

2245A

PORTABLE OSCILLOSCOPE OPERATORS

*Please Check for
CHANGE INFORMATION
at the Rear of This Manual*

First Printing JAN 1989
Revised JUN 1989

Tektronix[®]
COMMITTED TO EXCELLENCE

Copyright © 1987, 1889 Tektronix, Inc. All rights reserved. Contents of this publication may not be reproduced in any form without the written permission of Tektronix, Inc.

Products of Tektronix, Inc. and its subsidiaries are covered by U.S. and foreign patents and/or pending patents.

TEKTRONIX, TEK, SCOPE-MOBILE and  are registered trademarks of Tektronix, Inc.

Printed in U.S.A. Specification and price change privileges are reserved.

INSTRUMENT SERIAL NUMBERS

Each instrument has a serial number on a panel insert, tag, or stamped on the chassis. The first number or letter designates the country of manufacture. The last five digits of the serial number are assigned sequentially and are unique to each instrument. Those manufactured in the United States have six unique digits. The country of manufacture is identified as follows:

B000000	Tektronix, Inc., Beaverton, Oregon, U.S.A.
G100000	Tektronix Guernsey, Ltd., Channel Islands
E200000	Tektronix United Kingdom, Ltd., Marlow
J300000	Sony/Tektronix, Japan
H700000	Tektronix Holland, NV, Heerenveen, The Netherlands
HK00000	Tektronix, Inc. Hong Kong

Power Source

This product is intended to operate from a power source that does not apply more than 250 V rms between the supply conductors or between either supply conductor and ground. A protective ground connection, by way of the grounding conductor in the power cord, is essential for safe operation.

Grounding the Product

This product is grounded through the grounding conductor of the power cord. To avoid electrical shock, plug the power cord into a properly wired receptacle before making any connections to the product input or output terminals. A protective ground connection, by way of the grounding conductor in the power cord, is essential for safe operation.

Danger Arising From Loss of Ground

Upon loss of the protective-ground connection, all accessible conductive parts, including knobs and controls that may appear to be insulating, can render an electric shock.

Use the Proper Power Cord

Use only the power cord and connector specified for your product.

The power cord must be in good condition.

Read Section 1 for power-cord and connector information.

Use the Proper Fuse

To avoid fire hazard, use only a fuse of the correct type, voltage rating and current rating as specified on the back of your product and in Table 6-1.

Do Not Operate in an Explosive Atmosphere

To avoid explosion, do not operate this product in an explosive atmosphere.

Do Not Remove Covers or Panels

To avoid personal injury, do not remove the product covers or panels. Do not operate the product without the covers and panels properly installed.

SECTION 1

INTRODUCTION

PRODUCT OVERVIEW

Description

The 2245A is a 100 MHz, four-channel, dual-sweep, portable oscilloscope for general-purpose use (Figure 1-1). A microprocessor-based operating system controls most of the functions in the instrument, including a voltage and time cursor measurement system and a single-button automatic front-panel setup feature. A menu-driven service mode provides for configuring of single-sweep readout displays, internal calibration, and servicing diagnostics.

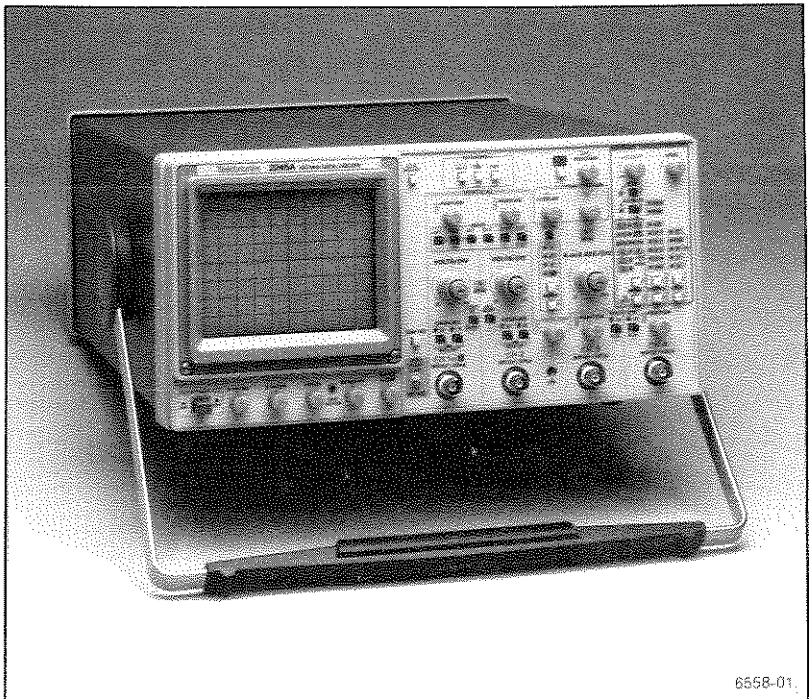

Figure 1-1. The 2245A Oscilloscope.

The vertical deflection system has four input channels. Two channels have 11 basic deflection factors from 2 mV to 5 V per division, and two channels have two basic deflection factors of 0.1 V and 0.5 V per division. Basic deflection factors can be extended with attenuator probes. VOLTS/DIV readouts are switched to display the correct vertical scale factors when properly coded probes are connected to the vertical input connectors.

The horizontal deflection system provides single, dual, or delayed sweeps from 0.5 s to 20 ns per division (delayed sweep, 5 ms to 20 ns per division). The trigger system provides stable triggering over the full bandwidth of the vertical deflection system.

Alphanumeric crt readouts of the vertical and horizontal scale factors are displayed at the bottom of the screen. On-screen vertical and horizontal cursors provide accurate voltage, time, and frequency measurements; measurement values are displayed at the top of the crt.

The measurement system provides direct readout of delta voltage, delta time, and frequency from positionable cursors. Delay-time and delta-delay measurements for time and frequency are available in ALT and B Horizontal Modes.

By pressing a single button (AUTO SETUP), the front-panel controls can be set up to produce a usable waveform display based on the voltage and time characteristics of the input signals.

Standard Accessories

The following items are standard accessories shipped with the 2245A instrument:

- 2 Probes, 10X, 1.5 meter, with accessories
- 1 Power cord
- 1 Power cord clamp
- 1 Operators manual
- 1 Reference guide
- 1 Crt filter, blue plastic (installed)
- 1 Fuse, 2A, 250 V, slow-blow
- 1 Accessory pouch, Ziploc

See Section 8 "Options and Accessories" for part numbers and further information about standard accessories and a list of the recommended optional accessories. For more information on accessories and ordering assistance, contact your Tektronix representative or local Tektronix Field Office.

PREPARATION FOR USE

Safety

Refer to the Operators Safety Summary at the front of this manual for power source, grounding, and other safety information about the use of the instrument. Before connecting the 2245A to a power source, read this section and the Safety Summary.

Line Fuse



This instrument can be damaged if the wrong line fuse is installed.

Verify the proper value of the power-input fuse with the following procedure.

1. Press in the fuse-holder cap and release it with a slight counter-clockwise rotation.
2. Pull the cap (with the attached fuse inside) out of the fuse holder.
3. Verify proper fuse value.
4. Install the proper fuse and reinstall the fuse-holder cap.





Line Voltage and Power Cord

The 2245A operates on line voltages from 90 to 250 V with line frequencies ranging from 48 to 440 Hz. No line voltage selecting is necessary. Instruments are shipped with the power cord that was requested on the order. The power cord must match the power-source outlet; if it does not, contact your Tektronix representative or local Tektronix Field Office. See Figure 1-2 for optional power cords available.

The detachable three-wire power cord has a three-contact plug for connection to the power source and the protective ground. The power cord is held to the rear panel by a clamp. The protective ground contact on the plug connects (through the power cord protective-ground conductor) to the accessible metal parts of the instrument.

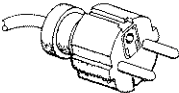
WARNING

For electrical-shock protection, insert this plug into a power-source outlet that has a properly grounded protective-ground contact.

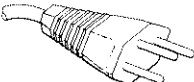
Plug Configuration	Usage	Line Voltage	Reference Standards	Option Number
	North American 120V/ 15A	120V	ANSI C73.11 NEMA 5-15-P IEC 83	Standard
	Universal Euro 240V/ 10-16A	240V	CEE (7),II,IV,VII IEC 83	A1
	UK 240V/ 13A	240V	BS 1363 IEC 83	A2
	Australian 240V/ 10A	240V	AS C112	A3
	North American 240V/ 15A	240V	ANSI C73.20 NEMA 6-15-P IEC 83	A4
	Switzerland 220V/ 6A	220V	SEV	A5
Abbreviations: ANSI — American National Standards Institute AS — Standards Association of Australia BS — British Standards Institution CEE — International Commission on Rules for the Approval of Electrical Equipment IEC — International Electrotechnical Commission NEMA — National Electrical Manufacturer's Association SEV — Schweizerischer Elektrotechnischer Verein				

(2931-21)6558-02

Figure 1-2. Optional power cords.

Instrument Cooling

To prevent instrument damage from overheated components, make sure the internal airflow is not blocked. Before turning on the power, check that the ventilation holes on the bottom and side of the cabinet are not covered.

Start-Up

At power on, the instrument does a self-diagnostic check. If the instrument does not turn on and operate normally, turn power off then on again. If the instrument still does not turn on properly, refer the instrument to a qualified service person. TRIGGER MODE LEDs may be flashing to indicate the circuit location of a start-up error; you should report this information to the service person.

When the instrument is turned on, a self-cal routine may run to set the voltage- and timing-measurement constants. The power-on self cal runs only if the stored constants have been lost, possibly due to a dead memory back-up battery. The following warning message will be displayed for 5 seconds: "WARNING PROBABLE BATTERY FAILURE TURN OFF AND ON TO VERIFY". If the message reappears after having turned the power off and on, have the battery checked and/or replaced by a qualified service person. The instrument can still be used for accurate measurements by running the SELF CAL MEASUREMENTS routine from the SERVICE MENU after the instrument has warmed up for at least 20 minutes.

To run the SELF CAL MEASUREMENTS routine, press the left and right VERTICAL MODE buttons (CH 1 and CHOP/ALT). Press the ADD button (down-arrow) to underline SELF CAL MEASUREMENTS. Press the CH 2 button (RUN) to start the routine, then CH 4 (QUIT) or CLEAR MEAS'MT button to return to the normal oscilloscope mode.

Repackaging for Shipment

Save the original shipping carton and packing material in case it is ever necessary to reship the instrument by a commercial transport carrier. If the original materials are unfit or not available, then repackage the instrument using the following procedure.

1. Use a corrugated cardboard shipping carton with a test strength of at least 275 pounds and an inside dimension at least six inches greater than the instrument dimensions.
2. If instrument is being shipped to a Tektronix Service Center, enclose the following information: owner's address, name and phone number of a contact person, type and serial number of the instrument, reason for returning, and a complete description of the service required.
3. Completely wrap the instrument with polyethylene sheeting or equivalent to protect the outside finish and keep harmful substances out of the instrument.
4. Cushion instrument on all sides with three inches of padding material or urethane foam, tightly packed between the carton and the instrument.
5. Seal the shipping carton with an industrial stapler or strapping tape.
6. Mark the address of the Tektronix Service Center and your own return address on the shipping carton.

SECTION 2

**CONTROLS,
CONNECTORS,
AND INDICATORS**

Crt, Power, and Display

Refer to Figure 2-1 for location of items 1 through 9.

- 1 **POWER Switch**—Turns on or off instrument power. Press for ON or OFF.

At least one VERTICAL MODE button will light when the power is turned on. The front-panel setup existing when the power is turned off will return when the power is turned on again.

- 2 **A INTEN Control**—Adjusts the brightness of the A trace.
- 3 **B INTEN Control**—Adjusts the brightness of the B Delayed sweep trace and the intensified zone on the A trace.
- 4 **FOCUS Control**—Adjusts the focus of the crt displays (traces, readout, and cursors).
- 5 **TRACE ROTATION Control**—Aligns the crt trace with the horizontal graticule lines. This is a screwdriver adjustment.
- 6 **READOUT Control**—Adjusts the brightness of the crt readout display (includes all alphanumeric and cursors).
- 7 **SCALE ILLUM Control**—Adjusts the illumination level of the graticule.

NOTE

Life of the graticule illumination lamps can be increased by setting the SCALE ILLUM control for the minimum intensity needed for viewing, and turning off scale illumination when not needed.

- 8 **BEAM FIND Button**—Locates off-screen and overscanned displays when the button is held in. Limits the vertical and horizontal deflection within the display area and unblanks the crt.

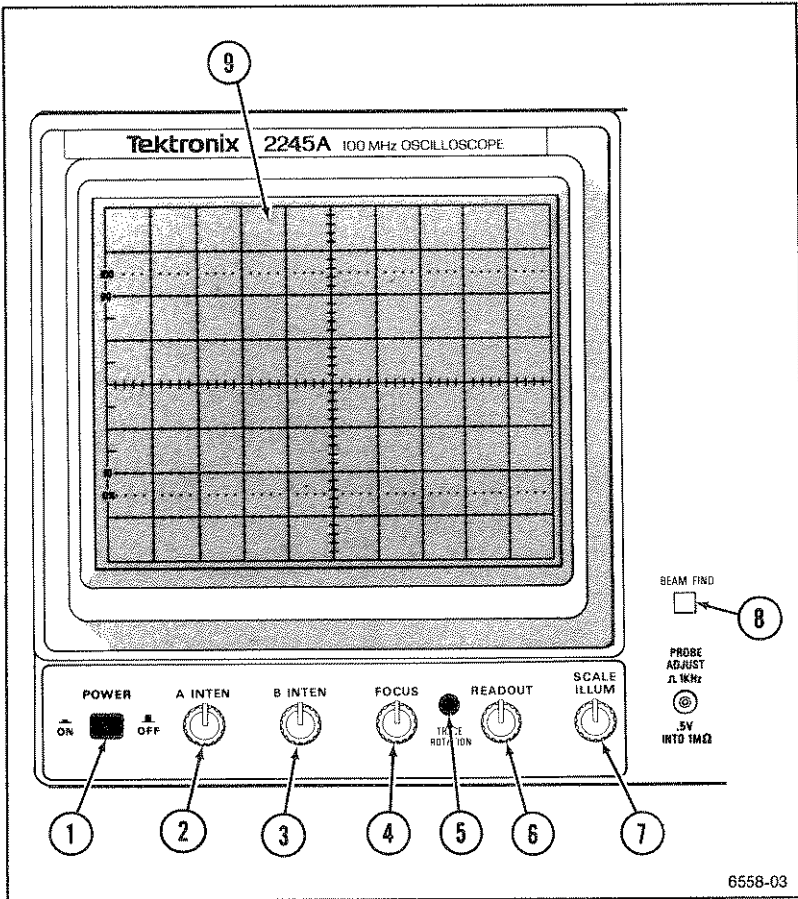

Figure 2-1. Crt, power and display controls.

- 9 CRT—Displays waveforms and readouts in an 80 mm vertical by 100 mm horizontal graticule area.

Internal graticule lines provide parallax-free viewing of trace and graticule lines. 0%, 10%, 90% and 100% points marked at the left edge of the graticule aid in making rise- and fall-time measurements.

Vertical

Refer to Figure 2-2 for location of items 10 through 17.

- ⑩ **CH 1 and CH 2 POSITION Controls**—Adjust vertical position of the Channel 1 and Channel 2 waveform displays.
- ⑪ **MODE Buttons**—Select the vertical channels for display (CH 1, ADD channels 1 and 2, CH 2, CH 3, and CH 4). The CHOP/ALT MODE button selects method for switching input channels on the display (chopped or alternating).

Except for CHOP/ALT modes, pressing an unlit mode button turns on the mode, and pressing a lit button turns off the mode. CHOP is selected when the CHOP/ALT button is lit; ALT is selected when the button is not lit.

CH 1, CH 2, CH 3, and CH 4—Select vertical channels for display. At least one of the channels or ADD is always on and cannot be turned off until another channel is turned on.

CHOP/ALT—In the CHOP mode the display chops between selected input channels at a rate of about 625 kHz. In the ALT mode, the selected channels are displayed in sequence (alternating at the end of each sweep).

ADD—Displays the algebraic sum of the Channel 1 and Channel 2 input signals. The ADD display is in addition to any other selected channel displays. In the ADD mode, a plus sign (+) is displayed between the Channel 1 and Channel 2 VOLTS/DIV readouts.

NOTE

In ADD mode when AUTO LEVEL TRIGGER MODE or CHOP VERTICAL MODE is selected, the algebraic sum of Channel 1 and Channel 2 display provides the internal signal source for the trigger system when the trigger source is VERT.

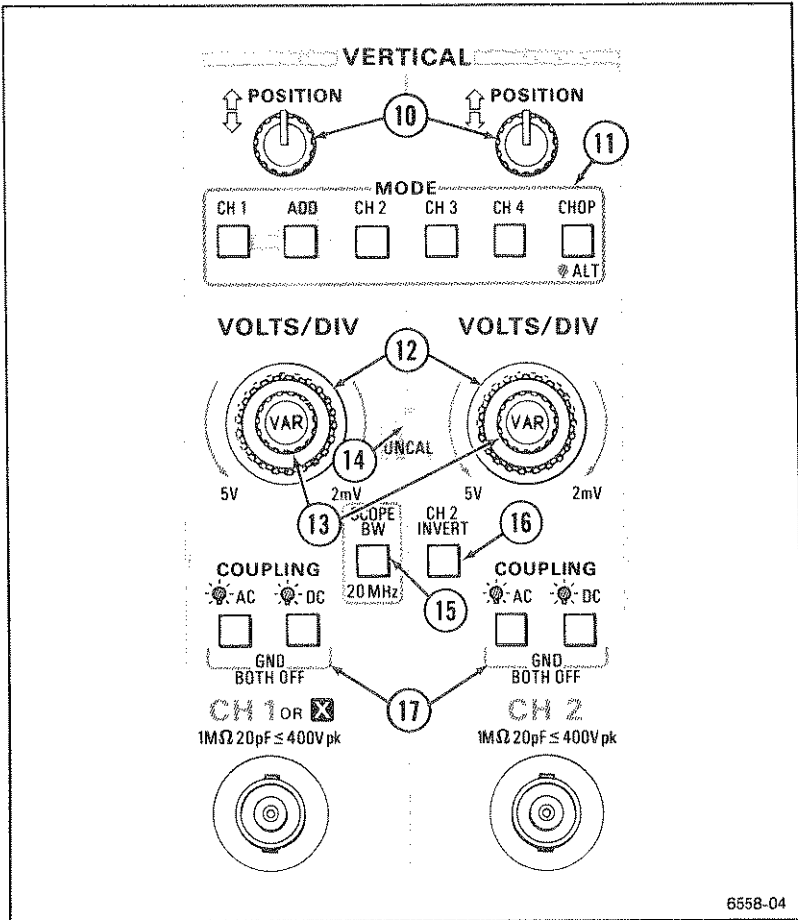

Figure 2-2. CH 1 and CH 2 vertical controls and indicators.

- ⑫ Channel 1 and Channel 2 VOLTS/DIV Switches—Select calibrated deflection factors for Channel 1 and Channel 2 from 2 mV per division to 5 V per division in a 1-2-5 sequence of 11 steps.

The switches are detented, continuous-rotation controls with no end stops. The VOLTS/DIV readouts reflect attenuation factors of coded attenuator probes connected to the vertical inputs.

CH 1 AND CH 2 VOLTS/DIV VAR Controls—Allow the CH 1 and CH 2 vertical deflection factors to be increased up to at least 2.5 times.

Vertical deflection factors are greater than the VOLTS/DIV switch setting when the UNCAL indicator is lit and a greater-than symbol (>) is displayed to the left of the associated VOLTS/DIV readout. The VOLTS/DIV settings are calibrated when the VAR control is in the fully clockwise (detent) position.

UNCAL Indicator—Lights when either CH 1 or CH 2 VOLTS/DIV setting is uncalibrated (variable function in effect).

SCOPE BW Button—Reduces the bandwidth of the vertical deflection system and trigger system to 20 MHz when the button is lit. The full vertical deflection bandwidth is available when the SCOPE BW button is not lit.

CH 2 INVERT Button—Inverts the Channel 2 input signal when the INVERT button is lit.

The Channel 2 input signal in ADD mode and the Channel 2 trigger signal pickoff are also inverted. A down-arrow symbol is displayed between the Channel 1 and Channel 2 VOLTS/DIV readout when the INVERT mode is on.

COUPLING Buttons—Select the method of coupling input signals to the Channel 1 and Channel 2 attenuators.

GND—Disconnects the input signal and grounds the input of the associated vertical attenuator to provide a zero (ground) reference voltage display.

The COUPLING switch is in the ground position when the AC and the DC buttons are not lit. A ground symbol (\perp) is displayed to the right of the associated VOLTS/DIV readout.

AC—Capacitively couples the input signal to the vertical attenuator when the AC button is lit.

Turning on AC Coupling turns off DC Coupling. AC Coupling blocks the dc component of the input signal. The lower -3 dB frequency limit is 10 Hz or less when using either a 1X probe or properly terminated coaxial cable; it is 1 Hz or less using a compensated 10X probe. With AC Coupling selected, an AC symbol (\sim) is displayed to the right of the associated VOLTS/DIV readout. An ac symbol is also displayed after the value readout of a CURSOR VOLTS measurement.

DC—Couples dc and all frequency components of the input signal to the vertical attenuator when the DC button is lit.

Turning on DC coupling turns off AC coupling. With DC Coupling selected, a DC symbol ($\overline{\text{---}}$) is displayed to the right of the associated VOLTS/DIV readout. Input resistance is 1 M Ω to ground.

Refer to Figure 2-3 for location of items 18 through 23.

- 18** CH 1 OR X and CH 2 Input Connectors—Connect signals to the inputs of Channel 1 and Channel 2 vertical attenuators.

Input connectors are BNC type with an outer contact ring for recognizing attenuation factors of coded attenuator probes. A signal connected to the CH 1 OR X input connector produces the horizontal deflection (X-Axis) in the X-Y horizontal mode. Any of the vertical signal channels or ADD can provide vertical deflection (Y-Axis) for an X-Y display.

- 19** PROBE ADJUST Connector—Outputs a 0.5 V square-wave signal (at about 1 kHz into a 1 M Ω load) for compensating voltage probes and checking the vertical deflection accuracy.

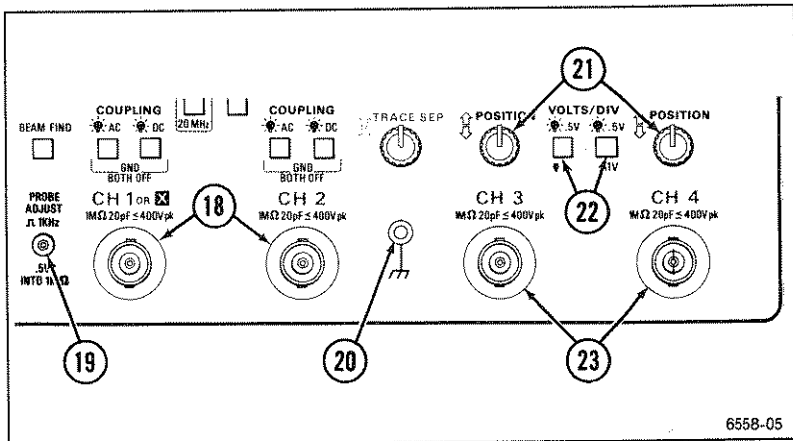

Figure 2-3. Vertical connectors and CH 3 and CH 4 controls and indicators.

- 20 **Auxiliary Ground Jack**—Provides an auxiliary chassis ground connection (banana jack) between the equipment under test and the 2245A.
- 21 **Channel 3 and Channel 4 POSITION Controls**—Adjust vertical position of Channel 3 and Channel 4 signal displays.
- 22 **Channel 3 and Channel 4 VOLTS/DIV Switches**—Select two basic deflection factors for Channel 3 and Channel 4, 0.5 volt/division (button lit) or 0.1 volt/division (button not lit).

The VOLTS/DIV switch setting displayed in the crt readout reflects the attenuation factor of coded attenuator probes that are connected to the vertical inputs.

- 23 **CH 3 and CH 4 Input Connectors**—Connect signals to the inputs of the Channel 3 and Channel 4 vertical attenuators. Input coupling is dc only.

The input connectors are BNC with probe-coding ring contacts (the same as Channel 1 and Channel 2). The limited choice of deflection factors for the Channel 3 and Channel 4 inputs makes them useful for digital and trigger signals.

Horizontal

Refer to Figure 2-4 for location of items 24 through 31.

- 24 **POSITION Control**—Adjusts the horizontal position of the waveform displays on the crt.
- 25 **X10 MAG Switch**—Magnifies the A and B sweeps by a factor of 10 and extends the fastest sweep speed to 2 ns per division. The center portion of an unmagnified sweep display will be within 0.5 division of the center of a magnified sweep display. No action occurs in X-Y mode.

When X10 MAG is on, a X10 symbol is displayed next to the SEC/DIV readouts. The readouts reflect correct display sweep speeds for the X10 MAG displays and the unmagnified displays.

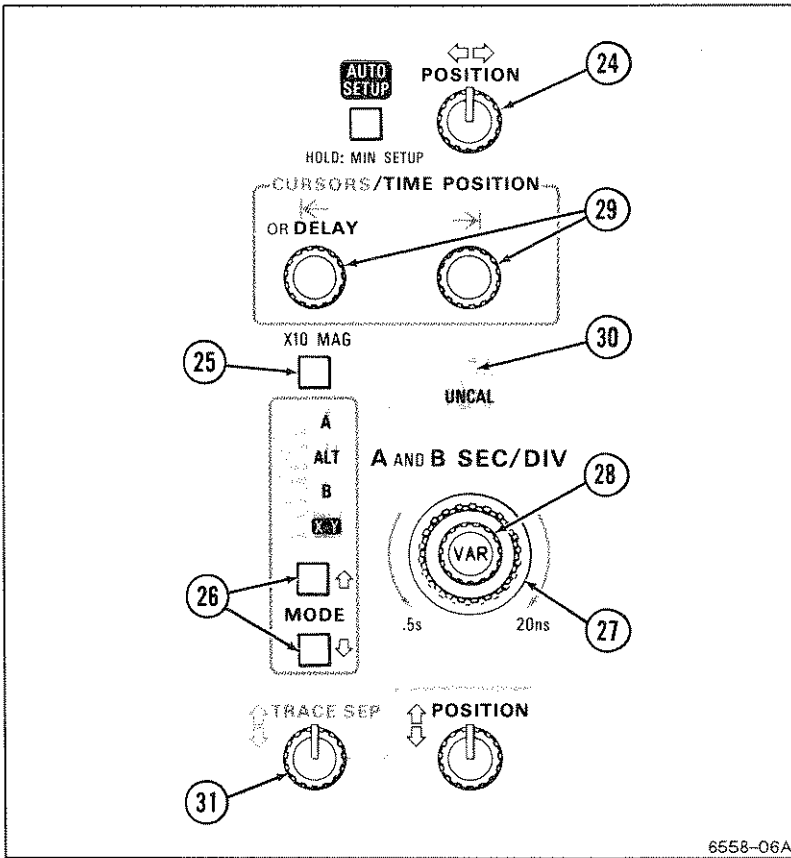

Figure 2-4. Horizontal controls and indicators.

- 26 MODE Buttons (Up-Arrow and Down-Arrow) and Indicators—Select the operating mode of the horizontal deflection system. Pressing the Up-/Down-Arrow buttons selects the horizontal deflection mode as shown by the MODE lights. Not all Measurement modes are compatible with all horizontal deflection modes. See Table 3-1, Behavior for Horizontal MODE Changes, in Section 3.

A—Selects A sweep horizontal deflection. The A sweep speed is determined by the A SEC/DIV switch setting as displayed in the crt

readout. Whenever A MODE is selected, the A/B SELECT switch is set to A Trigger.

ALT—Alternates between A sweep (with an intensified zone representing B sweep) and B delayed sweep. Both A and B SEC/DIV switch settings are displayed in the crt readout, but only the B can be adjusted. Whenever ALT MODE is selected, the A/B SELECT switch is set to B Trigger.

The B sweep speed cannot be set slower than the A sweep speed; attempting to do so forces the A sweep speed to follow the B sweep speed. To increase the A sweep speed in the ALT MODE, set the Horizontal MODE to A, adjust the SEC/DIV switch to a faster A sweep setting, and reset the Horizontal MODE switch to ALT. The B sweep speed and the length of the intensified zone are determined by the B SEC/DIV switch setting.

B—Selects B sweep horizontal deflection. The B sweep speed is determined by the B SEC/DIV switch setting as displayed in the crt readout. Whenever B MODE is selected, the A/B SELECT switch is set to B Trigger.

The start of the B sweep in RUNS AFTER mode (or the arming of the B Trigger in any triggered mode) is delayed from the start of the A sweep by a time determined by the setting of the ← OR DELAY control. The B SEC/DIV switch setting and the Delay Time Position setting are displayed in the crt readout. A greater-than sign (>) is displayed in front of the Delay Time readout if the B Trigger MODE is not RUNS AFTER.

X-Y—The signal applied to CH 1 OR X input connector produces the horizontal (X-Axis) deflection. Signals applied to any vertical input connector or ADD may be selected to provide the vertical deflection (Y-Axis).

The X-Y displays are horizontally positioned by the Horizontal POSITION control and vertically positioned by the associated vertical channel POSITION control.

- (27) **A AND B SEC/DIV Switch**—Selects the horizontal deflection rate (sweep speed) for both the A sweep and the B sweep in a 1-2-5 sequence. Calibrated sweep speeds are obtained with the A and B SEC/DIV VAR control in the detent (fully clockwise) position. The A SEC/DIV switch setting is set only from the A Horizontal MODE and the B SEC/DIV switch is set only from the ALT or B Horizontal MODE.

NOTE

The B sweep speed can never be slower than the A sweep speed. When the two sweep speeds are the same, they are "locked." At this point A will follow B to slower SEC/DIV settings (in ALT or B) and B will follow A to faster settings (in A).

A SEC/DIV—The calibrated A sweep speed is selected only in A Horizontal MODE from 0.5 s per division to 20 ns per division (X10 MAG off).

B SEC/DIV—The calibrated B sweep speed is selected either in ALT or B Horizontal MODE from 5 ms per division to 20 ns per division (X10 MAG off).

- 28 **A and B SEC/DIV VAR Control**—Provides continuously variable, uncalibrated A and B sweep speeds to at least 2.5 times slower than the calibrated SEC/DIV setting.

The VAR control extends the slowest A sweep speed to at least 1.25 sec per division. The UNCAL indicator is lit and a greater-than sign (>) is displayed before each SEC/DIV readout value when the sweep speeds are greater than the SEC/DIV settings. The SEC/DIV settings are calibrated when the VAR control is in the fully clockwise (detent) position.

- 29 **CURSORS/TIME POSITION Controls**—Set the reference and delta cursors on the display.

NOTE

The reference and delta cursors will only track together as long as the reference delay plus the delta delay is less than 10 times the A SEC/DIV setting (10 horizontal graticule divisions). The cursors cannot be positioned left of the 1st or right of the 11th vertical graticule lines.

← OR DELAY—This control has the following functions:

1. Positions the reference and delta cursors together in the CURSOR VOLTS, 1/TIME, or TIME measurement mode when the Horizontal MODE is A (also X-Y for CURSOR VOLTS).

2. Positions the reference and delta delays together in the 1/TIME or TIME measurement mode when the Horizontal MODE is ALT or A.
3. Sets the B sweep delay time in the DELAY measurement mode when the Horizontal MODE is ALT or B.

→ —This control has the following functions:

1. Positions the delta cursor in the CURSOR VOLTS, 1/TIME, or TIME measurement mode when the Horizontal MODE is A (also X-Y for CURSOR VOLTS).
2. Sets the B sweep delta delay in the 1/TIME or TIME measurement mode when the Horizontal MODE is ALT or B.

- ③0 **UNCAL Indicator**—Lights when the A AND B SEC/DIV settings are uncalibrated (variable function in effect).
- ③1 **TRACE SEP Control**—Positions the B sweep trace vertically with respect to the A sweep trace when ALT Horizontal MODE is selected.

Trigger

Refer to Figure 2-5 for location of items 32 through 38.

- ③2 **A/B SELECT Button**—Directs the MODE, SOURCE, CPLG, SLOPE, and LEVEL controls and Trigger lights (TRIG'D and READY) to either the A or B Trigger system (A, when lit; B, when not lit).

Either A or B trigger can be selected for any Horizontal MODE; however, A/B SELECT is preset to A when A Horizontal MODE is selected, and B when ALT or B Horizontal MODE is selected. No change occurs when switching from B to X-Y Horizontal MODE.

- ③3 **SLOPE Button**—Selects the slope (positive- or negative-going) of the trigger source signal that triggers either the A sweep or the B sweep. (Button lit = positive-going; button not lit = negative-going.)

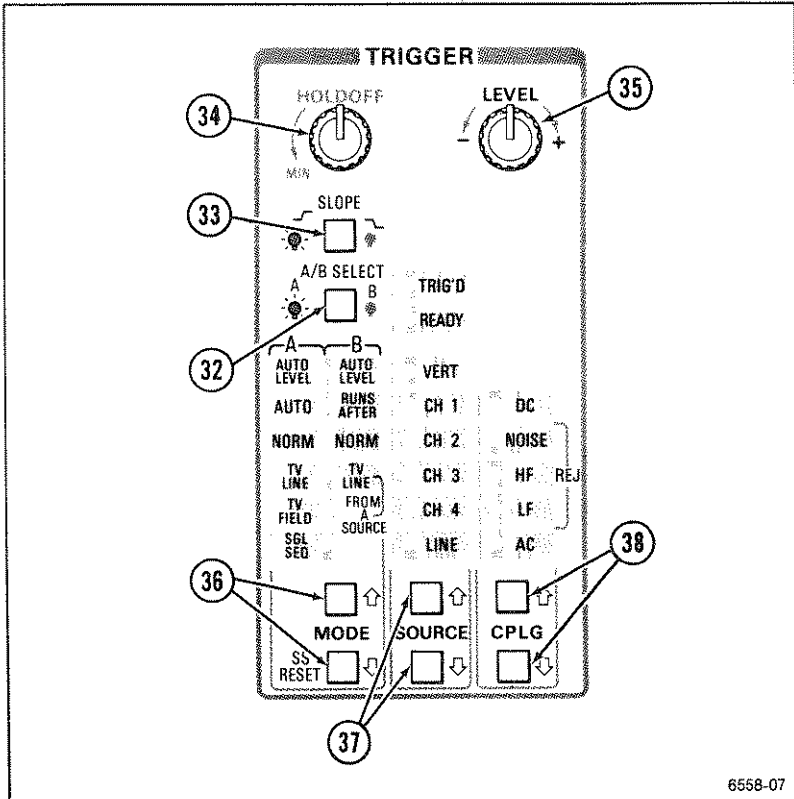

6558-07

Figure 2-5. Trigger controls and indicators.

- 34 **HOLDOFF Control**—Varies holdoff time between the end of one A sweep and the start of the next A sweep.

The HOLDOFF control can increase the minimum holdoff time by at least 10 times. Adjusting this control can improve triggering stability of aperiodic signals (i.e., complex digital waveforms).

- 35 **LEVEL Control**—Sets the amplitude level on the trigger signal at which either the A or B sweep is triggered.

Adjusting the LEVEL control to either end of its range, in the AUTO LEVEL trigger mode, resets the limits of the Trigger LEVEL control range to the peak-to-peak amplitude of the trigger source signal.

- 36 **MODE Buttons (Up- and Down-Arrows) and Indicators**—Select the operating modes of the A and B trigger systems. Pressing the Up-/Down-Arrow buttons selects the operating modes as shown by the TRIGGER MODE lights.

Selections available for the A Trigger (A/B SELECT button lit) are: AUTO LEVEL, AUTO, NORM, TV LINE, TV FIELD, and SGL SEQ. Selections for the B Trigger (A/B SELECT button not lit) are: AUTO LEVEL, RUNS AFTER, NORM, TV LINE FROM A SOURCE.

A Trigger Modes

AUTO LEVEL—Automatically sets the range of the Trigger LEVEL control to the peak-to-peak limits of an adequate A Trigger source signal and triggers the sweep.

Autoleveling is repeated if triggering is lost, if the TRIGGER LEVEL control is rotated to either end stop, or if AUTO LEVEL TRIGGER MODE is selected again. AUTO LEVEL mode is useful for quickly locating and maintaining an appropriate triggering level.

NOTE

When in AUTO LEVEL or AUTO triggering, the A sweep free-runs to produce a baseline trace when the A trigger source signal amplitude is too low or the frequency is below 10 Hz. Switch to NORM triggering if the repetition rate is too slow for autoleveling.

AUTO—Triggers the same as the NORM Trigger MODE when an adequate trigger signal is applied. However, the A sweep free-runs to display a baseline trace when there is no trigger signal or the frequency is below 10 Hz. The set triggering level changes only when the TRIGGER LEVEL control is adjusted to a new level setting.

NORM—Triggers the A sweep when the A Trigger LEVEL control is set within the peak-to-peak limits of an adequate trigger signal. When the A sweep is not triggered, no baseline trace is displayed.

TV LINE—Starts the A sweep at the beginning of a video signal line. SLOPE polarity must match the composite sync polarity (i.e.,  SLOPE for negative sync) to obtain TV LINE triggering on the horizontal sync pulse. Instruments Serial Numbered B020100 or above can have the TV SLOPE polarity preset by changing the instrument configuration from the CONFIGURE menu (see "Service Menu Features" in Section 3).

TV FIELD—Starts the A sweep at the beginning of a video signal field. SLOPE polarity must match the composite sync polarity to obtain TV FIELD triggering.

SGL SEQ (Single Sequence)—Sets up the A sweep for single-sequence operation. Each additional press of the down-arrow MODE button, when in single-sequence mode, resets the sweep and makes it ready to accept a trigger. As in NORM trigger MODE, the set triggering level changes only when the TRIGGER LEVEL control is adjusted to a new level setting.

When triggered, the sweep runs to produce a single sweep of each trace as required by the setting of the VERTICAL MODE and HORIZONTAL MODE switches. Each displayed sweep in the sequence requires a distinct A sweep triggering event. The READY light remains on until the final trace in the sequence is completed. The readout and cursors can be set to turn on briefly at the end of the sequence when using a camera (factory setting default mode), or they can be set to remain on by changing the instrument configuration from the CONFIGURE menu (see "Service Menu Features" in Section 3).

B Trigger Modes

AUTO LEVEL—Sets the range of the Trigger Level control to the peak-to-peak limits of an adequate B Trigger-source signal and triggers the B sweep.

The auto-level range is reset when triggering is lost, TRIGGER LEVEL control is rotated to either end stop, or AUTO LEVEL Trigger MODE is reselected. AUTO LEVEL mode is useful for quickly locating an appropriate triggering level.

The B sweep operates in RUNS AFTER mode when the trigger-source signal amplitude is too low or the frequency is below 10 Hz. Switch to NORM triggering if the repetition rate is too slow for auto leveling. The A Sweep must be running (free-running or triggered) for B Sweep to trigger.

RUNS AFTER—Starts the B sweep immediately after the delay time selected by the \leftarrow OR DELAY control.

The Trigger MODE must be in RUNS AFTER before time measurements can be selected when the Horizontal MODE is ALT or B. A time measurement will be canceled if the Trigger MODE is changed from RUNS AFTER while in the ALT or B Horizontal MODE.

NORM—The B sweep is triggered when an adequate trigger signal is received after the delay time condition has been met. When there is no trigger signal, there is no B sweep trace.

TV LINE FROM A SOURCE—Starts the B sweep at the beginning of the video signal line received after the delay time has been met.

SLOPE polarity defaults to the A Trigger SLOPE. This must match the composite sync polarity to obtain correct triggering on the horizontal sync pulse.

37 **SOURCE** (Up-Arrow and Down-Arrow) Buttons and Indicators—Select the trigger source for either the A or the B Trigger system as directed by the A/B SELECT button. Pressing the Up-/Down-Arrow SOURCE buttons selects the trigger source (for A or B trigger system) as shown by SOURCE lights.

VERT—Selects the trigger signal from the displayed waveforms.

The TRIGGER MODE and VERTICAL MODE switch settings determine the trigger signal source selection. When VERT is selected, one or more of the SOURCE lights will be on to indicate the trigger signal source. See Table 2-1 for VERT Trigger SOURCE selections.

CH 1—The signal applied to the CH 1 OR X input connector is the source of the trigger signal.

CH 2—The signal applied to the CH 2 input connector is the source of the trigger signal.

CH 3—The signal applied to the CH 3 input connector is the source of the trigger signal.

Table 2-1
VERT Trigger SOURCE

Trigger and Vertical Modes	ADD Mode	Trigger Source Selected
AUTO LEVEL or CHOP	On	Algebraic sum of CH 1 and CH 2 input signals.
	Off	Lowest numbered vertical channel displayed.
NON-AUTO LEVEL and ALT	On or Off	Alternates between displayed vertical channels in the following order: Ch 1, Ch 2, Ch 3, CH 4, and ADD.

CH 4—The signal applied to the CH 4 input connector is the source of the trigger signal.

LINE—The triggering signal is obtained from a sample of the ac power-source waveform. This trigger source is useful when the displayed waveform frequency is time related to the ac power-source frequency.

38 CPLG (Up-Arrow and Down-Arrow) Buttons and Indicators—Select the method of coupling the input trigger signal to the A or B trigger system as directed by the A/B SELECT button. Pressing the Up-/Down-Arrow buttons selects the trigger coupling as shown by the CPLG lights.

DC—Couples dc and all frequency components of a triggering signal to the trigger circuitry.

DC coupling is useful for most signals, but it is especially useful for providing a stable display of low-frequency or low-repetition-rate signals.

NOISE REJ (Noise Reject)—Couples all frequency components of the input signal to the trigger circuitry but increases the peak-to-peak signal amplitude required to produce a trigger event.

NOISE REJ coupling is useful for improving stability when the trigger signal is accompanied by low-level noise.

HF REJ (High Frequency Reject)—Attenuates high-frequency triggering signal components above 50 kHz.

HF REJ coupling is useful for providing a stable display of low-frequency components of complex waveforms and eliminates high-frequency interference from the trigger signal.

LF REJ (Low Frequency Reject)—Attenuates low-frequency triggering signal components below 100 kHz and blocks the dc component of the trigger signal.

LF REJ coupling is useful for producing stable triggering on the high-frequency components of complex waveforms and rejecting low-frequency interference or power supply hum from the trigger signal.

AC—Attenuates trigger signal frequency components below 50 Hz and blocks the dc component of the signal.

AC coupling is useful for triggering on ac waveforms that have a large dc offset.

Rear Panel

Refer to Figure 2-6 for location of items 39 through 41.

- 39** **EXT Z-AXIS INPUT Connector**—Connects external signals to the Z-Axis amplifier for intensity modulating the crt display.

Signals applied to the EXT Z-AXIS INPUT do not affect display waveshape. Signals with fast rise times and fall times provide the most abrupt intensity change. The active region threshold level is 1.8 V. Z-Axis voltage above the threshold voltage decreases the intensity, and 3.8 V or more produces noticeable modulation. The Z-Axis signals must be time-related to the displayed signal to obtain a fixed intensity-modulated crt display.

- 40** **Fuse Holder**—Contains the primary power fuse.

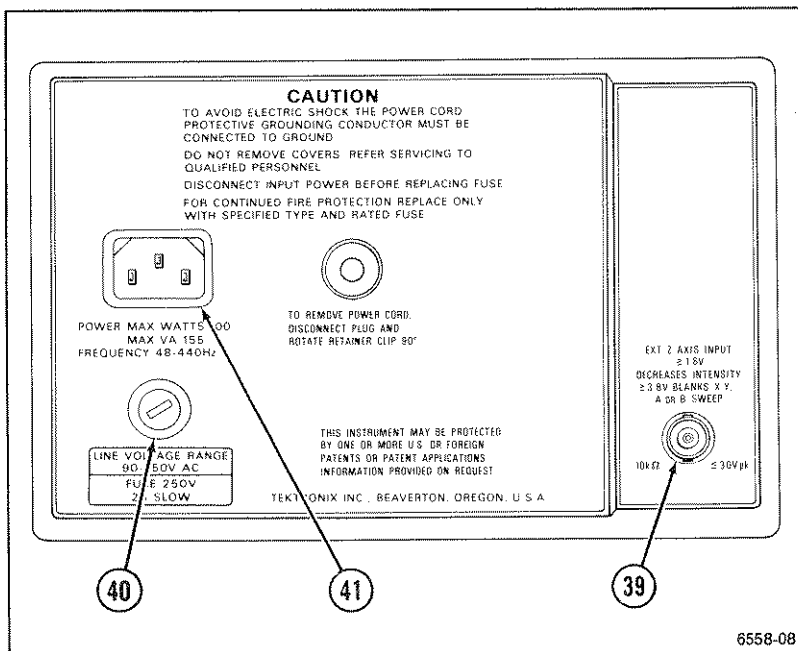

Figure 2-6. Rear panel connectors and fuse.

- 41 Power Cord Receptacle—Connects the ac power source to the instrument power supply.

The power cord protective-ground connection is connected to the exposed metal parts of the instrument. The power cord must be connected to a properly grounded source for electrical-shock protection.

Measurements and Auto Setup Controls

Refer to Figure 2-7 for location of items 42 through 46.

- 42 CLEAR MEAS'MT—Clears displayed service menus and cursor measurements functions.

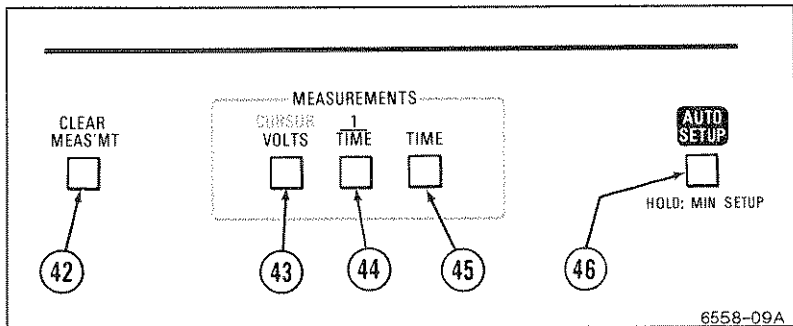

Figure 2-7. Measurement controls.

- 43 **CURSOR VOLTS**—Turns on the cursor volts measurement mode and displays two positionable horizontal cursors. One cursor is automatically positioned at the upper peak of the displayed waveform and the other at the lower peak. The voltage difference between the upper and lower cursors is displayed in the top line of the crt graticule. Cursors can be repositioned as desired using the \rightarrow control to move the upper cursor and the \leftarrow OR DELAY control to move both cursors together.

The measurement channel for the cursor volts measurement mode is set to Channel 1 or Channel 2 when either is displayed alone. If both CH 1 and CH 2 are selected, the measurement channel is set to Channel 1 unless Channel 2 had been selected first.

- 44 **1/TIME**—Turns on the 1/TIME (frequency) measurement mode and displays two positionable vertical cursors in A MODE. ALT and B MODE displays have two B sweeps, and in ALT MODE the A sweep has two intensified zones. The 1/TIME difference between the left and right cursors or edges of the B sweep is displayed in Hertz in the top line of the crt graticule. The displayed value accurately represents the frequency of a repetitive input signal when the cursors or edges of the B display are positioned so that they span one complete period of the waveform.
- 45 **TIME**—Turns on the delta-time measurement mode and displays two positionable vertical cursors in A MODE. ALT and B MODE displays have two B sweeps, and in ALT MODE the A sweep has two intensi-

fied zones. the delta-time difference between the left and right cursors or edges of the B display is displayed in seconds in the top line of the crt graticule.

NOTE

Measurement channels for time measurements modes in ALT or B Horizontal mode are set to the lowest number displayed channel for the delay time and the next lowest number displayed channel for the delta-delay time, if more than one channel is displayed. Both are set to the same channel when only one is displayed. ADD is considered the highest numbered channel.

- 46 **AUTO SETUP Button**—Automatically sets up the front-panel controls to produce a usable crt display of the input signals. Setups are based on the characteristics of the applied signals. The voltage and frequency characteristics of the input signal must be within the limits of the 2245A specifications. Auto-setup action for each front-panel control is shown in Appendix A.

NOTE

MIN SETUP as described below is only available on instruments Serial Numbered B020100 or above.

MIN SETUP—Pushing and holding the Auto-Setup button until instrument operation returns enters the MIN SETUP function. This sets up the front-panel controls as the Auto-Setup does but leaves many of the controls unchanged from what the user has previously set. MIN SETUP setup action for each front-panel control is shown in Appendix A.

SECTION 3

**OPERATORS
FAMILIARIZATION**

BASIC OPERATION

This subsection contains the basic operating information and techniques that should be considered before attempting any measurements. For location and function of instrument controls, connectors, and indicators see "CONTROLS, CONNECTORS, AND INDICATORS" Section 2 of this manual.

Readout Display

The crt readout display indicates how the instrument controls are set up. No physical markings are on the rotating switches to indicate the control setting. A key to the location and type of readout information displayed is illustrated in Figure 3-1.

Graticule

The graticule is internally marked on the crt face to provide parallax-free viewing and enable accurate measurements (see Figure 3-2). The graticule is marked with eight vertical and ten horizontal major divisions. Major divisions are further divided into five sub-divisions of 0.2 division each, marked along the center vertical and horizontal graticule lines. Percentage marks for rise-time and fall-time measurements are marked on the left side of the graticule. Vertical deflection factors and horizontal timing are calibrated to the graticule so that accurate measurements can be made directly from the crt.

The waveform displays are calibrated to the crt graticule markings for making quick and very accurate measurements of waveform parameters. Voltage measurements are done by counting the vertical graticule divisions and partial divisions occupied by the portion of the display being measured and then multiplying by the VOLTS/DIV setting. Time measurements using the graticule markings are done in a similar manner. Count the number of horizontal graticule divisions and partial divisions occupied by the portion of the waveform being measured and multiply by the SEC/DIV setting.

To improve the accuracy of the estimate, position the display to take advantage of the 0.2 division minor graticule markings on the center graticule lines. Also position one of the measurement points of the waveform as precisely as possible on one of the major graticule marks to be used as a measurement reference point.

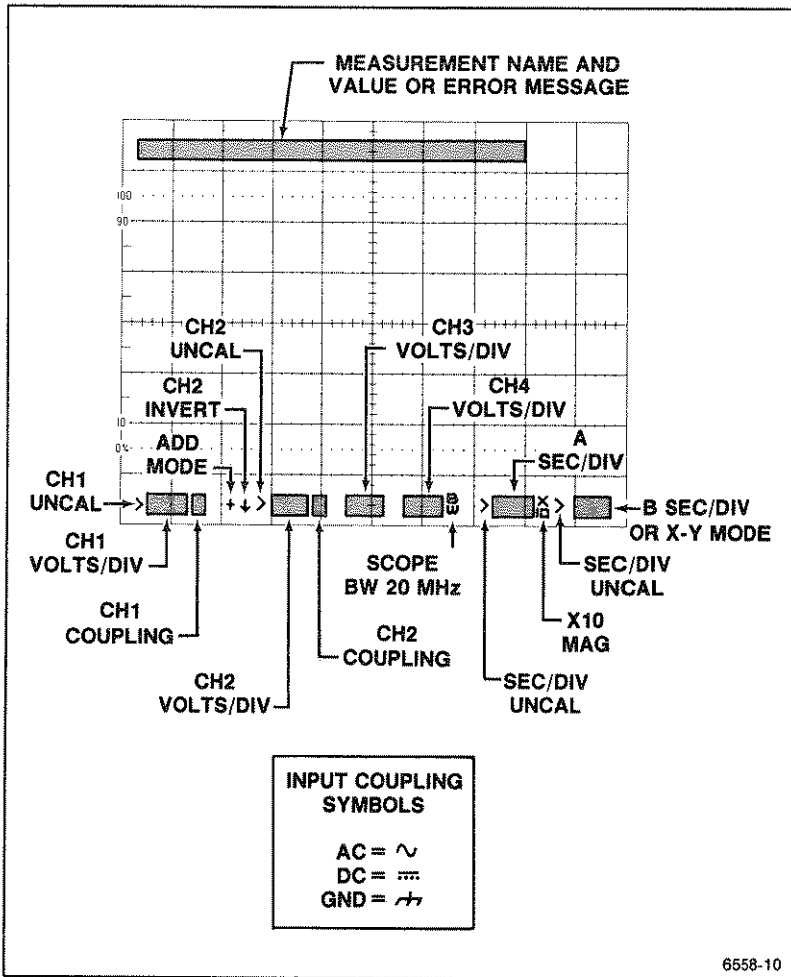

Figure 3-1. Readout display locations.

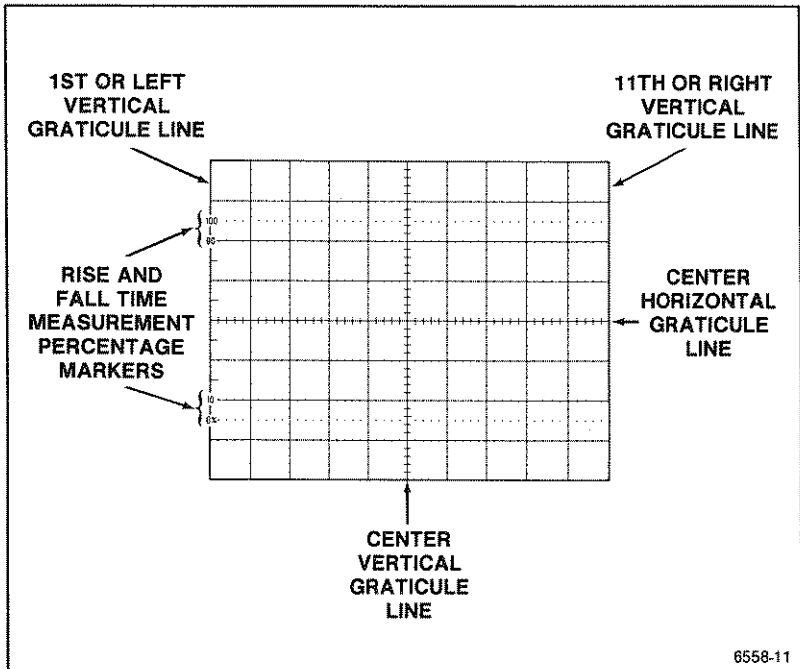

Figure 3-2. Graticule measurement markings.

Connecting Input Signals

Grounding

The most reliable signal measurements are made when the 2245A and the unit under test are connected by a common reference (ground lead) in addition to the single lead or probe. The ground lead of the probe provides the best grounding method for signal interconnection and ensures the maximum amount of signal-lead shielding in the probe cable. A separate ground lead (with a banana plug) can also be connected from the unit under test to the 2245A ground jack on the front panel.

Probes

A probe provides the most convenient way to connect an input signal to the oscilloscope. The standard 10X probes supplied with the 2245A are shielded against electromagnetic interference and have a high input impedance for low circuit loading. The subminiature probe bodies are designed for probing circuitry with closely spaced leads.

SCALE FACTOR SWITCHING. The VOLTS/DIV scale factors, displayed on the crt, reflect the probe attenuation factor when Tektronix coded probes are used.

OPERATING CONSIDERATIONS. To get the best waveform fidelity, keep probe ground and signal leads as short as possible.

Misadjusted probe compensation can cause measurement error. Check and adjust probe compensation whenever a probe is moved to a different channel or oscilloscope. For the probe compensation adjustment procedure, see Section 4 "Operator Checks And Adjustments".

For detailed operating considerations and probe maintenance, see the instruction sheet supplied with the probe.

Coaxial Cables

Signal input cables can greatly affect the accuracy of a displayed waveform. To maintain original frequency characteristics of the input signal, use only high-quality, low-loss coaxial cables. Coaxial cables must be terminated at both ends in their characteristic impedance to prevent signal reflections within the cable. Use suitable impedance-matching devices.

External Triggering

Any of the four vertical channels in the 2245A can be used as a source of A and B trigger signals. When you need a trigger signal source different from the one derived from displayed signals, you can use any free vertical input channel. CH 1 and CH 2 can "condition" a wide range of signals to produce triggers over the full vertical deflection range from millivolts to hundreds of volts. CH 3 and CH 4 have two basic attenuation factors (0.1 and 0.5 volts/division), making them especially useful for triggering on and viewing digital signal levels.

Auto Setup

Pressing the AUTO SETUP button automatically sets up the front-panel controls based on the characteristics of the applied signal. The voltage amplitude, sweep settings, trigger parameters, vertical and horizontal positioning, and trace intensities are preset to produce a usable waveform display. The waveform is horizontally centered and vertically positioned within the crt display. The voltage and frequency characteristics of the input signal must be within the limits of the 2245A specifications given in Section 6.

Auto-setup action for each front-panel control is shown in Appendix A.

MIN SETUP

MIN SETUP is only available on instrUments Serial Numbered BO20100 or above.

Pressing and holding the Auto-Setup button until the instrument returns to normal operation initiates the MIN SETUP function. This automatically sets up the front-panel controls but leaves many of the controls unchanged from what the user has set.

MIN SETUP action for each front-panel control is shown in Appendix A.

MEASUREMENT SYSTEM

The 2245A has a highly accurate voltage- and time- measurement system. Voltage or time is measured between two cursors (or intensified zones for time measurements in the ALT or B Horizontal MODE) that can be positioned, as desired, to two points on the waveform.

Cursor Volts Measurements

Press CURSOR VOLTS to display the voltage measurement cursors and activate the voltage measurement system. The measured value is displayed at the top of the screen.

NOTE

Changing the Horizontal MODE will remove the volts cursors from the display. Set Horizontal MODE back to A or X-Y and press the CURSOR VOLTS button to redisplay the cursors.

The voltage measurement system measures the equivalent voltage difference between two horizontal cursors when the Horizontal MODE is in A or X-Y. Both cursors are positioned by the ← OR DELAY control and the delta cursor is positioned by the →Δ control. When the cursor volts measurement is first turned on, the peak voltages of the source channel signal are measured, and one cursor is placed at the most positive peak and the other is placed at the most negative peak.

The CLEAR MEAS' MT button turns off the measurement.

Time Measurements

Press the TIME button to display the time measurement cursors. The selected measurement type and value are displayed at the top of the screen.

NOTE

Changing the Horizontal MODE from B to X-Y will cancel a time measurement mode. Set Horizontal MODE back to A, ALT, or B and press the TIME or 1/TIME button to reactivate the time measurement mode.

Vertical cursors are displayed for use in setting the time-measurement points in A Horizontal MODE. In ALT Horizontal MODE, the delay measurement is made using either the intensified zones as the measurement points or the alternate B delayed sweeps. For B Delayed Horizontal MODE, the delayed sweeps only are available for making timing measurements.

When the Horizontal MODE is either ALT or B, the B Trigger MODE must be set to RUNS AFTER (if not, the following message will be displayed: "USE RUNS-AFTER-DELAY TRIG MODE"). If the B Trigger MODE is switched away from RUNS AFTER using the front panel Trigger MODE buttons, the selected TIME or 1/TIME measurement will be canceled. Pressing the TIME or 1/TIME button again will reactivate the measurement only if the B Trigger MODE is set to RUNS AFTER.

In the A Horizontal MODE, cursors are used to make the time measurements; in ALT or B Horizontal MODE, the timing measurements are made using either the intensified zones that appear in the A sweep trace in ALT Horizontal MODE or the B delayed waveforms in either ALT or B Horizontal MODE. The ← OR DELAY control positions both cursors or delay times (reference and delta) together, and the →Δ control positions the independent delta cursor or delay when TIME or 1/TIME measurements are selected.

TIME—Press to measure the equivalent time difference between the two vertical cursors displayed in the A Horizontal MODE or the two time delays in ALT or B Horizontal mode. The measured time difference between the two cursors or delays is displayed in the crt readout.

If the Horizontal MODE is X-Y, pressing the TIME button causes the message "USE A OR ALT OR B MODE" to be displayed for two seconds. Changing the Horizontal MODE to X-Y after TIME has been activated, will cancel the measurement with no message.

1/TIME—Measures the time difference in frequency units (hertz) between the cursor positions in A Horizontal MODE or between the delay-time setting and the delta-delay time setting in either ALT or B Horizontal MODE. Measurement points are the left ends of the two intensified zones in ALT Horizontal MODE.

Behavior for Horizontal Mode Changes

If the Horizontal MODE is changed to a mode that cannot be used for the active measurement, that measurement will be canceled without a message being displayed. Returning to a mode that may be used and pressing the measurement button will restore the canceled measurement mode. See Table 3-1 for compatible and incompatible modes.

Table 3-1
Behavior for Horizontal MODE Changes

Measurement Mode	Compatible Horizontal Modes	Incompatible Horizontal Modes
CURSOR VOLTS	A, X-Y	ALT, B
TIME and 1/TIME	A, ALT, B	X-Y

Measurement Compatibility and Error Messages

CURSORS VOLTS measurements cannot occur when the VOLTS/DIV VAR control for the channel being measured is not in the detent position. The displayed error message is "MEAS SOURCE VAR OUT OF DETENT."

TIME and 1/TIME measurements cannot occur when the SEC/DIV VAR control is out of the detent position. The displayed error message is "VAR SECS/DIV OUT OF DETENT."

When in ALT or B Horizontal MODE, and the B Trigger MODE is not RUNS AFTER, a greater than symbol (>) will appear before the delay-time readout. The readout value displayed is the delay time between the A trigger and the time a B trigger can be accepted by the trigger system. A question mark (?) will appear in front of the delay time readout for delay measurements when the DELAY time is set to 0.25 division or less from the beginning of the sweep.

If a time measurement is selected when in ALT or B Horizontal MODE and the B Trigger MODE is NOT RUNS AFTER, the displayed error message is "USE RUNS-AFTER-DELAY TRIG MODE."

Measurements in Single Sequence Mode

All cursor measurements run continuously during SGL SEQ Trigger MODE. The readout and/or cursors are displayed briefly during single sequence mode for making a photographic record (or they may be configured to remain on—see the discussion on Configure Menu in the "SERVICE MENU FEATURES" part of this section.) The displayed readout is the value of the measurement at the instant it is displayed.

B Trigger AUTO LEVEL acquisitions do not occur when the A Trigger MODE is SGL SEQ.

Service Menu Features

Most of the items in the SERVICE MENU are for diagnostics, troubleshooting, and calibration. However, there are three menu selections that are also for operational use: CONFIGURE, SELF CAL MEASUREMENTS, and MAKE FACTORY SETTINGS. Press the CH 1 and CHOP/ALT Vertical MODE buttons at the same time to display the SERVICE MENU as shown in Figure 3-3. Menu selections are made using VERTICAL MODE buttons that correspond to the menu prompts appearing at the right side of the crt display.

A menu-selection underline appears under the SERVICE MENU heading. Pressing the ADD button (down arrow) moves the underline down; the CH 1 button (up arrow) moves the underline up.

Once the desired item is underlined, select RUN (CH 2 button) to start the selected process. Select Quit (CH 4 button) to exit the SERVICE MENU and return to the normal oscilloscope operation.

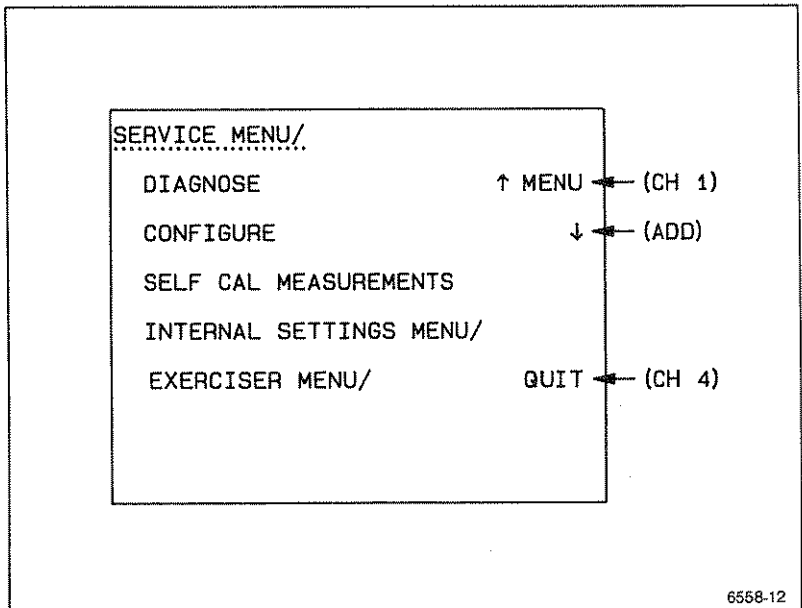

Figure 3-3. Service Menu.

Configure Menu

The CONFIGURE Item allows you to select whether or not to keep the readout on in the single-sequence trigger mode.

Select CONFIGURE from the SERVICE MENU and answer YES or NO to each of the displayed questions. Either YES or NO will be underlined to indicate how the Instrument is presently configured. After YES or NO is selected, the next configuration choice is displayed. After answering the last question, the SERVICE MENU display returns. To exit from the CONFIGURE menu without answering the remaining question(s), press the END button or the CLEAR DISPLAY button. The CONFIGURE items are listed as follows:

NOTE

Instruments Serial Numbered BO20099 or below only have one menu Item in CONFIGURE: KEEP MENU ON WHEN MEAS'MT SELECTED?

KEEP MENU ON WHEN MEAS'MT SELECTED? (Factory Settings default is NO.) Selecting NO clears the measurement menu items from the display after a measurement function is selected. Measurement cursors remain displayed. The AUTO TRACKING MENU remains on after a selection has been made.

Selecting YES allows a measurement menu to remain displayed after a function is selected. The measurement menu items can be removed at any time by pressing the CLEAR DISPLAY button once.

PRESET TV TRIG SLOPE FOR -SYNC? (Factory Settings default is YES.) Selecting YES will cause the trigger slopes to preset to "-" when TV trig mode is selected, and the configure menu is exited. If NO is selected, a second question is presented.

PRESET TV TRIG SLOPE FOR +SYNC? (Factory Settings default is NO.) Selecting YES will cause the trigger slopes to preset to "+" when TV trig mode is selected, and the configure menu is exited. If NO is selected, the scope will not use a preset slope when a TV trig mode is selected.

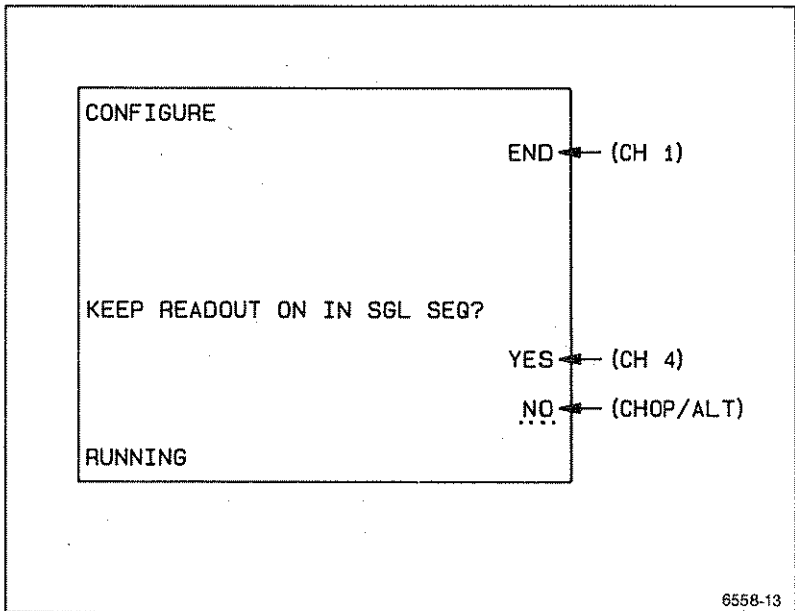

Figure 3-4. Configure Menu.

After YES or NO is selected, the SERVICE MENU/ display returns. Select INTERNAL SETTINGS MENU to continue with the testing or select QUIT to return to normal oscilloscope operating mode.

Self Cal Measurements

This selection does a self-characterization of the vertical channels 1 and 2, and the horizontal timing. The SELF CAL MEASUREMENTS routine stores calibration constants that set the accuracy of the internal measurement system.

NOTE

SELF CAL MEASUREMENTS can be performed anytime after a 20-minute warmup time to ensure the accuracy stated in Section 6.

Internal Settings Menu

The INTERNAL SETTINGS MENU (see Figure 3-5) consists of MAKE FACTORY SETTINGS and ADJUST VERTICAL OUTPUT. MAKE FACTORY SETTINGS can be performed by the operator; ADJUST VERTICAL OUTPUT is for use by servicing personnel. To return to SERVICE MENU, set the up-arrow key to underline INTERNAL SETTINGS MENU and press the button again to display the SERVICE MENU. To return to the oscilloscope mode, select QUIT from the INTERNAL SETTINGS MENU or SERVICE MENU, or press the CLEAR MEAS'MT button.

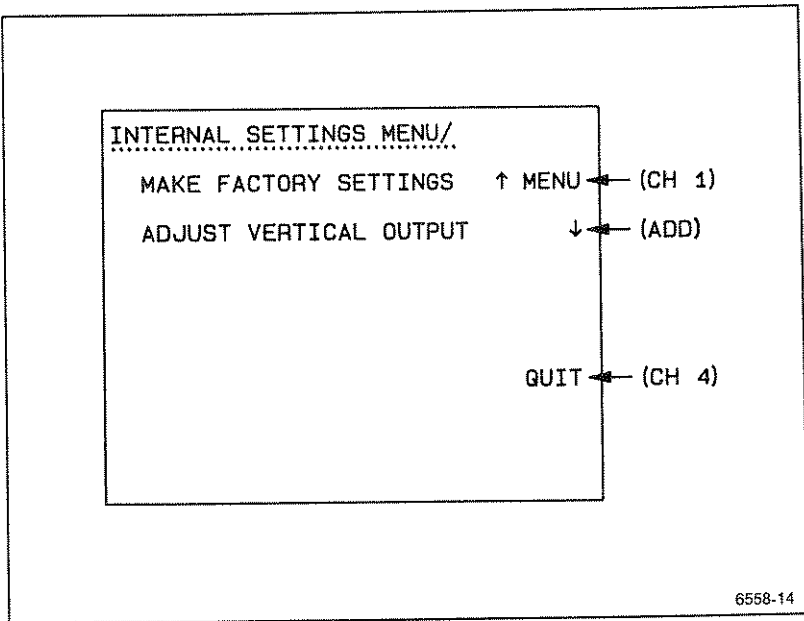

Figure 3-5. Internal Settings Menu.

MAKE FACTORY SETTINGS. Sets the front-panel controls and menu configurations as described in Appendix B.

SECTION 4

**OPERATOR
CHECKS AND
ADJUSTMENTS**

Introduction

The checks and adjustments in this section are for the operator and involve using only controls and adjustments on the outside of the instrument. Internal adjustments must be made by a qualified service person.

Before operating the instrument for the first time and before connecting the power, refer to Section 1 "Preparation for Use" to prepare the instrument for the initial startup.

Verify that the POWER switch is OFF (out position). Plug the power cord into a power-source outlet that supplies a voltage within the operating range of the instrument's power supply.

NOTE

If you notice an improper indication or instrument malfunction during these procedures, refer the instrument to a qualified service person.

Initial Setup

The following procedure may be used to set up front-panel controls when the instrument is first turned on or when a signal is not being applied to the input-connectors.

1. Press in the POWER switch button (ON) and let the instrument warm up (20 minutes is recommended for maximum accuracy).
2. Set the instrument front-panel controls to obtain a baseline trace:

Vertical Controls

VERTICAL MODE	CH 1
POSITION	Center the trace
VOLTS/DIV	1 V
VOLTS/DIV VAR	Calibrated detent
Channel 1 COUPLING	GND

Horizontal Controls

MODE	A
POSITION	Center the trace
X10 MAG	Off
A SEC/DIV	0.1 ms
SEC/DIV VAR	Calibrated detent

Trigger Controls

HOLDOFF	MIN
A/B SELECT	A
MODE	AUTO LEVEL
SOURCE	VERT
CPLG	DC

Display

A INTEN	Desired brightness
FOCUS	Best trace definition
READOUT	Desired brightness
SCALE ILLUM	Desired brightness

Measurement Functions

CLEAR MEAS'MT	Press to remove any displayed cursors
---------------	---------------------------------------

Auto Setup Function

The Auto Setup function can be used to automatically set up the front-panel controls to produce a usable display of the applied signal.

1. Connect signal(s) to be displayed to the appropriate input connector(s).

For triggering to be set up properly when the AUTO SETUP button is pressed, connect the trigger-source signal to the lowest numbered channel that will be turned on.

2. Set:

VERTICAL MODE	As desired (see NOTE)
Horizontal MODE	As desired

3. Press the AUTO SETUP button.

NOTE

Normally, the Auto Setup of the display is sufficient for measurement purposes. If further waveform enhancement is needed, use the appropriate front-panel controls to adjust the display. For auto-setup action, see Appendix A.

Trace Rotation Adjustment

1. Perform the "Initial Setup" procedure. Position the trace vertically to align it with the center horizontal graticule line and check that the trace is parallel with the graticule line.

NOTE

Normally, the trace will be parallel to the center horizontal graticule line, and the TRACE ROTATION adjustment will not be needed.

2. If necessary, adjust the TRACE ROTATION to make the baseline trace parallel to the center horizontal graticule line. Use a small straight-blade screwdriver or alignment tool.

Probe Low-Frequency Compensation

Misadjustment of probe compensation is a possible source of measurement error. The attenuator probes are equipped with compensation adjustments. To ensure the best measurement accuracy, always check probe compensation before making measurements.

1. Connect the two supplied 10X probes to the CH 1 and CH 2 BNC input connectors.

2. Connect the probe tips to the PROBE ADJUST connector and the probe ground leads to scope ground.
3. Set:

VERTICAL MODE	CH 1
Horizontal MODE	A
4. Press AUTO SETUP button.
5. Set the CH 1 VOLTS/DIV setting to 0.1 V (10 mV with probe disconnected) and vertically center the PROBE ADJUST square-wave signal.
6. Check the square-wave signal for overshoot and rolloff (see Figure 4-1). If necessary, use the special adjustment tool supplied in the probe accessory package to adjust the low-frequency compensation for a square front corner on the square wave displayed.
7. Press the CH 2 VERTICAL MODE button to turn CH 2 on in the display, and press the CH 1 Mode button to remove the CH 1 trace from the display.
8. Set the CH 2 VOLTS/DIV setting to 0.1 V (10 mV with probe disconnected) and vertically center the PROBE ADJUST square-wave signal.
9. Repeat Step 6 for the second probe on the CH 2 BNC input connector.

NOTE

Refer to the instruction manual supplied with the probe for more detailed information about the probes and adjustment procedure.

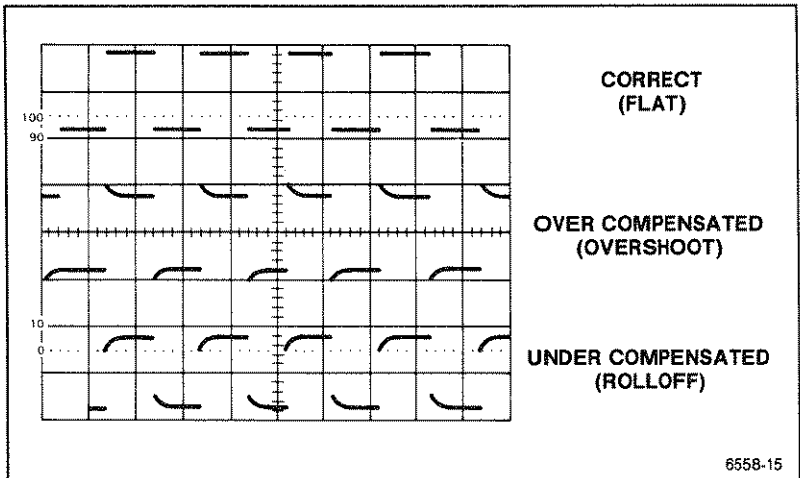

Figure 4-1. Probe compensation.

Vertical Deflection Check

The PROBE ADJUST square-wave signal may be used to check the Channel 1 and Channel 2 vertical deflection system in the following procedure:

1. Connect the two 10X probes (supplied) to the CH 1 and CH 2 input connectors.
2. Connect both probe hook tips to the PROBE ADJUST connector.
3. Set:

VERTICAL MODE	CH 1
Horizontal MODE	A
4. Press AUTO SETUP button.
5. Set CH 1 and CH 2 VOLTS/DIV switches to 0.1 V for the attached 10X probes.

6. Set the bottom of the trace of the PROBE ADJUST square-wave signal to a convenient horizontal graticule line with the Vertical POSITION control.
7. Check for a five-division display of the PROBE ADJUST square-wave signal.
8. Select CH 2 VERTICAL MODE and repeat steps 6 and 7.
9. Disconnect the probes from the instrument.

Timing Checks

The time measurement cursors may be used to check the horizontal deflection system.

1. Preset instrument controls and obtain a baseline trace and set the A SEC/DIV switch to 0.1 ms. Vertically center the baseline trace.
2. Press the TIME button to select the Time Measurement function for measuring time difference.
3. Align the reference cursor to the second vertical graticule line using the ← OR DELAY control (both cursors are positioned together).
4. Adjust the → control for a reading of 800.0 μ s
5. Check that the cursors are eight divisions apart.
6. Press the CLEAR MEAS'MT button to remove the cursors from the display.

SECTION 5

**BASIC
APPLICATIONS**

Introduction

The TEKTRONIX 2245A Oscilloscope has a cursor measurement system for making accurate, direct-readout voltage, time, and frequency measurements. The measurements given in this section are examples of typical applications using this measurement system. After becoming familiar with the controls, indicators, and capabilities of the instrument, you can develop convenient methods for making special measurements for your own applications. A brief description of how the graticule markings are used in making measurements is given in Section 3 of this manual.

When a procedure calls for "Initial Setup" or "Auto Setup Function," refer to the "OPERATOR CHECKS AND ADJUSTMENTS" Section 4. Certain signals such as video or aperiodic (non-repeating) signals and signals containing many unrelated frequency components may require more adjustment of the triggering controls to obtain the best display.

Voltage Measurement Cursors

The CURSOR VOLTS function can accurately measure signals displayed on CH 1 or CH 2. Voltage measurements using the cursors may also be done on CH 3, CH 4, and ADD waveforms by setting the VOLTS/DIV switch setting of the selected measurement channel to the same scale factor as the signal to be measured. However, measurements on CH 3 or CH 4 input signals will be less accurate than on the CH 1 or CH 2 input signals. Volts cursors are available for making measurements in the both the A and X-Y horizontal modes.

Voltage Difference

Use the following procedure steps as a guideline in making voltage-difference measurements using the positionable voltage cursors.

1. Apply the signal to the CH 1 input connector.
2. Set:

Vertical MODE	CH 1
Horizontal MODE	A

3. Press AUTO SETUP button.

- Adjust the CH 1 VOLTS/DIV control so that the signal fills as much of the screen as possible.
- Press the CURSOR VOLTS button to display the voltage cursors. The voltage cursors are initialized to the peak-to-peak voltage levels of CH 1. (See Figure 5-1).

NOTE

Voltage cursors are initialized to levels seen by the peak detector circuitry. Noise and other signals riding on the signal to be measured will cause a slight displacement of the cursors from the displayed waveform peaks, and above 50 MHz the bandwidth rolloff of the trigger circuit will affect the initial cursor positions on the waveform.

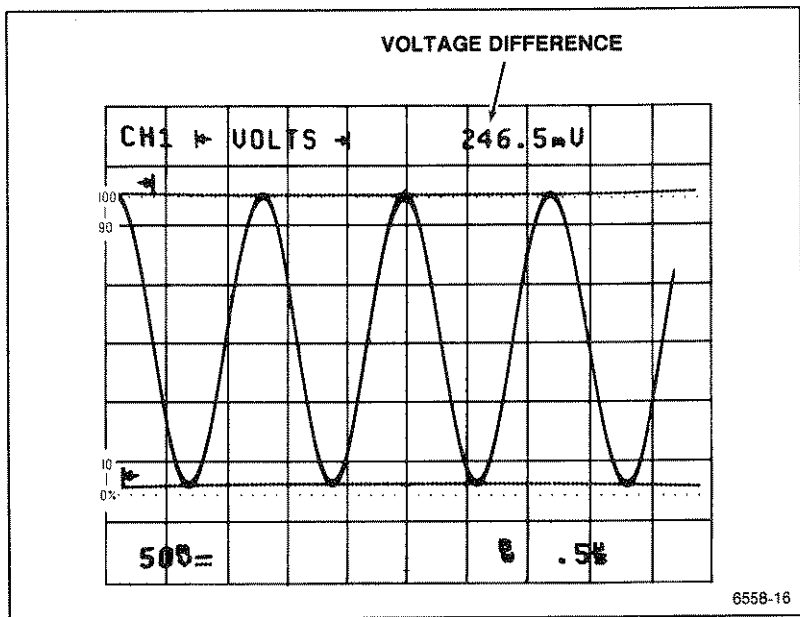

Figure 5-1. Voltage difference measurement using cursors.

6. For a peak-to-peak voltage measurement, slightly reposition the cursors as necessary to precisely align them with the peaks of the waveform. The \leftarrow OR DELAY control positions both cursors together (keeping the original difference between cursors), and the \rightarrow control positions the independent cursor. Read the measurement value displayed in the top line of the readout.
7. To make voltage difference measurements between any other locations on the waveform, move the \leftarrow cursor to the more-negative point of interest, then position the independent \rightarrow cursor to the more positive point on the waveform. Read the voltage difference.

Time Measurement Cursors

Time measurement cursors may be used on any of the input waveforms only in the A Horizontal MODE. (Time measurements are also available in ALT and B Horizontal MODE; see "Time Delay Measurement" in this section.)

Time Difference

Use the following procedure steps as a guideline in making time difference measurements using the TIME cursors. As with the voltage cursors, the \leftarrow OR DELAY control positions both cursors together, and the \rightarrow control positions the independent (delta-time) cursor.

1. Apply the signal to the input connector(s).

NOTE

Make sure that the signal used as the trigger source is connected to the lowest numbered channel that will be turned on.

2. Set:

Vertical MODE	As desired.
Horizontal MODE	A

3. Press AUTO SETUP button.

4. Adjust the VOLTS/DIV control so that the measurement points can be easily seen.

5. Select a SEC/DIV setting that provides the fewest number of cycles of the applied waveform necessary to display the measurement points of interest. This is to improve the accuracy of cursor placement for the measurement.

6. Press the TIME button to display the time cursors.

NOTE

The independent cursor (→) cannot be positioned in front of the reference cursor (← OR DELAY).

7. Use the ← OR DELAY control to position the reference cursor to the leftmost point on the waveform to be measured. Use the → control to position the independent cursor to the rightmost point to be measured. Then, read the time difference value in the top line of crt readout.

Period Measurement

This is a time-difference measurement. Position the TIME cursors to define a full period (1 cycle) of the input waveform. Its value is displayed. Use the setup for making time-difference measurements as a guideline for making period measurements (see Figure 5-2).

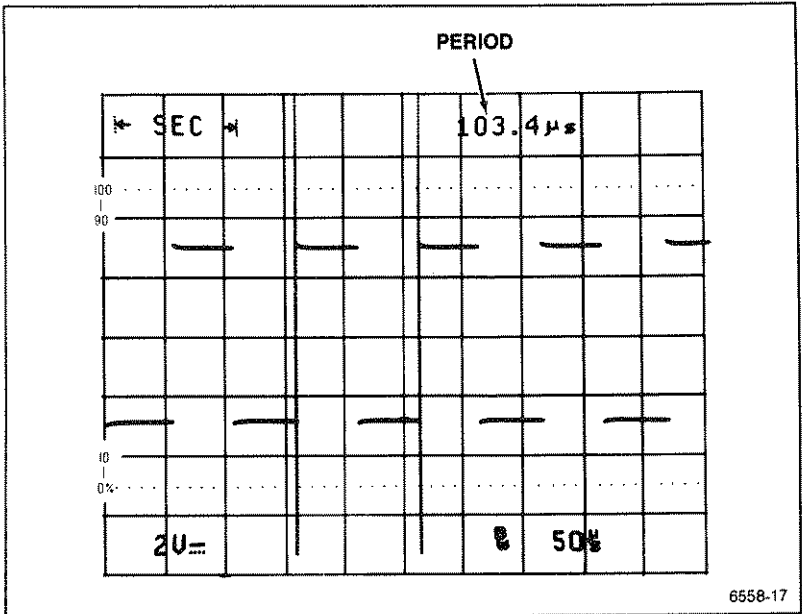

Figure 5-2. Period measurement.

Frequency Measurement

A frequency measurement is made using the same method as a period measurement; the difference is that the 1/TIME measurement mode is selected instead of TIME. The measurement value is displayed in frequency units. When the full period is defined by positioning the cursors, the frequency of the signal is displayed. Use the same front panel setup used for time-difference measurement as a guideline for making a frequency measurement with cursors (see Figure 5-3).

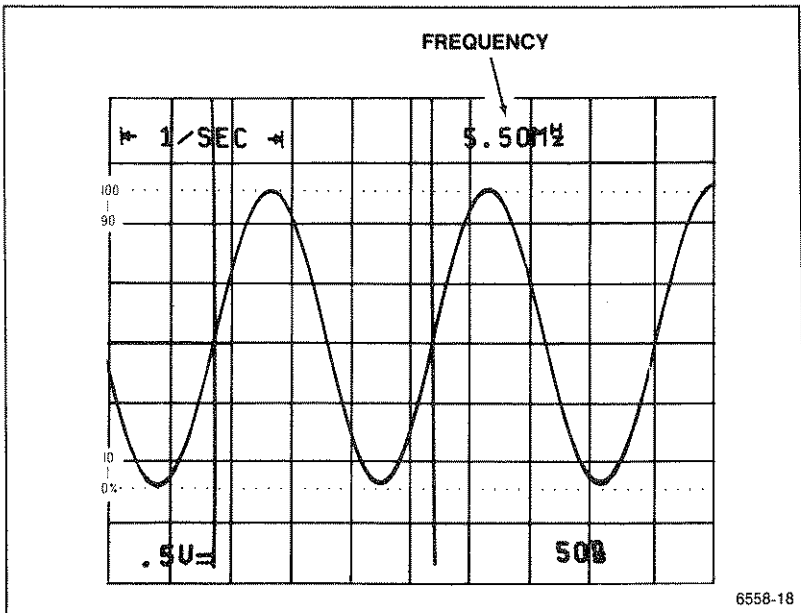

Figure 5-3. Frequency measurement.

Rise-Time Measurements

Making rise-time or fall-time measurements requires some additional signal scaling to use the graticule rise-time measurement aids. Numbers 0%, 10, 90, and 100 are etched near the left vertical graticule line. These numbers provide convenient reference points for making rise- and fall-time measurements when the signal to be measured is properly set up. Use the following steps as a guideline in making rise-time measurements.

1. Apply the signal to the CH 1 input connector.

2. Set:

Vertical MODE CH 1

Horizontal MODE A

A Trigger SLOPE 

3. Press AUTO SETUP button.
4. Set the CH 1 VOLTS/DIV and VOLTS/DIV VAR controls to provide an exact five-division vertical display.
5. Use the CH 1 Vertical POSITION control to place the negative amplitude of the signal on the 0% reference line and the positive amplitude on the 100% reference line.
6. Increase the SEC/DIV setting to stretch out the rising edge of the waveform as much as possible to improve the cursor placement accuracy (see Figure 5-4).
7. Adjust the Trigger LEVEL control, if necessary, to get the 10% level on screen.

NOTE

If measuring fall time, use negative SLOPE. This places the trigger point at the beginning of the sweep so that when the SEC/DIV setting is advanced, the slope of interest remains within the viewing area.

8. Increase the A INTEN control if necessary to brighten the beginning of the trace, and use the Horizontal POSITION control to place the 50% level (center) of the rising edge of the waveform at the center vertical graticule line.
9. Press TIME button to display the time cursors.
10. Use the ← OR DELAY control to align the first cursor to the rising edge at the point where it crosses the 10% reference graticule line. Then use the → control to align the second cursor to the point where the rising edge crosses the 90% graticule line and read the rise time displayed in the top line of the crt readout (see Figure 5-4).

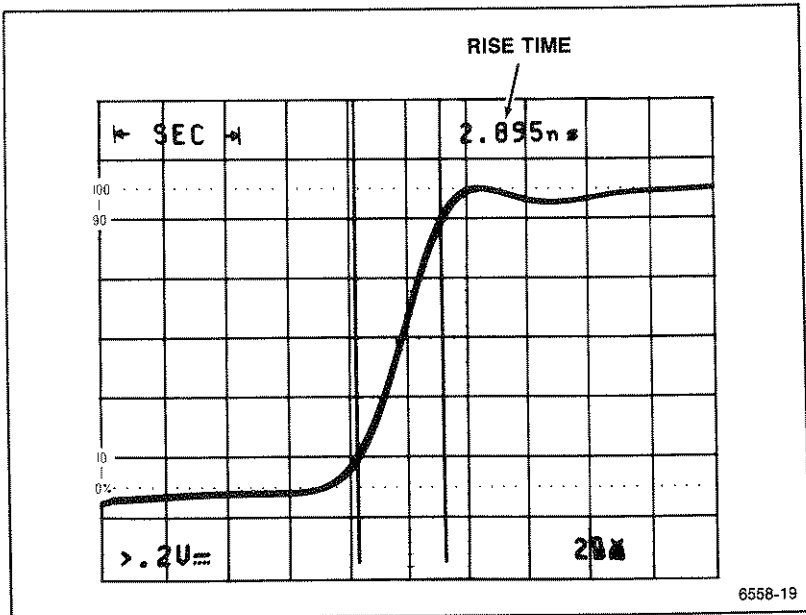



Figure 5-4. Rise-time measurement.

Phase Measurements

Making a phase measurement is done by first setting a reference for the full 360 degree waveform period. Use the following procedure as a guide:

1. Apply the reference waveform to the CH 1 input connector (any channel may be used, but CH 1 and CH 2 provide the most signal scaling possibilities). Use the standard 10X attenuator probe supplied with the instrument to make the signal connections as they produce very little signal loading to a circuit under test and produce matched delays. For phase measurements, external loading of a circuit and different delays in the signal connection paths will produce incorrect results.

2. Select CH 1 for display using the Vertical MODE buttons, and set the Input COUPLING for CH 1 and CH 2 to DC. AC may be used if the signals to be measured are riding on a dc voltage, but set both inputs to the same coupling. AC coupling produces some signal phase shift, especially at lower frequencies.
3. Set the CH 1 VOLTS/DIV control to display the reference waveform with about five divisions of amplitude. Vertically center the waveform.
4. Set the A SEC/DIV setting (in A Horizontal MODE) to display at least one complete reference waveform period and no more than two (if possible). An excessive number of cycles of the reference waveform in the display reduces the ability to make an accurate reference setting.
5. Select  or  SLOPE to position the waveform correctly within the graticule area for ease in measurement when viewing a single cycle of the reference signal.
6. Press the TIME button to display time cursors.
7. Position the first vertical cursor to the point where the reference waveform crosses the center horizontal graticule line in the positive direction (see Figure 5-5A). The Horizontal POSITION control may be used as necessary to center the waveform period in the viewing area.
8. Position the delta cursor to the second positive crossing of the center horizontal graticule line by the reference waveform as shown in Figure 5-5A.
9. Note the time readout at the top of the graticule. This is the 360° reference time.
10. Apply the phase-shifted, sine-wave signal to be measured to the CH 2 input connector using a 10X probe, and turn CH 2 Vertical MODE on to display the signal.

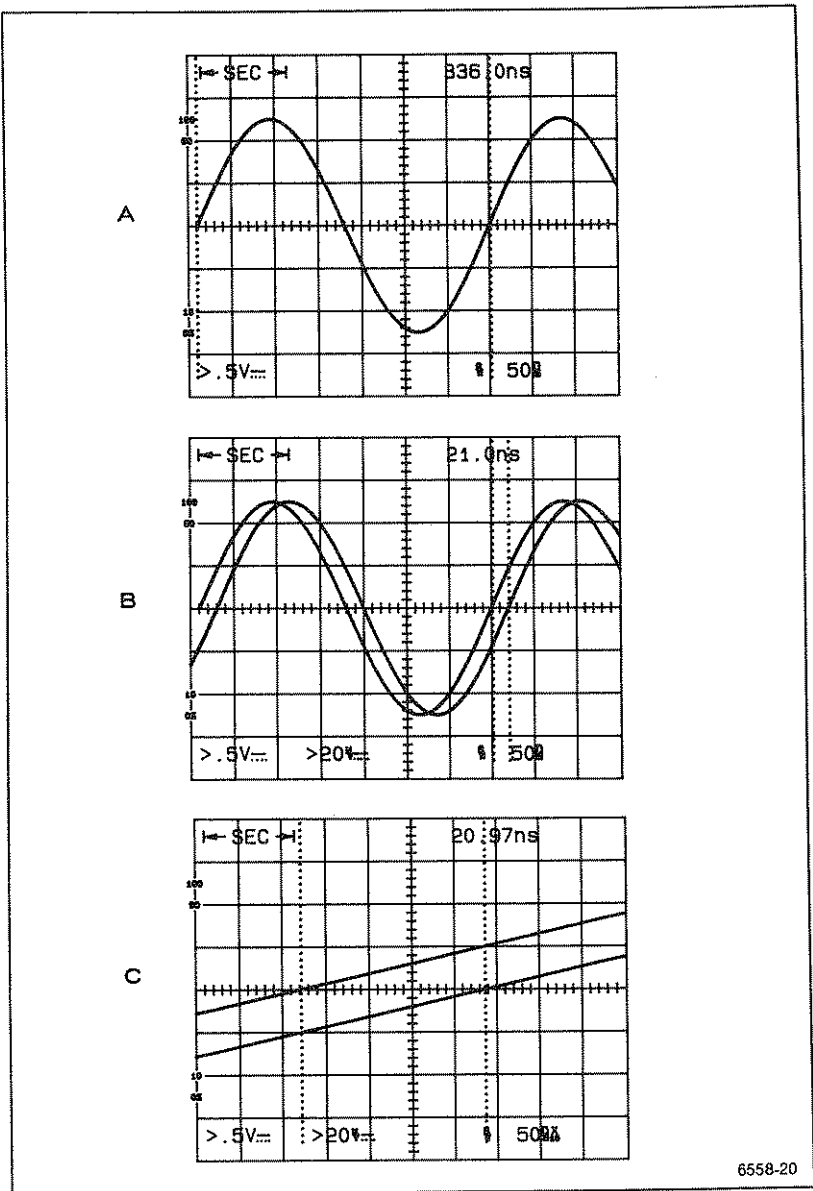

Figure 5-5. Phase difference measurement.

11. Set the VOLTS/DIV and VOLTS/DIV VAR controls to match the amplitude of the phase-shifted signal to that of the reference waveform as shown in Figure 5-5B. Use the Vertical POSITION control as necessary to align the two waveforms vertically.
12. Position the cursors to a positive or negative crossing of each signal as shown in Figure 5-5B.

NOTE

Figure 5-5B shows the delta time measurement made from the second positive crossing of each waveform. The delta time could also be measured from the first positive crossing (near the left edge of the screen), or the first negative crossing (near center screen).

Read the delta time at the top of the graticule and calculate the phase difference from the formula:

$$\begin{aligned} \text{Phase Difference (in degrees)} &= \frac{\text{delta time}}{\text{reference time}} \times 360^\circ \\ \text{or, as in Figure 5-5,} &= \frac{20.97 \text{ ns}}{336 \text{ ns}} \times 360^\circ = 22.5^\circ \end{aligned}$$

NOTE

For increased resolution of the phase measurement, the sweep may be increased and both cursors repositioned to the measurement points (see Figure 5-5C). The X10 MAG feature may also be used in a similar manner by placing the measurement points at the center vertical graticule line before pressing the X10 MAG button (you may want to reduce the A SEC/DIV setting prior to turning on the X10 MAG).

Time Delay Measurement

When using ALT Horizontal Mode, the TIME measurement mode provides two intensified zones on the A trace. There are also two B delayed traces matching each intensified zone. A direct readout of the delay difference between the two zones is displayed in the top line of crt readout. Use the following procedure steps as a guideline for making delta-time delay-time measurements.

1. Apply the signal or signals that measurements are to be made on to the vertical input connector(s). When making delay measurements between two different channels always connect the reference signal to the lower numbered channel and the delta signal to the higher numbered active channel. Turn on the Vertical MODE channels needed to display the signals.
2. Set A Trigger MODE to AUTOLEVEL, B Trigger MODE to RUNS AFTER, and A Trigger SOURCE to VERT.
3. Use a VOLTS/DIV setting that produces a usable vertical display amplitude for viewing ease; use an A SEC/DIV setting that produces two to five repetitions or cycles of the signal across the graticule area.

NOTE

When viewing multiple traces, it is best to limit the vertical amplitude to about two divisions so that good trace separation may be obtained in the display.

4. Switch the Horizontal MODE to ALT. Advance the SEC/DIV setting at least one position to obtain a faster B SEC/DIV setting.
5. Press the TIME button to turn on the time-delay measurement mode which displays two intensified zones on the A Sweep trace and two alternate B Delay Sweeps. Use the TRACE SEP and Vertical POSITION controls to position the sweeps vertically in the graticule area for ease of viewing the separate traces.

NOTE

When the TIME button is pushed, the delay-time measurement channel is automatically set to the lowest numbered active channel and the delta-time measurement channel is set to the next lowest numbered active channel. If one of the measurement channels is turned off when the time-delay measurement mode is active, both intensified zones will be displayed on the other measurement channel. Both intensified zones must be displayed on the same channel for making period, pulse width, or rise-time and fall-time measurements. If only a single channel is selected for display, both delays will default to that channel.

- Using the center vertical graticule line as a reference point, set the reference delay to align the B Sweep display of the first point of interest to be measured to that reference point with the \leftarrow OR DELAY control. Set the time delay to align the B Sweep display of the second point of interest to the reference point using the \rightarrow control. The time difference between the two B Sweep delays is displayed at the top of the screen.

Once the measurement points are identified, the A Intensified Sweep traces may be removed from the display for ease in viewing the B Sweep traces by switching to B Delayed Horizontal MODE. In B Horizontal MODE, exact placement of the two delays may be obtained by positioning one trace over the other and then aligning the measurement point using the \rightarrow control. Additional resolution may be obtained by advancing the B SEC/DIV switch setting to further expand the B Sweep traces.

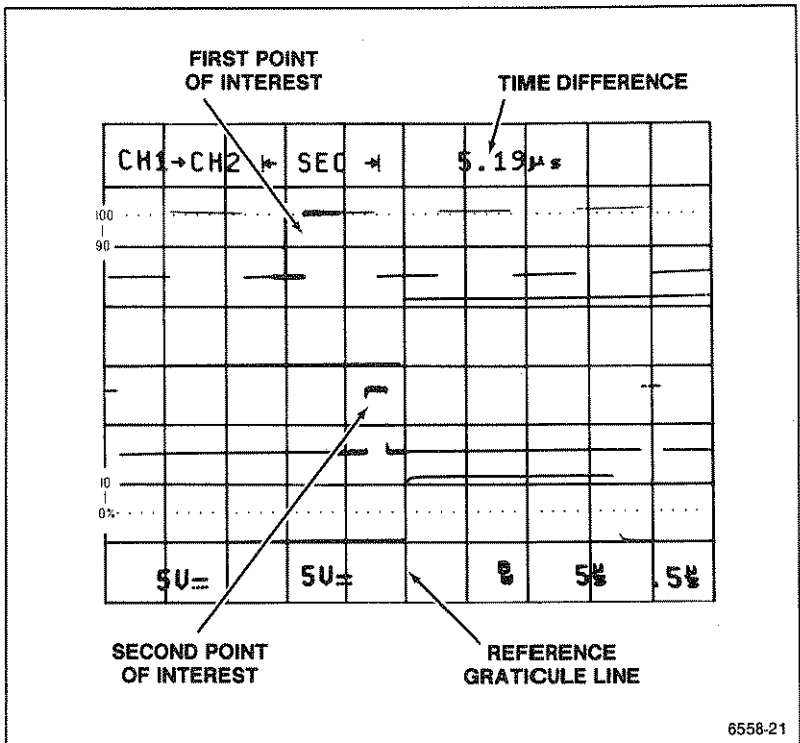

Figure 5-6. Time difference between two delays.

Add Mode

With the Vertical MODE set to ADD, the resulting waveform is the algebraic sum of the signals applied to the Channel 1 and Channel 2 inputs (CH 1 + CH 2). A plus symbol (+) appears in the readout between the CH 1 and CH 2 VOLTS/DIV setting readout to indicate that ADD is active. If the CH 2 INVERT feature is turned on (INVERT button light on), the waveform displayed is the difference between the signals applied to the Channel 1 and Channel 2 inputs. Neither CH 1 nor CH 2 waveform needs to be displayed to obtain the ADD trace, but any or ALL vertical input channels may be displayed at the same time if desired.

When CH 1 and CH 2 VOLTS/DIV switches are set to the same setting, the total deflection factor in the ADD mode is equal to the deflection factor indicated by either VOLTS/DIV readout. The voltage cursors may be used to make voltage measurements on the ADD trace if either CH 1 or CH 2 is displayed along with the ADD trace (CH 1 and CH 2 must be at the same VOLTS/DIV setting). If any voltage measurement function is active, turning off CH 1 and CH 2 to display the ADD trace by itself causes the message "VOLTMETER SOURCE: CH 1 OR 2 ONLY" to appear and cancels the measurement. If calling for a voltage measurement with ADD displayed and neither CH 1 nor CH 2 displayed, the CH 1 Vertical MODE is turned on, and the measurement is initialized to the signal applied to the CH 1 input.

Two common uses for ADD mode are: (1) providing a dc offset to bring an ac signal riding on top of a large dc voltage within the graticule viewing area and (2) canceling out a large line-frequency signal component to view some small feature riding on the waveform in greater detail using common-mode rejection.

The following general precautions should be observed when using ADD mode.

- a. Do not exceed the input-voltage rating of the oscilloscope or probe.
- b. Do not apply signals that exceed the equivalent of about eight times the VOLTS/DIV switch settings, since large voltages may distort the display. For example, with a VOLTS/DIV setting of 0.5 V, the voltage applied to that channel should not exceed 4 V.
- c. Use CH 1 and CH 2 POSITION control settings which most nearly position the signal on each channel to mid-screen when viewed separately. This ensures the greatest dynamic range for ADD mode signal displays.

- d. To have similar responses for both channels, use the same Input COUPLING for both CH 1 and CH 2.

The following procedure shows how to eliminate an unwanted ac input-power frequency signal component from the displayed signal.

- a. Perform the "Initial Setup" in "OPERATOR CHECKS AND ADJUSTMENTS" Section 4, but do not apply any signals and center the baseline trace vertically.
- b. Apply the signal of interest containing the unwanted line-frequency component to the CH 1 input connector.
- c. Apply a line-frequency signal to the CH 2 input connector. To maximize cancellation, the signal applied to the CH 2 input must be in phase with the frequency component to be canceled from the CH 1 signal.
- d. Select CH 1 and CH 2 Vertical MODE.
- e. Set Trigger SOURCE switch to VERT.
- f. Set both VOLTS/DIV switches to produce displays of about two or three divisions in amplitude.
- g. Adjust the CH 2 VOLTS/DIV switch and VAR control so that the CH 2 display is about the same amplitude as the component to be canceled in the CH 1 waveform (see Figure 5-7A).
- h. Select both ADD and CH 2 INVERT. Turn off the CH 1 and CH 2 displays and slightly readjust the CH 2 VOLTS/DIV VAR control for maximum cancellation of the line-frequency component (see Figure 5-7B).
- i. The SEC/DIV setting may be set to a faster sweep speed to expand the waveform and the display amplitude may be increased by advancing both VOLTS/DIV switches and readjusting the VOLTS/DIV VAR controls as necessary to maintain cancellation of the undesired signal component.

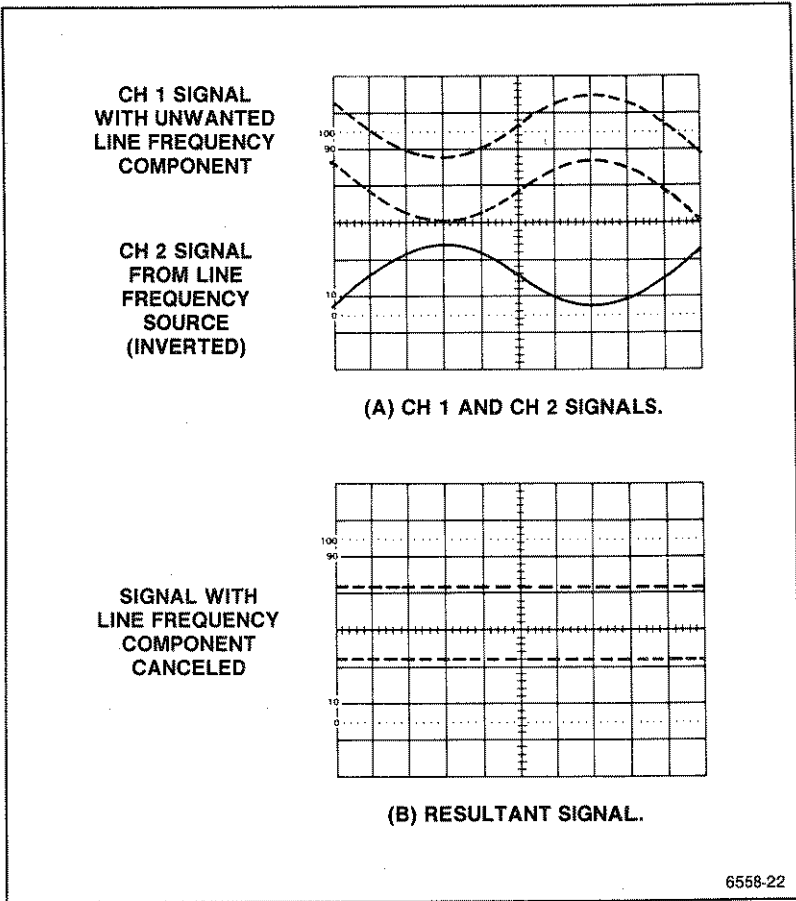

Figure 5-7. Eliminating common-mode signals.

SECTION 6

**PERFORMANCE
CHARACTERISTICS**

Introduction

Electrical characteristics in Table 6-1 apply when the 2245A has been calibrated at an ambient temperature between +20°C and +30°C, has warmed up at least 20 minutes, and is operating in an ambient temperature between -10°C and +55°C (unless otherwise noted).

Items listed in the "Performance Requirements" column are verifiable qualitative or quantitative limits that define the measurement capabilities of the instrument.

Environmental Specifications of the 2245A are in Table 6-2, and Mechanical Specifications are in Table 6-3.

Recommended Calibration Schedule

To ensure accurate measurements, check the performance of this instrument every 2000 hours of operation (once each year if used infrequently). When components are replaced, affected circuits may have to be readjusted.

Table 6-1
Electrical Characteristics

CHARACTERISTICS	PERFORMANCE REQUIREMENTS
VERTICAL DEFLECTION SYSTEM — CH 1 AND CH 2	
Deflection Factor	
Range	2 mV/div to 5 V/div in 1-2-5 sequence. ^a
Accuracy (includes ADD MODE and CH 2 INVERT)	
15 °C to 35 °C	Within ± 2%.
-10 °C to 15 °C and 35 °C to 55 °C	Within ± 2%. ^a
Variable Range	Increases deflection factor by at least 2.5:1.
Frequency Response (-3 dB bandwidth)	
-10 °C to 35 °C	
5 mV to 5 V/div	Dc to 100 MHz (at the input BNC and at the probe tip).
2 mV	Dc to 90 MHz (at the input BNC and at the probe tip).
35 °C to 55 °C	Dc to 90 MHz (at the input BNC and at the probe tip).
AC Coupled Lower -3 dB Point	
1X Probe	10 Hz or less.
10X Probe	1 Hz or less.
Step Response (5-division step)	
Rise Time	
-10 °C to 35 °C	
5 mV to 5 V/div	3.5 ns or less (calculated). ^a
2 mV	3.9 ns or less (calculated). ^a
35 °C to 55 °C	3.9 ns or less (calculated). ^a

^a Performance Requirement not checked in manual.

Table 6-1 (cont)

CHARACTERISTICS	PERFORMANCE REQUIREMENTS				
Delay Match (CH 1 to CH 2)	Less than 200 ps difference.				
Common Mode Rejection Ratio (CMRR)	At least 10:1 at 50 MHz for signals of eight divisions or less with VOLTS/DIV VAR adjusted for best CMRR at 50 kHz.				
Channel Isolation (attenuation of deselected channel) 2 mV/Div to 0.5 V/Div	<table border="1"> <thead> <tr> <th>10 MHz</th> <th>100 MHz</th> </tr> </thead> <tbody> <tr> <td>50 dB or more</td> <td>34 dB or more</td> </tr> </tbody> </table> <p>Channel isolation tested with eight-division input signal.</p>	10 MHz	100 MHz	50 dB or more	34 dB or more
10 MHz	100 MHz				
50 dB or more	34 dB or more				
Trace Shift as VAR VOLTS/DIV is Turned	1 division or less.				
Invert Trace Shift	1 division or less.				
Trace Shift Between VOLTS/DIV Switch Positions	0.2 division or less.				
Trace Shift Between GND and DC Input Coupling					
-10 °C to 35 °C	Less than 0.5 mV.				
35 °C to 55 °C	Less than 2 mV. ^a				
Position Range	At least ± 11 divisions from graticule center.				
Input Characteristics					
Resistance	1 M Ω $\pm 1\%$. ^a				
Capacitance	20 pF ± 1 pF. ^a				
Capacitance Match Between Any Two VOLTS/DIV Settings	± 0.5 pF.				
Maximum Input Volts Δ	400 V (dc + peak ac); 800 V p-p at 10 kHz or less. ^a (See Figure 6-1.)				

^a Performance Requirement not checked in manual.

Table 6-1 (cont)

CHARACTERISTICS	PERFORMANCE REQUIREMENTS
VERTICAL DEFLECTION SYSTEM — CH 3 AND CH 4	
Deflection Factor	
Range	0.1 V per division and 0.5 V per division. ^a
Accuracy	
15° C to 35° C	Within ± 2%.
-10° C to 55° C	Within ± 3%.
Frequency Response (-3 dB bandwidth)	
-10° C to 35° C	Dc to 100 MHz (at the input BNC and at the probe tip).
35° C to 55° C	Dc to 90 MHz (at the input BNC and at the probe tip). ^a
Step Response (5-division step)	
Rise Time	
-10° C to 35° C	3.5 ns or less. ^a
35° C to 55° C	3.9 ns or less. ^a
Delay Match (CH 3 to CH 4)	Less than 200 ps difference.
Trace Shift Between VOLTS/DIV Settings	1 division or less.
Position Range	At least ± 11 divisions from graticule center.
Channel Isolation (attenuation of deselected channel)	34 dB or more at 100 MHz. Channel isolation tested with eight-division input signal.
Input Characteristics	
Resistance	1 M Ω ± 1.0%. ^a
Capacitance	20 pF ± 1 pF. ^a
Maximum Input Volts Δ	400 V (dc + peak ac); 800 V p-p at 10 kHz or less. ^a (See Figure 6-1.)

^a Performance Requirement not checked in manual.

Table 6-1 (cont)

CHARACTERISTICS	PERFORMANCE REQUIREMENTS						
VERTICAL DEFLECTION SYSTEM — ALL CHANNELS							
Bandwidth Limit (-3 dB bandwidth)	20 MHz \pm 15%.						
Low Frequency Linearity (Relative to center screen)	Within \pm 5%. Linearity is measured by positioning a two- division test signal anywhere on screen and noting the amplitude change.						
TRACE SEP Control Position Range	At least \pm 4 divisions.						
CHOP Mode Clock Rate	625 kHz \pm 10%. ^a						
Delay Match (CH 1 or CH 2 to CH 3 or CH 4)	Less than 200 ps difference.						
HORIZONTAL DEFLECTION SYSTEM							
Sweep Range							
A Sweep	0.5 s/div to 20 ns/div in a 1-2-5 sequence. ^a X10 magnifier extends maximum sweep speed to 2 ns/div.						
B Sweep	5.0 ms/div to 20 ns/div in a 1-2-5 sequence. ^a X10 magnifier extends maximum sweep speed to 2 ns/div.						
Accuracy							
15°C to 35°C	<table border="1" style="margin-left: auto; margin-right: auto;"> <thead> <tr> <th>Unmagnified</th> <th>Magnified</th> </tr> </thead> <tbody> <tr> <td style="text-align: center;">\pm 2%</td> <td style="text-align: center;">\pm 3%</td> </tr> <tr> <td style="text-align: center;">\pm 3%</td> <td style="text-align: center;">\pm 4%</td> </tr> </tbody> </table>	Unmagnified	Magnified	\pm 2%	\pm 3%	\pm 3%	\pm 4%
Unmagnified	Magnified						
\pm 2%	\pm 3%						
\pm 3%	\pm 4%						
-10°C to 15°C and 35°C to 55°C	<table border="1" style="margin-left: auto; margin-right: auto;"> <tbody> <tr> <td style="text-align: center;">\pm 3%</td> <td style="text-align: center;">\pm 4%</td> </tr> </tbody> </table>	\pm 3%	\pm 4%				
\pm 3%	\pm 4%						
	Sweep Accuracy applies over the center eight divisions. Excludes the first 1/4 division or 25 ns from the start of the magnified sweep and anything beyond the 100th magnified division.						

^a Performance Requirement not checked in manual.

Table 6-1 (cont)

CHARACTERISTICS	PERFORMANCE REQUIREMENTS
HORIZONTAL DEFLECTION SYSTEM (cont)	
Sweep Linearity (relative to center two displayed divisions)	$\pm 5\%$. Sweep Linearity applies over the center eight divisions. Excludes the first 1/4 division or 25 ns from the start of the magnified sweep and anything beyond the 100th magnified division.
POSITION Control Range Normal Displays	Able to move the start of the sweep to the right of the center vertical graticule; able to move a time mark corresponding to the end of the tenth division of an unmagnified sweep to the left of the center graticule.
X-Y Displays	At least ± 13 divisions. ^a
X10 Magnifier Registration (X10 to X1)	Expands the normal sweep by ten times around that portion of the sweep positioned at the center vertical graticule line. ^a 0.5 division or less shift.
Variable Control Range	Continuously variable between calibrated SEC/DIV settings. Extends both the A and B sweep time per division by at least a factor of 2.5.
Sweep Length	Greater than 10 divisions.
Delay Time Delay Control Range	Less than 0.1 division to 10 times the A SEC/DIV switch setting. Maximum value does not exceed end of the A Sweep.
Jitter	1 part in 20,000, or less, peak-to-peak, during a two-second time interval.
Delta Time Delta Control Range	0 to greater than 9.9 divisions to the right of setting of DELAY control, but maximum value does not exceed end of the A Sweep.

^a Performance Requirement not checked in manual.

Table 6-1 (cont)

CHARACTERISTICS	PERFORMANCE REQUIREMENTS
A AND B TRIGGER	
Sensitivity—CH 1 through CH 4: AUTO LEVEL, NORM AND SINGLE SEQUENCE	Trigger sensitivity is defined as the minimum peak-to-peak sine-wave trigger signal amplitude required to show the test signal with horizontal jitter of less than 3.0% of one period (p-p viewed over two seconds), with Trigger LEVEL control set at mid-level, but not at control extremes.
COUPLING	
DC	0.35 division from dc to 25 MHz, increasing to 1.0 division at 150 MHz (100 MHz in AUTO LEVEL).
NOISE REJECT	1.4 division from dc to 25 MHz; increasing to 2.2 division at 100 MHz. 0.5 division or less will not trigger.
HF REJECT	0.35 division from dc to 50 kHz; attenuates signals above upper -3 dB cutoff frequency of 70 kHz.
LF REJECT	0.35 division from 100 kHz to 25 MHz, increasing to 1.0 division at 150 MHz (100 MHz in AUTO LEVEL); attenuates signals below the lower -3 dB cutoff frequency of 50 kHz.
AC	0.35 division from 50 Hz to 25 MHz, increasing to 1.0 division at 150 MHz; (100 MHz in AUTO LEVEL); attenuates signals below the lower -3 dB cutoff frequency of 20 Hz.
TV LINE, TV FIELD	0.5 division of composite sync will achieve a stable display.
Free Run Enable Frequency	
AUTO and AUTO LEVEL	The sweep will free run if trigger source frequency is less than 10 Hz. In AUTO LEVEL, if the trigger source frequency is ≤ 25 Hz, the range of the Trigger LEVEL control may be reduced.

Table 6-1 (cont)

CHARACTERISTICS	PERFORMANCE REQUIREMENTS
LEVEL Control Range	<p>± 10 divisions referred to the appropriate vertical input.</p> <p>This range is sufficient to allow triggering at any point on a displayed waveform for all modes except "ADD". In ADD, the combined range of the two position controls exceeds the trigger level range, making it possible (though unlikely) to pull a signal on screen for display but fail to trigger on it due to insufficient trigger level range.</p>
TRIGGER LEVEL READOUT Accuracy	$\pm (0.3\% \text{ of reading} + 10\% \text{ of one vertical division})$.
HOLDOFF Control Range	Increases A Sweep holdoff time by at least a factor of 10.

FUNCTIONS WITH DIGITAL READOUT

	<p>Specifications for functions with digital readout are valid only when the ambient temperature is within $\pm 10^\circ \text{C}$ of the temperature at the time of the last SELF CAL. For maximum performance, a recent SELF CAL is recommended.</p>
CURSOR FUNCTIONS	
<p>TIME (manually positioned cursors)</p> <p>Accuracy</p>	$\pm (0.5\% \text{ of reading} + 2\% \text{ of the SEC/DIV setting})$.
<p>1/TIME (manually positioned cursors)</p> <p>Accuracy</p>	Readout calculated from TIME cursor positions.
<p>CURSOR VOLTS (manually positioned cursors)</p> <p>Accuracy</p>	$\pm (1.0\% \text{ of reading} + 2\% \text{ of one vertical division} + \text{high-frequency display errors})$.

Table 6-1 (cont)

CHARACTERISTICS	PERFORMANCE REQUIREMENTS
Delay Accuracy, A Sweep Trigger Point to Start of B Sweep	$\pm(0.5\%$ of reading + 5% of one division of the A Sweep + 25 ns).
X-Y OPERATION	
Deflection Factors	Same as Vertical deflection system with the VOLTS/DIV variable controls in calibrated detent position. ^a
Accuracy	
Y Axis	
15°C to 35°C	Within $\pm 2\%$.
-10°C to 15°C and 35°C to 55°C	Within $\pm 3\%$. ^a
X Axis	
15°C to 35°C	Within $\pm 3\%$.
-10°C to 15°C and 35°C to 55°C	Within $\pm 4\%$. ^a
Horizontal (X-Axis) -3dB Bandwidth	3 MHz or more.
Phase Match (DC Coupled)	± 3 degrees from dc to 50 kHz.
EXTERNAL Z-AXIS INPUT	
Active Region Lower Threshold (intensity decreases above this voltage)	+1.8 volts or less.
Signal Required to Modulate an A or B Trace	+3.8 volts or less provides noticeable modulation of a normal intensity trace. Usable frequency range is dc to 10 MHz. External Z-Axis signal does not affect the readout or the intensified zone intensity.
Maximum Input Voltage 	30 V (dc + peak ac); 30 V p-p ac at 1 kHz or less. ^a
Input Loading	Represents less than one LSTTL load. ^a

^a Performance Requirement not checked in manual.

Table 6-1 (cont)

CHARACTERISTICS	PERFORMANCE REQUIREMENTS
PROBE ADJUST OUTPUT	
Overshoot (rising and falling edge)	0.1% or less.
Output Voltage on PROBE ADJUST Jack	0.5 V \pm 2% into 1 M Ω load.
Repetition Rate	1 kHz \pm 25%.
FRONT PANEL SETUP MEMORY	
Battery Life	5 years. ^a
Battery Type	3.0 V, 1200 mAH, Type BR-2/3AE2P, Lithium. ^a <i>WARNING—To avoid personal injury, have battery replaced only by a qualified service person who understands proper handling and disposal procedures for Lithium batteries.</i>
POWER SOURCE	
Line Voltage Range	90 Vac to 250 Vac. ^a
Line Frequency	48 Hz to 445 Hz. ^a
Line Fuse	2 A, 250 V, slow blow. ^a
Maximum Power Consumption	100 Watts (155 VA). ^a

^a Performance Requirement not checked in manual.

Table 6-1 (cont)

CHARACTERISTICS	PERFORMANCE REQUIREMENTS
CRT DISPLAY	
Display Area	8 by 10 cm. ^a
Geometry	
Vertical	± 1/2 minor (0.1 div) at 8 by 8 cm centered area.
Horizontal	± 1/2 minor (0.1 div) at 8 by 10 cm centered area.
Trace Rotation Range	Adequate to align trace with center horizontal graticule line.
Standard Phosphor	P31. ^a
Y-Axis Orthogonality	0.1 division or less, over eight vertical divisions. No adjustment.
Nominal Accelerating Voltage	16 kV. ^a
OPTION 15	
CH 2 Signal Out	
Dynamic Range	± 7 divisions.
Deflection Factor	10 mV/div into 50 Ω ±10%. 20 mV/div into 1 M Ω ±10%.
3dB Bandwidth	DC to 25 MHz.
DC Offset (Adjusted)	< 0.5 div (measured at 2 mV/DIV).
A GATE Out	
Output Voltage	3.5 V to 5.25 V positive-going pulse starting at 0 V to 0.7 V.
Output Drive	Will supply 4 mA during HI state, will sink 20 mA during LO state (not tested in Performance Check).

^a Performance Requirement not checked in manual.

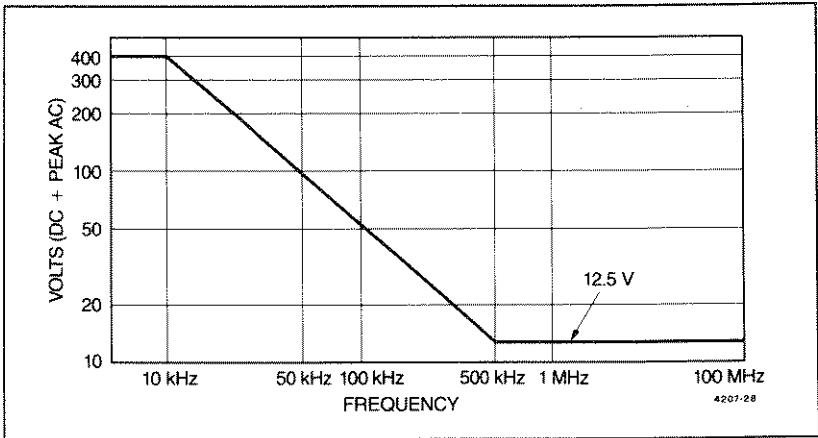

Figure 6-1. Maximum input voltage vs frequency derating curve for the CH 1, CH 2, CH 3, CH 4 input connectors.

Table 6-2
Environmental Characteristics

CHARACTERISTICS	DESCRIPTION
STANDARD INSTRUMENT	
Environmental Requirements	Instrument meets or exceeds the environmental requirements of MIL-T-28800D for Type III, Class 3, Style D equipment. ^a
Temperature	
Operating	-10° C to +55° C (+14° F to +131° F).
Non-operating	-51° C to +71° C (-60° F to +160° F). Tested to MIL-T-28800D paragraphs 4.5.5.1.3 and 4.5.5.1.4, except in 4.5.5.1.3, steps 4 and 5 (-10° C operating test) are performed ahead of step 2 (-51° C non-operating test). Equipment shall remain off upon return to room ambient during step 6. Excessive condensation shall be removed before operating during step 7.
Altitude	
Operating	To 4,570 m (15,000 ft). Maximum operating temperature decreases 1° C per 1000 ft above 5000 ft.
Non-Operating	To 15,240 m (50,000 ft).
Humidity (Operating and Non-operating)	Five cycles (120 hours) referenced to MIL-T-28800D paragraph 4.5.5.1.2.2, for type III, class 3 instruments. Non-operating and operating at 95%, -0% to +2% relative humidity. Operating at +30° C and +55° C for all modes of operation. Non-operating at +30° C to +60° C.
Radiated and conducted Emission required per VDE 0871	Meets Category B.

^a Performance not checked in manual.

Table 6-2 (cont)
Environmental Characteristics

CHARACTERISTICS	DESCRIPTION
Electrostatic Discharge	Withstands discharge of up to 20kV. Test performed with probe containing a 500 pF capacitor with 1 kΩ resistance charged to the test voltage. Conforms to Tektronix Standard 062-2862-00.
Vibration (operating)	15 minutes along each of 3 major axes at a total displacement of 0.25 inch p-p (4 g at 55 Hz) with frequency varied from 10 Hz to 55 Hz in 1-minute sweeps. Hold from 10 minutes at 55 Hz in each of the three major axes. All major resonances must be above 55 Hz.
Bench Handling Test (cabinet on and cabinet off)	MIL-STD-810D, Method 516.3, Procedure VI (MIL-T-28800D, Paragraph 4.5.5.4.3).
Transportation	
Packaged Vibration Test	Meets the limits of the National Safe Transit Association test procedure 1A-B-1; excursion of 1 inch p-p at 4.63 Hz (1.1 g) for 30 minutes on the bottom and 30 minutes on the side (for a total of 60 minutes).
Package Drop Test	Meets the limits of the National Safe Transit Association test procedure 1A-B-2; 10 drops of 36 inches.

Table 6-3
Mechanical Characteristics

CHARACTERISTICS	DESCRIPTION
STANDARD INSTRUMENT	
Weight	
With Front Cover, Accessories, and Accessories Pouch (without manual)	8.9 kg (19.5 lb).
With Power Cord	7.9 kg (17.3 lb).
Shipping Weight (Domestic)	11.7 kg (25.8 lb).
Overall Dimensions	See Figure 6-2, dimensional outline drawing.
Height	
With Feet and Accessories Pouch (empty)	Approx. 176.5 mm (6.95 in).
Without Accessories Pouch	163.6 mm (6.44 in).
Width (with handle)	360.4 mm (14.19 in).
Depth	
With Front Cover on	445.3 mm (17.53 in).
With Handle Extended	518.9 mm (20.43 in).
Cooling	Forced air circulation; no air filter.
Finish	Tek Blue, pebble-grain finish painted on aluminum cabinet.
Construction	Aluminum alloy chassis. Plastic-laminate front panel.

Table 6-3 (cont)
Mechanical Characteristics

CHARACTERISTICS	DESCRIPTION
RACKMOUNT INSTRUMENT	
Weight	
With Power Cord	10.0 kg (22.0 lb).
Shipping Weight	
Domestic, includes manual	14.2 kg (31.3 lb).
Overall Dimensions	See Figure 6-3, Dimensional drawing
Height	
Overall	168 mm (6.6 in).
Center of mounting rail to bottom of cabinet	89 mm (3.5 in).
From cabinet top or bottom to respective front-panel mounting holes	38 mm (1.5 in).
Between front-panel mounting holes	102 mm (4.0 in).
Width	
Overall	483 mm (19.0 in).
Between mounting hole centers	464 mm (18.3 in).
Between outer edges of mounting rails	427 mm (16.8 in).
Between handle centers	450 mm (17.7 in).

Table 6-3 (cont)
Mechanical Characteristics

CHARACTERISTICS	DESCRIPTION
Depth	
Overall	516 mm (20.35 in).
Front panel to rear of mounting rail (inside)	465 mm (18.3 in).
Front panel to rear of mounting rail (outside)	472 mm (18.6 in).
Handles	44 mm (1.75 in).
Required Clearance dimensions	
Height	≥ 178 mm (7 in).
Width	≥ 448 mm (17-5/8 in).
Depth	≥ 508 mm (20 in).
Cooling	Forced air circulation; no air filter.
Finish	Tek Blue, pebble-grain finish painted on aluminum cabinet.
Construction	Aluminum alloy chassis, front-panel frame, and rear support. Plastic-laminate front panel. Glass-laminate circuit boards.

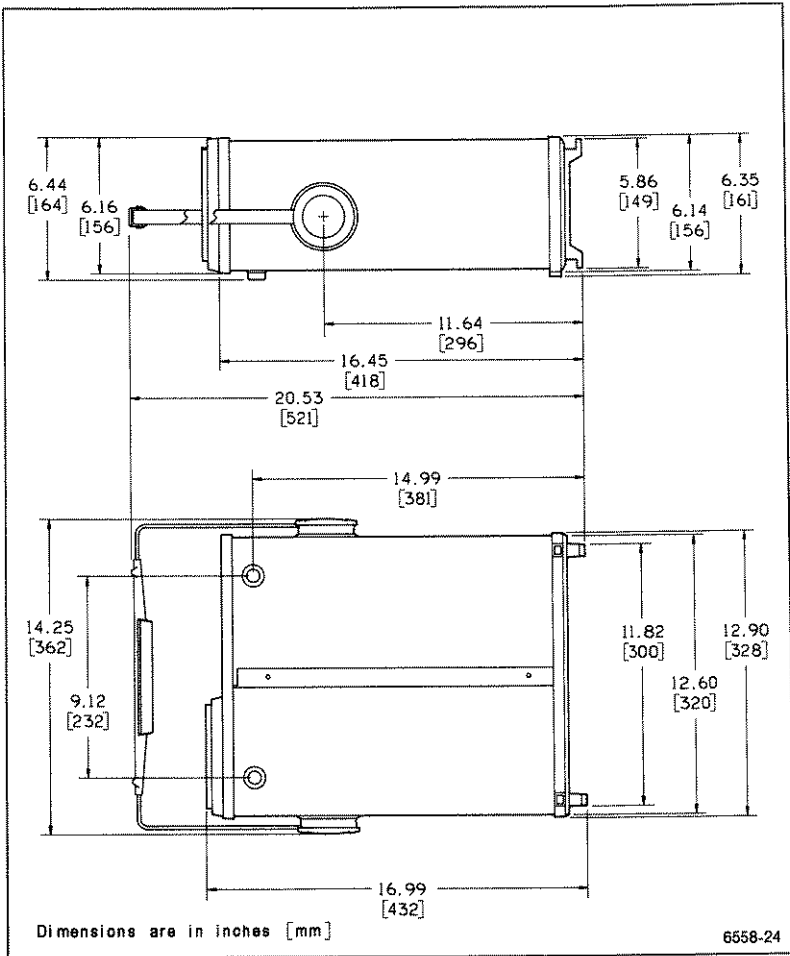

Figure 6-2. Dimensional drawing, standard cabinet.

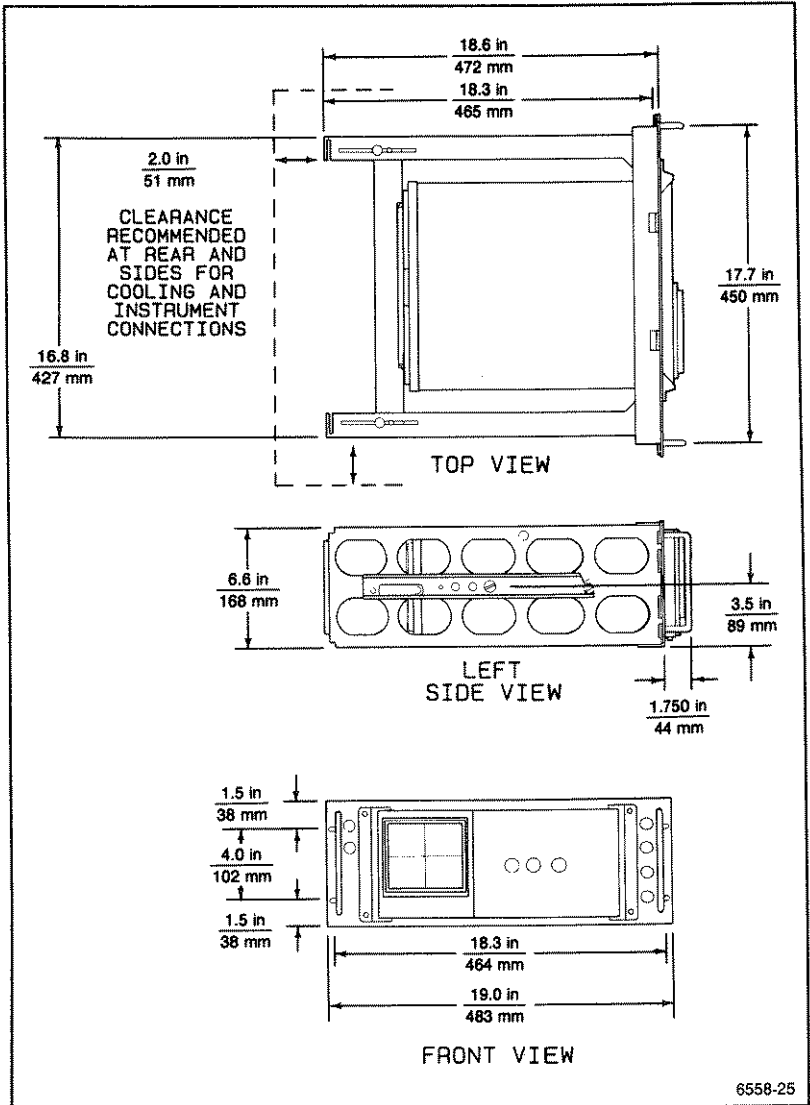

Figure 6-3. Dimensional drawing, rackmount cabinet (2240F1R).

Certificate of the Manufacturer/Importer

We hereby certify that the _____

2245A OSCILLOSCOPE AND ALL INSTALLED OPTIONS

complies with the RF Interference Suppression requirements of
Amtsbl.-Vfg 1046/1984.

The German Postal Service was notified that the equipment is being
marketed.

The German Postal Service has the right to re-test the series and to
verify that it complies.

TEKTRONIX

Bescheinigung des Herstellers/Importeurs

Hiermit wird bescheinigt, daß der/die/das _____

2245A OSCILLOSCOPE AND ALL INSTALLED OPTIONS

in Übereinstimmung mit den Bestimmungen der Amtsblatt-Verfügung
1046/1984 funktentstört ist.

Der Deutschen Bundespost wurde das Inverkehrbringen dieses Gerätes
angezeigt und die Berechtigung zur Überprüfung der Serie auf Einhalten
der Bestimmungen eingeräumt.

TEKTRONIX

NOTICE to the user/operator:

The German Postal Service requires that Systems assembled by the operator/user of this instrument must also comply with Postal Regulation, Vfg. 1046/1984, Par. 2, Sect. 1.

HINWEIS für den Benutzer/Betreiber:

Die vom Betreiber zusammengestellte Anlage, innerhalb derer dies Gerät eingesetzt wird, muß ebenfalls den Voraussetzungen nach Par. 2, Ziff. 1 der Vfg. 1046/1984 genügen.

NOTICE to the user/operator:

The German Postal Service requires that this equipment, when used in a test setup, may only be operated if the requirements of Postal Regulation, Vfg. 1046/1984, Par. 2, Sect. 1.7.1 are complied with.

HINWEIS für den Benutzer/Betreiber:

Dies Gerät darf in Meßaufbauten nur betrieben werden, wenn die Voraussetzungen des Par. 2, Ziff. 1.7.1 der Vfg. 1046/1984 eingehalten werden.

TABLE OF CONTENTS

	Page
LIST OF ILLUSTRATIONS	vi
LIST OF TABLES	vii
OPERATORS SAFETY SUMMARY	viii
SECTION 1—INTRODUCTION	
PRODUCT OVERVIEW	1-1
Description	1-1
Standard Accessories	1-3
PREPARATION FOR USE	1-4
Safety	1-4
Line Fuse	1-4
Line Voltage and Power Cord	1-4
Instrument Cooling	1-6
Start-Up	1-6
Repackaging for Shipment	1-8
SECTION 2—CONTROLS, CONNECTORS, AND INDICATORS	
Crt, Power, and Display	2-1
Vertical	2-3
Horizontal	2-7
Trigger	2-11
A Trigger Modes	2-13
B Trigger Modes	2-14
Rear Panel	2-17
Measurements and Auto Setup Controls	2-18

SECTION 3—OPERATORS FAMILIARIZATION

BASIC OPERATION	3-1
Readout Display	3-1
Graticule	3-1
Connecting Input Signals	3-3
Grounding	3-3
Probes	3-4
Coaxial Cables	3-4
External Triggering	3-4
Auto Setup	3-5
MIN SETUP	3-5
MEASUREMENT SYSTEM	3-5
Cursor Volts Measurements	3-5
Time Measurements	3-6
Behavior for Horizontal Mode Changes	3-7
Measurement Compatibility and Error Messages	3-8
Measurements in Single Sequence Mode	3-8
Service Menu Features	3-9
Configure Menu	3-10
Self Cal Measurements	3-11
Internal Settings Menu	3-12

SECTION 4—OPERATOR CHECKS AND ADJUSTMENTS

Introduction	4-1
Initial Setup	4-1
Auto Setup Function	4-2
Trace Rotation Adjustment	4-3
Probe Low-Frequency Compensation	4-3
Vertical Deflection Check	4-5
Timing Checks	4-6

SECTION 5—BASIC APPLICATIONS

Introduction	5-1
Voltage Measurement Cursors	5-1
Voltage Difference	5-1

Time Measurement Cursors	5-3
Time Difference	5-3
Period Measurement	5-4
Frequency Measurement	5-5
Rise-Time Measurements	5-6
Phase Measurements	5-8
Time Delay Measurement	5-11
Add Mode	5-14

SECTION 6—PERFORMANCE CHARACTERISTICS

Introduction	6-1
Recommended Calibration Schedule	6-1

SECTION 7—PERFORMANCE CHECK PROCEDURE

INTRODUCTION	7-1
Test Equipment Required	7-1
Performance Check Interval	7-1
Preparation	7-1
INDEX TO PERFORMANCE CHECK PROCEDURE	7-6
DISPLAY	7-8
TRACE ROTATION	7-8
Geometry	7-9
VERTICAL	7-10
Input COUPLING Functional Check	7-10
CH 1 and CH 2 VOLTS/DIV Trace Shift	7-11
CH 3 and CH 4 VOLTS/DIV Trace Shift	7-12
CH 1 and CH 2 VAR VOLTS/DIV Trace Shift	7-12
CH 1 and CH 2 Input COUPLING Trace Shift	7-13
CH 2 INVERT Trace Shift	7-13
CH 1 and CH 2 VAR VOLTS/DIV Range	7-13
Low-Frequency Linearity	7-14
CH 1 and CH 2 Vertical Deflection Accuracy	7-15
CH 3 and CH 4 Vertical Deflection Accuracy	7-16
ADD Mode and CH 2 INVERT Deflection Accuracy	7-17
Vertical POSITION Range (all channels)	7-18
CH 1 to CH 2 Signal Delay Match	7-19
CH 1 to CH 4 Signal Delay Match	7-19
CH 3 to CH 4 Signal Delay Match	7-20
Ch 1 and CH 2 Vertical Bandwidth	7-21
CH 3 and CH 4 Vertical Bandwidth	7-22

SCOPE BW (Bandwidth Limit) Accuracy	7-22
Common-Mode Rejection Ratio	7-23
Channel Isolation	7-24
AC-Coupled Lower -3 dB Point	7-25
Vertical ALT and CHOP Modes	7-26
BEAM FIND Functional Check	7-26
A and B Trace Separation	7-27
TRIGGERING	7-28
500 Hz Trigger Sensitivity	7-27
500 kHz Trigger Sensitivity	7-28
25 MHz Trigger Sensitivity	7-30
150 MHz Trigger Sensitivity	7-31
Single Sweep Mode	7-32
Trigger LEVEL Control Range	7-33
TV Field Trigger Sensitivity	7-34
TV Line Trigger Sensitivity	7-34
Line Trigger Functional Check	7-35
HORIZONTAL	7-36
A and B Sweep Length	7-36
Horizontal POSITION Range	7-37
VAR SEC/DIV Range	7-38
Magnifier Registration	7-38
A and B Timing Accuracy and Linearity	7-38
A and B Magnified Timing Accuracy and Linearity	7-41
Delay Time Jitter	7-42
Delay Time Accuracy	7-43
Delay Time Position Range	7-44
X-Axis Gain Accuracy	7-44
X-Y Phase Difference	7-45
X-Axis Bandwidth	7-45
MEASUREMENT CURSORS	7-46
← SEC → and ← 1/SEC → Cursor Accuracy	7-46
← VOLTS → Cursor Accuracy	7-47
EXTERNAL Z-AXIS, PROBE ADJUST, AND AUTO SETUP FUNCTIONS	7-48
Check External Z-Axis Input	7-48
PROBE ADJUST Output	7-49
AUTO SETUP Functional Check	7-49
OPTION 15	7-50
Signal Output	7-50
A GATE Output	7-51

SECTION 8—OPTIONS AND ACCESSORIES

Introduction	8-1
Options A1–A5 International Power Cords	8-1
OPTION 15	8-1
Standard Accessories	8-1
Optional Accessories	8-2
Instrument Enhancements	8-2
Transportation Aids	8-2
Cameras	8-2
Probes	8-3
Viewing Hoods	8-3

APPENDIX A – AUTO-SETUP/MIN SETUP Control Settings

APPENDIX B – FACTORY SETTINGS

CHANGE INFORMATION

LIST OF ILLUSTRATIONS

Figure	Page
1-1	The 2245A Oscilloscope 1-1
1-2	Optional power cords 1-5
2-1	CRT, power, and display controls 2-2
2-2	CH 1 and CH 2 vertical controls and connectors 2-4
2-3	Vertical connectors and CH 3 and CH 4 controls and indicators 2-6
2-4	Horizontal controls and indicators 2-8
2-5	Trigger controls and indicators 2-12
2-6	Rear panel connectors and fuse 2-18
2-7	Measurement controls 2-19
3-1	Readout display locations 3-2
3-2	Graticule measurement markings 3-3
3-3	Service Menu 3-9
3-4	Configure Menu 3-11
3-5	Internal Settings Menu 3-12
4-1	Probe compensation 4-5
5-1	Voltage difference measurement using cursors 5-2
5-2	Pulse period measurement 5-5
5-3	Frequency measurement 5-6
5-4	Rise time measurement 5-8
5-5	Phase difference measurement 5-10
5-6	Time difference between two delays 5-13
5-7	Eliminating common-mode signals 5-16
6-1	Maximum input voltage vs frequency derating curve for the CH 1, CH 2, CH 3, CH 4 input connectors 6-12
6-2	Dimensional drawing, standard cabinet 6-18
6-3	Dimensional drawing, rackmount cabinet (2240F1R) 6-19

LIST OF TABLES

Table		Page
2-1	VERT Trigger SOURCE	2-16
3-1	Behavior for Horizontal MODE Changes	3-7
6-1	Electrical Characteristics	6-2
6-2	Environmental Characteristics	6-13
6-3	Mechanical Characteristics	6-15
7-1	Test Equipment Required	7-3
7-2	Signal-to-Graticule Accuracy	7-16
7-3	Settings for Timing Accuracy Checks	7-40
7-4	Delay Time Accuracy	7-43
A-1	AUTO-SETUP Control Settings	A-1
A-2	MIN SETUP Control Settings	A-4
B-1	Factory Settings	B-1

OPERATORS SAFETY SUMMARY

The safety information in this summary is for operating personnel. Warnings and cautions will also be found throughout the manual where they apply.

Terms in this Manual

CAUTION statements identify conditions or practices that could result in damage to the equipment or other property.

WARNING statements identify conditions or practices that could result in personal injury or loss of life.

Terms as Marked on Equipment

CAUTION indicates a personal injury hazard not immediately accessible as one reads the markings, or a hazard to property, including the equipment itself.

DANGER indicates a personal injury hazard immediately accessible as one reads the marking.

Symbols in this Manual



This symbol indicates where applicable cautionary or other information is to be found. For maximum input voltage see Table 6-1.

Symbols as Marked on Equipment



DANGER—High voltage.



Protective ground (earth) terminal.



ATTENTION—Refer to manual.

SECTION 7

**PERFORMANCE
CHECK
PROCEDURE**

INTRODUCTION

This Performance Check Procedure verifies the Performance Requirements of the 2245A as listed in the Performance Characteristics (Section 6) and helps determine the need for readjustment. These checks may also be used as an acceptance test or as a preliminary troubleshooting aid.

You do not have to remove the wrap-around cabinet from the 2245A to do this procedure. All checks can be made with controls and connectors accessible from the outside.

Test Equipment Required

Table 7-1 lists all the test equipment required to do the Performance Check Procedure. Test equipment specifications described are the minimum necessary to provide accurate results. For test equipment operating information, refer to the appropriate test equipment instruction manual.

When you use equipment other than that recommended, you may have to make some changes to the test setups. If the exact example equipment in Table 7-1 is not available, use the Minimum Specification column to determine if any other available test equipment might be adequate to do the check.

Performance Check Interval

To ensure instrument accuracy, check the performance of the 2245A after every 2000 hours of operation, or once each year if used infrequently. If the checks indicate a need for readjustment or repair, refer the instrument to a qualified service person.

Preparation

This procedure is divided into subsections to let you check individual sections of the instrument when it is not necessary to do the complete Performance Check. An Equipment Required block at the beginning of each subsection lists the equipment from Table 7-1 that is needed to do the checks in that subsection.

The initial front-panel control settings at the beginning of each subsection prepare the instrument for the first step of the subsection. Do each of the steps in a subsection completely and in order to ensure the correct control settings for steps that follow. To ensure performance accuracies stated in the Performance Characteristics (Section 6), let the instrument warm up for 20 minutes and run the SELF CAL MEASUREMENTS routine.

To run the SELF CAL MEASUREMENTS routine:

Press the CH 1 and CHOP/ALT VERTICAL MODE buttons at the same time to display the SERVICE MENU. Underline and select SELF CAL MEASUREMENTS by pressing the ADD button. Press RUN (CH 2 button) to start the routine, then QUIT (CH 4 button) to return to the normal oscilloscope mode.

NOTE

Performance accuracies are ensured only when the SELF CAL MEASUREMENTS is done AFTER the 20-minute warmup.

Table 7-1
Test Equipment Required

Item and Description	Minimum Specification	Use	Example of Test Equipment
Leveled Sine-Wave Generator	Frequency: 250 kHz to above 150 MHz. Output amplitude: variable from 10 mV to 5 V p-p. Output impedance: 50 Ω . Amplitude accuracy: constant within 1.5% of reference frequency to 100 MHz.	Vertical, horizontal, triggering, measurement bandwidth, and Z-Axis checks and adjustments.	TEKTRONIX SG 503 Leveled Sine-Wave Generator. ^a
Calibration Generator	Standard-amplitude signal levels (Dc and Square wave): 5 mV to 50 V. Accuracy: $\pm 0.25\%$. High-amplitude signal levels: 1 V to 60 V. Repetition rate: 1 kHz. Fast-rise signal level: 1 V. Repetition rate: 1 MHz. Rise time: 1 ns or less. Flatness: $\pm 0.5\%$.	Signal source for gain and transient response checks and adjustments	TEKTRONIX PG 506 Calibration Generator. ^a
Time-Mark Generator	Marker outputs: 5 ns to 0.5 s. Marker accuracy: $\pm 0.1\%$. Trigger output: 1 ms to 0.1 μ s, time-coincident with markers.	Horizontal checks and adjustments. Display adjustment. Time cursor checks.	TEKTRONIX TG 501 Time-Mark Generator. ^a
Function Generator	Range: less than 1 Hz to 1 kHz; sinusoidal output; amplitude variable up to greater than 10 V p-p open circuit with dc offset adjust.	Low-frequency checks.	TEKTRONIX FG 502 Function Generator. ^a

^a Requires a TM500-series power module.

Table 7-1 (cont)

Item and Description	Minimum Specification	Use	Example of Test Equipment
Coaxial Cable (2 required)	Impedance: 50 Ω Length: 42 in. Connectors: BNC	Signal inter-connection.	Tektronix Part Number 012-0057-01.
Precision Coaxial Cable	Impedance: 50 Ω Length: 36 in. Connectors: BNC	Used with PG 506 Calibration Generator and SG 503 Sine-Wave Generator.	Tektronix Part Number 012-0482-00.
Termination (2 required)	Impedance: 50 Ω Connectors: BNC	Signal termination.	Tektronix Part Number 011-0049-01.
10X Attenuator	Ratio: 10X. Impedance: 50 Ω Connectors: BNC	Triggering checks.	Tektronix Part Number 011-0059-02.
2X Attenuator	Ratio: 2X. Impedance: 50 Ω Connectors: BNC	Triggering checks.	Tektronix Part Number 011-0069-02.
Adapter	Connectors: BNC male-to-miniature-probe tip.	Signal inter-connection.	Tektronix Part Number 013-0084-02.
Alignment Tool	Length: 1-in shaft. Bit size: 3/32 in. Low capacitance; insulated.	Adjust TRACE ROTATION pot. Adjust variable capacitors and resistors.	Tektronix Part Number 003-0675-00.
Test Oscilloscope	Bandwidth: 20 MHz.	Z-Axis Response adjustment.	TEKTRONIX 2246A.
Dual-Input Coupler	Connectors: BNC female-to-dual-BNC male.	Signal inter-connection.	Tektronix Part Number 067-0525-02
T-Connector	Connectors, BNC.	Signal inter-connection.	Tektronix Part Number 103-0030-00.
Precision Normalizer	Input Resistance: 1 M Ω ; Input Capacitance: 22 pF.	Input Capacitance adjustments.	Tektronix Part Number 067-0538-00.

Table 7-1 (cont)

Item and Description	Minimum Specification	Use	Example of Test Equipment
TV Signal Generator	Provide Composite TV Video and Line Sync Signals.	Check TV Trigger circuit.	TEKTRONIX TSG-100 Test Signal Generator.
Digital Multimeter (DMM)	Dc Volts Range: 0 to 140 V. Dc Voltage accuracy: $\pm 0.15\%$. 4 1/2 digit display.	Power supply voltage checks and adjustments.	TEKTRONIX DM501A Digital Multimeter. ^a

^a Requires a TM500-series power module.

INDEX TO PERFORMANCE CHECK PROCEDURE

DISPLAY

- 1. TRACE ROTATION 7-8
- 2. Geometry 7-9

VERTICAL

- 1. Input COUPLING Functional Check 7-10
- 2. CH 1 and CH 2 VOLTS/DIV Trace Shift 7-11
- 3. CH 3 and CH 4 VOLTS/DIV Trace Shift 7-12
- 4. CH 1 and CH 2 VAR VOLTS/DIV Trace Shift 7-12
- 5. CH 1 and CH 2 Input COUPLING Trace Shift 7-13
- 6. CH 2 INVERT Trace Shift 7-13
- 7. CH 1 and CH 2 VAR VOLTS/DIV Range 7-13
- 8. Low Frequency Linearity 7-14
- 9. CH 1 and CH 2 Vertical Deflection Accuracy 7-15
- 10. CH 3 and CH 4 Vertical Deflection Accuracy 7-16
- 11. ADD Mode and CH 2 INVERT Deflection Accuracy 7-17
- 12. Vertical POSITION Range (all channels) 7-18
- 13. CH 1 to CH 2 Signal Delay Match 7-19
- 14. CH 1 to CH 4 Signal Delay Match 7-20
- 15. CH 3 to CH 4 Signal Delay Match 7-20
- 16. CH 1 and CH 2 Vertical Bandwidth 7-21
- 17. CH 3 and CH 4 Vertical Bandwidth 7-22
- 18. SCOPE BW (Bandwidth Limit) Accuracy 7-22
- 19. Common-Mode Rejection Ratio 7-23
- 20. Channel Isolation 7-24
- 21. AC-Coupled Lower -3 dB Point 7-25
- 22. Vertical ALT and CHOP Mode 7-26
- 23. BEAM FIND Functional Check 7-26
- 24. A and B Trace Separation 7-27

TRIGGERING

- 1. 500 Hz Trigger Sensitivity 7-28
- 2. 500 kHz Trigger Sensitivity 7-29
- 3. 25 MHz Trigger Sensitivity 7-30
- 4. 150 MHz Trigger Sensitivity 7-31
- 5. Single Sweep Mode 7-32
- 6. Trigger LEVEL Control Range 7-33
- 7. TV Field Trigger Sensitivity 7-34
- 8. TV Line Trigger Sensitivity 7-34
- 9. Line Trigger Functional Check 7-35

HORIZONTAL

1. A and B Sweep Length 7-36
2. Horizontal POSITION Range 7-37
3. VAR SEC/DIV Range 7-38
4. Magnifier Registration 7-38
5. A and B Timing Accuracy and Linearity 7-38
6. A and B Magnified Timing Accuracy and Linearity 7-41
7. Delay Time Jitter 7-42
8. Delay Time Accuracy 7-43
9. Delay Time Position Range 7-44
10. X-Axis Gain Accuracy 7-44
11. X-Y Phase Difference 7-45
12. X-Axis Bandwidth 7-45

MEASUREMENT CURSORS

1. \leftarrow SEC \rightarrow and \leftarrow 1/SEC \rightarrow Cursor Accuracy 7-46
2. \leftarrow VOLTS \rightarrow Cursor Accuracy 7-47

EXTERNAL Z-AXIS, PROBE ADJUST, AND AUTO SETUP FUNCTIONS

1. Check External Z-Axis Input 7-48
2. PROBE ADJUST Output 7-49
3. AUTO SETUP Functional Check 7-49

OPTION 15

1. Signal Output 7-50
2. A GATE Output 7-51

DISPLAY

Equipment Required (See Table 7-1)

Time mark generator	50 Ω BNC coaxial cable
50 Ω BNC termination	

1. TRACE ROTATION

a. Set:

READOUT (Intensity)	For a viewable readout
A INTEN	For a viewable trace
VERTICAL MODE	CH 1
CH 1 VOLTS/DIV	0.1 V
CH 1 COUPLING	AC
SCOPE BW	Off
A/B SELECT	A Trigger
TRIGGER MODE	AUTO LEVEL
TRIGGER SOURCE	VERT
TRIGGER CPLG	DC
TRIGGER SLOPE	 (positive-going)
TRIGGER HOLDOFF	Min
TRIGGER LEVEL	12 o'clock
Horizontal MODE	A
Horizontal POSITION	12 o'clock
A SEC/DIV	2 μ s
CLEAR MEAS'MT	Press to remove measurement cursors.
FOCUS	For best defined display

- b. Position trace vertically to the center graticule line.
- c. CHECK—trace rotation control range is adequate to align trace with center graticule line using a small straight-bladed alignment tool.
- d. ADJUST—trace parallel to center horizontal graticule line.

2. Geometry

- a. Connect time mark generator (TG 501) to CH 1 via a $50\ \Omega$ BNC coaxial cable and a $50\ \Omega$ BNC termination.
- b. Set generator for $0.2\ \mu\text{s}$ time marks.
- c. Position the bottom of the CH 1 signal below the bottom graticule line. It may be necessary to increase the A intensity in order to see the time markers.
- d. CHECK—deviation of any vertical line within the center eight horizontal divisions does not exceed 0.1 division (half a minor division).
- e. Set CH 1 COUPLING to GND.
- f. Position trace slowly from the bottom graticule line to the top graticule line while making the following check.
- g. CHECK—bowing or tilt of baseline trace doesn't exceed 0.1 division (half a minor division) within the eight vertical divisions.
- h. Disconnect test signal from the 2245A.

VERTICAL

Equipment Required (See Table 7-1)

Leveled sine-wave generator	50 Ω precision BNC coaxial cable
Calibration generator	50 Ω termination
Function generator	Dual-input coupler
50 Ω BNC coaxial cable	

1. Input COUPLING Functional Check

a. Set:

READOUT (Intensity)	For a viewable readout
A INTEN	For a viewable trace
VERTICAL MODE	CH 1 and CH 2
CH 1 and CH 2	
VOLTS/DIV	1 V
CH 1 and CH 2	
Input COUPLING	DC
SCOPE BW	Off
CH 2 INVERT	Off
A/B SELECT	A TRIGGER
TRIGGER MODE	AUTO LEVEL
TRIGGER SOURCE	VERT
TRIGGER CPLG	DC
TRIGGER SLOPE	 (positive-going)
TRIGGER LEVEL	12 o'clock
TRIGGER HOLDOFF	Min
Horizontal POSITION	12 o'clock
Horizontal MODE	A
SEC/DIV	0.5 ms
FOCUS	For best defined display
CLEAR MEAS'MT	Press to remove measurement cursors

b. Set Vertical MODE to CH 1 (CH 2 off).

c. Connect Function Generator (FG 502) sine-wave output to the CH 1 input via a 50 Ω BNC coaxial cable and a 50 Ω BNC termination.

- d. Set function generator output for 1 kHz sine-wave signal of five divisions peak-to-peak with maximum positive dc offset.
- e. Position the bottom of the signal to the center horizontal graticule line.
- f. Set CH 1 Input COUPLING to AC.
- g. CHECK—display is roughly centered about the center horizontal graticule line.
- h. Move the test signal to the CH 2 input.
- i. Set CH 2 VERTICAL MODE to on (CH 1 off).
- j. Repeat the procedure for CH 2.
- k. Disconnect the test signal from the 2245A.

2. CH 1 and CH 2 VOLTS/DIV Trace Shift

a. Set:

CH 1 and CH 2	
VERTICAL MODE	On
CH 1 and CH 2	
VOLTS/DIV	2 mV
CH 1 and CH 2	
Input COUPLING	GND

- b. Set VERTICAL MODE to CH 1 (CH 2 off).
- c. Position trace to center horizontal graticule line.
- d. Switch CH 1 VOLTS/DIV through all positions from 2 mV to 5 V.
- e. CHECK—trace shift does not exceed 0.2 division between steps.
- f. Set VERTICAL MODE to CH 2 (CH 1 off).
- g. Position CH 2 trace to the center horizontal graticule line.
- h. Switch CH 2 VOLTS/DIV through all positions from 2 mV to 5 V.
- i. CHECK—trace shift does not exceed 0.2 division between steps.

3. CH 3 and CH 4 VOLTS/DIV Trace Shift

- a. Set VERTICAL MODE to CH 3 (CH 2 off).
- b. Position trace to the center horizontal graticule line.
- c. Switch CH 3 VOLTS/DIV between 0.1 V and 0.5 V.
- d. CHECK—trace shift does not exceed one division.
- e. Set VERTICAL MODE to CH 4 (CH 3 off).
- f. Position trace to the center horizontal graticule line.
- g. Switch CH 4 VOLTS/DIV between 0.1 V and 0.5 V.
- h. CHECK—trace shift does not exceed one division.

4. CH 1 and CH 2 VAR VOLTS/DIV Trace Shift

- a. Set:

VERTICAL MODE	CH 1 (CH 4 off)
CH 1 VOLTS/DIV	2 mV

- b. Position trace to center graticule line.
- c. Set CH 1 VAR VOLTS/DIV fully CCW (counterclockwise).
- d. CHECK—trace shift does not exceed one division.

- e. Set:

CH 1 VAR VOLTS/DIV	Detent (calibrated)
VERTICAL MODE	CH 2 (CH 1 off)
CH 2 VOLTS/DIV	2 mV

- f. Position trace to center graticule line.
- g. Set CH 2 VAR VOLTS/DIV fully CCW.
- h. CHECK—trace shift does not exceed one division.
- i. Set CH 2 VAR VOLTS/DIV to detent (calibrated) position.

5. CH 1 and CH 2 Input COUPLING Trace Shift

- a. Position trace to center graticule line.
- b. Set CH 2 Input COUPLING to DC.
- c. CHECK—trace shift does not exceed 0.25 division.
- d. Set:

VERTICAL MODE	CH 1 (CH 2 off)
CH 1 Input COUPLING	GND

- e. Position trace to center graticule line.
- f. Set CH 1 Input COUPLING to DC.
- g. CHECK—trace shift does not exceed 0.25 division.

6. CH 2 INVERT Trace Shift

- a. Set:

VERTICAL MODE	CH 2 (CH 1 off)
CH 2 Input COUPLING	GND

- b. Position trace to center horizontal graticule line.
- c. Set CH 2 INVERT On.
- d. CHECK—trace shift does not exceed one division.

- e. Set:

CH 2 INVERT	Off
CH 2 Input COUPLING	DC

7. CH 1 and CH 2 VAR VOLTS/DIV Range

- a. Set VERTICAL MODE to CH 1 (CH 2 off).
- b. Position CH 1 and CH 2 traces to the center horizontal graticule line.

c. Set:

CH 1 VOLTS/DIV	10 mV
CH 1 VAR VOLTS/DIV	Fully CCW

d. Connect calibration generator (PG 506) Std Ampl output to the CH 1 input via a 50 Ω precision BNC coaxial cable. Set generator Std Ampl output to 50 mV.

e. CHECK—the signal amplitude is two divisions or less.

f. Set:

CH 1 VAR VOLTS/DIV	Detent (calibrated)
Vertical MODE	CH 2 (CH 1 off)
CH 2 VOLTS/DIV	10 mV

g. Position CH 2 trace to the center horizontal graticule line.

h. Move the test signal to the CH 2 input.

i. Set CH 2 VAR VOLTS/DIV fully CCW.

j. Repeat the CHECK procedure for CH 2.

k. Set CH 2 VAR VOLTS/DIV to detent (calibrated) position.

8. Low-Frequency Linearity

a. Set:

VERTICAL MODE	CH 1 (CH 2 off)
CH 1 VOLTS/DIV	10 mV
SCOPE BW	ON

b. Set calibration generator to Std Ampl output, 20 mV.

c. Move the test signal to the CH 1 input.

d. Position the top of the signal to top graticule line.

e. CHECK—the signal amplitude is between 1.9 and 2.1 divisions.

f. Set bottom of the signal to bottom graticule line.

- g. CHECK—the signal amplitude is between 1.9 and 2.1 divisions.
- h. Repeat the procedure for CH 2.

9. CH 1 and CH 2 Vertical Deflection Accuracy

- a. Set CH 2 VOLTS/DIV to 2 mV.
- b. Set calibration generator to Std Ampl output, 10 mV.
- c. Position the trace two graticule lines below the center horizontal graticule line.
- d. CHECK—all positions of the VOLTS/DIV settings for correct signal to graticule accuracy, using the settings in Table 7-2, Signal-to-Graticule Accuracy, for the checks.
- e. Set calibration generator to Std Ampl output, 10 mV.
- f. Move the test signal to the CH 1 input.
- g. Set:

VERTICAL MODE	CH 1 (CH 2 off)
CH 1 VOLTS/DIV	2 mV

- h. Same as c. above.
- i. Repeat CHECK procedure for CH 1.

- h. Same as b. above.
- i. Repeat CHECK for CH 4.
- j. Set CH 3 and CH 4 VOLTS/DIV to 0.5 V.
- k. Set calibration generator to Std Ampl output, 2 V.
- l. CHECK—the signal amplitude is between 3.92 and 4.08 divisions.
- m. Set:

VERTICAL MODE	CH 3 (CH 4 off)
CH 3 VOLTS/DIV	0.5 V

- n. Move the test signal to the CH 3 input.
- o. Repeat CHECK procedure for CH 3.
- p. Disconnect the test setup from the 2245A.

11. ADD Mode and CH 2 INVERT Deflection Accuracy

- a. Set:

VERTICAL MODE	ADD (all others off)
CH 1 and CH 2 VOLTS/DIV	0.1 V
CH 1 and CH 2 Input COUPLING	DC

- b. Connect calibration generator Std Ampl output to the CH 1 and CH 2 inputs via a 50 Ω precision BNC coaxial cable and a BNC dual-input coupler.
- c. Set the calibration generator to Std Ampl output, 0.2 V.
- d. Position the ADD signal to the center of the crt graticule with the CH 1 and CH 2 POSITION controls.
- e. CHECK—That the ADD signal amplitude is between 3.92 and 4.08 divisions.
- f. Set CH 2 INVERT On.
- g. CHECK—That the ADD signal amplitude is 0.08 division (less than half a minor graticule division) or less excluding trace width (sweep will free run).
- h. Disconnect the test setup from the 2245A.

12. Vertical POSITION Range (all channels)

a. Set:

A SEC/DIV	0.1 ms
VERTICAL MODE	CH 1 (ADD off)
CH 1 VOLTS/DIV	1 V
CH 2 INVERT	Off
SCOPE BW	Off
CH 1 and CH 2 Input COUPLING	AC

b. Connect leveled sine-wave generator (SG 503) output to the CH 1 and CH 2 inputs via a 50 Ω BNC coaxial cable, a 50 Ω BNC termination, and a BNC dual-input coupler.

c. Position trace to center horizontal graticule line.

d. Set leveled sine-wave generator output for two-division signal at 50 kHz.

e. Set:

CH 1 VOLTS/DIV	0.1 V
CH 1 POSITION	Fully CW (clockwise)

f. CHECK—that the bottom of the waveform is at least one division above the center horizontal graticule line.

g. Set CH 1 POSITION fully CCW.

h. CHECK—that the top of the waveform is at least one division below the center horizontal graticule line.

i. Set:

CH 1 POSITION	12 o'clock
VERTICAL MODE	CH 2 (CH 1 off)
CH 2 POSITION	Fully CW

j. CHECK—that the bottom of the waveform is at least one division above the center horizontal graticule line.

k. Set CH 2 POSITION fully CCW.

l. CHECK—that the top of the waveform is at least one division below the center horizontal graticule line.

- m. Set CH 2 POSITION to 12 o'clock.
- n. Move the BNC dual-input coupler from the CH 1 and CH 2 Inputs to the CH 3 and CH 4 inputs.
- o. Set:

VERTICAL MODE	CH 3 (CH 2 off)
CH 3 and CH 4	
VOLTS/DIV	0.1 V
CH 3 POSITION	Fully CW
- p. CHECK—that the bottom of the waveform is at least one division above the center graticule line.
- q. Set CH 3 POSITION fully CCW.
- r. CHECK—that the top of the waveform is at least one division below the center graticule line.
- s. Set:

CH 3 POSITION	12 o'clock
VERTICAL MODE	CH 4 (CH 3 off)
- t. Repeat the procedure for CH 4.
- u. Set CH 4 POSITION to 12 o'clock.
- v. Disconnect the test setup from the 2245A.

13. CH 1 to CH 2 Signal Delay Match

- a. Set:

VERTICAL MODE	CH 1 and CH 2 (CH 4 off)
CH 1 and CH 2	
Input COUPLING	DC
CH 1 and CH 2	
VOLTS/DIV	0.1 V
SEC/DIV	20 ns
TRIGGER SOURCE	CH 3
- b. Superimpose the CH 1 and CH 2 traces at the 100% graticule marking.

- c. Connect calibration generator (PG 506) fast rise, rising-edge signal to the CH 1 and CH 2 inputs via a 50 Ω precision BNC coaxial cable, a 50 Ω BNC termination, and a BNC dual-input coupler.
- d. Connect calibration generator trig out signal to the CH 3 input via a 50 Ω BNC coaxial cable and a 50 Ω BNC termination.
- e. Set the calibration generator to Fast Rise and adjust Pulse Amplitude for five divisions of signal amplitude at 1 MHz.
- f. Position the rising edges of the superimposed waveforms horizontally to the center vertical graticule line.

NOTE

It may be necessary to readjust the trigger level to display the rising-edge signal in the Delay Match steps. This can be done by pressing the upper Trigger MODE button to cause the trigger level to be automatically readjusted.

- g. Set X10 MAG On (for 2 ns/div sweep speed).
- h. CHECK—that the leading edges of the two waveforms have less than 0.1 horizontal division separation at the center graticule line excluding trace width.

14. CH 1 to CH 4 Signal Delay Match

- a. Set VERTICAL MODE to CH 1 and CH 4 (CH 2 off).
- b. Move the CH 2 signal to the CH 4 input connector.
- c. Superimpose the CH 4 waveform on the CH 1 waveform.
- d. CHECK—that the leading edges of the two waveforms have less than 0.1 horizontal division separation at the center graticule line excluding trace width.

15. CH 3 to CH 4 Signal Delay Match

- a. Set:

VERTICAL MODE	CH 3 and CH 4 (CH 1 off)
TRIGGER SOURCE	CH 2

- b. Move the CH 3 signal to the CH 2 input and the CH 1 trigger signal to the CH 3 input.

- c. Superimpose CH 3 and CH 4 waveforms at the center graticule line.
- d. CHECK—that the leading edges of the two waveforms have less than 0.1 horizontal division separation at the center graticule line.
- e. Disconnect the test setup.

16. CH 1 and CH 2 Vertical Bandwidth

- a. Set:

X10 MAG	Off
VERTICAL MODE	CH 1 (CH 3 and CH 4 off)
SEC/DIV	0.1 ms
CH 1 VOLTS/DIV	5 mV
CH 1 and CH 2 Input COUPLING	DC
TRIGGER SOURCE	VERT
Horizontal POSITION	12 o'clock

- b. Connect leveled sine-wave generator (SG 503) output to the CH 1 input via a 50 Ω precision BNC coaxial cable and a 50 Ω BNC termination.
- c. Set the leveled sine-wave Generator output for a six-division signal amplitude at 50 kHz.
- d. Set the generator Frequency Range and Frequency Variable controls for a 90 MHz output signal.
- e. CHECK—the displayed signal amplitude is 4.2 divisions or more as the frequency is increased to 100 MHz.
- f. Repeat the frequency setup and CHECK procedure for VOLTS/DIV settings of 50 mV through 0.5 V.
- g. Move the test signal to the CH 2 input.
- h. Set:

VERTICAL MODE	CH 2 (CH 1 off)
CH 2 VOLTS/DIV	5 mV
- i. Repeat the complete Bandwidth check procedure for Channel 2.

17. CH 3 and CH 4 Vertical Bandwidth

a. Set:

VERTICAL MODE	CH 3 (CH 2 off)
CH 3 and CH 4 VOLTS/DIV	0.1 V

- b. Connect leveled sine-wave generator (SG 503) output to the CH 3 input via a 50 Ω precision BNC coaxial cable and a 50 Ω BNC termination.
- c. Set the generator output for a six-division signal display at 50 kHz.
- d. Set the generator Frequency Range and Frequency Variable controls for a 90 MHz output frequency.
- e. CHECK—that the signal display amplitude is 4.2 divisions or more as the frequency is increased to 100 MHz.
- f. Repeat the procedure for 0.5 VOLTS/DIV setting.
- g. Move the test signal to the CH 4 input.
- h. Set VERTICAL MODE to CH 4
- i. Repeat the procedure for CH 4.

18. SCOPE BW (Bandwidth Limit) Accuracy

a. Set:

VERTICAL MODE	CH 1 (CH 4 off)
CH 1 VOLTS/DIV	10 mV
SCOPE BW	On

- b. Move test signal from the CH 4 input to the CH 1 input.
- c. Set leveled sine-wave generator (SG 503) output for a six-division signal amplitude at 50 kHz.
- d. Increase the leveled sine-wave generator output frequency, using the Frequency Range and Frequency Variable controls until a signal display amplitude of 4.2 divisions is obtained.

- e. CHECK—that the sine-wave generator output frequency is between 17 MHz and 23 MHz.
- f. Disconnect the test setup.

19. Common-Mode Rejection Ratio

- a. Connect leveled sine-wave generator (SG 503) output to the CH 1 and CH 2 input connectors via a 50 Ω precision BNC coaxial cable, a 50 Ω BNC termination, and a BNC dual-input coupler.
- b. Set the leveled sine-wave generator output for an eight-division signal-display amplitude at 50 kHz.
- c. Set:

VERTICAL MODE	ADD (CH 1 off)
CH 2 VOLTS/DIV	10 mV
CH 2 INVERT	On
SCOPE BW	Off
- d. Adjust CH 1 or CH 2 VAR VOLTS/DIV (as needed) for smallest signal amplitude.
- e. Set the leveled sine-wave output frequency to 50 MHz.
- f. Set the VERTICAL MODE to CH 1 (ADD off).
- g. Set the leveled sine-wave output amplitude for an eight-division display.
- h. Set the VERTICAL MODE to ADD (CH 1 off).
- i. CHECK—the signal is less than 0.8 division in amplitude.
- j. Disconnect the test setup.

20. Channel Isolation

a. Set:

CH 1 and CH 2 VERTICAL MODE	On (ADD off)
CH 2 INVERT	Off
CH 1, CH 2, CH 3, and CH 4	
VOLTS/DIV	0.1 V
TRIGGER SOURCE	CH 1

b. Connect the leveled sine-wave generator (SG 503) output to the CH 1 input via a 50 Ω precision BNC coaxial cable and a 50 Ω BNC termination.

c. Set the leveled sine-wave generator (SG 503) output for a five-division signal display amplitude at 100 MHz.

d. Set CH 2, CH 3, and CH 4 VERTICAL MODE On (CH 1 off).

e. CHECK—display amplitude is 0.1 division or less, excluding trace width, on the CH 2, CH 3, and CH 4 traces.

f. Move sine-wave generator signal to the CH 2 input.

g. Set:

CH 1, CH 3, and	
CH 4 VERTICAL MODE	On (CH 2 off)
TRIGGER SOURCE	CH 2

h. CHECK—display amplitude is 0.1 division or less, excluding trace width, on the CH 1, CH 3, and CH 4 traces.

i. Move sine-wave generator signal to the CH 3 input.

j. Set:

CH 1, CH 2, and CH 4	
VERTICAL MODE	On (CH 3 off)
TRIGGER SOURCE	CH 3

k. CHECK—display amplitude is 0.1 division or less, excluding trace width, on the CH 1, CH 2, and CH 4 traces.

22. Vertical ALT and CHOP Modes

a. Set:

VERTICAL MODE	CH 1, CH 2, CH 3, CH 4 On
CHOP VERTICAL MODE	Off (ALT mode)
CH 1 and CH 2 VOLTS/DIV	10 mV
CH 3 and CH 4 VOLTS/DIV	0.1 V
CH 1 and CH 2 Input COUPLING	DC
Horizontal MODE	A
SEC/DIV	0.1 ms
TRIGGER MODE	AUTO LEVEL

- b. Position all traces for two divisions of separation with the CH 1 trace near the top; then in order down the graticule area with the CH 4 trace near the bottom.
- c. Set SEC/DIV to 10 ms.
- d. CHECK—that four traces are sweeping across the screen alternately.
- e. Set CHOP VERTICAL MODE On.
- f. CHECK—that four traces are sweeping across the screen simultaneously.

23. BEAM FIND Functional Check

- a. Push BEAM FIND in and hold.
- b. CHECK—the signal is visible and compressed fully within the graticule area as the horizontal and vertical position controls are rotated through their ranges.
- c. Release the BEAM FIND button.
- d. Set all Vertical and Horizontal POSITION controls at the 12 o'clock position.

24. A and B Trace Separation

a. Set:

A SEC/DIV	1 ms
VERTICAL MODE	CH 1 (others off)
Horizontal MODE	ALT
B SEC/DIV	0.5 ms
A/B SELECT	B
B Trigger MODE	RUNS AFTER
TRACE SEP	Fully CW

- b. Position the CH 1 trace below the center horizontal graticule line to display the separated B trace.
- c. CHECK—for at least four divisions of upward trace separation between the B trace and the A trace.
- d. Set TRACE SEP fully CCW.
- e. Position the CH 1 trace above the center horizontal graticule line to display the separated B trace.
- f. CHECK—for at least four divisions downward trace separation of the B trace from the A trace.

TRIGGERING

Equipment Required (See Table 7-1)

Leveled sine-wave generator	Function generator
50 Ω BNC coaxial cable	10X BNC attenuator
2X BNC attenuator	50 Ω BNC termination
Dual-input coupler	TV signal generator

1. 500 Hz Trigger Sensitivity

a. Set:

READOUT (Intensity)	For a viewable readout
A INTEN	For a viewable trace
VERTICAL MODE	CH 1
CH 1 and CH 2 Input COUPLING	DC
CH 1 VOLTS/DIV	0.1 V
SCOPE BW	On
Horizontal MODE	A
A SEC/DIV	1 ms
Horizontal POSITION	12 o'clock
A/B SELECT	A Trigger
TRIGGER MODE	AUTO LEVEL
TRIGGER SOURCE	VERT
TRIGGER CPLG	AC
TRIGGER SLOPE	 (positive-going)
TRIGGER HOLDOFF	Min
FOCUS	For best defined display
CLEAR MEAS'MT	Press to remove measurement cursors.

- b. Connect function generator (FG 502) output to the CH 1 input via a 50 Ω BNC coaxial cable and a 50 Ω BNC termination.
- c. Set function generator (FG 502) output to produce a 7.0 division sine-wave display at 500 Hz.
- d. Add a 10X and a 2X BNC attenuator before the 50 Ω BNC termination (for a 0.35 division display).

NOTE

The TRIGGER LEVEL control may be used to obtain a stable display.

- e. CHECK—that the display is stably triggered with DC, HF REJ, and AC Trigger CPLG; and that the display will not trigger on NOISE REJ or LF REJ Trigger CPLG.

- f. Set:

Horizontal MODE	B
TRIGGER CPLG	DC
A/B SELECT	B Trigger
B TRIGGER MODE	NORM
B TRIGGER SOURCE	VERT
B TRIGGER SLOPE	 (positive-going)
B SEC/DIV	0.5 ms
DELAY Time	?0.000 (minimum delay time)
B INTEN	For viewable display

NOTE

It may be necessary to adjust the TRIGGER LEVEL control to obtain a display.

- g. CHECK—that, using the Trigger LEVEL control the display can be stably triggered in DC, HF REJ, and AC Trigger CPLG; and that the display cannot be triggered in NOISE REJ or LF REJ Trigger CPLG.

- h. Disconnect the test setup from the CH 1 input.

2. 500 kHz Trigger Sensitivity

- a. Set:

SCOPE BW	Off
Horizontal MODE	A
A/B SELECT	A Trigger
A SEC/DIV	2 μ S

- b. Connect leveled sine-wave generator (SG 503) output to the CH 1 input via a 50 Ω BNC coaxial cable and a 50 Ω BNC termination.

- c. Set leveled sine-wave generator output to produce a 7.0 division sine-wave display amplitude at 500 kHz.
- d. Add a 10X and a 2X BNC attenuator before the 50 Ω BNC termination (for a 0.35 division display amplitude).
- e. CHECK—that the display cannot be triggered in either HF REJ of NOISE REJ CPLG.
- f. Set:

Horizontal MODE	B
A/B SELECT	B Trigger
B SEC/DIV	1 μ s

- g. CHECK—that the display cannot be triggered in HF REJ or NOISE REJ CPLG by adjusting the Trigger LEVEL control.

3. 25 MHz Trigger Sensitivity

- a. Set:

Horizontal MODE	A
A/B SELECT	A Trigger
TRIGGER CPLG	DC
A SEC/DIV	50 ns

- b. Remove the 10X and 2X BNC attenuators from the signal path.
- c. Set leveled sine-wave generator output to produce a 7.0 division display amplitude at 25 MHz.
- d. Add a 10X and a 2X BNC attenuator before the 50 Ω BNC termination.
- e. CHECK—that the display is stably triggered in DC, LF REJ, and AC Trigger CPLG; the display is not triggered in NOISE REJ and HF REJ Trigger CPLG settings.

- f. Set:

TRIGGER CPLG	DC
Horizontal MODE	B
A/B SELECT	B Trigger
B SEC/DIV	20 ns

- g. CHECK—that, using the Trigger LEVEL control, the display can be stably triggered in DC, LF REJ, and AC Trigger CPLG; the display can not be triggered in NOISE REJ and HF REJ Trigger CPLG settings.
- h. Set leveled sine-wave generator (SG 503) to produce a 1.4 division display at 25 MHz.
- i. CHECK—that the display can be stably triggered with NOISE REJ Trigger CPLG but does not trigger with HF REJ CPLG.

j. Set:

Horizontal MODE	A
A/B SELECT	A Trigger

- k. CHECK—that the display is stably triggered with NOISE REJ Trigger CPLG but does not trigger with HF REJ CPLG. (The Trigger LEVEL control may be adjusted to improve display stability in NOISE REJ CPLG.)

4. 150 MHz Trigger Sensitivity

- a. Set TRIGGER CPLG to DC.
- b. Set leveled sine-wave generator to produce a 1.0 division display at 150 MHz.
- c. CHECK—that the display is stably triggered in DC, LF REJ, and AC Trigger CPLG.

d. Set:

Horizontal MODE	B
A/B SELECT	B Trigger

- e. CHECK—that, using the Trigger LEVEL control, the display can be stably triggered in DC, LF REJ, and AC Trigger CPLG.

f. Set:

Horizontal MODE	A
VERTICAL MODE	CH 2 (CH 1 off)
CH 2, CH 3, and CH 4	
VOLTS/DIV	0.1 V
A/B SELECT	A Trigger

Performance Check Procedure

TRIGGER CPLG

DC

- g. Move test signal from CH 1 to the CH 2 input.
- h. Set leveled sine-wave generator output to produce a 1.0 division display amplitude at 150 MHz.
- i. CHECK—that a stable display can be obtained. (The Trigger LEVEL control may be adjusted to improve the display stability.)
- j. Repeat the procedure for CH 3 and CH 4 (turn on the appropriate VERTICAL MODE and move the test signal as required).
- k. Move test signal to the CH 1 input.
- l. Set VERTICAL MODE to CH 1 (others off).
- m. Remove the 2X BNC attenuator from the test signal path.
- n. Set leveled sine-wave generator output for a 2.2 division display amplitude at 100 MHz.
- o. CHECK—that the display is stably triggered with NOISE REJ Trigger CPLG but is not triggered with HF REJ Trigger CPLG.
- p. Set leveled sine-wave generator output for a 0.5 division display amplitude at 100 MHz.
- q. CHECK—that the display is not triggered in NOISE REJ Trigger CPLG.
- r. Set:

TRIGGER CPLG
Horizontal MODE
A/B SELECT

DC
B
B Trigger

- s. Repeat 100 MHz NOISE REJ Trigger CPLG procedure for the B Trigger.

5. Single Sweep Mode

- a. Set:

Horizontal MODE
A SEC/DIV
A/B SELECT

A
10 μ s
A Trigger

- b. Remove the 10X BNC attenuator from the test signal path.
- c. Set leveled sine-wave generator output to produce a 7.0 division display amplitude at 50 kHz.
- d. Add a 10X and a 2X BNC attenuator before the 50 Ω BNC termination. (Display should stably trigger with AUTO LEVEL finding the correct trigger level setting.)
- e. Set:

A TRIGGER MODE	NORM
CH 1 Input COUPLING	GND
TRIGGER MODE	SGL SEQ
- f. CHECK—that the Trigger READY LED turns on and remains on.
- g. Set:

A INTEN	3/4 fully CW
CH 1 Input COUPLING	DC (see CHECK below)
- h. CHECK—that the TRIG'D LED flashes, and the READY LED turns off after a single sweep and readout display occurs when the Input COUPLING switches to DC.

6. Trigger LEVEL Control Range

- a. Set:

TRIGGER MODE	AUTO (not AUTO LEVEL)
TRIGGER LEVEL	Fully CCW
A INTEN	For a good viewing intensity
- b. Remove 10X and 2X BNC attenuators from the test signal path.
- c. Reduce leveled sine-wave generator output level until a stably triggered display is just obtainable.
- d. Set TRIGGER LEVEL fully CW.
- e. Set leveled sine-wave generator output for a stable display (if necessary).
- f. Set CH 1 VOLTS/DIV to 1 V.

- g. CHECK—that the CH 1 signal display amplitude is four divisions or more (peak-to-peak). Note that the signal is not triggered.
- h. Disconnect the test setup from the 2245A.

7. TV Field Trigger Sensitivity

- a. Set:

VERTICAL MODE	CH 2 (CH 1 off)
CH 2 VOLTS/DIV	1 V
SEC/DIV	0.2 ms
TRIGGER SLOPE	 (negative-going)
TRIGGER MODE	TV FIELD

- b. Connect TV signal generator video output to the CH 2 input via a 50 Ω BNC cable.
- c. Set CH 2 VAR VOLTS/DIV control for a 0.5 division composite sync signal.
- d. CHECK—that a stable display is obtained.

- e. Set:

CH 2 INVERT	On
TRIGGER SLOPE	 (positive-going)

- f. CHECK—that a stable display is obtained.

8. TV Line Trigger Sensitivity

- a. Set:

CH 2 INVERT	OFF
TRIGGER SLOPE	 (negative-going)
A SEC/DIV	2 ms
Horizontal MODE	B
B SEC/DIV	20 μ s
A/B SELECT	B
TRIGGER MODE	TV LINE

- b. CHECK—that a stable display is obtained for various portions of the TV FIELD as the  OR DELAY control is rotated.

c. Set:

CH 2 VAR VOLTS/DIV	DETENT (calibrated)
TRIGGER SLOPE	 (negative-going)

d. Disconnect the TV signal generator from the 2245A.



9. Line Trigger Functional Check

a. Set:

CH 2 VOLTS/DIV	0.1 V (without a 10X probe attached)
CH 2 Input COUPLING	DC
A SEC/DIV	5 ms
TRIGGER MODE	AUTO LEVEL
TRIGGER SOURCE	LINE
TRIGGER CPLG	DC

b. Connect a 10X probe to the CH 2 input connector.

c. Attach the probe tip to a length of wire at least four inches long. Hold the wire near the middle portion of the instrument power cord.

d. CHECK—that the display can be triggered in both  (positive-going) and  (negative-going) slopes.

e. Disconnect the test setup.

HORIZONTAL

Equipment Required (See Table 7-1)

Time-mark generator	50 Ω BNC coaxial cable
50 Ω BNC termination	

1. A and B Sweep Length

a. Set:

READOUT (Intensity)	For a viewable readout
A INTEN	For a viewable trace
VERTICAL MODE	CH 1
CH 1 and CH 2	
Input COUPLING	DC
CH 1 VOLTS/DIV	0.5 V
Horizontal MODE	A
A SEC/DIV	2 ms
Horizontal POSITION	12 o'clock
A/B SELECT	A Trigger
TRIGGER MODE	AUTO LEVEL
TRIGGER SOURCE	VERT
TRIGGER CPLG	AC
TRIGGER SLOPE	 (positive-going)
TRIGGER HOLDOFF	Min
TRIGGER LEVEL	12 o'clock
CLEAR MEAS'MT	Press to remove measurement cursors.
FOCUS	For best defined display

b. Connect time mark generator (TG 501) to the CH 1 input via a 50 Ω BNC coaxial cable and a 50 Ω BNC termination.

c. Set generator for 2 ms time marks.

d. CHECK—sweep length of the A trace is greater than 10 divisions.

e. Set:

Horizontal MODE	B
B SEC/DIV	1 ms
A/B SELECT	B Trigger
TRIGGER MODE	RUNS AFTER
← OR DELAY Control	Fully CCW to the lowest DELAY readout value
B INTEN	For a visible display

f. CHECK—the Delay Time readout is 20.000 ms, and the B Sweep length is greater than 10 divisions.

2. Horizontal POSITION Range

a. Set:

Horizontal MODE	A
Horizontal POSITION	Fully CW

b. CHECK—that the start of trace positions past the center vertical graticule line.

c. Set Horizontal POSITION fully CCW.

d. CHECK—that the 11th time marker is positioned to the left of the center vertical graticule line.

3. VAR SEC/DIV Range

a. Set:

SEC/DIV	1 ms
SEC/DIV VAR	Fully CCW
Horizontal POSITION	12 o'clock

- b. Set time mark generator for 5 ms time marks.
- c. CHECK—the time-mark spacing is equal to or less than two divisions.
- d. Set SEC/DIV VAR fully CW (calibrated detent).

4. Magnifier Registration

- a. Set X10 MAG on.
- b. Position rising edge of a time marker to the center vertical graticule line.
- c. Set X10 MAG off.
- d. CHECK—for less than 0.5 division horizontal trace shift.

5. A and B Timing Accuracy and Linearity

- a. Set A SEC/DIV to 20 ns.
- b. Set time-mark generator for 20 ns time marks.

- c. Position the time marker peaks vertically to the center horizontal graticule line (allows use of the minor division graticule markings as an aid in making the accuracy checks).

NOTE

For the fastest sweep speeds, where the time marker peaks are rounded and not well defined, greater resolution can be achieved by vertically centering the display and using the point where the rising edge of the time marks cross the center horizontal graticule line as a reference.

- d. Position the second time marker to the second vertical graticule line.
- e. CHECK—that the tenth time marker is within 0.16 divisions (left or right) of the tenth graticule line.
- f. CHECK—that the spacing of the time markers over any two division interval within the center eight divisions does not deviate from the value measured at the center two division by more than 0.1 division.
- g. Repeat the procedure for all other A SEC/DIV settings. Use SEC/DIV and Time Mark Generator settings in the column labeled X1 given in Table 7-3, Settings for Timing Accuracy Checks.
- h. Set SEC/DIV to 20 ns.
- i. Set time-mark generator for 20 ns time marks.
- j. Set:

Horizontal MODE	B
B INTEN	For a viewable display

- k. Repeat the CHECK procedure for all the B SEC/DIV settings.

Table 7-3
Settings for Timing Accuracy Checks

SEC/DIV Setting		Time-Mark Setting	
X1	X10 MAG	X1	X10 MAG
20 ns	2 ns	20 ns	5 ns
50 ns	5 ns	50 ns	5 ns
0.1 μ s	10 ns	0.1 ns	10 ns
0.2 μ s	20 ns	0.2 μ s	20 ns
0.5 μ s	50 ns	0.5 μ s	50 ns
1 μ s	0.1 μ s	1 μ s	0.1 μ s
2 μ s	0.2 μ s	2 μ s	0.2 μ s
5 μ s	0.5 μ s	5 μ s	0.5 μ s
10 μ s	1 μ s	10 μ s	1 μ s
20 μ s	2 μ s	20 μ s	2 μ s
50 μ s	5 μ s	50 μ s	5 μ s
0.1 ms	10 μ s	0.1 ms	10 μ s
0.2 ms	20 μ s	0.2 ms	20 μ s
0.5 ms	50 μ s	0.5 ms	50 μ s
1 ms	0.1 ms	1 ms	0.1 ms
2 ms	0.2 ms	2 ms	0.2 ms
5 ms	0.5 ms	5 ms	0.5 ms
A Sweep only			
10 ms	1 ms	10 ms	1 ms
20 ms	2 ms	20 ms	2 ms
50 ms	5 ms	50 ms	5 ms
0.1 s	10 ms	0.1 s	10 ms
0.2 s	20 ms	0.2 s	20 ms
0.5 s	50 ms	0.5 s	50 ms

6. A and B Magnified Timing Accuracy and Linearity

a. Set time-mark generator for 20 ns time marks.

b. Set:

Horizontal MODE	A
A SEC/DIV	20 ns
Horizontal MODE	B
B SEC/DIV	20 ns
X10 MAG	On (for 2 ns/div sweep speed)
CH 1 VOLTS/DIV	0.5V (use 0.2 V for the 5 ns time markers if necessary)

c. Set the Horizontal POSITION control to 12 o'clock, and then align the rising edge of the nearest time marker to the second vertical graticule line (center the display vertical).

NOTE

For the fastest sweep speeds, where the time marker peaks are rounded and not well defined, greater resolution can be achieved by vertically centering the display and using the point where the rising edge of the time marks cross the center horizontal graticule line as a reference.

d. CHECK—that the rising edge of the fourth displayed time marker crosses the center horizontal graticule line at between 8.27 divisions and 8.73 division from the left-most graticule line.

e. CHECK—that the spacing of the time markers over any 2.5 division interval within the center eight divisions does not deviate from the value measured at the center 2.5 divisions by more than 0.12 division. Use the fifth vertical graticule line as a starting point for the measurement at the center 2.5 divisions. Exclude the first 1/4 division or 25 ns and any portion of the sweep past the 100th magnified division.

f. Set SEC/DIV to 5 ns.

g. Set the Horizontal POSITION control to 12 o'clock, and then align the nearest time marker to the second vertical graticule line.

h. CHECK—that the tenth displayed time marker is within 0.24 division (left or right) of the tenth graticule line.

j. Repeat the timing and linearity checks for all SEC/DIV settings between 10 ns and 0.5 ms. Use the SEC/DIV and Time Mark Generator X10 MAG settings given in Table 7-3.

k. Set:

Horizontal MODE	A
SEC/DIV	2 ns (with X10 MAG on)

l. Set time-mark generator for 5 ns time markers.

m. Repeat the magnified accuracy and linearity checks for the A Sweep at all magnified SEC/DIV settings.

7. Delay Time Jitter

a. Set:

X10 MAG	Off
A SEC/DIV	1 ms
Horizontal MODE	ALT
B SEC/DIV	0.5 μ s

b. Set time-mark generator for 1 ms time marks.

c. Position the intensified dot to the leading edge of the 10th time marker to display the rising edge on the B Trace (using the \leftarrow OR DELAY control). It may be necessary to reduce the A intensity level to observe the intensified dot.

d. Set:

Horizontal MODE	B
B INTEN	Fully CW (maximum intensity)

d. CHECK—that the jitter on the leading edge does not exceed one division over a two-second interval. Disregard slow drift.

8. Delay Time Accuracy

a. Set:

Horizontal MODE	ALT
B SEC/DIV	10 μ s
TRACE SEP	Fully CCW (maximum downward position)
CH 1 POSITION	To display both the ALT and the B Delayed Traces

- b. Position the intensified dot to full left position (counter-clockwise rotation of the κ - OR DELAY control).
- c. Align the leading edge of the time marker displayed on the B trace to the left-most (first) graticule line, using only the Horizontal POSITION control.
- d. CHECK—that the readout is ?0.000 ms.
- e. Position the intensified zone to the second time marker and align the leading edge of the time marker displayed on the B Trace to the left-most (first) graticule line using only the κ - OR DELAY control. Using the Readout Accuracy Limits given in Table 7-4, check the delay time accuracy.
- f. Repeat the procedure for the 3rd through 10th time markers.

**Table 7-4
Delay Time Accuracy**

Time Marker	Readout Accuracy Limits
1st	? 0.000 ms
2nd	0.945 ms to 1.055 ms
3rd	1.940 ms to 2.060 ms
4th	2.935 ms to 3.065 ms
5th	3.930 ms to 4.070 ms
6th	4.925 ms to 5.075 ms
7th	5.920 ms to 6.080 ms
8th	6.915 ms to 7.085 ms
9th	7.910 ms to 8.090 ms
10th	8.905 ms to 9.095 ms

9. Delay Time Position Range

- a. Set time-mark generator for 0.1 ms.
- b. Set:

A SEC/DIV	1 ms
B SEC/DIV	5 μ s
μ - OR DELAY control	70.000 ms
- c. CHECK—that the intensified dot is positioned at or before the second time marker.
- d. Turn the μ - OR DELAY control clockwise until the delay readout stops increasing (largest number).
- e. CHECK—that the intensified dot is positioned at or after the 99th time marker (located at a Delay Time of 9.9 ms).
- f. Disconnect the time mark generator from the 2245A.

10. X-Axis Gain Accuracy

- a. Set:

Horizontal MODE	X-Y
VERTICAL MODE	CH 2 (CH 1 off)
CH 1 and CH 2	
VOLTS/DIV	10 mV
CH 1 Input COUPLING	DC
CH 2 Input COUPLING	GND
- b. Connect calibration generator Std Ampl output to the CH 1 input via a 50 Ω precision BNC coaxial cable.
- c. Set calibration generator for Std Ampl output, 50 mV.
- d. CHECK—X-Axis amplitude is between 4.85 and 5.15 horizontal divisions.
- e. Disconnect calibration generator.

11. X-Y Phase Difference

a. Set:

HORIZONTAL MODE	A
VERTICAL MODE	CH 1 (CH 2 off)
CH 1 Input COUPLING	DC

b. Connect leveled sine-wave generator output to the CH 1 Input via a 50 Ω BNC coaxial cable and a 50 Ω BNC termination.

c. Set leveled sine-wave generator output for six divisions of signal display amplitude at 50 kHz.

d. Set:

Horizontal MODE	X-Y
CH 1 Input COUPLING	GND

e. Position dot to graticule center.

f. Set CH 1 Input COUPLING to DC.

g. CHECK—ellipse opening at the center is 0.3 division or less, measured horizontally.

12. X-Axis Bandwidth

a. Set VERTICAL MODE to CH 2 (CH 1 off).

b. Set leveled sine-wave generator output for six divisions of horizontal display amplitude at 50 kHz.

c. Set leveled sine-wave output to 3 MHz.

d. CHECK—X-Axis display is 4.2 horizontal divisions or more.

e. Disconnect the test equipment from the 2245A.

MEASUREMENT CURSORS

Equipment Required (See Table 7-1)

Time mark generator
50 Ω BNC coaxial cable

Calibration generator
50 Ω BNC termination

1. \leftarrow SEC \rightarrow and \leftarrow 1/SEC \rightarrow Cursor Accuracy

a. Set:

READOUT (Intensity)	For a viewable readout
A INTEN	For a viewable trace
VERTICAL MODE	CH 1
CH 1 VOLTS/DIV	0.5 V
CH 1 and CH 2	
Input COUPLING	DC
CH 2 INVERT	Off
SCOPE BW	Off
Horizontal MODE	A
A SEC/DIV	1 ms
A/B SELECT	A Trigger
TRIGGER MODE	AUTO LEVEL
TRIGGER CPLG	DC
TRIGGER SOURCE	VERT
TRIGGER SLOPE	 (positive-going)
TRIGGER HOLDOFF	Min
FOCUS	For best defined display

- b. Connect time-mark generator (TG 501) output via a 50 Ω BNC coaxial cable and a 50 Ω BNC termination to the CH 1 input.
- c. Set time-mark generator for 1 ms time marks.
- d. Position first time marker horizontally to the first vertical graticule line (left-most edge of the graticule).
- e. Press TIME MEASUREMENTS button to display the \leftarrow SEC \rightarrow cursors.
- f. Position the reference cursor to the second time marker and the delta cursor to the tenth time marker.

- g. CHECK—that the readout is 7.940 ms to 8.060 ms.
- h. Press the 1/TIME MEASUREMENTS button to display the $\left\langle \leftarrow 1/\text{SEC} \rightarrow \right\rangle$ cursors.
- i. Reposition the reference cursor and the delta cursor to the second and tenth time markers respectively.
- j. CHECK—that the readout is 124 Hz to 126 Hz.

2. $\left\langle \leftarrow \text{VOLTS} \rightarrow \right\rangle$ Cursor Accuracy

- a. Set:

CH 1 VOLTS/DIV	0.1 V
SEC/DIV	0.5 ms

- b. Connect calibration generator (PG 506) output to the CH 1 input via a 50 Ω precision BNC coaxial cable.
- c. Set calibration generator to Std Ampl 0.5 V.
- d. Position bottom of the signal to the second horizontal graticule line from the bottom.
- e. Press the CURSOR VOLTS button to display the cursors $\left\langle \leftarrow \text{VOLTS} \rightarrow \right\rangle$.
- f. Position the reference cursor to the bottom of the signal and the delta cursor to the top of the signal (both cursors move with the $\left\langle \leftarrow \text{OR DE-LAY} \right\rangle$ control).
- g. CHECK—that the readout is between 0.493 V to 0.507 V.
- h. Disconnect calibration generator.

EXTERNAL Z-AXIS, PROBE ADJUST AND AUTO SETUP FUNCTIONS

Equipment Required (See Table 7-1)

Calibration Generator	BNC T-connector
Two 50 Ω BNC coaxial cable	Test oscilloscope
50 Ω precision BNC coaxial cable	with a 10X probe

1. Check External Z-Axis Input

a. Set:

READOUT (Intensity)	For a viewable readout
A INTEN	For a viewable trace
VERTICAL MODE	CH 1
CH 1 VOLTS/DIV	1 V
CH 2 INVERT	Off
SCOPE BW	Off
CH 1 Input COUPLING	DC
Horizontal MODE	A
A SEC/DIV	0.5 ms
Horizontal POSITION	12 o'clock
A/B SELECT	A Trigger
TRIGGER MODE	AUTO LEVEL
TRIGGER CPLG	DC
TRIGGER SOURCE	VERT
TRIGGER SLOPE	 (positive-going)
TRIGGER HOLDOFF	Min
FOCUS	For best defined display

- b. Connect calibration generator (PG 506) Std Ampl output to the CH 1 and the EXT Z-AXIS inputs via a 50 Ω precision BNC coaxial cable, a BNC T-connector, and two 50 Ω BNC coaxial cables. Set generator to Std Ampl output, 5 V.
- c. Set A INTEN to maximum intensity.
- d. CHECK—waveform display intensity starts decreasing at 1.8 V or less and the waveform is extremely modulated out at 3.8 V.

- e. Set A INTEN to midrange.
- f. Disconnect the test equipment from the 2245A.

2. PROBE ADJUST Output

- a. Set:

CH 1 VOLTS/DIV	10 mV
SEC/DIV	0.2 ms

- b. Connect a 10X probe to the CH 1 input connector and connect the probe tip to the 2245A PROBE ADJUST output. (When using Tektronix coded probes, the readout changes to .1 V.)
- c. CHECK—For a 5-division vertical display of PROBE ADJUST square-wave signal (square-wave period is typically 1 ms, within 25%).

3. AUTO SETUP Functional Check

- a. Set:

CH 1 COUPLING	GND
CH 1 VOLTS/DIV	2 mV
A SEC/DIV	20 ns

- b. Press the AUTO SETUP button.
- c. Check that the Probe Adjust waveform is stably displayed on the upper half of the crt.

OPTION 15

Equipment Required (See Table 7-1)

Calibration generator	Two 50 Ω BNC coaxial cables
Test oscilloscope	50 Ω Precision BNC coaxial cable
Level sine-wave generator	Two 50 Ω BNC termination

1. Signal Output

a. Set:

VERTICAL MODE	
CH 1 and CH 2	On (light on)
CH 3 and CH 4	Off (light off)
BW LIMIT	Off (light off)
VOLTS/DIV	
CH 1 and CH 2	2 MV
Input Coupling	
CH 1 and CH 2	GND
A and B SEC/DIV	1 ms
TRIGGER MODE	AUTO LVL
SOURCE	VERT
COUPLING	NOISE REJ

- b. Push the CH 2 VERTICAL MODE button so that light is off.
- c. Connect the CH 2 signal from the rear-panel CH 2 SIGNAL OUT connector to the CH 1 OR X input connector via a 50 Ω BNC cable.
- d. Align the CH 1 trace to the center graticule line.
- e. Set CH 1 Input Coupling to DC.
- f. CHECK—Display amplitude to 4.5 to 5.5 divisions (neglect trace width).
- g. Connect a 1 kHz, 10 mV standard-amplitude signal from the Calibration Generator to the CH 2 Input Connector via a 50 Ω BNC cable.

- h. Set CH 2 Input Coupling to DC.
- i. Set CH 1 VOLTS/DIV to 20 mV.
- j. CHECK—Display amplitude to 4.5 to 5.5 divisions (neglect trace width).
- k. Connect a 50 Ω terminator to the CH 1 Input.
- l. Set CH 1 VOLTS/DIV to 10 mV.
- m. CHECK—Display amplitude to 4.5 to 5.5 divisions (neglect trace width).
- n. Set CH 2 VOLTS/DIV to 0.1 V.
- o. Connect to 50 kHz signal from the Leveled Sine-Wave Generator to the CH 2 input connector via a 50 Ω precision BNC cable and a 50 Ω BNC termination.
- p. Adjust the generator output level to produce a 6-division CH 1 display.
- q. Increase the generator frequency to 25 MHz.
- r. CHECK—Display amplitude is 4.24 divisions or greater.
- s. Disconnect the test setup.

2. A GATE Output

a. Set:

SEC/DIV	0.1 ms
TRIGGER MODE	Auto
HOLDOFF	Minimum (CCW)

- b. Connect a test oscilloscope to the A GATE OUT Connector from the rear-panel via 50 Ω BNC cable.
- c. CHECK—Test oscilloscope displays a signal with a high level between 2 V and 5.25 V and a low level between 0 V and 0.7 V.
- d. CHECK—Duration of the high level is greater than or equal to 0.2 ms.
- e. Set HOLDOFF Control to maximum (CW).
- f. CHECK—Duration of the high level is greater than or equal to 2 ms.
- g. Disconnect the test setup.

SECTION 8

**OPTIONS
AND
ACCESSORIES**

Introduction

This section lists the instrument options and accessories that were available at the time this manual was published. To obtain additional information about these and other options and accessories, refer to a current Tektronix Product Catalog or contact your local Tektronix Field Office or representative.

Options A1–A5 International Power Cords

Instruments are shipped with the detachable power-cord option as ordered by the customer. Descriptive information about the international power-cord options is provided in Section 2 "Preparation for Use." Order power cords only by option number and description. The optional power cords available for the 2245A are as follows:

- Standard, North American 120 V, 60 Hz, 74 in.
- Option A1, Universal Euro 220 V, 50 Hz, 2.5 m
- Option A2, UK 240 V, 50 Hz, 2.5 m
- Option A3, Australian 240 V, 50 Hz, 2.5 m
- Option A4, North American 220 V, 50 Hz, 2.5 m
- Option A5, Switzerland 220 V, 50 Hz, 2.5 m

Option 15

The 2245A Option 15 oscilloscope provides two additional output signals from the rear of the instrument: a Channel 2 output signal and an A GATE output signal. The following paragraphs give a more detailed description of both of these outputs. Specifications and Performance Checks are integrated into the appropriate sections of this manual.

CH 2 Signal Output—Connector located on the rear-panel provides an output signal that is a normalized representation of the Channel 2 input signal. The output amplitude into a 1 M Ω load is approximately 20 mV per division of input signal. Into a 50 Ω load, the output amplitude is approximately 10 mV per division of input signal.

A GATE Output—Connector located on the rear-panel provides a TTL and CMOS compatible, positive-going gate signal that is HI during the A Sweep and LO when the A Sweep is not running.

Option 1R Rackmounted Instrument

When the 2245A Portable Oscilloscope is ordered with Option 1R, it is shipped in a configuration that permits easy installation into a 19-inch-wide equipment rack. Also, an optional rackmounting kit may be ordered to convert the standard 2245A to a rackmounted instrument. Installation instructions for rackmounting are provided in the documentation supplied with the rackmounting kit and the 1R Option.

Other Available Options

Option 02	Front Panel Cover and Accessory Pouch
Option 1C	C-5C Option 02 Camera
Option 1K	K212 Portable Instrument Cart
Option 17	P6408 Logic Probe included
Option 22	Two P6109 Option 1 10X voltage probes
Option 23	Two P6062B 1X/10X voltage probes, 6 feet

Standard Accessories

The following standard accessories are provided with each instrument:

	Part Number
2 Probes, 10X, 1.5 m with accessories	P6109 or equivalent
1 Power cord (Option A0-A5)	As ordered
1 Power cord clamp	343-1213-00
1 Operators manual	070-6558-01
1 Reference guide	070-6718-01
1 CRT implosion shield, blue plastic (Installed)	337-2775-00
1 Fuse, 2 A, 250 V, slow-blow	159-0023-00
1 Accessory pouch, ziploc	004-0130-00

Optional Accessories

The following optional accessories are recommended for use with the 2245A Oscilloscope:

Instrument Enhancements	Part Number
Protective front-panel cover	200-3232-00
Attaching accessories pouch	016-0857-00
Protective waterproof vinyl cover	016-0848-00
Clear implosion shield	337-2775-01
Rackmounting kit	2240F1R
DC Inverter power supply	1105
2245A Service manual	070-6557-00

Transportation Aids

Carrying strap	346-0199-00
Portable instrument cart	K212

Cameras

Low-cost scope camera	C5 Option 02
Motorized camera	C7 Options 03 and 30
High-performance camera	C30B Option 01

Probes

Active probe	P6202A
Power supply for active probe	1101A
Current probes	P6021 (1.52 m); P6022 (1.52 m); A6302/AM503; A6303/AM503
Environmental probe	P6008 (1.83 m)
High voltage probe	P6009 (2.74 m)
1X/10X passive probe	P6063B (1.83 m)
Subminiature 10X probe	P6130 (2 m)
Ground isolation monitor	A6901
Isolator (for floating measurements)	A6902B

Viewing Hoods

APPENDIX

APPENDIX

Table A-1
 AUTO-SETUP Control Settings

FRONT-PANEL CONTROL	AUTO-SETUP ACTION
SCOPE BW	Off.
X10 MAG	Off.
Horizontal POSITION	Midrange, if not within 1 division of midrange. The Horizontal position control does not affect the position of the trace until moved through the point corresponding to the trace position set by AUTO SETUP.
Horizontal MODE	A, if A or X-Y selected; ALT if ALT or B selected.
TRIGGER	
A/B SELECT	A, if A Horizontal MODE selected by AUTO-SETUP; otherwise B.
A MODE	AUTO LEVEL.
B MODE	RUNS AFTER, if ALT or B selected; otherwise as selected.
A SOURCE	VERT.
B SOURCE	VERT, if ALT or B selected; otherwise as selected.
A CPLG	NOISE REJ, if SOURCE Volts/Div is set to 2 mV by AUTO SETUP, otherwise DC.
B CPLG	NOISE REJ, if SOURCE Volts/Div is set to 2 mV by AUTO SETUP, otherwise DC.
A SLOPE	As selected.
B SLOPE	As selected.
A LEVEL	Nominally midway between peaks of A SOURCE signal. Signal peaks must be $\leq (10 \text{ volts} \times \text{probe multiplier})$.
B LEVEL	Nominally midway between peaks of B SOURCE signal. Signal peaks must be $\leq (10 \text{ volts} \times \text{probe multiplier})$.

Table A-1 (cont.)
AUTO-SETUP Control Settings

FRONT-PANEL CONTROL	AUTO-SETUP ACTION
VERTICAL MODE CH 1, CH 2, and ADD	CH 1 and CH 2, if ADD only was selected; otherwise only CH 1, CH 2, or both as selected.
CH 3 and CH 4	As selected.
CHOP/ALT	CHOP. If A sweep is 0.1 ms/div or slower, ALT of 50 μ s/div or faster.
CH 2 INVERT	Off.
VERTICAL POSITION	
CH 1 (Channel turned on)	Ground level aligned with 3rd graticule line from top. ^a
CH 2 (Channel turned on)	Ground level aligned with 5th graticule line from top. ^a
CH 3 (Channel turned on)	Ground level aligned with 1st graticule line from top. ^a
CH 4 (Channel turned on)	Ground level aligned with 7th graticule line from top. ^a The VERTICAL POSITION controls do not affect the position of the trace until moved through the point corresponding to the trace position set by AUTO SETUP.
CH 1 and CH 2 VOLTS/DIV (Channel turned on)	Lowest setting for which all waveform values are within ± 2 divisions of ground. ^a
CH 3 and CH 4 VOLTS/DIV (Channel turned on)	0.5 V (plus probe factor if applicable). ^a
A SEC/DIV	One speed slower than the fastest speed that displays one complete cycle of the triggering signal, within the range 2 ms to 20 ns. Depending on input signal characteristic, if more than one complete cycle can be displayed, the A SEC/DIV is set to

Table A-1 (cont.)
AUTO-SETUP Control Settings

FRONT-PANEL CONTROL	AUTO-SETUP ACTION
B SEC/DIV	20 ns, if A SEC/DIV was set to 50 ns by AUTO SETUP; otherwise two speeds faster than A SEC/DIV.
CURSORS/TIME POSITION	Measurement Reinitialized
A INTEN, B INTEN, READOUT	<p>Midrange, if pot rotation is less than 28% from CCW stop; otherwise as selected.</p> <p>A intensify is set to 30% if Horizontal MODE is ALT.</p> <p>The A INTEN, B INTEN and READOUT controls do not affect display intensity until moved through the point corresponding to the intensity level set by the AUTO SETUP.</p>
TRACE SEP	<p>Midrange, if ALT or B selected; otherwise as selected.</p> <p>The TRACE SEP control does not affect the trace separation until moved through the point corresponding to the trace position set by AUTO SETUP.</p>
HOLDOFF	As adjusted.
CH 1 VAR, CH 2 VAR, SEC/DIV VAR	As adjusted.
Measurements	As selected.

Appendix A

Table A-2
MIN SETUP Control Settings^a
B020100 and above

FRONT-PANEL CONTROL	MIN SETUP ACTION
HORIZONTAL MODE	Changes to ALT if B selected.
TRIGGER A LEVEL	Nominally midway between peaks of A SOURCE signal. Signal peaks must be \leq (10 volts X probe multiplier).
B LEVEL	Nominally midway between peaks of B SOURCE signal. Signal peaks must be \leq (10 volts X probe multiplier).
CH 1 and CH 2 COUPLING (Channel turned on)	DC, if COUPLING set to GND or DC; otherwise AC.
VERTICAL MODE CH 1, CH 2, and ADD	CH 1 and CH 2, if ADD only was selected; otherwise only CH 1, or CH 2, or both as selected.
CH 1 and CH 2 VOLTS/DIV	Lowest value for which all waveform values are within ± 2 divisions of ground. ^b If Horizontal MODE is X-Y, CH 1 VOLTS/DIV is stepped down one additional setting
A SEC/DIV	One speed slower than the fastest speed that displays one complete cycle of the triggering signal, within the range 2 ms to 20 ns. ^c Depending on input signal characteristics, if more than one complete cycle can be displayed at 20 ns, the A sweep may be set to either 50 ns or 20 ns. 5ms, if TV FIELD selected; 10 μ s, if TV LINE selected.
B SEC/DIV	20 ns, if A SEC/DIV was set to 20 ns or 50 ns by MIN SETUP; otherwise two speeds faster than A SEC/DIV. ^c 10 μ s, if TV LINE selected.
CURSORS/TIME POSITION	Measurement Reinitialized.

^a MIN SETUP only sets those controls listed. All other front panel controls remain as set by the user.
^b Download from Www.Somanuals.com. All Manuals Search And Download.

Table B-1
Factory Settings

Controls	Settings
VERTICAL MODE	CH 1 AND CH 2
CH 1, CH 2 INPUT COUPLING	DC
CH 1, 2, 3, 4 VOLTS/DIV	0.1 V
CH 2 INVERT	OFF
SCOPE BW	OFF
HORIZONTAL MODE	A
X10 MAG	OFF
A SEC/DIV	0.1 ms
B SEC/DIV	1 μ s
A, B SLOPE	
A/B SELECT	A
A TRIGGER MODE	AUTO LEVEL
B TRIGGER MODE	RUNS AFTER
A and B TRIGGER SOURCE	CH 1
A and B TRIGGER COUPLING	DC
TRIGGER HOLDOFF	As selected
MEASUREMENTS	OFF
CONFIGURE Selections:	
KEEP MENU ON WHEN MEAS' MT SELECTED?	NO
PRESET TV TRIG SLOPE FOR -SYNC? ^a	YES
A INTEN, B INTEN, READOUT	As selected

MANUAL CHANGE INFORMATION

At Tektronix, we continually strive to keep up with latest electronic developments by adding circuit and component improvements to our instruments as soon as they are developed and tested.

Sometimes, due to printing and shipping requirements, we can't get these changes immediately into printed manuals. Hence, your manual may contain new change information on following pages.

A single change may affect several sections. Since the change information sheets are carried in the manual until all changes are permanently entered, some duplication may occur. If no such change pages appear following this page, your manual is correct as printed.

Date: 5-8-89 Change Reference: C1/0589

Product: 2245A OPERATORS Manual Part Number: 070-6558-01

DESCRIPTION

Product Group 46

INSTALLING THE ACCESSORY POUCH

REFER TO THE ILLUSTRATION ON THE FOLLOWING PAGE WHILE PERFORMING THIS PROCEDURE

1. Place the oscilloscope on a table or work bench with the rear against a firm support or wall and the front facing you.
2. Center the rear of the pouch plate and insert the rear edge of the plate in the space between the cabinet top and the rear panel trim (see part A of illustration).
3. Move the pouch sideways as necessary to line up the key slots in the pouch plate with the keys on the rear panel (the plate will be centered when aligned) and push the plate all the way in (see part B of illustration).
4. Grasp the pouch plate assembly with both hands near the front of the assembly.

NOTE

In the next step, use only enough force to clear the front panel trim with the plate front edge. Excessive force will cause a permanent bow in the plate.

5. Push back on the plate and press down with the heels of your hands to bow the plate enough to slide the front of the plate into the space between the cabinet top and the front panel trim (see part C of illustration).
6. Move the front of the pouch as needed to line up the key slots in the plate with the keys on the front panel.

7. Release the pressure on the plate to allow it to return to its normal flat state.

MANUAL CHANGE INFORMATION

Product: 2245A OPERATORS Date: 5-8-89 Change Reference: C1/0589

DESCRIPTION

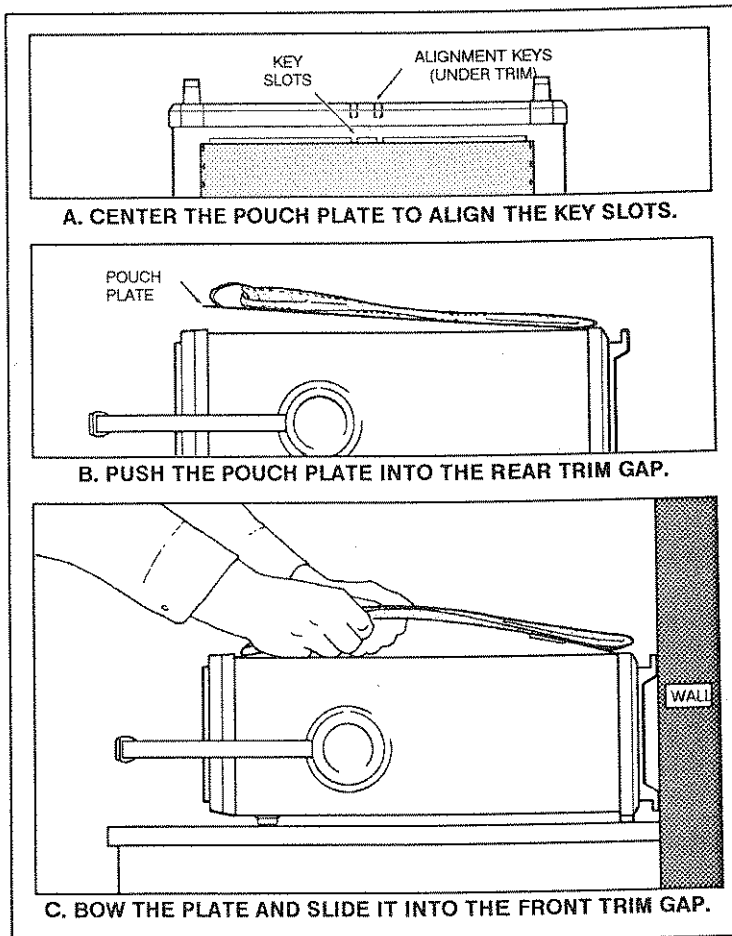



MANUAL CHANGE INFORMATION

Date: 8-28-89 Change Reference: C2/0889

Product: 2245A OPERATORS Manual Part Number: 070-6558-01

DESCRIPTION

Product Group 46

EFFECTIVE ALL SERIAL NUMBERS

Page 6-6 HORIZONTAL DEFLECTION SYSTEM

Replace the Sweep Linearity with the following:

Sweep Linearity	<p>± 5%.</p> <p>Sweep Linearity applies over the center eight divisions. Excludes the first 1/4 division or 25 ns from the start of the magnified sweep and anything beyond the 100th magnified division.</p>
-----------------	---



MANUAL CHANGE INFORMATION

Date: 10-20-89 Change Reference: C2/0889(REV)

Product: 2245A OPERATORS Manual Part Number: 070-6558-01

DESCRIPTION

Product Group 46

EFFECTIVE ALL SERIAL NUMBERS

Page 6-6 HORIZONTAL DEFLECTION SYSTEM

Replace the Sweep Linearity with the following:

Sweep Linearity	
0.5 s/div to 5 ns/div	$\pm 5\%$.
2 ns/div	$\pm 15\%$
	Sweep Linearity applies over the center eight divisions. Excludes the first 1/4 division or 25 ns from the start of the magnified sweep and anything beyond the 100th magnified division.



MANUAL CHANGE INFORMATION

Date: 11-08-89 Change Reference: C3/1189

Product: 2245A OPERATORS Manual Part Number: 070-6558-01

DESCRIPTION

Product Group 46

EFFECTIVE ALL SERIAL NUMBERS

Page 6-5 VERTICAL DEFLECTION SYSTEM

Replace Delay Match with the following:

Delay Match (CH 1 or CH 2 to CH 3 OR CH 4)	≤400 ps difference.
---	---------------------

Page 7-21

Step 14. CH 1 to CH 4 Signal Delay Match

d. CHECK – that the leading edges of the two waveforms have ≤ 0.2 horizontal division separation at the center graticule line excluding trace width.

Date: 11-16-89 Change Reference: C3/1189 (Rev)

Product: 2245A OPERATORS Manual Part Number: 070-6558-01

DESCRIPTION

Product Group 46

EFFECTIVE ALL SERIAL NUMBERS

Page 6-5 VERTICAL DEFLECTION SYSTEM

Replace Delay Match with the following:

Delay Match (CH 1 or CH 2 to CH 3 OR CH 4)	≤ 400 ps difference.
---	---------------------------

Page 7-21

Step 14. CH 1 to CH 4 Signal Delay Match

d. CHECK — that the leading edges of the two waveforms have ≤ 0.2 horizontal division separation at the center graticule line excluding trace width.



Free Manuals Download Website

<http://myh66.com>

<http://usermanuals.us>

<http://www.somanuals.com>

<http://www.4manuals.cc>

<http://www.manual-lib.com>

<http://www.404manual.com>

<http://www.luxmanual.com>

<http://aubethermostatmanual.com>

Golf course search by state

<http://golfingnear.com>

Email search by domain

<http://emailbydomain.com>

Auto manuals search

<http://auto.somanuals.com>

TV manuals search

<http://tv.somanuals.com>