

User Manual

Tektronix

**TDS 340A, TDS 360 & TDS 380
Digital Real-Time Oscilloscopes**

070-9459-02

CE

Copyright © Tektronix, Inc. 1995. All rights reserved.

Tektronix products are covered by U.S. and foreign patents, issued and pending. Information in this publication supercedes that in all previously published material. Specifications and price change privileges reserved.

Printed in the U.S.A.

Tektronix, Inc., P.O. Box 1000, Wilsonville, OR 97070-1000

TEKTRONIX and TEK are registered trademarks of Tektronix, Inc.

WARRANTY

Tektronix warrants that the products that it manufactures and sells will be free from defects in materials and workmanship for a period of three (3) years from the date of shipment. If a product proves defective during this warranty period, Tektronix, at its option, either will repair the defective product without charge for parts and labor, or will provide a replacement in exchange for the defective product.

In order to obtain service under this warranty, Customer must notify Tektronix of the defect before the expiration of the warranty period and make suitable arrangements for the performance of service. Customer shall be responsible for packaging and shipping the defective product to the service center designated by Tektronix, with shipping charges prepaid. Tektronix shall pay for the return of the product to Customer if the shipment is to a location within the country in which the Tektronix service center is located. Customer shall be responsible for paying all shipping charges, duties, taxes, and any other charges for products returned to any other locations.

This warranty shall not apply to any defect, failure or damage caused by improper use or improper or inadequate maintenance and care. Tektronix shall not be obligated to furnish service under this warranty a) to repair damage resulting from attempts by personnel other than Tektronix representatives to install, repair or service the product; b) to repair damage resulting from improper use or connection to incompatible equipment; c) to repair any damage or malfunction caused by the use of non-Tektronix supplies; or d) to service a product that has been modified or integrated with other products when the effect of such modification or integration increases the time or difficulty of servicing the product.

THIS WARRANTY IS GIVEN BY TEKTRONIX IN LIEU OF ANY OTHER WARRANTIES, EXPRESS OR IMPLIED. TEKTRONIX AND ITS VENDORS DISCLAIM ANY IMPLIED WARRANTIES OF MERCHANTABILITY OR FITNESS FOR A PARTICULAR PURPOSE. TEKTRONIX' RESPONSIBILITY TO REPAIR OR REPLACE DEFECTIVE PRODUCTS IS THE SOLE AND EXCLUSIVE REMEDY PROVIDED TO THE CUSTOMER FOR BREACH OF THIS WARRANTY. TEKTRONIX AND ITS VENDORS WILL NOT BE LIABLE FOR ANY INDIRECT, SPECIAL, INCIDENTAL, OR CONSEQUENTIAL DAMAGES IRRESPECTIVE OF WHETHER TEKTRONIX OR THE VENDOR HAS ADVANCE NOTICE OF THE POSSIBILITY OF SUCH DAMAGES.

Table of Contents

General Safety Summary	vii
Preface	xi
Getting Started	
Start Up	1-2
Line Fuse Replacement	1-3
Self Test	1-5
Functional Test	1-7
Operating Basics	
Display and Power Controls	2-1
Vertical Controls	2-2
Horizontal Controls	2-3
Trigger Controls	2-4
Miscellaneous Controls	2-5
Display Map	2-6
Inputs	2-7
Rear-Panel Connectors	2-8
Using the Menu System	2-9
Using the Probes	2-12
Using Autoset	2-15
Reference	
Introduction	3-1
Manipulating Waveforms	3-3
Vertical Operations	3-3
Horizontal Operations	3-6
Displaying Math Waveforms	3-8
Triggering	3-11
Edge Triggering	3-11
Video Triggering	3-14
Taking Measurements	3-17
Automated Measurements	3-17
Taking Measurements with Cursors	3-21
Controlling Acquisition	3-25
Controlling the Display	3-27
Using the FFT	3-31
Description	3-31
Operation	3-32
Considerations for Using FFTs	3-36
Making Hard Copies (Option 14 Equipped Instruments Only)	3-41
Configuring Hard Copy Output	3-41
Saving a Hard Copy to Disk	3-43

Saving and Recalling Waveforms	3-45
Using Reference Waveforms	3-45
Using the Disk	3-47
Viewing a Waveform on a Spreadsheet	3-49
Saving and Recalling Front-Panel Setups	3-51
Using Internal Memory	3-52
Using the Disk	3-52
Using the File System	3-55
Using the Utility Menu	3-59
Setting the Date and Time	3-60

Appendices

Appendix A: Specifications	A-1
Warranted Characteristics	A-1
Typical Characteristics	A-5
Nominal Traits	A-7
Appendix B: Performance Verification	B-1
Conventions	B-1
Test Equipment	B-3
Test Record	B-4
Performance Test Overview	B-5
Signal Acquisition System Checks	B-5
Time Base System Checks	B-10
Trigger System Checks	B-11
Sine Wave Generator Leveling Procedure	B-14
Appendix C: Options and Accessories	C-1
Options	C-1
Standard Accessories	C-3
Optional Accessories	C-3
Accessory Probes	C-4
Accessory Cables	C-4
Appendix D: General Care and Cleaning	D-1
General Care	D-1
Cleaning	D-1

Glossary

Index

List of Figures

Figure 1-1: The ON/STBY button	1-3
Figure 1-2: Line fuse removal	1-4
Figure 1-3: Verifying adjustments and signal path compensation ...	1-6
Figure 1-4: Hookup for functional test	1-7
Figure 2-1: Using menus	2-10
Figure 2-2: A pop-up menu	2-11
Figure 2-3: Connecting a probe	2-12
Figure 2-4: Probe compensation setup	2-13
Figure 2-5: Compensation waveform	2-13
Figure 2-6: How probe compensation affects signals	2-14
Figure 2-7: Location of probe compensation adjustment	2-14
Figure 2-8: The AUTOSET button	2-15
Figure 3-1: The VERTICAL MENU button	3-3
Figure 3-2: The vertical menu	3-4
Figure 3-3: Inverting a waveform	3-5
Figure 3-4: The HORIZONTAL MENU button	3-6
Figure 3-5: The horizontal menu	3-6
Figure 3-6: The MATH button	3-8
Figure 3-7: A math waveform	3-9
Figure 3-8: The TRIGGER MENU button	3-11
Figure 3-9: The edge trigger menu	3-12
Figure 3-10: The video trigger menu	3-14
Figure 3-11: The video scan-rate menu	3-15
Figure 3-12: The MEASURE button	3-17
Figure 3-13: The measure menu and active measurements	3-18
Figure 3-14: The CURSOR button	3-22
Figure 3-15: The cursor menu	3-22
Figure 3-16: Paired cursor measurements of a sine wave	3-23
Figure 3-17: The ACQUIRE button	3-25
Figure 3-18: The acquire menu	3-25
Figure 3-19: The DISPLAY button	3-27
Figure 3-20: The display menu	3-27
Figure 3-21: System response to an impulse	3-32
Figure 3-22: Define FFT waveform menu	3-33

Figure 3-23: Cursor measurement of an FFT waveform	3-35
Figure 3-24: FFT time domain record vs. FFT frequency domain record	3-36
Figure 3-25: How aliased frequencies appear in an FFT	3-38
Figure 3-26: Windowing the FFT time domain record	3-39
Figure 3-27: The HARDCOPY button	3-41
Figure 3-28: The UTILITY button	3-42
Figure 3-29: The system I/O menu	3-42
Figure 3-30: The reference waveform buttons	3-45
Figure 3-31: A reference waveform menu	3-46
Figure 3-32: Save Format menu	3-48
Figure 3-33: The SAVE/RECALL button	3-51
Figure 3-34: The save/recall menu	3-51
Figure 3-35: File utilities	3-55
Figure 3-36: File system — Labelling menu	3-57
Figure 3-37: The UTILITY button	3-59
Figure 3-38: The utility pop-up menu	3-60
Figure 3-39: Date and time display	3-61
Figure A-1: TDS 340A, TDS 360, and TDS 380 dimensions	A-11
Figure B-1: Menu locations	B-2
Figure B-2: Hookup for DC voltage measurement accuracy check	B-6
Figure B-3: Hookup for analog bandwidth check	B-8
Figure B-4: Measuring analog bandwidth	B-9
Figure B-5: Hookup for sample rate check	B-10
Figure B-6: Hookup for trigger sensitivity check	B-12
Figure B-7: Measuring trigger sensitivity	B-13
Figure B-8: Hookup for sine wave generator leveling	B-15

List of Tables

Table 2-1: Autoset defaults	2-15
Table 3-1: Measurement definitions	3-19
Table A-1: Warranted characteristics — signal acquisition system .	A-1
Table A-2: Warranted characteristics — time base system	A-2
Table A-3: Warranted characteristics — triggering system	A-3
Table A-4: Power Requirements	A-3
Table A-5: Warranted characteristics — environmental	A-4
Table A-6: Typical characteristics — signal acquisition system	A-5
Table A-7: Typical characteristics — triggering system	A-6
Table A-8: Typical characteristics — probe compensator output ...	A-6
Table A-9: Typical characteristics — data handling	A-7
Table A-10: Nominal traits — signal acquisition system	A-7
Table A-11: Nominal traits — time base system	A-8
Table A-12: Nominal traits — triggering system	A-8
Table A-13: Nominal traits — display system	A-9
Table A-14: Nominal traits — I/O interface option	A-9
Table A-15: Nominal traits — power distribution system	A-9
Table A-16: Nominal traits — mechanical characteristics	A-10
Table A-17: Certifications and compliances	A-12
Table B-1: Test equipment	B-3
Table B-2: DC accuracy	B-7
Table C-1: VGA output connector pins	C-1
Table C-2: International power cords	C-1
Table C-3: Language options	C-2
Table C-4: Standard accessories	C-3
Table C-5: Optional accessories	C-3
Table C-6: Accessory cables	C-4

General Safety Summary

Review the following safety precautions to avoid injury and prevent damage to this product or any products connected to it. To avoid potential hazards, use the product only as specified.

Only qualified personnel should perform service procedures.

Injury Precautions

- | | |
|--|--|
| Use Proper Power Cord | To avoid fire hazard, use only the power cord specified for this product. |
| Avoid Electric Overload | To avoid electric shock or fire hazard, do not apply a voltage to a terminal that is outside the range specified for that terminal. |
| Avoid Electric Shock | To avoid injury or loss of life, do not connect or disconnect probes or test leads while they are connected to a voltage source. |
| Ground the Product | This product is grounded through the grounding conductor of the power cord. To avoid electric shock, the grounding conductor must be connected to earth ground. Before making connections to the input or output terminals of the product, ensure that the product is properly grounded. |
| Do Not Operate Without Covers | To avoid electric shock or fire hazard, do not operate this product with covers or panels removed. |
| Use Proper Fuse | To avoid fire hazard, use only the fuse type and rating specified for this product. |
| Do Not Operate in Wet/Damp Conditions | To avoid electric shock, do not operate this product in wet or damp conditions. |
| Do Not Operate in an Explosive Atmosphere | To avoid injury or fire hazard, do not operate this product in an explosive atmosphere. |

Product Damage Precautions

- Use Proper Power Source** Do not operate this product from a power source that applies more than the voltage specified.
- Provide Proper Ventilation** To prevent product overheating, provide proper ventilation.
- Do Not Operate With Suspected Failures** If you suspect there is damage to this product, have it inspected by qualified service personnel.

Safety Terms and Symbols

Terms in This Manual These terms may appear in this manual:



WARNING. *Warning statements identify conditions or practices that could result in injury or loss of life.*



CAUTION. *Caution statements identify conditions or practices that could result in damage to this product or other property.*

Terms on the Product These terms may appear on the product:

DANGER indicates an injury hazard immediately accessible as you read the marking:

WARNING indicates an injury hazard not immediately accessible as you read the marking.

CAUTION indicates a hazard to property including the product.

Symbols on the Product The following symbols may appear on the product:



DANGER
High Voltage



Protective Ground
(Earth) Terminal



ATTENTION
Refer to Manual



Double
Insulated

Certifications and Compliances

CSA Certified Power Cords

CSA Certification includes the products and power cords appropriate for use in the North America power network. All other power cords supplied are approved for the country of use.

Compliances

Consult the product specifications for Overvoltage Category and IEC Classifications.

Preface

This manual provides user information for the TDS 300 Two-Channel Digital Real-Time Oscilloscopes. The manual contains the following chapters and appendices:

- *Getting Started* contains a brief product description, information needed to power on the oscilloscope, and a brief procedure to verify that it functions.
- *Operating Basics* contains user interface, probe, and autoset information.
- *Reference* contains task-oriented descriptions of oscilloscope features. The features are described in order from most basic to more specialized.
- *Appendix A: Specifications* contains typical, nominal, and warranted specifications for the oscilloscope.
- *Appendix B: Performance Verification* contains procedures you can use to verify that oscilloscope is operating within warranted specifications.
- *Appendix C: Options and Accessories* describes other products that are useful with the oscilloscope.
- *Appendix D: General Care and Cleaning* describes how to care for and clean the oscilloscope.
- *Glossary* contains a glossary of terms.
- *Index* contains a full index.

Related Manuals

These other manuals are available for the TDS 300 Two-Channel Digital Real-Time Oscilloscopes:

- The *Reference* gives you a quick overview of how to operate your oscilloscope.
- *The XYZ's of Analog and Digital Oscilloscopes* provides introductory instruction on basic oscilloscope theory.
- The *Programmer Manual* provides complete information about controlling the oscilloscope through the Option 14 Communications Board.
- The *Service Manual* provides information to troubleshoot and repair the oscilloscope at the module level.

Getting Started

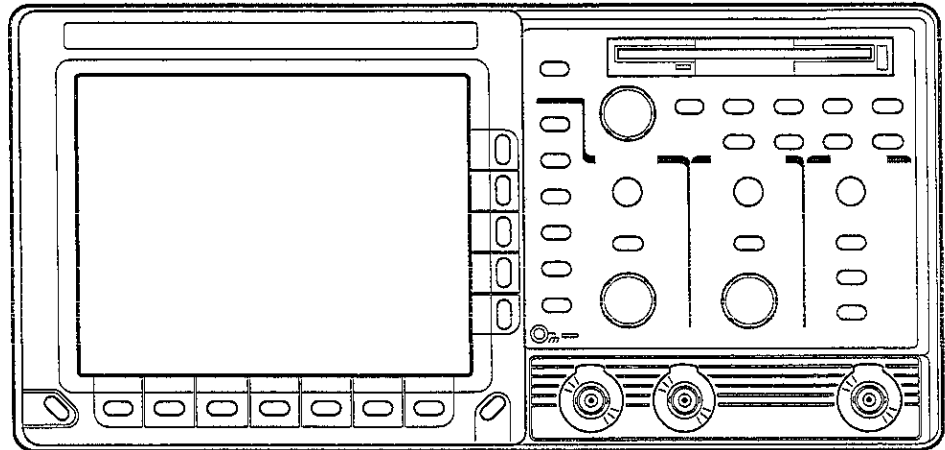

Tektronix TDS 340A, TDS 360, and TDS 380 oscilloscopes are digital signal processors and are superb tools for displaying and measuring waveforms. Their performance addresses the needs of both benchtop lab and portable applications with the following features:

- Two input channels, each with a record length of 1,000 samples and 8-bit vertical resolution. Both channels acquire waveforms simultaneously.
- 2 Gigasample/second maximum sample rate (TDS 380); 1 Gigasamples/second maximum sample rate (TDS 360); 500 Megasamples/second maximum sample rate (TDS 340A).
- 400 MHz analog bandwidth and fastest time base setting of 1 ns/div (TDS 380); 200 MHz analog bandwidth and fastest time base setting of 2.5 ns/div (TDS 360); 100 MHz analog bandwidth and fastest time base setting of 5 ns/div (TDS 340A).
- A full complement of advanced functions including on-screen readout, AUTOSET, cursors, continuously updated automatic measurements, and FFT.
- Waveform averaging, waveform enveloping, and hardware peak detection.
- Floppy disk drive for mass storage of waveforms, setups, and hard copies.
- A unique graphical user interface (GUI) and a logical front-panel layout which combine to deliver the standard in usability pioneered by the TDS family of oscilloscopes.

Start Up

To properly install and power on the oscilloscope, perform this procedure.

1. Check that you have the proper electrical connections. The rear label lists power requirements for all possible voltage inputs.
2. Check the fuse to be sure it is the proper type and rating (Figure 1-2). TDS 300 Series oscilloscopes are shipped with a UL-approved fuse installed.

Fuse specifications are as follows:

5 mm × 20 mm, time-lag, 3.15 A, 250 V, or

1.25 in × 0.25 in, time-lag, 3 A, 250 V

3. Connect the proper power cord from the rear-panel power connector (Figure 1-2) to the power system. Use the power cord clamp to secure the cord to the rear panel.
4. Leave space for cooling. Do this by verifying that the air-intake and exhaust holes on the sides and bottom of the cabinet (where the fan operates) are free of any airflow obstructions. Leave at least 5.1 cm (2 in) free on each side.
5. Press the ON/STBY button to power up the oscilloscope (see Figure 1-1).

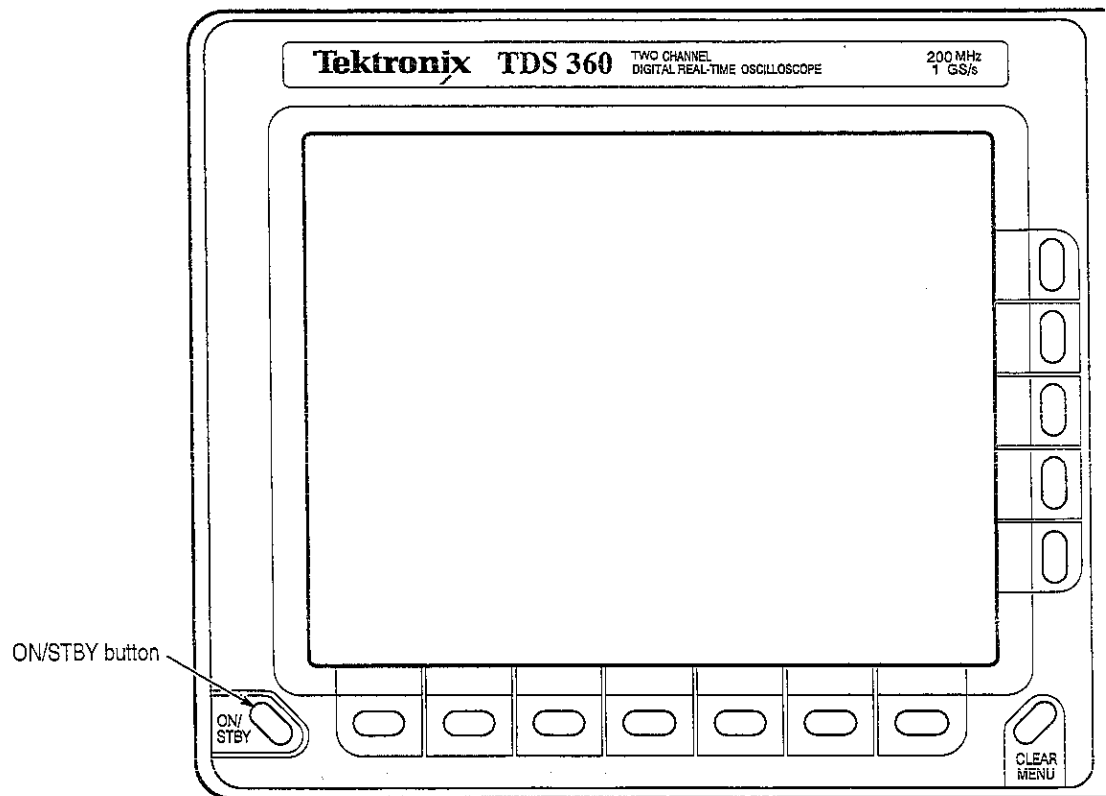

Figure 1-1: The ON/STBY button

Line Fuse Replacement



WARNING. To avoid injury or death, unplug the line cord from the line voltage power source before continuing.

1. Have handy a flat-bladed screwdriver.
2. Set the oscilloscope so its bottom is down on the work surface and its rear is facing you.
3. Find the line cord on the rear cover. (See Figure 1-2.) Unplug the line cord from its receptacle.
4. Find the fuse drawer beneath the line-voltage plug on the rear panel. Now, pry open the drawer with a small flat-bladed screwdriver, and remove the line fuse. (See Figure 1-2.)

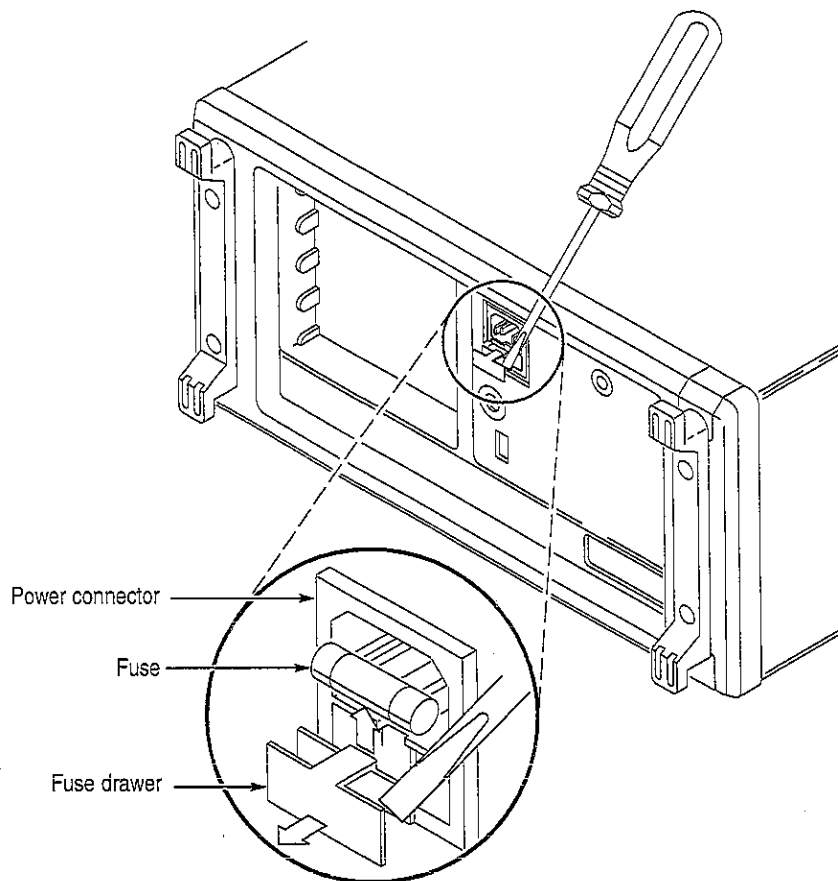

Figure 1-2: Line fuse removal

5. *Reinstallation:* Do in reverse steps 4 through 2 to reinstall the line fuse and then the line cord.

Self Test

This procedure uses internal routines to verify that the oscilloscope functions and passes its internal self tests and signal-path compensations. It also confirms that the oscilloscope was adjusted properly at the time it was last adjusted. No test equipment or hookups are required.

Equipment Required: None.

Time Required: Approximately 5 minutes.

Prerequisites: Power up the oscilloscope and allow a 20 minute warm up before doing this procedure.

Procedure:

1. Press the front-panel button **UTILITY**.
2. Press the main-menu button **System** to select **Diag**.
3. Press the main-menu button **Execute** and then press the side-menu button **OK Confirm Run Test**. The internal diagnostics verify proper oscilloscope function. This verification takes about 30 seconds. While it progresses, a variety of test patterns flash on screen. When finished, status messages appear on the screen.
4. Check that the screen reports no failures. If it reports a failure, the oscilloscope has failed the self test. Contact your Tektronix representative for assistance.
5. Press **CLEAR MENU**.
6. Press **UTILITY** and then press the main-menu button **System** to select **Cal**.
7. Check that the word **Pass** appears in the main menu under the **Voltage Reference**, **Timing**, and **Ext Trig** menu labels. (See Figure 1-3.) If any of the labels read **Fail**, the oscilloscope has failed the self test. Contact your Tektronix representative for assistance.

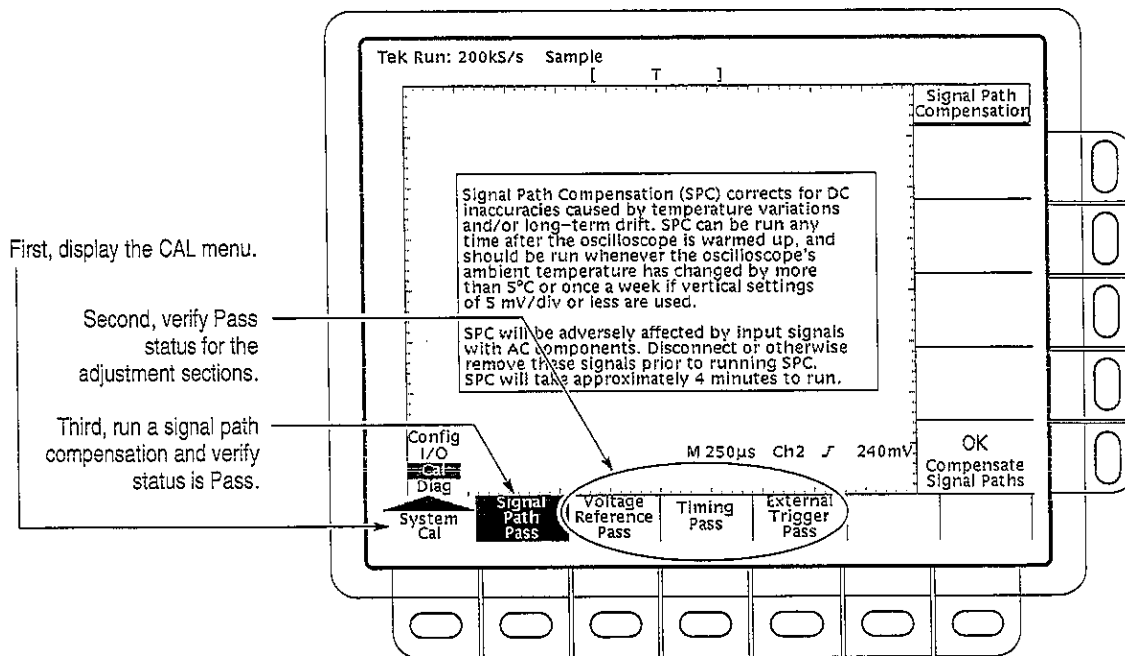

Figure 1-3: Verifying adjustments and signal path compensation

8. Press Signal Path and then press the side menu button OK Compensate Signal Paths. When compensation completes, the status message updates to Pass or Fail in the main menu
9. Check that the word Pass appears under Signal Path in the main menu. (See Figure 1-3.) If Pass does not appear, the oscilloscope has failed the performance verification; return it to Tektronix for servicing.

Functional Test

The purpose of this procedure is to confirm that the oscilloscope functions properly.

NOTE. This procedure verifies functions; that is, it verifies that oscilloscope features operate. It does not verify that they operate within limits. Therefore, when the instructions that follow call for you to verify that a signal appears on-screen "that is about five divisions in amplitude" or "has a period of about six horizontal divisions," do NOT interpret the quantities given as limits. Operation within limits is checked in the performance tests, which begin on page B-5.

DO NOT make changes to the front-panel settings that are not called out in the procedure. If you make changes to these settings other than those called out in the procedure, you may obtain invalid results. In this case, just redo the procedure from step 1.

Equipment Required: One P6109B (TDS 340A), P6111B (TDS 360), or P6114B (TDS 380) probe.

Time Required: Approximately 5 minutes.

Prerequisites: None.

Procedure:

1. Install the probe on CH 1. Connect the probe tip to PROBE COMP on the front panel; leave the probe ground unconnected. (See Figure 1-4.)

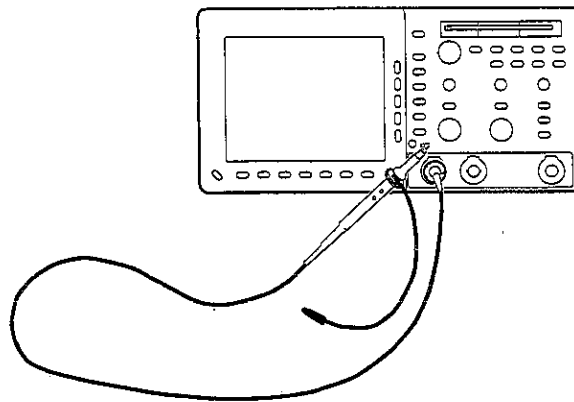

Figure 1-4: Hookup for functional test

2. Press the front-panel button SAVE/RECALL, the main-menu button Recall Factory Setup, and then the side-menu button OK Confirm Factory Init.
3. Press AUTOSSET.
4. Set the VOLTS/DIV to 1 V. Use the vertical POSITION knob to center the waveform vertically on screen.
5. Set the SEC/DIV to 250 μ s.
6. Check that a square wave probe-compensation signal of about five divisions in amplitude is on screen.
7. Check that one period of the square wave probe-compensation signal is about four horizontal divisions on screen.
8. Check that the horizontal POSITION knob positions the signal left and right on screen when rotated.
9. Press the front-panel button TRIGGER MENU, the main-menu button Mode, and then the side-menu button Normal.
10. Check that the trigger-level readout for the main trigger system changes with the trigger LEVEL knob.
11. Check that the trigger-level knob can trigger and untrigger the square-wave signal as you rotate it. (Leave the signal *untriggered*.)
12. Check that pressing SET LEVEL TO 50% triggers the signal that you just left untriggered.
13. Press the front-panel button ACQUIRE, the main-menu button Mode, and then the side-menu button Sample.
14. Check that the oscilloscope displays an actively acquiring waveform on-screen. (Note that there is noise present on the peaks of the square wave.)
15. Press the side-menu button Peak Detect. Check that the oscilloscope displays an actively acquiring waveform on screen with the noise "peak detected."
16. Press the side-menu button Envelope. Check that the oscilloscope displays an actively acquiring waveform on screen with the noise displayed.
17. Press the side-menu button Average. Check that the oscilloscope displays an actively acquiring waveform on screen with the noise reduced.

18. Press WAVEFORM OFF to remove Channel 1 from the display.
19. Press CH 2 and move the probe to the CH 2 input.
20. Repeat steps 3 through 17 for Channel 2.
21. Disconnect the probe from the channel input and the PROBE COMP terminal.

Operating Basics

This chapter begins with eight illustrations that identify and describe each control and connector on the TDS 300 Series oscilloscope. Next, *Operating Basics* covers these additional topics:

- Using the menu system
- Using probes
- Using autoset

Display and Power Controls

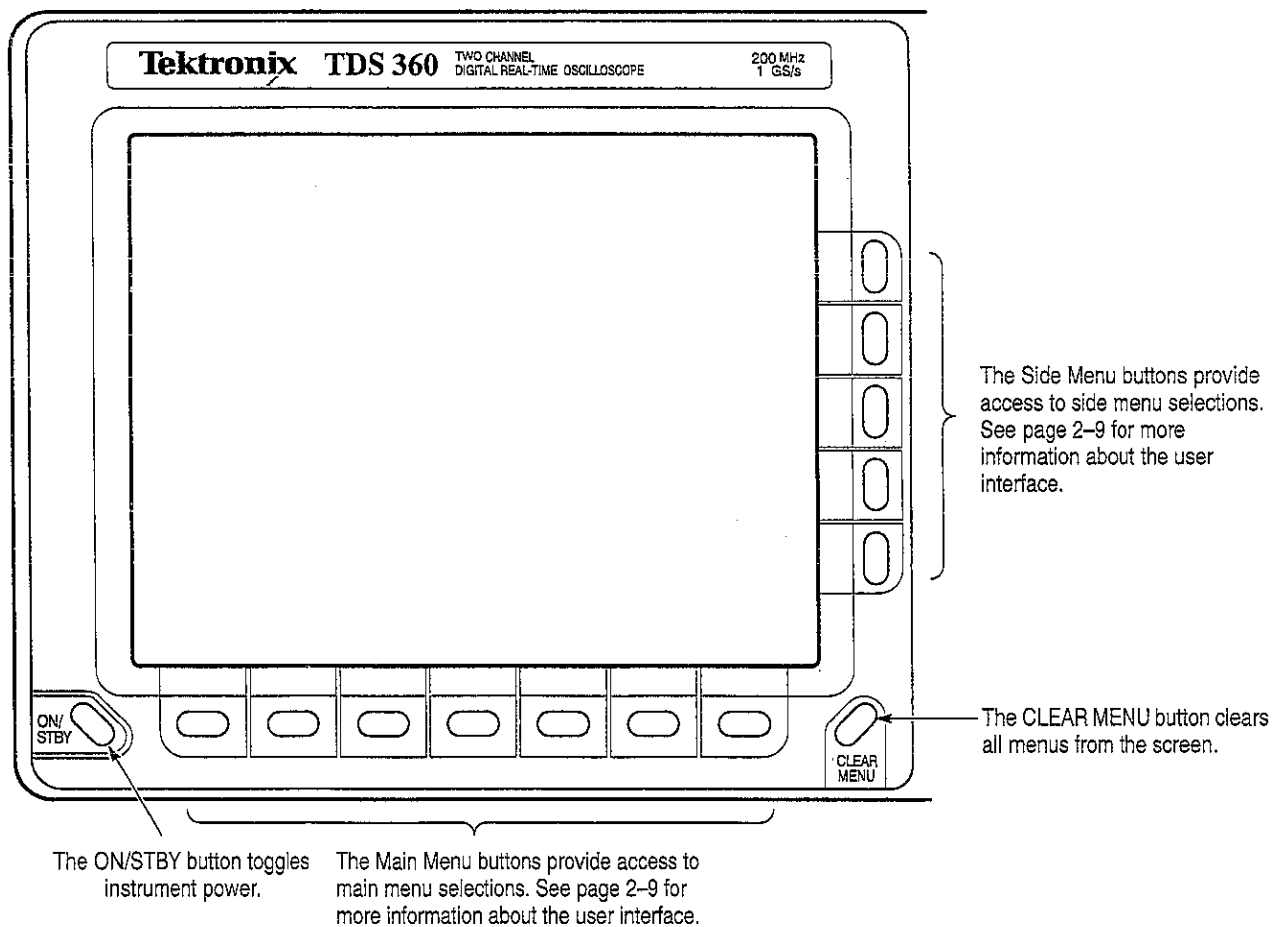

Vertical Controls

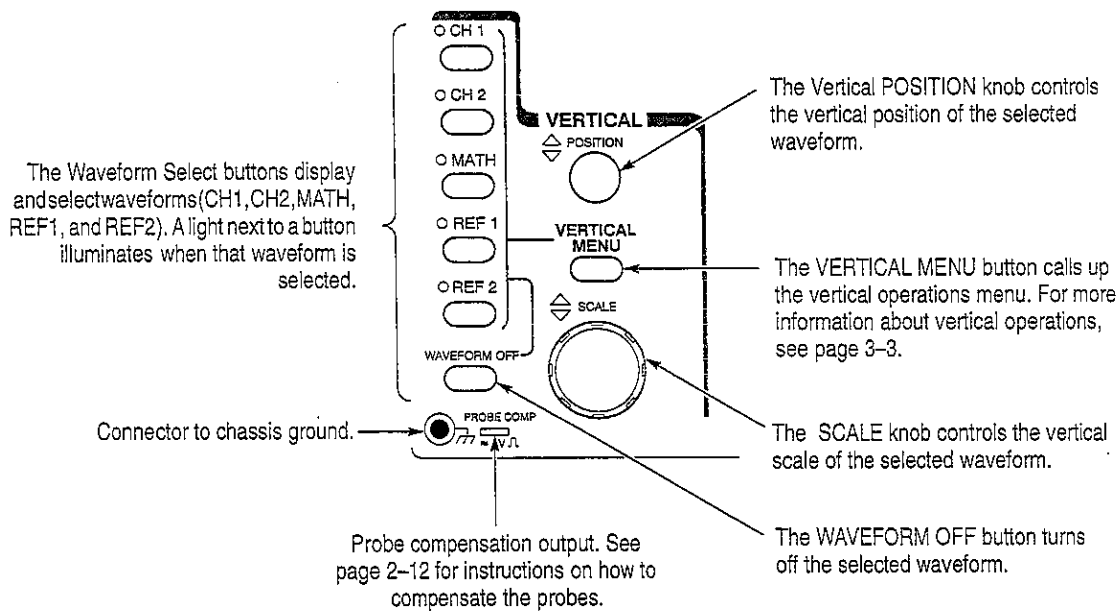

Horizontal Controls

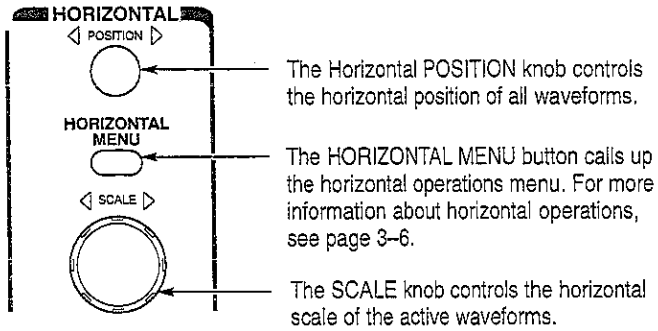

Trigger Controls

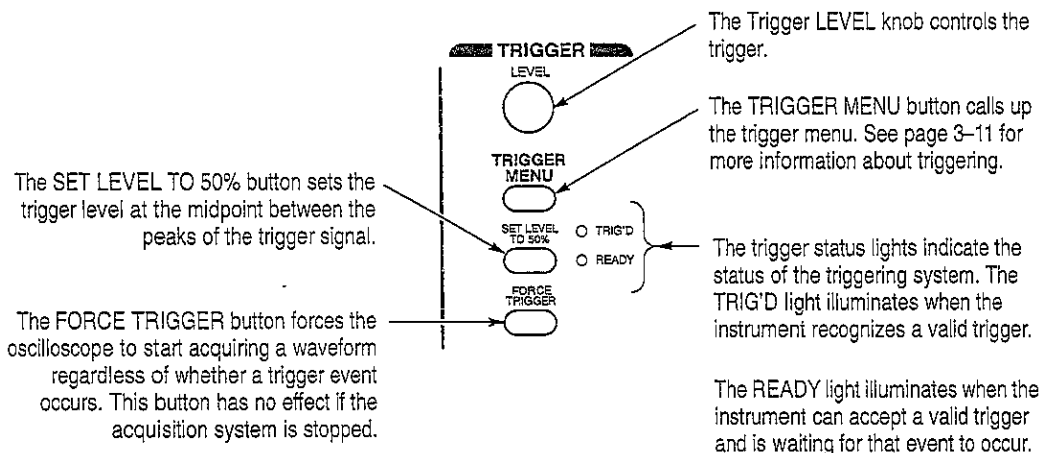

Miscellaneous Controls

The MEASURE button calls up the automated measurements menu. See page 3-17 for more information about automated measurements.

The UTILITY button calls up the utility menu. See page 3-59 for more information about utilities.

The AUTOSSET button automatically sets up the instrument to produce a usable display of the input signals. See page 2-15 for more information about the autosest function.

The floppy disk drive provides mass storage for waveforms, setups, and hard copies.

The RUN/STOP button starts and stops acquisition.

The HARDCOPY button starts print operations. See page 3-41 for more information about making hard copies.

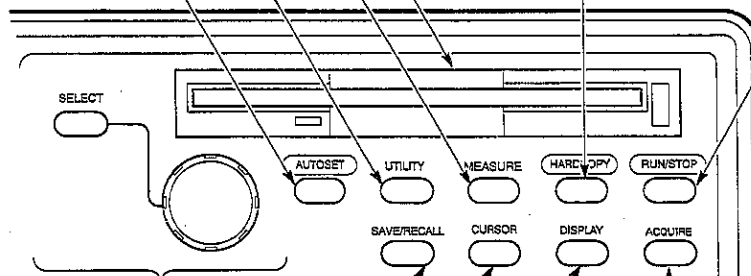

The General Purpose Knob controls many side-menu functions, including the cursors. The SELECT button switches control from cursor to cursor.

The SAVE/RECALL button calls up the save/recall menu. See page 3-45 for more information about saving and recalling waveforms. See page 3-51 for more information about saving and recalling setups.

The CURSOR button calls up the cursor menu. See page 3-21 for information about making measurements with cursors.

The DISPLAY button calls up the display menu. See page 3-27 for information about controlling the display.

The ACQUIRE button calls up the acquisition menu. See page 3-25 for more information about controlling acquisition.

Display Map

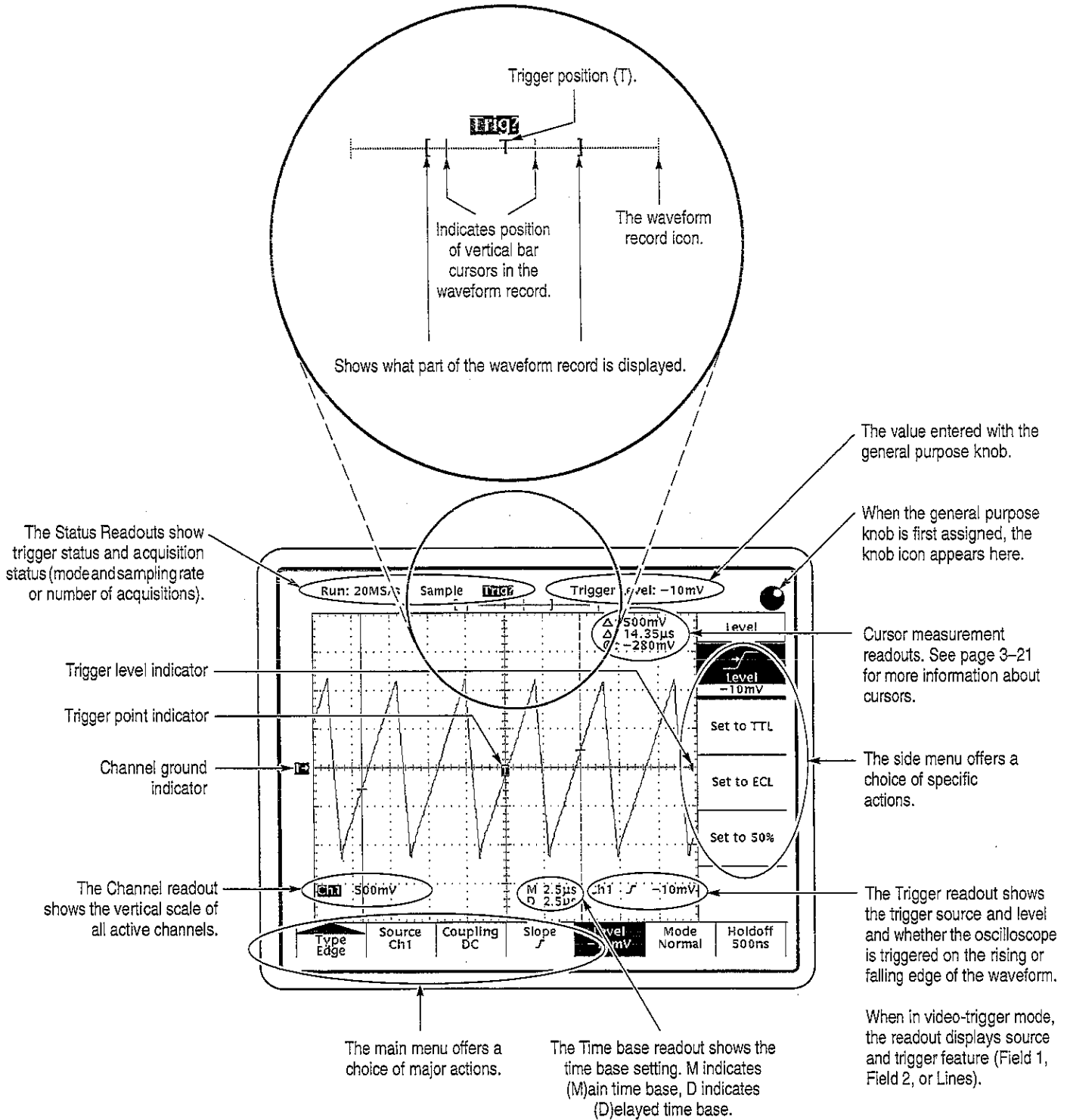

Inputs

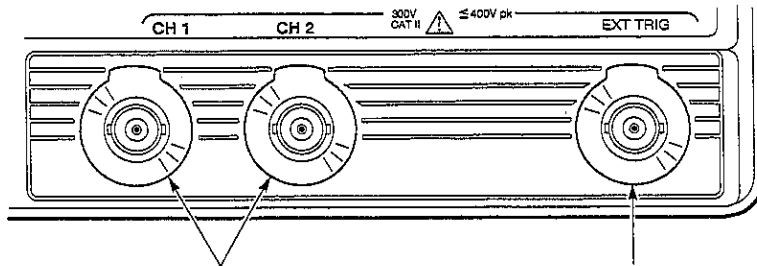

The channel BNC inputs (CH1 and CH2) accept electrical signals for display.

The EXT TRIG input accepts external trigger signals. See page 3-12 for more information about external triggering.

Rear-Panel Connectors

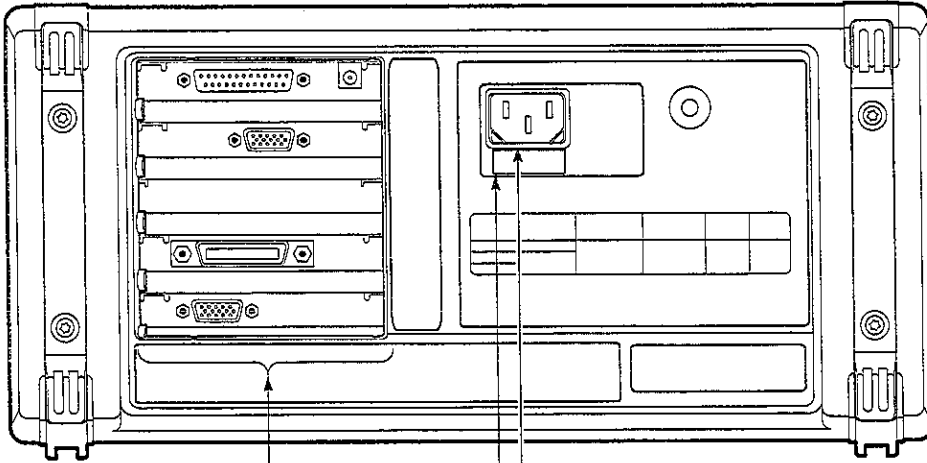

The Option 14 Panel (Option 14 instruments only) allows access to three communications interfaces: a Centronics parallel port, an RS-232 interface, and a GPIB interface. It also includes a VGA video-compatible output port and a power connector for the optional TDS4F5P printer upgrade kit.

You can use the Centronics, RS-232, and GPIB interfaces to transmit hardcopy data; see page 3-41 for hard copy procedures.

You can use the GPIB and RS-232 interfaces to operate and program the oscilloscope from a GPIB controller; refer to the *TDS 340A*, *TDS 360 & TDS 380 Programmer Manual* for more information.

The power connector accepts line voltage to power the instrument. See page C-1 for a list of power cord and connector options.

The fuse drawer holds the line fuse. See page 1-3 for fuse replacement procedures.

Using the Menu System

TDS 300 Series oscilloscopes use an intuitive user interface. This interface reduces front-panel clutter while allowing easy access to specialized functions through the menu structure.

The procedure on page 2-10 illustrates how to navigate in the menu structure. If you are unfamiliar with this menu system, you may want to run through the procedure several times to learn how you can access functions and subfunctions. Refer to Figure 2-1 as necessary.

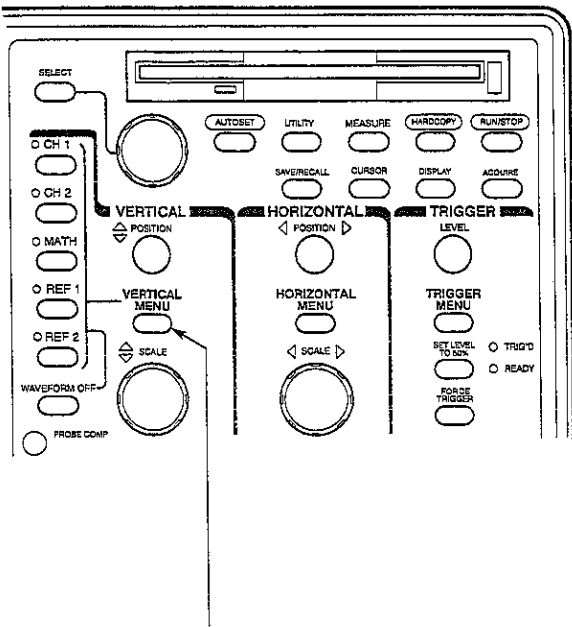

1 Press any of the front-panel menu buttons.

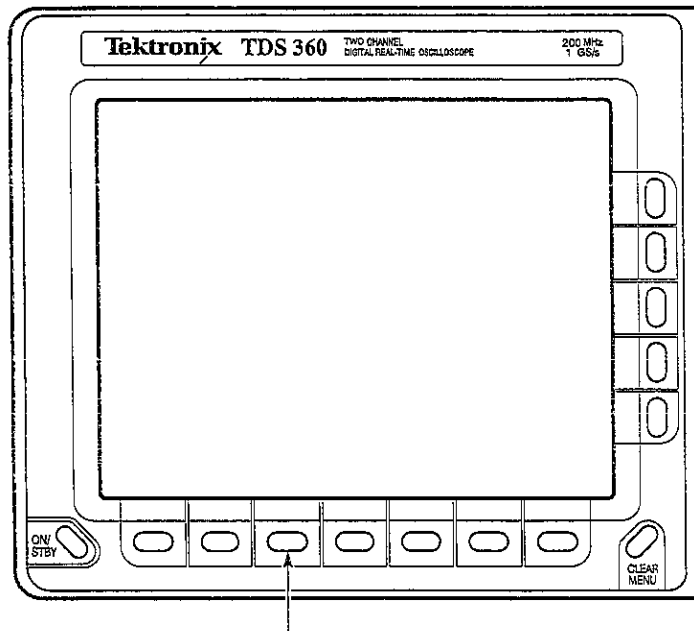

2 Select an item from the main (bottom) menu or use leftmost button to pop up selections.

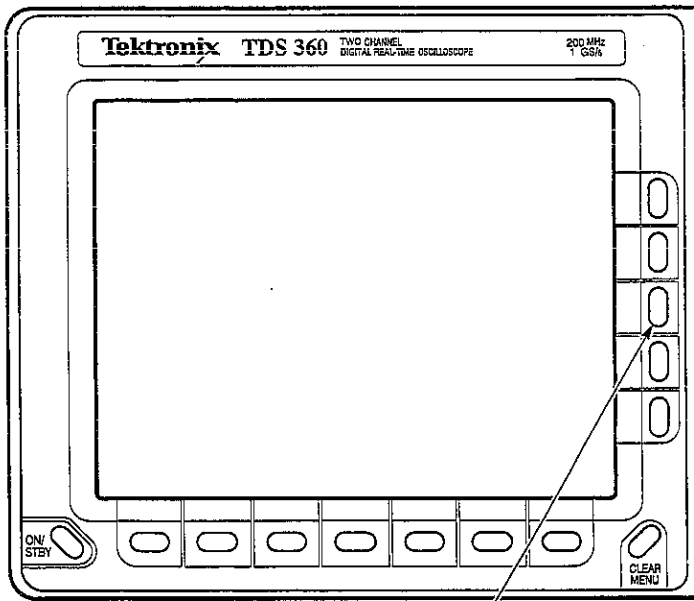

3 Select an item from the side menu, if displayed.

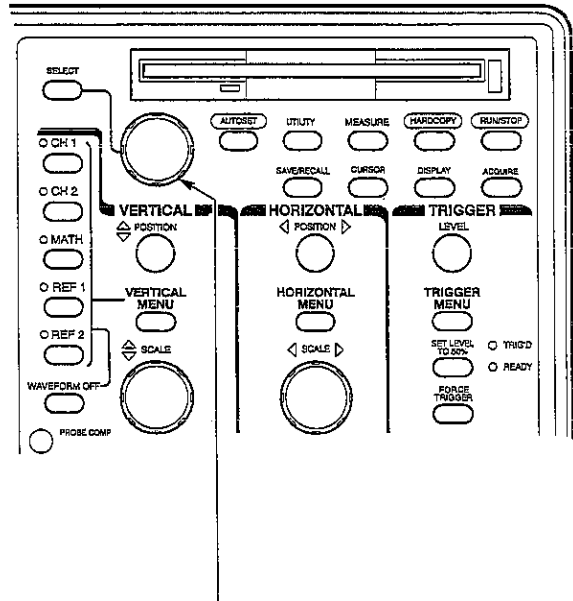

4 Adjust menu item values with general purpose knob.

Figure 2-1: Using menus

1. Push one of the indicated front-panel buttons to call up a menu of functions. This first menu is the *main menu*. Sometimes the main menu will be a side menu (step 3), but most main menus are bottom menus.

2. Push a bottom menu button to select a function. One of three things result:
 - If the function has no subfunctions, it becomes active. If it is a variable function, you can now use the General Purpose Knob to adjust it (step 4).
 - If the function has subfunctions, they appear on the side menu (step 3).
 - The leftmost bottom menu button sometimes activates a pop-up menu (as shown in Figure 2–2). You can cycle through the pop-up menu options by repeatedly pressing the button. Each selection calls up different bottom and side menus.

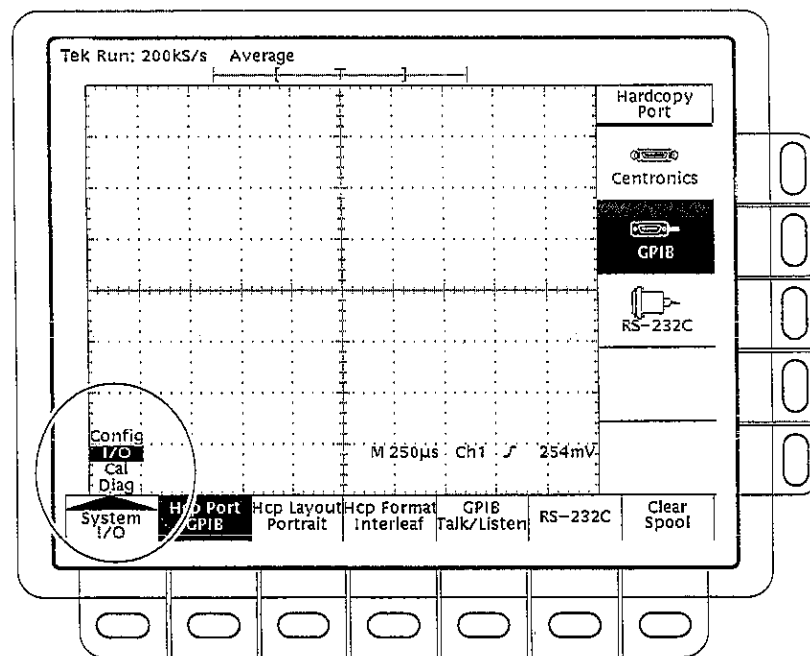

Figure 2–2: A pop-up menu

3. Push a side-menu button to select a subfunction.
4. Use the General Purpose Knob to alter variable-function or subfunction settings.
5. Press the CLEAR MENU button to remove a menu from the screen.

Using the Probes

The TDS 340A, TDS 360, and TDS 380 come with two standard-accessory probes. Use these probes to conduct signals to the oscilloscope. For detailed probe specifications and instructions, see the instruction manual packaged with the probe.

Connecting a Probe

To connect a probe to the oscilloscope, attach the BNC end of the probe to either the CH 1 or CH 2 input. Be sure to twist the probe end clockwise until the BNC is fully locked. See Figure 2-3.

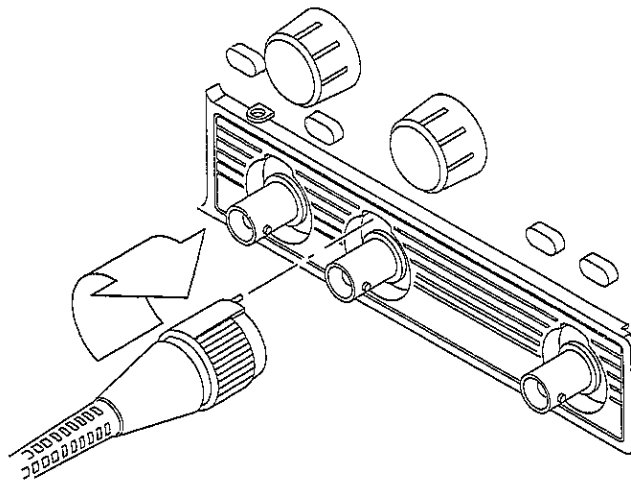

Figure 2-3: Connecting a probe

Compensating a Probe

Use the following procedure to compensate the probe every time you set up your oscilloscope.

1. Attach the probe BNC connector to the CH 1 input and attach the probe tip to the PROBE COMP output signal as shown in Figure 2-4. Attach the probe ground clip to the outer ring of the CH 2 BNC.

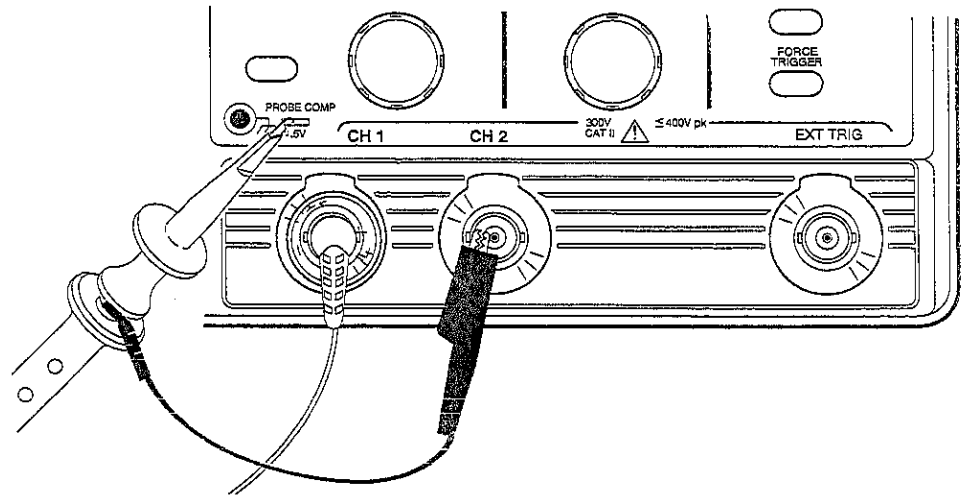

Figure 2-4: Probe compensation setup

2. Press AUTOSET. The oscilloscope displays the compensation waveform. It should resemble the waveform shown in Figure 2-5.

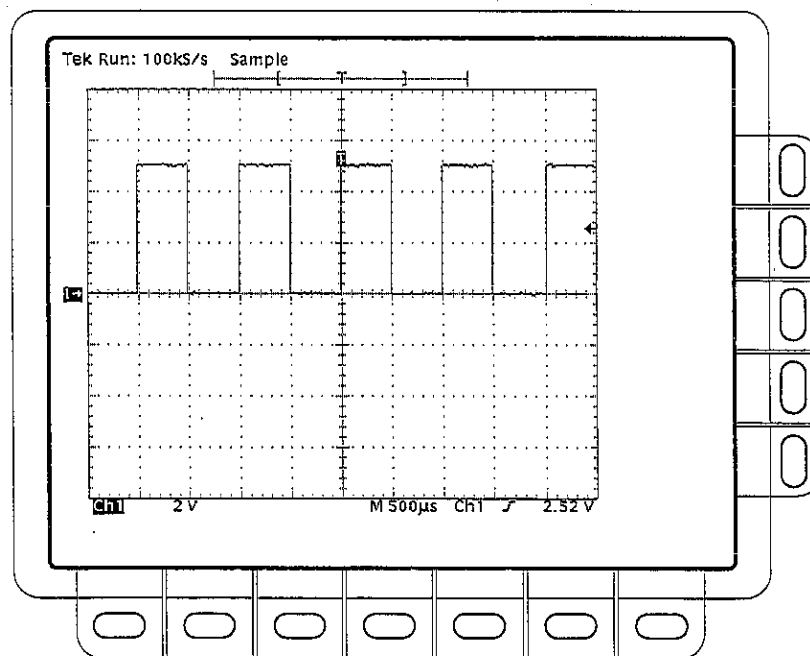

Figure 2-5: Compensation waveform

3. Check that the waveform indicates correct compensation (see Figure 2-6). If the waveform indicates over or undercompensation, use the alignment tool provided with the probe to adjust the compensation as shown in Figure 2-7.

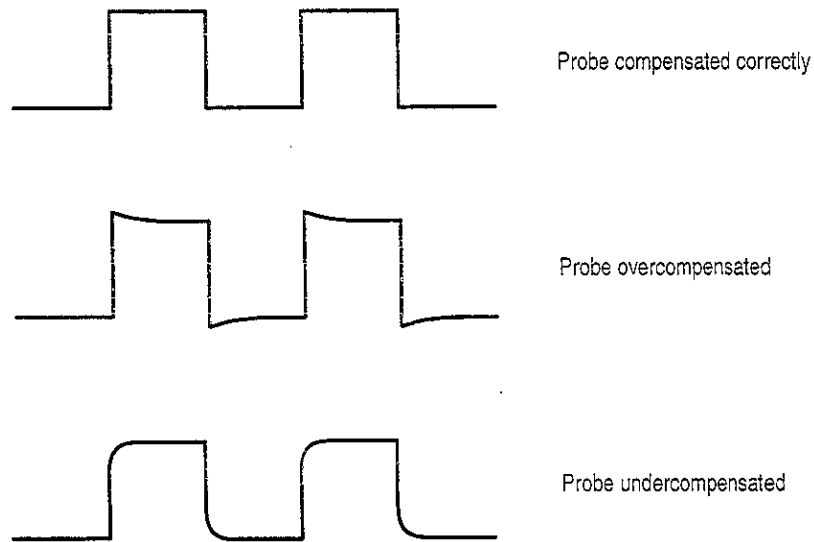

Figure 2-6: How probe compensation affects signals

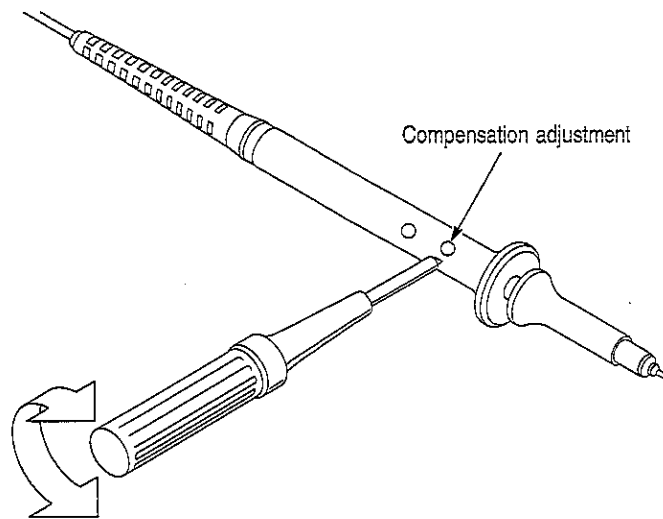

Figure 2-7: Location of probe compensation adjustment

Using Autoset

The TDS 300 Series autoset feature produces a stable, triggered display of almost any input signal. To use autoset, connect a signal to either the CH 1 or CH 2 input connector, and press the AUTOSSET button (shown in Figure 2-8).

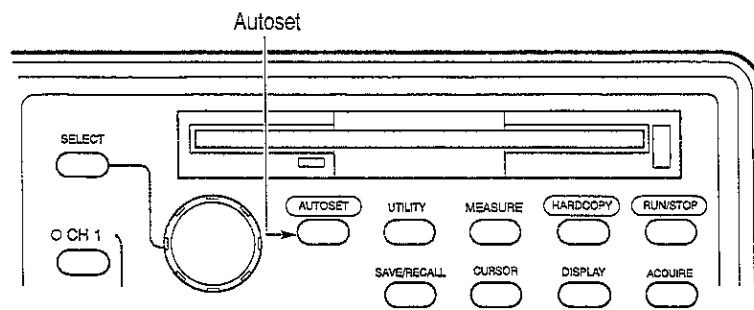

Figure 2-8: The AUTOSSET button

Table 2-1 specifies the changes autoset makes in your oscilloscope setup.

Table 2-1: Autoset defaults

Control	Changed by autoset to
Selected channel	If none already displayed, numerically lowest of the displayed channels
Acquire Mode	Sample
Acquire Stop After	RUN/STOP button only
Display Style	Vectors
Display Intensity — Overall	If less than 50%, set to 75%
Display Format	YT
Horizontal Position	Centered within the graticule window
Horizontal Scale	As determined by the signal frequency
Horizontal Time Base	Main Only
Trigger Position	Unchanged
Trigger Type	Edge
Trigger Source	Numerically lowest of the displayed channels (the selected channel)
Trigger Level	Midpoint of data for the trigger source
Trigger Slope	Positive
Trigger Coupling	DC

Table 2-1: Autoset defaults (Cont.)

Control	Changed by autoset to
Trigger Holdoff	500 ns
Vertical Scale	As determined by the signal level
Vertical Coupling	DC unless AC was previously set; AC remains unchanged
Vertical Bandwidth	Full
Vertical Offset	0 volts

Introduction

This chapter describes common tasks where you can use the TDS 300 oscilloscope. The tasks listed below are in a functional order, starting with the most basic and then moving to the more specialized:

- Manipulating Waveforms
- Triggering
- Taking Measurements
- Controlling Acquisition
- Controlling the Display
- Using the FFT
- Making Hard Copies
- Saving and Recalling Waveforms
- Saving and Recalling Setups
- Using the File System
- Using the Utility Menu

Manipulating Waveforms

There are two basic ways to manipulate waveforms acquired by TDS 300 Series oscilloscopes.

- You can change their display parameters with the vertical and horizontal systems
- You can add, subtract, and multiply them with the waveform math feature

Vertical Operations

To access the vertical-system features, press the VERTICAL MENU button, shown in Figure 3-1.

NOTE. The VERTICAL MENU button calls up the vertical menu only if a channel waveform (CH 1 or CH 2) is selected. If a math or reference waveform is selected, the VERTICAL MENU button calls up the math or reference waveform menu.

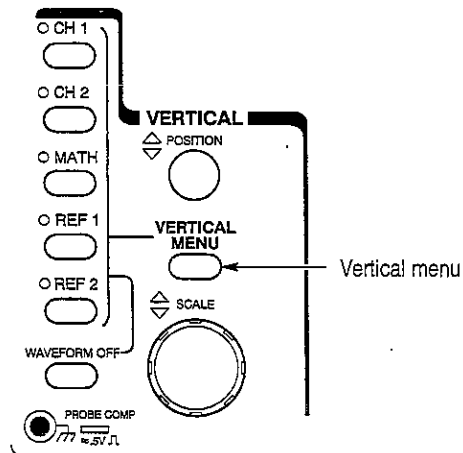

Figure 3-1: The VERTICAL MENU button

Figure 3–2 shows the vertical menu.

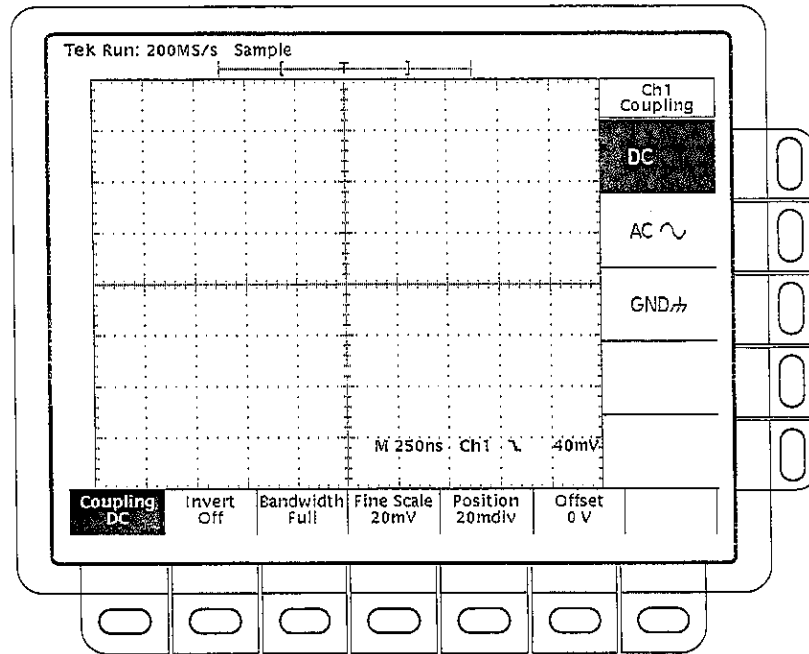

Figure 3–2: The vertical menu

Use the vertical menu to perform these tasks.

Select Input Coupling

Press the main-menu button Coupling. Use the side menu to select DC, AC, or ground (GND) coupling.

Invert a Waveform

Press the main-menu button Invert. Use the side menu to turn invert off and on. When you turn invert on, the selected waveform “flips” (reverses polarity) around the zero volt axis. Figure 3–3 shows an inverted pulse signal.

NOTE. Invert flips the waveform, but it does not alter the trigger level accordingly. To obtain a stable trigger after inverting a waveform, press SET LEVEL TO 50%.

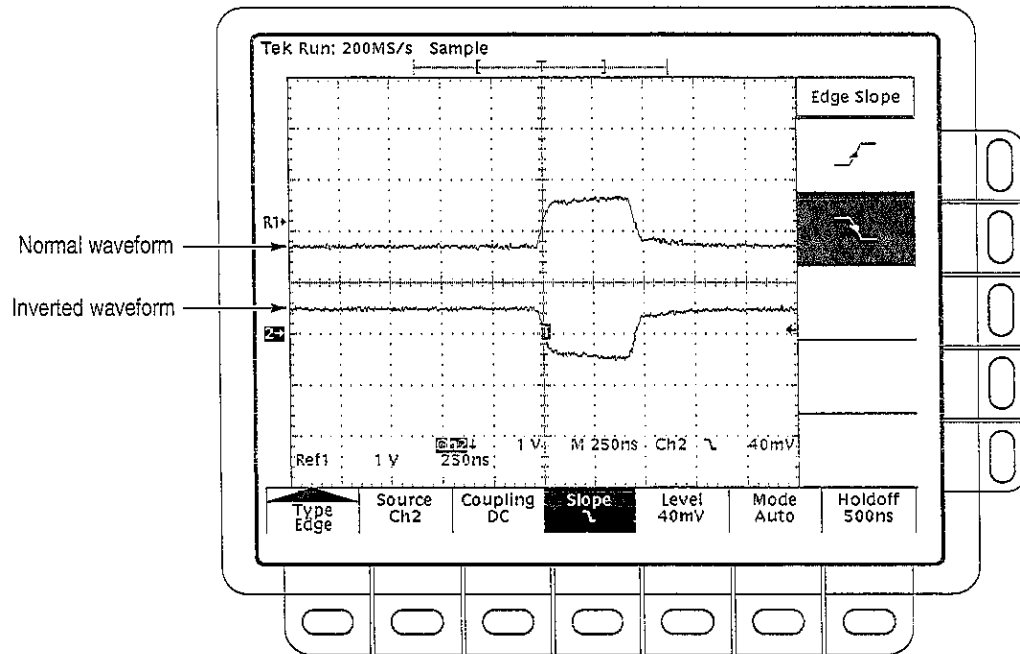

Figure 3-3: Inverting a waveform

Select Bandwidth Press the main-menu button Bandwidth. Use the side menu to switch between 20 MHz and full bandwidth.

Make Fine V/div Adjustments Press the main-menu button Fine Scale to activate the General Purpose Knob. Then use the knob to make precise adjustments to the vertical scale setting.

Adjust Vertical Position Press the main-menu button Position to activate the General Purpose Knob. Then, use the knob to adjust vertical position or use the side menu to set the vertical position to 0 divisions. Vertical position is limited to a range of ± 5 divisions.

NOTE. This selection performs the same function as the vertical POSITION knob.

Adjust Vertical Offset Press the main-menu button Offset to activate the General Purpose Knob. Then use the knob to adjust offset or use the side menu to set the offset to 0 V. Offset performs a function similar to the vertical POSITION knob, but it has a wider range. Use offset to view a waveform that has a large DC bias.

Horizontal Operations

To access horizontal system features, press the HORIZONTAL MENU button, shown in Figure 3-4. Figure 3-5 shows the horizontal menu.

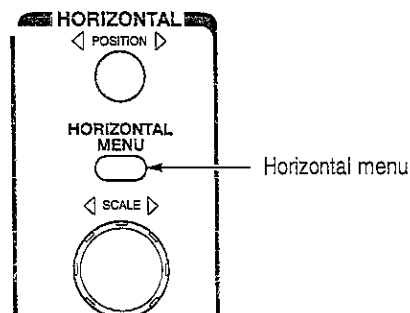

Figure 3-4: The HORIZONTAL MENU button

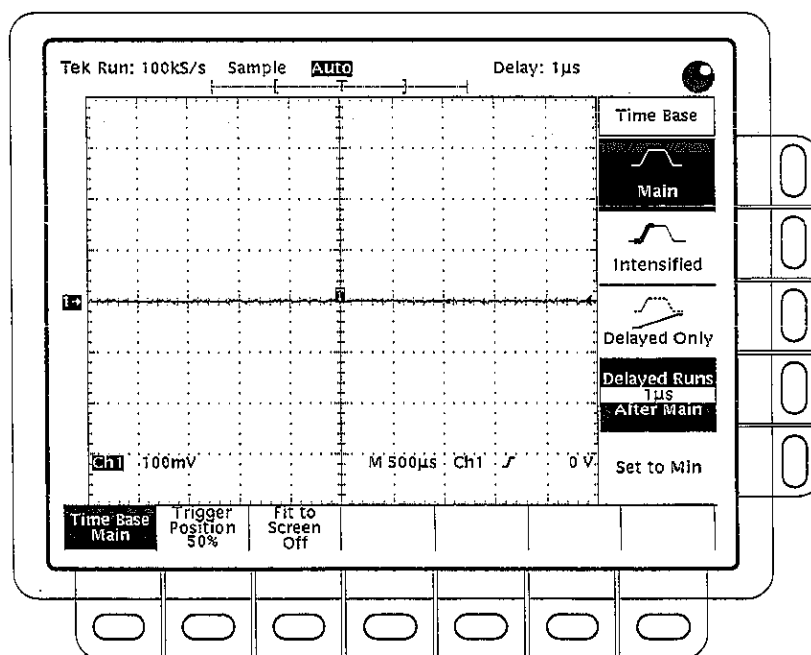

Figure 3-5: The horizontal menu

Use the horizontal menu to perform these tasks.

Select the Time Base

Press the main-menu button Time Base. Use the side menu to select from these options:

- Press Main Only to show only the main time base.
- Press Intensified to show both the main and delayed time bases. The oscilloscope intensifies a portion of the waveform; this intensified zone indicates the location of the delayed time base with respect to the main. Use the horizontal SCALE knob to change the length of the zone and the General Purpose Knob to change its position.
- Press Delayed Only to show only the delayed time base.
- Use the General Purpose Knob to adjust the delay time (the interval between the main and delayed time bases). You adjust the delay time in coarse increments when Main Only or Intensified are selected and in fine increments when Delayed Only is selected. The side menu selection Delayed Runs After Main shows the delay time.
- Press Set to Min to set the delay time to its minimum value.

Adjust Trigger Position

Press the main-menu button Trigger Position. Use the General Purpose Knob to adjust horizontal trigger position or use the side menu to set the trigger position to near the beginning, middle, or end of the waveform record. (The TDS 380 maximum pretrigger is 75%.)

Select Fit to Screen

Press the main-menu button Fit to Screen. Use the side menu to select from these options:

- Press Off to display 500 points of the 1000-point waveform record. The waveform record icon, described on page 2-6, shows the location of the displayed portion of the waveform record. Use the horizontal POSITION knob to adjust the portion of the waveform record to display.
- Press On to display the entire 1000-point waveform record. If you use this setting to display FFT math waveforms, you can view a complete frequency spectrum, from DC to the Nyquist frequency.

Displaying Math Waveforms

A TDS 300 Series oscilloscope performs math operations on one or both channel waveforms. Using one channel waveform, the oscilloscope can calculate a Fast Fourier Transform (FFT) to display the frequency content of a signal. Using both channel waveforms, the oscilloscope can add or multiply them or subtract one from the other and display the result as a math waveform.

To activate the math waveform, press the MATH button, shown in Figure 3-6.

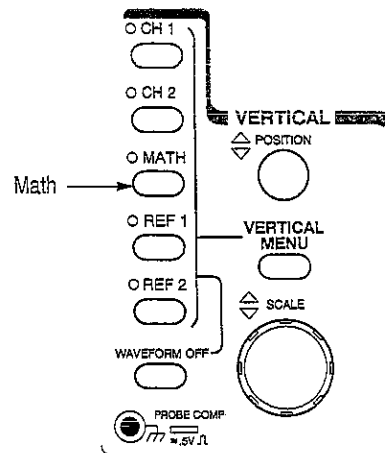

Figure 3-6: The MATH button

To choose one of the arithmetic math functions, select a formula from the side menu (Ch1 + Ch2, Ch1 - Ch2, Ch2 - Ch1, or CH1 * Ch2). Figure 3-7 shows a square wave on Channel 2 added to a sine wave on Channel 1. For more information about the FFT math function, refer to the section *Using the FFT* on page 3-31.

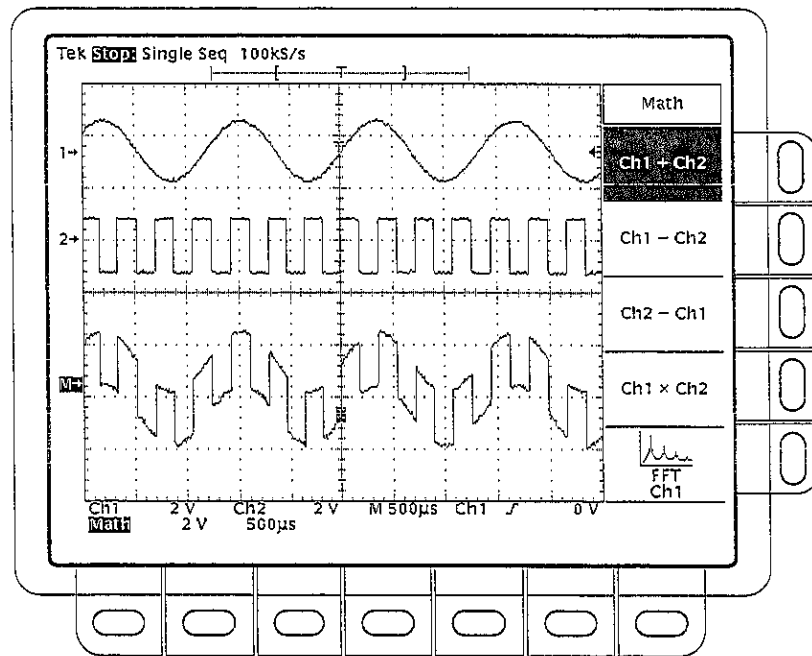

Figure 3-7: A math waveform

Triggering

TDS 300 Series oscilloscopes have two triggers: a standard edge trigger and a video trigger. To access trigger settings and features, press the TRIGGER MENU button, shown in Figure 3-8.

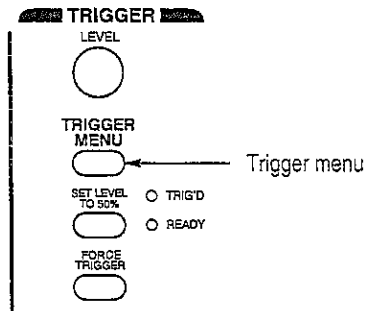

Figure 3-8: The TRIGGER MENU button

This button calls up one of two menus: the edge trigger menu or the video trigger menu. Press the leftmost main-menu button to switch between the two trigger menus.

Edge Triggering

The edge trigger triggers on the rising or falling edge of the input signal. You can access edge-trigger settings through the edge trigger menu, shown in Figure 3-9. Be sure the leftmost main menu selection indicates Type Edge.

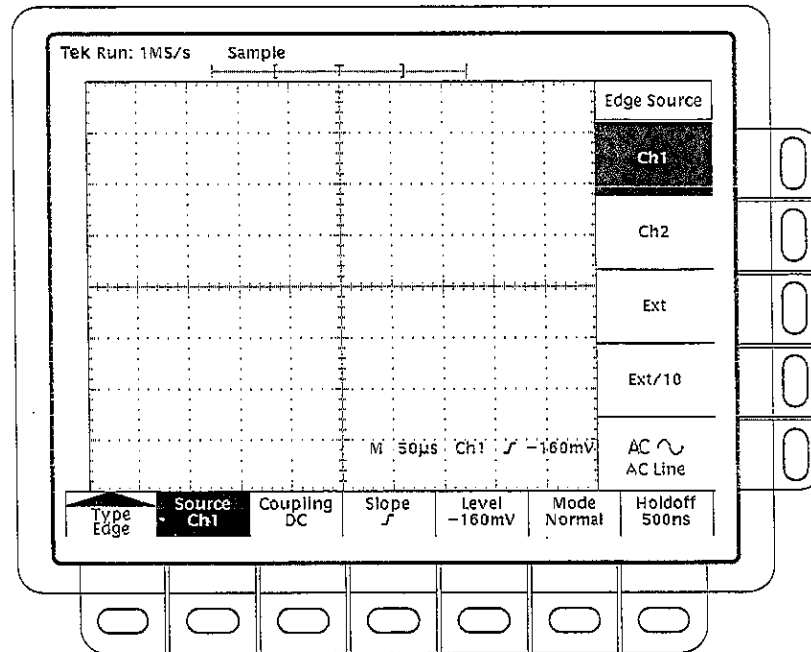

Figure 3-9: The edge trigger menu

Use the edge trigger menu to perform these tasks.

Select the Trigger Source

Press the main-menu button Source. Use the side menu to select from these options:

- Press Ch1 or Ch2 to set the trigger source to one of the input channels.
- Press Ext or Ext/10 to set the trigger source to the EXT TRIG input on the front panel. Ext/10 attenuates the external input signal by a factor of ten. Note that while the instrument can trigger on external trigger signals, it cannot display them.
- Press AC to set the trigger source to the oscilloscope line voltage signal.

Select Trigger Coupling

Press the main-menu button Coupling. Use the side menu to select from these options:

- Press DC to select DC coupling.
- Press AC to select AC coupling.
- Press HF Reject to select high-frequency reject mode. High-frequency rejection removes the high-frequency portion of the triggering signal. This

allows only the low-frequency components to pass on to the triggering system. High-frequency reject mode attenuates signals above 30 kHz.

- Press LF Reject to select low-frequency reject mode. Low-frequency rejection is the opposite of high-frequency rejection. Low-frequency reject mode attenuates signals below 80 kHz.
- Press Noise Reject to select noise reject mode. Noise rejection provides DC low sensitivity, but it requires additional signal amplitude for stable triggering.

Change Trigger Slope Press the main-menu button Slope. Use the top two side-menu buttons to switch between positive-going and negative-going slope.

Adjust Trigger Level Press the main-menu button Level. Use the side menu to select from these options:

- Use the General Purpose Knob to adjust trigger level. (Note that this selection performs the same function as the trigger LEVEL knob on the front panel.)
- Press Set to TTL to automatically set the trigger level to the TTL switching threshold.
- Press Set to ECL to automatically set the trigger level to the ECL switching threshold.
- Press Set to 50% to set the trigger level to the midpoint of the trigger source signal. (Note that this selection performs the same function as the SET LEVEL TO 50% button on the front panel.)

Select Trigger Mode Press the main-menu button Mode. Use the side menu to select either Auto or Normal mode.

In normal trigger mode, the oscilloscope waits for a valid trigger from the trigger signal source. In auto trigger mode, the oscilloscope produces an internal trigger in the absence of other trigger events.

At horizontal scale settings of 100 ms per division and slower, auto trigger mode switches to an untriggered roll display. When the display is in "roll" mode the envelope and average acquisition modes does not work properly, and the display does not show a trigger "T" on the waveform.

Adjust Holdoff Press the main-menu button Holdoff to activate the General Purpose Knob. Use the knob to adjust holdoff; the TDS 300 Series have a holdoff range of 500 ns to 10 s. Press the side-menu button Set to Min to quickly set the holdoff to 500 ns.

Video Triggering

The video trigger triggers on field 1, field 2, any field, or lines of an NTSC or PAL standard video signal. It can also trigger on nonstandard video signals with similar sync signals. You can access video trigger settings through the video trigger menu, shown in Figure 3–10.

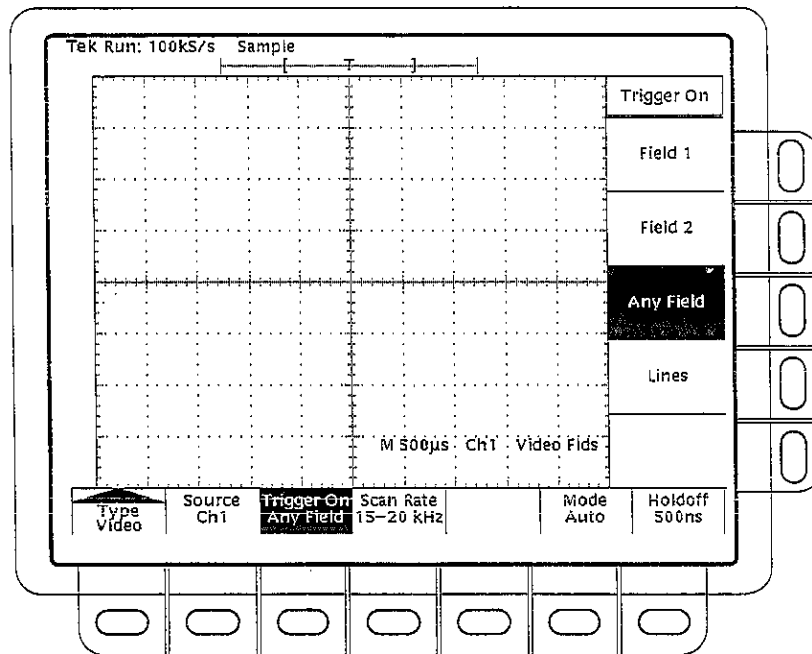

Figure 3–10: The video trigger menu

Use the video trigger menu to perform these tasks.

Select Trigger Source, Mode, and Holdoff

These main menu selections perform exactly as in the edge trigger menu, because the two triggers share these parameters. For example, if you set the edge trigger holdoff to 2.3 ms and then switch to the video trigger, its holdoff will also be 2.3 ms.

Select Trigger Point

Press the main-menu button **Trigger On** to select the part of the video signal on which the oscilloscope will trigger. Use the side menu to select from these options:

- Press **Field 1** to trigger on field 1 of the video signal.
- Press **Field 2** to trigger on field 2 of the video signal.

- Press Any Field to trigger on any field of the video signal.
- Press Lines to trigger on all lines of the video signal.

The video trigger can only trigger on negative-going sync. If you need to trigger on the positive-going sync of a signal, simply invert the signal from the vertical menu (see page 3-4).

Select Scan Rate

Press the main-menu button Scan Rate to select the scan rate frequency range. Use the side menu to select from the following rates (see Figure 3-11):

- Press Rate 1 to select a scan rate of 15 to 20 kHz.
- Press Rate 2 to select a scan rate of 20 to 25 kHz.
- Press Rate 3 to select a scan rate of 25 to 35 kHz.
- Press Rate 4 to select a scan rate of 35 to 50 kHz.
- Press Rate 5 to select a scan rate of 50 to 65 kHz.

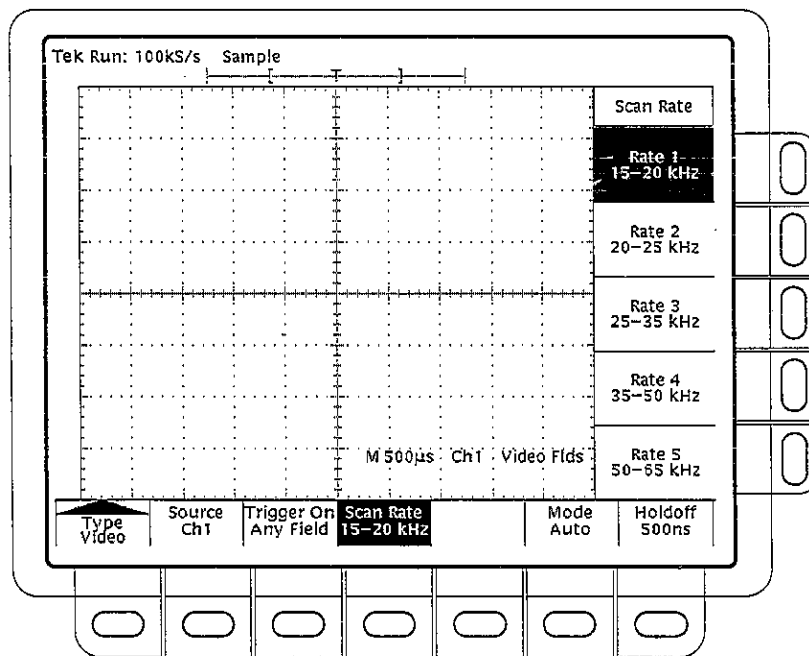

Figure 3-11: The video scan-rate menu

Taking Measurements

TDS 300 Series oscilloscopes have two features that make it easy for you to measure data from a displayed waveform: automated measurements and cursors.

Automated Measurements

The oscilloscope can perform 21 different automated measurements on a waveform (four measurements at any one time). To access these measurements, press the MEASURE button, shown in Figure 3-12.

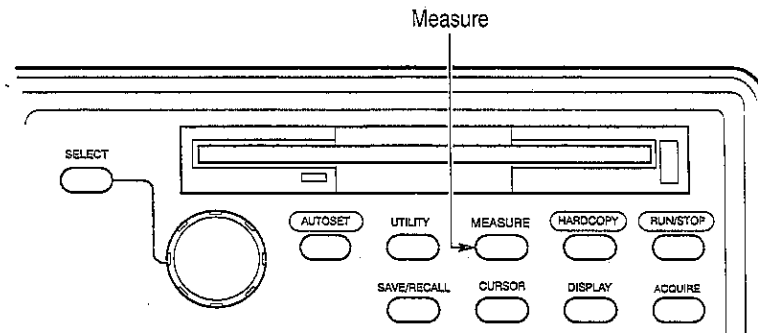

Figure 3-12: The MEASURE button

The MEASURE button activates the measure menu, shown in Figure 3-13.

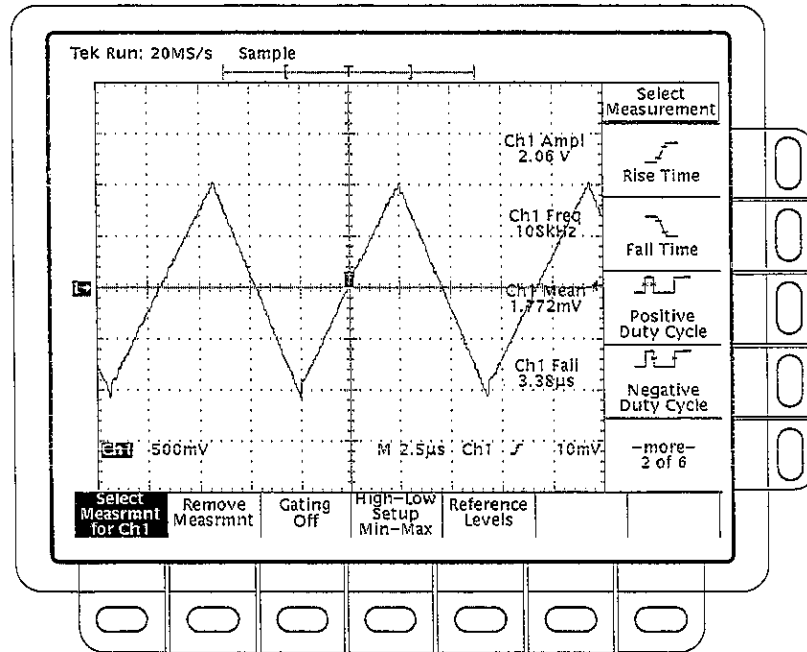

Figure 3-13: The measure menu and active measurements

Use the measure menu to perform the following tasks.

Activate a Measurement

Use this procedure to activate a measurement for the selected waveform:

1. Press the main-menu button Select Measrmt for...
2. If necessary, press the lowermost side-menu button (labeled -more- x out of 6) to page through the available measurements until the measurement you want to take appears in the side menu.
3. Then press one of the top four side-menu buttons to activate a particular measurement.

The measured values appear to the left of the side menu, as shown in Figure 3-13. For definitions of the available measurements, see Table 3-1.

NOTE. Measurements only remain active while the channel is active. If you activate several measurements for a channel and then press the WAVEFORM OFF button, the measurements disappear just like the waveform.

Table 3-1: Measurement definitions





















Name	Definition
 Period	Timing measurement. Time it takes for the first complete signal cycle to happen in the waveform or gated region. The reciprocal of frequency. Measured in seconds.
 Frequency	Timing measurement for the first cycle in the waveform or gated region. The reciprocal of the period. Measured in Hertz (Hz) where 1 Hz = 1 cycle per second.
 Positive Width	Timing measurement of the first pulse in the waveform or gated region. The distance (time) between MidRef (default 50%) amplitude points of a positive pulse.
 Negative Width	Timing measurement of the first pulse in the waveform or gated region. The distance (time) between MidRef (default 50%) amplitude points of a negative pulse.
 Rise time	Timing measurement. Time taken for the leading edge of the first pulse in the waveform or gated region to rise from a Low Ref value (default = 10%) to a High Ref value (default = 90%) of its final value.
 Fall Time	Timing measurement. Time taken for the falling edge of the first pulse in the waveform or gated region to fall from a High Ref value (default = 90%) to a Low Ref value (default = 10%) of its final value.
 Positive Duty Cycle	Timing measurement of the first cycle in the waveform or gated region. The ratio of the positive pulse width to the signal period expressed as a percentage. $PositiveDutyCycle = \frac{PositiveWidth}{Period} \times 100\%$
 Negative Duty Cycle	Timing measurement of the first cycle in the waveform or gated region. The ratio of the negative pulse width to the signal period expressed as a percentage. $NegativeDutyCycle = \frac{NegativeWidth}{Period} \times 100\%$
 Burst Width	Timing measurement. The duration of a burst. Measured over the entire waveform or gated region.
 Positive Overshoot	Voltage measurement over the entire waveform or gated region. $PositiveOvershoot = \frac{Max-High}{Amplitude} \times 100\%$
 Negative Overshoot	Voltage measurement. Measured over the entire waveform or gated region. $NegativeOvershoot = \frac{Low-Min}{Amplitude} \times 100\%$
 High	The value used as 100% whenever High Ref, Mid Ref, and Low Ref values are needed (as in fall time and rise time measurements). Measured over the entire waveform or gated region.
 Low	The value used as 0% whenever High Ref, Mid Ref, and Low Ref values are needed as in fall time and rise time measurements. Measured over the entire waveform or gated region.
 Maximum	Voltage measurement. The maximum amplitude. Typically the most positive peak voltage. Measured over the entire waveform or gated region.
 Minimum	Voltage measurement. The minimum amplitude. Typically the most negative peak voltage. Measured over the entire waveform or gated region.
 Peak to Peak	Voltage measurement. The absolute difference between the maximum and minimum amplitude in the entire waveform or gated region.

Table 3-1: Measurement definitions (Cont.)

Name	Definition
 Amplitude	Voltage measurement. The high value less the low value measured over the entire waveform or gated region. $\text{Amplitude} = \text{High} - \text{Low}$
 Mean	Voltage measurement. The arithmetic mean over the entire waveform or gated region.
 Cycle Mean	Voltage measurement. The arithmetic mean over the first cycle in the waveform, or the first cycle in the gated region.
 Cycle RMS	Voltage measurement. The true Root Mean Square voltage over the first cycle in the waveform, or the first cycle in the gated region.
 RMS	Voltage measurement. The true Root Mean Square voltage over the entire waveform or gated region.

Remove a Measurement

Press the main-menu button Remove Measrmt. Use the top four side-menu buttons to remove specific measurements or use the lowest side-menu button to remove all measurements.

Using Gating

By default, TDS 300 Series oscilloscopes take automated measurements on the entire waveform record. If you want a measurement of only a portion of the waveform, you can use gating to mark the boundaries of that portion. Use this procedure to “gate” a signal:

1. Press the main-menu button Select Measrmt for...
2. If necessary, press the lowermost side-menu button (labeled –more– x out of 6) to page through the available measurements until the measurement you want to take appears in the side menu.
3. Then press one of the top four side-menu buttons to activate a particular measurement.
4. Press the main-menu button Gating.
5. Press the side-menu button Gate with V Bar Cursors.
6. Use the General Purpose Knob to set one cursor to the left edge of your gate.
7. Press SELECT.
8. Use the General Purpose Knob to set the other cursor to the right edge of the gate. All automated measurements now take data only from the portion of the waveform that is within the gate.
9. Press Gate Off to turn gating off.

NOTE. *Gate Off deactivates the gating function, but it does not deactivate the vertical cursors. Deactivate the cursors from the cursor menu as described in the next section.*

Switch High-Low Setup

Press the main-menu button High–Low Setup to change the way the measurement system determines the high and low levels of waveforms. Use the side menu to select from these options:

- Press Histogram to set the levels statistically. The oscilloscope attempts to find the highest density of points above and below the midpoint, ignoring spikes. This method works well for measuring square waves and pulse waveforms.
- Press Min–Max to set the levels to the lowest amplitude (most negative) and highest amplitude (most positive) samples.

Set Reference Levels

Press the main-menu button Reference Levels to set the high, middle, and low reference levels. The oscilloscope uses these levels for rise time, fall time, width, and overshoot measurements. Use the side menu to select from these options:

- Press Set Levels in to toggle the units of the reference levels. Switch between volts and percent.
- Press High Ref, Mid Ref, or Low Ref to select a particular reference level. Use the General Purpose Knob to alter the selected reference level. The defaults are 90%, 50%, and 10%, respectively.

Taking Measurements with Cursors

You can also take quantitative measurements of a waveform with the cursor system. To take measurements with cursors, follow this procedure:

1. Press the front panel button CURSOR, shown in Figure 3–14. The CURSOR button calls up the cursor menu, shown in Figure 3–15.

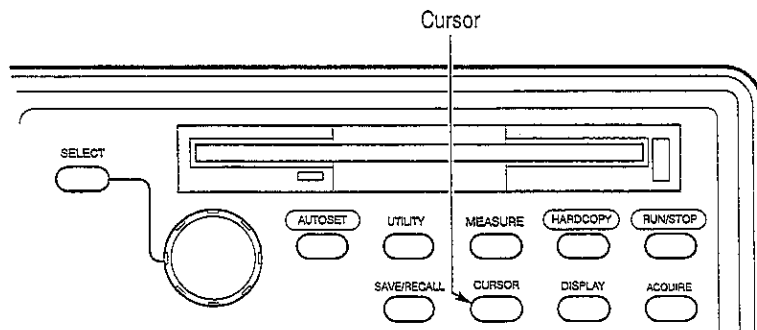

Figure 3-14: The CURSOR button

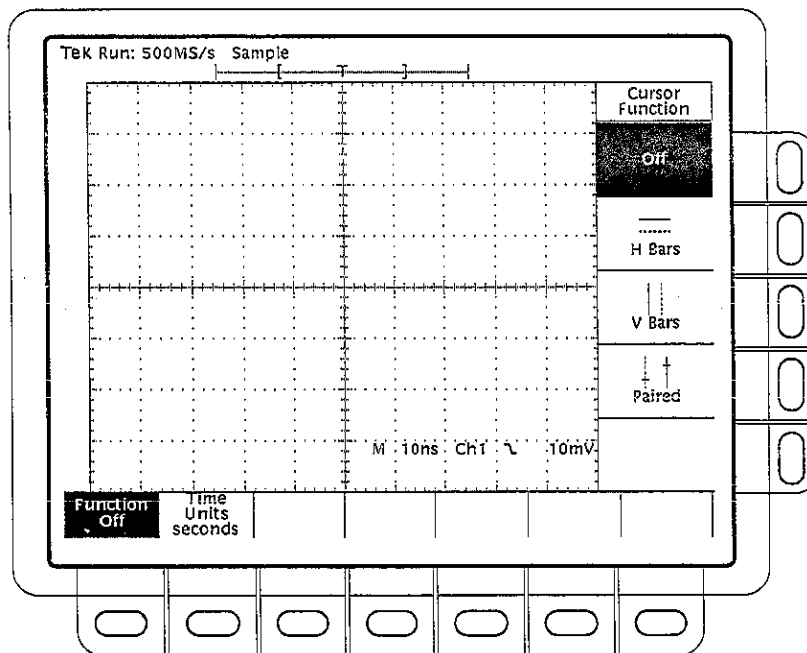

Figure 3-15: The cursor menu

2. If you want to take a time measurement in Hertz instead of seconds, press the main-menu button Time Units and use the side menu to switch between the two.
3. If the main menu selection Function is not highlighted, press its main-menu button.
4. Use the side menu to select the type of measurement you want to take. Select H Bars to take a voltage measurement, select V Bars to take a time measurement, or select Paired to take simultaneous voltage and time measurements.

- Use the General Purpose Knob to move one cursor to a desired measurement point. For example, if you wanted to measure both the peak-to-peak voltage and period of a sine wave, you would start by moving one paired cursor to a “valley” (see Figure 3–16).

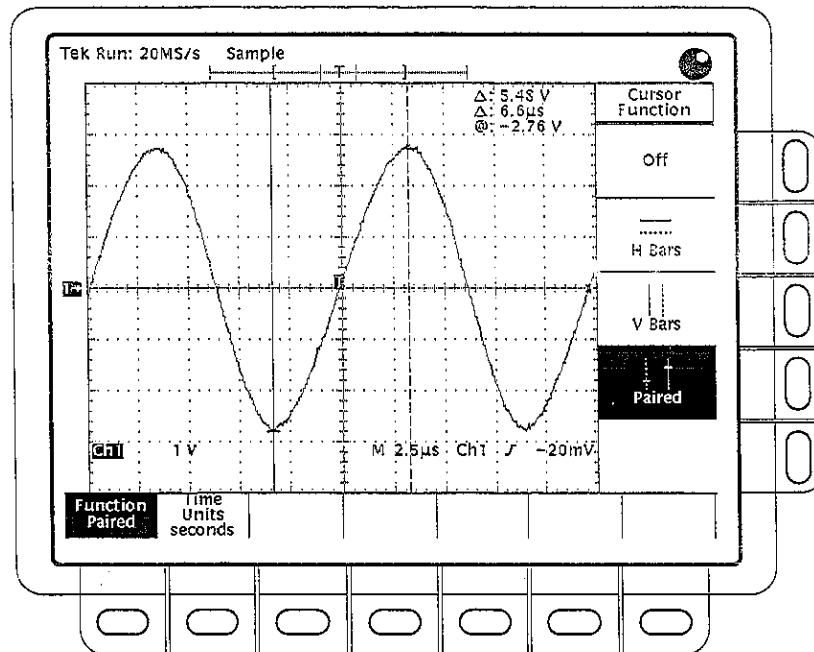

Figure 3–16: Paired cursor measurements of a sine wave

- Press SELECT.
- Use the General Purpose Knob to move the second cursor to another desired measurement point. To continue the example, you would move the second cursor to the previous “peak.”
- Read the measured value(s) at the upper right corner of the display next to the Δ sign(s). Figure 3–16 shows a sine wave with a 5.48 V_{p-p} and a 13.2 μ s period ($6.6 \mu\text{s} \times 2$).

Controlling Acquisition

To access the acquisition controls, press the front panel button ACQUIRE, shown in Figure 3-17.

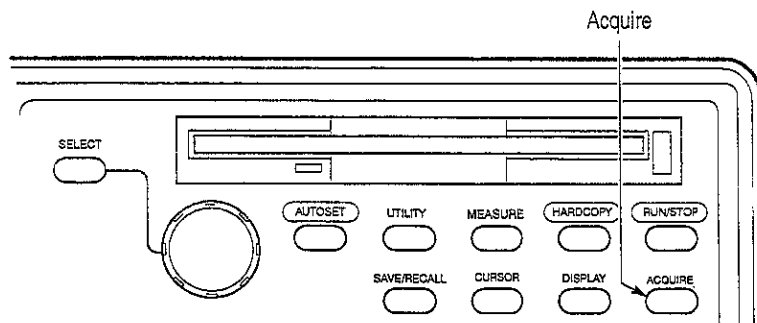

Figure 3-17: The ACQUIRE button

The ACQUIRE button activates the acquire menu, shown in Figure 3-18.

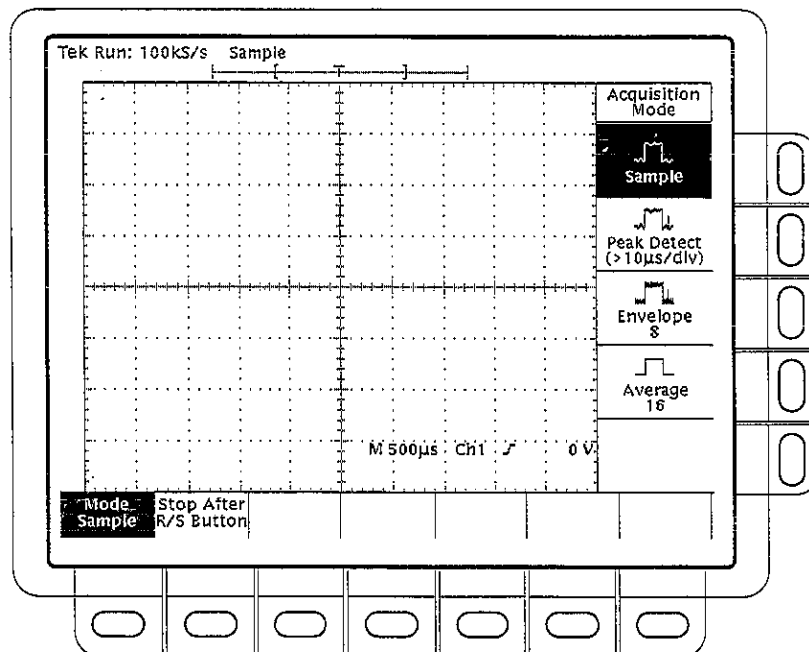

Figure 3-18: The acquire menu

Use the acquire menu to perform these tasks.

Select Acquisition Mode

Press the main-menu button Mode. Use the side menu to select from these modes.

- Press Sample to select sample mode.
- Press Peak Detect to select peak detect mode. Peak detect mode only operates at horizontal SCALE settings of 25 μ s or slower.
- Press Envelope to select envelope mode. Use the General Purpose Knob to adjust the number of envelopes (2, 4, 8, 16, 32, 64, 128, 256, or ∞).
- Press Average to select average mode. Use the General Purpose Knob to adjust the number of acquisitions to average (2, 4, 8, 16, 32, 64, 128, or 256).

NOTE. Average is the only available acquisition mode if an FFT math waveform is displayed.

Activate Single-Sequence Mode

Press the main-menu button Stop After and then the side-menu button Single Acquisition Sequence.

When in single-sequence mode, the oscilloscope acquires a single sequence, displays it, and then waits for you to press the RUN/STOP button.

The definition of a sequence depends on the present acquisition mode. In sample or peak detect mode, a sequence is a single acquisition. In envelope or average mode, a sequence is a number of acquisitions equal to the number of envelopes or averages.

For example, when both average and single-sequence mode are active and the number of averages is 16, the oscilloscope collects 16 acquisitions, averages them, displays the resulting waveform, and then stops until you press the RUN/STOP button.

To deactivate single-sequence mode, press RUN/STOP button only in the side menu.

Controlling the Display

To access the display controls, press the front panel button DISPLAY, shown in Figure 3-19.

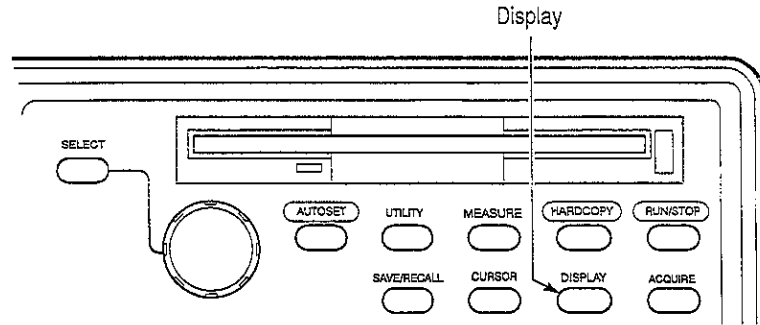

Figure 3-19: The DISPLAY button

The DISPLAY button activates the display menu, shown in Figure 3-20.

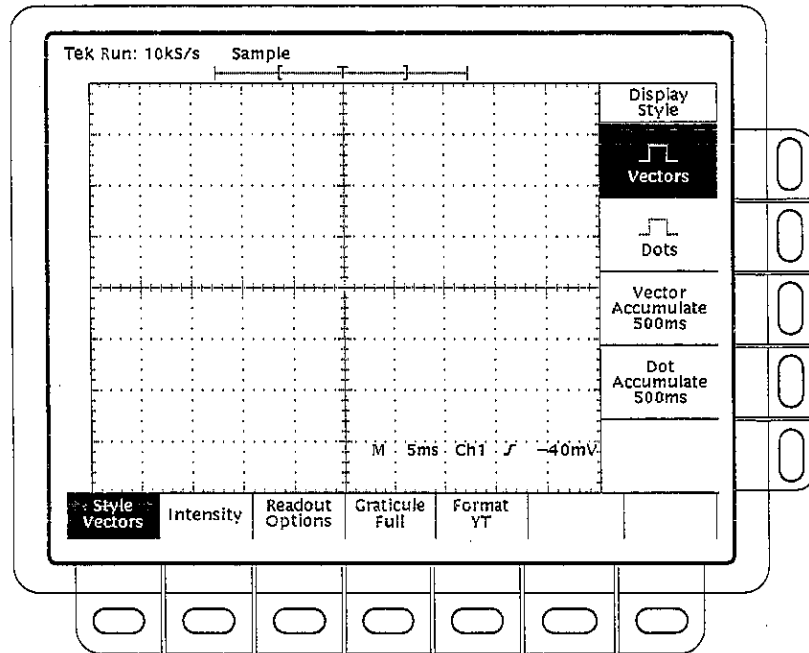

Figure 3-20: The display menu

Use the display menu to perform these tasks.

Select Display Style

Press the main-menu button Style. Use the side menu to select from these display styles:

- Press Vectors to select vector display style. The oscilloscope draws a vector between each pair of waveform points.
- Press Dots to select dot display mode. The oscilloscope displays only the waveform points.
- Press Vector Accumulate or Dot Accumulate to set the display to accumulate dots. Use the General Purpose Knob to adjust the time limit (from 500 ms to 10 s in 250 ms increments or ∞). The display accumulates dots until it reaches the time limit. It then clears the waveform and starts over. Dot Accumulate mode shows the latest acquired waveform in dot format, while Vector Accumulate mode shows it in vector format.

Adjust Display Intensity

Press the main-menu button Intensity. Use the side menu to select from the following menu items:

- Press Overall to adjust the intensity of the screen as a whole. Use the General Purpose Knob to vary screen intensity.
- Toggle Text/Grat to switch the text and graticule between bright and dim.
- Toggle Waveform to switch the waveform between bright and dim.
- Press Contrast to adjust the contrast between the bright and dim settings. Use the General Purpose Knob to vary the contrast level from 100% to 250%. (When you set contrast to 200%, the dim setting is half as bright as the bright setting.)

Add or Remove the Trigger 'T'

By default, TDS 300 oscilloscopes display a 'T' at the trigger point. Press the main-menu button Readout Options and then toggle the Display 'T' @ Trigger Point button to remove and add this feature.

Select Graticule Type

Press the main-menu button Graticule and then use the side menu to switch between a full graticule, a frame, a grid, or cross hairs.

Select Display Format

Press the main-menu button Format and then use the side menu to switch between YT and XY modes.

**Add or Remove the
Date/Time Stamp**

You can display the current date and time on screen so that it appears in the display, on hard copies you print, and with any files you store on the floppy disk. To enable the date and time stamp in the display, do the following steps:

1. Press the front-panel button DISPLAY and then the main-menu button Readout Options.
2. Press the side-menu button Display Date and Time to toggle the setting to On.
3. The date and time are backed up by a battery and need not be set each time you power up the oscilloscope. If the date and time are not correct, skip steps 4 and 5 and continue with step 1 of *Setting the Date and Time* on page 3-60. Then redo this procedure.
4. Press Clear Menu to remove the menu from the display so the date and time can be displayed. See Figure 3-39. (The date and time is removed from the display when menus are displayed.)
5. Press HARDCOPY to print your date/time stamped hardcopy.

NOTE. *To set the date and time, refer to Setting the Date and Time on page 3-60.*

Using the FFT

Using the Fast Fourier Transform (FFT), you can transform a waveform from a display of its amplitude against time to one that plots the amplitudes of the various discrete frequencies the waveform contains. Use FFT math waveforms in the following applications:

- Testing impulse response of filters and systems
- Measuring harmonic content and distortion in systems
- Characterizing noise in DC power supplies
- Analyzing vibration
- Analyzing harmonics in 50 and 60 Hz power lines

Description

The FFT computes and displays the frequency content of a waveform you acquire as an FFT math waveform. This frequency domain waveform is based on the following equation:

$$X(k) = \frac{1}{N} \sum_{n = \frac{-N}{2}}^{\frac{N}{2}-1} x(n) e^{-\frac{j2\pi nk}{N}} \quad \text{for } k = 0 \text{ to } N-1$$

Where: $x(n)$ is a point in the time domain record data array

$X(k)$ is a point in the frequency domain record data array

n is the index to the time domain data array

k is the index to the frequency domain data array

N is the FFT length

j is the square root of -1

The resulting waveform is a display of the magnitude of the various frequencies the waveform contains with respect to those frequencies. For example, Figure 3-21 shows the non-transformed impulse response of a system in channel 1 at the top of the screen. The FFT-transformed magnitude appears in the math waveform below the impulse. The horizontal scale for FFT math waveform is

always expressed in frequency/division with the beginning (left-most point) of the waveform representing zero frequency (DC).

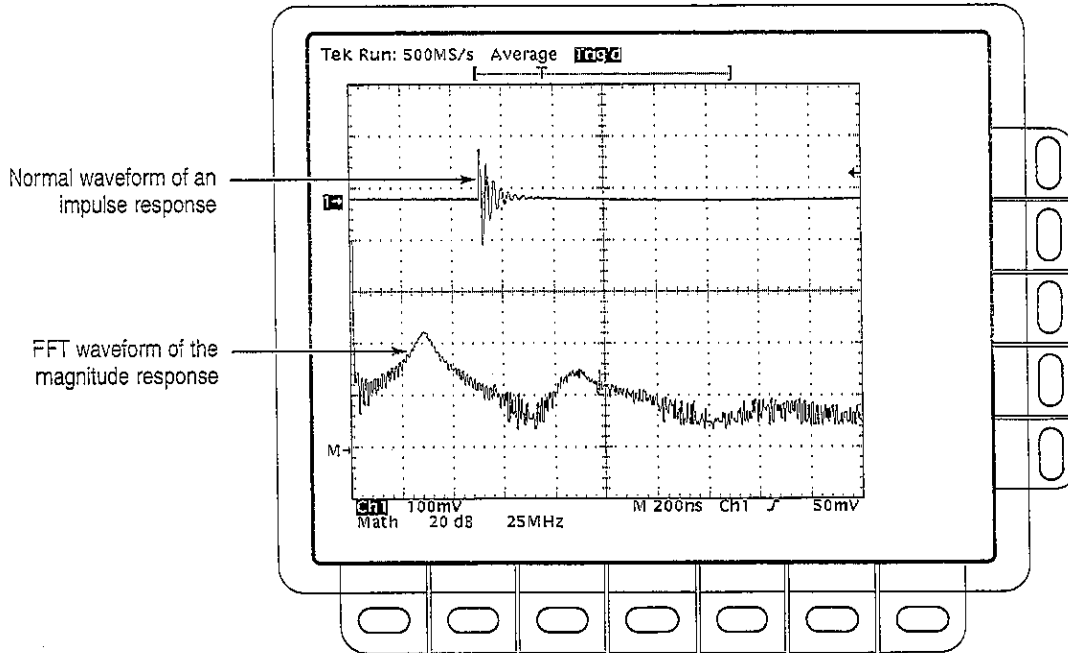

Figure 3-21: System response to an impulse

Operation

To obtain an FFT of your waveform, do these basic tasks:

- Acquire and display it normally (that is, in the time domain) in your choice of input channels.
- Transform it to the frequency domain using the math waveform menu.
- Use cursors or automated measurements to measure its parameters.

Displaying an FFT

Perform the following steps to display an FFT math waveform:

1. Connect the waveform to the desired channel input and select that channel.
2. Adjust the vertical and horizontal scales and trigger the display (or press AUTOSET).

The topic *Offset, Position, and Scale*, on page 3-37, provides in-depth information about optimizing your setup for FFT displays.

3. Press the front-panel MATH button to display a math waveform.
4. Press the FFT side-menu button to select the FFT waveform. To select a different source channel, press the FFT side-menu button repeatedly. See Figure 3-22.

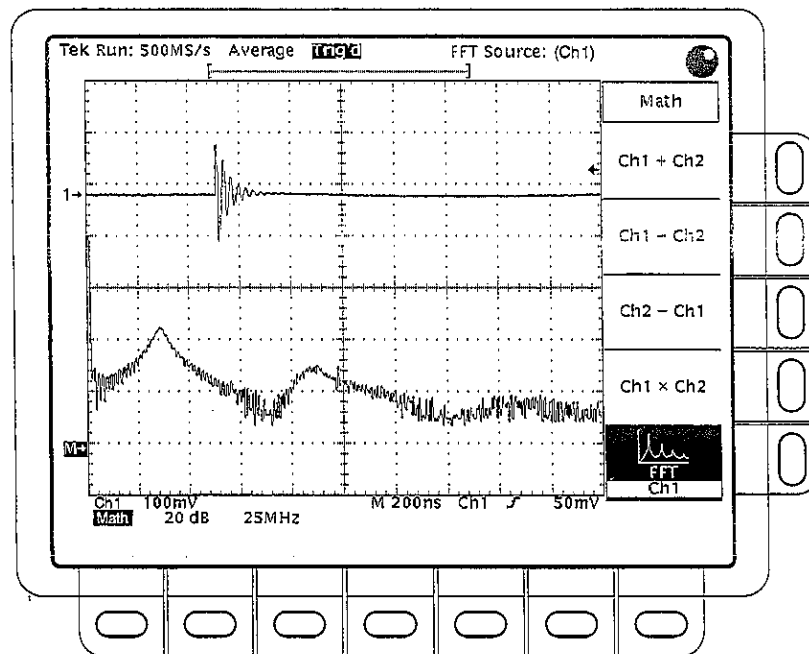

Figure 3-22: Define FFT waveform menu

NOTE. The FFT math waveform vertical scale factor is dBV_{RMS} , which is dB relative to $1 V_{RMS}$ ($0 dB = 1 V_{RMS}$).

5. Press the HORIZONTAL MENU button and then press the main-menu button Fit to Screen.
6. Press the side-menu button On to display a complete frequency spectrum, from DC to the Nyquist frequency.

Cursor Measurements of an FFT

Once you have displayed an FFT math waveform, use cursors to measure its frequency amplitudes.

1. Be sure MATH is selected in the channel selection buttons.
2. Press the front-panel button CURSOR, the main-menu button Function, and then the side-menu button H Bars.
3. Use the general purpose knob to align the selected cursor (solid line) to the top (or to any amplitude on the FFT waveform you choose).
4. Press SELECT to select the other cursor. Use the general purpose knob to align the selected cursor to the bottom (or to any amplitude on the FFT waveform you choose).
5. Read the amplitude between the two cursors from the Δ : readout. Read the amplitude of the selected cursor relative to $1 V_{RMS}$ (0 dB) from the @: readout (See Figure 3-23).
6. Press the side-menu button V Bars. Use the general purpose knob to align one of the two vertical cursors to a point of interest along the horizontal axis of the waveform.
7. Press SELECT to select the alternate cursor.
8. Align the alternate cursor to another point of interest on the FFT waveform.
9. Read the frequency difference between the cursors from the Δ : readout. The cursor units will always be in Hz, regardless of the setting in the Time Units side menu.

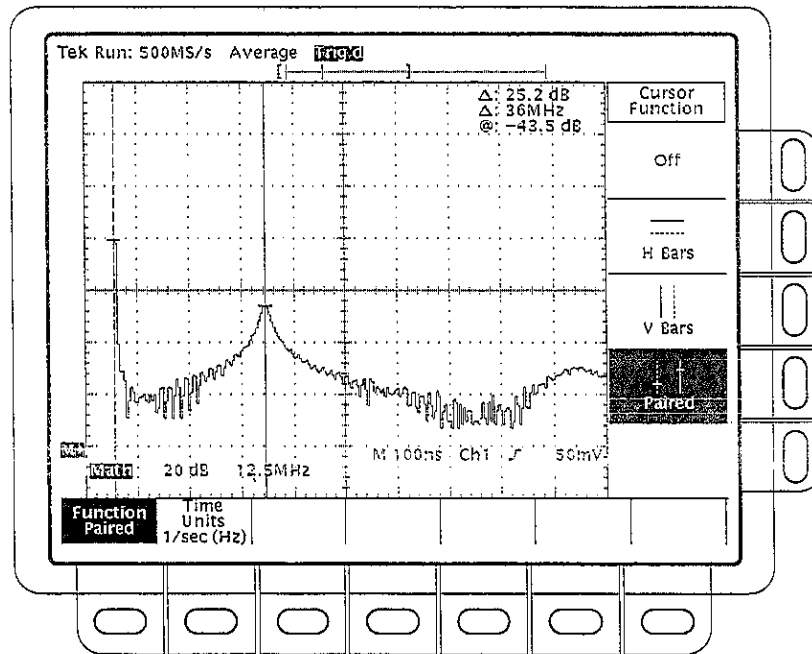

Figure 3-23: Cursor measurement of an FFT waveform

10. Press the main-menu button Function and then the side-menu button Paired.
11. Use the technique just outlined to place the vertical bar of each paired cursor to the points along the horizontal axis you are interested in.
12. Read the amplitude between the short horizontal bar of the two paired cursors from the top-most Δ : readout. Read the amplitude of the short horizontal bar of the selected (solid) cursor relative to $1 V_{RMS}$ (0 dB) from the @: readout. Read the frequency between the long horizontal bars of both paired cursors from the bottom Δ : readout.

Automated Measurements of an FFT

You can also use automated measurements to measure FFT math waveforms. Use the same procedure as is found under *Taking Measurements* on page 3-17.

Considerations for Using FFTs

There are several characteristics of FFTs that affect how they are displayed and should be interpreted. Read the following topics to learn how to optimize the oscilloscope setup for good display of your FFT waveforms.

FFTs Transform Time Records to Frequency Records

A 1000-point time-domain record is input for the FFT. Figure 3–24 shows the transformation of that time-domain data record into a frequency-domain record. The resulting frequency-domain record is initially 1000 points that contain both positive and negative frequencies. Since the negative values mirror the positive values, only the positive 500 values are kept. Then, each value is repeated to make a 1000-point frequency-domain record.

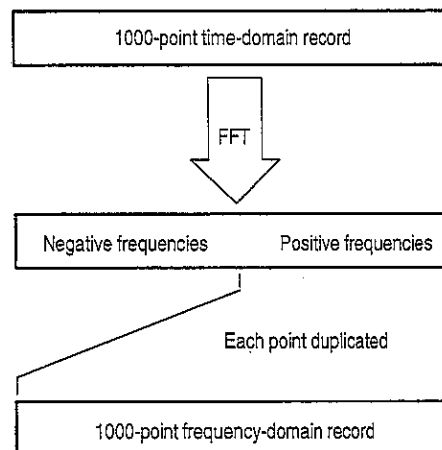

Figure 3–24: FFT time domain record vs. FFT frequency domain record

FFT Frequency Range and Resolution

When you turn on an FFT waveform, the oscilloscope displays the magnitude of the FFT frequency domain record. The resolution between the discrete frequencies displayed in this waveform is determined by the following equation:

$$\Delta F = \frac{\text{Sample Rate}}{\text{FFT Length}} = \frac{\text{Sample Rate}}{500 \text{ samples}}$$

Where: ΔF is the frequency resolution in Hz.

Sample Rate is the sample rate of the source waveform.

FFT Length is the number of independent points in the FFT.

The sample rate also determines the range these frequencies span; they span from zero to one-half the sample rate of the waveform record. (The value of one-half the sample rate is often referred to as the Nyquist frequency or point.) For

example, a sample rate of 20 Megasamples/second would yield an FFT with a range of 0 to 10 MHz. The sample rates available for acquiring data records vary over a range the limits of which depend on your oscilloscope model. The oscilloscope displays the sample rate in the acquisition readout at the top of the oscilloscope screen.

Offset, Position, and Scale

To properly display your FFT waveform, scale the source waveform so it is not clipped.

- You should scale and position the source waveform so it is contained on screen. (Off screen waveforms may be “clipped,” which will result in errors in the FFT waveform).

Alternately, to get maximum vertical resolution, you can display source waveforms with amplitudes up to two divisions greater than that of the screen. If you do, turn on Pk-Pk in the measurement menu and monitor the source waveform for clipping.

- Use vertical position and vertical offset to position your source waveform. As long as the source waveform is not clipped, its vertical position and vertical offset will not affect your FFT waveform except at DC. (DC correction is discussed below.)

Normally, the output of a standard FFT computation yields a DC value that is twice as large as it should be with respect to the other frequencies. The displayed output of the FFT on a TDS 300 oscilloscope is corrected for these errors to show the true value for the DC component of the input signal. The Position and Offset must be set to zero for the source waveform in the Vertical menu. When measuring the amplitude at DC, remember that 1 VDC equals 1 V_{RMS} and the display is in dB.

Undersampling (Aliasing)

Aliasing occurs when the oscilloscope acquires a source waveform with frequency components outside of the frequency range for the current sample rate. In the FFT waveform, the actual higher frequency components are under-sampled, and therefore, they appear as lower frequency aliases that “fold back” around the Nyquist point (see Figure 3-25).

The greatest frequency that can be input into any sampler without aliasing is one-half the sample frequency. Since source waveforms often have a fundamental frequency that does not alias but have harmonic frequencies that do, you should have methods for recognizing and dealing with aliases:

- Be aware that a source waveform with fast edge transition times creates many high frequency harmonics. These harmonics typically decrease in amplitude as their frequency increases.
- Sample the source signal at rates that are at least 2X that of the highest frequency component having significant amplitude.

- Filter the input to bandwidth limit it to frequencies below that of the Nyquist frequency.
- Recognize and ignore the aliased frequencies.

If you think you have aliased frequencies in your FFT, select the source channel and adjust the horizontal scale to increase the sample rate. Since you increase the Nyquist frequency as you increase the sample rate, the alias signals should “unfold” and appear at their proper frequency.

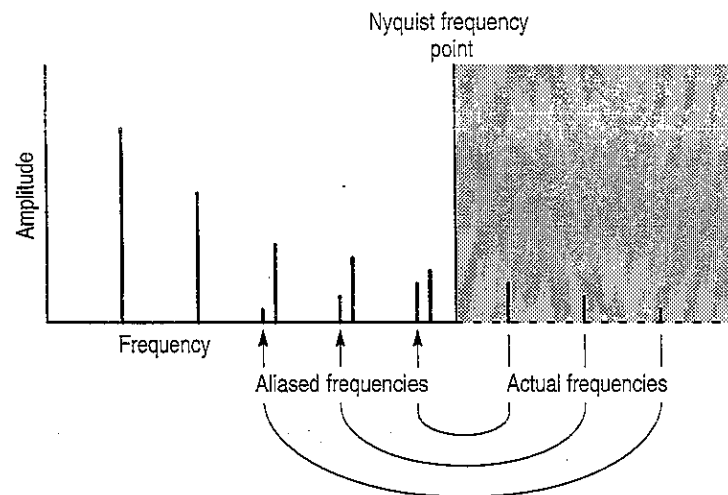

Figure 3-25: How aliased frequencies appear in an FFT

FFT Windows

The oscilloscope multiplies the FFT time domain record by a Hanning window before it inputs the record to the FFT function. Figure 3-26 shows how the time domain record is processed.

The FFT windowing acts like a bandpass filter between the FFT time domain record and the FFT frequency domain record. The shape of the window controls the ability of the FFT to resolve (separate) the frequencies and to accurately measure the amplitude of those frequencies. The Hanning window is optimized for low leakage and good amplitude measurement accuracy on the different frequency components of the signal.

If possible, adjust the trigger position so that the most interesting parts of the signal in the time domain record are positioned in the center region of the window so that the tapering does not cause severe errors.

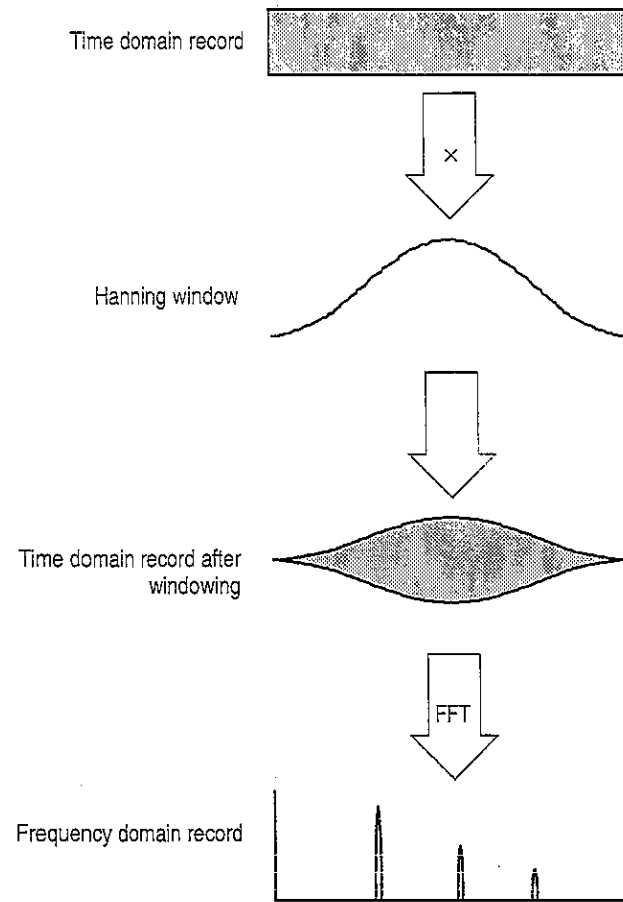

Figure 3-26: Windowing the FFT time domain record

Making Hard Copies (Option 14 Equipped Instruments Only)

By using the Option 14 Communications Interface, you can make hard copies of waveforms with the oscilloscope. To make a hard copy, connect your hard copy device to the appropriate interface on the rear panel and press the **HARDCOPY** button, shown in Figure 3-27.

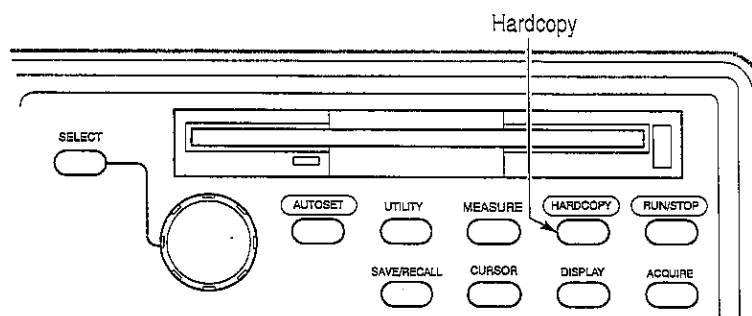

Figure 3-27: The HARDCOPY button

To abort a hard copy enter the System I/O menu as described in the next section and press the main-menu button Clear Spool.

Configuring Hard Copy Output

Before you can successfully make a hard copy, you need to configure the hard copy output to match your hard copy device. Use this procedure to configure the hard copy output:

1. Press the **UTILITY** button, shown in Figure 3-28.

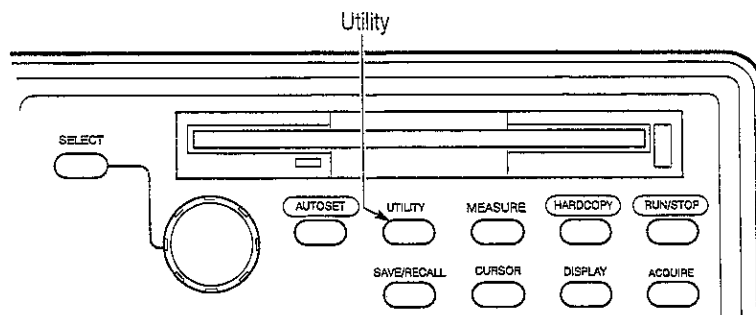

Figure 3-28: The **UTILITY** button

2. Repeatedly press the System main-menu button until **I/O** is highlighted in the pop-up menu. This activates the system I/O menu, shown in Figure 3-29.

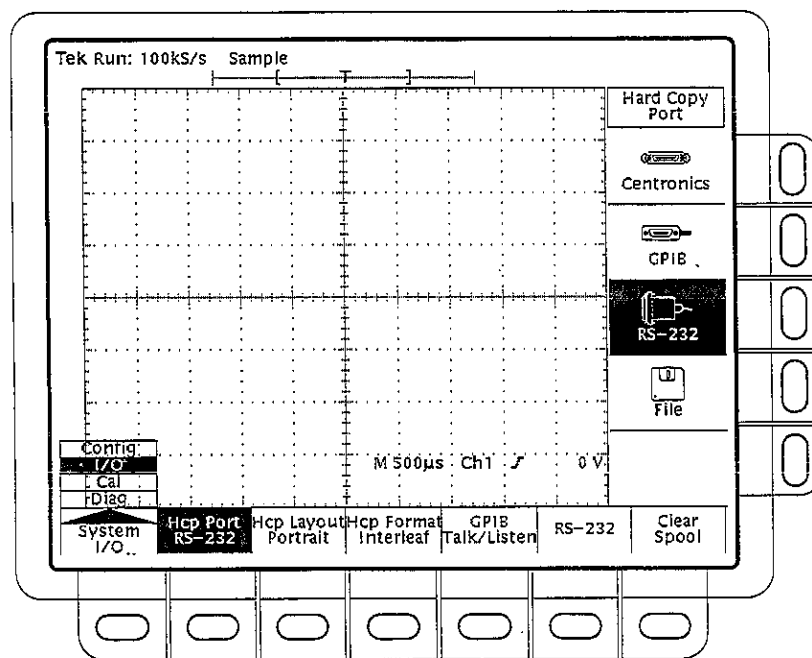

Figure 3-29: The system I/O menu

3. Press the main-menu button Hcp Port. Use the side menu to select Centronics, GPIB, or RS-232C.
4. Press the main-menu button Hcp Layout. Use the side menu to select Landscape or Portrait.
5. Press the main-menu button Hcp Format. Use the side menu to select your printer format (press the lowermost side-menu button, labeled –more– x of 3, to page through the formats as necessary). Formats available are Thinkjet, Deskjet, Laserjet, Epson, Interleaf, TIFF, PCX, BMP, EPS (Encapsulated PostScript), DPU 411/II, and DPU 412.
6. If you are using the GPIB as your hard copy port, press the main-menu button GPIB. Then press the side-menu button Hardcopy (Talk Only).
7. If you are using the RS-232C as your hard copy port, press the main-menu button RS-232C. Then press, in turn, each side-menu button until the desired parameter settings are displayed in the side menu. Or, if its settings are appropriate, press Set RS-232 Parameters to Default Values. Remember, the parameter settings you select must be compatible with the settings of your hardcopy device or personal computer. (For additional RS-232 information see the *TDS 340A, TDS 360 & TDS 380 Programmer Manual*.)

You are now ready to make a hard copy. Press the front-panel **HARDCOPY** button.

Saving a Hard Copy to Disk

You can send a “hard copy” (the screen image) to a floppy disk to use later in your documentation. You cannot recall hard copies from the disk back into the oscilloscope. To save a hard copy to disk do the following steps:

1. Insert a formatted 720 Kbyte or 1.44 Mbyte floppy disk into the slot at the top of the oscilloscope.

NOTE. *To format disks, delete hard copy files you save to disk, and otherwise manage the disk storage, see Using the File System on page 3–55.*

2. Press the front-panel button **UTILITY** and then press the main-menu button **System** to select the I/O menu.
3. Press the main-menu button **Hcp Port** and then press the side-menu button **File**. The file list and its scrollbar will appear.

4. Turn the general purpose knob to place the scroll bar over the file in which to store the hard copy.

NOTE. Upon power on, the oscilloscope creates the "wild card" file TEK?????.FMT for storing hard copies, where ".FMT" is replaced by the hard copy format you select. Selecting this file and pressing **HARDCOPY** stores a hard copy in a uniquely named, sequentially numbered file. For instance, if the selected format is Thinkjet, the oscilloscope saves the first hard copy you save to the file TEK00001.TJ, the second to TEK00002.TJ, and so on.

5. Press **HARDCOPY** to copy the screen image to the selected file.

Saving files to the floppy disk provides a convenient way to store hard copies for later recall and display at a remote site. You can load them into your desktop publishing software that runs on a compatible PC.

Saving and Recalling Waveforms

You can save waveforms into and recall them from reference waveforms that reside in nonvolatile memory. You can also save and recall waveforms to and from files on a floppy disk.

Using Reference Waveforms

TDS 300 Series oscilloscopes have two reference waveforms. You can use the reference waveforms to store “live” waveforms (channel and math waveforms). You can also shift a stored waveform from one reference waveform to the other.

Reference waveforms respond just like live waveforms to changes in vertical position and scale, but they do not respond to horizontal scale adjustments. There is no way to horizontally expand a reference waveform.

NOTE. The TekSecure feature (page 3-59) erases both reference waveforms and fills them with null data.

Saving to a Reference Waveform

To save a live waveform to a reference waveform, press one of the reference-waveform buttons (REF 1 or REF 2) shown in Figure 3-30.

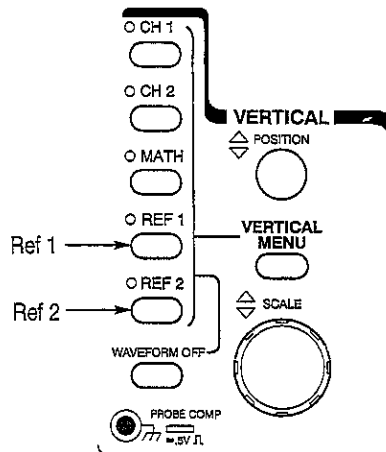

Figure 3-30: The reference waveform buttons

If the selected reference waveform does not contain null data, it appears on the screen. A side menu also appears; select one of these options from the side menu (see Figure 3–31).

- Press Save CH1 to Ref(x) to save the channel 1 waveform to the selected reference waveform.
- Press Save CH2 to Ref(x) to save the channel 2 waveform to the selected reference waveform.
- Press Save MATH to Ref(x) to save the math waveform to the selected reference waveform.
- Press Save Ref(y) to Ref(x) to save the unselected reference waveform to the selected reference waveform. (For example, Ref2 to Ref1 or Ref1 to Ref2.)
- Press Horizontal Position to toggle between the Lock and Independent modes. In Lock mode, the horizontal position of the selected reference waveform is locked to the live waveforms. In Independent mode, the selected reference waveform is independently positionable.

NOTE. When saving to a reference waveform, the previous contents of the reference waveform are overwritten.

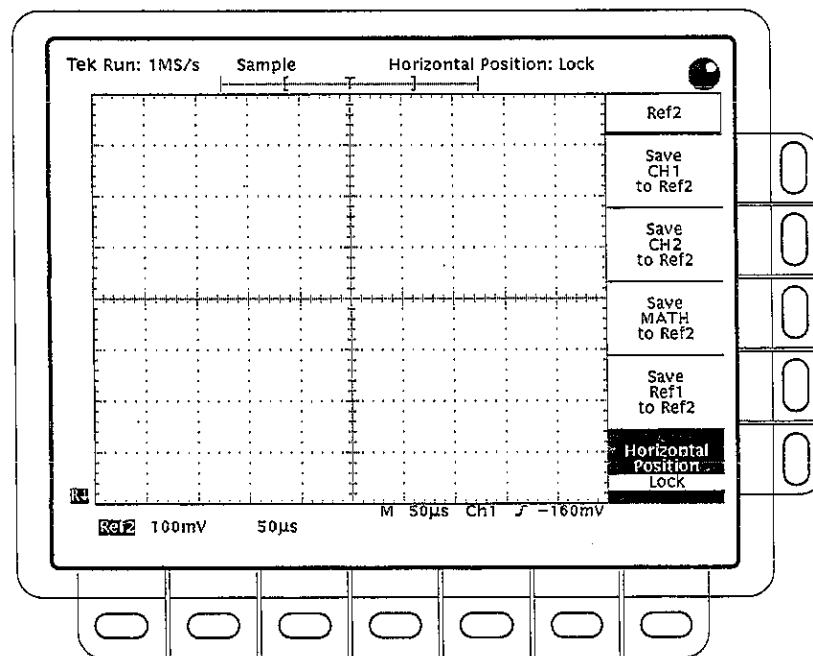

Figure 3–31: A reference waveform menu

The reference waveforms maintain their contents indefinitely, regardless of the power state or setup of the instrument. To remove a selected reference waveform from the display, press WAVEFORM OFF.

Recalling a Reference Waveform

To recall a reference waveform simply press its front panel button (REF 1 or REF 2).

Using the Disk

You can save waveforms to a floppy disk in several useful formats for mass storage or transfer to other applications. You can recall waveforms for display as reference waveforms.

Selecting the Save Format

To select the file format that the oscilloscope uses to save waveforms to a file, press the front-panel button SAVE/RECALL, and then the main-menu button Save Format. Three format choices are available using the side-menu buttons:

- Internal creates files (.ISF) in the internal format of the oscilloscope
- MathCad creates files (.DAT) in a format usable by MathCad®

DAT files are supported by the MathCad numerical analysis program. DAT file data is read line by line and placed into variables in the MathCad document. You then do whatever calculations are required. The DAT format begins with four values acting as a header containing the record length, time per sample interval, trigger location, and trigger offset, followed by a linear array of ASCII floating-point Y values. The recordLength, pre-trigger sample count and trigger offset are in samples. The horizontal scale per sample is in x units and the y value is in y units.

- Spreadsheet creates files (.CSV) in a format usable by most spreadsheets (Excel®, Lotus 1-2-3®, and Quattro Pro®)

CSV files (Comma Separated Values) contain comma separated X and Y ASCII values on CRLF terminated lines (a 2 dimensional array). Each value is a floating point number. There is one line for each point in a waveform record. The X and Y values are displayed in the units of seconds and Volts. All scaling to sample increments and offsetting has been done. Zero on the X scale is the trigger point, with negative values being pretrigger and positive values being posttrigger.

Refer to *Viewing a Waveform on a Spreadsheet* on page 3-49 for an example of using this format.

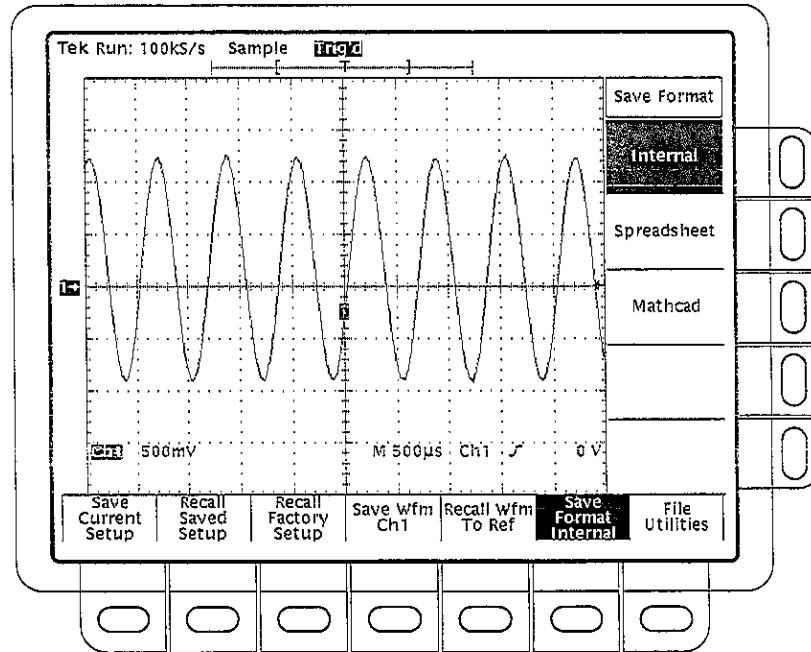

Figure 3-32: Save Format menu

Saving a Waveform to the Disk

To store a waveform to disk, insert a formatted 720 Kbyte or 1.44 Mbyte floppy disk into the slot at the top of the oscilloscope. Press the main-menu button Save Wfm and then the side-menu button To File. Use the general purpose knob to select the exact file from the resulting scrollbar list. Finally, press the side-menu button Save To Selected File to complete the operation.

Recalling a Waveform from the Disk

To recall a waveform from disk to an internal reference memory, press the front-panel button SAVE/RECALL and then the main-menu button Recall Wfm To Ref. Use the general purpose knob to select the exact file from the resulting scrollbar list. Only files with .ISF extensions are displayed. Finally, press either the side-menu button To Ref1 or To Ref2 to complete the operation.

NOTE. You can only recall waveforms saved with the .ISF extension. You cannot read files saved with .DAT or .CSV extensions back into the oscilloscope.

Viewing a Waveform on a Spreadsheet

To save a waveform and view the waveform data using a spreadsheet (this example uses EXCEL):

1. With a disk in the disk drive, press the front-panel button SAVE/RECALL, the main-menu button Save Format, and then the side-menu button Spreadsheet.
2. Press the main-menu button Save Wfm, the side-menu button To File, and then the side-menu button Save to Selected File.
3. Remove the disk and place it in your computer drive.
4. Start EXCEL.
5. Using the EXCEL File menu, select Open. From the List Files of Type menu, select Text Files (*.pm, *.txt, *.csv). From the Drives menu, select the drive containing the waveform file. From the File Name menu, select the name of the waveform file. Now select OK.

For information on the CSV data format, see *Selecting the Save Format* on page 3-47.

Running the File Utilities

To run file utilities, see *Using the File System* on page 3-55.

Saving and Recalling Front-Panel Setups

TDS 300 Series oscilloscopes can store up to ten front-panel setups in internal memory for an indefinite period. You can also save and recall setups to and from a floppy disk. To access front-panel save and recall features, press the SAVE/RECALL button, shown in Figure 3-33.

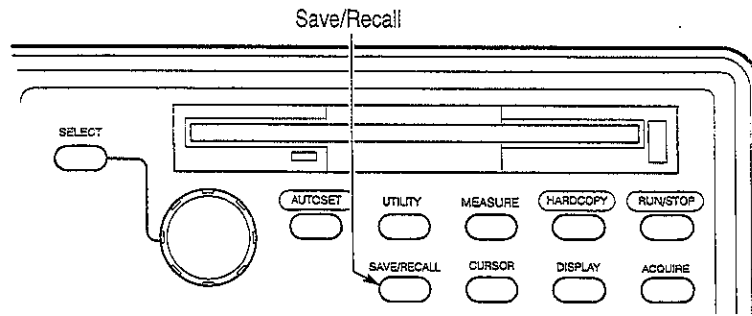

Figure 3-33: The SAVE/RECALL button

Pressing the button activates the save/recall menu, shown in Figure 3-34.

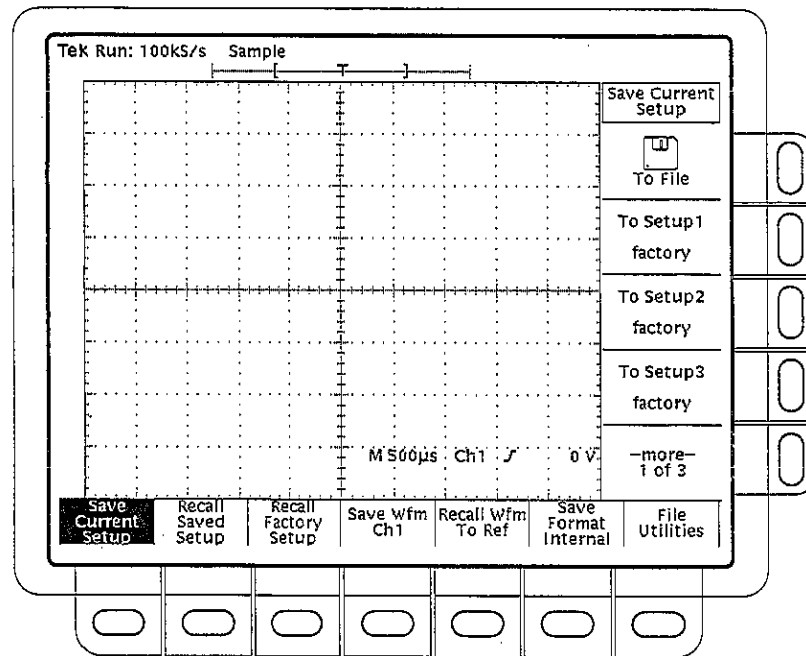

Figure 3-34: The save/recall menu

Using Internal Memory

Internal, nonvolatile memory contains locations to store up to ten oscilloscope setups.

NOTE. *The Tek Secure feature (page 3–59) will erase all saved setups.*

Saving the Current Setup

To save the current setup, press the front-panel button SAVE/RECALL and then the main-menu button Save Current Setup. Select a setup from the side menu (press the lowermost side-menu button, labeled –more– x of 3, to page through the setups). Finally, press the side-menu button OK Overwrite Saved Setup.

Recalling a Setup

To recall a setup from internal memory, press the front-panel button SAVE/RECALL and then press the main-menu button Recall Saved Setup. Select a destination setup memory from the side menu (press the lowermost side-menu button, labeled –more– x of 3, to page through the setups).

Recalling a setup does not change the menu that is currently displayed. If you recall a setup that is labeled *factory* in the side menu, you recall the factory setup. (The conventional method for recalling the factory setup is described below.)

Recalling the Factory Setup

To recall the default factory setup, press the front-panel button SAVE/RECALL and then press the main-menu button Recall Factory Setup. Press the side-menu button OK Confirm Factory Init to complete the initialization.

Using the Disk

The disk drive can provide mass storage for an unlimited number of oscilloscope setups.

NOTE. *Setups are not transferable between different oscilloscope models or software versions.*

Saving the Current Setup

To save a setup on a formatted disk, insert a formatted 720 Kbyte or 1.44 Mbyte floppy disk into the slot at the top of the oscilloscope. Press the front-panel button SAVE/RECALL, the main-menu button Save Setup, and then the side-menu button To File. Use the general purpose knob to select the exact file from the resulting scrollbar list. Finally, press the side-menu Save To Selected File to complete the operation.

Recalling a Setup

To recall a setup stored on disk, press the front-panel button SAVE/RECALL, the main-menu button Recall Setup, and then the side-menu button From File. Use the general purpose knob to select the exact file from the resulting scrollbar list. Only files with *.set* extensions will be displayed. Finally, press the side-menu Recall From Selected File to complete the operation.

Running the File Utilities

To run file utilities, see *Using the File System* on page 3-55.

Using the File System

The TDS 300 oscilloscopes provide file utilities and a floppy disk drive for saving hard copies, setups, and waveforms. This section describes how to manage (delete, rename, and so forth) these files using the file system. Read the sections listed under *For More Information* on page 3-58 for information on saving hard copies, setups, and waveforms.

Accessing the File Utilities

The File Utilities menu lets you delete, rename, copy, print files, create a new directory, operate the confirm delete and overwrite lock, and format disks.

To bring up the File Utilities menu:

1. Press the SAVE/RECALL button.
2. Press File Utilities in the main menu to bring up the File Utilities side menu. (See Figure 3-35.)

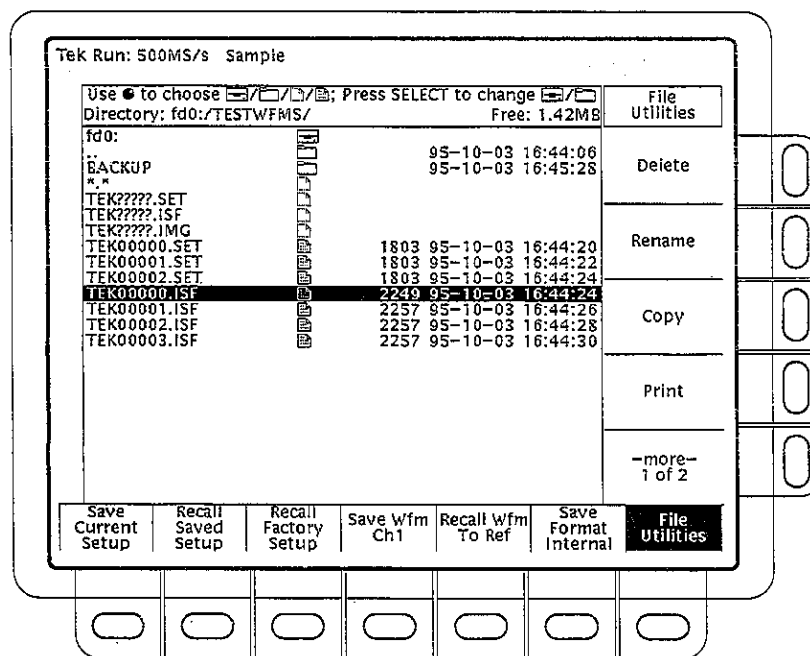

Figure 3-35: File utilities

NOTE. *The amount of free space on the disk is shown in the upper right corner of the display. The display shows the amount in Kbytes (or in Mbytes if the free space is 1 Mbyte or more).*

Bytes are only shown if the free space is less than 1 Kbyte. Kbytes are only shown if the free space is 1 Kbyte or more, but less than 1 Mbyte. 1 Mbyte is shown if the free space is 1 Mbyte or more.

Deleting a File or Directory

To delete a file or directory, turn the general purpose knob until it scrolls the cursor over the name of the file or directory to delete. Then, press the side-menu button Delete.

To delete all files in the file list, set the cursor to the *.* selection.

The oscilloscope deletes directories recursively. That means it deletes both the directory and all its contents.

Renaming a File or Directory

To rename a file or directory, turn the general purpose knob until it scrolls the cursor over the name of the file or directory to rename. For example, to rename the target file whose default name is TEK????? set the cursor over its name. Then, press the side-menu button Rename.

The labelling menu should appear. Turn the general purpose knob or use the main-menu arrow keys to select each letter. Press Enter Char from the main menu to enter each letter. When you have entered the name, press the side-menu button OK Accept. (See Figure 3-36).

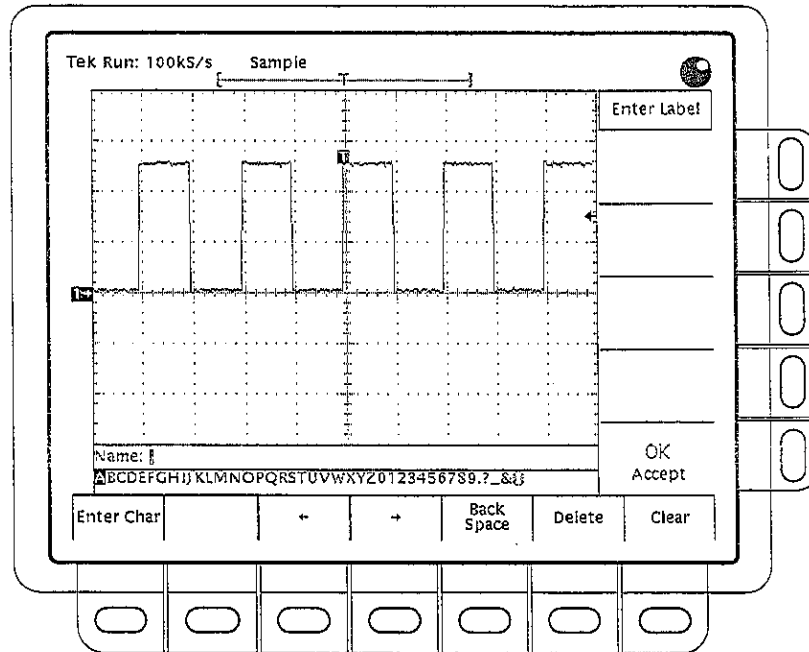

Figure 3-36: File system — Labelling menu

Copying a File or Directory

To copy a file or directory, turn the general purpose knob until it scrolls the cursor over the name of the file to copy. Then, press the side menu button Copy. The file menu reappears with the names of directories to copy to. Select a directory and press the side-menu button Copy <name> to Selected Directory.

To copy all files, select the *.* entry.

The oscilloscope copies all directories recursively. That means it copies both the directory and all its contents.

Printing a File

To print a file, turn the general purpose knob until it scrolls the cursor over the name of the file to print. Then, press the side-menu button Print.

The Print-To side menu should appear. Select the port to print to from GPIB, RS-232, or Centronics. (See Figure 3-36.) Then the oscilloscope sends the file in its raw form out the port. The device (printer) receiving the file must be capable of printing the particular file format.

Creating a Directory

To create a new directory, press the side-menu button Create Directory.

The labelling menu appears. Turn the general purpose knob or use the main-menu arrow keys to select each letter. Press Enter Char from the main menu to enter each letter. When you have entered the name, press the side-menu button OK Accept. (See Figure 3-36.)

- Setting Confirm Delete** To turn on or off the confirm delete message, toggle the side-menu button Confirm Delete.
- When the confirm delete option is OFF, the oscilloscope can immediately delete files or directories. When the confirm option is ON, the oscilloscope warns you before it deletes files and gives you a chance to reconsider.
- Setting Override Lock** To turn on or off the file overwrite lock, toggle the side-menu button Overwrite Lock.
- When overwrite lock is on, the oscilloscope will not permit you to write over an existing file of the same name. An important reason to allow overwriting is to let you write files using a target file name that contains wild card characters ("?"). This means the oscilloscope creates sequential files whose names are similar except for the sequential numbers that go in the real name in the place of the question marks.
- Formatting a Disk** To format a 720 Kbyte or 1.44 Mbyte disk, turn the general purpose knob until it scrolls the cursor over the name of the drive to format in. (fd0:) Then, press the side-menu button Format.
- For More Information** See *Making Hard Copies*, on page 3-41.
- See *Saving and Recalling Front-Panel Setups*, on page 3-51.
- See *Saving and Recalling Waveforms*, on page 3-45.

Using the Utility Menu

The utility menu is actually four menus in one. Access these menus by pressing the **UTILITY** button (Figure 3-37) and then the leftmost main-menu button. The pop-up menu (see Figure 3-38) shows these options.

- The Config menu offers Tek Secure (which overwrites all setup and reference memories) and the software version identifier as main menu selections.
- The I/O menu (Option 14 instruments only) pertains to making hardcopies (see page 3-41) and remote operations (refer to the *TDS 340A*, *TDS 360* & *TDS 380 Programmer Manual*).
- The Cal menu, which you should only use in conjunction with the adjustment procedures.
- The Diag menu, which you should only use in conjunction with the Self Test.

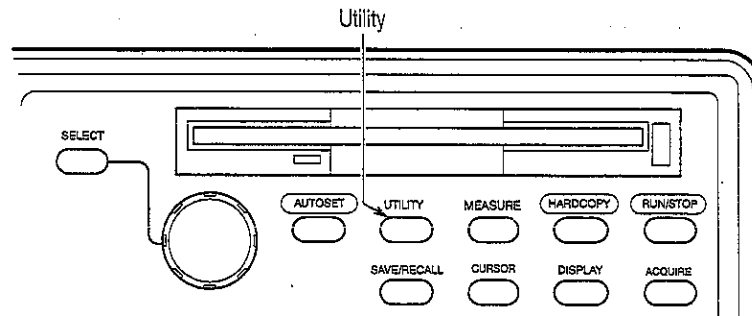

Figure 3-37: The **UTILITY** button

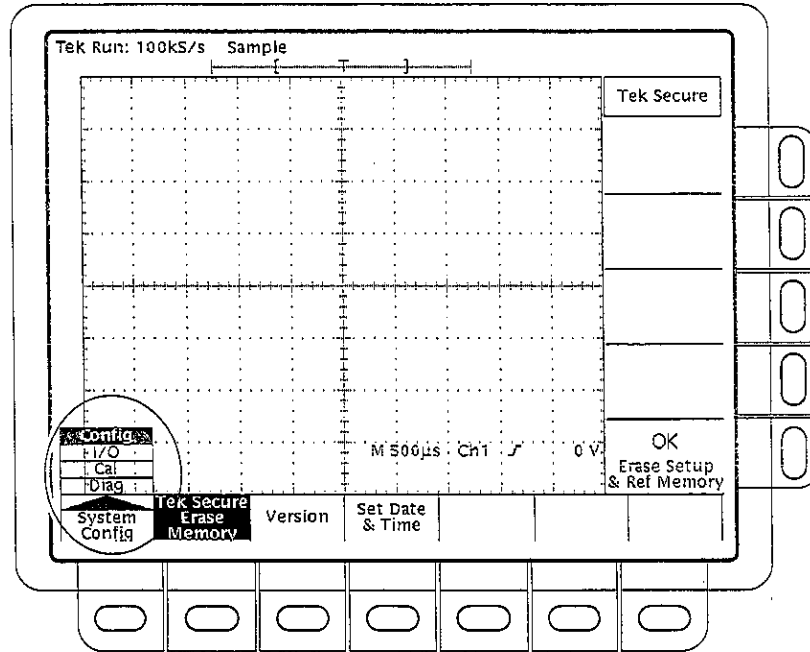

Figure 3-38: The utility pop-up menu

Setting the Date and Time

If you need to set the date and time of the oscilloscope, do the following steps:

1. Press the front-panel button **UTILITY**, the main-menu button **System**, and then select the popup-menu item **Config**
2. Press the main-menu button **Set Date & Time**.

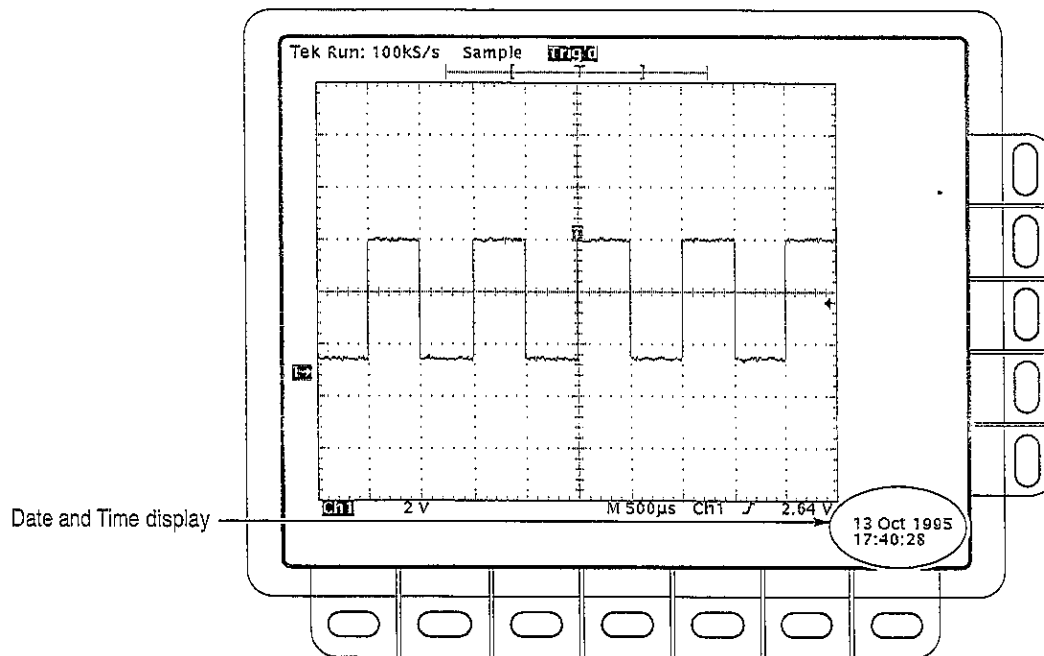

Figure 3-39: Date and time display

3. Press the side-menu button Year, Day Month, Hour, or Minute. Use the general purpose knob to set the parameter you have chosen to the value desired.
4. Repeat step 3 to set other parameters as desired.
5. Press the side menu button OK Enter Date/Time to put the new settings into effect. This sets the seconds to zero.

NOTE. When setting the clock, you can set to a time slightly later than the current time and wait for it to catch up. When current time catches up to the time you have set, pressing Ok Enter Date/Time synchronizes the set time to the current time.

6. Press CLEAR MENU to see the date/time displayed with the new settings. If the date and time is not in the display, you need to enable it. Refer to *Add or Remove Date/Time Stamp* on page 3-29 for information about how to enable the date and time display.

Appendix A: Specifications

This appendix contains complete specifications for the TDS 340A, TDS 360, and TDS 380. The specifications are divided into three subsections, one for each of three classes of traits: *Warranted Characteristics*, *Typical Characteristics*, and *Nominal Traits*.

Warranted Characteristics

Warranted characteristics are described in terms of quantifiable performance limits that are warranted. This subsection lists only warranted characteristics.

NOTE. In these tables, those warranted characteristics that are checked in the Performance Tests, starting on page B-5, appear in boldface type under the column Name.

Performance Conditions

The electrical characteristics found in these tables of warranted characteristics apply when the oscilloscope has been adjusted at an ambient temperature between +20° C and +30° C, has had a warm-up period of at least 20 minutes, and is operating at an ambient temperature between -10° C and +55° C (unless otherwise noted).

Table A-1: Warranted characteristics — signal acquisition system

Name	Description	
Accuracy, DC Voltage Measurement, Average Acquisition Mode	Measurement type	DC accuracy
	Average of ≥ 16 waveforms	$\pm(2.0\% \times (\text{reading} - \text{Net Offset}^1) + \text{Offset Accuracy} + 0.1 \text{ div})$
	Delta volts between any two averages of ≥ 16 waveforms acquired under the same setup and ambient conditions	$\pm(2.0\% \times \text{reading} + 0.15 \text{ div} + 0.3 \text{ mV})$
Accuracy, DC Gain, Sample or Average Acquisition Modes	$\pm 2\%$	
Pulse Response, Peak Detect and Envelope Mode	Sec/Div setting	Minimum pulse width
	5 s/div – 25 $\mu\text{s}/\text{div}$	10 ns
	TDS 340A: 10 $\mu\text{s}/\text{div}$ – 5 ns/div TDS 360: 10 $\mu\text{s}/\text{div}$ – 2.5 ns/div TDS 380: 10 $\mu\text{s}/\text{div}$ – 1 ns/div	The greater of 10 ns or $.02 \times \text{sec/div setting}$

Table A-1: Warranted characteristics — signal acquisition system (Cont.)

Name	Description	
Accuracy, Offset	Volts/Div setting	Offset accuracy
	2 mV/div – 99.5 mV/div	$\pm(0.4\% \times \text{INet Offset}^1)$ + 3 mV + 0.1 div \times V/div setting)
	100 mV/div – 995 mV/div	$\pm(0.4\% \times \text{INet Offset}^1)$ + 30 mV + 0.1 div \times V/div setting)
	1 V/div – 10 V/div	$\pm(0.4\% \times \text{INet Offset}^1)$ + 300 mV + 0.1 div \times V/div setting)
Analog Bandwidth, DC Coupled	TDS 340A: DC – ≥ 100 MHz TDS 360: DC – ≥ 200 MHz; DC – ≥ 180 MHz for 2 mV/div TDS 380: DC – ≥ 400 MHz; DC – ≥ 250 MHz for 2 mV/div	
Cross Talk (Channel Isolation)	$\geq 100:1$ at 50 MHz with equal Volts/Div settings on each channel	
Input Impedance, DC-Coupled	TDS 340A: 1 M Ω $\pm 1\%$ in parallel with 20 pF ± 2.0 pF TDS 360: 1 M Ω $\pm 1\%$ in parallel with 20 pF ± 2.0 pF TDS 380: 1 M Ω $\pm 1\%$ in parallel with 12 pF ± 2.0 pF	
Input Voltage, Maximum	± 300 V (DC or AC) CAT II; derate at 20 dB/decade above 100 kHz to 13 V peak AC at 3 MHz and above	
Lower Frequency Limit, AC Coupled ²	≤ 10 Hz	

¹ Net Offset = Offset – (Position \times Volts/Div). Net offset is the voltage level at the center of the A-D converter dynamic range. Offset Accuracy is the accuracy of this voltage level.

² The AC Coupled Lower Frequency Limits are reduced by a factor of 10 when 10X, passive probes are used.

Table A-2: Warranted characteristics — time base system

Name	Description
Accuracy, Long Term Sample Rate and Delay Time	± 100 ppm over any ≥ 1 ms interval
Accuracy, Delta Time Measurements ^{1, 2}	For single-shot acquisitions using sample acquisition mode and a bandwidth limit setting of FULL: $\pm(1 \text{ WI} + 100 \text{ ppm} \times \text{Reading} + 0.6 \text{ ns})$ For repetitive acquisitions using average acquisition mode with ≥ 16 averages and a bandwidth limit setting of FULL: $\pm(1 \text{ WI} + 100 \text{ ppm} \times \text{Reading} + 0.4 \text{ ns})$

¹ For input signals ≥ 5 divisions in amplitude and a slew rate of ≥ 2.0 divisions/ns at the delta time measurement points. Signal must be acquired at a volts/division setting ≥ 5 mV/division.

² The WI (waveform interval) is the time between the samples in the waveform record. Also, see the footnotes for *Sample Rate Range* and *Equivalent Time or Interpolated Waveform Rates* in Table A-11 on page A-8.

Table A-3: Warranted characteristics — triggering system

Name	Description	
Accuracy, Trigger Level, DC Coupled	Trigger source	Sensitivity
	CH1 or CH2	$\pm(3\% \text{ of } \text{Setting} - \text{Net Offset} ^1 + 0.2 \text{ div} \times \text{volts/div setting} + \text{Offset Accuracy})$
	External	$\pm(6\% \text{ of } \text{Setting} + 20 \text{ mV})$
	External/10	$\pm(6\% \text{ of } \text{Setting} + 200 \text{ mV})$
Sensitivity, Edge-Type Trigger, DC Coupled	Trigger source	Sensitivity
	CH1 or CH2	TDS 340A: 0.35 division from DC to 20 MHz, increasing to 1 div at 100 MHz TDS 360: 0.35 division from DC to 50 MHz, increasing to 1 div at 200 MHz TDS 380: 0.35 division from DC to 50 MHz, increasing to 1 div at 400 MHz
	External	TDS 340A: 50 mV from DC to 20 MHz, increasing to 150 mV at 100 MHz TDS 360: 50 mV from DC to 50 MHz, increasing to 150 mV at 200 MHz TDS 380: 50 mV from DC to 50 MHz, increasing to 500 mV at 400 MHz
	External/10	TDS 340A: 500 mV from DC to 20 MHz, increasing to 1.5 V at 100 MHz TDS 360: 500 mV from DC to 50 MHz, increasing to 1.5 V at 200 MHz TDS 380: 500 mV from DC to 50 MHz, increasing to 5.0 V at 400 MHz
	Input Impedance, External Trigger	1 M Ω \pm 2% in parallel with 20 pF \pm 2 pF
	Maximum Input Voltage, External Trigger	\pm 300 V (DC or AC) CAT II; derate at 20 dB/decade above 100 kHz to 13 V peak AC at 3 MHz and above

¹ Net Offset = Offset – (Position \times Volts/Div). Net Offset is the voltage level at the center of the A-D converter dynamic range. Offset Accuracy is the accuracy of this voltage level.

Table A-4: Power Requirements

Name	Description
Source Voltage and Frequency	90 to 132 VAC _{RMS} , continuous range, for 47 Hz through 440 Hz 132 to 250 VAC _{RMS} , continuous range, for 47 Hz through 63 Hz
Power Consumption	\leq 65 Watts (120 VA)

Table A-5: Warranted characteristics — environmental

Name	Description
Atmospherics	<p>Temperature without diskette in floppy disk drive: +4° C to +50° C, operating; -22° C to +60° C, non-operating</p> <p>Temperature with diskette in floppy disk drive: +10° C to +50° C, operating or non-operating</p> <p>Relative humidity without diskette in floppy disk drive: to 80% at or below +29° C, or to 20% from +30° C to +50° C, operating; to 90% at or below +40° C, or to 5% from +41° C to +50° C, non-operating;</p> <p>Relative humidity with diskette in floppy disk drive: to 80% at or below +29° C, or to 20% from +30° C to +50° C, operating or non-operating</p> <p>Altitude: To 15,000 ft (4570 m), operating; to 40,000 ft (12190 m), non-operating</p>
Dynamics	<p>Random vibration without diskette in floppy disk drive: 0.31 g_{RMS}, from 5 to 500 Hz, 10 minutes each axis, operating; 2.46 g_{RMS}, from 5 to 500 Hz, 10 minutes each axis, non-operating</p>

Typical Characteristics

Typical characteristics are described in terms of typical or average performance. Typical characteristics are not warranted.

Table A-6: Typical characteristics — signal acquisition system

Name	Description			
Accuracy, DC Gain, Envelope Acquisition Mode	$\pm 3\%$ for sec/div settings from 5 Sec/Div to 25 $\mu\text{sec}/\text{div}$; $\pm 2\%$ for sec/div settings from 10 $\mu\text{s}/\text{div}$ to 5 ns/div (TDS 340A); $\pm 2\%$ for sec/div settings from 10 $\mu\text{s}/\text{div}$ to 2.5 ns/div (TDS 360); $\pm 2\%$ for sec/div settings from 10 $\mu\text{s}/\text{div}$ to 1 ns/div (TDS 380)			
Accuracy, DC Voltage Measurement, Sample Acquisition Mode	Measurement type	DC accuracy		
	Any Sample	$\pm(2.0\% \times (\text{Ireading} - \text{Net Offset}^1)) + \text{Offset Accuracy} + 0.13 \text{ div} + 0.6 \text{ mV}$		
	Delta Volts between any two samples ² acquired under the same setup and ambient conditions	$\pm(2.0\% \times \text{Ireading} + 0.26 \text{ div} + 1.2 \text{ mV})$		
Frequency Limit, Upper, 20 MHz Bandwidth Limited	20 MHz			
Step Response Settling Error	Volts/Div setting	Step amplitude	Settling error (%) ³	
			100 ns	20 ms
	2 mV/div – 99.5 mV/div	$\leq 2 \text{ V}$	≤ 1.0	≤ 0.1
	100 mV/div – 995 mV/div	$\leq 20 \text{ V}$	≤ 1.5	≤ 0.2
	1 V/div – 10 V/div	$\leq 200 \text{ V}$	≤ 2.5	≤ 0.2
Common Mode Rejection Ratio (CMRR)	100:1 at 60 Hz, reducing to 20:1 at 50 MHz, with equal Volts/Div and Coupling settings on each channel.			

¹ Net Offset = Offset – (Position \times Volts/Div). Net Offset is the voltage level at the center of the A-D converter dynamic range. Offset Accuracy is the accuracy of this voltage level.

² The samples must be acquired under the same setup and ambient conditions.

³ The values given are the maximum absolute difference between the value at the end of a specified time interval after the mid-level crossing of the step, and the value one second after the mid-level crossing of the step, expressed as a percentage of the step amplitude.

Table A-7: Typical characteristics — triggering system

Name	Description	
Error, Trigger Position, Edge Triggering	Acquire mode	Trigger-position error ^{1,2}
	Sample, Average	$\pm(1 \text{ WI} + 2 \text{ ns})$
	Peak Detect, Envelope	$\pm(2 \text{ WI} + 2 \text{ ns})$
Sensitivity, Video-Type Trigger	Source	Typical sensitivity
	CH1 or CH2	0.6 division of video sync signal
	External	75 mV of video sync signal
External/10	750 mV of video sync signal	
Lowest Frequency for Successful Operation of "Set Level to 50%" Function	50 Hz	
Sensitivity, Edge Type Trigger, Not DC Coupled ³	Trigger coupling	Typical signal level for stable triggering
	AC	Same as DC-coupled limits ⁴ for frequencies above 60 Hz. Attenuates signals below 60 Hz.
	Noise Reject	Three and one half times the DC-coupled limits. ⁴
	High Frequency Reject	One and one half times times the DC-coupled limits ⁴ from DC to 30 kHz. Attenuates signals above 30 kHz.
	Low Frequency Reject	One and one half times the DC-coupled limits ⁴ for frequencies above 80 kHz. Attenuates signals below 80 kHz.

- ¹ The trigger position errors are typically less than the values given here. These values are for triggering signals having a slew rate at the trigger point of ± 0.5 division/ns.
- ² The waveform interval (WI) is the time between the samples in the waveform record. Also, see the footnote for the characteristics *Sample Rate Range* and *Equivalent Time or Interpolated Waveform Rates* in Table A-11 on page A-8.
- ³ The minimum sensitivity for obtaining a stable trigger. A stable trigger results in a uniform, regular display triggered on the selected slope. The trigger point must not switch between opposite slopes on the waveform, and the display must not "roll" across the screen on successive acquisitions. The TRIG'D LED stays constantly lighted when the SEC/DIV setting is 2 ms or faster but may flash when the SEC/DIV setting is 10 ms or slower.
- ⁴ See the characteristic *Sensitivity, Edge-Type Trigger, DC Coupled* in Table A-3, which begins on page A-3.

Table A-8: Typical characteristics — probe compensator output

Name	Description	
Output Voltage and Frequency, Probe Compensator	Characteristic	
	Voltage	5.0 V (low-high) into a 1 M Ω load
	Frequency	1 kHz

Table A-9: Typical characteristics — data handling

Name	Description
Time, Data-Retention, Nonvolatile Memory ^{1,2}	≥5 Years

¹ The time that reference waveforms, stored setups, and calibration constants are retained when there is no power to the oscilloscope.

² Data is maintained by a lithium poly-carbon monofluoride battery.

Nominal Traits

Nominal traits are described using simple statements of fact such as “Two, identical” for the trait “Input Channels, Number of,” rather than in terms of limits that are performance requirements.

Table A-10: Nominal traits — signal acquisition system

Name	Description	
Bandwidth Selections	20 MHz and FULL	
Digitizers, Number of	Two, identical, digitized simultaneously	
Digitized Bits, Number of	8 bits ¹	
Input Channels, Number of	Two, identical, called CH 1 and CH 2	
Input Coupling	DC, AC, or GND	
Ranges, Offset, All Channels	Volts/Div setting	Offset range
	2 mV/div – 99.5 mV/div	±1 V
	100 mV/div – 995 mV/div	±10 V
	1 V/div – 10 V/div	±100 V
Range, Position	±5 divisions	
Range, Sensitivity ²	2 mV/div to 10 V/div	
Rise Time	TDS 340A: 3.5 ns TDS 360: 1.75 ns TDS 380: 875 ps	
TekProbe Interface	Level one probe coding	

¹ Displayed vertically with 25 digitization levels (DLs) per division and 10.24 divisions dynamic range with zoom off. A DL is the smallest voltage level change that the 8-bit A-D Converter can resolve, with the input scaled to the volts/division setting of the channel used. Expressed as a voltage, a DL is equal to 1/25 of a division times the volts/division setting.

² The sensitivity ranges from 2 mV/div to 10 V/div in a 1–2–5 sequence of coarse settings. Between consecutive coarse settings, the sensitivity can be finely adjusted with a resolution of 1% of the more sensitive setting. For example, between 50 mV/div and 100 mV/div, the volts/division can be set with 0.5 mV resolution.

Table A-11: Nominal traits — time base system

Name	Description
Range, Sample-Rate ^{1,2}	TDS 340A: 10 Samples/s to 500 MSamples/s in a 1–2–5 sequence TDS 360: 10 Samples/s to 1 GSamples/s in a 1–2–5 sequence TDS 380: 10 Samples/s to 2 GSamples/s in a 1–2–5 sequence
Range, Seconds/Division	TDS 340A: 5 ns/div to 5 s/div in a 1–2.5–5 sequence TDS 360: 2.5 ns/div to 5 s/div in a 1–2.5–5 sequence TDS 380: 1 ns/div to 5 s/div in a 1–2.5–5 sequence
Range, Time Base Delay Time	16.5 ns to 50 seconds
Record Length	1,000 samples

- ¹ The range of real-time rates, expressed in samples/second, at which a digitizer samples signals at its inputs and stores the samples in memory to produce a record of time-sequential samples
- ² The Waveform Rate (WR) is the equivalent sample rate of a waveform record. For a waveform record acquired by real-time sampling of a single acquisition, the waveform rate is the same as the real-time sample rate; for a waveform created by interpolation of real-time samples from a single acquisition or by equivalent-time sampling of multiple acquisitions, the waveform rate is faster than the real time sample rate. For all three cases, the waveform rate is $1/(\text{Waveform Interval})$ for the waveform record, where the waveform interval (WI) is the time between the samples in the waveform record.

Table A-12: Nominal traits — triggering system

Name	Description	
Range, Hold Off	500 ns minimum to 10 seconds maximum	
Ranges, Trigger Level	Source	Range
	Any Channel	±12 divisions from center of screen
	External	±1.5 Volts
	External /10	±15 Volts
	Line	±300 Volts
Formats and Field Rates, Video Trigger	Triggers from sync-negative composite video, 525 to 625 lines, 50 Hz to 60 Hz, interlaced or noninterlaced systems with scan rates from 15 kHz to 65 kHz – such as NTSC, PAL, or SECAM	
TekProbe Interface, External Trigger	Level one probe coding	

Table A-13: Nominal traits — display system

Name	Description
CRT Type	7-inch (17.95 cm) diagonal, magnetic deflection; horizontal raster-scan; P31 green phosphor
Video Display Resolution	640 pixels horizontally by 480 pixels vertically Display area is 5.04 inch (12.92 cm) horizontally by 3.78 inch (9.69 cm) vertically
Waveform Display Graticule	A single graticule 401 × 501 pixels (8 × 10 divisions, with divisions that are approximately 1 cm by 1 cm)
Intensity Levels	Dim and Bright, with adjustable Overall Intensity and Contrast

Table A-14: Nominal traits — I/O interface option

Name	Description
GPIB	Part of Option 14 I/O interface or TD3F14A I/O interface field upgrade kit; complies with IEEE Std 488-1987
RS-232	Part of Option 14 I/O interface or TD3F14A I/O interface field upgrade kit; a 9-pin male DTE RS-232 interface that complies with EIA/TIA 574-90
Centronics	Part of Option 14 I/O interface or TD3F14A I/O interface field upgrade kit; a 25-pin, IBM PC-type, parallel printer interface that complies electrically with Centronics C332-44, Rev A
Video Signal Output (Option 14 Only)	DB-9 rear panel Video connector; non-interlaced, with levels that comply with ANSI RS343A VGA compatible at a 30.6 kHz sync rate
Power Supply, Printer (Option 14 Only)	Power supply connector to supply power to the Option 3P Printer Pack

Table A-15: Nominal traits — power distribution system

Name	Description
Fuse Rating	5 mm × 20 mm, 3.15 A (T), 250 V; or 1.25 in × 0.25 in, 3 A (T), 250 V

Table A-16: Nominal traits — mechanical characteristics

Name	Description
Weight	
Standard	7.0 kg (15.5 lbs) stand-alone instrument; 8.6 kg (19 lbs) with front cover, accessories, and accessories pouch installed; 12.9 kg (28.5 lbs) when packaged for domestic shipment
Rackmount	6.6 kg (14.5 lbs), plus weight of rackmount parts (Option 1R); 14.7 kg (32.5 lbs) when the rackmounted oscilloscope is packaged for domestic shipment
Rackmount conversion kit	4.5 kg (10 lbs); 7.5 kg (17.5 lbs) when kit is packaged for domestic shipment
Overall Dimensions	
Standard Instrument (Figure A-1)	Height: 191 mm (7.5 in) with feet and accessories pouch installed 165 mm (6.5 in) without the accessories pouch installed Width: 362 mm (14.25 in) with handle Depth: 471 mm (18.55 in) stand-alone instrument 490 mm (19.28 in) with front cover installed 564 mm (22.2 in) with handle extended
Rackmount Instrument	Height: 178 mm (7 in) Width: 483 mm (19 in) Depth: 472 mm (18.6 in) without handles; 517 mm (20.35 in) including handles

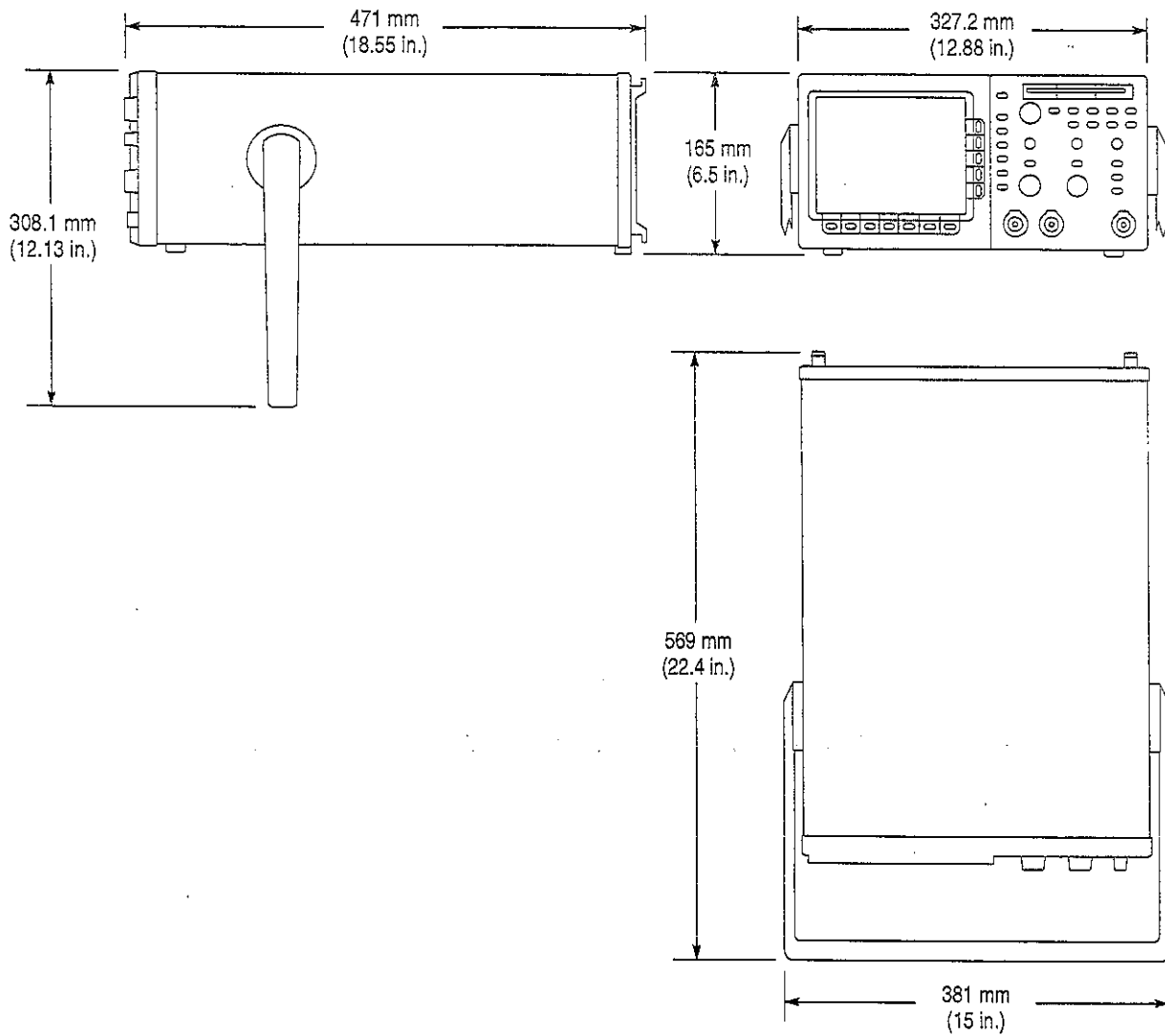

Figure A-1: TDS 340A, TDS 360, and TDS 380 dimensions

Table A-17: Certifications and compliances

EC Declaration of Conformity	<p>Meets intent of Directive 89/336/EEC for Electromagnetic Compatibility and Low Voltage Directive 73/23/EEC for Product Safety. Compliance was demonstrated to the following specifications as listed in the Official Journal of the European Communities:</p> <p>EMC Directive 89/336/EEC: EN 55011 Class B Radiated and Conducted Emissions ¹ EN 50081-1 Emissions: EN 60555-2 AC Power Line Harmonic Emissions EN 50082-1 Immunity: IEC 801-2 Electrostatic Discharge Immunity IEC 801-3 RF Electromagnetic Field Immunity ² IEC 801-4 Electrical Fast Transient/Burst Immunity IEC 801-5 Power Line Surge Immunity</p> <p>Low Voltage Directive 73/23/EEC: EN 61010-1 Safety requirements for electrical equipment for measurement, control, and laboratory use</p> <p>¹ To maintain emission requirements when connecting to the I/O interface of this oscilloscope, use only a high-quality, double-shielded (braid and foil) cable. The cable shield must have low-impedance connections to both connector housings. The VGA cable must also have a ferrite core at both ends. Acceptable cables are listed in Table C-6 on page C-4.</p> <p>² Performance criteria: $\leq \pm 0.3$ division waveform displacement, or ≤ 0.6 division increase in p-p noise from 27 MHz to 500 MHz. Test conditions: both channel inputs terminated with grounding caps, both channels set to 10 mV/div, both channels set to DC Coupling, trigger source set to CH 1, acquisition mode set to Sample, and time base set to 250 μs/div.</p>								
Certifications	<p>Underwriters Laboratories listing to Standard UL3111-1 for Electrical Measuring and Test Equipment. ^{3 4}</p> <p>Canadian Standards Association certified to Standard CAN/CSA-C22.2 No. 1010.1-92. ³</p> <p>³ These standards are North American interpretations of IEC 1010.</p> <p>⁴ Conditions for certification: operating temperature -10° C to $+55^{\circ}$ C, maximum operating altitude 2000 m, Safety Class I (IEC 1010-1 Annex H), Overvoltage Category II (IEC 1010-1 Annex J), Pollution Degree 2 (IEC 1010-1).</p>								
FCC Compliance	Emissions comply with FCC Code of Federal Regulations 47, Part 15, Subpart B, Class A Limits								
CSA Certified Power Cords	CSA Certification includes the products and power cords appropriate for use in the North America power network. All other power cords supplied are approved for the country of use.								
Overvoltage Category	<table border="0"> <tr> <td>Category:</td> <td>Examples of Products in this Category:</td> </tr> <tr> <td>CAT III</td> <td>Distribution-level mains, fixed installation</td> </tr> <tr> <td>CAT II</td> <td>Local-level mains, appliances, portable equipment</td> </tr> <tr> <td>CAT I</td> <td>Signal levels in special equipment or parts of equipment, telecommunications, electronics</td> </tr> </table>	Category:	Examples of Products in this Category:	CAT III	Distribution-level mains, fixed installation	CAT II	Local-level mains, appliances, portable equipment	CAT I	Signal levels in special equipment or parts of equipment, telecommunications, electronics
Category:	Examples of Products in this Category:								
CAT III	Distribution-level mains, fixed installation								
CAT II	Local-level mains, appliances, portable equipment								
CAT I	Signal levels in special equipment or parts of equipment, telecommunications, electronics								
Pollution Degree 2	Do not operate in environments where conductive pollutants may be present.								

Appendix B: Performance Verification

The procedure in this appendix verifies that the TDS 340A, TDS 360, and TDS 380 oscilloscopes meet warranted specifications. Depending on what you want to accomplish, you may prefer to perform another procedure you can find elsewhere in this manual.

- To rapidly confirm that this oscilloscope functions, just do the procedures under *Self Tests*, which begin on page 1-5.

Advantages: This procedure is quick to do, requires no external equipment or signal sources, and performs extensive functional and accuracy testing to provide high confidence that the oscilloscope performs properly. You can use it as a quick check before making a series of important measurements.

- To further check functionality, do the procedures under *Functional Tests* that begin on page 1-7.

Advantages: These procedures require minimal additional time to perform, require no additional equipment other than a standard-accessory probe, and more completely test the internal hardware of this oscilloscope. You can use them to quickly determine if the oscilloscope is suitable for putting into service, such as when it is first received.

- If you need a more extensive confirmation of performance, do the *Performance Tests* in this appendix, beginning on page B-5, after doing the *Functional* and *Self Tests* just referenced.

Advantages: These procedures add direct checking of warranted specifications. They require more time and suitable test equipment. (See *Equipment Required* on page B-3.)

Conventions

Throughout these procedures the following conventions apply:

- Each test procedure uses the following general format:

- Title of Test
- Equipment Required
- Time Required
- Prerequisites
- Procedure

- Refer to Figure B-1: "Main menu" refers to the menu that labels the seven menu buttons under the display. "Side menu" refers to the menu that labels

the five buttons to the right of the display. “Pop-up menu” refers to a menu that pops up when a main menu button is pressed.

- Where instructed to use a front-panel button or knob, select from a main or side menu, or verify a readout or status message, the name of the button or knob appears in boldface type.
- Instructions for menu selection follow this format: **FRONT PANEL BUTTON** → **Pop-Up** (if necessary) → **Main Menu Button** → **Side Menu Button**. For example, “Push **TRIGGER MENU** → **Type: Video** → **Trigger On** → **Lines**.”

***STOP.** This symbol denotes information you must read to do the procedure properly.*

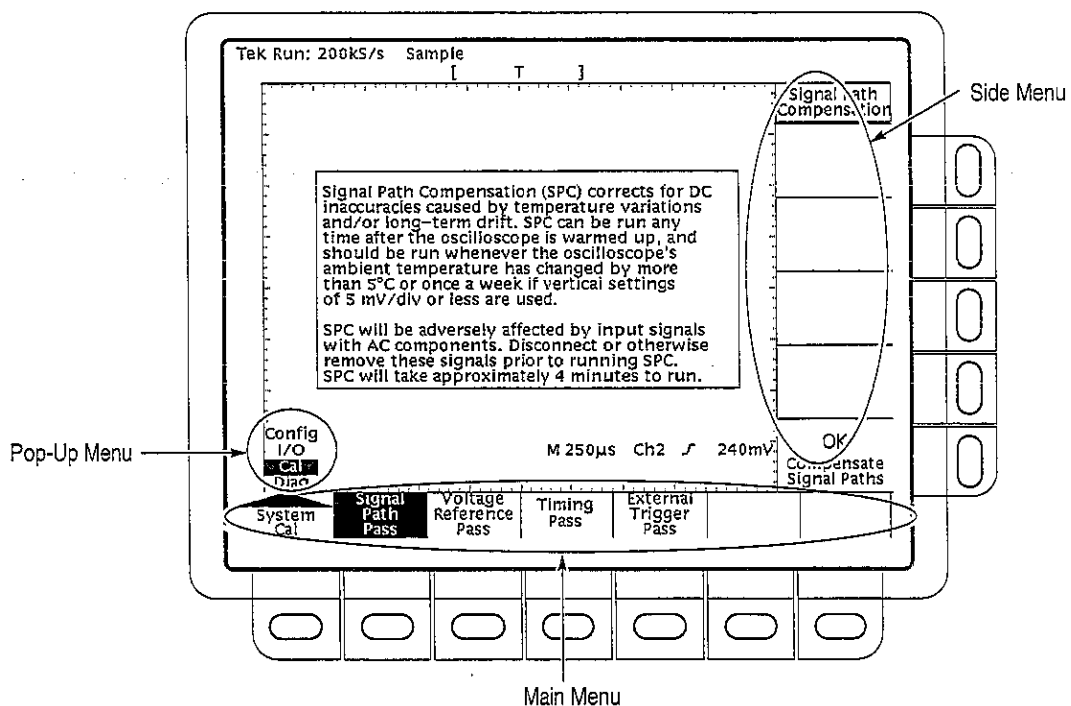

Figure B-1: Menu locations

Test Equipment

These procedures use external, traceable signal sources to directly check instrument performance. If your test equipment does not meet the minimum requirements listed in Table B-1, your test results will be invalid.

Table B-1: Test equipment

Item number and description	Minimum requirements	Example	Purpose
1. Termination 50 Ω (two required)	Impedance 50 Ω ; connectors: female BNC input, male BNC output	Tektronix part number 011-0049-01	Checking delay between channels
2. Cable, Precision Coaxial (two required)	50 Ω , 91 cm (36 in), male to male BNC connectors	Tektronix part number 012-0482-00	Signal interconnection
3. Connector, Dual-Banana	Female-BNC to dual-banana	Tektronix part number 103-0090-00	Several accuracy tests
4. Connector, BNC "T"	Male-BNC to dual-female-BNC	Tektronix part number 103-0030-00	Checking trigger sensitivity
5. Coupler, Dual-Input	Female-BNC to dual-male-BNC	Tektronix part number 067-0525-02	Checking delay between channels
6. Generator, DC Calibration	Variable amplitude to ± 110 V; accuracy to 0.1%	Wavetek 9100 Calibration System with Option 250	Checking DC offset, gain, and measurement accuracy
7. Generator, Leveled Sine Wave, Medium-Frequency	200 kHz to 250 MHz; variable amplitude from 5 mV to 4 V _{p-p} into 50 Ω	Wavetek 9100 Calibration System with Option 250	Checking bandwidth and trigger sensitivity
8. Generator, Leveled Sine Wave, High-Frequency ¹	200 kHz to 400 MHz; variable amplitude from 5 mV to 4 V _{p-p} into 50 Ω	Rohde & Schwarz SMY with URV 35 Power Meter and NRV-Z8 Power Sensor	Checking bandwidth and trigger sensitivity
9. Generator, Time Mark	Variable marker frequency from 10 ms to 10 ns; accuracy within 2 ppm	Wavetek 9100 Calibration System with Option 250	Checking sample rate and delay-time accuracy
10. Probe, 10X, included with this instrument	A P6109B (TDS 340A), P6111B (TDS 360), or P6114B (TDS 380) probe	Tektronix number P6109B (TDS 340A), P6111B (TDS 360), or P6114B (TDS 380)	Signal interconnection

¹ The high frequency leveled sine wave generator is only required to verify the TDS 380, not the TDS 340A or TDS 360. If you use the example equipment, refer to *Sine Wave Generator Leveling Procedure* on page B-14 for information on obtaining a leveled output from an unleveled sine wave generator. If available, you can use a Tektronix SG504 Leveled Sine Wave Generator in place of the example equipment.

Test Record

Photocopy this page and use it to record the performance test results for your instrument.

TDS 340A, TDS 360, and TDS 380 test record

Instrument Serial Number: _____	Certificate Number: _____
Temperature: _____	RH %: _____
Date of Calibration: _____	Technician: _____

Performance test	Minimum	Incoming	Outgoing	Maximum
DC Voltage Measurement Accuracy				
CH1 VOLTS/DIV 1 V	+97.1 V	_____	_____	+98.9 V
200 mV	+8.28 V	_____	_____	+8.52 V
50 mV ¹	-581 mV	_____	_____	-619 mV
50 mV ²	-881 mV	_____	_____	-919 mV
Δ at 50 mV	+286 mV	_____	_____	+314 mV
10 mV	+54.6 mV	_____	_____	+65.4 mV
5 mV	-982 mV	_____	_____	-998 mV
CH2 VOLTS/DIV 1 V	+97.1 V	_____	_____	+98.9 V
200 mV	+8.28 V	_____	_____	+8.52 V
50 mV ¹	-581 mV	_____	_____	-619 mV
50 mV ²	-881 mV	_____	_____	-919 mV
Δ at 50 mV	+286 mV	_____	_____	+314 mV
10 mV	+54.6 mV	_____	_____	+65.4 mV
5 mV	-982 mV	_____	_____	-998 mV
Analog bandwidth				
CH1	42.5 mV	_____	_____	N/A
CH2	42.5 mV	_____	_____	N/A
Long term sample rate and delay time accuracy				
	-2.0 Div	_____	_____	+2.0 Div
Edge trigger sensitivity, DC coupled				
Main Trigger	stable trigger	_____	_____	N/A
Main Trigger – Falling	stable trigger	_____	_____	N/A

¹ Generator set at -0.6 V.
² Generator set at -0.9 V.

Performance Test Overview

The procedures are in three groupings: *Signal Acquisition System Checks*, *Time Base System Checks*, and *Triggering System Checks*. They check all the characteristics that appear in **boldface** type under *Warranted Characteristics* on page A-1.

Prerequisites

The tests in this subsection comprise an extensive, valid confirmation of performance and functionality when the following requirements are met:

- The cabinet must be installed.
- You must have performed and passed the procedures under *Self Tests*, on page 1-5 and those under *Functional Tests*, on page 1-7.
- The digitizing oscilloscope must have been operating for a warm-up period of at least 20 minutes, and must be operating at an ambient temperature between -10°C and $+55^{\circ}\text{C}$.

Signal Acquisition System Checks

These procedures check signal acquisition system characteristics that are listed as checked under *Warranted Characteristics* in the *Specifications* section.

Check DC Voltage Measurement Accuracy



WARNING. Performance of this procedure requires input voltages up to 98 VDC. Contact with live circuits could cause injury or death. Be sure to set the DC calibration generator to 0 volts before connecting, disconnecting, and/or moving the test hookup during the performance of this procedure.

Equipment Required: One dual-banana connector (Item 3), one DC calibration generator (Item 6), and one precision coaxial cable (Item 2).

Time Required: Approximately 35 minutes.

Prerequisites: The oscilloscope must meet the prerequisites listed on page B-5.

Procedure:

1. Set the output of a DC calibration generator to 0 volts.

2. Connect the output of a DC calibration generator through a dual-banana connector followed by a 50 Ω precision coaxial cable to CH 1, as shown in Figure B-2.

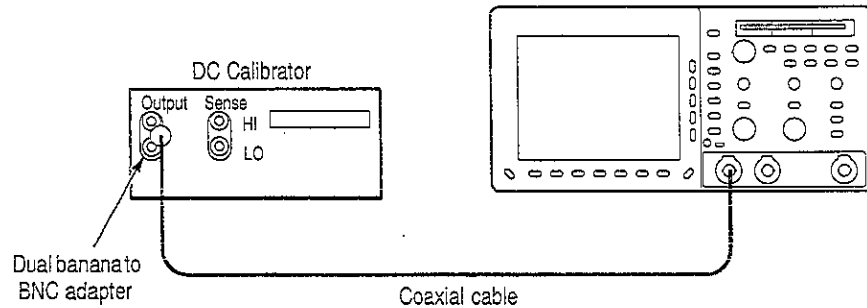

Figure B-2: Hookup for DC voltage measurement accuracy check

3. Press **SAVE/RECALL SETUP** → **Recall Factory Setup** → **OK Confirm Factory Init**.
4. Press **ACQUIRE** → **Mode** → **Average 16**.
5. Press **MEASURE** → **Select Measurement**.
6. Press the side menu button **more** until the menu label **Mean** appears in the side menu. Press the side menu button **Mean**.
7. Set the vertical **SCALE** to one of the settings listed in Table B-2 that you have not yet checked. (Start with the first setting listed.)
8. Press **VERTICAL MENU** → **Position**.
9. Turn the **General Purpose Knob** to set the vertical position to the setting listed in Table B-2. The baseline level moves off screen.
10. Press the main menu button **Offset**.
11. Use the **General Purpose Knob** to set vertical offset to the setting listed in Table B-2 for the present vertical scale setting. The baseline level remains off screen.

Table B-2: DC accuracy

Vertical scale setting	Position setting (divs)	Offset setting	Generator setting	Accuracy limits
1 V	+5	+100 V	+98 V	+97.1 V to +98.9 V
200 mV	+5	+10 V	+8.4 V	+8.28 V to +8.52 V
50 mV	-5	-1 V	-0.6 V	-581 mV to -619 mV
50 mV	-5	-1 V	-0.9 V	-881 mV to -919 mV
Δ at 50 mV				+286 mV to +314 mV
10 mV	-5	0 V	+60 mV	+54.6 mV to +65.4 mV
5 mV	0	-1 V	-990 mV	-982 mV to -998 mV

12. Set the generator to the level and polarity indicated in Table B-2 for the vertical scale, position, and offset settings you have made. The DC test level should appear on screen. (If it does not return, the DC accuracy check has failed for the present vertical scale setting of the current channel.)
13. Check that the readout for the measurement **Mean** readout on screen is within the limits listed for the present vertical scale and position/offset/generator settings.
14. Repeat steps 7 through 13 until you have checked all the vertical scale settings listed in Table B-2. Record the measurements for each of the 50 mV settings.
15. Subtract the second 50 mV measurement from the first and compare the result to the " Δ at 50 mV" limits in Table B-2.
16. Press **WAVEFORM OFF**; then, press **CH 2**.
17. Set the generator output to 0 V.
18. Move the test hookup to the **CH 2** input.
19. Repeat steps 5 through 15 for channel 2.
20. Set the generator output to 0 V.
21. Disconnect the cable at the **CH 2** input connector.

DC Gain Accuracy

DC gain accuracy is verified by successful completion of the self tests and the DC voltage measurement accuracy (in the previous procedure).

Offset Accuracy

Offset accuracy is verified by successful completion of the Self Tests and the DC voltage measurement accuracy (in the previous procedure).

Check Analog Bandwidth

Equipment Required: One leveled sine wave generator (Item 7 or 8), one 50 Ω precision cable (Item 2), and one 50 Ω termination (Item 1).

Time Required: Approximately 20 minutes.

Prerequisites: See page B-5.

Procedure:

1. Connect, through a 50 Ω precision cable and a 50 Ω termination, the sine wave output of a leveled sine wave generator to **CH 1** (see Figure B-3). Set the output of the generator to a reference frequency of 50 kHz.

***NOTE.** If you are verifying a TDS 380, you need a leveled sine wave generator with a 400 MHz output frequency. Refer to Sine Wave Generator Leveling Procedure on page B-14 for information on obtaining a leveled output from an unleveled sine wave generator.*

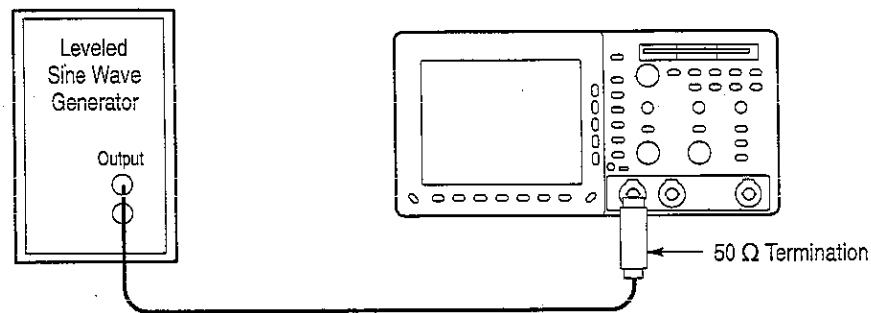

Figure B-3: Hookup for analog bandwidth check

1. Press **SAVE/RECALL SETUP** → **Recall Factory Setup** → **OK Confirm Factory Init.**
2. Set the horizontal **SCALE** to 10 μ s/div.
3. Press **TRIGGER MENU** → **Coupling** → **Noise Rej.**
4. Press **ACQUIRE** → **Mode** → **Average 16.**
5. Press **MEASURE** → **High-Low Setup** → **Min-Max.**
6. Press the main menu button **Select Measurement**. Now press the side menu button **more** until the menu label **Pk-Pk** appears in the side menu. Press the side menu button **Pk-Pk**.
7. Set the vertical **SCALE** to 10 mV/div.

8. Set the generator output so the **CHx Pk-Pk** readout equals 60 mV.
9. Press **SET LEVEL TO 50%** as necessary to trigger the display.
10. Increase the frequency of the generator output to 100 MHz (TDS 340A), 200 MHz (TDS 360), or 400 MHz (TDS 380).
11. Set the horizontal **SCALE** to 5 ns/div (TDS 340A), 2.5 ns/div (TDS 360), or 2.5 ns/div (TDS 380).
12. Press **SET LEVEL TO 50%** as necessary to trigger the display.
13. Check that the **Pk-Pk** readout on screen (as shown in Figure B-4) is ≥ 42.5 mV.

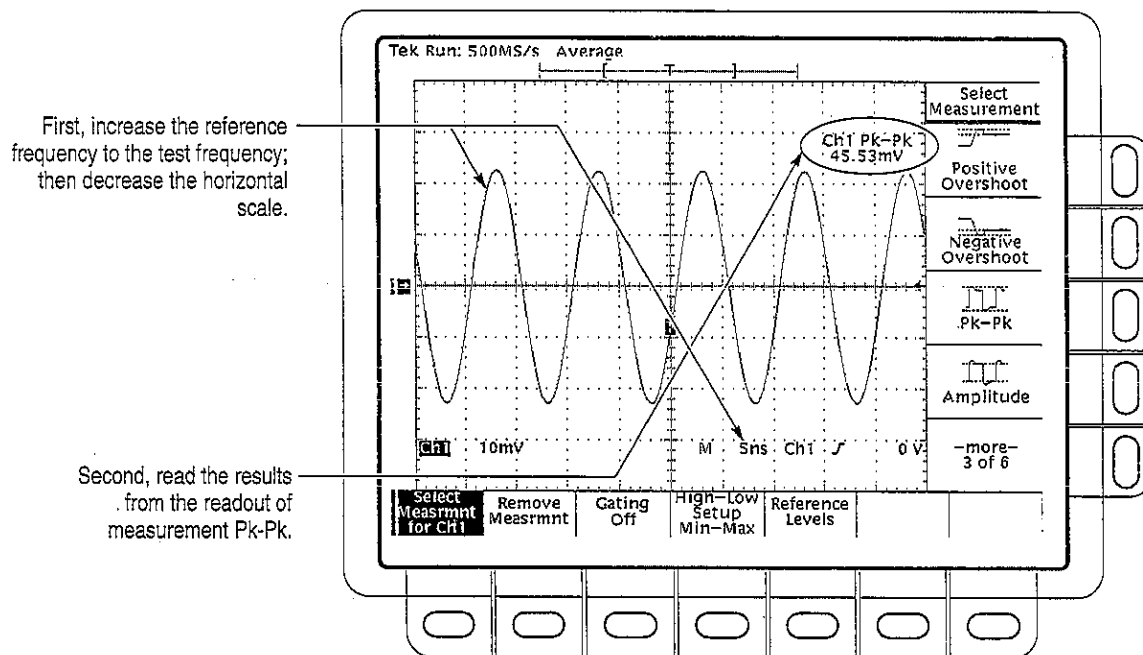

Figure B-4: Measuring analog bandwidth

14. When finished checking, set the horizontal **SCALE** back to the 10 μ s/div setting, and set the generator output frequency back to 50 kHz.
15. Press **WAVEFORM OFF** to remove Channel 1 from the display.
16. Press **CH 2** and move the hookup to the **CH 2** input.
17. Press **TRIGGER MENU** \rightarrow **Source** \rightarrow **CH 2**.
18. Repeat steps 6 through 13 for **CH 2**.

19. Disconnect the test hook up from the CH 2 input connector.

Time Base System Checks

This procedure checks those characteristics that relate to the Main and Delayed time base system and are listed as checked under *Warranted Characteristics* in the *Specifications* section.

Check Long-Term Sample Rate and Delay Time Accuracy

Equipment Required: One time-marker generator (Item 9), one precision coaxial cable, (Item 2) and one 50 Ω termination (Item 1).

Time Required: Approximately 5 minutes.

Prerequisites: See page B-5.

Procedure:

1. Connect, through a 50 Ω precision coaxial cable and a 50 Ω termination, the time-mark output of a time-marker generator to CH 1, as shown in Figure B-5. Set the output of the generator for 10 ms markers.

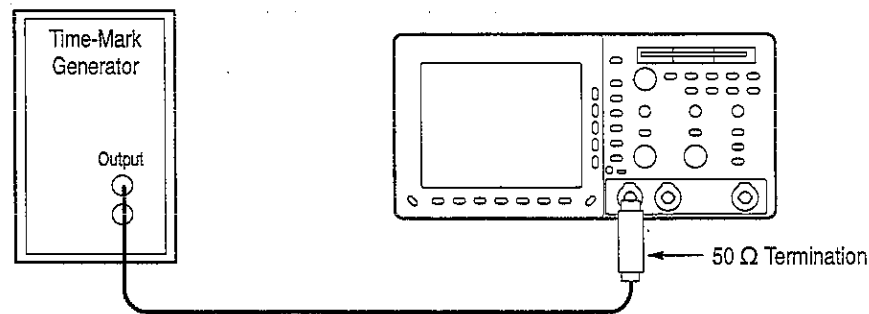

Figure B-5: Hookup for sample rate check

2. Press **SAVE/RECALL SETUP** → **Recall Factory Setup** → **OK Confirm Factory Init**.
3. Set the vertical **SCALE** to 500 mV/div.
4. Press **SET LEVEL TO 50%**; use the vertical **POSITION** knob to center the test signal on screen.
5. Set the horizontal **SCALE** to 1 ms/div.
6. Press **HORIZONTAL MENU** → **Trigger Position** → **Set to 10%**.

7. Adjust the horizontal **POSITION** to move the trigger **T** to the right and on to the screen. Continue to position the trigger **T** to align it to the center vertical graticule line.
8. Press the main menu button **Time Base**; then press the side menu button **Delayed Only**.
9. Set the horizontal **SCALE** of the **D** (delayed) time base to 1 ms/div. Then use the **General Purpose** knob to set delay time to 10 ms.
10. Set the horizontal **SCALE** of the **D** (delayed) time base to 500 ns/div.

***NOTE.** When you change the **SEC/DIV** in step 10, the delay time readout changes to 10.00001 or 9.99999. This is normal and has no effect on the verification*

11. Check that the rising edge of the marker crosses the center horizontal graticule line at a point within ± 2.0 divisions of the graticule center.

***NOTE.** One division of displacement from the center graticule corresponds to a 50 ppm time base error.*

12. Disconnect the test hookup.

Delta Time Measurement Accuracy

Delta time measurement accuracy is verified by successful completion of the previous procedure.

Trigger System Checks

These procedures check those characteristics that relate to the trigger system and are listed as checked under *Warranted Characteristics* in the *Specifications* section.

Check Edge Trigger Sensitivity, DC Coupled

Equipment Required: One leveled sine wave generator (Item 7 or 8), two precision 50 Ω coaxial cables (Item 2), one 50 Ω termination (Item 1), and one BNC T connector (Item 4).

Time Required: Approximately 10 minutes.

Prerequisites: See page B-5.

Procedure:

1. Press **SAVE/RECALL SETUP** → **Recall Factory Setup** → **OK Confirm Factory Init.**
2. Set the vertical **SCALE** to 500 mV/div.
3. Set the horizontal **SCALE** to 10 ns/div.
4. Press **TRIGGER MENU** → **Mode** → **Normal.**
5. Press **ACQUIRE** → **Mode** → **Average 16.**
6. Connect one 50 Ω cable to the output of the sine wave generator. Attach a BNC T connector to the other end of the cable. Connect a second 50 Ω cable to the other side of the BNC T connector.
7. Connect the BNC T connector to **CH 1**; connect the cable to the **EXT TRIG** input through a 50 Ω termination as shown in Figure B-6.

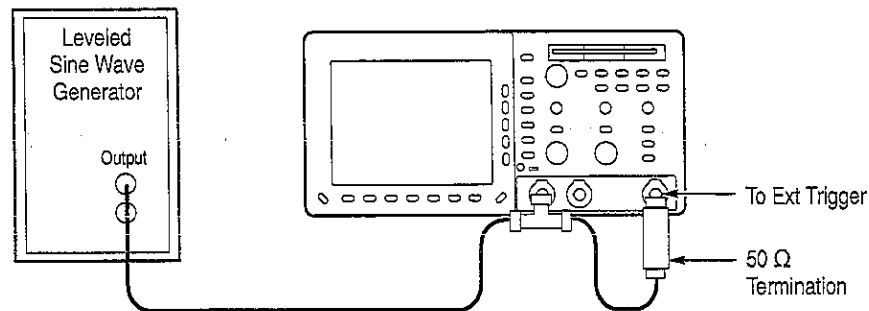

Figure B-6: Hookup for trigger sensitivity check

8. Set the generator frequency to 100 MHz (TDS 340A), 200 MHz (TDS 360), or 400 MHz (TDS 380).
9. Press **MEASURE** → **High-Low Setup** → **Min-Max.**
10. Press the main menu button **Select Measurement.**
11. Press the side menu button **–more–** until **Amplitude** appears in the side menu. Press the side menu button **Amplitude.**
12. Press **SET LEVEL TO 50%.**
13. Set the test signal amplitude for about one division on screen. Fine adjust the generator output until the **CH 1 Amplitude** readout indicates the amplitude is 500 mV. (Readout may fluctuate around 500 mV.)
14. Press **TRIGGER MENU** → **Slope.**

15. Press **SET LEVEL TO 50%**. Check that a stable trigger is obtained for the test waveform on both the positive and negative slopes (see Figure B-7). (Use the side menu to switch between trigger slopes; use the trigger **LEVEL** knob to stabilize the trigger if required.)

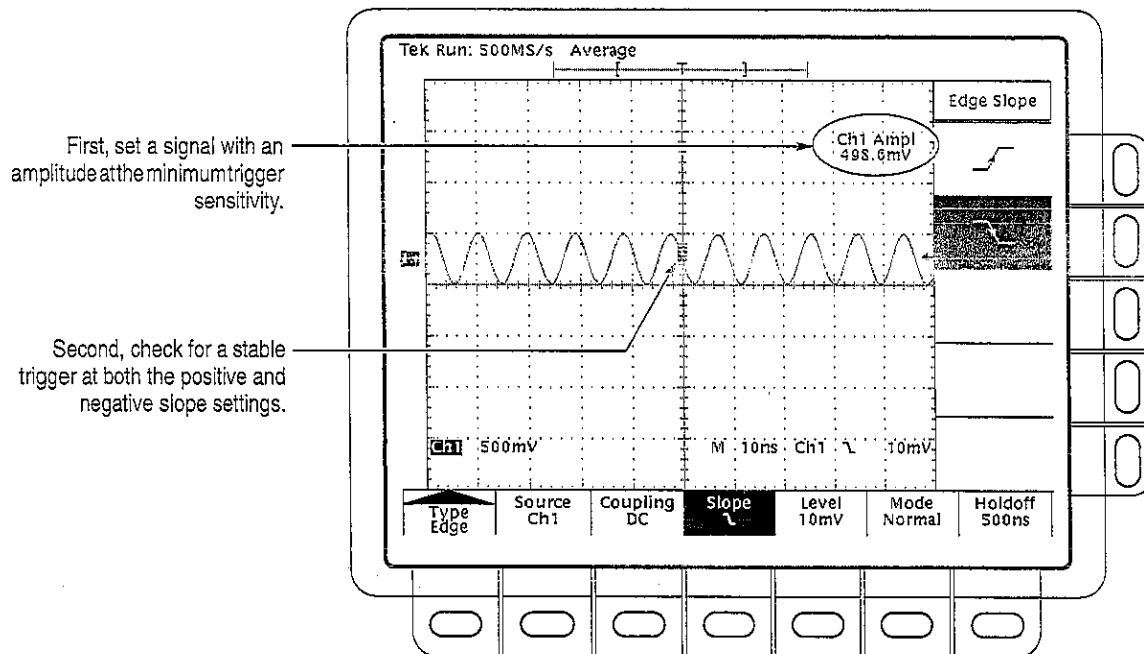

Figure B-7: Measuring trigger sensitivity

16. Press **WAVEFORM OFF**.
17. Press **CH 2**.
18. Press **TRIGGER MENU** → **Source** → **Ch2**.
19. Disconnect the hookup from **CH 1** and connect it to **CH 2**.
20. Set the vertical **SCALE** to 500 mV/div.
21. Repeat steps 14 and 15 for Channel 2.
22. Press **TRIGGER MENU** → **Source** → **EXT/10**.
23. Press **MEASURE** → **Select Measrmtnt** → **Amplitude**.
24. Increase the generator amplitude until the amplitude measurement reads 1.5 V if you are checking a TDS 340A or TDS 360. Increase the generator amplitude until the amplitude measurement reads 4.0 V if you are checking a TDS 380.

25. Repeat steps 14 and 15 for the external trigger.
26. Disconnect the test hookup.

**Trigger Level Accuracy,
DC Coupled**

Trigger level accuracy is verified by the successful completion of the Self Tests and the DC voltage measurement accuracy procedure on page B-5.

This completes the performance verification procedure.

Sine Wave Generator Leveling Procedure

Some procedures in this manual require a sine wave generator to produce the necessary test signals. If you do not have a leveled sine wave generator, use the following procedure to level the output amplitude of your sine wave generator using a power meter.

Equipment Required: Sine wave generator, level meter and power sensor, power splitter, and one precision coaxial cable.

Time Required: About 5 minutes.

Prerequisites: See page B-5.

Procedure:

1. Connect the equipment as shown in Figure B-8.
2. Set the sine wave generator to a reference frequency of 50 kHz.
3. Adjust the sine wave generator amplitude to the required number of divisions as measured by the oscilloscope.
4. Note the reading on the level meter.
5. Change the sine wave generator to the desired new frequency.
6. Input the correction factor for the new frequency into the level meter.
7. Adjust the sine wave generator amplitude until the level meter again reads the value noted in step 4. The signal amplitude is now correctly set for the new frequency.

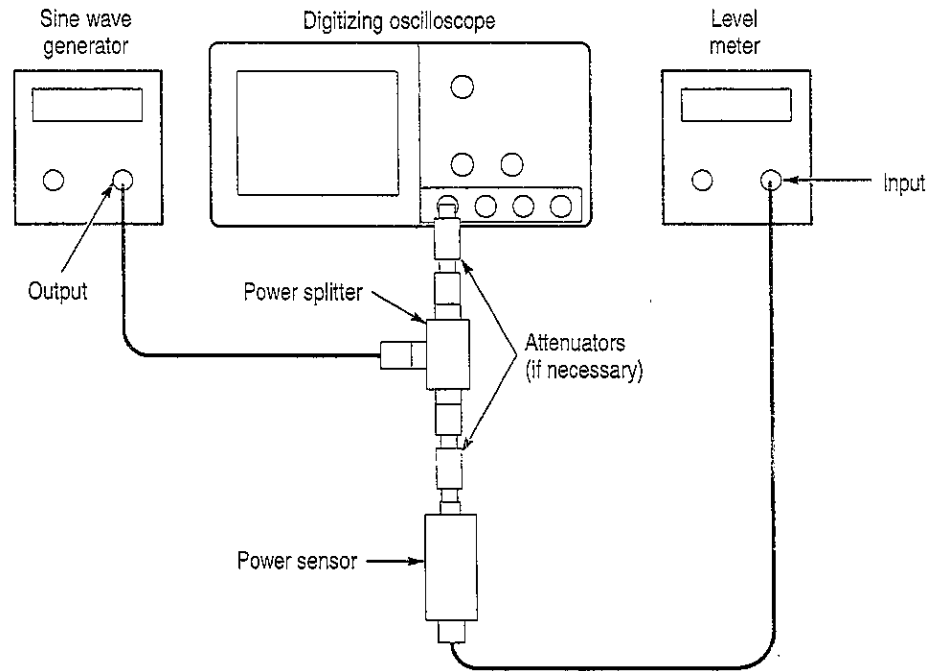

Figure B-8: Hookup for sine wave generator leveling

Appendix C: Options and Accessories

This appendix describes the various options as well as the standard and optional accessories that are available for the TDS 340A, TDS 340A, and TDS 380.

Options

Options include the following.

Option 14: I/O Interfaces

This option includes GPIB, RS-232, and Centronics interfaces, VGA video output, and power for the DPU 411 printer. It also includes the *TDS 340A, TDS 360 & TDS 380 Programmer Manual*.

You can connect a remote display to the VGA 9-pin D connector on the rear panel. Table C-6 on page C-4 gives the part number of a properly shielded cable that is commercially available.

Because display manufacturers use different pin combinations and connectors, you may find the information in Table C-1 helpful.

Table C-1: VGA output connector pins

Pin	Signal
2	Video (monochrome analog)
4	Horizontal sync @ 31.5 kHz (VGA rate)
5	Vertical sync
6, 7, 8	Ground

Options A1-A5: International Power Cords

Besides the standard North American, 110 V, 60 Hz power cord, Tektronix ships any of five alternate power cord configurations with the oscilloscope when ordered by the customer (see Table C-2).

Table C-2: International power cords

Option	Power Cord
A1	Universal European — 220 V, 50 Hz
A2	UK — 240 V, 50 Hz
A3	Australian — 240 V, 50 Hz

Table C-2: International power cords (Cont.)

Option	Power Cord
A4	North American — 240 V, 60 Hz
A5	Switzerland — 220 V, 50 Hz

Language Options

Language options provide user documentation in following local languages (see Table C-3 for options and manual part numbers):

Table C-3: Language options

Language option	Language	User manual	Reference
Std	English	070-9459-XX	070-9434-XX
L1	French	070-9431-XX	
L3	German	070-9432-XX	
L4	Spanish	070-9433-XX	
L5	Japanese	070-9440-XX	070-9441-XX
L7	Simple Chinese	070-9437-XX	
L8	Standard Chinese	070-9438-XX	
L9	Korean	070-9439-XX	

Warranty-Plus Service Options

The following options add to the services available with the standard warranty. (The standard warranty appears immediately following the title page in this manual.)

- Option M2: Tektronix provides three years of warranty plus two years remedial service.
- Option M3: Tektronix provides three years of warranty plus two years remedial service and four oscilloscope calibrations.
- Option M8: Tektronix provides four calibrations and four performance verifications, one of each in the second through the fifth years of service.

Standard Accessories

The standard accessories listed in Table C-4 come with the TDS 340A, TDS 360, and TDS 380. (Refer to Table C-3 for manual part numbers.)

Table C-4: Standard accessories

Accessory
Reference
User Manual
U.S. Power Cord
Probes (quantity two) P6109B 10X Passive (TDS 340A)
Probes (quantity two) P6111B 10X Passive (TDS 360)
Probes (quantity two) P6114B 10X Passive (TDS 380)

Optional Accessories

You can order the optional accessories listed in Table C-5.

Table C-5: Optional accessories

Accessory	Part number
Scope Camera	C-9, Option 4, (includes Adapter Hood 016-1154-01)
Oscilloscope Cart	K212
Rackmount Kit (for field conversion)	016-1166-00
Soft-Sided Carrying Case	016-1158-01
Carrying Case	016-0792-01
Deluxe Transit Case	016-1157-00
Front Cover	200-3232-02
Accessories Pouch	016-1159-00
I/O Interface Field Upgrade Kit	TD3F14A
Docuwave waveform capture utility software for the PC	S60 DWAV
Printer, bubble-jet, 360 dpi, 83 cps, plain paper	HC 220
Printer, portable thermal, 112 mm paper	DPU 411
Paper for DPU 411 printer, package of five rolls	006-7580-00
Programmer Manual	070-9442-XX
Service Manual	070-9435-XX

Accessory Probes

These are other types of probes you can use with the TDS 340A, TDS 360, and TDS 380. You can order the following probes separately:

- P6101B 1X Passive Probe
- P6129B Switchable 1X–10X Passive Probe (not recommended for the TDS 360 or TDS 380)
- P6408 TTL Logic Probe
- P5100 High Voltage Probe
- P5200 High-Voltage Differential Probe
- AM503S DC/AC Current Probe System
- P6561AS SMD Small-Geometry Probe

Accessory Cables

Table C–6 lists cables you can use with the TDS 340A, TDS 360, and TDS 380. You can order them separately.

Table C–6: Accessory cables

Cable type	Part number
GPIB, 1 meter (3.3 feet)	012-0991-01
GPIB, 2 meter (6.6 feet)	012-0991-00
RS-232, 9-pin female to 9-pin female connectors, null modem, 76 inch (for AT style computers)	012-1379-00
RS-232, 9-pin female to 25-pin female connectors, null modem, 76 inch (for PC style computers)	012-1380-00
RS-232, 9-pin female to 25-pin male connectors, null modem, 9 feet (for serial interface printers)	012-1298-00
RS-232, 9-pin female to 25-pin male connectors, 15 feet (for modems)	012-1241-00
Centronics, 25-pin male to 36-pin Centronics, 2.4 meter (8 feet) (for parallel printer interfaces)	012-1214-00
NEC® VGA video cable. (Use an appropriate adapter when other than a 9-pin monitor connection is needed.)	73893029

Appendix D: General Care and Cleaning

General Care

Protect the oscilloscope from adverse weather conditions. The oscilloscope is not waterproof.



CAUTION. To avoid damage to the oscilloscope, do not expose it to sprays, liquids, or solvents.

Cleaning

Inspect the oscilloscope as often as operating conditions require. To clean the oscilloscope exterior, perform the following steps:

1. Remove loose dust on the outside of the oscilloscope with a lint-free cloth. Use care to avoid scratching the clear plastic display filter.
2. Use a soft cloth or paper towel dampened with water to clean the oscilloscope. You can use a 75% isopropyl alcohol solution for more efficient cleaning.



CAUTION. To avoid damage to the surface of the oscilloscope, do not use any abrasive or chemical cleaning agents.

Glossary

AC Coupling

A mode that blocks the DC component of a signal but passes the dynamic (AC) component of the signal. Useful for observing an AC signal that is normally riding on a DC signal.

Acquisition

The process of sampling signals from input channels, digitizing the samples, processing the results into data points and assembling the data points into a waveform record. The waveform record is stored in memory.

Active Cursor

The cursor that moves when you turn the General Purpose Knob. The @ readout on the display shows the position of the active cursor.

Aliasing

A false representation of a signal due to insufficient sampling of high frequencies or fast transitions. A condition that occurs when an oscilloscope digitizes at an effective sampling rate that is too slow to reproduce the input signal. The waveform displayed on the oscilloscope may have a lower frequency than the actual input signal.

Attenuation

The degree the amplitude of a signal is reduced when it passes through an attenuating device such as a probe or attenuator, that is, the ratio of the input measure to the output measure. For example, a 10X probe attenuates, or reduces, the input voltage of a signal by a factor of 10.

Auto Trigger Mode

A trigger mode that causes the oscilloscope to automatically acquire if it does not detect a triggerable event.

Autoset

A function of the oscilloscope that automatically produces a stable waveform of usable size. Autoset sets up front-panel controls based on the characteristics of the active waveform. A successful autoset sets the volts per division, time per division, and trigger level to produce a coherent and stable waveform display.

Average Acquisition Mode

In this mode the oscilloscope acquires and displays a waveform that is the averaged result of several acquisitions. This reduces the apparent noise. The oscilloscope acquires data as in the sample mode and then averages it according to a specified number of averages.

Cursors

Paired markers that you can use to make measurements between two waveform locations. The oscilloscope displays the values (expressed in volts or time) of the position of the active cursor and the distance between the two cursors.

DC Coupling

A mode that passes both AC and DC signal components to the circuit. Available for both the trigger system and the vertical system.

Digital Real-Time Digitizing

A digitizing technique that samples the input signal with a sample frequency of four to five times the oscilloscope bandwidth. Combined with $(\sin x)/x$ interpolation, all frequency components of the input up to the bandwidth are accurately displayed.

Digitizing

The process of converting a continuous analog signal such as a waveform to a set of discrete numbers representing the amplitude of the signal at specific points in time.

Edge Trigger

Triggering occurs when the oscilloscope detects the source passing through a specified voltage level in a specified direction (the trigger slope).

Envelope Acquisition Mode

A mode in which the oscilloscope acquires and displays a waveform that shows the variation extremes of several acquisitions.

Fast Fourier Transform (FFT)

An algorithm used to transform a time-domain waveform into a frequency-domain waveform. The frequency-domain waveform shows the spectral content of the time-domain waveform.

Gated Measurements

A feature that lets you limit automated measurements to a specified portion of the waveform. You define the area of interest using the vertical cursors.

GPIB (General Purpose Interface Bus)

An interconnection bus and protocol that allows you to connect multiple instruments in a network under the control of a controller. Also known as IEEE 488 bus. It transfers data with eight parallel data lines, five control lines, and three handshake lines.

Ground (GND) Coupling

Coupling option that disconnects the input signal from the vertical system.

Hard Copy

An electronic copy of the display in a format useable by a printer or plotter.

Holdoff, Trigger

A specified amount of time after a trigger signal that elapses before the trigger circuit will accept another trigger signal. This helps ensure a stable display.

Horizontal Bar Cursors

The two horizontal bars that you position to measure the voltage parameters of a waveform. The oscilloscope displays the value of the active (moveable) cursor with respect to ground and the voltage value between the bars.

Main Menu

A group of related controls for a major oscilloscope function that the oscilloscope displays across the bottom of the screen.

Main Menu Buttons

Bezel buttons under the main menu display. They allow you to select items in the main menu.

Normal Trigger Mode

A mode on which the oscilloscope does not acquire a waveform record unless a valid trigger event occurs. It waits for a valid trigger event before acquiring waveform data.

Pixel

A visible point on the display. The oscilloscope display is 640 pixels wide by 480 pixels high.

Pop-Up Menu

A submenu of a main menu. Pop-up menus temporarily occupy part of the waveform display area and present additional choices associated with the main menu selection. You can cycle through the options in a pop-up menu by repeatedly pressing the main menu button underneath the pop-up.

Pretrigger

The specified portion of the waveform record that contains data acquired before the trigger event.

Record Length

The specified number of samples in a waveform.

Reference Memory

Memory in an oscilloscope used to store waveforms or settings. You can use that waveform data later for processing. The oscilloscope saves the data even if you turn it off or unplug it.

Roll

An acquisition mode useful at slow horizontal scale settings. Roll mode allows you to view the waveform as it is acquired point-by-point. The waveform appears to roll across the display.

Sample Acquisition Mode

The oscilloscope creates a record point by saving the first sample during each acquisition interval. This is the default mode of the acquisition system.

Sample Interval

The time interval between successive samples in a time base. For real-time digitizers, the sample interval is the reciprocal of the sample rate.

Sampling

The process of capturing an analog input, such as a voltage, at a discrete point in time and holding it constant so that it can be quantized.

Selected Waveform

The waveform on which all measurements are performed and which is affected by vertical position and scale adjustments.

Side Menu

Menu that appears to the right of the display. These selections expand on main menu selections.

Side Menu Buttons

Bezel buttons to the right of the side menu display. They allow you to select items in the side menu.

Signal Path Compensation (SPC)

The ability of the oscilloscope to minimize the electrical offsets in the vertical, horizontal, and trigger amplifiers caused by ambient temperature changes and component aging. You should run SPC at the following times: when the ambient temperature varies more than 5° C from the last SPC, when using settings equal to or less than 5 mV per division, and when performing critical measurements.

Tek Secure

This feature erases all waveform and setup memory locations (setup memories are replaced with the factory setup). Then it checks each location to verify erasure. This feature is useful where the oscilloscope is used to gather security sensitive data.

Time base

The set of parameters that let you define the time and horizontal axis attributes of a waveform record. The time base determines when and how long to acquire record points.

Vertical Bar Cursors

The two vertical bars you position to measure the time parameter of a

waveform record. The oscilloscope displays the value of the active (moveable) cursor with respect to trigger and the time value between the bars.

Video Trigger

Triggering on the sync pulse of a composite video signal.

XY Format

A display format that compares the voltage level of two waveform records point by point. It is useful for studying phase relationships between two waveforms.

YT Format

The conventional oscilloscope display format. It shows the voltage of a waveform record (on the vertical axis) as it varies over time (on the horizontal axis).

Index

A

- Aborting a hard copy, 3-41
- AC input coupling, 3-4
- AC trigger coupling, 3-12
- AC trigger source, 3-12
- Accessories
 - cables, C-4
 - optional, C-3-C-4
 - pouch, C-3
 - probes, C-4
 - standard, C-3-C-4
- ACQUIRE button, 2-5, 3-25
- Acquire menu, 3-25
- Acquisition, 3-25
 - autoset default, 2-15
 - average mode, 3-26
 - defined, Glossary-1
 - envelope mode, 3-26
 - mode, 3-26
 - nominal specifications, A-7
 - peak detect mode, 3-26
 - performance verification, B-5
 - sample mode, 3-26
 - single sequence mode, 3-26
 - typical specifications, A-5
 - warranted specifications, A-1
- Active cursor, Glossary-1
- Air intake space, 1-2
- Aliasing, 3-37, Glossary-1
- Amplitude measurement, 3-20
- Analog bandwidth, 1-1
- Applications, FFT math waveforms, 3-31
- Attenuation, Glossary-1
- Auto trigger mode, 3-13, Glossary-1
- Automated measurements, 1-1, 3-17
 - of FFT math waveforms, 3-35
- Autoset, 1-1, 2-15, Glossary-1
 - defaults, 2-15
- AUTOSET button, 2-5, 2-15
- Average acquisition mode, 3-26, Glossary-2

B

- Bandwidth
 - analog, 1-1
 - autoset default, 2-16
 - selecting, 3-5
- Burst width measurement, 3-19

C

- Cables, C-4
- Cal menu, 3-59
- Calibration test record, B-4
- Camera, C-3
- Carrying case, C-3
 - soft sided, C-3
- Centronics interface, 2-8, 3-42
 - cables, C-4
- CH 1, 2-2
- CH 1 input, 2-7
- CH 2, 2-2
- CH 2 input, 2-7
- Channel ground indicator, 2-6
- CLEAR MENU button, 2-1
- Clipping, FFT math waveforms, 3-37
- Compensating a probe, 2-12
- Compensation, output, 2-2
- Config menu, 3-59
- Connecting a probe, 2-12
- Connector, chassis ground, 2-2
- Contrast, 3-28
- Controls
 - display, 2-1
 - horizontal system, 2-3
 - power, 2-1
 - trigger, 2-4
 - vertical system, 2-2
- Conventions, performance verification, B-1-B-16
- Cooling space, 1-2

Coupling

- AC, 3-4, Glossary-1
- DC, 3-4
- ground, 3-4, Glossary-3
- input, 3-4
- trigger, 3-12
 - AC, 3-12
 - DC, 3-12
 - HF reject, 3-12
 - LF reject, 3-13
 - noise reject, 3-13
- Current probe, C-4
- CURSOR button, 2-5, 3-21
- Cursor menu, 3-34
- Cursor readout
 - H-Bars, 3-34
 - Paired cursors, 3-35
 - V-Bars, 3-34
- Cursors, 1-1, 3-21, Glossary-2
 - menu, 3-22
 - paired, 3-22
 - readouts, 2-6
 - vertical bar indicators, 2-6
 - with FFT waveforms, 3-34
- Cycle mean, measurement, 3-20
- Cycle RMS, measurement, 3-20

D

- Data handling, typical specifications, A-7
- Date/Time stamp
 - displaying, 3-29
 - setting, 3-60
- DC coupling, Glossary-2
 - input, 3-4
 - trigger, 3-12
- DC offset, 3-37
 - for DC correction of FFTs, 3-37
 - with math waveforms, 3-37
- Deluxe transit case, C-3
- Diag menu, 3-59
- Digitizing, Glossary-2
- Dimensional drawing, A-11
- Disk drive, 3-55-3-58
 - See also* File system

Display

- contrast, 3-28
- controls, 2-1, 3-27
- dot accumulate, 3-28
- dots, 3-28
- format, 3-28
 - autoset default, 2-15
- intensity, 3-28
 - autoset default, 2-15
 - text and graticule, 3-28
 - waveform, 3-28
- map, 2-6
- menu, 3-27
- menu locations, B-2
- nominal specifications, A-9
- persistence, 3-28
- style, 3-28
 - autoset default, 2-15
- vector accumulate, 3-28
- vectors, 3-28
- DISPLAY button, 2-5, 3-27
- Dot accumulate, 3-28
- Dot display, 3-28
- Duty cycle, measurement, 3-19

E

- ECL switching threshold, 3-13
- Edge trigger, Glossary-2
- Envelope acquisition mode, 3-26, Glossary-2
- Environmental, safety, and reliability, warranted specifications, A-4
- Equipment list, for performance verification, B-3-B-16
- EXT TRIG input, 2-7, 3-12
- External triggering, 3-12

F

- Factory setup, 3-52
- Fall time measurement, 3-19
- Fast Fourier Transforms (FFTs), applications, 3-31
- FFT, definition, Glossary-2
- FFT frequency domain record, 3-36
- FFT math waveform, 3-31
 - aliasing, 3-37
 - automated measurements of, 3-35
 - DC correction, 3-37
 - derivation of, 3-31
 - frequency range, 3-36
 - frequency resolution, 3-36
 - procedure for displaying, 3-32
 - procedure for measuring, 3-34
 - record length, 3-36
 - undersampling, 3-37
 - window, 3-38
- File system, 3-55-3-58
 - confirm delete, 3-58
 - copying a file, 3-57
 - creating a directory, 3-57
 - deleting a file, 3-56
 - formatting a disk, 3-58
 - override lock, 3-58
 - printing a file, 3-57
 - renaming a file, 3-56
- Fit to screen, 3-7
- FORCE TRIGGER button, 2-4
- Frame graticule, 3-28
- Frequency measurement, 3-19
- Front panel
 - cover, C-3
 - inputs, 2-7
 - setups, saving and recalling, 3-51
- Full graticule, 3-28
- Fuse, 1-2
 - drawer, 2-8
 - removal and replacement, 1-3-1-4
 - specifications, 1-2

G

- Gated measurements, Glossary-2
- Gating, 3-20
- General Purpose Knob, 2-5, 2-11, 3-5, 3-7, 3-13, 3-20, 3-21, 3-23, 3-26, 3-28
 - icon, 2-6
 - readout, 2-6

- GPIB interface, 3-42, Glossary-2
 - cables, C-4
 - port, 2-8
 - talk only, 3-43
- Graphical user interface, 1-1, 2-9
- Graticule, full or frame, 3-28
- Graticule intensity, 3-28
- Ground coupling, 3-4, Glossary-3

H

- H Bars, 3-22
- Hanning window, 3-38
- Hard copy, 3-41, Glossary-3
 - abort, 3-41
 - configuring output, 3-41
 - format, 3-42
 - layout, 3-42
 - output ports, 2-8
 - port, 3-42
 - saving to disk, 3-43
- HARDCOPY button, 2-5, 3-41
- HF reject trigger coupling, 3-12
- High frequency reject, 3-12
- High measurement, 3-19
- High Ref, 3-19, 3-21
- High voltage probe, C-4
- High-low setup, 3-21
- Histogram, 3-21
- Holdoff, Glossary-3
 - adjustment, 3-13
 - autoset default, 2-16
 - range, 3-13
- Horizontal bar cursors, Glossary-3
- HORIZONTAL MENU button, 2-3, 3-6
- Horizontal position lock, reference waveforms, 3-46
- Horizontal system, 3-6
 - controls, 2-3
 - menu, 3-6
 - menu button, 2-3
 - position, autoset default, 2-15
 - POSITION knob, 2-3
 - scale, autoset default, 2-15
 - scale control, 2-3
 - scale readout, 2-6

- I**
- I/O interface field upgrade kit, C-3
 - Input channels, 1-1
 - Input coupling, 3-4
 - Inputs
 - CH 1 and CH 2, 2-7
 - EXT TRIG, 2-7
 - Installation, 1-2
 - Instruction manual, xi
 - Intensity, 3-28
 - autoset default, 2-15
 - text and graticule, 3-28
 - waveform, 3-28
 - Interfaces
 - Centronics, 2-8
 - GPIB, 2-8
 - nominal specifications, A-9
 - RS-232, 2-8
 - user, 2-9
 - Inverting a waveform, 3-4
- L**
- Landscape output, 3-42
 - LEVEL knob, 2-4
 - LF reject trigger coupling, 3-13
 - Line cord removal, 1-3-1-4
 - Logic probe, C-4
 - Low frequency reject, 3-13
 - Low measurement, 3-19
 - Low Ref, 3-19, 3-21
- M**
- Main menu, 2-6, 2-10, Glossary-3
 - buttons, 2-1, 2-11, Glossary-3
 - MATH button, 2-2, 3-8
 - Math waveform, 3-8
 - FFT. *See* FFT math waveform menu, 3-3, 3-9
 - Maximum measurement, 3-19
 - Mean measurement, 3-20
 - MEASURE button, 2-5, 3-17
 - Measure menu, 3-18
 - Measurement definitions, 3-19
 - Measurements, 3-17
 - amplitude, 3-20
 - automated, 1-1, 3-17
 - activating, 3-18
 - burst width, 3-19
 - cycle mean, 3-20
 - cycle RMS, 3-20
 - fall time, 3-19
 - frequency, 3-19
 - gated, Glossary-2
 - high, 3-19
 - low, 3-19
 - maximum, 3-19
 - mean, 3-20
 - minimum, 3-19
 - negative duty cycle, 3-19
 - negative overshoot, 3-19
 - negative width, 3-19
 - peak to peak, 3-19
 - period, 3-19
 - positive duty cycle, 3-19
 - positive overshoot, 3-19
 - positive width, 3-19
 - removing, 3-20
 - rise time, 3-19
 - RMS, 3-20
 - Mechanical characteristics, nominal specifications, A-10
 - Menu locations, B-2
 - Menus
 - acquisition, 3-25
 - cal, 3-59
 - config, 3-59
 - cursor, 3-22
 - diagnostics, 3-59
 - display, 3-27
 - edge trigger, 3-12
 - horizontal system, 2-3, 3-6
 - math, 3-3, 3-9
 - measure, 3-18
 - pop-up, Glossary-3
 - reference waveform, 3-3, 3-46
 - save/recall setup, 3-51
 - system I/O, 3-59
 - trigger, 2-4
 - utility, 3-59
 - vertical system, 3-3, 3-4
 - video trigger, 3-14, 3-15
 - Mid Ref, 3-19, 3-21
 - Min-max, 3-21
 - Minimum measurement, 3-19

N

Negative duty cycle measurement, 3-19
 Negative overshoot measurement, 3-19
 Negative width measurement, 3-19
 Noise reject trigger coupling, 3-13
 Nominal specifications, A-7
 Normal trigger mode, 3-13, Glossary-3
 NTSC standard video signal, 3-14
 Nyquist frequency, 3-37

O

Offset, 3-5
 autoselect default, 2-16
 vertical, 3-37
 ON/STBY button, 1-2, 2-1
 Option 14, 2-8, 3-59, C-1
 Optional accessories, C-3
 Options, C-1
 I/O interfaces, C-1
 power cords, C-1
 warranty-plus service, C-2
 Options and accessories, C-1
 Oscilloscope cart, C-3

P

Paired cursors, 3-22
 PAL standard video signal, 3-14
 Peak Detect mode, 3-26
 Peak to peak measurement, 3-19
 Performance tests, A-1
 Performance verification
 equipment required, B-3
 functional test, 1-7-1-10
 general instructions, B-1-B-16
 of warranted characteristics, B-5-B-16
 partial vs. complete. *See* Performance Verification,
 General Instructions
 prerequisites, B-5-B-16
 purpose and extent of. *See* Performance Verification,
 General Instructions
 self tests, 1-5-1-6
 test record, B-4
 trigger checks, B-11
 Period measurement, 3-19
 Pixel, Glossary-3
 Pop-up menu, 2-11, Glossary-3
 Portrait output, 3-42
 Position, vertical, 3-37

POSITION knob

horizontal, 2-3
 vertical, 2-2

Positive duty cycle measurement, 3-19**Positive overshoot measurement, 3-19****Positive width measurement, 3-19****Power**

connector, 1-2, 2-8
 controls, 2-1
 cord, 1-2
 clamp, 1-2
 option, C-1
 removal, 1-3-1-4
 distribution system, nominal specifications, A-9
 on, 1-2-1-4
 requirements, warranted, A-3

Pretrigger, Glossary-3**PROBE COMP output, 2-12****Probe compensation**

output, 2-2
 typical specifications, A-6
 waveform, 2-13

Probes, 2-12, C-3

accessory, C-4
 compensating, 2-12
 connecting, 2-12
 current, C-4
 high voltage, C-4
 logic, C-4
 specifications, 2-12

Product description, 1-1**Programmer manual, xi, 2-8, 3-59, C-1****Programming**

via GPIB, 2-8
 via RS-232, 2-8

R**Rackmount kit, C-3****Readout, cursor**

H-Bars, 3-34
 Paired cursors, 3-35
 V-Bars, 3-34

Readouts, 1-1

cursor, 2-6
 general purpose knob, 2-6
 horizontal scale, 2-6
 status, 2-6
 trigger, 2-6
 trigger position (horizontal), 2-6
 vertical scale, 2-6

READY indicator, 2-4

Rear panel, 2-8
 label, 1-2
 power connector, 1-2, 2-8

Recalling
 front panel setups, 3-51
 the factory setup, 3-52
 waveforms, 3-47

Record length, 1-1, Glossary-3

REF 1, 2-2
 button, 3-45

REF 2, 2-2
 button, 3-45

Reference, xi
 levels, 3-21
 memory, Glossary-3
 section, 3-1
 waveform menu, 3-3, 3-46
 waveforms, 3-45
 horizontal lock, 3-46
 removing from the display, 3-47

Related manuals, xi

Remote control
 GPIB port, 2-8
 RS-232 port, 2-8

Removing a measurement, 3-20

Resolution, vertical, 1-1

Rise time measurement, 3-19

RMS measurement, 3-20

Roll, acquisition mode, 3-13, Glossary-4

RS-232 port, 2-8

RUN/STOP button, 2-5, 3-26

S

Sample
 acquisition mode, Glossary-4
 interval, Glossary-4
 mode, 3-26
 rate, 1-1

Sampling, Glossary-4

Save format, 3-47

SAVE/RECALL SETUP button, 2-5, 3-51

Save/recall setup menu, 3-51

Saving front panel setups, 3-51

Saving waveforms, 3-45

Scale, vertical, 3-37

SCALE knob
 horizontal, 2-3
 vertical, 2-2

Scope camera, C-3

Seconds per division, fastest setting, 1-1

SELECT button, 2-5, 3-20, 3-23

Selected waveform, Glossary-4

Service options, C-2

SET LEVEL TO 50% button, 2-4, 3-13

Side menu, 2-6, Glossary-4
 buttons, 2-1, Glossary-4

Signal path, compensation, Glossary-4

Single sequence mode, 3-26

SPC, Glossary-4

Specifications, A-1

Standard accessories, C-3

Start up, 1-2

Status readouts, 2-6

System I/O, 3-42

System I/O menu, 3-59

T

Tek Secure, 3-52, 3-59, Glossary-4

TekSecure, 3-45

Test record, B-4

Text intensity, 3-28

Time base, 3-7, Glossary-4
 delayed, 3-7
 delayed runs after main, 3-7
 fastest setting, 1-1
 intensified zone, 3-7
 main, 3-7
 nominal specifications, A-8
 performance verification, B-10
 readout, 2-6
 warranted specifications, A-2

Time base setting, autosest default, 2-15

Time/Date stamp
 displaying, 3-29
 setting, 3-60

Transit case, C-3

TRIG'D indicator, 2-4

- Trigger
 - controls, 2-4
 - coupling
 - AC, 3-12
 - autoset default, 2-15
 - DC, 3-12
 - HF reject, 3-12
 - LF Reject, 3-13
 - noise reject, 3-13
 - edge, 3-11, Glossary-2
 - edge menu, 3-12
 - external, 3-12
 - holdoff
 - adjustment, 3-13
 - autoset default, 2-16
 - range, 3-13
 - horizontal position adjustment, 3-7
 - horizontal position readout, 2-6
 - level
 - adjustment, 3-13
 - autoset default, 2-15
 - indicator, 2-6
 - set to 50%, 3-13
 - LEVEL knob, 3-13
 - mode, 3-13
 - normal, 3-13
 - roll, 3-13
 - nominal specifications, A-8
 - point indicator, 2-6
 - position, autoset default, 2-15
 - readout, 2-6
 - slope, 3-13
 - autoset default, 2-15
 - source, 3-12
 - AC, 3-12
 - autoset default, 2-15
 - T, 3-28
 - type, autoset default, 2-15
 - typical specifications, A-6
 - video, 3-11, 3-14
 - menu, 3-14, 3-15
 - point adjustment, 3-14
 - source, mode, and holdoff, 3-14
 - warranted specifications, A-3
 - TRIGGER MENU button, 2-4, 3-11
 - Triggering, 3-11
 - edge, 3-11
 - external, 3-12
 - on the ECL switching threshold, 3-13
 - on the TTL switching threshold, 3-13
 - video, 3-14
 - TTL switching threshold, 3-13
 - Typical specifications, A-5
- ## U
- User interface, 2-9
 - UTILITY button, 2-5, 3-41
 - Utility menu, 3-59
- ## V
- V Bars, 3-22
 - Vector
 - accumulate, 3-28
 - display, 3-28
 - Vertical bar
 - cursors, Glossary-4
 - indicators, 2-6
 - VERTICAL MENU button, 2-2, 3-3
 - Vertical position, for DC correction of FFTs, 3-37
 - Vertical resolution, 1-1
 - Vertical scale readout, 2-6
 - Vertical system, 3-3
 - controls, 2-2
 - coupling, autoset default, 2-16
 - fine scale adjustments, 3-5
 - menu, 3-4
 - menu button, 2-2
 - offset, autoset default, 2-16
 - offset adjustment, 3-5
 - position adjustments, 3-5
 - POSITION control, 2-2
 - scale, autoset default, 2-16
 - scale control, 2-2
 - VGA display, C-1
 - Video trigger, 3-14
 - source, mode, and holdoff, 3-14
 - trigger point adjustment, 3-14

W

- Warranted specifications, A-1
 - performance conditions for, A-1
- Warranty-plus service options, C-2
- WAVEFORM OFF button, 2-2, 3-18, 3-47
- Waveform Rate, A-8
- Waveform record, FFT, 3-36
- Waveform record icon, 2-6
- Waveforms
 - intensity, 3-28
 - inverting, 3-4
 - math, 3-8
 - recalling from disk, 3-48
 - recalling reference waveforms, 3-47
 - reference, 3-45
 - horizontal lock, 3-46
 - saving to a reference waveform, 3-45
 - saving to disk, 3-48
 - selecting, 2-2

- Width measurement, 3-19
- Window, Hanning, 3-38

X

- XY
 - format, Glossary-5
 - mode, 3-28
- XYZs of Analog and Digital Oscilloscopes, xi

Y

- YT
 - format, Glossary-5
 - mode, 3-28

Free Manuals Download Website

<http://myh66.com>

<http://usermanuals.us>

<http://www.somanuals.com>

<http://www.4manuals.cc>

<http://www.manual-lib.com>

<http://www.404manual.com>

<http://www.luxmanual.com>

<http://aubethermostatmanual.com>

Golf course search by state

<http://golfingnear.com>

Email search by domain

<http://emailbydomain.com>

Auto manuals search

<http://auto.somanuals.com>

TV manuals search

<http://tv.somanuals.com>