

2754/2754P SPECTRUM ANALYZER

Valuetronics International, Inc.
1-800-552-8258
MASTER COPY

Please Check for CHANGE INFORMATION at the Rear of This Manual

First Printing JUN 1985
Revised OCT 1986

Tektronix
COMMITTED TO EXCELLENCE

Copyright © 1986 Tektronix, Inc. All rights reserved.
Contents of this publication may not be reproduced in
any form without the written permission of Tektronix, Inc.

Products of Tektronix, Inc. and its subsidiaries are
covered by U.S. and foreign patents and/or pending
patents.

TEKTRONIX, TEK, SCOPE-MOBILE, and  are
registered trademarks of Tektronix, Inc. TELEQUIP-
MENT is a registered trademark of Tektronix U.K.
Limited.

Printed in U.S.A. Specification and price change
privileges are reserved.

Tektronix, Inc.
P.O. Box 500
Beaverton, Oregon 97077

Serial Number

PREFACE

This manual is one of a set of product manuals for the TEKTRONIX 2754 and programmable 2754P Spectrum Analyzer. The manual describes the instrument installation and operation. These instructions assume a thorough knowledge of frequency domain analysis. The purpose of this manual is to explain the operation of the 2754 so that measurements will be meaningful. The manual organization is shown in the Table of Contents. The manuals that are available now in addition to this Operators Manual are the

- 2754/2754P Service Manuals, Volume 1 and 2 (standard accessories),
- 2754P Programmers Manual (standard accessory for 2754P only),
- 2750P-Series Programmers Reference Guide (optional accessory).

For manual ordering information, contact your local Tektronix Field Office or representative or refer to the Accessories portion of the Replaceable Mechanical Parts list in the Service Manual, Volume 2.

Standards and Conventions Used

Most terminology is consistent with standards adapted by IEEE and IEC. A glossary of terms is provided in Appendix A. Abbreviations in the documentation are consistent with ANSI Y1.1-1972. GPIB functions conform to the IEEE 488-1978 Standard. Copies of ANSI and IEEE standards can be ordered from the Institute of Electrical and Electronic Engineers Inc.

Change/History Information

Any change information that involves manual corrections or additional information is located behind the tabbed Change Information page at the back of this manual.

History information, as well as the updated data, is combined within this manual when the page(s) is revised. A revised page is identified by a revision date located in the lower inside corner of the page.

Unpacking and Initial Inspection

Instructions for unpacking and preparing the instrument for use are described in Section 5.

Storage and Repackaging

Instructions for short- and long-term storage and instrument repackaging for shipment are described in Section 3.

TABLE OF CONTENTS

	Page		Page
PREFACE.....	i	Section 4 (continued)	
TABLE OF CONTENTS.....	ii	Correcting Numerical Entry Errors.....	4-2
LIST OF ILLUSTRATIONS.....	iv	Instrument Power Control and	
LIST OF TABLES.....	v	Frequency.....	4-3
SAFETY SUMMARY.....	vi	Frequency Span and Resolution.....	4-5
Section 1 GENERAL INFORMATION		Marker Functions.....	4-7
Product Overview.....	1-1	Display Parameters.....	4-14
Firmware Version and Error Message		Sweep.....	4-17
Readout.....	1-1	Digital Storage.....	4-19
Accessories.....	1-1	Display and General Purpose.....	4-21
Options.....	1-2	Front-panel Input/Output and	
Section 2 SPECIFICATION		GPIB.....	4-23
Electrical Characteristics.....	2-1	Rear-panel Input/Output and	
Verification of Tolerance Values.....	2-1	GPIB.....	4-25
Frequency Related Characteristics.....	2-1	Section 5 INSTRUMENT CHECK OUT	
Amplitude Related Characteristics.....	2-7	Firmware Version and Error Message	
Input Signal Characteristics.....	2-12	Readout.....	5-1
Output Signal Characteristics.....	2-15	Firmware Version.....	5-1
General Characteristics.....	2-17	Error Message Readout.....	5-1
Power Requirements.....	2-17	Preparation for Use.....	5-1
Environmental Characteristics.....	2-18	1. Initial Turn On.....	5-1
Physical Characteristics.....	2-19	2. Calibrate Position, Center Fre-	
Section 3 PREPARATION FOR USE		quency, Reference Level, and	
Unpacking and Initial		Bandwidth.....	5-2
Inspection.....	3-1	Functional or Operational Check.....	5-3
Installation.....	3-1	Equipment Required.....	5-3
Rackmount Instrument.....	3-1	Preliminary Preparation.....	5-3
Rack Adapter Kit.....	3-1	1. Check Operation of Front-Panel	
Power Source and Power		Pushbuttons and Controls.....	5-3
Requirements.....	3-2	2. Check Gain Variation Between	
Storage and Repackaging.....	3-2	Resolution Bandwidths.....	5-10
Storage.....	3-2	3. Check Span Accuracy and	
Repackaging for Shipment.....	3-2	Linearity.....	5-10
Section 4 CONTROLS, CONNECTORS,		4. Check Resolution Bandwidth and	
AND INDICATORS		Shape Factor.....	5-10
Operating Modes.....	4-1	5. Check Reference Level Gain and	
Initial Entry Functions (Black Labels) ..	4-1	RF Attenuator Steps.....	5-11
Multiple-Pushbutton Sequence		6. Check Sensitivity.....	5-11
Functions (SHIFT Pushbutton).....	4-1	7. Check Residual FM.....	5-12
Terminating Multiple-Pushbutton		8. Check Frequency Drift or	
Sequences.....	4-1	Stability.....	5-12
DATA ENTRY Functions (Orange		9. GPIB Verification Program.....	5-13
Labels).....	4-1	Section 6 OPERATION	
		Instrument Operating Features.....	6-1
		Firmware Version and Error Message	
		Readout.....	6-1
		Crt Light Filters.....	6-1
		Intensity Level and Beam Alignment...	6-1

	Page		Page
Section 6 (continued)		Section 6 (continued)	
Signal Application	6-1	5. Level of Pulsed Signals	6-11
RF INPUT Connector	6-1	6. Level of Continuous Wave Signals	6-12
Resolution Bandwidth, Frequency		7. Excessive Input Signal Level	6-12
Span, and Sweep Time	6-3	8. No Cr ^t Trace	6-12
Using the MANUAL PEAK Control		9. PEAK/AVERAGE	6-12
or Automatic Peaking	6-4	10. Digital Storage Effects on Signal	
Using the Signal Identifier	6-4	Analyses	6-12
Using the Video Filters	6-4	11. Stored Display Averaged in Wide	
Using Time Domain Operation	6-5	Spans	6-12
Triggering the Display	6-5	12. Automatic Calibration of Relative	
Sweeping the Display	6-5	Amplitudes of Resolution Bandwidth	
Manual Scan of the Spectrum	6-5	Filters	6-12
Reference Level, RF Attenuation, and		13. TRIGGERING	6-12
Vertical Display	6-6	Service Information	6-13
Alternate Reference Level Units		Service Manual	6-13
Selection	6-6	Product Service	6-13
Using the Delta A Mode	6-6	Emergency Repair	6-13
Using MIN NOISE or MIN		Maintenance Agreements	6-13
DISTORTION	6-7		
Using Digital Storage	6-7	Section 7 OPTIONS	
Using the Store and Recall Features ..	6-7	Options A1-A5 (Power Cord Options) ..	7-1
Using the Markers Feature	6-8	Options M1-M3 (Extended Service and	
Marker Terms	6-8	Warranty Options)	7-2
Marker Turn On	6-8	Option 01 (Add Preselector)	7-2
Tuning Markers	6-9	Option 07 (Provide 75 Ω Input)	7-3
Error Detection	6-9	Options 30 (Provide Rackmount	7-5
Using the Automatic Performance		Option 52 (Provide North American	
Testing Feature	6-9	220 V)	7-5
Programming Features (2754P GPIB			
Operation)	6-10	Appendix A GLOSSARY	
Setting GPIB Address Switches	6-10	General Terms	A-1
TALK ONLY, LISTEN ONLY		Terms Related to Frequency	A-1
Switches	6-10	Terms Related to Amplitude	A-2
Connecting to a System	6-10	Terms Related to Digital	
Plotting the Display	6-10	Storage	A-3
Operational Considerations/Precautions	6-11	Terms Related to Markers	A-3
1. RF INPUT Power Limit	6-11		
2. Instrument Warm-up After Storage	6-11		
3. Auto Resolution	6-11		
4. Measurements Outside Specified			
Frequency and Tuning Range vs			
Display Span	6-11		

LIST OF ILLUSTRATIONS

Figure Number	Page	Figure Number	Page
TEKTRONIX 2754P Programmable			
	Spectrum Analyzer.....viii		
2-1	Dimensions2-19	6-1	Circuit of a 75-50 Ω matching pad (ac coupled).....6-2
4-1	Instrument Power Control and Frequency4-3	6-2	Graph illustrating the relationship between dBm, dBmV, and dB μ V (matching attenuator included where necessary).....6-2
4-2	Frequency Span and Resolution.....4-5	6-3	Volts-dBm-Watts conversion chart for 50 Ω impedance.....6-3
4-3	Marker Functions.....4-7	6-4	Typical display mixed with the VIDEO FILTER6-5
4-4	Locating the signal peak.....4-8	6-5	Typical display using B-SAVE A to observe the difference between SAVE A and B displays6-8
4-5	Using FIND PEAK MAX4-10		
4-6	Signal finding examples.....4-11	7-1	International power cord options for the spectrum analyzer.....7-1
4-7	Signal finding examples.....4-12		
4-8	Signal finding example.....4-13		
4-9	Display Parameters.....4-14		
4-10	Sweep.....4-17		
4-11	Digital Storage4-19		
4-12	Display and General Purpose4-21		
4-13	Front-Panel Input/Output and GPIB4-23		
4-14	Rear-Panel Input/Output and GPIB.....4-25		
5-1	Crt display and readout at initial turn on.....5-1		
5-2	Typical display of calibration markers in the maximum span position5-2		
5-3	Integrating a display with the VIDEO FILTER5-5		
5-4	Using the IDENT feature to identify a real or true response5-6		
5-5	Displays that illustrate how bandwidth and shape factor are determined5-11		
5-6	Typical display showing how to determine residual FM5-13		

LIST OF TABLES

Table Number	Page	Table Number	Page
2-1	Frequency Related Characteristics.....2-1	6-1	50 Ω System Reference Level Conversion.....6-2
2-2	Amplitude Related Characteristics.....2-7	6-2	Primary Marker Trace Organization.....6-10
2-3	Input Signal Characteristics2-12		
2-4	Output Signal Characteristics2-15	7-1	Power Cord Options7-1
2-5	Power Requirements2-16	7-2	Extended Service and Warranty Options7-2
2-6	General Characteristics2-17	7-3	Option 01 Alternate Specifications.....7-2
2-7	Environmental Characteristics2-18	7-4	Option 07 Alternate Specifications.....7-4
2-8	Physical Characteristics.....2-19		
5-1	Sensitivity5-12		

SAFETY SUMMARY

(Refer all servicing to qualified servicing personnel)

The safety information in this summary is for both operating and servicing personnel. Specific warnings and cautions will be found throughout the manual where they apply, but may not appear in this summary.

CONFORMANCE TO INDUSTRY STANDARDS

The 2754/2754P complies with the following Industry Safety Standards and Regulatory Requirements.

Safety

CSA: Electrical Bulletin

FM: Electrical Utilization Standard Class 3820

ANSI C39.5 — Safety Requirements for Electrical and Electronic Measuring and Controlling Instrumentation.

IEC 348 (2nd edition) — Safety Requirements for Electronic Measuring Apparatus.

Regulatory Requirements

VDE 0871 Class B — Regulations for RFI Suppression of High Frequency Apparatus and Installations.

TERMS

In This Manual

CAUTION statements identify conditions or practices that could result in damage to the equipment or other property.

WARNING statements identify conditions or practices that could result in personal injury or loss of life.

As Marked on Equipment

CAUTION indicates a personal injury hazard not immediately accessible as one reads the marking, or a hazard to property, including the equipment itself.

DANGER indicates a personal injury hazard immediately accessible as one reads the marking.

SYMBOLS

In This Manual



This symbol indicates where applicable cautionary or other information is to be found.

As Marked on Equipment



DANGER — High voltage.



Protective ground (earth) terminal.



ATTENTION — refer to manual.



Refer to manual

POWER

Power Source

This product is intended to operate from a power source that will not apply more than 250 V rms between the supply conductors or between either supply conductor and ground. A protective ground connection by way of the grounding conductor in the power cord is essential for safe operation.

Grounding the Product

This product is grounded through the grounding conductor of the power cord. To avoid electrical shock, plug the power cord into a properly wired receptacle before connecting it to the product input or output terminals. A protective ground connection by way of the grounding conductor in the power cord is essential for safe operation.

Danger From Loss of Ground

Upon loss of the protective-ground connection, all accessible conductive parts (including knobs and controls that may appear to be insulating) can render an electric shock.

Use the Proper Power Cord

Use only the power cord and connector specified for your product.

Use only a power cord that is in good condition.

Refer cord and connector changes to qualified service personnel.

For detailed information on power cords and connectors, see the Maintenance section in the Service Manual, Volume 1.

Use the Proper Fuse

To avoid fire hazard or equipment damage, use only the fuse of correct type, voltage rating, and current rating for your product (as specified in the Replaceable Electrical Parts list in Volume 2 of the Service Manual). Refer fuse replacement to qualified service personnel.

OPERATIONAL PRECAUTIONS

Do Not Operate in Explosive Atmospheres

To avoid explosion, do not operate this product in an explosive atmosphere unless it has been specifically certified for such operation.

Do Not Remove Covers or Panels

To avoid personal injury, do not remove the product covers or panels unless you are qualified to do so. Do not operate the product without the covers and panels properly installed.

Dangerous voltages exist at several points in this product. To avoid personal injury, do not touch exposed connections and components while power is on. REFER ALL SERVICING TO QUALIFIED SERVICE PERSONNEL.

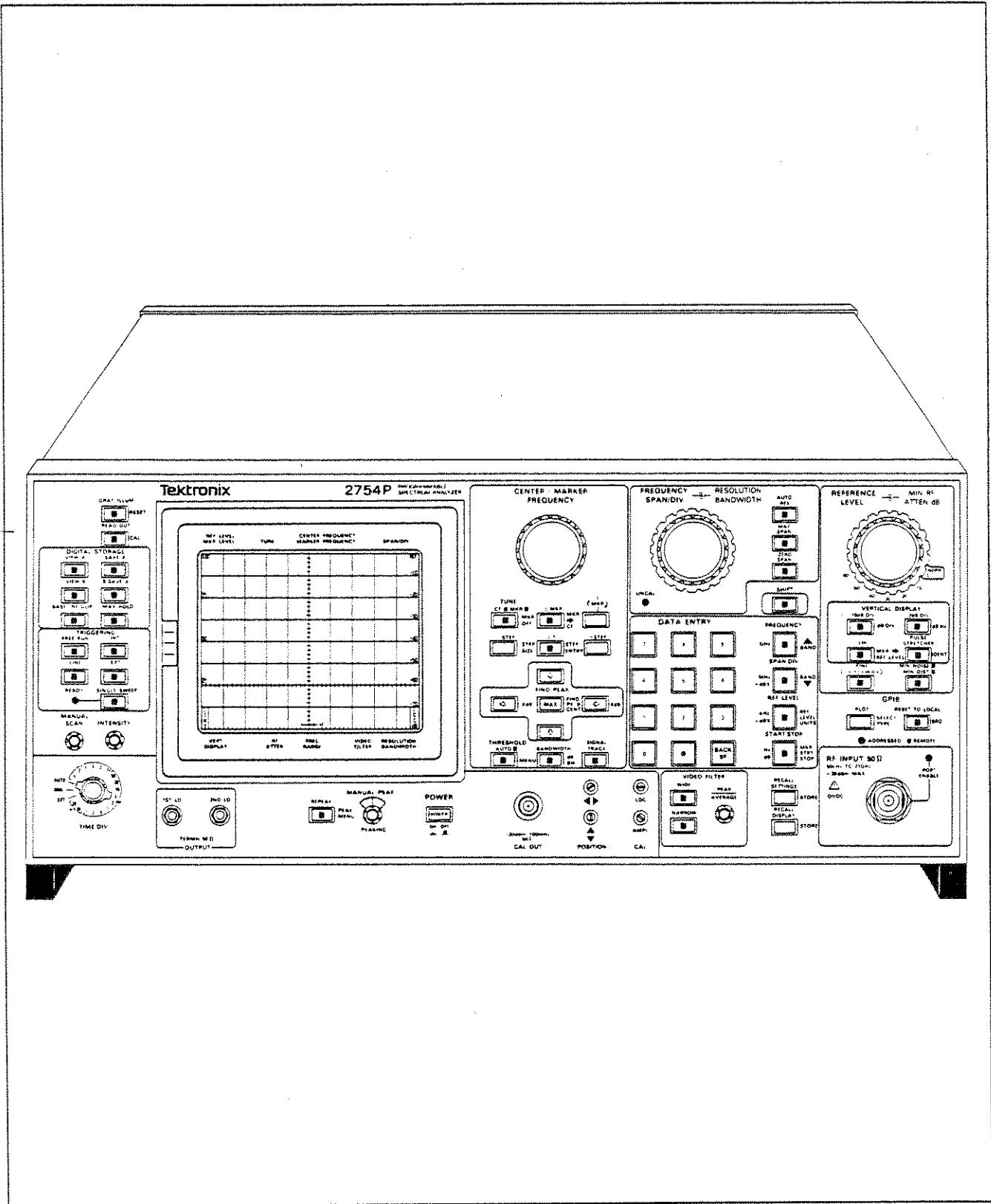

TEKTRONIX 2754P Programmable Spectrum Analyzer

GENERAL INFORMATION

PRODUCT OVERVIEW

The TEKTRONX 2754 and programmable 2754P Spectrum Analyzer are high performance, benchtop instruments. Microcomputer control of most functions simplifies and enhances operation.

The following is a list of the main instrument features.

- single and delta marker modes
- synthesizer frequency accuracy
- precise amplitude measurement capability
- digital storage display
- internal memory to retain front-panel settings and displays
- diagnostic crt messages
- front-panel Data Entry pushbuttons

The frequency range is 50 kHz to 21 GHz. A minimum resolution bandwidth of 1 kHz, with a minimum span of 200 Hz/div, provides measurement resolution that is proportional to the frequency accuracy. Digital storage provides flicker-free displays plus SAVE A, B—SAVE A, and MAX HOLD to compare and subtract displays and save maximum values. In addition to conventional digital storage features, internal memory stores up to nine separate displays with their readouts and dot markers, which can be recalled later for additional analysis and comparison. It is also possible to store up to ten different front-panel control setups for future recall.

Select center frequency either by the front-panel CENTER/MARKER FREQUENCY knob or by the Data Entry pushbuttons. When using the Data Entry pushbuttons, it is not necessary to alter the Span/Div setting regardless of the frequency selected. Other parameters, such as vertical display and reference level, are pushbutton selectable with the flexibility previously available only under program control of the general purpose interface bus (GPIB).

The single and delta markers provide direct readout of frequency and amplitude information of any point along any displayed trace. Relative (delta) frequency and amplitude information between any two points along any displayed trace or between traces is also available. The CENTER/MARKER FREQUENCY control can move the markers, or it can move the display with a stationary frequency marker. For additional marker information refer to Using the Markers Feature in Section 6 of this Manual.

The programmable version of the instrument adds remote control capabilities to the manual instrument features.

The front-panel controls (except those intended exclusively for local use, such as INTENSITY) can be remotely operated through the GPIB port, which allows the spectrum analyzer to be used with a variety of systems and controllers. Refer to the Programmers Manual for additional information.

Firmware Version and Error Message Readout

This feature of the spectrum analyzer provides readout that identifies the version of firmware installed. The readout is momentarily displayed when the power is turned on or when either the RESET TO LOCAL or <SHIFT> RESET pushbuttons are pressed. All front-panel lights will temporarily flash on when the power is first turned on.

If the spectrum analyzer fails to complete any routine or function, an error message will flash on the screen explaining the failure.

Accessories

The Replaceable Mechanical Parts list in the Service Manual, Volume 2, contains the part numbers, descriptions, and ordering information for all standard and optional accessories offered for the spectrum analyzer at this time.

The following list includes all standard accessories currently shipped with each instrument. Refer to Option 30 in the Options section of this manual for alternate information.

- 50 ohm coaxial cable; N to N connector, 72 inch
- 50 ohm coaxial cable; bnc to bnc connector, 18 inch
- Adapter; N male to bnc female
- 4A fast-blow fuses¹; 2 each

¹ If the instrument is wired for 220-240 V operation (Options A1, A2, A3, A4, A5) or if Option 52 is installed (North American configuration for 220 V with standard power cord), 2A medium-blow fuses are used.

General Information — 2754/2754P Operators

- Power cord
- Cord clamp
- Crt light filters; 2 – one each amber and grey
- Crt mesh filter
- Operators Manual
- Service Manual, Volume 1
- Service Manual, Volume 2
- Programmers Manual; 2754P Only

Options

The Options section of this Manual contains detailed information on all of the options currently available for the spectrum analyzer.

SPECIFICATION

This section includes the electrical, physical, and environmental characteristics of this instrument. Any instrument specification changes due to options are listed in the Options section of this manual.

ELECTRICAL CHARACTERISTICS

The following tables of electrical characteristics and features apply to the spectrum analyzer after a 30-minute warm up and after doing the front-panel CAL adjustments, except as noted. The Performance Requirement column defines some characteristics in quantitative terms and in limit form. The Supplemental Information column explains performance requirements or provides performance information. Statements in this column are not considered to be guaranteed performance and are not ordinarily supported by a performance check procedure. Procedures to verify performance requirements are provided in the Performance Check portion of his manual.

The instrument performs an internal calibration check each time power is turned on. This check verifies that the instrument frequency and amplitude performance is as specified. An Instrument Check Out procedure, which does not require external test equipment or technical expertise, is provided in Section 4. This procedure will satisfy most incoming inspections and will help familiarize you with the instrument capabilities.

Verification of Tolerance Values

Perform compliance tests of specified limits, listed in the Performance Requirement column, only after a 30-minute warm-up time (except as noted) and after a doing the front-panel CAL procedure. Use measurement instruments that do not affect the values measured. Measurement tolerance of test equipment should be negligible when compared to the specified tolerance. If the tolerance is not negligible, add the error of the measuring device to the specified tolerance.

Table 2-1
FREQUENCY RELATED CHARACTERISTICS

Characteristic	Performance Requirement	Supplemental Information
Center Frequency Range		50 kHz-21 GHz Tuned by the CENTER/MARKER FREQUENCY control or the DATA ENTRY pushbuttons
Accuracy (after front-panel CAL has been performed)		Center Frequency Accuracy is specified by two characteristics: <ul style="list-style-type: none"> ● initial accuracy ● center frequency drift during the sweep
Initial (start of sweep) Bands 1 & 5 with SPAN/DIV > 200 kHz, and Bands 2-4 with SPAN/DIV > 100 kHz (1st LO unlocked)	$\pm (20\%D + (CF \times 10^{-5}))^a + 15N \text{ kHz}$ Where: D = SPAN/DIV or RESOLUTION BANDWIDTH, whichever is greater CF = Center Frequency N = Harmonic Number	Refer to IF, LO Range, and Harmonic Number specification later in this table for the N value Allow a settling time of one second for each GHz change in CF within a band. In band 4, divide the CF change by N.

^aOver the operating temperature range this term is $(CF \times 1.5 \times 10^{-5})$

Table 2-1 (Continued)
FREQUENCY RELATED CHARACTERISTICS

Characteristic	Performance Requirement	Supplemental Information
Initial Accuracy (Continued) Bands 1 & 5 with SPAN/DIV \leq 200 kHz, and Bands 2-4 with SPAN/DIV \leq 100 kHz (1st LO locked)	$\pm ((20\%D) + CF \times 10^{-5})^a$ Hz Where: D = SPAN/DIV or RESOLUTION BANDWIDTH, whichever is greater CF = Center Frequency	
Drift After 30 minute warm up Bands 1 & 5 with SPAN/DIV > 200 kHz, and Bands 2-4 with SPAN/DIV > 100 kHz (1st LO unlocked)		With constant ambient temperature and fixed center frequency (any error is observed during sweep time) $\leq (25 \text{ kHz})N$ per minute of sweep time
— Bands 1 & 5 with SPAN/DIV \leq 200 kHz, and Bands 2-4 with SPAN/DIV \leq 100 kHz (1st LO locked)		≤ 150 Hz per minute of sweep time
After 1 hour warm up Band 1 & 5 with SPAN/DIV > 200 kHz, and Bands 2-4 with SPAN/DIV > 100 kHz (1st LO unlocked)		$\leq (5 \text{ kHz})N$ per minute of sweep time
Bands 1 & 5 with SPAN/DIV \leq 200 kHz, and Bands 2-4 with SPAN/DIV \leq 100 kHz (1st LO locked)		≤ 50 Hz per minute of sweep time

^aOver the operating temperature range this term is $(CF \times 1.5 \times 10^{-5})$.

Table 2-1 (Continued)
FREQUENCY RELATED CHARACTERISTICS

Characteristic	Performance Requirement	Supplemental Information
Readout Resolution		≤ 10% of SPAN/DIV to minimum of 1 kHz. 100 Hz in delta mode.
Residual FM		Short term, after 1 hour warm up
Bands 1 & 5 with SPAN/DIV > 200 kHz, and Bands 2-4 with SPAN/DIV > 100 kHz (1st LO unlocked)	≤ (7 kHz)N total excursion in 20 ms	
Bands 1 & 5 with SPAN/DIV ≤ 200 kHz, and bands 2-4 with SPAN/DIV ≤ 100 kHz (1st LO locked)	≤ (10+2N)Hz total excursion in 20 ms	
Resolution Bandwidth (6 dB down)	Within 20% of selected bandwidth	1 kHz-1 MHz in decade steps
Shape Factor (60 dB/6 dB)	7.5:1 or less	
Noise Sidebands	At least -75 dBc at an offset of 30× resolution bandwidth	
Video Filter Narrow		Reduces video bandwidth to approximately 1/300th of the selected resolution bandwidth.
Wide		Reduces video bandwidth to approximately 1/30th of the selected resolution bandwidth.
Pulse Stretcher Fall Time		30 μs per vertical division (± 50%).

Table 2-1 (Continued)
FREQUENCY RELATED CHARACTERISTICS

Characteristic	Performance Requirement	Supplemental Information	
Frequency Span/Div			
Overall Range			
With SPAN/DIV control		200 Hz–1 GHz (in a 1-2-5 sequence)	
With the DATA ENTRY push-buttons		200 Hz–1.2 GHz (to two significant digits)	
Minimum Span/Div		200 Hz in all bands	
Maximum Span/Div		With SPAN/DIV Control	With DATA ENTRY Pushbuttons
Band 1 (50 kHz–4.2 GHz) ^a		200 MHz	410 MHz ^a
Band 2 (1.7–5.5 GHz)		200 MHz	370 MHz
Band 3 (3–7.1 GHz)		200 MHz	400 MHz
Band 4 (5.4–18 GHz)		1 GHz	1.2 GHz
Band 5 (15–21 GHz)		500 MHz	590 MHz
		In addition, MAX SPAN sweeps across an entire band and ZERO SPAN provides a 0 Hz display.	
Accuracy/Linearity	Within 5% of the selected span/div	Measured over the center 8 divisions	

^aFor Option 01 instruments, band 1 is 50 kHz–1.8 GHz, and the Span/Div range with the SPAN/DIV control is 100 MHz and with the DATA ENTRY pushbuttons is 170 MHz.

Table 2-1 (Continued)
FREQUENCY RELATED CHARACTERISTICS

Characteristic	Performance Requirement		Supplemental Information
Frequency Response			Measured with 10 dB RF attenuation and peaking optimized for each center frequency setting (when applicable) Response is affected by: <ul style="list-style-type: none"> ● input VSWR ● harmonic number (N) ● gain variation ● mixer ● preselector (Opt 01) Digital storage typically increases errors by $\pm 0.5\%$. Display flatness is typically 1 db greater than frequency response.
Coaxial (direct) Input	About the mid-point between two extremes	Referenced to 100 MHz	Refer to the Options section of this manual for variations in this specification.
Band and Freq Range			
1 (50 kHz–4.2 GHz) ^a	± 1.5 dB	± 2.5 dB	
2 (1.7–5.5 GHz)	± 1.5 dB	± 2.5 dB	
3 (3.0–7.1 GHz)	± 1.5 dB	± 2.5 dB	
4 (5.4–18.0 GHz)	± 2.5 dB	± 3.5 dB	
5 (15.0–21.0 GHz)	± 3.5 dB	± 5.0 dB	

^aFor Option 01 Instruments, band 1 is 50 kHz–1.8 GHz.

Table 2-1 (Continued)
FREQUENCY RELATED CHARACTERISTICS

Characteristic	Performance Requirement	Supplemental Information		
IF Frequency, LO Range, and Harmonic Number (N) Band and Freq Range 1 (50 kHz–4.2 GHz) ^a 2 (1.7–5.5 GHz) 3 (3.0–7.1 GHz) 4 (5.4–18 GHz) 5 (15–21 GHz)				
		1st IF (MHz)	(N)	LO Range (MHz)
		2072	1 –	2072–6272
		829	1 –	2529–6329
		829	1 +	2171–6271
829	3 –	2072–6276		
2072	3 +	4309–6309		
Marker(s)		When activated, the marker is a bright dot positioned by the CENTER/MARKER FREQUENCY control or the DATA ENTRY pushbuttons.		
Normal Accuracy	Identical to center frequency accuracy	For the live trace		
Δ MKR Accuracy	1% of total span	For the live trace. ΔMKR activates a second marker at the position of the single marker on the trace. Parenthesis appear on the marker display line indicating that the delta mode is active. The display shows the difference in frequency and amplitude. 1—MKR—2 selects which marker is tuned.		

^aFor Option 01 instruments, band 1 is 50 kHz–1.8 GHz, and the LO Range is 2072–3872.

Table 2-2
AMPLITUDE RELATED CHARACTERISTICS

Characteristic	Performance Requirement	Supplemental Information
Vertical Display Modes		10 dB/Div, 2 dB/Div, and Linear — any integer between 1-15 dB/Div can also be selected with the DATA ENTRY pushbuttons.
Display Dynamic Range		80 dB maximum (Log Mode) 8 divisions (Linear Mode)
Display Dynamic Accuracy 10 dB/div Log Mode	± 1.0 dB/10 dB to a maximum cumulative error of ± 2.0 dB over 80 dB range	
2 dB/div Log Mode	± 0.4 dB/2.0 dB to a maximum cumulative error of ± 1.0 dB over 16 dB range	
Linear Mode	$\pm 5\%$ of full scale	
Reference Level Range Log Mode		Top of the graticule. From -117 dBm to $+40$ dBm; $+40$ dBm includes 10 dB of IF gain reduction ($+30$ dBm is the maximum safe input). Alternate reference levels are: <ul style="list-style-type: none"> ● dBV (-130 dBV to $+27$ dBV) ● dBmV (-70 dBmV to $+87$ dBmV) ● dBμV (-10 dBμV to $+147$ dBμV)
Linear Mode		39.6 nV/Div-2.8 V/Div (1W maximum safe input)
Steps 10 dB/div Log Mode		10 dB for the Coarse Mode 1 dB for the Fine Mode
2 dB/div Log Mode		1 dB for the Coarse Mode 0.25 dB for the Fine Mode
Linear Mode		1-2-5 sequence for Coarse Mode 1 dB equivalent steps for Fine Mode
Set with DATA ENTRY push-buttons		Steps correspond to the display mode in coarse; except, for 2 dB when the steps are 1 dB. In Fine Mode: 1 dB when the mode is 5 dB/div or more 0.25 dB for display modes of 4 dB/div or less (referred to as Delta A Mode)

Table 2-2 (Continued)
AMPLITUDE RELATED CHARACTERISTICS

Characteristic	Performance Requirement	Supplemental Information
Reference Level (Continued) Accuracy		Dependent on the following characteristics: <ul style="list-style-type: none"> ●RF Attenuation Accuracy ●IF Gain Accuracy ●Resolution Bandwidth ●Display Mode ●Calibrator Accuracy ●Frequency Band ●Frequency Response ●<SHIFT> CAL routine reduces error between resolution bandwidths at -20 dBm REF LEVEL. Other reference levels may have larger errors. ●Ambient Temperature Change (± 0.15 dB/°C maximum)
RF Attenuator Range		0-60 dB in 10 dB steps
Accuracy Dc-1.8 GHz	Within 0.5 dB/10 dB to a maximum of 1 dB over the 60 dB range	
1.8 GHz-18 GHz	Within 1.5 dB/10 dB to a maximum of 3 dB over the 60 dB range	
18 GHz-21 GHz	Within 3.0 dB/10 dB to a maximum of 6 dB over the 60 dB range	
Marker(s)		When activated, the marker is a bright dot positioned by the CENTER/MARKER FREQUENCY control.
Accuracy (Normal or Delta Mode)		Identical to REF LEVEL accuracy plus cumulative error of display scale (dependent on vertical position) ΔMKR activates a second marker at the position of the single marker on the trace. Parenthesis appear on the marker display line indicating that the delta mode is active. The display shows the difference in frequency and amplitude. 1—MKR—2 selects which marker is tuned.

Table 2-2 (Continued)
AMPLITUDE RELATED CHARACTERISTICS

Characteristic	Performance Requirement	Supplemental Information
Gain Variation Between Resolution Bandwidths		Measurement conditions: <ul style="list-style-type: none"> ● measured at -20 dBm ● Minimum Distortion Mode ● at 25°C ambient temperature ● after front-panel CAL adjustments
With respect to 1 MHz Filter	±0.4 dB	
Between Any Two Filters	0.8 dB	
IF Gain Range		87 dB of gain increase, 10 dB of gain decrease (MIN NOISE activated), in 10 dB and 1 dB steps
Accuracy 1 dB Step	At least 0.2 dB/dB step to 0.5 dB/9 dB steps except at the decade transitions	
Decade Transitions -29 to -30 dBm -39 to -40 dBm -49 to -50 dBm -59 to -60 dBm	0.5 dB or less	Maximum 1 dB cumulative error over 10 dB. Measured in Min Noise mode.
Maximum Deviation over the 97 dB Range	±2 dB	

Table 2-2 (Continued)
 AMPLITUDE RELATED CHARACTERISTICS

Characteristic	Performance Requirement	Supplemental Information		
Differential Amplitude Measurement		Delta A Mode provides differential measurements in 0.25 dB increments. (This is not related to the Delta Marker Mode.)		
Range		0 dB above to 48 dB below the reference level established when the Delta A Mode was activated. DO NOT USE Delta A Mode outside the -117 dBm to +30 dBm reference level range.		
Accuracy		Difference	Steps	Error
		0.25 dB	1	0.15 dB
		2 dB	8	0.4 dB
		10 dB	40	1.0 dB
		48 dB	192	2.0 dB
Spurious Responses				
Residual	-100 dBm or less	No input signal, referenced to the internal mixer input, and fundamental mixing for Bands 1-3.		
3rd Order Intermodulation Products 50 kHz-21 GHz (Bands 1-5)	-70 dBc or less from any two on-screen signals within any frequency span.	Refer to Option 01 in the Options section for alternate specification. In Minimum Distortion Mode		
Harmonic Distortion 50 kHz-21 GHz (Bands 1-5)	-60 dBc or less	Measured at -40 dBm input level in Minimum Distortion Mode.		
LO Emission	Less than -10 dBm to 21 GHz	With 0 dB RF Attenuation		

Table 2-2 (Continued)
AMPLITUDE RELATED CHARACTERISTICS

Characteristic	Performance Requirement					Supplemental Information
Sensitivity	Equivalent Input Noise in dBm versus Resolution Bandwidth					Equivalent maximum input noise without internal preselection for each resolution bandwidth for frequency bands 1-5 (50 kHz-21 GHz). The NARROW Video Filter is activated for resolution bandwidths of 1 kHz or less and the WIDE Video Filter for resolution bandwidths above 1 kHz. (See Options 01 and 07 in the Options section for alternate specifications.)
	Band and Frequency Range	1 kHz	10 kHz	100 kHz ^a	300 kHz ^b	
1 ^b (50 kHz-4.2 GHz)	-115	-105	-95	-90	-85	
2 & 3 (1.7-7.1 GHz)	-115	-105	-95	-90	-85	
4 (lower part) (5.4-12.0 GHz)	-100	-90	-80	-75	-70	
4 (upper part) (12.0-18.0 GHz)	-95	-85	-75	-70	-65	
5 (15.0-21.0 GHz)	-95	-85	-75	-70	-65	

^a Option 07 replaces the 100 kHz filter with a 300 kHz filter.

^b For Option 01 instruments, band 1 is 50 kHz-1.8 GHz.

Table 2-3
INPUT SIGNAL CHARACTERISTICS

Characteristic	Performance Requirement	Supplemental Information
RF INPUT		Type N female connector, specified to 21 GHz. (See Option 07 in the Options section for supplemental specifications concerning an additional 75 Ω input.)
Impedance		50 Ω
VSWR with 10 dB or more RF Attenuation 50 kHz–2.5 GHz		1.3:1 (typically 1.2:1)
2.5–6.0 GHz		1.7:1 (typically 1.5:1)
6.0–18 GHz		2.3:1 (typically 1.9:1)
18–21 GHz		3.5:1 (typically 2.7:1)
VSWR with 0 dB RF Attenuation 50 kHz–2.5 GHz		Standard measured within 3 MHz of center of preselector band for Option 01 (does not apply in Band 1). Typically 1.9:1
2.5–6.0 GHz		Typically 1.9:1
6.0–18 GHz		Typically 2.3:1
18–21 GHz		Typically 3.0:1
Maximum Safe Input (With 0 dB RF attenuation)		+13 dBm (Input Mixer Limit) 1 W with 20 dB attenuation
1 dB Compression Point (Minimum) Bands 1–5 (50 kHz–21 GHz)	-20 dBm	With no RF attenuation. In Min Distortion mode.
Optimum RF Input Level for Linear Operation		-30 dBm, referenced to the input mixer This is achieved in Minimum Distortion mode when not exceeding full screen display.

Table 2-3 (Continued)
INPUT SIGNAL CHARACTERISTICS

Characteristic	Performance Requirement	Supplemental Information
HORIZ/TRIG (Rear Panel)		Dc coupled input for external horizontal drive (selected by the EXT position of the front-panel TIME/DIV control) and ac coupled input for external trigger signals (selected at other positions of the TIME/DIV control).
Sweep Input Voltage Range		0 to +10V (dc + peak ac) for full screen deflection
Trigger Input Voltage Range	At least 1.0V peak from 15 Hz-1 MHz	
Minimum		
Maximum dc + peak ac		50V
ac		30V _{rms} -10 kHz, then derate linearly to 3.5V _{rms} at 100 kHz and above.
Pulse Width		0.1 μ s minimum
MARKER/VIDEO (Rear Panel)		External Video input or External Video Marker input, switched by pin 1 of the J104 ACCESSORIES connector.
Marker Input Level		0 to -10V Interfaces with Tektronix 1405 Sideband Adapter.
Video Input Level		0 to +4V for full screen display with pin 1 of the ACCESSORIES connector low.
J104 ACCESSORY (Rear Panel)		25-pin connector (Not RS-232 compatible) Provides bi-directional access to the instrument bus. Also provides external Video select and external preselector drive. Except for the external preselector drive output, all lines are TTL compatible. Maximum voltage on all lines is ± 15 V.
Pin 1		External Video Select Low selects External Video Input. High (default) selects Video Marker Input.
Pin 2		External Preselector — Drive signal for an external preselector. Output voltage is proportional to frequency (only Option 01 and in bands 2-5).
Pin 3		External Preselector Return — Ground return for the External Preselector signal.

Table 2-3 (Continued)
INPUT SIGNAL CHARACTERISTICS

Characteristic	Performance Requirement	Supplemental Information
J104 ACCESSORY (Continued) Pin 4		Internal Control. High (default) selects internal control. Instrument bus lines are output at the J104 ACCESSORIES connector. Low selects External control. Instrument bus lines at the J104 ACCESSORIES connector accept input from an external controller.
Pin 5		Chassis Ground
Pins 6-13 ^a		Instrument Bus Address lines 7-0 ^a
Pin 14 ^a		Instrument Bus Data Valid signal ^a
Pin 15 ^a		Instrument Bus Service Request signal ^a
Pin 16 ^a		Instrument Bus Poll signal ^a
Pin 17		Data Bus Enable input signal for external controller. High (unasserted) disables external data bus. Low enables external data bus.
Pins 18-25		Instrument Bus Data lines 0-7 Active when external Data Bus Enable (pin 17) is low.

^aOutput when internally controlled (pin 4 high) and input when externally controlled (pin 4 low).

Table 2-4
OUTPUT SIGNAL CHARACTERISTICS

Characteristic	Performance Requirement	Supplemental Information
Calibrator (CAL OUT)	-20 dBm \pm 0.3 dB at 100 MHz \pm 10 ppm ^a	100 MHz comb of markers provide amplitude calibration at 100 MHz and markers for frequency and span calibration to 1.0 GHz.
1st LO and 2nd LO OUTPUTs		Provide access to the output of the respective local oscillators. THESE PORTS MUST BE TERMINATED IN 50 Ω AT ALL TIMES.
1st LO OUTPUT Power		+7.5 dBm to +15 dBm
2nd LO OUTPUT Power		-22 dBm to 0 dBm.
VERT (OUTPUT) (Rear Panel)		Provides 0.5V \pm 5% (open circuit) of signal per division of video that is above and below the centerline. Full range -2.0V to +2.0V. Source impedance is approximately 1k Ω .
HORIZ (OUTPUT) (Rear Panel)		Provides 0.5V/Div (open circuit) either side of center. Full range -2.5V to +2.5V. Source impedance is approximately 1k Ω .
PEN LIFT (Rear Panel)		TTL compatible, nominal +5V to lift plotter pen.
10 MHz IF (OUTPUT) (Rear Panel)		Provides access to the 10 MHz IF signal. Output level is approximately -5 dBm for a full screen signal at -30 dBm reference level. Nominal impedance is approximately 50 Ω .

^a Over the operating temperature range this is +15 PPM.

Table 2-4 (Continued)
OUTPUT SIGNAL CHARACTERISTICS

Characteristic	Performance Requirement	Supplemental Information
IEEE STD 488 PORT (P version)		In accordance with IEEE 488-1978 standard and Tektronix Codes and Formats standard (version 81.1). Implemented as SH1, AH1, T5, L3, SR1, RL1, PP1, DC1, DT1, and C0. See Programmers Manual.
(Non P version)		Implemented as SH1, AH0, T3, L0, SR0, RL0, PP0, DC0, DT0 and C0.
PROBE POWER (Rear Panel)		Provides operating voltages for active probes.
Outputs		
Pin 1		+5V at 100 mA maximum
Pin 2		Ground
Pin 3		-15V at 100 mA maximum
Pin 4		+15V at 100 mA maximum
J104 ACCESSORIES (Rear Panel)		All inputs and outputs are listed in Table 2-3 INPUT CHARACTERISTICS.

Table 2-5
POWER REQUIREMENTS

Characteristic	Performance Requirement	Supplemental Information
Line Frequency Range	47-63 Hz	47 Hz to 440 Hz. Operation over 63 Hz exceeds protective grounding conductor leakage current of 3.5 mA. A redundant protective grounding means is essential to protect against electric shock.
Line Voltage Range	90 V _{ac} to 132 V _{ac}	115 V nominal
	180 V _{ac} to 250 V _{ac}	230 V nominal
Line Fuse		
115V Nominal	4A	
230V Nominal	2A Medium-Blow	
Input Power	210 W maximum (3.2A)	At 115V and 60 Hz
Leakage Current		5 mA maximum

Table 2-6
GENERAL CHARACTERISTICS

Characteristic	Performance Requirement	Supplemental Information
Sweep		Triggered, auto, manual, and external
Sweep Time	20 μ s/Div-5 s/Div in 1-2-5 sequence (10 s/Div available in AUTO)	
Accuracy	$\pm 5\%$ over center 8 divisions	
Triggering		INTERNAL, EXTERNAL, FREE RUN, and SINGLE SWEEP
Internal Trigger Level	2 divisions or more of signal	
External Trigger Input Level	1.0V peak, minimum	EXTERNAL is ac-coupled (15 Hz-1 MHz). Maximum external trigger input is 50V (dc + peak ac).
Crt Readout		Displays all parameters listed on the crt bezel, plus help and operating messages.
Battery-Powered Memory		Instrument settings, displays, calibration offsets, and peaking codes for each band are stored in battery-powered non-volatile RAM.
Battery Life		
At +55°C Ambient Temperature		1-2 years
At +25°C Ambient Temperature		At least 5 years
Temperature Range for Retaining Data Operating		0°C to +50°C
Non-Operating		-30°C to +75°C

Table 2-8
PHYSICAL CHARACTERISTICS

Characteristic	Description
Weight	50 lbs maximum Including standard accessories, except manuals.
Dimensions (See Figure 2-1) Without handles or feet	7 × 17 × 24 inches (17.78 × 43.18 × 60.96 cm)

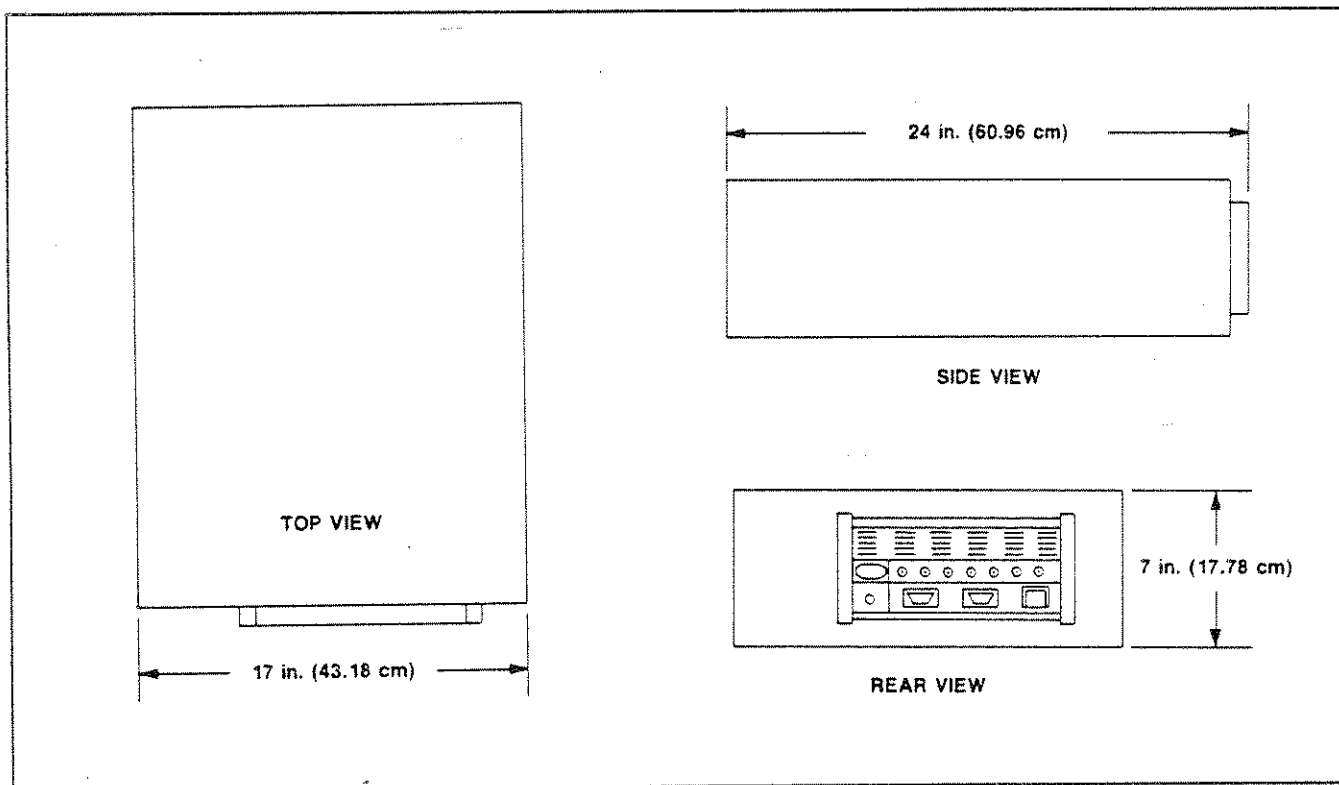

Figure 2-1. Dimensions.

PREPARATION FOR USE

This section describes unpacking, installation, power requirements, storage information, and repackaging for the spectrum analyzer.

UNPACKING AND INITIAL INSPECTION

Before unpacking the spectrum analyzer, inspect the shipping container for signs of external damage. If the container is damaged, notify the carrier as well as Tektronix, Inc. The shipping container contains the basic instrument and its standard accessories. For a list of the standard accessories, refer to Standard Accessories, in Section 1 of this Manual (or, for ordering information, refer to the list following the Replaceable Mechanical Parts list in the Service Manual, Volume 2).

If the contents of the shipping container are incomplete, if there is mechanical damage or defect, or if the instrument does not meet operational check requirements, contact your local Tektronix Field Office or representative.

Keep the shipping container if the instrument is to be stored or shipped to Tektronix for service or repair. Refer to Storage and Repackaging for Shipment later in this section.

The instrument was inspected both mechanically and electrically before shipment, and it should be free of mechanical damage and meet or exceed all electrical specifications. The Operation section of this Manual contains procedures to check functional or operational performance. Perform the functional check procedure to verify that the instrument is operating properly. This check is intended to satisfy the requirements for most receiving or incoming inspections. (A detailed electrical performance verification procedure in the Service Manual, Volume 1, provides a check of all specified performance requirements, as listed in the Specification section.)

The instrument can be operated in any position that allows air flow in the bottom and out the rear of the instrument. Feet on the four corners allow ample clearance even if the instrument is stacked with other instruments. The air is drawn in by a fan through the bottom and expelled out the back. Avoid locating the instrument where paper, plastic, or any other material might block the air intake.

INSTALLATION

The spectrum analyzer is equipped with a flipstand to adjust the viewing angle.

WARNING

Removing or replacing the cabinet on the instrument can be hazardous. Only qualified service personnel should attempt to remove the instrument cabinet.

Rackmount Instrument

Refer to the Service Manual, Volume 1, for installation instructions for the rackmount version of the instrument. Refer installation to qualified service personnel.

CAUTION

If the rackmount instrument is extended out of the rack and tipped up to gain access to the bottom or back panels of the cabinet, securely hold the instrument so it cannot fall back into the rack. Use care when doing this to avoid damaging the instrument front panel or equipment that may be mounted above the instrument.

Rack Adapter Kit

A field-installable kit is available to permit the spectrum analyzer to be rack mounted in a standard 19" wide rack on a non-tilting slide-out track. Fan-forced ventilation of the rack enclosure is highly recommended. If the rack-adapter assembly is installed in an enclosed rack, a minimum depth of 25" behind the front panel is recommended for proper air circulation. The rack adapter kit comes complete with the slide-out tracks and all mounting hardware. Contact your local Tektronix Field Office or representative for additional information and ordering instructions.

POWER SOURCE AND POWER REQUIREMENTS

The spectrum analyzer is intended to be operated from a single-phase power source that has one of its current-carrying conductors (neutral) at ground (earth) potential. It is not recommended to operate the spectrum analyzer from power sources where both current-carrying conductors are isolated or above ground potential (such as phase-to-phase on a multi-phase system or across the legs of a 110-220 V single-phase, three-wire system). In this method of operation, only the line conductor has over-current (fuse) protection within the unit. Refer to the Safety Summary at the front of this Manual.

The ac power connector is a three-wire, polarized plug with the ground (earth) lead connected directly to the instrument frame to provide electrical shock protection. If the unit is connected to any other power source, connect the unit frame to an earth ground.

Operate the spectrum analyzer from either 115 Vac or 230 Vac nominal line voltage with a range of 90 to 132 or 180 to 250 Vac, at 48 to 440 Hz. Power and voltage requirements are printed on a back-panel plate mounted below the power input jack. Refer power input changes to qualified service personnel. The Service Manual, Volume 1, contains instructions to change the input voltage range.

The international power cord and plug configuration is shown in Figure 7-1 in Section 7 of this Manual.

WARNING

Do not attempt to change the power input requirements. Unfamiliarity with safety procedures can result in personal injury. Refer all power input changes to qualified service personnel. Refer to the Safety Summary at the front of this Manual.

STORAGE AND REPACKAGING

Storage

Short Term (less than 90 days) — For short term storage, store the instrument in an environment that meets the non-operating environmental specifications in Table 2-9 in Section 2 of this Manual.

Long Term — For instrument storage of more than 90 days, use the original shipping container to repackage the instrument. Package the instrument in a vapor bag with a drying material and store in a location that meets the non-operating environmental specifications in Table 2-9 in Section 2 of this Manual.

If you have any questions, contact your local Tektronix Field Office or representative.

Repackaging for Shipment

When the spectrum analyzer is to be shipped to a Tektronix Service Center for service or repair, attach a tag that shows the owner and address, the name of the individual at your location that can be contacted, the complete instrument serial number, and a description of the service required. If the original shipping container is unfit for use or not available, use the following repackaging information.

1. Use a container of corrugated cardboard with a test strength of 375 pounds (140 kilograms) and inside dimensions that are at least six inches more than the equipment dimensions (refer to Table 2-10 in Section 2), to allow for cushioning.
2. Install the instrument front cover, and surround the instrument with plastic sheeting to protect the finish.
3. Cushion the equipment on all sides with packing material or plastic foam.
4. Seal the container with shipping tape or an industrial, heavy-duty stapler.

CONTROLS, CONNECTORS, AND INDICATORS

This section includes the descriptions of the instrument's main operating modes. It also covers the functions of the controls, selectors, indicators, and connectors for the spectrum analyzer, which are shown and identified in Figures 4-1 through 4-3 and 4-9 through 4-14. Some of the functions are described in greater detail in Section 5.

Included with many of the descriptions are syntax diagrams that graphically display the function. The ovals and circles indicate a literal element that must be sent (i.e., pushbutton pressed) exactly as shown. Boxes contain a name for an element (i.e., DATA ENTRY represents numbered pushbuttons 0 through 9 and the units terminators). The arrows that connect the elements of the syntax diagrams show the possible paths through the diagram. Parallel paths mean that one, and only one, of the paths must be followed. A path around an element or group of elements indicates an optional skip. Arrows indicate the direction that must be followed (usually the flow is to the right; but, if an element may be repeated, an arrow returns from the right to the left of the element).

The following examples illustrate basic syntax diagram structure.

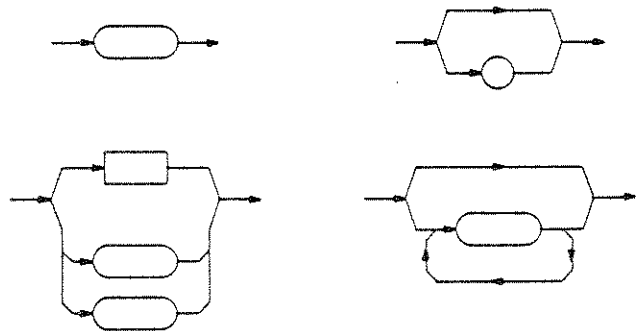

When DATA ENTRY boxes are part of a command's syntax diagram, there are numbers shown with the boxes. These numbers represent the valid range available for that particular command.

OPERATING MODES

Initial Entry Functions (Black-Labels)

Most of the spectrum analyzer operating modes are selected by a single pushbutton press or control turn; i.e., FREE RUN, TIME/DIV, PULSE STRETCHER, MAX HOLD, PEAK/AVERAGE. Generally, these selections are the same as all Tektronix 490-Series and 2750-Series Spectrum Analyzers.

Multiple-Pushbutton Sequence Functions (SHIFT Pushbutton)

<SHIFT> Functions — There are many general operating modes and two marker operating modes selected with multiple-pushbutton presses. Press the <SHIFT> pushbutton before selecting a blue-labeled function; i.e., STEP ENTRY, CAL. For some of these functions, menu prompts appear on the screen to guide you.

Terminating Multiple-Pushbutton Sequences

A SHIFT multiple-pushbutton sequence can be terminated at any time. Push the <SHIFT> pushbutton once to stop the sequence and return the spectrum analyzer to the previous activity.

DATA ENTRY Functions

Some operations require the entry of numerical data; for example, to set frequency or enter a number to select a choice from a menu. This will be as part of a multiple-pushbutton sequence, and the crt will prompt you when a number is required. Enter the number with the DATA ENTRY pushbuttons. Numerical data is entered first, with a units terminator entered last; e.g., 100.00 MHz or 20 -dBx.

Correcting Numerical Entry Errors

Use the BACKSPACE pushbutton to correct errors in numerical data that have been entered with the DATA ENTRY pushbuttons. Each pushbutton press backs the cursor up one space, erasing the number in that location. You can then enter the correct numerical data and end the sequence with a units pushbutton.

INSTRUMENT POWER CONTROL AND FREQUENCY

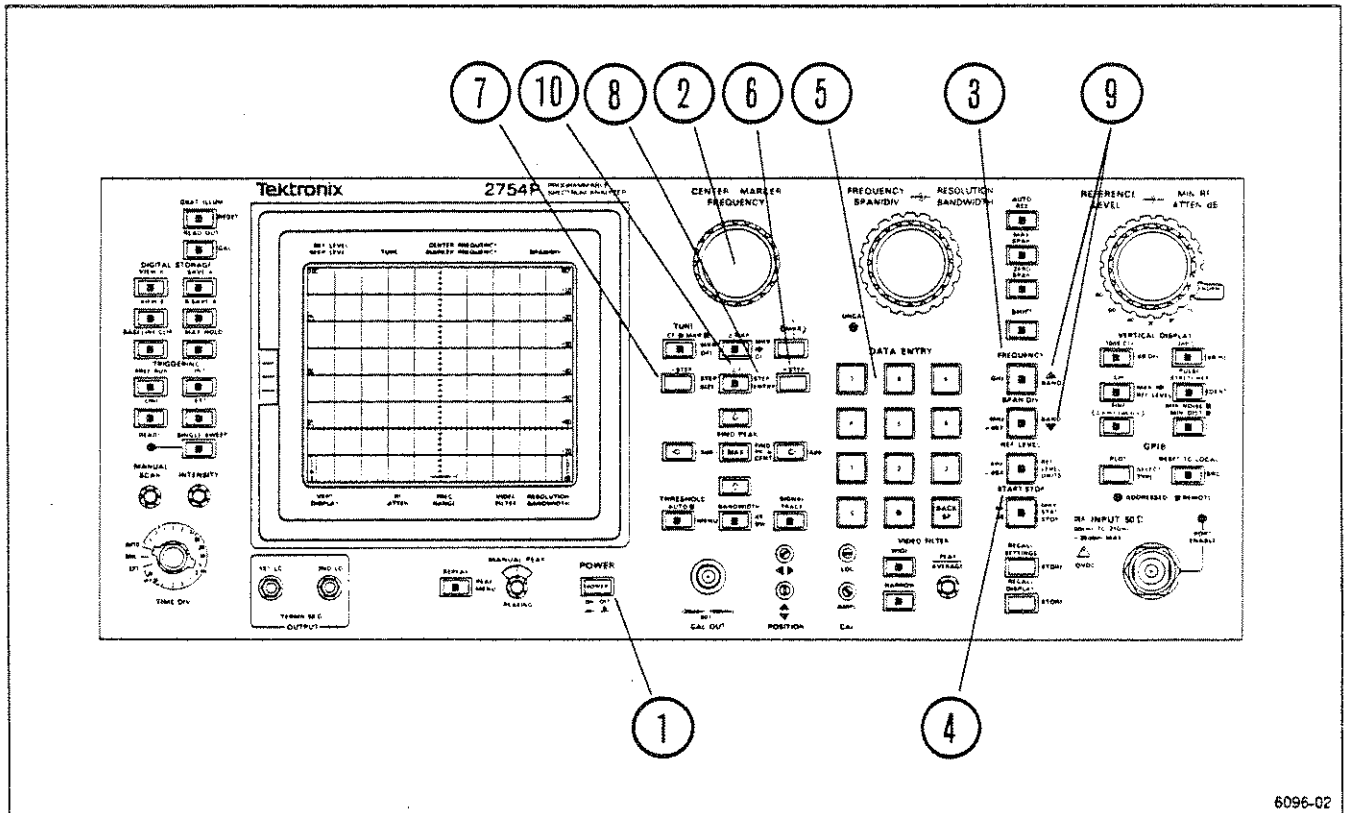
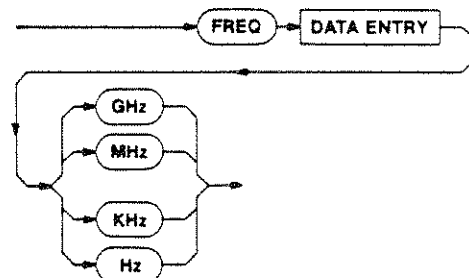

Figure 4-1

- 1 **POWER** — This push-push switch turns the main power supply ON and OFF (in=ON, out=OFF). When power is switched off, the current instrument front-panel set-up is stored in memory register 0 (see RECALL SETTINGS/STORE in Section 5) so this set-up can be easily recalled. Full RF attenuation is switched in when power is switched off to protect the 1st mixer from overload and damage.
- 2 **CENTER/MARKER FREQUENCY** — This control tunes the center frequency or marker, if selected (this function is limited to the edge of the screen). Tuning of center frequency is done in 0.1 division increments, regardless of the selected FREQUENCY SPAN/DIV. In MAX SPAN, the center frequency is fixed, and only the frequency dot is tuned. The tuning range in narrow spans is identical to wide spans; i.e., equal to the frequency range of the band selected.
- 3 **FREQUENCY** — This pushbutton allows direct entry of center or marker frequency to 1 Hz resolution (it will be displayed to 1 kHz), from the DATA ENTRY pushbuttons. If the center frequency entered is not in the current frequency range, the nearest frequency range that contains the frequency will be automatically selected. The center frequency range that can be selected is 0 Hz to 21 GHz. Values that are entered outside this range will be ignored. Frequency digits that are entered from the DATA ENTRY pushbuttons are terminated with one of the four unit pushbuttons (GHz, MHz, kHz, or Hz).



- 4 **START STOP** — This pushbutton allows you to use the DATA ENTRY pushbuttons to enter a start frequency (at the left edge of the display) and a stop frequency (at the right edge of the display). The start-stop function is usable only in the selected band.
- 5 **<SHIFT> 7** (Disable Frequency Corrections; not identified on the front panel) — This pushbutton sequence disables the frequency correction for the local oscillator. This enables the instrument to be operated with reduced performance if the oscillator frequency cannot be corrected.
- 6 **+STEP** — When the instrument is in the Tune Center Frequency mode (TUNE CF/MKR pushbutton unlit), this pushbutton increases the center frequency by steps (this function is limited to the edge of the screen). The step size is determined by **<SHIFT> STEP ENTRY** or **<SHIFT> STEP SIZE**. See **+STEP** later in this section under Marker Functions for alternate operation.
- 7 **-STEP** — When the instrument is in the Tune Center Frequency mode (TUNE CF/MKR pushbutton unlit), this pushbutton decreases the center or marker frequency by steps (this function is limited to the edge of the screen). The step size is determined by **<SHIFT> STEP ENTRY** or **<SHIFT> STEP SIZE**. See **-STEP** later in this section under Marker Functions for alternate operation.
- 8 **<SHIFT> STEP ENTRY** — This pushbutton sequence allows you to enter a desired center or marker frequency step size with the DATA ENTRY pushbuttons (this function is limited to the edge of the screen).
- 9 **<SHIFT> ΔBAND/BAND▽** — These two pushbuttons step up or down through the frequency ranges. The frequency range of the current band is displayed by the crt readout. When the frequency range (band) is changed, an attempt is made to preserve the 1st and 2nd LO frequencies. If this is not possible, the nearest center frequency limit of the band is selected. When returning to a previous band, without changing center frequency, the original LO frequencies are always used, so the center frequency is preserved.
- 10 **ΔF** — This pushbutton allows measurement of the frequency differences. When pressed (lit), the frequency readout goes to zero. The readout now shows only the offset, or deviation, from this reference as the center frequency is changed. The resolution of the readout will be the less accurate of either the current center frequency resolution or the center frequency resolution when ΔF was activated. Do not confuse this pushbutton with ΔMKR, which is described later in this section under

Marker Functions.

FREQUENCY SPAN AND RESOLUTION

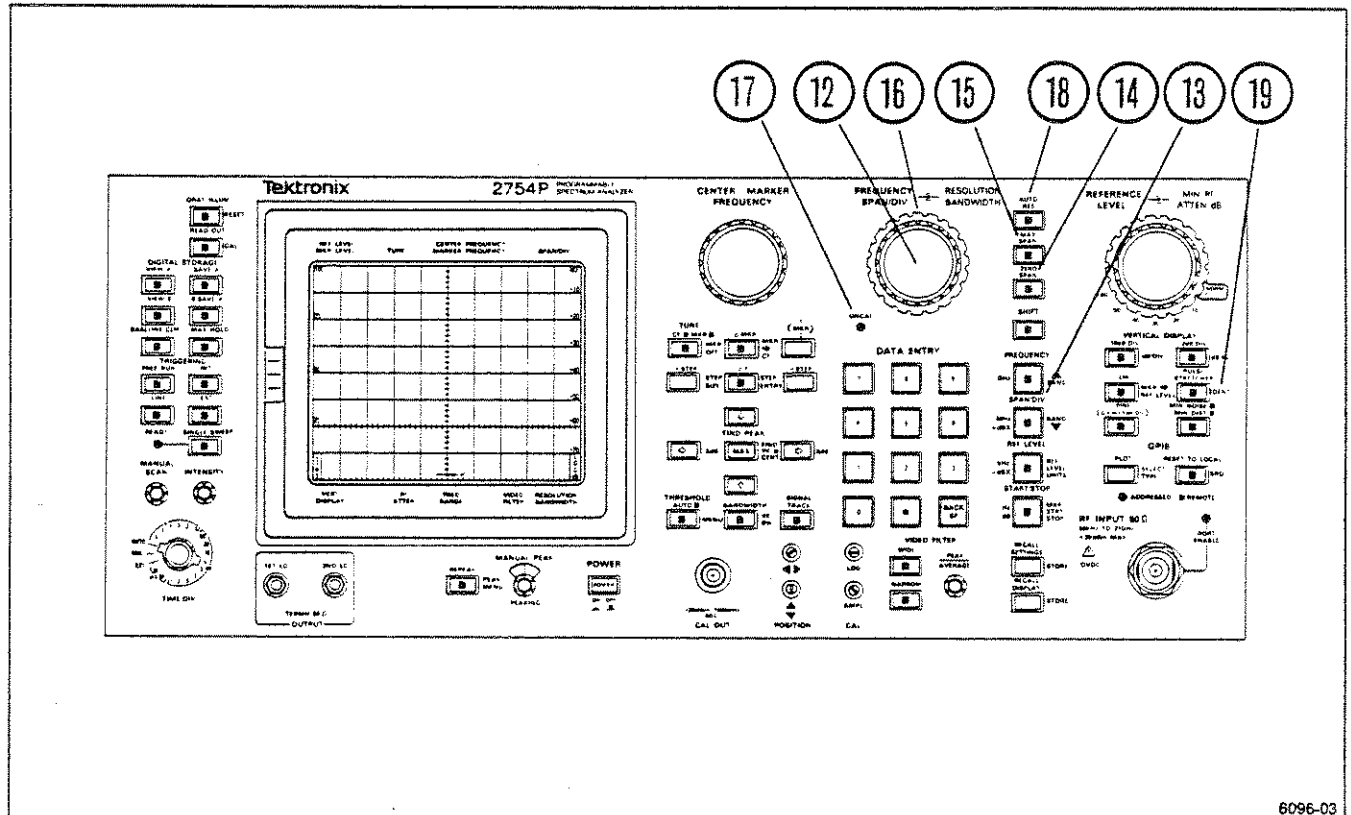

Figure 4-2

- 12 **FREQUENCY SPAN/DIV** — This control selects the frequency span swept by the spectrum analyzer. The span/div is indicated by the crt readout. The range of this control depends on the frequency band. Selection is in a 1-2-5 sequence plus max span and zero, or time domain. **FREQUENCY SPAN/DIV** can also be entered with the **SPAN/DIV** pushbutton and the **DATA ENTRY** pushbuttons. The spectrum analyzer will try to maintain a calibrated display if the **TIME/DIV** control is in the **AUTO** position or the **AUTO RES** pushbutton is active (lit).

goes to center.

When the **FREQUENCY SPAN/DIV** is reduced to zero, the spectrum analyzer operates like a tunable receiver. The spectrum analyzer displays signals within the resolution bandwidth in the time domain, with the crt reading out time/div instead of frequency span/div.

When the **FREQUENCY SPAN/DIV** is in the maximum span mode, the full band is displayed. A dot near the top of the screen indicates the center frequency readout position on the span. This dot and the center frequency position will be center screen when the **FREQUENCY SPAN/DIV** is reduced from the **MAX** span position. When the markers are on, they show the frequency position, and the dot

- 13 **SPAN/DIV** — This pushbutton allows direct entry of FREQUENCY SPAN/DIV, with two significant digits of resolution. The span/div range that can be selected is 200 Hz/div to 1 GHz/div. The maximum range available is a function of frequency range. If a value outside the allowable range is entered, the Span/Div will switch to the lowest non-zero or maximum span. Spans entered from the DATA ENTRY pushbuttons are terminated with one of the four unit pushbuttons (GHz, MHz, kHz, or Hz).

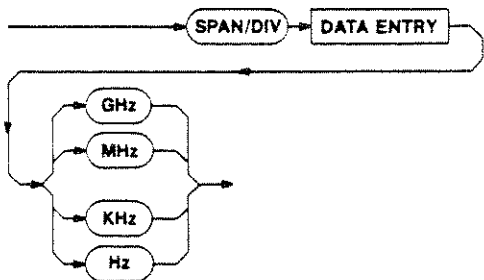

- 14 **ZERO SPAN** — This pushbutton switches the span to zero for time domain display. When deactivated, the Span/Div returns to its previous value.
- 15 **MAX SPAN** — When activated, the spectrum analyzer sweeps the entire range of the current frequency band. The position of the spectrum analyzer's center frequency is shown with a dot near the top of the screen. When this function is turned off, the span returns to the previous Frequency Span/Div setting. When the markers are on, they show the frequency position, and the dot goes to center.
- 16 **RESOLUTION BANDWIDTH** — This control selects the bandwidth of the spectrum analyzer. Selected bandwidth is indicated on the crt readout. The bandwidth selections are 1 kHz, 10 kHz, 100 kHz, and 1 MHz. Time/div is automatically selected when the TIME/DIV control is in the AUTO position.
- 17 **UNCAL** — This indicator lights when the display amplitude or frequency is no longer calibrated; e.g., the sweep rate is not compatible with the frequency span/div and resolution bandwidth. Select a slower sweep rate or larger resolution bandwidth to return to calibrated operation.
- 18 **AUTO RES** — When this function is on, resolution bandwidth is automatically selected to maintain a calibrated display for the selected Freq Span/Div, Time/Div, Video Filter, and Vertical Display modes. When the TIME/DIV control is in the AUTO posi-

tion, resolution bandwidth is selected as a function of Freq Span/Div only, and Time/Div is selected to maintain a calibrated display at the highest sweep rate. The RESOLUTION BANDWIDTH control will not operate when AUTO RES is on (the message AUTO RES MUST BE OFF TO CHANGE RESOLUTION will appear on the screen).

- 19 **<SHIFT> IDENT** — This pushbutton sequence separates real signals from spurious responses when using the spectrum analyzer without a pre-selected front end. This pushbutton causes every other trace to be displaced vertically. The 1st and 2nd local oscillator frequencies shift so that real, or true, signals are not displaced horizontally on alternate sweeps (1/2 division), while spurious signals can be shifted to more than 100 MHz, or even off screen. The FREQ SPAN/DIV must be 50 kHz or less before the Identify mode can be used.

MARKER FUNCTIONS

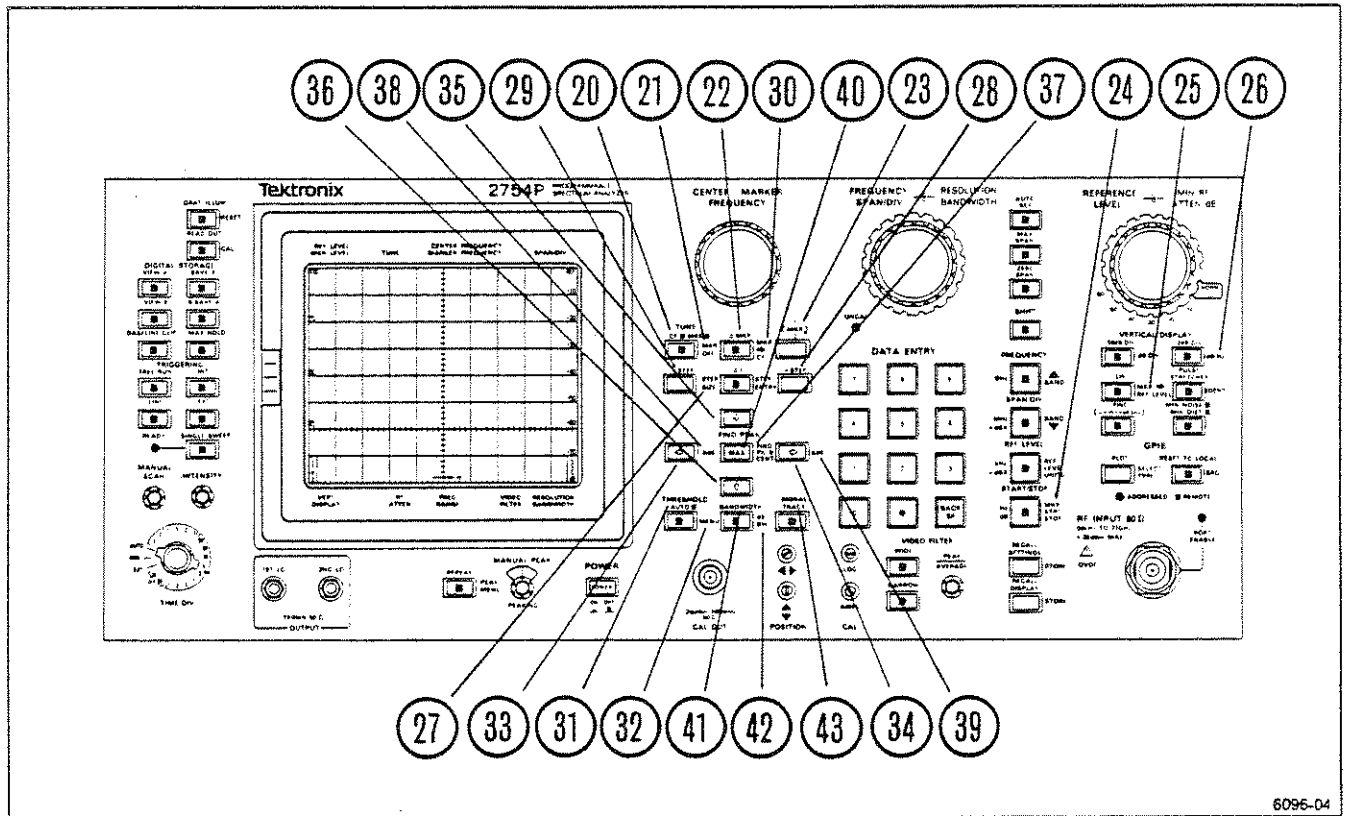

Figure 4-3

- | | |
|--|---|
| <p>20 TUNE CF/MKR — When this pushbutton is lit, a single marker is turned on at the trace of highest priority, and you can move the marker with CENTER/MARKER FREQUENCY control. When the pushbutton is pressed again, the marker stays on and does not change its horizontal positioning; the CENTER/MARKER FREQUENCY control now adjusts the center frequency.</p> <p>21 <SHIFT> MKR OFF — This pushbutton sequence turns the marker(s) off.</p> <p>22 Δ MKR — This pushbutton activates a second marker at the position of the single marker on the trace (or turns on the Delta Marker mode if markers are off). The symbols () will appear on the screen on the marker frequency readout line to indicate delta frequency and delta amplitude.</p> | <p>23 1-MKR-2 — This pushbutton alternately selects which marker will be tuned when Δ MKR is on.</p> <p>24 <SHIFT> MKR START STOP — This pushbutton sequence allows you to set the start and stop frequencies directly from the delta marker position (this function is not available with a stored trace. Δ MKR must be on for this function to operate).</p> <p>25 <SHIFT> MKR → REF LVL — This pushbutton sequence changes the reference level of the top graticule to the present marker amplitude (this function is not available with a stored trace).</p> <p>26 <SHIFT> dB/Hz — This pushbutton sequence mathematically figures the 1 Hz noise level at the current marker position.</p> |
|--|---|

- 27 **<SHIFT> STEP SIZE** — This pushbutton sequence defines the frequency step as the center frequency, marker frequency, or the delta marker frequency, whichever mode is active (this function is limited to the edge of the screen).
- 28 **-STEP** — When the instrument is in the tune marker mode (the TUNE CF/MKR pushbutton is lit), this pushbutton increases the marker frequency by steps (this function is limited to the edge of the screen). The step size is determined by **<SHIFT> STEP SIZE** or **<SHIFT> STEP ENTRY**. See **+STEP** earlier in this section under Frequency for alternate operation.
- 29 **+STEP** — When the instrument is in the tune marker mode (the TUNE CF/MKR pushbutton is lit), this pushbutton decreases the marker frequency by steps (this function is limited to the edge of the screen). The step size is determined by **<SHIFT> STEP SIZE** or **<SHIFT> STEP ENTRY**. See **+STEP** earlier in this section under Frequency for alternate operation.
- 30 **<SHIFT> MKR → CF** — This pushbutton sequence centers the signal at the active marker by setting the center frequency equal to the marker frequency (this function is not available with a stored trace).
- 31 **THRESHOLD** — In Auto mode (button lit) this pushbutton selects the minimum signal level recognized in **FIND PEAK ↑**, **FIND PEAK ↓**, **FIND PEAK ←**, **FIND PEAK →**, **FIND PEAK MAX**, **dB BW**, and **SIGNAL TRACK**.
- 32 **<SHIFT> MENU** — This pushbutton calls up a menu display on the crt that allows selection of the threshold levels. You must define both **SET SIGNAL TYPE** and **SET XdB** when **THRESHOLD** is in this Menu mode.

SET SIGNAL TYPE — This alters the marker functions to recognize one of three signal types above the threshold.

CW — Identifies continuous wave signals and ignores spurious signals and impulses.

PULSE — Identifies the peak of pulsed RF lobes for either line (lines must be <2 minimum divisions apart), or dense spectra.

SPURS — Identifies all signals.

SET XdB — Using the **DATA ENTRY** keypad, enter the minimum value that the instrument recognizes when in Find Peak modes.

Figure 4-4 is a signal enlarged to show how the spectrum analyzer locates the signal peak with one of the signal processing functions. The signal processing functions are **FIND PEAK ←**, **FIND PEAK →**, **FIND PEAK ↓**, **FIND PEAK ↑**. The spectrum analyzer looks at both the individual left-most and right-most peaks of a signal. From this reading, the spectrum analyzer calculates the exact center of the signal. If this location is a digital storage point, the marker is positioned here. If, as in Figure 4-4, the calculated center of the signal is not equal to the maximum digital storage point, the marker is positioned on the closest point to the center. At the end of this Marker Functions portion are five illustrations showing the use of this signal finding command.

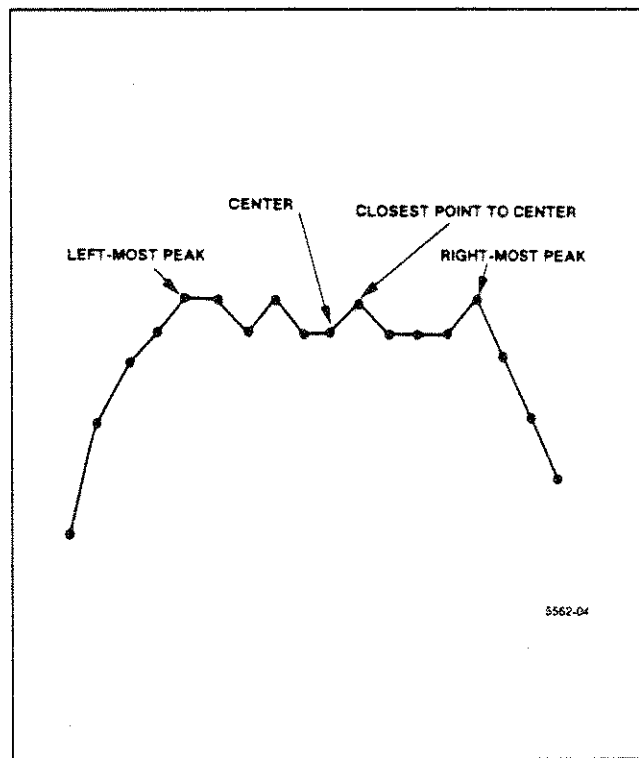

Figure 4-4. Locating the signal peak.

- 33 **FIND PEAK ←** — This moves the Marker to the next signal lower in frequency than the present marker. If there is no signal lower in frequency than the Marker that meets threshold and signal type parameters, one of the following messages will be displayed on screen (depending on whether **CW**, **PULSE**, or **SPURS** has been selected as signal type) —

NO CW TO THE LEFT ABOVE THRESHOLD

NO PULSE TO THE LEFT ABOVE THRESHOLD

NO SPUR TO THE LEFT ABOVE THRESHOLD

- 34 **FIND PEAK ←** — This moves the Marker to the next signal higher in frequency than the present marker. If there is no signal higher in frequency than the Marker that meets threshold and signal type parameters, one of the following messages will be displayed on screen (depending on whether CW, PULSE, or SPURS has been selected as signal type) —

NO CW TO THE RIGHT ABOVE THRESHOLD

NO PULSE TO THE RIGHT ABOVE THRESHOLD

NO SPUR TO THE RIGHT ABOVE THRESHOLD

- 35 **FIND PEAK ↑** — This moves the Marker to the next signal higher in amplitude than the present marker. If there is no signal higher in amplitude than the Marker that meets threshold and signal type parameters, one of the following messages will be displayed on screen (depending on whether CW, PULSE, or SPURS has been selected as signal type) —

NO HIGHER CW SIGNAL ABOVE THRESHOLD

NO HIGHER PULSE SIGNAL ABOVE THRESHOLD

NO HIGHER SPUR ABOVE THRESHOLD

- 36 **FIND PEAK ↓** — This moves the Marker to the next signal lower in amplitude than the present marker. If there is no signal lower in amplitude than the Marker that meets threshold and signal type parameters, one of the following messages will be displayed on screen (depending on whether CW, PULSE, or SPURS has been selected as signal type) —

NO LOWER CW SIGNAL ABOVE THRESHOLD

NO LOWER PULSE SIGNAL ABOVE THRESHOLD

NO LOWER SPUR ABOVE THRESHOLD

- 37 **FIND PEAK MAX** — This pushbutton places the Primary marker at the peak of the highest on-screen signal without regard to signal type (CW, PULSE, SPURS). Peak B would be selected from the cluster in Figure 4-5A, peak A would be selected in Figure 4-5B because the low point (B) would stop a search from continuing to the cluster (C).

- 38 **<SHIFT> XdB →** — This allows you to select the number of dB to move the Primary marker down in frequency while staying on the trace (horizontal

movement to the left). If there is no level to the left of the Primary marker that meets threshold and signal type parameters, the message NO POINT TO THE LEFT TO MOVE TO will be displayed on screen.

- 39 **<SHIFT> XdB ←** — This allows you to select the number of dB to move the Primary marker up in frequency while staying on the trace (horizontal movement to the right). If there is no level to the right of the Primary marker that meets threshold and signal type parameters, the message NO POINT TO THE RIGHT TO MOVE TO will be displayed on screen.

- 40 **<SHIFT> FIND PK & CENT** — This places the active marker at the peak of the highest on-screen signal (refer to FIND PEAK MAX description earlier in this section). If a signal is present, the center frequency is set equal to the marker frequency; this centers the signal of interest. If there is no signal above the threshold, the message NO POINT FOUND ABOVE THE THRESHOLD will be displayed on the screen, and the marker will not move, which is useful to center a signal just before reducing the span/div by several settings at once.

- 41 **BANDWIDTH** — This pushbutton places markers on a selected signal and displays the XdB bandwidth (select <SHIFT> dB BW to set X). The screen will display NO SIGNAL — BW IDLE when there is no signal at the marker that meets threshold and peak excursion parameters.

- 42 **<SHIFT> dB BW** — This selects the value for the Bandwidth mode.

- 43 **SIGNAL TRACK** — This pushbutton automatically maintains tuning of a drifting signal within limits. While this mode is active SIGNAL TRACK will be displayed on the screen; SIGNAL TRACK IDLE will be displayed when there is no signal above the threshold. Select SET SIGNAL THRESHOLD from the Menu to set the threshold.

Signal Finding

To the finding routine, a signal consists of a peak above threshold and two points (one on each side of the peak) that are 3 dB below the peak. The location of the signal is the highest amplitude point on the signal. Figures 4-6 through 4-8 illustrate the use of SET SIGNAL TYPE that can be selected from the MENU. All of the figures use the signal processing function FIND PEAK ←. Any of the other signal processing functions (FIND PEAK →, FIND PEAK ↓, FIND PEAK ↑) work similarly, according to their specific function. The minimum bandwidth criteria is defined as the two 3 dB down points that must be <5 kHz (1/2 a resolution bandwidth) apart.

Figures 4-7 Top, 4-7 Bottom, and 4-6 Top — If CW was selected, the spectrum analyzer would not identify any signal because none of the signals displayed meets the minimum bandwidth criteria. If PULSE was selected, the signals labeled D, E, and F would be identified because the other signals in the display are less than 2 minor divisions apart. If the signals were greater than 2 minor divisions apart, PULSE would have identified all labeled signals (A, B, C, etc.). If SPURS was selected, all signals would be identified (A, B, C, etc.).

Figure 4-8 — The NEXT RIGHT function begins at the left screen margin. With this display, CW, PULSE, and SPURS will each identify all of the signals because they all meet the minimum bandwidth criteria (i.e., the selections would be A, B, C, D, and E).

Figure 4-6 Bottom — The threshold is assumed to be -70 dBm. If CW was selected, signals B, E, F, and G would be identified. The other signals would not be identified because they do not meet the minimum bandwidth criteria. If PULSE was selected, signals A, B, D, E, F, and G would be identified. Signal C would be skipped, because it is within 2 minor divisions from signal B. The PULSE algorithm will think signal C is a part of signal B. If SPURS was selected, all signals would be identified.

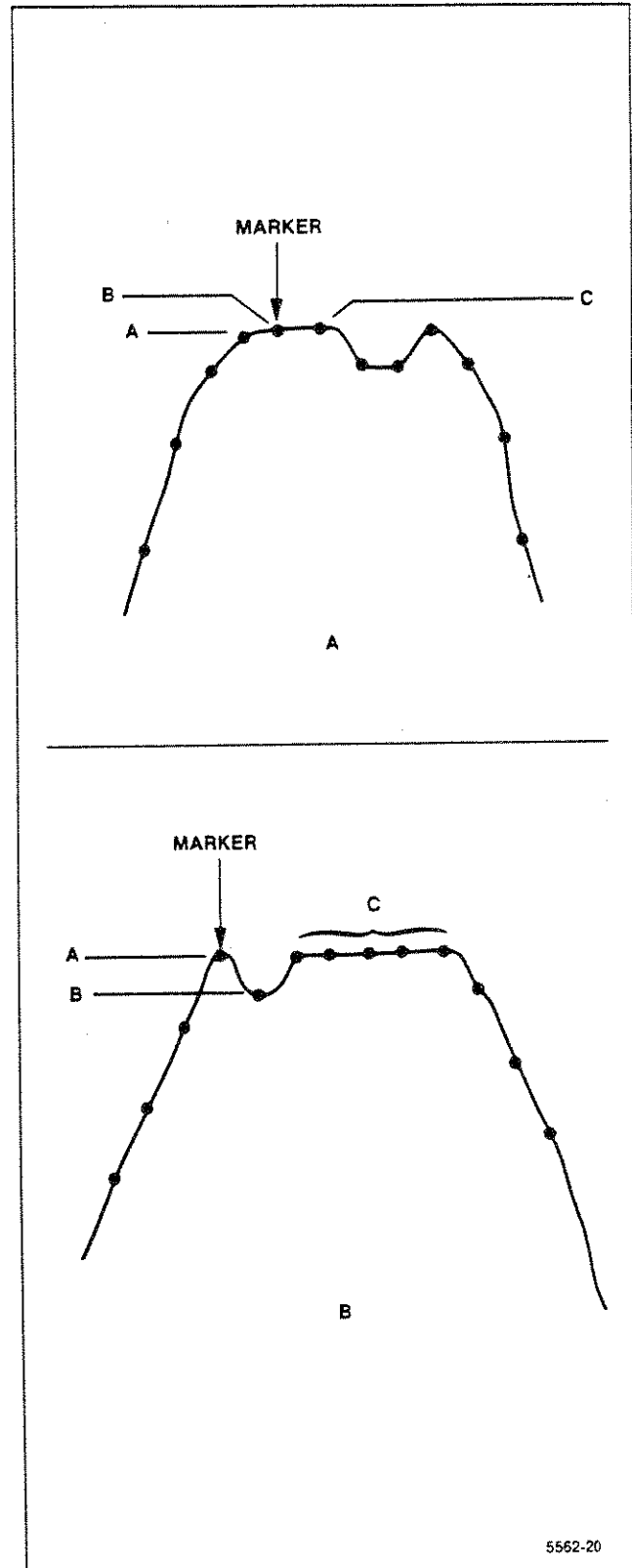

Figure 4-5. Using FIND PEAK MAX.

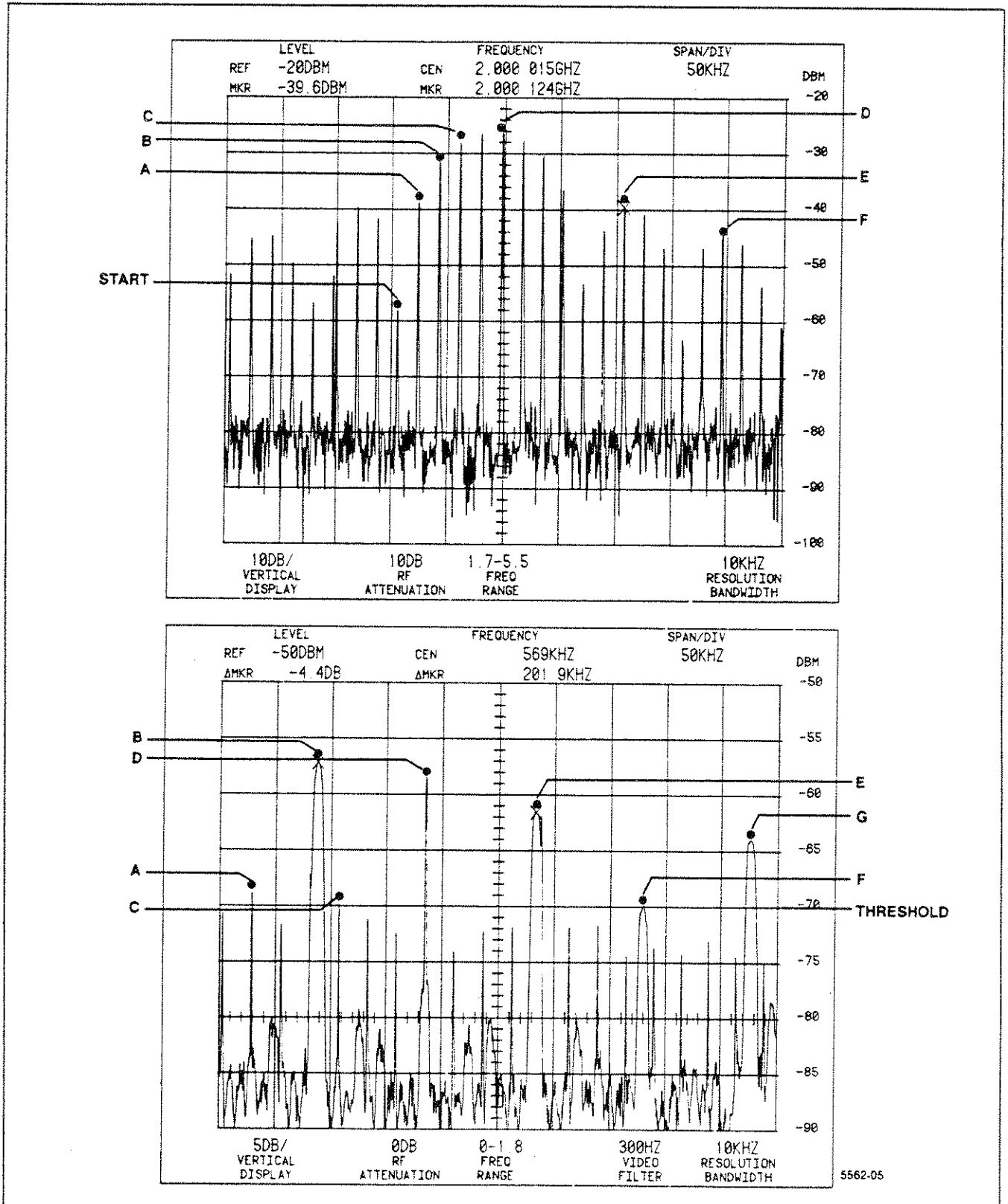
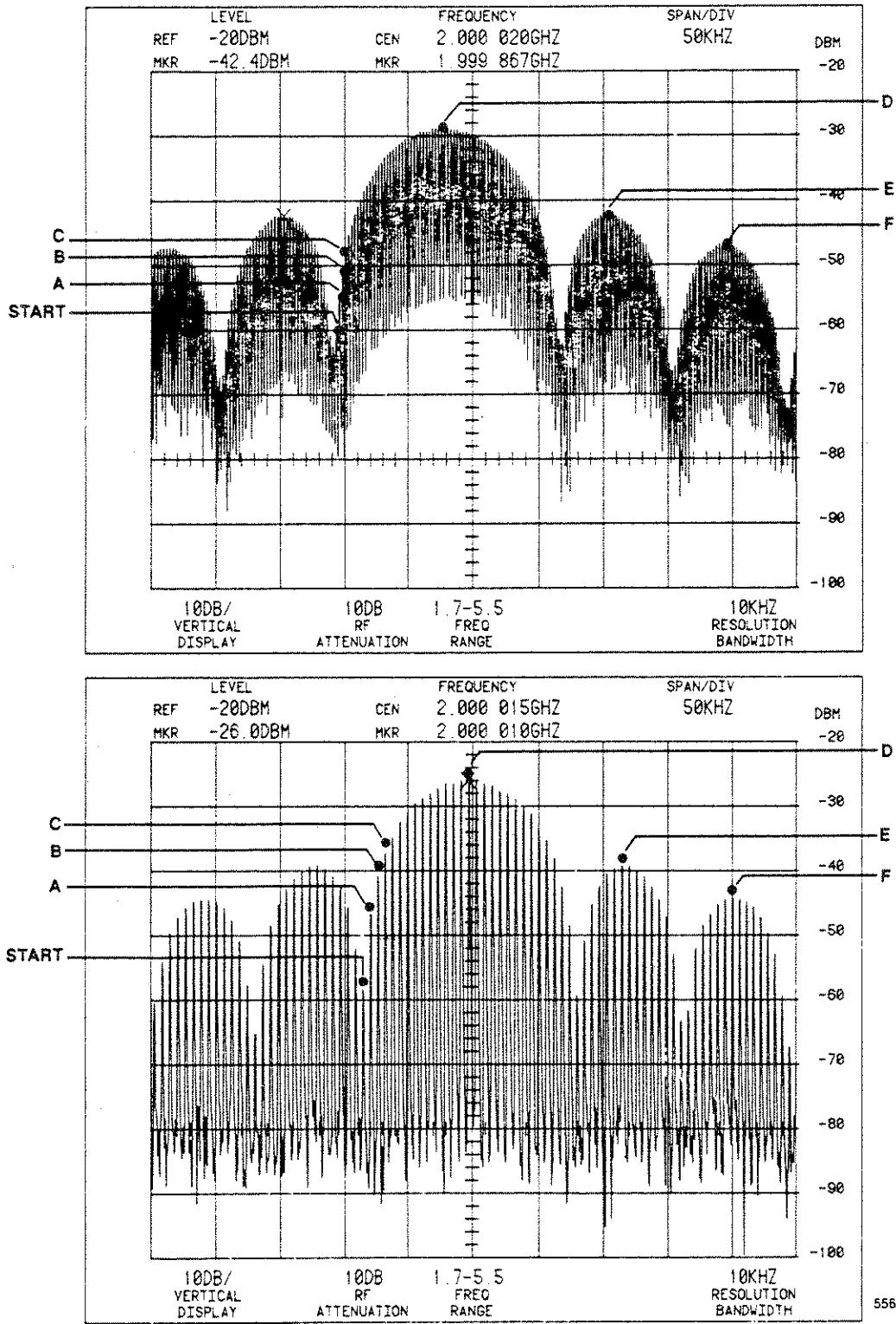

Figure 4-6. Signal finding examples.



5562-06

Figure 4-7. Signal finding examples.

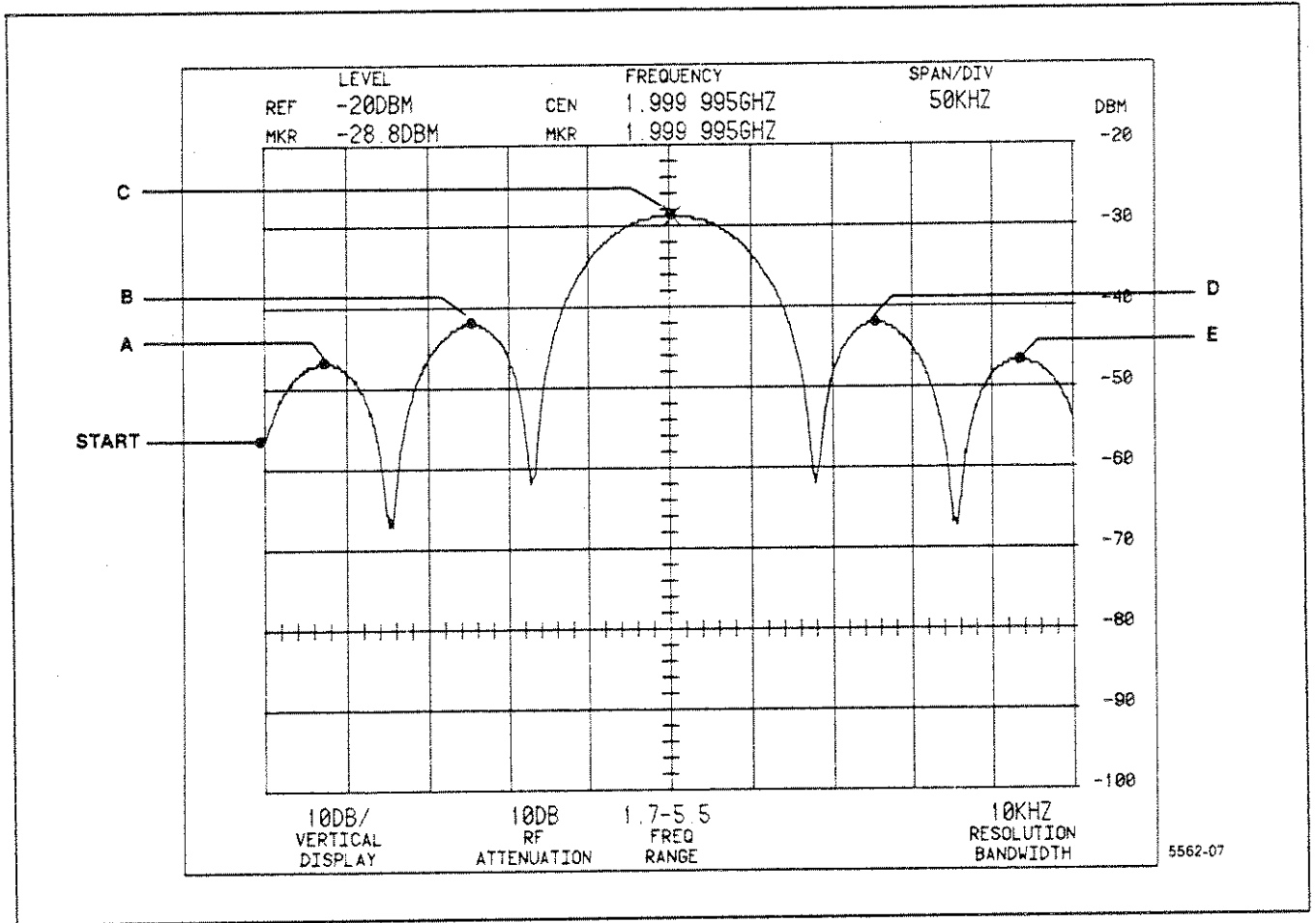

Figure 4-8. Signal finding example.

DISPLAY PARAMETERS

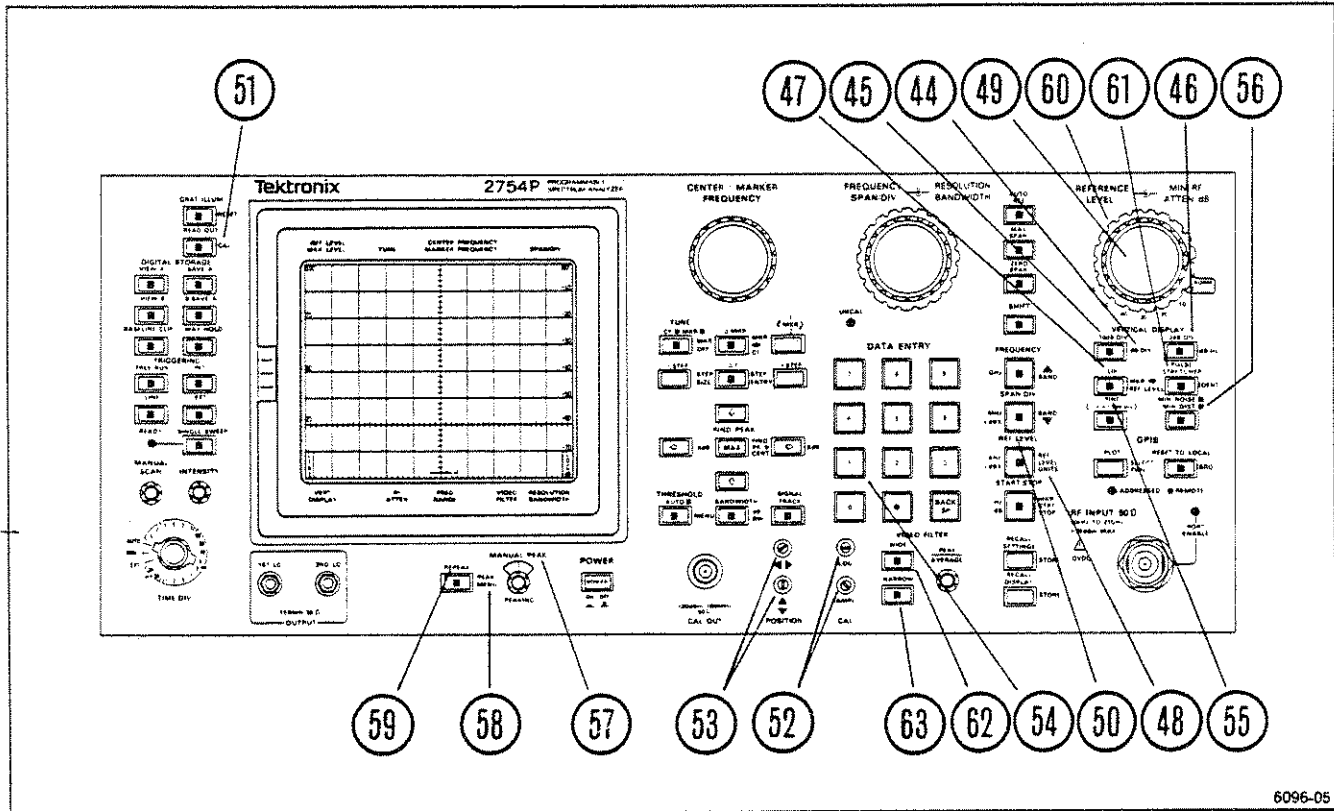

Figure 4-9

44 <SHIFT> dB/DIV — This pushbutton sequence allows direct entry of the desired amplitude display factor. The range is 1 to 15 dB/div in 1 dB increments. Although a display with greater than an 80 dB range can be selected, the actual measurement range will not exceed 80 dB. Numbers outside the allowable range will be ignored. Terminate the dB/div number entered with the dB pushbutton.



VERTICAL DISPLAY — These three pushbuttons select the vertical display factors. The crt readout indicates the selection. The vertical display factor, in the Log mode, can also be entered with the DATA ENTRY pushbuttons.

45 10 dB/DIV — With this pushbutton activated, the dynamic range of the display is a calibrated 80 dB with each major graticule division representing 10 dB.

46 2 dB/DIV — This pushbutton increases resolution so that each major graticule division represents 2 dB. Display dynamic range is 16 dB.

47 LIN — With this pushbutton activated, a linear display between zero volts (bottom graticule line) and the reference level (top graticule line), scaled in volts/division, is selected (see the REFERENCE LEVEL description).

48 <SHIFT> REF LEVEL UNITS — This pushbutton sequence allows the selection of reference level units to be dBm, dBV, dBmV, or dBμV.

49 **REFERENCE LEVEL** — This control changes the reference level one step for each stop. Automatic selection of the IF gain and RF attenuation provide for the best overall noise and distortion performance. In the Log Vertical Display mode, when FINE is not activated, the step size equals the selected dB/div factor; except for 2 dB/div, where step size is 1 dB. When FINE is activated, the step size is 1 dB for dB/div factors of 5 or more and 0.25 dB for Vertical Display factors of <5 dB/div. When the display factor is <5 dB/div and FINE is activated, the Delta A mode is selected. Refer to Section 6 for a description of the Delta A mode.

50 **REF LEVEL** — This pushbutton allows direct entry of reference level, with 1 dB resolution. The range is +30 dBm to -117 dBm (+40 dBm if the Minimum Noise mode is selected). Values entered outside this range are ignored (values will be in the selected units; dBm, dBV, dBmV, or dBμV). Either the +dBx or -dBx pushbutton terminates the reference level numbers entered.

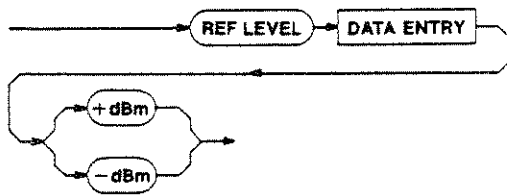

51 **CAL** — This pushbutton sequence starts a frequency and reference level measurement procedure that uses the spectrum analyzer calibrator. Messages on the crt screen will guide you through the adjustments of vertical and horizontal POSITION, and LOG and AMPL CAL. The spectrum analyzer then runs an automatic frequency, bandwidth, and relative amplitude measurement routine for the resolution bandwidth filters.

The frequency measuring routine adjusts center frequency by measuring the frequency of each resolution bandwidth filter to reduce center frequency variation when changing resolution bandwidth. The relative amplitude measuring routine reduces reference level variation when changing Resolution Bandwidth. To ensure that the instrument meets frequency and amplitude performance characteristics, run these routines whenever the instrument's surrounding temperature changes significantly. Cal factors that are used internally to correct for the errors measured by this function are retained in memory when the instrument power is off. To display these factors, press <SHIFT> 1.

52 **LOG and AMPL CAL** — These screwdriver adjustments calibrate the vertical portion of the display. LOG CAL adjusts the logarithmic gain in dB/div, and AMPL CAL adjusts the display amplitude. Press <SHIFT> CAL to initiate a procedure that will guide you through these adjustments, as well as the vertical and horizontal POSITION adjustments. Refer to <SHIFT> CAL for additional information.

53 **POSITION ΔΔΔΔ** — These screwdriver adjustments position the display along the horizontal and vertical axes. The <SHIFT> CAL pushbutton sequence will guide you through the adjustment of these controls. Refer to <SHIFT> CAL for additional information.

54 **<SHIFT> 1 (Self-Measurement Results; not identified on the front panel)** — The factors used to internally correct for frequency and amplitude errors are displayed. The factors shown are as measured with the last <SHIFT> CAL operation. If one of the factors could not be measured at the last operation, the old value will be noted. This means that the previously measured value is used. If < or > appears next to the amplitude calibration factor, it means that this filter's amplitude related to the 1 MHz filter is outside the range of correction (correction is set to the limit). Press <SHIFT> to exit the calibration factor display.

55 **FINE (Δ A IN <5 dB/DIV)** — This pushbutton selects step size for the REFERENCE LEVEL control. When FINE is off, step size is equal to dB/div, except 2 dB/div where step size is 1 dB. When FINE is on, step size is 1 dB for display factors of 5 dB/div or more, and 0.25 dB for display factors of <5 dB/div. When step size is 0.25 dB, the Delta A mode is selected. The crt Ref Level readout goes to 0.00 dB, and the REFERENCE LEVEL control steps in 0.25 dB increments. These fine steps provide the means to make accurate relative amplitude measurements over a 48 dB measurement range. Refer to Delta A mode operation in Section 6 for more details.

56 **MIN NOISE/MIN DISTortion**

MIN NOISE (pushbutton lit) — In this mode, the noise level is reduced by changing the RF attenuation and IF gain used for a particular reference level. Both are reduced 10 dB so noise generated in the IF stages is decreased; however, intermodulation distortion products will increase. RF attenuation must be at least 10 dB for this control to have any effect.

MIN DISTortion (pushbutton not lit) — In this mode, intermodulation distortion products are minimized. This is the usual operating mode.

- 57 **MANUAL PEAK (PEAKING)** — This control peaks the internal preselector tracking in Option 01 instruments. The peak code consists of numbers at 500 MHz intervals. The control is used to peak signal response.
- 58 **<SHIFT> PEAK MENU** — This pushbutton sequence calls up a menu that lists the available methods to adjust the preselector tracking. The **MANUAL PEAK** control can be selected, peaking code can be stored in memory, and then used in the selected band; a number from 0 to 1023 can be run for electronic tuning; or an automatic repeak routine can be run that replaces the stored peak value for a particular band.
- 59 **REPEAK** — The **REPEAK** function maximizes the amplitude of a signal that is ± 1 division of the active frequency marker.
- 60 **MIN RF ATTEN dB** — This control specifies the lowest value of input attenuation that will be used when **REF LEVEL** is selected. This allows operator-control to protect the front end of the analyzer against overload and/or damage from excessive signal level into the 1st mixer. Actual attenuation is set according to the **MIN RF ATTEN dB**, **REFERENCE LEVEL**, and **MIN NOISE/MIN DISTORTION** selections and is displayed on the crt readout. If the **MIN RF ATTEN dB** setting is increased, the IF gain is automatically changed to maintain the current reference level, if possible.

- 61 **PULSE STRETCHER** — This pushbutton causes the fall-time of pulse signals to be increased so very narrow pulses can be seen. The effect is most apparent for pulsed RF signals where pulse width is small compared to one division of sweep time. Pulse stretcher operation may be necessary for a digital storage display of such signals, to ensure that the correct amplitude is displayed.

VIDEO FILTER

- 62 **WIDE** — This pushbutton reduces video bandwidth and high-frequency components for display noise averaging. The video bandwidth selected is approximately 1/30th of the selected resolution bandwidth. Selecting **WIDE** cancels **NARROW**. The filter value is displayed in the lower readout.
- 63 **NARROW** — This pushbutton reduces video bandwidth and high-frequency components for display noise averaging. The video bandwidth selected is approximately 1/300th of the selected resolution bandwidth. Selecting **NARROW** cancels **WIDE**. The filter value is displayed in the lower readout.

SWEEP

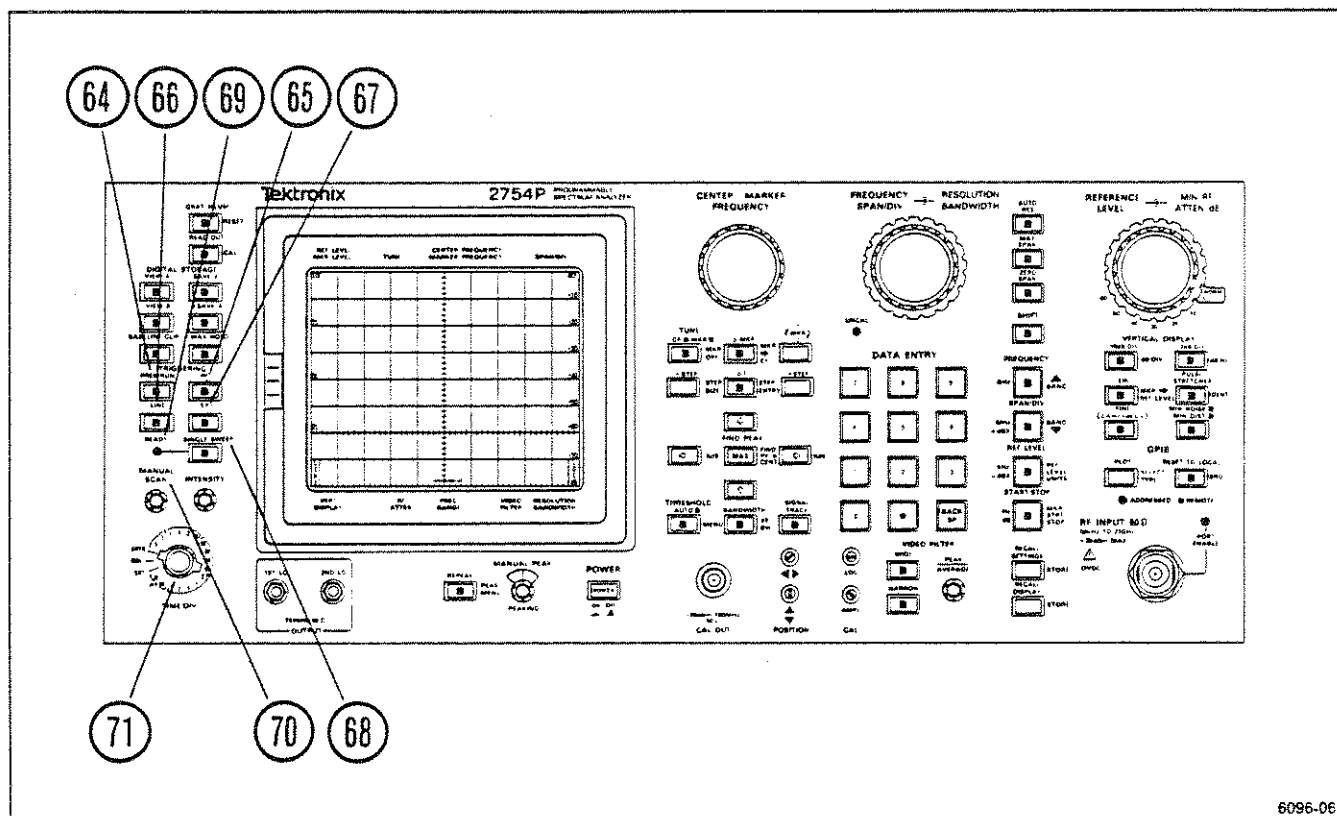

Figure 4-10

TRIGGERING

- 64 **FREE RUN** — This pushbutton allows the sweep to free run without regard to trigger source. Other TRIGGERING selections are cancelled, including single-sweep.
- 65 **INT** — This pushbutton allows the sweep to be triggered by any signal at the left edge of the display that has an amplitude of 2.0 divisions or more. Other TRIGGERING selections are cancelled, including single-sweep.
- 66 **LINE** — This pushbutton allows a sample of the ac power line voltage to trigger the sweep. Other TRIGGERING selections are cancelled, including single-sweep.
- 67 **EXT** — This pushbutton allows the sweep to be triggered by signal between 1.0 V peak (minimum) to 50 V peak (maximum) that are applied through the rear-panel HORIZTRIG (EXT IN) connector. Other TRIGGERING selections are cancelled, including single-sweep.
- 68 **SINGLE SWEEP** When first pressed, this pushbutton activates the single-sweep mode and aborts the current sweep. When pressed again, the sweep trigger circuit is armed, the READY indicator is lit, and the center frequency is corrected. The sweep will run only after it receives a trigger signal. When SINGLE SWEEP is selected, the TRIGGERING selection (i.e., FREE RUN, INTERNAL, LINE, or EXTERNAL) is not changed. Select any TRIGGERING selection to cancel SINGLE SWEEP.

69 **READY** (only used in the Single Sweep mode) — This indicator lights when the trigger circuit is armed and ready for a trigger signal. It remains lit until the sweep ends.

70 **MANUAL SCAN** — With TIME/DIV in the MNL position, rotate this control to Manually scan the spectrum.

71 **TIME/DIV** — This control selects sweep rates from 5 s/div to 20 us/div, in a 1-2-5 sequence, in addition to AUTO, MaNuaL, and EXTernal sweeps.

AUTO (automatic) — This position allows the sweep rate to be selected automatically to maintain a calibrated display for most FREQUENCY SPAN/DIV, RESOLUTION BANDWIDTH, VIDEO FILTER, and Vertical Display selections.

EXT (external sweep) — This position allows the sweep circuit to be driven by a signal applied to the rear-panel HORIZ|TRIG (EXT IN) connector. A voltage ramp of 0 to +10 V will sweep 10 divisions of horizontal (X) axis.

MNL (Manual) — This position allows the spectrum or display to be manually swept with the MANUAL SCAN control.

DIGITAL STORAGE

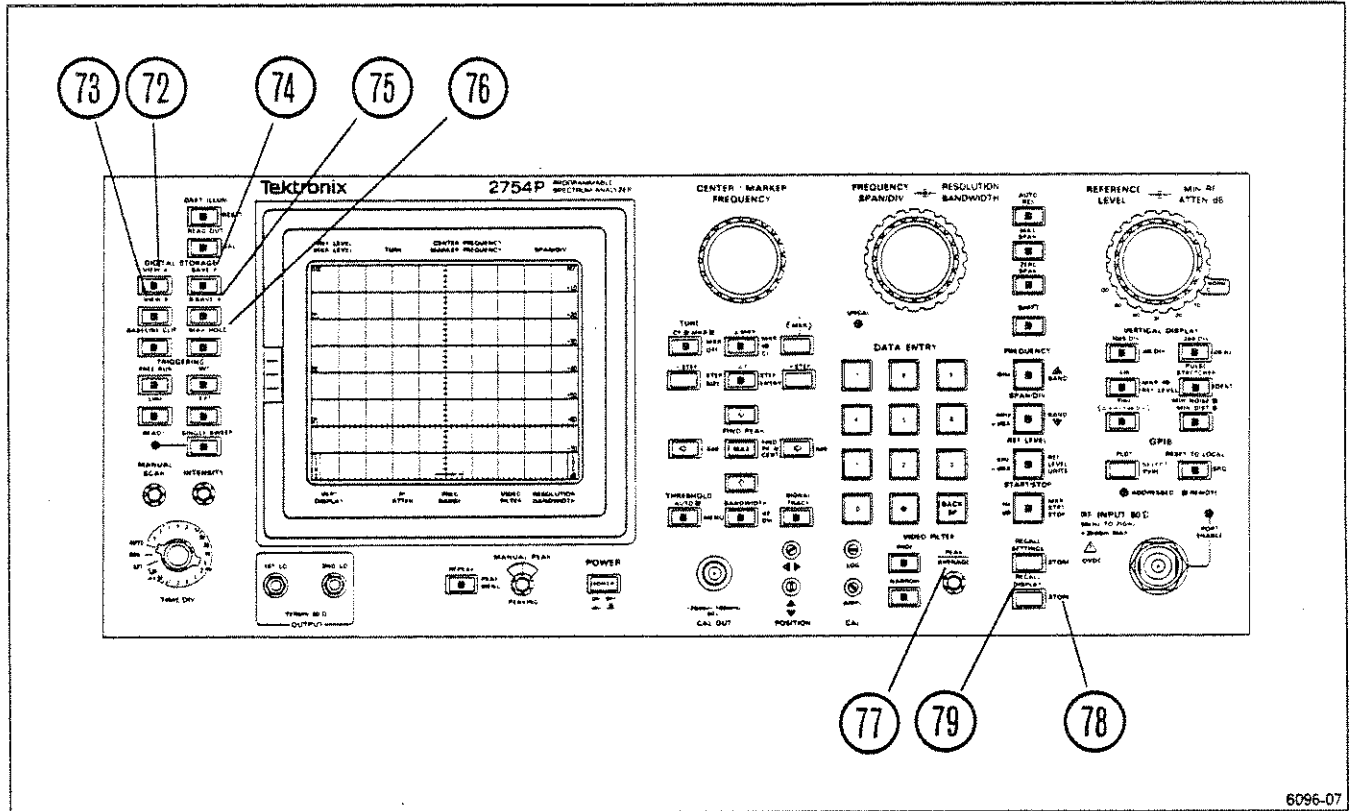

Figure 4-11

DIGITAL STORAGE — These pushbuttons allow either or both sections of memory to be selected to provide digital storage. When VIEW A and VIEW B are activated, contents of both the A and B memories are displayed on the screen. Both sections are updated with each sweep.

- 72 **VIEW A** — This pushbutton causes the A waveform to be displayed. If SAVE A is on and only the A waveform is being viewed, the crt readout will show the settings when the A waveform was stored.
- 73 **VIEW B** — This pushbutton causes the B waveform to be displayed.
- 74 **SAVE A** — This pushbutton saves the A waveform and its readout. The readout stored with the waveform is displayed if both SAVE A and VIEW A are on and VIEW B and B-SAVE A are off; if either VIEW B or B-SAVE A is on, the

readout reflects the current spectrum analyzer settings. Turning SAVE A off cancels B-SAVE A, if it is on. If SAVE A is off and either VIEW A or VIEW B is on, both waveforms will be displayed. The A waveform is not updated by the sweep if SAVE A is on.

- 75 **B-SAVE A** — When activated, the spectrum analyzer displays the difference between the B waveform and the A waveform and automatically turns on SAVE A. The factory-set zero reference line is mid-screen, and positive differences are displayed above this line and negative differences below. Refer any change in the position of the zero reference line to authorized service personnel.
- 76 **MAX HOLD** — This pushbutton causes digital storage to retain the maximum signal amplitude at every storage location (500 locations; or 1000 locations if SAVE A is off). If SAVE A is on, the A

waveform is not affected. Use MAX HOLD to measure frequency drift or peak amplitude excursions of a signal.

- 77 **PEAK/AVERAGE** — This control selects the vertical position (shown on the screen by a horizontal line) at which digital storage switches from peak detection to signal averaging. Video signals above the cursor are peak detected; video signals below the cursor are digitally averaged.

Store/Recall

- 78 **<SHIFT> STORE display** — This pushbutton sequence starts a multiple-pushbutton sequence that stores either the A or B waveform and its associated readout and marker(s) in a numbered (0 through 8) memory register. Information is held in memory while instrument power is off. Messages displayed on the crt aid in completing the multiple-pushbutton sequence. After selecting **<SHIFT> STORE display**, a list of the center frequencies of stored displays is shown. The number of digits in a center frequency in the menu list is an indication of the span/div of that stored display (a larger number of digits indicates a narrower span). This display includes a prompt asking for the register number (0-8) into which the display will be stored. Select the register from the **DATA ENTRY** pushbuttons. Press **VIEW A** to select the A waveform or **VIEW B** to select the B waveform. Selection of the waveform completes the sequence and returns the instrument to normal operation. To exit the store display sequence at any point, press **SHIFT**.

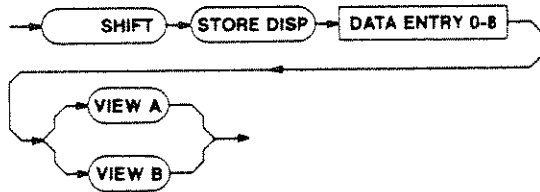

79

RECALL DISPLAY — This pushbutton sequence starts a multiple-pushbutton sequence that recalls a selected waveform, with its readout and marker(s) from one of the memory registers (0 through 8) and puts it in either the A or B display, for viewing. Information is held in memory while the instrument is off. After selecting **<SHIFT> RECALL DISPLAY**, a list of center frequencies of stored displays is shown. This display includes a prompt asking for the register number (0-8) from which the display will be recalled. Select the register from the **DATA ENTRY** pushbuttons. The readout for a recalled A waveform will only be displayed if **VIEW B** and **B-SAVE A** are off and **VIEW A** is on. The readout for a recalled B waveform will only be displayed if both **VIEW B** or **B-SAVE A** are on and **SINGLE SWEEP** is selected. The marker(s) will only be displayed if markers are turned on.

SAVE A is activated to allow the separate display of the A or B waveform. Remember to turn on **SINGLE SWEEP** before recalling a waveform to B to prevent overwrite by the sweep. The waveform cannot be recalled into B when in Manual or External Sweep.

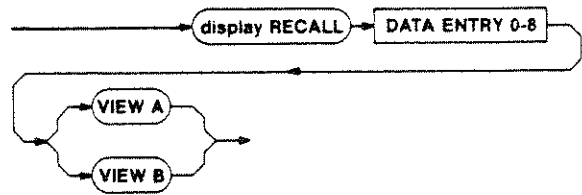

DISPLAY AND GENERAL PURPOSE

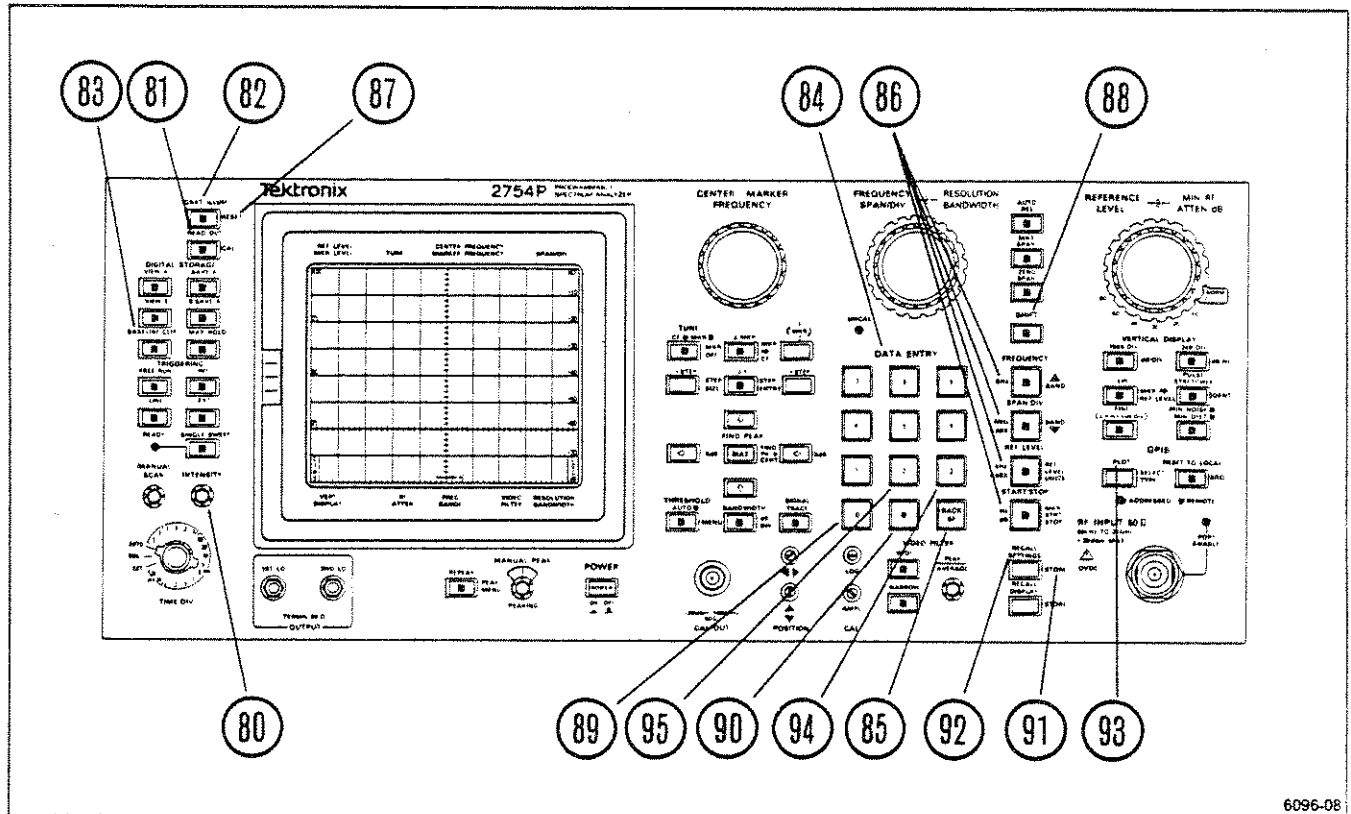

Figure 4-12

- 80 INTENSITY** — This control adjusts the brightness of the crt trace, readout, and text. Beam focus is automatically controlled.
- 81 READOUT** — This pushbutton turns crt readout on and off. The brightness is proportional to the trace brightness. This pushbutton does not affect prompt or help messages.
- 82 GRAT ILLUM** — This pushbutton switches the graticule lights from dim for low-light viewing to bright for photographing displays.
- 83 BASELINE CLIP** — This pushbutton clips, or blanks, about one graticule division of the spectrum trace at the baseline of the display. Use **BASELINE CLIP** to observe the readout at the bottom of the screen or to eliminate the bright baseline when photographing displays.
- 84 DATA ENTRY** — These pushbuttons are used to enter data directly from the front panel when directed by a message on the crt.
- Numbers** — The numbers 0 through 9 and a decimal point are available to enter data from the front panel.
- 85 BACKSPACE** — This pushbutton backs the cursor up one space each time it is pressed, erasing the number in that location. This allows you to enter correct numerical data before finishing the sequence with a units pushbutton.
- 86 Units** — The units GHz, MHz, kHz, Hz, +dBx, -dBx, and dB are available to complete a number-entry function from the front panel.

- 87 <SHIFT> RESET This pushbutton sequence resets all front-panel settings to their original condition as if power was just turned on.
- 88 <SHIFT> — This pushbutton allows selection of the blue-labeled front-panel pushbutton functions. Press <SHIFT> each time before selecting a blue-lettered function. <SHIFT> also stops multiple-pushbutton sequence operations.
- 89 <SHIFT> 0 (Diagnostic Aids; not identified on the front panel) — This pushbutton sequence displays a menu on the crt of all the available diagnostic aids for use while troubleshooting.

WARNING

MOST OF THIS INFORMATION IS FOR QUALIFIED SERVICE PERSONNEL ONLY. UNFAMILIARITY WITH SAFETY PROCEDURES CAN RESULT IN PERSONAL INJURY. PERFORM ONLY THE OPERATIONS THAT CAN BE COMPLETED FROM THE INSTRUMENT FRONT PANEL. DO NOT ATTEMPT TO REMOVE THE INSTRUMENT PANELS OR PERFORM ANY INTERNAL OPERATIONS; CONTACT QUALIFIED SERVICE PERSONNEL.

cally stored in register 0 when the spectrum analyzer is turned off, overwriting the settings previously stored there.

- 93 PLOT — This pushbutton causes display information to be sent to directly drive a plotter. The plotters that can be driven are a Tektronix 4662 Option 01, 4662 Option 31, or 4663 (emulating the 4662); a Hewlett Packard HP7470A, HP7475A, HP7580B, HP7585B, or HP7486B, or a Gould 6310 or 6320. The plotter type is selected by pressing the <SHIFT> SELECT TYPE pushbutton sequence. Refer to Plotting The Display in Section 6 for details. This pushbutton also causes the spectrum analyzer to update the GPIB address in 2754P instruments.

- 94 <SHIFT> 3 (Plot B-Save A Offset; not identified on the front panel) — The vertical position of the zero reference line for the B-SAVE A display is set with an internal switch selection. However, when using the PLOT function, the position of zero reference for the plot must be entered using this function. The range for the position is 0 to 225 with 125 representing center screen. Enter the position with the DATA ENTRY pushbuttons when prompted by the crt message, and terminate with the Hz pushbutton. The entered position is then stored in memory.



- 90 <SHIFT> . (Instrument Errors; not identified on the front panel) — This pushbutton sequence displays on the crt all the detected instrument errors; for use while troubleshooting.
- 91 <SHIFT> STORE settings — This pushbutton sequence allows a front-panel setup to be stored in memory. The crt displays a list of center frequencies of each setup as an aid in identifying the contents of each register. Select the desired register, and the setup is stored. The instrument settings are automatically stored in register 0 when the spectrum analyzer is turned off, overwriting the settings previously stored there.



- 95 <SHIFT> 2 (Select Plotter Type; not identified on the front panel) — This pushbutton sequence displays the list of the plotter types available for use with the PLOT pushbutton sequence. Select the desired plotter type by choosing one of the menu items and entering the number on the DATA ENTRY pushbuttons. The choices are 0=Tektronix 4662 Option 01 or the 4663 in a one-pen setup; 1=Tektronix 4662 Option 31 or the 4663 in a two-pen setup; 2=HP7470A or Gould 6310 or 6320; or 3=HP7475A, HP7580B, HP7585B, or HP7586B. Any plotter that is compatible with one of these can also be used. The selected plotter type is stored in memory.

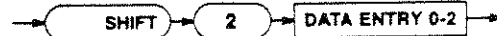

- 0 = (TEK 4662)
- 1 = (TEK 4662 OPT. 31)
- 2 = (HP 7470A)
- 3 = MCOLOR

- 92 RECALL SETTINGS — This pushbutton recalls an instrument front-panel setup from memory. The crt displays a list of the center frequencies of each stored setup as an aid in identifying the contents of each register. To return to these settings, press RECALL SETTINGS 0; however, the time and minimum RF attenuation settings stay at the knob values. Select the desired register number, and the front-panel controls automatically switch to that setup. The instrument settings are automati-

FRONT-PANEL INPUT/OUTPUT AND GPIB

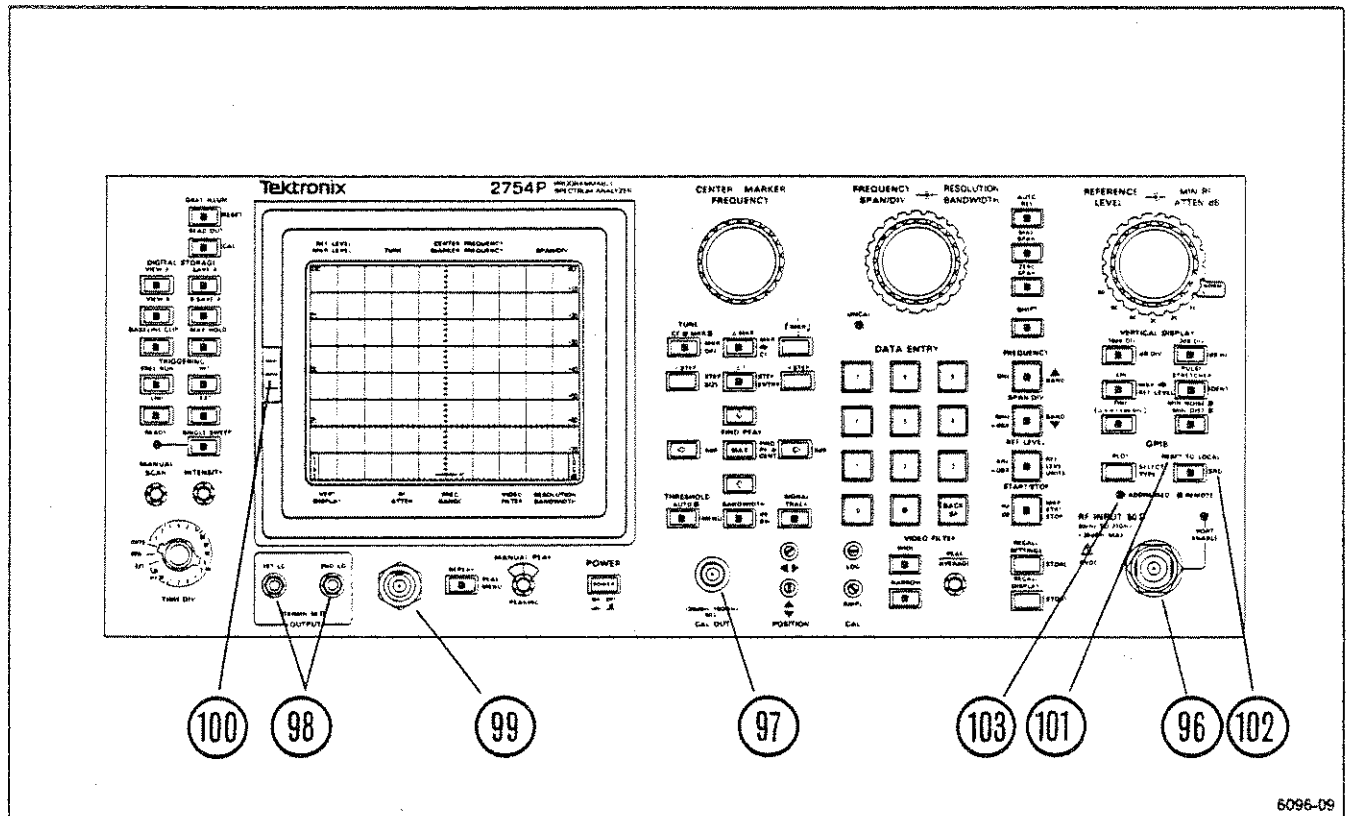

Figure 4-13

- 96 RF INPUT 50 Ω — This 50 Ω coaxial input connector is for RF signals to 21 GHz. If the input signal has a dc component, use a blocking capacitor in line with the signal.

CAUTION

The maximum, non-destructive input signal level to the input mixer is +13 dBm or 20 mW. Signals above -18 dBm may cause compression.

The maximum rating of the RF attenuator is +30 dBm (1 W average, 75 W peak pulse width 1 ms or less, with a duty cycle that does not exceed 0.001). Burn-out occurs above 1 W. If MIN NOISE is activated and the RF ATTEN is 60 dB, the +30 dBm rating will be exceeded if the signal level is increased to a full-screen display. Under

these conditions the input level will be +40 dBm. Reduce the level of high-powered signals with external attenuators. Input signals to the mixer must not contain any dc component. Refer to Signal Application in Section 6.

- 97 CAL OUT (Calibrator output) — This connector is the source of a calibrated -20 dBm ± 0.3 dB, 100 MHz signal and a comb of frequency markers 100 MHz apart. This 100 MHz source is the instrument reference frequency. In Option 07 instruments using the 50 Ω input, the signal is the same as the standard instrument, and using the 75 Ω input, the signal is +20 dBmV, ± 0.5 dB.

- 98 **OUTPUT (1ST LO/2ND LO)** — These connectors are the outputs of the respective local oscillators. The connectors must be terminated into 50 Ω when they are not connected to an external device.
- 99 **RF INPUT 75 Ω** (Option 07 instruments only) — This connector provides calibrated 75 Ω measurement capability.
- 100 **Camera Power** — This connector is the source of power for the Tektronix C-50 Series Cameras that have electrically-actuated shutters (either the C-5 or the C-59 is recommended). Single-sweep reset is not provided.
- 101 **RESET TO LOCAL/REMOTE** — This pushbutton is lit when the spectrum analyzer is in the remote state. While the instrument is remote, the other front-panel controls are not active. Indicators still reflect the current state of front-panel functions. This pushbutton is not lit when the spectrum analyzer is in the local state. While the spectrum analyzer is under local control, no GPIB messages are executed that would conflict with front-panel controls or change the waveforms in digital storage. See Programming Features in Section 6 for additional information.
- 102 **<SHIFT> SRQ** — This pushbutton sequence sends a service request over the GPIB bus to the controller.
- 103 **ADDRESSED** — This indicator lights when the spectrum analyzer is addressed to either talk or listen. The characters T, L, and/or S appear in the crt readout to indicate talk, listen, and/or SRQ, respectively.

REAR-PANEL INPUT/OUTPUT AND GPIB

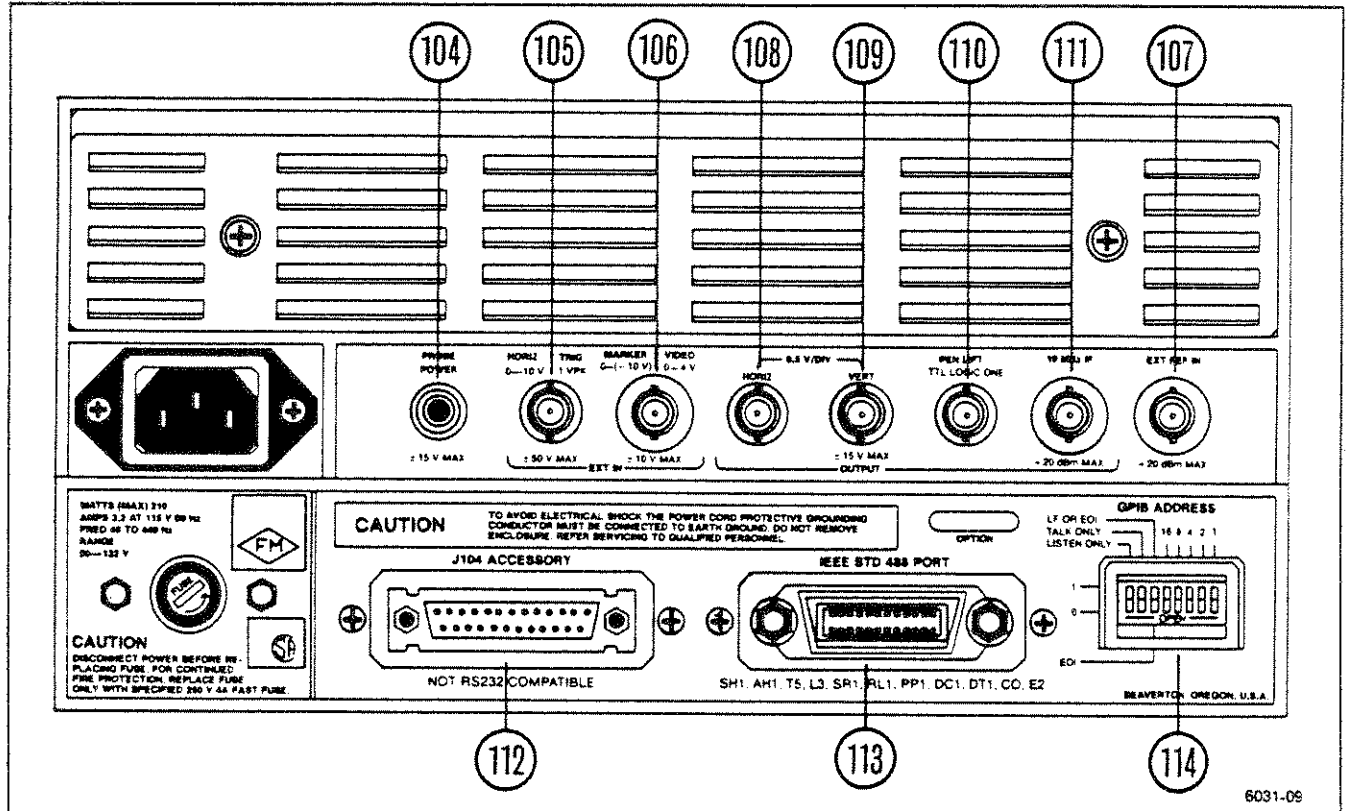

Figure 4-14

- 104 PROBE POWER** — This connector provides operating power for active probe systems. This connector should be used only with compatible probes or accessories specifically designed for use with this power source.
- 105 HORIZ/TRIG (EXT IN)** — Horizontal or triggering modes depend on the TRIGGERING and TIME/DIV selections. In the External Triggering mode, the connector is an ac coupled input for trigger signals. Trigger amplitudes from 1.0 V to 50 V peak, with a 0.1 ms minimum pulse width or within the frequency range of 15 Hz to 1 MHz, are required for triggering. When the TIME/DIV selection is EXT, the connector is a dc coupled input for horizontal sweep voltages. Deflection sensitivity is 1 V/div. A 0 to +10 voltage will deflect the beam across the screen from left to right.
- 106 MARKER/VIDEO (EXT IN)** — (Available on instruments without Option 42 only). This connector interfaces the spectrum analyzer with a Tektronix 1405 TV Adapter to display an externally-generated marker.
- 107 EXT REF IN** — A 50 Ω input for a 1, 2, 5, or 10 MHz external reference signal, within -15 dBm to +15 dBm level. Phase noise should be no greater than -110 dBc, in a 1 Hz bandwidth at 10 Hz offset, referenced to 10 MHz. Input signal must be a sine wave with a duty cycle symmetry of 35 to 65%. Input is ECL or TTL.
- 108 HORIZ (OUTPUT)** — This connector supplies a 0.5 V/div horizontal signal. Full range is -2.5 V to +2.5 V. Source impedance is approximately 1 kΩ.

109 VERT (OUTPUT) — This connector provides access to the video signal with 0.5 V for each division of displayed video that is above and below the center line. Source impedance is approximately 1 k Ω .

NOTE

Both HORIZ and VERT output signals are driven from digital storage if it is on. Both signals are driven from the analyzer sweep and video amplifier stage if digital storage is off.

110 PEN LIFT (OUTPUT) — This connector provides access to a TTL compatible signal to lift the pen of a chart recorder during spectrum analyzer sweep retrace. This signal is always derived from the spectrum analyzer sweep, regardless of the selection of the digital storage.

In Option 42 instruments, use this connector to input external video signals if pin 1 of the ACCESSORIES connector is grounded (refer any questions about this connection to qualified service personnel).

111 10 MHz IF (OUTPUT) — This connector provides access to the output of the 10 MHz IF. The output level is approximately -16 dBm for a full-screen signal at -30 dBm reference level.

112 J104 ACCESSORY — This connector provides bi-directional access to the instrument bus. It is not RS 232 compatible. A TTL 0 applied to pin 1 selects External Video. Video signals, which are applied to rear-panel MARKER/VIDEO, are connected to the video path ahead of the video filters. Pins 2 and 3 provide the output and return lines to drive an external preselector (used only in instruments with Option 01 installed).

113 IEEE STD 488 PORT (GPIB) — This connector interfaces the spectrum analyzer to the GPIB bus. The interface functions provided are SH1, AH1, T5, L3, SR1, RL1, PP1, DC1, DT1, and C0. In non-programmable instruments this connector may be used as a plotter output.

114 GPIB ADDRESS — These switches set the value of the lower five bits of the instrument GPIB address; this value is the instrument's primary address. These switches also select the Talk Only and Listen Only operating modes, and the message terminator for input and output. Address 31 (11111) logically disconnects the spectrum analyzer from the bus. Address 0 (00000) is reserved for Tektronix 4050-Series controllers. If these switches are changed after the instrument is already active, press RESET TO LOCAL or PLOT to cause the spectrum analyzer to re-read them.

Details of how the switches are used in remote control are in the Programmers Manual.

INSTRUMENT CHECK OUT

This section includes the basic instrument check-out procedures and first-time preparation for use. An instrument operational check is included for the front-panel pushbuttons and controls and some of the operating functions. No extra equipment is required to perform these check-out procedures, and the instrument covers do not need to be removed. Refer any additional instrument check out to qualified service personnel.

FIRMWARE VERSION AND ERROR MESSAGE READOUT

Firmware Version

When the spectrum analyzer is first turned on, the front-panel processor firmware versions will be displayed on screen for approximately two seconds, and all the front-panel LEDs will light up.

Error Message Readout

If the instrument detects an internal hardware failure, a failure report comes on screen and remains for approximately 2 seconds. A status message then appears and remains for as long as the failure exists. Press <SHIFT> . to bring error messages to the screen that explain the impact of the failure on instrument operation.

If the oscillator frequency cannot be set due to a hardware failure, it will continue to try each sweep, and the sweep holdoff time will increase with each try. To disable attempted oscillator corrections, press <SHIFT> 7; however, center frequency accuracy specifications will not be met in this mode. Press <SHIFT> 7 again to re-enable oscillator correction routines. Another failure message will appear if the failure has not been corrected.

There are other error messages to report a calibration failure, power supply failure, and battery-operated RAM checksum error. Promptly report any error messages to qualified service personnel.

PREPARATION FOR USE

The following procedure creates a display and calibrates center frequency readout, display reference level, and bandwidth. Whenever the SHIFT pushbutton is required in this procedure to precede a multiple-pushbutton sequence, it is enclosed in arrows; i.e. <SHIFT> .

1. Initial Turn On

a. Connect the spectrum analyzer power cord to an appropriate power source (see Power Source And Power Requirements in Section 3 of this manual) and push the POWER switch ON.

When POWER is switched ON (power-up), the processor runs a memory and I/O test. If no processor system problems are found, the power-up program will complete in approximately 10 seconds, and the instrument will be ready to operate. The crt readout is functioning properly if it is as shown in Figure 5-1. If a problem does exist within the instrument, a message will appear on the screen. To bypass the failed test and attempt to use the instrument, press the pushbutton as directed in the error message. However, performance may not be as specified.

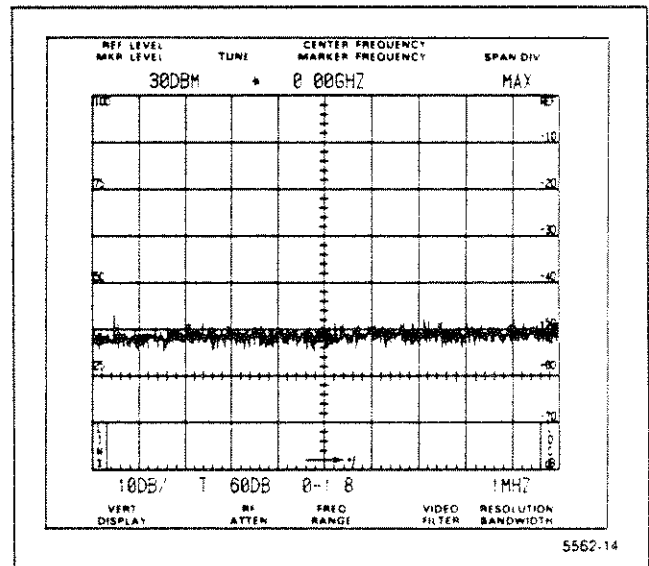

Figure 5-1. Crt display and readout at initial turn on.

The spectrum analyzer operating functions and modes will initialize to the following power-up states.

REF LEVEL	30 DBM
CENTER FREQUENCY	900 MHZ
MARKER FREQUENCY	0 MHZ
SPAN/DIV	MAXimum
VERT DISPLAY	10 DB/
RF ATTENUATION	60 DB
FREQ RANGE	0-4.2
(FREQ RANGE OPTION 01	0-1.8)
RESOLUTION BANDWIDTH	1 MHZ
TRIGGERING	FREE RUN
AUTO RES	On
DIGITAL STORAGE	VIEW A/VIEW B On
All other pushbuttons	Inactive or Off

b. Set the MIN RF ATTEN dB control to 0 (NORM) and the PEAK/AVERAGE control fully counterclockwise. Set the TIME/DIV control to AUTO, and the REF LEVEL to read -20 DBM. Adjust the INTENSITY control for the desired brightness. Note that the RF ATTEN readout is now 10 DB.

c. Connect a 50 Ω coaxial cable between the CAL OUT connector and RF INPUT to apply the CAL OUT signal to the RF INPUT connector.

d. A dot marker will appear in the upper portion of the screen in the MAX frequency mode. This marker indicates the location on the display to which the spectrum analyzer frequency is tuned. With a frequency readout of 0.00 GHz, the marker will be in the upper left portion of the screen. Rotate the CENTER/MARKER FREQUENCY control and watch the dot marker move across the display. Notice that the CENTER FREQUENCY readout (top line) remains at 900 MHz GHz, and that the MARKER FREQUENCY readout (second line) changes according to the position of the marker (dot).

e. A comb of 100 MHz markers will be displayed, as shown in Figure 5-2. To select 100 MHz center frequency, press the pushbutton sequence of FREQUENCY 1 0 0 MHz.

f. To change the FREQ SPAN/DIV readout to 100 MHz, press the pushbutton sequence of SPAN/DIV 1 0 0 MHz. The dot marker is now horizontally centered, and the 100 MHz calibrator signal is at center screen.

2. Calibrate Position, Center Frequency, Reference Level, and Bandwidth

NOTE

When the <SHIFT> CAL sequence is pressed, the spectrum analyzer performs a center frequency, bandwidth, and reference level calibration. Prompts appear on the

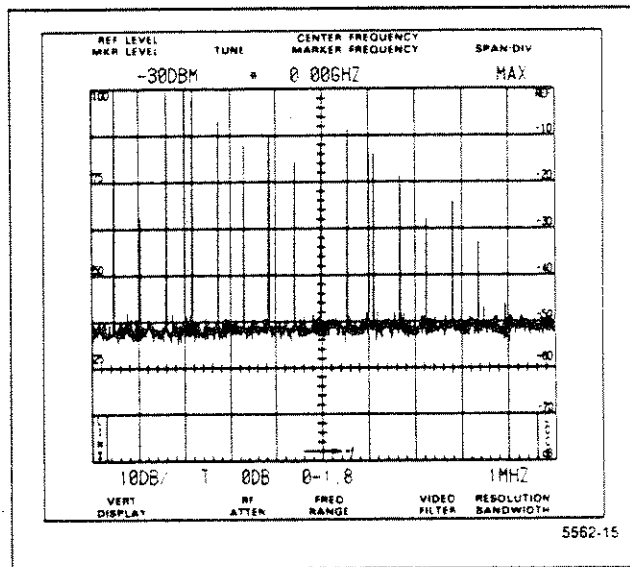

Figure 5-2. Typical display of calibration markers in the maximum span position.

screen to guide you step-by-step through the procedure. This calibration should be done at regular intervals. It must be done before the instrument will meet its center frequency and reference level accuracy performance specifications. It should also be done any time the instrument ambient temperature is substantially different from the last calibration. An explanation of reference level accuracy with respect to ambient temperature is described in the Specification section of this manual.

To see the results after the spectrum analyzer has completed a calibration routine, press the <SHIFT> 1 sequence. A message will appear on the screen that shows the correction factors used by the spectrum analyzer to center the resolution bandwidth filters to produce a calibrated center frequency. It also shows the correction that was required to bring the amplitude level within 0.4 dB of the 1 MHz filter.

Press the <SHIFT> CAL sequence to start the calibration routine. Prompt messages on the screen will guide you through setting the four front-panel adjustments of vertical and horizontal POSITION, and AMPL and LOG CAL. This sets the absolute reference level for the 1 MHz resolution bandwidth filter. An automatic calibration is then done, which measures and corrects for absolute frequency and amplitude (relative to 1 MHz) errors of the filters. This takes approximately 60

seconds. If a message appears on the screen, refer to Error Message Readout earlier in this section. The correction factors are held in memory. Press FINE to continue calibration as instructed or either SHIFT pushbutton to exit the routine.

FUNCTIONAL OR OPERATIONAL CHECK

This procedure uses minimum test equipment to check instrument operating modes, functions, and basic performance. The internal calibrator and attenuator are used as the source to check most of the operational characteristics. Since both are very accurate, this check should satisfy most incoming inspection or pre-operational check-out requirements. This check will also help familiarize you with the instrument operation. A detailed Performance Check that verifies all performance requirements in the Specification section is included in the Service Manual, Volume 1.

Equipment Required

The only external equipment used is an N-male-to-bnc-female adapter and the 50 Ω coaxial cable, which are supplied as standard accessories.

Preliminary Preparation

Perform the procedure described under Preparation for Use, then allow the instrument to warm up for at least 15 minutes before proceeding with this check.

1. Check Operation of Front-Panel Pushbuttons and Controls

This procedure checks the operation of all front-panel pushbuttons and controls and ensures that the buttons illuminate when the function is active.

Pushbuttons indicating a mode light when the function is active. Pushbuttons that have an immediate, one-time effect on the crt display, such as +STEP, are not illuminated.

Connect the CAL OUT signal to the RF INPUT with the 50 Ω cable and bnc-to-N adapter. Tune the 100 MHz, -20 dBm signal to center screen. Reduce the SPAN/DIV readout to 20 kHz, and change the VERTICAL DISPLAY to 2 dB/DIV. Press or change the following pushbuttons and controls and note their affect on the operation.

INTENSITY — Rotate the control through its range and note the crt beam brightness change.

GRAT ILLUM — When activated, the graticule is illuminated.

<SHIFT> MENU — Press this pushbutton to display a menu of available commands that are not assigned to a front-panel pushbutton.

TRIGGERING — To activate the triggering mode, press one of four pushbuttons. The pushbutton illuminates when in the active state. Press any one of the pushbuttons to cancel or deactivate any other mode. Turn VIEW A and VIEW B off to better observe the triggering effect.

FREE RUN — In the active state, the trace free runs.

INT — When active, the sweep is triggered when an AC signal or noise level at the left edge is ≥ 2.0 division.

(a) Change SPAN/DIV to 100 kHz, RESOLUTION BANDWIDTH to 100 kHz, CENTER FREQUENCY to 100.00 MHz, REFERENCE LEVEL to -10 DBM, VERT DISPLAY to 10 DB/DIV, and VIEW A and VIEW B off.

(b) Activate INT TRIGGERING and check that a display is present.

(c) Set the VERTICAL DISPLAY to 2 dB/DIV, and check that the display is no longer present.

LINE — When active, the trace is triggered at power line frequency. Switch to LINE and the sweep will be triggered.

EXT — When this function is active, the trace runs only when an external signal ≥ 1.0 V peak is applied to the back-panel EXT IN connector. Since external test equipment is required to check this function, a check cannot be made with this procedure.

SINGLE SWEEP — When this function is active, single sweep aborts the current sweep. Press the pushbutton again to arm the sweep generator and light the READY indicator. When triggering conditions are met after the circuit is armed, the analyzer makes only one sweep. The indicator will remain lit until the sweep has run. The single sweep mode is cancelled when any TRIGGERING pushbutton is pressed. The effect of SINGLE SWEEP is more apparent with VIEW A and VIEW B off.

(a) Press FREE RUN TRIGGERING, and set TIME/DIV to 0.5 s.

(b) Press SINGLE SWEEP to abort the sweep.

(c) Press SINGLE SWEEP again, and the READY indicator lights and the sweep runs.

(d) Press FREE RUN to cancel single sweep; return TIME/DIV to AUTO.

TIME/DIV — This control selects sweep rate, manual scan, and external sweep operation. In the MNL position, the MANUAL SCAN control should move the crt beam across the horizontal axis of the crt graticule. In the EXT position, a voltage of 0 to +10 V, applied to the rear-panel HORIZ/TRIG connector, should deflect the crt beam across the full 10 division screen.

VERTICAL DISPLAY — Display modes are activated by three pushbuttons. Press any of these pushbuttons to cancel any other mode. Turn VIEW A and VIEW B on.

10 dB/DIV — When this pushbutton is activated, the display is a calibrated 10 dB/division with an 80 dB dynamic range.

(a) With a REF LEVEL readout of -20 dBm, activate 10 dB/DIV. Set the SPAN/DIV to 20 kHz and tune the calibrator signal to center screen.

(b) Change REF LEVEL, and the display steps in 1 division increments, representing 10 dB/division. Return the REF LEVEL readout to -20 dBm.

2 dB/DIV — When this pushbutton is pressed, the display is a calibrated 2 dB/division with 16 dB of dynamic range.

(a) Activate 2 dB/DIV, and change the REF LEVEL readout to -6 dBm. The display now steps 1.0 division for each two steps of the REFERENCE LEVEL control.

(b) Return the REF LEVEL readout to -20 dBm.

LIN — When this pushbutton is pressed, the display is linear between the reference level (top of the graticule) and zero volts (bottom of the graticule), and the crt VERTICAL DISPLAY reads out in volts/division.

Activate LIN, and the VERT DISPLAY readout changes to MV/.

PULSE STRETCHER — When this pushbutton is pressed, the fall-time of video signals increases so narrow video pulses will show on the display.

(a) Increase the SPAN/DIV readout to 100 MHz, change the VERTICAL DISPLAY to 10 dB/DIV, increase TIME/DIV to 1 ms, and switch VIEW A and VIEW B both off.

(b) The trailing edge of the markers appear brighter due to the increased fall time.

(c) Turn the PULSE STRETCHER off, return TIME/DIV to AUTO, and turn both VIEW A and VIEW B on.

VIDEO FILTER — Two filters can be independently selected to provide WIDE or NARROW (approximately 1/30th or 1/300th of the resolution bandwidth) filtering to reduce noise.

(a) Change the SPAN/DIV readout to 500 kHz, and tune the calibrator signal to center screen.

(b) Alternately activate WIDE and NARROW Video Filters. The noise in each filter is reduced as the filter is switched in (see Figure 5-3). The NARROW filter will have a more pronounced effect on noise reduction. Note the change in sweep rate when the TIME/DIV selector is in the AUTO position, when the Digital Storage is off.

(c) Turn both Video Filters off.

DIGITAL STORAGE — Select either one or both of the A and B waveforms from digital storage. The amplitude of a signal should remain constant when digital storage is turned on (VIEW A or VIEW B activated). The PEAK/AVERAGE control positions a cursor over the vertical window of the screen, with noise and signal level averaged below the cursor and peak-detected above the cursor.

VIEW A — When this pushbutton is pressed, the A waveform from digital storage is displayed. With SAVE A off, the A waveform is updated each sweep as the beam travels from left to right. With SAVE A on, the waveform is not updated.

VIEW B — When this pushbutton is pressed, the B waveform is displayed. When both VIEW A and VIEW B are active, the A and B waveforms are interlaced and displayed. Both waveforms are updated each sweep. Update of the A waveform depends on the state of SAVE A.

SAVE A — When SAVE A is activated, the A waveform with its readout is saved. In this mode, the data for the A waveform is not updated each sweep. Turn VIEW B off, and change the setting of the REFERENCE LEVEL control. The A display will not change. The readout for the saved waveform will be displayed any time SAVE A is on and VIEW B and B-SAVE A are off. If either VIEW B or B-SAVE A is on, the readout reflects the current analyzer setup.

MAX HOLD — When this pushbutton is pressed, the maximum signal amplitude at each memory location is stored. The waveform is updated only when signal data is greater than that previously stored. To verify operation, change the settings of the

reference level can be changed by qualified service personnel. Positive differences between the two displays appear above this line and negative differences below the line.

PEAK/AVERAGE — When digital storage is on, this control positions a horizontal line, or cursor, anywhere within the graticule window. Signals above the cursor are peak detected, signals below the cursor are averaged by the digital storage. To verify operation, move the cursor within the noise level; the noise amplitude will change as the cursor is positioned.

<SHIFT> IDENTify — When the identify function is activated, every other sweep with its waveform is vertically displaced from the other. The frequencies of the 1st and 2nd local oscillators are moved so that true signals are not displaced horizontally on alternate sweeps while spurious signals are shifted significantly, or off screen. The FREQUENCY SPAN/DIV setting must be 50 kHz or less before the processor will activate the Identify mode. Refer to Using the Signal Identifier under General Operating Information, in Section 6 of this manual.

(a) With the 500 MHz calibrator harmonic tuned to center frequency, decrease the FREQUENCY SPAN/DIV setting to 50 kHz or less and press **<SHIFT> IDENT**.

(b) There will be no horizontal displacement of the 500 MHz signal on alternate sweeps. To help determine if the signal is true or spurious (see Figure 5-4), decrease the sweep rate or push **SAVE A** with both **VIEW A** and **VIEW B** on, so a comparison can be made.

(c) Turn **IDENT** off.

AUTO RES — When this pushbutton is pressed and FREQUENCY SPAN/DIV and TIME/DIV settings are changed, resolution bandwidth is automatically selected by the processor to maintain a calibrated display. To check operation, change FREQUENCY SPAN/DIV or TIME/DIV settings; the RESOLUTION BANDWIDTH will change.

MAX SPAN — When activated, the span switches to maximum and the analyzer sweeps the full band. When deactivated, the Span/Div returns to its previous setting.

ZERO SPAN — When activated, the span shifts to zero for a time-domain display. When deactivated, the span returns to its previous setting.

FREQUENCY SPAN/DIV — As this control is rotated, the Span/Div changes between 0 and Max, and the display indicates the change. The range of selections depends on the frequency band (see specifications in Section 2).

RESOLUTION BANDWIDTH — As this control is rotated from a full counterclockwise position, the resolution bandwidth changes in decade steps from 1 kHz to 1 MHz.

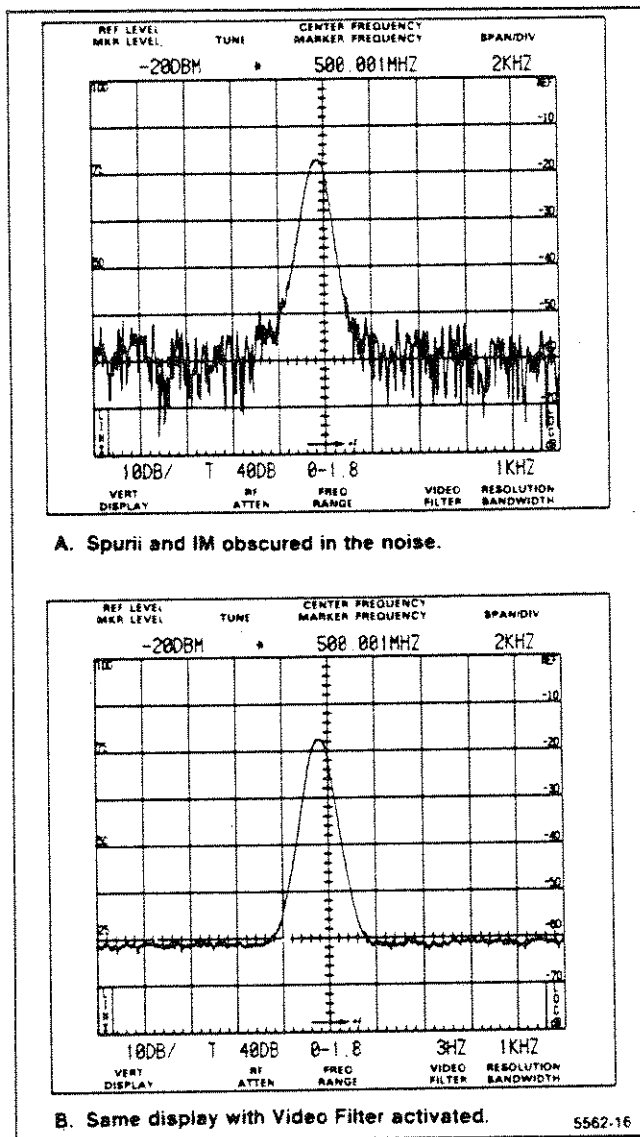

Figure 5-3. Integrating a display with the VIDEO FILTER.

CENTER/MARKER FREQUENCY or **REFERENCE LEVEL** controls; the maximum level at each location will be retained.

B-SAVE A — Press this pushbutton to display the arithmetic difference between an updated **B** waveform and a **SAVE A** waveform. The **SAVE A** function is automatically activated when **B-SAVE A** is pressed.

Press **B-SAVE A**, and change the **REFERENCE LEVEL** setting so the difference between the **B** and **SAVE A** waveform is displayed with **VIEW A** and **VIEW B** off. The reference (zero difference) level is factory set at graticule center. The position of this

REFERENCE LEVEL — With 10 dB/DIV VERTICAL DISPLAY active and FINE off, the REF LEVEL readout steps in 10 dB increments as the control is rotated. When FINE is activated, the steps are 1 dB. In the 2 dB/DIV mode, the steps are 1 dB with FINE off and 0.25 dB with FINE active. When the Vertical Display factor is 4 dB/div or less with FINE on, the analyzer switches to the delta A mode. In the delta A mode, the REF LEVEL readout goes to 0.00 dB, then steps in 0.25 dB increments as the REFERENCE LEVEL control is rotated.

(a) Set the MIN RF ATTEN dB control to 0 dB and VERTICAL DISPLAY to 10 dB/DIV. Rotate the REFERENCE LEVEL control counterclockwise to 30 dBm, then clockwise to -110 dBm.

(b) The REF LEVEL readout changes in 10 dB increments.

(c) Press FINE, and change the setting of the REFERENCE LEVEL control. The REF LEVEL readout now steps in 1 dB increments.

(d) Press <SHIFT> dB/DIV and 4 dB with the DATA ENTRY pushbuttons, and the REF LEVEL readout goes to 0.00 dB. Rotate the REFERENCE LEVEL control. The REF LEVEL now steps in 0.25 dB increments from the 0.00 dB reference.

(e) Return the REF LEVEL readout to -20 dBm, and 10 dB of RF ATTENUATION is switched in. This prevents signal compression of any signal with an amplitude within the graticule area.

MIN RF ATTEN dB — This control sets the minimum amount of RF attenuation in the signal path, regardless of the REFERENCE LEVEL control setting. To check operation, set the MIN RF ATTEN dB selector to 20 and change the REFERENCE LEVEL control settings. The RF ATTENUATION readout will not go below 20 dB.

FINE — When activated, the REFERENCE LEVEL control steps decrease to the Fine mode. (Refer to the REFERENCE LEVEL check earlier in this section).

MIN NOISE/MIN DISTORTION — This pushbutton selects one of two methods that select RF attenuator and IF gain. MIN NOISE (button illuminated) reduces the noise level by reducing attenuation 10 dB and decreasing IF gain 10 dB. MIN DISTORTION reduces IM distortion due to input mixer overload. The normal mode of operation is with minimum distortion. To observe any change, the amount of RF ATTENUATION displayed by the crt readout must be 10 dB higher than the MIN RF ATTEN dB selector setting at a reference level > -20 dBm.

(a) Set the FREQUENCY readout to 100 MHz, FREQ SPAN/DIV to 500 kHz, REF LEVEL readout to -20 dBm and MIN RF ATTEN dB to 0 dB. The RF ATTENUATION readout will indicate 10 dB.

(b) Activate MIN NOISE. The noise floor will drop approximately 10 dB, and the RF ATTENUATION readout will change to 0 dB.

(c) Deactivate MIN NOISE.

UNCAL — This indicator lights when the display is uncalibrated.

(a) Set the TIME/DIV control to 50 ms, deactivate AUTO RES, and set RESOLUTION BANDWIDTH to 10 kHz.

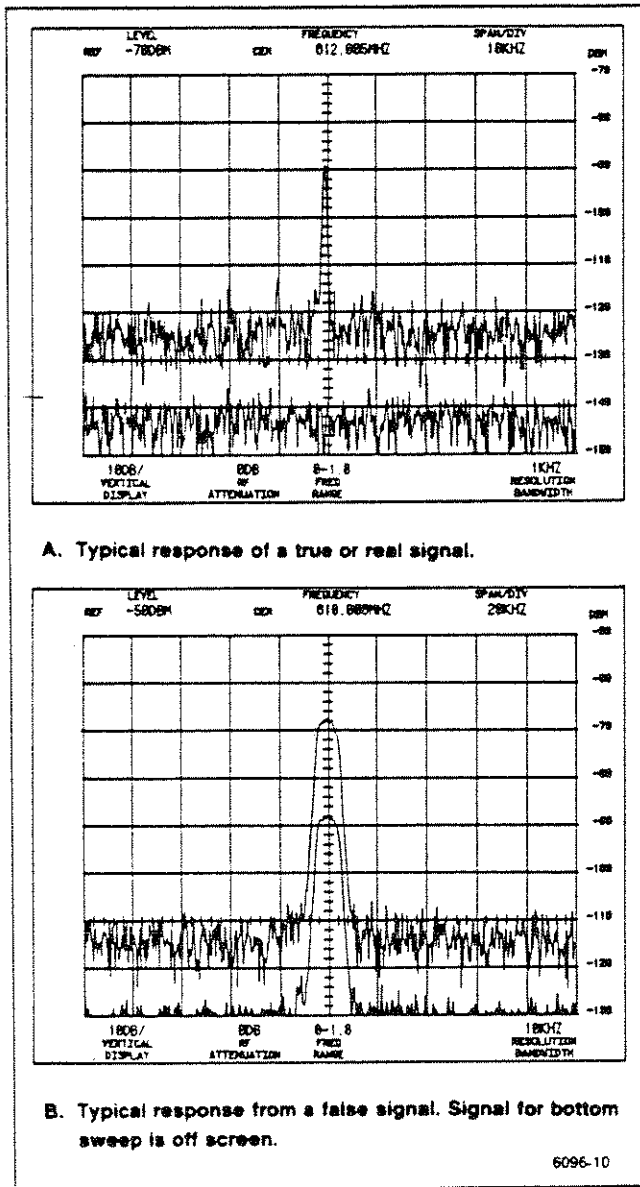

Figure 5-4. Using the IDENT feature to identify a real or true response.

(b) The UNCAL indicator should light and remain lit until the SPAN/DIV readout is reduced to 200 kHz or the RESOLUTION BANDWIDTH is increased to 1 MHz.

(c) Return TIME/DIV control to AUTO, press AUTO RES, and set the FREQUENCY SPAN/DIV control to 100 MHz.

SHIFT — This pushbutton shifts multiple-function pushbuttons to their alternate function. The names of most of these alternate functions are printed in blue lettering next to the pushbutton. The shift mode deactivates after the function has been performed.

RECALL SETTINGS/STORE — When this pushbutton is pressed, the processor lists the settings, with their center frequency, that are stored in memory (registers 0–9). The 0 register holds the power-down settings so they can be recalled after power-up. Press <SHIFT> STORE to store the existing front-panel setup in one of the available registers.

(a) Press <SHIFT> STORE, and select register number 1 with the DATA ENTRY pushbuttons to store the current front-panel setup.

(b) Change front-panel pushbutton and control settings.

(c) Press RECALL SETTINGS, then DATA ENTRY 1 to recall the setup.

(d) The instrument front-panel set-up returns to that previously entered, with the exception of the Time/Div and RF Attenuation setting.

Δ F — When the delta F function is activated, FREQUENCY readout initializes to 0.0 kHz to 0 MHz. The frequency difference, to a desired signal or point on the display, can be determined by tuning that point to center screen and noting the readout. Check by measuring the difference between calibrator harmonics. If the delta frequency is tuned below 0, the readout will include a minus sign.

TUNE CF/MARKER — When this pushbutton is lit, a Marker appears as a bright spot on the screen and the CENTER/MARKER FREQUENCY control tunes the Marker; the FREQUENCY readout remains constant. An asterisk (*) between the FREQUENCY and REF LEVEL readout indicates that the CENTER/MARKER FREQUENCY control is tuning the Marker Frequency.

+STEP/-STEP — When these pushbuttons are pressed, the marker or center frequency is increased or decreased by steps. Perform the following steps while in the Tune CF mode.

(a) Reduce the SPAN/DIV readout to 50 MHz, set the FREQUENCY readout to 100 MHz with the DATA ENTRY pushbuttons. Press <SHIFT> STEP ENTRY; enter 25 MHz with the DATA ENTRY pushbuttons. Press +STEP, the FREQUENCY readout will increase to 125 MHz. Press +STEP again, and the FREQUENCY

readout will increase to 150 MHz.

(b) Push the -STEP pushbutton. The FREQUENCY readout will decrease to 125 MHz, and push -STEP again to return the FREQUENCY readout to 100 MHz.

REPEAK/PEAK MENU — This dual-function pushbutton selects Repeak or when <SHIFT> is pushed, PEAK MENU.

If the spectrum analyzer is operating in the preselector bands (1.7–21 GHz), the preselector initiates a peaking routine on any signal within the center two divisions of the screen. In Option 01 instruments, the peak code consists of numbers at 500 MHz intervals. The algorithm will peak the preselector tuning for this center frequency setting, then store this peak setting in battery-operated memory. If a signal is not on screen, the algorithm will revert to the code that was previously stored in memory; or, if there is no setting, to the mid point of the peaking range. After a setting for a band has been stored, you can switch between preselector bands with the assurance that the preselector is peaked well enough to track the oscillator and provide reasonable sensitivity.

Press <SHIFT> PEAK MENU to select one of four peaking options: KNOB, for manual operation using the MANUAL PEAK control, STORED VALUE, INPUT, for input via DATA ENTRY pushbuttons, and REPEAK.

(a) With the calibrator signal applied to the RF INPUT, select a FREQUENCY of 2.0 GHz by pressing FREQUENCY 2.0 GHz with the DATA ENTRY pushbuttons. Select a REF LEVEL readout of -40 dBm SPAN/DIV readout of 10 kHz, and a RESOLUTION BANDWIDTH of 1 kHz.

(b) Peak the 2 GHz signal with the MANUAL PEAK control by pressing <SHIFT> PEAK MENU, and select item 0. Adjust the signal for maximum amplitude with the MANUAL PEAK control. Press <SHIFT> PEAK MENU, and select item 3. The message PEAKING will appear on screen. Press the REPEAK button and observe the instrument running the peaking routine once more.

(c) When either method is complete, the signal amplitude should equal or exceed that obtained with manual peaking.

RESET TO LOCAL — The RESET TO LOCAL pushbutton is lighted when the spectrum analyzer is under control of the GPIB controller. While under remote control, the other front-panel controls are not active, but indicators will still reflect the current state of all front-panel functions, except Time/Div, Peak/Average and RF Attenuation.

This pushbutton is not lighted when the spectrum analyzer is under local operator control. While under local control, the spectrum analyzer does not execute GPIB messages that would conflict with front-panel controls or change the waveforms in digital storage.

When the pushbutton is pressed, local control is restored to the operator unless the controller prevents this with the local lockout message. Programmable functions do not change when switching from remote to local control, except as necessary to match the settings of front-panel controls for TIME/DIV, MIN RF ATTN dB, PEAKING, and PEAK/AVERAGE.

The internal microcomputer flashes the instrument and front-panel firmware version numbers and the GPIB address on the crt when the pushbutton is pressed. The microcomputer also updates the GPIB primary address if the GPIB ADDRESS switches have been changed.

For another function of this pushbutton when in the talk-only mode, refer to Talk-Only/Listen-Only Operation in Section 6 of this manual.

GPIB Function Readout — A single character appears in the lower crt readout when the spectrum analyzer is talking (T), listening (L), or requesting service (S). Two characters will appear in this location if the spectrum analyzer is talking or listening and also requesting service, or is in the talk/listen mode.

SHIFT Functions — Press SHIFT to change the pushbuttons that have more than one function. Some functions require a parameter or command to be entered that includes numerical data. This data is entered with the DATA ENTRY pushbuttons.

RECALL DISPLAY — Press RECALL DISPLAY, the register number from the displayed menu, and the part of digital storage (A or B) where you want to have the recalled waveform placed.

If A is selected, SAVE A is automatically activated to prevent an overwrite. VIEW A must be on to observe the recalled waveform and VIEW B must be off to see the readout that applies to the recalled waveform. If VIEW B and VIEW A are on, both the recalled waveform in A and the current waveform in B will be displayed. Readout will apply to the current B waveform.

If B is selected, the next sweep will overwrite the display unless SINGLE SWEEP was activated before selecting B; a message will appear on the screen as a reminder of this. VIEW B must be on to observe the recalled waveform and its readout. Remember to deactivate SINGLE SWEEP when leaving this recalled mode.

<SHIFT> STORE — Press <SHIFT> STORE, and the register number from the displayed menu. When SAVE A is on, also select waveform A or B to be stored.

(a) Establish a display on the screen. Press <SHIFT> STORE display, the memory register number (0-8) to place the display, and the display (A or B) you wish stored.

(b) Change the characteristics of the current display with either REFERENCE LEVEL or FREQUENCY SPAN/DIV control.

(c) Press RECALL DISPLAY, the register number where the display was stored (note the center frequency listing of the stored displays in each register), then VIEW A so the recalled waveform is placed in the A part of digital storage.

(d) If VIEW A is on and VIEW B off, the recalled display with its readout will now become the A display. SAVE A will activate to prevent overwrite. If VIEW A and VIEW B are on, both the recalled display and the current B display will be on screen. Since the most current display is the B waveform, the readout will show the parameters for the B display. Switch VIEW B off to see the readout applicable to the recalled A waveform.

(e) Recall a stored display into the B section by repeating the process in step d. Before starting the process, press SINGLE SWEEP so the recalled waveform will not be overwritten by the next sweep; a message will appear when you select the B section to remind you of this.) Remember to deactivate SINGLE SWEEP when returning to normal operation.

NOTE

If an attempt is made to recall a display from an empty location, error message NVRAM CHECKSUM ERROR will be issued.

MKR OFF — Press <SHIFT> MKR OFF to turn off the markers.

MKR — CF — Press <SHIFT> MKR — CF to bring a marker signal to center screen.

(a) Set the REF LEVEL readout to -20 dBm, FREQUENCY readout to 100 MHz. Set FREQ SPAN/DIV to 200 kHz, and VERTICAL DISPLAY to 10 dB/DIV; set RESOLUTION BANDWIDTH to 100 kHz.

(b) Tune the signal off center, activate TUNE MKR. Tune the Marker to the top of the signal and press <SHIFT> MKR — CF. The signal should move to center screen. Push <SHIFT> MKR OFF.

BAND ▲/BAND ▼ — These <SHIFTed> pushbuttons shift the frequency range up or down from the current band. Press one and then the other and the frequency bands will change accordingly. If the frequency is selected from the DATA ENTRY pushbuttons, the spectrum analyzer automatically selects the appropriate frequency range.

READOUT — Press READOUT to turn off the crt readout of the markers, REF LEVEL, FREQUENCY, SPAN/DIV, VERTICAL DISPLAY, RF ATTENUATION, FREQ RANGE, RESOLUTION BANDWIDTH, and VIDEO FILTERS. Press <SHIFT> READOUT to reactivate the readout on the display.

START STOP — Activating START STOP allows you to enter a start and stop frequency within the selected band with the DATA ENTRY pushbuttons.

(a) Enter a start frequency of FREQUENCY 90 MHz with the DATA ENTRY pushbuttons. Enter stop frequency 210 MHz.

(b) The signals at the 1st and 9th graticule line should be 100 MHz apart. Set the VERTICAL DISPLAY to 10 dB/DIV, and observe that the SPAN/DIV readout is 12 MHz.

STEP ENTRY — Activate <SHIFT> STEP ENTRY to increase the frequency setting a desired amount. Perform the following steps while in the Tune Marker mode.

Press <SHIFT> STEP ENTRY and enter a step frequency of 10 MHz. Activate +STEP and note that the CENTER FREQUENCY readout is 160 MHz. Push -STEP to return the FREQUENCY setting to 150 MHz.

BASELINE CLIP — Press <SHIFT> BASELINE CLIP to clip (blank) the baseline of the display up to about one graticule division.

RESET — Press <SHIFT> RESET to return the instrument to the original power-up state.

REF LEVEL UNITS — Disconnect the calibrator signal from the RF INPUT, and change the REF LEVEL readout to 0 dBm. Press <SHIFT> REF LEVEL UNITS. Select item 1, and note the REF LEVEL readout change to -13dBV. Select item 2, and note the REF LEVEL readout change to 47 dBmV. Select item 3, and note the REF LEVEL readout change to 107 dB μ V. Press 0 to return the readout to 0 dBm. Reconnect the calibrator signal to the RF INPUT.

Markers — The markers provide direct readout of frequency and amplitude information of any point along any displayed trace or relative (delta frequency) and amplitude information between any two points along any displayed trace or traces (in delta only). In the delta mode, only the difference in frequency and amplitude will be displayed. Two independent marker frequencies and amplitudes cannot be displayed at the same time.

With the FREQUENCY readout at 100 MHz, a REF LEVEL readout of -10 dBm, and a SPAN/DIV of 5 MHz, press TUNE CF/MARKER. A bright dot, the marker, appears on screen, as well as a second line of readout with an asterisk between the REF LEVEL and FREQUENCY readout. Turn the CENTER/MARKER FREQUENCY knob, and note that the marker tunes.

Press TUNE CF/MARKER again, the indicator button will not be lit but the marker remains on screen. When the CENTER/MARKER FREQUENCY knob is rotated now, the marker does not move, but both the Center Frequency and the Marker Frequency change. Also, the asterisk has now moved to the first readout line to indicate that the center frequency is being tuned.

Return the FREQUENCY readout to 100 MHz, and press TUNE CF/MARKER to activate the marker.

FIND PEAK MAX — Press FIND PEAK MAX to move the marker to the top of the signal.

Δ MKR, 1-MKR-2, MKR START STOP, MKR — REF LEVEL — Press Δ MKR to activate a second marker at the position of the single marker on the trace. Parentheses will be added to the second line readout.

(a) Rotate the CENTER/MARKER FREQUENCY control; two markers will be on screen. Set the delta marker readout to 5 MHz.

(b) Press 1-MKR-2. The left marker is now brighter as an indication that it is being tuned. Tune the marker until the readout shows -10 MHz, which is the difference in frequency between the two markers (the delta marker frequency).

(c) Press <SHIFT> MKR START STOP. The markers now appear at the left and right edge of the screen. The waveform will be "zoomed in".

(d) Press Δ MKR again, there will be just a single marker now, and the parentheses around the second line of readout will disappear.

(e) Press FIND PEAK MAX, then <SHIFT> MKR-CENTER. The signal is now at center screen.

(f) Press <SHIFT> MKR-REF LEVEL, the signal and the marker will now be at the top of the screen.

(g) Reduce the FREQ SPAN/DIV readout to 500 kHz, and set the RESOLUTION BANDWIDTH to 1 MHz.

(h) Press <SHIFT> dB BW, and enter 10 with the DATA ENTRY pushbuttons. Observe that the Delta MKRs have moved down 10 dB from the top of the signal. Delta frequency is a little over 1 MHz wide. Press <SHIFT> dB BW again.

(i) Press <SHIFT> MKR OFF, and using the DATA ENTRY pushbuttons, set the FREQUENCY readout to 200 MHz and the FREQ SPAN/DIV readout to 25 MHz. Set the Peak/Average cursor to the bottom of the screen. Press TUNE CF/MKR.

(j) Press FIND PEAK MAX. The marker will now be positioned on the 100 MHz calibrator signal (the left-most tall signal of the three signals

on screen).

(k) Press FIND PEAK \uparrow . The marker will move to the 300 MHz calibrator harmonic. Press the FIND PEAK \uparrow pushbutton one more time; the marker will move to the 200 MHz calibrator harmonic. Press FIND PEAK \downarrow twice to return the marker to the original 100 MHz signal. Press TUNE CF/MKR to turn the marker off.

SIGNAL TRACK — Press the SIGNAL TRACK to keep a drifting signal on screen.

(a) Set the REF LEVEL readout to -20 dBm, the FREQUENCY readout to 100.000 MHz, the SPAN/DIV readout to 5 kHz. Push the VERTICAL DISPLAY 10 dB/DIV pushbutton, and the RESOLUTION BANDWIDTH to 1 kHz. The signal should be on screen.

(b) Press the SIGNAL TRACK. The TUNE MKR lights and the signal will be moved back to center screen. Signal Track will be indicated in the marker readout on the crt.

(c) To deactivate the function, press SIGNAL TRACK again.

2. Check Gain Variation Between Resolution Bandwidths

(less than 0.4 dB with respect to the 1 MHz filter and less than 0.8 dB between any two filters)

a. Calibrate the Center/Marker Frequency, Reference Level, and Bandwidth as described earlier in this section.

b. Set the FREQUENCY readout to 100 MHz by pressing FREQUENCY 1 0 0 MHz with the DATA ENTRY pushbuttons. Set the FREQUENCY SPAN/DIV control to 1 MHz, the RESOLUTION BANDWIDTH to 1 MHz, the REFERENCE LEVEL control to -20dBm, TIME/DIV to AUTO, and activate AUTO RESolution.

c. Apply 100 MHz markers from the CAL OUT connector to the RF INPUT. Set the Vertical Display factor to 1 dB/DIV by pressing <SHIFT> dB/DIV 1 dB, and set the RESOLUTION BANDWIDTH readout to 1 MHz.

d. Verify that the amplitude of the 100 MHz signal is at the top graticule line. If not, repeat the front-panel calibration procedure by pressing <SHIFT> CAL.

e. Change the REF LEVEL readout to -19 dBm, RESOLUTION to 1 MHz and activate SAVE A. This is the reference for checking the other filters.

f. Change the RESOLUTION BANDWIDTH and FREQUENCY SPAN/DIV controls to 100 kHz.

g. Check the amplitude of the 100 MHz signal. It should be within 0.4 dB of the 1 MHz reference established in part e.

h. Set the RESOLUTION BANDWIDTH control to each of the remaining positions and the FREQ SPAN/DIV readout for a readable display. The amplitude accuracy and frequency can now be checked with respect to the 1 MHz reference and between any two filters. Reference level error should not exceed 0.4 dB from the reference and 0.8 dB between any filter.

i. Turn SAVE A off.

3. Check Span Accuracy and Linearity

Span accuracy is the displacement error of calibrator markers from the center reference over ± 4 major divisions of span. Linearity accuracy is determined by the displacement of calibrator frequency markers from their specified positions over the center eight divisions of the display area, using the 1st graticule line as the reference.

a. Set the FREQUENCY readout to 500 MHz, the FREQUENCY SPAN/DIV control to 100 MHz, the REF LEVEL readout to -20 dBm, and activate AUTO RESolution. Change the VERTICAL DISPLAY to 10 dB/DIV.

b. Span is accurate when the 100 MHz markers are within 5% of their reference graticule line over the center eight divisions. (It may be easier to observe the markers with DIGITAL STORAGE off.)

c. Tune CENTER/MARKER FREQUENCY to align one of the markers at the 1st graticule line from the left edge.

d. Linearity is accurate when the displacement of successive markers, over the center eight divisions, does not exceed 5% of 100 MHz (the FREQ SPAN/DIV setting) or 0.2 division.

4. Check Resolution Bandwidth and Shape Factor

(bandwidth is within 20% of the selected 1 MHz to 1 kHz range shape factor is 7.5:1 or less)

a. With the Calibrator output applied to the RF INPUT and the FREQUENCY readout at 100 MHz, set the REFERENCE LEVEL control to -20 dBm, the FREQ SPAN/DIV control to 500 kHz, RESOLUTION BANDWIDTH to 1 MHz, TIME/DIV at AUTO, VERTICAL DISPLAY to 2 dB/DIV, and activate MIN NOISE.

b. Measure the 6 dB down bandwidth (see Figure 5-5A). Bandwidth should equal 1 MHz, ± 200 kHz.

c. Change VERTICAL DISPLAY to 10 dB/DIV, and measure the 60 dB down bandwidth (see Figure 5-5B).

d. Calculate the shape factor as the ratio of -60 dB/-6 dB bandwidths (see Figure 5-5). Shape factor should equal 7.5:1 or less.

e. Change the RESOLUTION BANDWIDTH setting to 100 kHz and the FREQ SPAN/DIV to 100 kHz.

f. Check the resolution bandwidth and shape factor of the 100 kHz filter by repeating the above process.

g. Repeat the process to check the resolution bandwidth and shape factor for the 10 kHz, and 1 kHz filters. Shape factor should equal 7.5:1 for all.

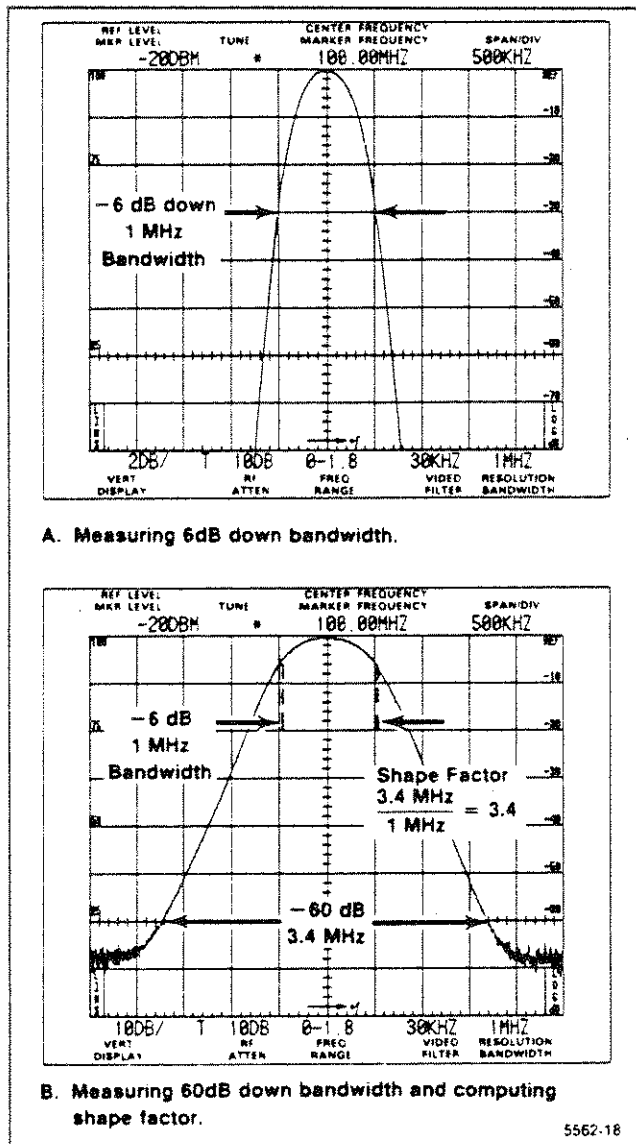

Figure 5-5. Displays that illustrate how bandwidth and shape factor are determined.

5. Check Reference Level Gain and RF Attenuator Steps

a. With the Calibrator signal applied to the RF INPUT and the FREQUENCY readout set to 100 MHz, set the FREQ SPAN/DIV and RESOLUTION BANDWIDTH controls to 100 kHz. Set VERTICAL DISPLAY to 10 dB/DIV, REF LEVEL readout to -20 dBm, and activate MIN

NOISE and NARROW VIDEO FILTER.

b. To check the attenuator, increase REF LEVEL readout to +40 dBm; the signal peak will decrease 1 major division per 10 dB step of the RF ATTENUATION.

c. Set FREQUENCY readout to 200 MHz and the REFERENCE LEVEL control to -20 dBm.

d. Increase the MIN RF ATTEN dB to 60 dB; the noise level will increase 1 division for each 10 dB step.

e. To check IF gain steps, switch REFERENCE LEVEL control between -20 dBm and +40 dBm. The noise level will decrease 1 division per step.

f. Activate FINE; then, check that the trace rises 1 dB/step of the reference level as it is changed to +30 dBm.

g. Switch FINE off, and reduce MIN RF ATTEN setting to 0.

h. Switch MIN NOISE off; the noise floor will rise about 1 division as the RF ATTENUATION increases 10 dB. REF LEVEL readout should not change.

i. Change REF LEVEL to -60 dBm, and switch VERTICAL DISPLAY to 2 dB/DIV. Adjust REF LEVEL so the signal level is near the top graticule line.

j. Change the REFERENCE LEVEL control; the signal amplitude will change in 1 dB increments (0.5 div).

k. Set VERTICAL DISPLAY readout to 1 dB/DIV with the <SHIFT> dB/DIV 1 dB with the DATA ENTRY push-buttons.

l. Change the REFERENCE LEVEL control positions; the REF LEVEL readout will change in 1 dB steps, and the display in 1 division steps.

m. Activate FINE (Delta A mode). The REF LEVEL now reads 0.00 dB, which denotes the Delta A mode.

n. Change the REFERENCE LEVEL control positions; the REF LEVEL readout will change in + or - 0.25 dB increments.

o. Deactivate FINE. Change the VERTICAL DISPLAY to 10 dB/DIV and the REF LEVEL readout to -20 dBm.

6. Check Sensitivity (refer to Table 5-1)

NOTE

Sensitivity is specified according to the input mixer average noise level. The calibrator signal is the reference used to calibrate the display.

Table 5-1
SENSITIVITY (OPTION 01 INSTRUMENT)

Equivalent Input Noise (dBm) versus Resolution Bandwidth					
Band	Frequency	1 MHz	100 kHz	10 kHz	1 kHz
Band 1	50 kHz–1.8 GHz	–80	–90	–100	–110
Band 2	1.7–5.5 GHz	–80	–90	–100	–110
Band 3	3.0–7.1 GHz	–79	–89	–99	–109
Band 4	5.4–12.0 GHz	–65	–75	–85	–95
Band 5	15.0–21.0 GHz	–55	–64	–75	–85

a. Remove the calibrator signal from the RF INPUT. Set VERTICAL DISPLAY to 10 dB/DIV, REF LEVEL readout to –30 dBm, FREQ SPAN/DIV readout to 5 MHz, the RESOLUTION BANDWIDTH control to 1 MHz, the TIME/DIV control at 1 second. Adjust the PEAK/AVERAGE cursor so it is off the top of the screen, and activate the WIDE VIDEO FILTER.

b. The noise floor (level) should be at least –80 dBm (as indicated in Table 5-1) or five divisions down from the REF LEVEL readout of –30 dBm.

c. Change the REFERENCE LEVEL control to –40 dBm, the FREQUENCY SPAN/DIV control to 1 MHz, and the RESOLUTION BANDWIDTH control to 100 kHz.

d. The noise floor should be at least –90 dBm (refer to Table 5-1).

e. Change the REFERENCE LEVEL control to –60 dBm, the FREQUENCY SPAN/DIV to 10 kHz, the TIME/DIV control to AUTO and the RESOLUTION BANDWIDTH control to 1 kHz.

f. Check that the average noise level for the 1 kHz resolution bandwidth is as listed in Table 5-1.

7. Check Residual FM

(within 7 kHz over 20 ms, with FREQ SPAN/DIV readout greater than 200 kHz, and within 12 Hz, over 20 ms, with FREQ SPAN/DIV readout of 200 kHz or less)

a. With the calibrator signal applied to the RF INPUT, set the FREQUENCY readout to 100 MHz, the FREQ SPAN/DIV readout to 1 MHz, the RESOLUTION BANDWIDTH control to 100 kHz, VERTICAL DISPLAY to 2 dB/DIV, and the REFERENCE LEVEL readout to –23 dBm.

b. Press <SHIFT> 7. A message will appear on the screen to indicate that the 1st LO synthesis and phase lock are disabled. This is normal. It is now possible to switch the FREQUENCY SPAN/DIV control to narrower spans with the 1st LO phase lock disabled.

c. Decrease the FREQUENCY SPAN/DIV and RESOLUTION BANDWIDTH settings to 10 kHz. Keep the 100 MHz calibrator signal centered on the screen with the CENTER/MARKER FREQUENCY control.

d. Switch the VERTICAL DISPLAY to LIN. Position the signal so the slope (horizontal versus vertical excursion) of the response can be determined (see Figure 5-6A). It may help to determine slope by using SINGLE SWEEP and SAVE A to freeze the display at a convenient point on the graticule for measurement.

e. If SINGLE SWEEP and SAVE A where used in part d, deactivate SAVE A and SINGLE SWEEP. Push ZERO SPAN, set the TIME/DIV setting to 20 ms, and adjust the CENTER/MARKER FREQUENCY control to position the display near center screen as shown in Figure 5-6B. Use SINGLE SWEEP and SAVE A to freeze the display for ease in measuring the FM (frequency modulation). The peak-to-peak amplitude of the display per any horizontal division, scaled to the vertical deflections according to the slope estimated in part d, is the residual FM. Residual FM must not exceed 7 kHz for 20 ms (1 division).

f. Press <SHIFT> 7 to re-enable the phase lock, and set the FREQUENCY readout to 100 MHz. Switch the TIME/DIV setting to AUTO, and reduce the FREQUENCY SPAN/DIV to 200 Hz and RESOLUTION BANDWIDTH settings to 1 kHz.

g. Adjust the CENTER/MARKER FREQUENCY control to position the signal so its slope can be determined. It will be easier if you use SINGLE SWEEP and SAVE A to freeze the display at a convenient position on the graticule.

h. Deactivate SAVE A and SINGLE SWEEP, and switch the TIME/DIV control to 20 ms. Activate ZERO SPAN, and position the display near center screen so the vertical excursions per horizontal division (20 ms) can be measured. Residual FM must not exceed 12 Hz.

8. Check Frequency Drift or Stability

(50 Hz or less per minute of sweep time, when the FREQ SPAN/DIV is 200 kHz or less, after 1 hour of warmup, and within a stable ambient temperature)

a. With the Calibrator signal applied to the RF INPUT, set the FREQUENCY readout to 100 MHz, the TIME/DIV control to AUTO, the FREQUENCY SPAN/DIV control to 200 Hz, the RESOLUTION BANDWIDTH control to 1 kHz, VERTICAL DISPLAY to 2 dB/DIV, and the REFERENCE LEVEL control to –23 dBm. Switch VIEW A and VIEW B on.

e. Check that the frequency drift rate in Hz/minute = $300 \times \Delta f / (250 + \Delta f)$. Drift rate must not exceed 50 Hz/minute.

9. GPIB Verification Program

The Service Manual, Volume 1, contains a GPIB verification program. If you wish to check the operation of the GPIB interface, request the program from service personnel.

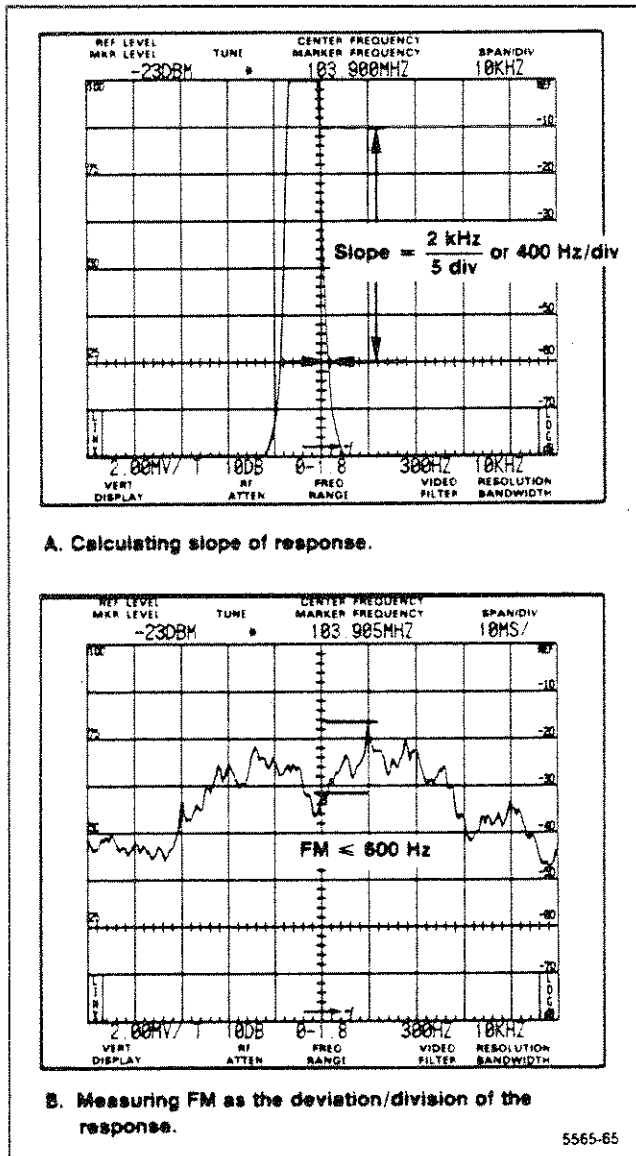

Figure 5-6. Typical display showing how to determine residual FM.

b. Adjust the CENTER/MARKER FREQUENCY control so one side of the signal intersects the sixth division graticule line from the left edge. Press SINGLE SWEEP, and activate SAVE A to save the display.

c. Select the NARROW VIDEO FILTER, and press SINGLE SWEEP again to start the sweep. The sweep will now run at a 10 s/div rate.

d. Note the frequency difference between the two displays at the sixth graticule line. Label this difference delta f.

OPERATION

This section describes the normal operating features of the spectrum analyzer. Many instrument features and operating modes are described, and examples are included to show some typical applications.

INSTRUMENT OPERATING FEATURES

Firmware Version and Error Message Readout

Refer to Section 5 for information.

Crt Light Filters

Two light filters, amber and grey, are supplied as standard accessories to the spectrum analyzer. Select the filter that best suits the surrounding light conditions, light reflections, and your viewing needs. To install the filter, pull the top of the plastic mask out and place the filter behind it. Remove the light filter when taking display photographs.

Intensity Level and Beam Alignment

Operate the instrument with the intensity level no higher than that required to clearly see the display. Trace alignment and beam focus are internal adjustments that must be performed by qualified service personnel.

The required intensity level for some displays may be high enough to produce a bright and flared baseline. This bright baseline can be eliminated (clipped) with the BASELINE CLIP pushbutton. BASELINE CLIP is useful when photographing displays, and it also allows the lower readout characters to be more easily viewed. When the markers are turned on, set the intensity below the level where dot "blooming" or defocusing occurs.

Signal Application

Signal frequencies to 21 GHz can be applied through a short, high-quality, 50 Ω coaxial cable to the RF INPUT connector. These signals pass through an internal RF attenuator to the 1st mixer. When Option 01 is installed, the instrument automatically selects either a low-pass filter or tuned preselector (depending on frequency range) between the RF attenuator and the 1st mixer.

RF INPUT Connector

The nominal input impedance of the coaxial RF INPUT is 50 Ω , and 75 Ω on the optional 75 Ω INPUT (Option 07). Because cable losses can be significant at microwave frequencies, it is important to keep the cables as short as possible. Impedance mismatch between the signal source and the RF INPUT will produce reflections that degrade flatness, frequency response, and sensitivity and may increase spurious responses. Impedance mismatch can be caused by poor connections, incorrect signal source impedance, and long or low-quality coaxial cable. When optimum flatness or frequency response is desired and signal strength is adequate, set the MIN RF ATTEN dB control to 10 dB or more. The addition of the attenuator helps minimize reflections to improve the input characteristics.

CAUTION

The front end of the spectrum analyzer is specified at +30 dBm maximum. It is possible to set the reference level to +40 dBm with MIN NOISE activated. If the signal level is increased for a full-screen display, the input level will exceed the power rating of the attenuator. Do not apply any dc potential to the RF INPUT. Use a dc block if a signal is riding on any dc potential. For dc block ordering information, see the Optional Accessories in the Service Manual, Volume 2, or contact your local Tektronix Field Office or representative.

Spurious responses can be minimized if the signal amplitude is kept within the graticule window. A recommended procedure is to select a reference level setting that limits stronger signals to the graticule window.

High-level signals can cause compression; if excessive (above +30 dBm or +20 dBm when MIN NOISE is on), the 1st mixer may be destroyed. Signals above +30 dBm must be reduced by external attenuators. Ensure that the frequency range of any external attenuator is adequate.

Line impedance stabilizing networks, used for conducting EMI/RF measurements, will often have several volts of 60 Hz signal at the output. To protect the input mixer, use a dc block (refer to the Service Manual, Volume 2, or your local Tektronix Field Office or representative for ordering information). It is important to be sure that all equipment being tested has power applied through the line stabilizing networks before any

RF signal is connected to the spectrum analyzer input.

If your instrument has Option 01 installed, refer to the Option 01 information in Section 7 of this manual for additional information.

Connecting to a 75 Ω Source — Signals from a 75 Ω source, at the lower frequencies (1 MHz to 1 GHz), can be applied directly to the 75 Ω INPUT if Option 07 is installed or to the RF INPUT by using a 75 Ω-to-50 Ω minimum loss attenuator (refer to the Tektronix catalog or your local field office or representative for ordering information).

Sensitivity and power levels are often rated in dBm (dB with reference to 1 mW regardless of impedance). Sensitivity and power levels for 75 Ω systems are usually rated in dBmV (dB with reference to 1 mV across 75 Ω). A circuit diagram of a suitable matching pad for this purpose is shown in Figure 6-1. Figure 6-2 shows the relationship between 50 Ω and 75 Ω units with matching attenuators included. The conversion to alternate reference level units is listed below for 75 Ω and is shown in Table 6-1 for 50 Ω.

1. dBmV (75 Ω) = dBm (50 Ω) + 54.47 dB:
e.g. -60 dBm (50 Ω) + 54.47 dB = -5.5 dBmV (75 Ω).
2. dBm (75 Ω) = dBm (50 Ω) + 5.72 dB:
e.g. -60 dBm (50 Ω) + 5.72 dB = -54.3 dBm (75 Ω).

Table 6-1
50 Ω SYSTEM REFERENCE LEVEL
CONVERSION

To	dBm	dBmV	dBμV
From			
dBm	0	+47	+107
dBmV	-47	0	-60
dBμV	-107	+60	0

Amplitude Conversion — A conversion chart, as shown in Figure 6-3, can be used to convert input signal levels of voltage or power to dBm, dBV, dBmV, and dB.

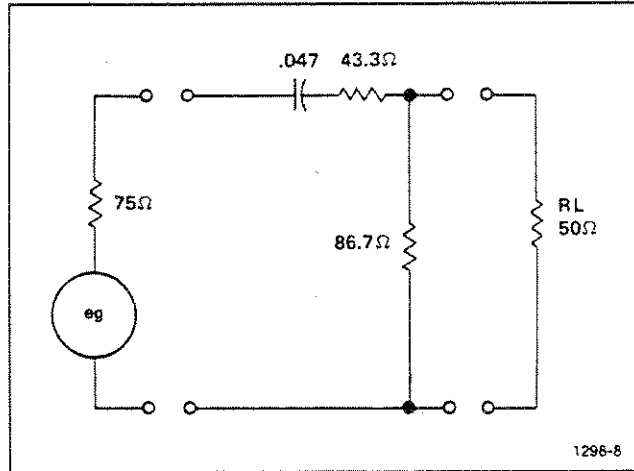

Figure 6-1. Circuit of a 75 to 50 Ω matching pad (ac coupled).

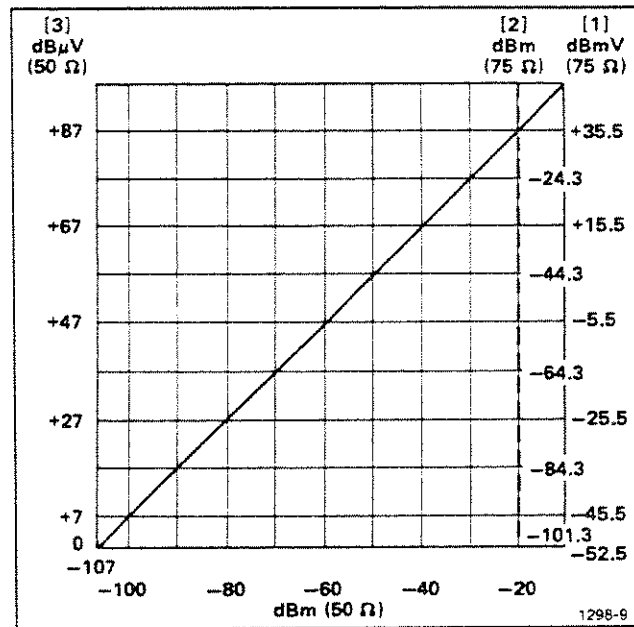

Figure 6-2. Graph illustrating the relationship between dBm, dBmV, and dBμV (matching attenuator included where necessary).

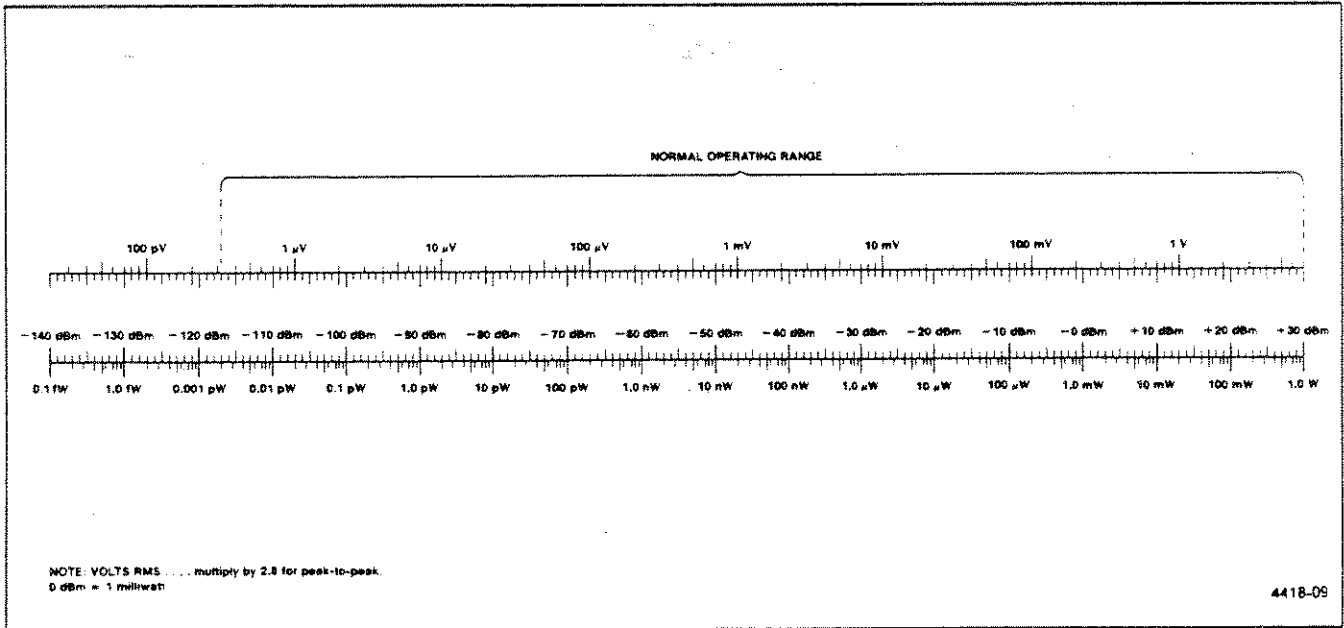

Figure 6-3. Volts-dBm-Watts conversion chart for 50 Ω Impedance.

Resolution Bandwidth, Frequency Span, and Sweep Time

Resolution is the ability of the spectrum analyzer to display discrete frequency components within a frequency span. This ability is a function of the instrument bandwidth, sweep time, frequency span, and incidental FM. Frequency span and sweep time are normally selected so the resolution bandwidth for a particular continuous wave (cw) signal is minimum. Bandwidth also has an effect on the noise level. As the bandwidth decreases, the signal-to-noise ratio, or sensitivity, increases so maximum sensitivity is attained with the narrow resolution bandwidths.

As the spectrum analyzer sweep rate is increased, a critical rate is reached where both sensitivity and resolution are degraded. Therefore, sweep time for a calibrated display is dependent on the resolution bandwidth and frequency span.

In MAX SPAN, the display represents the full frequency range of the selected band. The frequency readout on the crt is indicated on the display by a frequency dot if markers are off or by the primary marker if markers are turned on. This frequency point will shift to center screen when the FREQ SPAN/DIV is reduced to some setting other than MAX. The frequency span/division setting depends on the particular measurement application. Wide spans are usually used to monitor a frequency spectrum for spurious signals, or check harmonic content. When wide spans are used for non-digital store displays, the sweep rate is usually set for minimum flicker, which requires wider resolution bandwidths to

maintain a calibrated display. Narrow spans are used to analyze the characteristics about or near a particular signal, such as modulation side bands, bandwidth, or power line related distortion. Slow sweep rates are required when using narrow spans and high resolution to observe signal phenomena.

The spectrum analyzer will select the sweep rate and resolution bandwidth so the display remains calibrated for the selected frequency span/division, if TIME/DIV is in the AUTO position and AUTO RES is on. AUTO RES optimizes bandwidth for the selected FREQ SPAN/DIV and TIME/DIV settings unless either is outside the range of calibration. When this occurs, UNCAL lights and a > symbol prefixes the REF LEVEL readout on the crt display.

To analyze pulsed signals, a wider bandwidth than that provided by the automatic feature is usually required. Set RESOLUTION BANDWIDTH to approximately 1/10 the side lobe frequency width or the reciprocal of the pulse width, if known, in order to ensure adequate bandwidth. The resolution bandwidth is usually set for optimum main lobe detail after the sweep rate has been selected.

Using the MANUAL PEAK Control or Automatic Peaking

The MANUAL PEAK control sets the preselector tracking for Option 01 over the 1.7 to 21 GHz range (Bands 2—5). In operation the control is adjusted for maximum signal amplitude.

If automatic peaking is activated from measurements, a peaking routine runs once that uses any signal within the center two divisions of the screen, or one division each side of the marker. The peak code consists of numbers about the signal at 500 MHz intervals when using the preselector in Option 01 instruments. This routine sets the preselector tracking for maximum signal response. When the response is peaked, the setting is stored in memory for use when switching between bands or returning to the peaked band. If no signal is present during the peaking routine, the previous peak setting is recalled from memory. If no setting is stored in memory, peaking is set to mid-range. During automatic peaking, the settings for each band are recalled as you switch between frequency ranges or bands.

It is always good practice to re-adjust peaking before making amplitude or power measurements, especially if the measurement is to be made after a significant change in center frequency.

Using the Signal Identifier

In non-option 01 instruments, there is no preselection ahead of the mixer, so many spurious responses are generated in the 1st mixer (see Figure 6-4). This is due to multiple harmonics of the local oscillator and incoming signals converting to intermediate frequencies that are within the band-pass of the 1st IF. These responses pass through the IF band-pass and appear as signals on screen.

The spectrum analyzer features a Signal Identify mode to help identify true signals from false signals. When in this mode, the frequency of the local oscillators are shifted on alternate sweeps. At the same time, the sweeps are vertically displaced about two divisions. True signals shift only a small amount on alternate sweeps, while false signals or spurious responses will shift at least 1 division, especially in the millimeter wave bands where the N factor is large.

This mode can only be activated when the FREQ SPAN/DIV is 50 kHz or less.

Using the Video Filters

The video filters restrict the video bandwidth so noise is reduced (see Figure 6-4). When signals are closely spaced, the filter can reduce the modulation between two signals to make it easier to analyze the display. The filters can also be used to average the envelope of pulsed RF spectra that has a relatively high pulse repetition frequency (prf); however, because the filter is basically an integrating circuit, the video filter will not be very effective when measuring low prf spectra.

The WIDE filter reduces the bandwidth to approximately 1/30th the selected resolution bandwidth; the NARROW filter to approximately 1/300th. Using the filter may require a reduction in the sweep rate to maintain a calibrated display. UNCAL lights if the sweep rate is not compatible with the other parameters to maintain a calibrated display. When either the WIDE or NARROW filter is selected, the filter bandwidth is displayed on the crt lower readout line.

Triggering the Display

The Triggering mode is usually FREE RUN for spectrum displays. However, it may be desirable or necessary to trigger the display when the event is time related to some source, or when the frequency span has been reduced to zero for time domain analysis. In FREE RUN, the sweep will not synchronize with any input signal.

In addition to FREE RUN, the sweep can be internally triggered (INT) by the video signal, at the line frequency rate of the power supply (LINE), or by an external signal (EXT) applied to the HORIZTRIG EXT IN connector on the rear panel. The required amplitude for triggering is 2.0 divisions or more for internal triggering and from 1.0 to 50 V maximum (dc + peak ac) for external triggering.

In addition to the Triggering source selections, SINGLE SWEEP is provided. In SINGLE SWEEP, the sweep will run once after the circuit has been armed and a trigger signal arrives. READY lights when the circuit is armed and waiting to be triggered and remains lit during sweep time. Push SINGLE SWEEP once to activate the Single Sweep mode and cancel the current sweep. Push SINGLE SWEEP again to arm the trigger circuit so it is ready for a trigger signal. This mode is useful for viewing single events.

Sweeping the Display

Horizontal sweep voltage for the display can be internal or from an external source. Sweep rate and source are selected with the TIME/DIV control. When the TIME/DIV control is in the AUTO position, the sweep rate is automatically set to maintain a calibrated display.

When TIME/DIV is in the EXT position, a signal source of 0 to +10 V, applied to the HORIZTRIG EXT IN connector will sweep the crt beam across the 10 division span. The input is dc coupled and sensitivity is 1 V/div. External input impedance is approximately 10 kΩ.

The beam can be manually positioned by the MANUAL SCAN control when TIME/DIV is in the MNL position (see Manual Scan of the Spectrum that follows).

Manual Scan of the Spectrum

The MANUAL SCAN control is usually used to examine a particular point or sector of a display. One example is looking at one of the null points of a frequency modulation spectrum. Another example is when it takes unnecessarily long to look at a small segment of the full span because of the slow sweep rate. With a wide span/div and/or a narrow resolution bandwidth, it is very possible to manually scan too fast to achieve an accurate display. Best results are obtained without digital storage; digital storage can produce unpredictable results due to the sweep rate, and the digital storage display is only updated when scanning from left to right.

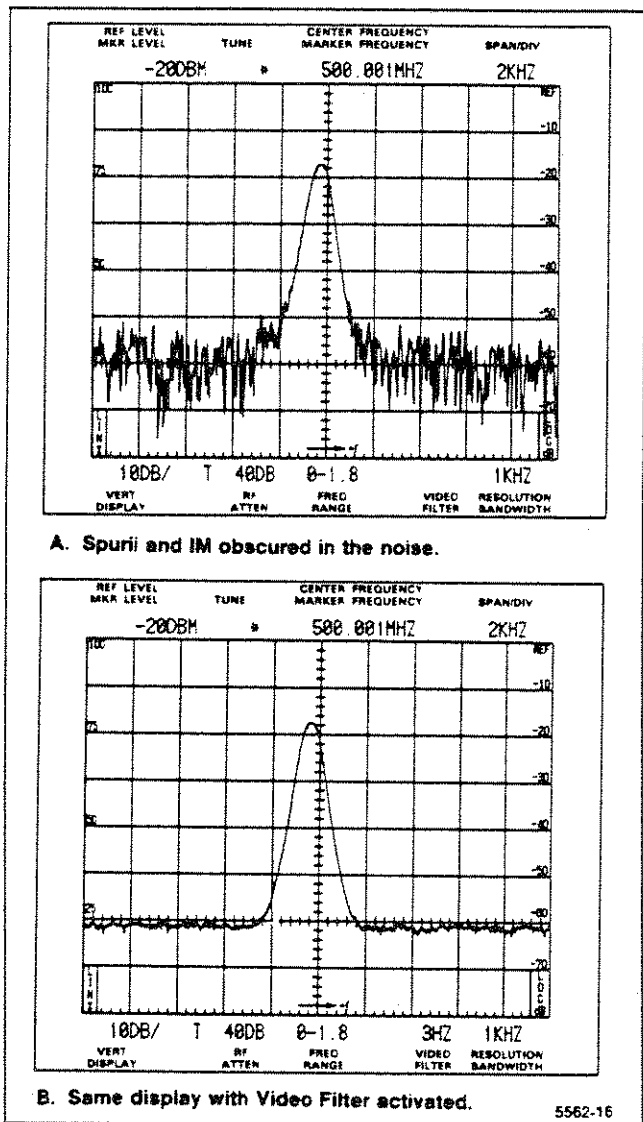

Figure 6-4. Typical display mixed with the VIDEO FILTER.

Using Time Domain Operation

When the FREQ SPAN/DIV is zero, the spectrum analyzer functions as a tunable receiver to display time domain characteristics within the selected resolution bandwidth. Characteristics like modulation pattern and pulse repetition rates can now be analyzed with TIME/DIV selections. Resolution bandwidth is usually maximum (1 MHz) for time domain analysis of the signal.

Reference Level, RF Attenuation, and Vertical Display

When a change is made to REF LEVEL, the gain distribution is automatically selected (IF gain and input RF attenuation) for the new reference level. The selection is made according to the settings of VERTICAL DISPLAY, FINE, MIN RF ATTEN dB, and MIN NOISE/MIN DISTortion.

The amount of input RF attenuation set is based on the reference level requested and the settings of MIN RF ATTEN dB and MIN NOISE/MIN DISTortion. The spectrum analyzer assumes the MIN RF ATTEN dB selection is the minimum attenuation required for the expected signal levels, and will not reduce RF attenuation below this value. As MIN RF ATTEN dB is increased, the lowest reference level is raised an equal amount. At 0 dB minimum attenuation, the lowest reference level is -117 dBm; at 10 dB minimum attenuation, the lowest reference level is -107 dBm, and so on. The best ratio of RF attenuation IF gain is selected according to the Minimum Noise/Minimum Distortion mode (see the description later in this section).

The REFERENCE LEVEL control steps depend on the VERTICAL DISPLAY and FINE settings. With LOG selected, the REFERENCE LEVEL control steps in 1 dB to 15 dB increments with FINE off. With FINE on, it steps in 1 dB increments for display factors of 5 dB/div or more and 0.25 dB for display factors of 4 dB/DIV or less. The 0.25 dB increments apply to the Delta A mode (see the description later in this section). With LIN selected and FINE off, the bottom of the crt graticule is zero volts, and the top of the crt graticule is eight times the vertical display factor. The display factor changes in a 1-2-5 volts/division sequence from 500 mV to 50 nV with FINE off. With FINE on, the reference level changes in 1 dB steps and the scale factor/division is 1/8 the voltage equivalent of the REFERENCE LEVEL.

Alternate Reference Level Units Selection

It is a simple procedure to select an alternate to dBm reference level units. Disconnect the calibrator signal from the RF INPUT, and change the REF LEVEL readout to 0 dBm. Press <SHIFT> REF LEVEL UNITS to get the reference level units menu. To change to dBV, select 1 from the menu, and the REF LEVEL readout changes to -13 dBV. To change to dBmV, select 2 from the menu, and the REF LEVEL readout changes to 47 dBmV. To change to dB, select 3 from the menu, and the REF LEVEL readout changes to 107 dB. To change back to dBm, select 0 from the menu, and the REF LEVEL readout changes to 0 dBm.

Using the Delta A Mode

To select the Delta A mode, push FINE while the vertical display factor is 4 dB/div or less. The REF LEVEL readout goes to 0.00 dB and the REFERENCE LEVEL control steps in 0.25 dB increments from this reference.

The Delta A mode accurately measures signal-relative amplitude difference. This is possible because the gain distribution (IF gain and RF attenuation) does not change in the Delta A mode. The REF LEVEL is changed by shifting the log amplifier offset. The total range of the Delta A mode is 58 dB. The measurement range depends on the REF LEVEL that is current at the time the Delta A mode is activated. It is typically at least 0 to 48 dB below the REF LEVEL that was current at the time the Delta A mode was activated. The overall instrument reference level range of -117 dBm to $+30$ dBm cannot be exceeded.

The Delta A mode is turned off when the vertical display factor is increased above 4 dB/div or FINE is turned off, by pushing the FINE pushbutton or changing the gain distribution with MIN RF ATTEN dB or MIN NOISE selections.

Signals with large amplitude differences that are within the Delta A range can be compared without the distortion usually introduced when signals are driven off-screen. Signals shifted off-screen by changes in the Delta A reference level are not overdriving the input. This is because the attenuator and IF gain do not change: the mixers do not see any change in signal levels even though the Delta A reference level changes.

Follow these five steps to measure the amplitude level differences of two signals.

1. Select the Delta A mode by pressing FINE. Select a vertical display of 4 dB/div or less with the dB/DIV DATA ENTRY pushbuttons or push the 2 dB/DIV pushbutton.
2. Set the peak of the larger signal to a graticule line with the REFERENCE LEVEL control.
3. Press the FINE pushbutton twice to turn the Delta A mode off an on. The readout will return to 0.00 dB.
4. With the REFERENCE LEVEL control, set the peak of the lower amplitude signal to the same graticule line established in step 2.
5. The REF LEVEL readout will now indicate the amplitude difference between the two signals in dB.

NOTE

Do not confuse the Delta A mode with the delta marker mode.

Using MIN NOISE or MIN DISTortion

One of two methods can be selected to control RF attenuator and IF gain settings. MIN NOISE minimizes noise level by decreasing input attenuation and IF gain by 10 dB. MIN DISTortion minimizes input mixer overload by increasing input attenuation and IF gain 10 dB. MIN DISTortionN is the normal mode of operation.

CAUTION

With MIN NOISE on and MIN RF ATTEN dB set to 60 dB, the REF LEVEL can be set to +40 dBm. The front end of the spectrum analyzer is specified at +30 dBm maximum if Option 01 is installed. Do not increase input signal level to full screen with a REF LEVEL of +40 dBm because this will exceed the attenuator rating. In instruments without Option 01 (no internal preselector), there is no limiter before the 1st mixer, so RF input power into the mixer (0 attenuation) should not exceed +13 dBm.

Using Digital Storage

Digital storage provides a smooth, flicker-free display. Two complete displays can be digitized and stored. In addition, the instrument Store Display and Recall functions will store up to nine displays in memory (see Using the Store and Recall Features later in this section). One of the two digitized waveforms can be saved and then compared to later waveforms. The Max Hold feature updates digital storage data only when the input signal amplitude is greater than previous data. This allows monitoring and graphic plotting of display changes (amplitude and frequency) with time.

The display is divided by a horizontal line that is positioned with the PEAK/AVERAGE control. Above the line, video information is peak detected; below the line, signal averaging occurs. This feature subdues noise in the portion below the line and allows full peak detection above the line. An intensified spot on the line indicates the horizontal position where memory is being updated. The average (number of samples) is a function of the sweep rate; the slower the rate the more samples.

When digital storage is used, an error of 0.5% of full screen must be added to the amplitude performance characteristics (i.e., frequency response, sensitivity).

The digital storage display is divided into an A and B section. Data can be stored in either A or B or in both. There are 500 horizontal locations in A and 500 horizontal locations in B. When both are displayed, the origin of the B waveform is shifted so the A and B coordinates

are interlaced to provide 1000 display increments. Data in memory is continually updated with each sweep so the display is always current.

When SAVE A is turned on, data in the A section is saved and only the B section of storage is updated. This takes place whether the A waveform is displayed or not. This mode captures an event or waveform, with its readout, for comparison with a subsequent event displayed by the B display. If VIEW B is on, the readout applies to the current B waveform. If SAVE A and VIEW A are on and VIEW B and B-SAVE A are off, the readout applies to the saved A waveform.

When B-SAVE A is turned on, the arithmetic difference between the B waveform and the saved A waveform is displayed (see Figure 6-5). This convenient mode can be used to align filters or other devices. The reference waveform is stored in A and the unknown is displayed by B. If the device under test is active, the B waveform may be larger than the reference so that the difference is off the screen. The reference level is usually set mid-screen so positive and negative quantities can be observed. The position of the zero reference can be changed by an internal switch. Contact qualified service personnel to have the reference level repositioned.

MAX HOLD causes the memory to be updated only if the new input is of higher magnitude than the former (B memory only if SAVE A is active). This allows monitoring of signals that may change with time and provides a graphic record of amplitude/frequency excursions.

Signal averaging is useful for suppressing noise. The number of samples averaged per horizontal digitized slot is a function of the spectrum analyzer sweep rate. The slower the sweep speed, the more samples averaged per horizontal slot. Resolution bandwidth affects the amplitude difference between peak detected and average levels of cw signals. When the resolution bandwidth is less than 1/30th the span/division (e.g., 100 kHz or less with 5 MHz span/div) there will be significant error in the average amplitude levels of cw signals, especially if only A or B is displayed. The peak value will be the true value. When using narrow resolution bandwidth with wide frequency spans, it is best to run digital storage with both the A and B waveforms interlaced and the cursor (horizontal line) at the bottom of the display.

To measure signal amplitude level, set the cursor to the bottom of the screen. To average noise, set the horizontal line at least one division above the noise level.

Using the Store and Recall Features

The spectrum analyzer features two functions to store up to nine waveforms, with marker(s) and readout, in memory to be recalled later for review or analyses. To save the display currently on the screen, press <SHIFT> STORE display, the register number (0-8) where you want to store the display, and if SAVE A is on the identity of the display you want stored (A or B). To

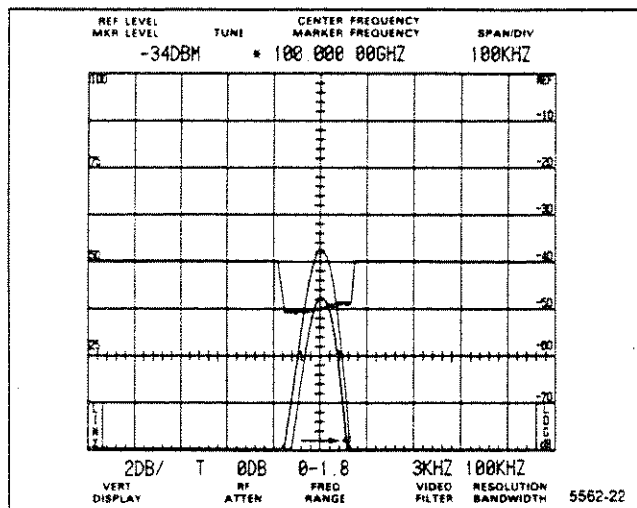

Figure 6-5. Typical display using B-SAVE A to observe the difference between SAVE A and B displays.

later recall this same display, press <SHIFT> RECALL DISPLAY, and the register menu showing the center frequency of each stored display will appear on the crt. Select the correct register number with a DATA ENTRY pushbutton, and then select the part of the digital storage (A or B) where you want to place the recalled display.

SAVE A is automatically activated to prevent an overwrite if location A is selected, VIEW A must be on to see the recalled display and VIEW B must be off to see the readout that applies to the recalled display. If VIEW B and VIEW A are on, both the display recalled in A and the current display in B will be visible on the screen. The readout shown applies to the current B display. Turn VIEW B off to see the readout that applies to the recalled A display.

If location B is selected, the next sweep will overwrite the display unless SINGLE SWEEP was activated before selecting B; a message will appear on the screen as a reminder of this. VIEW B must be on to observe the recalled display. Remember to deactivate SINGLE SWEEP when leaving this recalled mode.

To plot waveforms and readout, see Plotting the Display under PROGRAMMING FEATURES later in this section.

Using the Markers Feature

The marker modes provide direct readout of frequency and amplitude information of any point along any displayed trace. Relative (delta) frequency and amplitude information between any two points along any displayed trace or between traces is also available. Two independent marker frequencies and amplitudes cannot be displayed at the same time.

Marker Terms — The following definitions of marker terms are used throughout this section.

- **Live Trace** — Any combination of the A trace when SAVE A is off and/or the B trace. A trace recalled into B is not an active trace.
- **Active Trace** — A Live Trace or the B-SAVE A trace (a trace recalled into B is not an active trace).
- **Inactive Trace** — A SAVE A trace or a trace recalled into the B display before the sweep is started.
- **Primary Marker** — The marker displayed in the Single Marker mode whose frequency and/or position is changed when tuning with the CENTER/MARKER FREQUENCY control. When two markers are displayed, the brightest marker is the Primary marker.
- **Secondary Marker** — The "second" marker; displayed only in the Delta Marker mode.

Marker Turn On — The Single Marker mode places one marker (Primary marker) on the spectrum to display marker frequency and amplitude. The Delta Marker mode places two markers (Primary marker and Secondary marker) that display the difference in frequency and amplitude between the two markers. When two markers are displayed, the Primary marker is brighter. The Primary marker position and frequency can be changed with the CENTER/MARKER FREQUENCY control or from the GPIB.

The marker(s) can be turned on by pushing many of the pushbuttons related to marker action.

- TUNE CF/MKR (pushbutton lit) turns on the Primary marker
- <SHIFT> MKR — CF turns on the Primary marker
- FIND PEAK turns on the Primary marker
- SIGNAL TRACK turns on the Primary marker
- <SHIFT> MKR — REF LVL turns on the Primary marker
- 1—MKR—2 turns on both the Primary and Secondary markers
- Δ MKR turns on both the Primary and Secondary markers

There are three pushbutton sequences that turn the marker(s) off.

- <SHIFT> MKR OFF turns off all marker functions
- <SHIFT> RESET turns off all marker functions (the instrument is returned to the initial turn-on condition)
- Δ MKR (when both markers are on) turns off the Secondary marker and returns the instrument to the Single Marker mode

The markers are visible only when DIGITAL STORAGE functions are on; there can be no markers on a real-time trace. Any marker(s) on a trace will be stored

and recalled with the trace. In either the Single or Delta marker mode, a second line of readout appears on the crt. In the Single Marker mode, the marker frequency readout is displayed directly below the center frequency readout, and the marker amplitude is displayed directly below the reference level readout. In the Delta Marker mode, the frequency of the Primary marker with respect to that of the Secondary marker is displayed directly below the frequency readout, and the amplitude of the Primary marker with respect to that of the Secondary marker is displayed directly below the reference level readout. When in the Delta Marker mode, the relative amplitude and frequency readouts are enclosed on the screen in parentheses.

Assigning Markers — When the marker mode is first turned on from the front panel, the trace(s) on which the marker(s) appears is determined by the traces that are currently displayed, as indicated in Table 6-2. When a trace is turned off, any marker(s) on it are re-located according to Table 6-2. When a trace is turned on, the previous marker locations do not change and the marker always jumps to the active trace in maximum span or when in the Signal Track mode.

Tuning Markers — Move the Primary marker with the front-panel CENTER/MARKER FREQUENCY control (when the TUNE CF/MKR pushbutton is lit). To make it possible to change the position of the Secondary marker, you must make the Secondary marker be the Primary marker. Push 1—MKR—2 to swap the Primary and Secondary marker positions. Move the Primary marker (which used to be the Secondary marker), and then push 1—MKR—2 again to swap the Primary marker back to its previous location.

The marker normally moves over the fixed display. Marker tuning (both frequency and position) stops when the screen edge is reached while using the CENTER/MARKER FREQUENCY control. If the marker is on a trace containing a band edge, the marker may be tuned over the in-band portion only. This is true for both active and inactive traces. However, if the marker is on the B—SAVE A trace and the A trace contains a band edge but the B trace does not, the tuning is not limited.

The marker tuning rate depends on the speed with which the TUNE CF/MKR control is turned. If the control is turned rapidly, the marker moves 1/10 of a division per click. If the knob is turned quite slowly, the marker moves 1/100 of a division per click. At intermediate turning speeds, the marker moves approximately 1/30 of a division per click.

When two markers are displayed (delta-marker mode) and the marker frequency, center frequency, and span are changed, the Secondary marker remains fixed at its original frequency and is allowed to move off the screen. If the Primary and Secondary markers are swapped (with the 1—MKR—2 pushbutton) while the Secondary marker is off the screen, the display is centered on the frequency of the old Secondary marker (now the new Primary marker). The old Primary marker (now the new Secondary marker) is placed off the screen.

Error Detection

When an internal error is found in the spectrum analyzer, the words ERROR USE 7 will appear at the right end of the marker readout line. This message appears when the markers are on or the instrument is in MAX. Press 7 to read the definition of the problem and the probable effects of the problem. If the markers are off and the measurement is not in MAX, the error message will be steady and will specify the problem area. Additional information and servicing instructions are in the diagnostics information in the Maintenance section of the Service Manual, Volume 1. Report all problems or error information to qualified service personnel.

Using the Automatic Performance Testing Feature

<SHIFT> CAL activates a routine that tests frequency and relative amplitude of the IF filters. This routine should be done any time the temperature changes. Settings are held in memory after the test routine has run. Refer to Display Parameter Controls in Section 4 for further information.

Table 6-2
PRIMARY MARKER TRACE ORGANIZATION

VIEW A	VIEW B	SAVE A	B-SAVE A	PRIMARY MARKER LOCATION
Off	Off	Off	Off	Full Screen
Off	Off	On	Off	B ^a
Off	Off	On	On	B-SAVE A
Off	On	Off	Off	Full Screen
Off	On	On	Off	B
Off	On	On	On	B
On	Off	Off	Off	Full Screen
On	Off	On	Off	A
On	Off	On	On	B-SAVE A
On	On	Off	Off	Full Screen
On	On	On	Off	B
On	On	On	On	B

^aThe marker is located as shown; but, the marker is re-located when one of the digital storage traces is turned on.

PROGRAMMING FEATURES (2754P GPIB OPERATION)

Setting GPIB Address Switches

The general purpose interface bus (GPIB) ADDRESS switches on the rear panel set the value of the instrument's GPIB addresses. The Programmers manual contains details of how the switches are used in remote control operations.

The switches can be set as desired, except when using Tektronix 4050-Series controllers. They reserve address 0 for their own use. Selecting a primary address of 31 logically removes the instrument from the bus; it does not respond to any GPIB address, but remains both unlistened and untalked. If the switches are changed after power-up, the RESET TO LOCAL or PLOT pushbutton must be activated so the spectrum analyzer will update the primary address.

TALK ONLY, LISTEN ONLY Switches

The spectrum analyzer switches for talk-only and listen-only operation are part of the GPIB ADDRESS switch bank. Set either or both switches (you can have talk only, listen only, or both talk only and listen only features). If the spectrum analyzer power is on, press RESET TO LOCAL or PLOT for a change in these switches to take effect. Both the TALK ONLY and LISTEN ONLY switches must be off (down) when the spectrum analyzer is used with any controller.

Set the LF OR EOI switch to EOI (down) for use with Tektronix equipment. The switches marked 1, 2, 4, 8, and 16 may be set to any combination except all ones (decimal 31), which logically disconnects the spectrum analyzer from the bus or all zeroes when using the instrument with a 4050-Series controller.

Connecting to a System

Connect the programmable spectrum analyzer to a GPIB system through the GPIB cable supplied with the instrument. Connect the power cable after the power to the spectrum analyzer has been turned on or the controller is turned off to avoid generating interference on the bus.

Plotting the Display

Press PLOT to send display and/or graticule information over the GPIB to drive many external plotters such as the Tektronix 4662 Option 01, 4662 Option 31, or 4663 (emulating the 4662); the Hewlett-Packard HP7470A or HP7475A, HP7580B, HP7585B, or HP7486B; or the Gould 6310 or 6320.

To use the plot feature, connect the plotter to the spectrum analyzer with a IEEE STD 488 (GPIB) cable, and complete the following steps.

1. Set the corners of the plot for a 3:2 aspect ratio for the Tektronix plotters, or 6:5 for the Hewlett Packard and Gould plotters. The plotter must be in the Listen Only mode and the spectrum analyzer must be in either the TALK ONLY or TALK/LISTEN ONLY mode (appropriate switches on the rear panel GPIB ADDRESS switch closed or in the 1 position).

2. Set the plotter interface switches as follows:

Tektronix 4662 Option 01 or 4662 Option 31 (rear panel)

- A = 0, 1, 8, or 9
- B = C or D
- C = X (don't care)
- D = X (don't care)

Tektronix 4663

Interface Select = 1 if Option 04 or 2 if Option 01
 Initial Command/Response Format = 5
 Interface Mode = Listen Only

Hewlett-Packard or Gould Plotters

Address = 31

3. Press <SHIFT> 2 on the spectrum analyzer, and select the desired plotter type from the menu on the crt. The selection is stored in memory and does not need to be selected again unless the plotter type is changed.

4. Select the display and the information that you wish to plot. The Plot feature is similar to using a camera, in that a plot is made of everything that is turned on for the crt display. The information plotted depends on the setting of several front-panel pushbuttons and controls. If READOUT is on, the crt readout will be plotted with the display. If GRAT ILLUM is on, the bezel and graticule information will be included with the plot. If VIEW A, VIEW B, or B-SAVE A are on, these waveforms will be part of the plot. By the same token, if any of these functions are off, they will not be plotted.

The zero level for a B-SAVE A waveform is usually the graticule center line. (Switches within the instrument can set the level. Contact your service personnel for this change.) If you desire to shift the zero level for the plotting function only, press <SHIFT> 3, and enter the desired level in display units (25 is the bottom graticule line, 25 units/div). This zero level is retained in memory. It is not related to the display zero level, since the processor has no way of determining the internally-set zero level for the crt display or no way of changing it.

5. Press PLOT. During the plot operation, the front-panel controls are operational except <SHIFT> STORE display, and RECALL DISPLAY. The instrument can be used for other measurements.

OPERATIONAL CONSIDERATIONS AND PRECAUTIONS

Following are some operational precautions to observe and traps that can occur when analyzing displays.

1. RF INPUT Power Limit

CAUTION — DO NOT EXCEED THE RF INPUT POWER LIMIT OF +30 DBM. DO NOT APPLY DC VOLTAGE TO THE RF INPUT.

2. Instrument Warm-up After Storage

After storage below -15° C, allow 15 minutes instrument warm-up time, then turn the power off and back on.

3. Auto Resolution

Use AUTO RES with care when measuring absolute amplitude level. Always use a bandwidth wider than the incidental FM level of the signal source.

4. Measurements Outside Specified Frequency and Tuning Range vs Display Span

Signal level or frequency measurements outside the specified frequency range of the band are not reliable. In wide spans the total span of the display can exceed the frequency range; for example, the display extends below the 1.7 GHz lower limit of Band 2 and below the 15 GHz limit of Band 5 (15 to 21 GHz). The center frequency tuning range corresponds to the specified frequency range of the band. It can be confusing if a displayed signal, outside the frequency range of the band, will not tune to center screen.

The frequency range for external mixer bands is equal to the frequency range of the waveguide mixers.

5. Level of Pulsed Signals

The spectrum for a pulsed signal is spread out. Consequently, the height of the crt response is less for a pulsed signal than for a cw signal of the same peak amplitude. This loss in display height means, in effect, a loss in sensitivity. The amount of loss can be computed from the following formula.

$$\text{Voltage loss} = (t_p/B)(1.5)$$

here t_p = pulse duty cycle
 B = resolution bandwidth

The power of the self-generated noise increase is proportional to bandwidth. Pulsed RF voltage level is also proportional. Since power is proportional to voltage squared, a wider bandwidth gives better sensitivity and greater dynamic range for pulsed RF inputs.

When in doubt about signal level overdrive problems, reduce the signal level by inserting RF attenuation; then, repeat the measurement. If the two agree, the measure-

ment is correct; if not, the input mixer stage is probably overdriven.

An important consideration for pulsed RF measurements is the peak signal level at the mixer. The signal level is greater by $(t_o B)(1.5)$ than the peak level displayed on the crt. Taking the sensitivity loss into account is the only way of being sure that the mixer peak power input for linear operation is not exceeded.

6. Level of Continuous Wave Signals

Problems similar to those described in 6 can occur when analyzing cw signals at relatively narrow span widths. The large cw signal may not appear on screen because its frequency is outside the set span width. The mixer, nevertheless, is saturated and will compress signals. This will occur only if within the preselected bandwidth from 20 MHz at 1.7 GHz to 60 MHz above 10 GHz in standard instruments. The compression will not occur in Option 01 instruments, whatever the separation is.

7. Excessive Input Signal Level

Too much input power will destroy the front-end mixer or attenuator. Replacement mixers and attenuators are costly. When working with high power signals, use couplers or other devices to reduce the signal down to acceptable levels. Once the signal is down below the rating of the RF attenuator, prevent possible mixer damage by starting with MIN RF ATTEN dB fully clockwise, then reduce attenuation if needed.

8. No Crt Trace

BASILINE CLIP is used to reduce the brightness of the baseline on the crt for easier viewing of the readout. If TRIGGERING, INTENSITY, and vertical POSITION all seem to be in order and there is no crt trace, check the status of BASILINE CLIP; the trace may be turned off.

9. PEAK/AVERAGE

PEAK/AVERAGE should normally be fully counterclockwise so narrow signals in wide spans are not reduced in amplitude.

10. Digital Storage Effects on Signal Analyses

When using digital storage, the frequency base is divided into storage slots. For peak displays, above the cursor (horizontal line) the display point in each slot corresponds to the maximum sampled value of the sig-

nal. Samples are taken at about 9 μ s intervals. When sweeping at one second per division, this is about 1000 samples per slot. For average displays, below the cursor the values of all samples per slot are added and divided by the number of samples to compute the display point for each slot. Each display point is connected to create a smooth display. When A or B memory are displayed independently, only half of the slots are connected. The following are a few pitfalls that can occur.

If the cursor set by PEAK/AVERAGE is above the signal level, the average value for each digital slot will be displayed. With narrow resolution bandwidths compared to the slot width, the average value of the resolution response shape will be displayed, which has nothing to do with signal amplitude.

To avoid the above pitfalls, run digital storage with A and B interlaced. Do not set the PEAK/AVERAGE cursor to average a cw signal. It is best if the cursor is about 1/4 division above the signal to be averaged and about 1/2 division below the signal to be analyzed.

None of these restrictions apply when the resolution bandwidth is wide compared to a digital storage slot (e.g., 5 MHz/div with 1 MHz resolution).

11. Stored Display Averaged in Wide Spans

When operating in wide spans with digital storage, low level signals will be averaged with the noise and lost if the PEAK/AVERAGE cursor is above the display. Turn the control fully counterclockwise for peak detection when operating with wide spans.

12. Automatic Calibration of Relative Amplitudes of Resolution Bandwidth

Filters*

If a calibration failed message appears when the automatic calibration completes, refer to the correction factors for an explanation. Press <SHIFT> 1 to display the correction factors held in memory. Refer to Calibrate Center Frequency, Reference Level, and Dynamic Range in Section 5 for further information.

13. TRIGGERING

TRIGGERING is set to FREE RUN for most applications. In pulsed RF applications, a triggered display is required to measure between pulse repetition lines to determine the pulse repetition rate.

Internal triggering requires one or more divisions of signal amplitude. Tune the center frequency so a reasonably-sized signal is located at the sweep start before changing the trigger source from FREE RUN to INT.

SERVICE INFORMATION

Service Manual

The spectrum analyzer Service Manuals are separate publications. The Service Manual, Volume 1, includes circuit descriptions, troubleshooting information, calibration procedures, and maintenance procedures. The Service Manual, Volume 2, includes the electrical and mechanical parts lists, standard and optional accessories, and schematic diagrams. Service Manuals are intended for use by **QUALIFIED SERVICE PERSONNEL ONLY**. To avoid electrical shock, **DO NOT** perform any servicing unless qualified to do so. Service personnel should read the Safety information at the beginning of the Service Manuals before performing any servicing.

Product Service

To assure adequate product service and maintenance for our instruments, Tektronix, Inc. has established Field Offices and Service Centers at strategic points throughout the United States and in all other countries where our products are sold. Contact your local Service Center, representative, or sales engineer for details regarding Warranty, Calibration, Emergency Repair, Repair Parts, Scheduled Maintenance, Maintenance Agreements, Pickup and Delivery, On-Site Service for fixed installations, and other services available through these centers.

Emergency Repair

This service provides immediate attention to instrument malfunction if you are in an emergency situation. Contact any Tektronix Service center for assistance to get you on your way within a minimum of time.

Maintenance Agreements

Several types of maintenance or repair agreements are available. For example; for a fixed fee, a maintenance agreement program provides maintenance and recalibration on a regular basis. Tektronix, Inc. will remind you when a product is due for recalibration and perform the service within a specified time-frame. Refer to Options M1 through M5 in Section 7 for extended service and warranty options available. Any Service Center can furnish complete information on costs and types of maintenance programs.

OPTIONS

This section describes the options available at this time for the spectrum analyzer. Changes in specifications, if any, are described in this section. Contact your local Tektronix Field Office or representative for additional information and ordering instructions (unless otherwise indicated).

Options are usually factory installed; however, field kits are available for some options. Contact your local Tektronix Field Office or representative for information on field kits and their installation.

Options A1, A2, A3, A4, and A5 (Power Cord Options)

There are five international power cord options offered for the spectrum analyzer (see Table 7-1). The physical descriptions of the cord plugs are illustrated in Figure 7-1. For ordering purposes, refer to the Replaceable Mechanical Parts list in the Service Manual, Volume 2, for the Tektronix Part Number.

Table 7-1
POWER CORD OPTIONS

Option	Description
A1	European, 220 V/50 Hz @ 16A
A2	United Kingdom, 240 V/50 Hz @ 13A
A3	Australian, 240 V/50 Hz, @ 10A
A4	North American, 240 V/60 Hz. @ 15A
A5	Swiss, 220 V/50 Hz, @ 10A

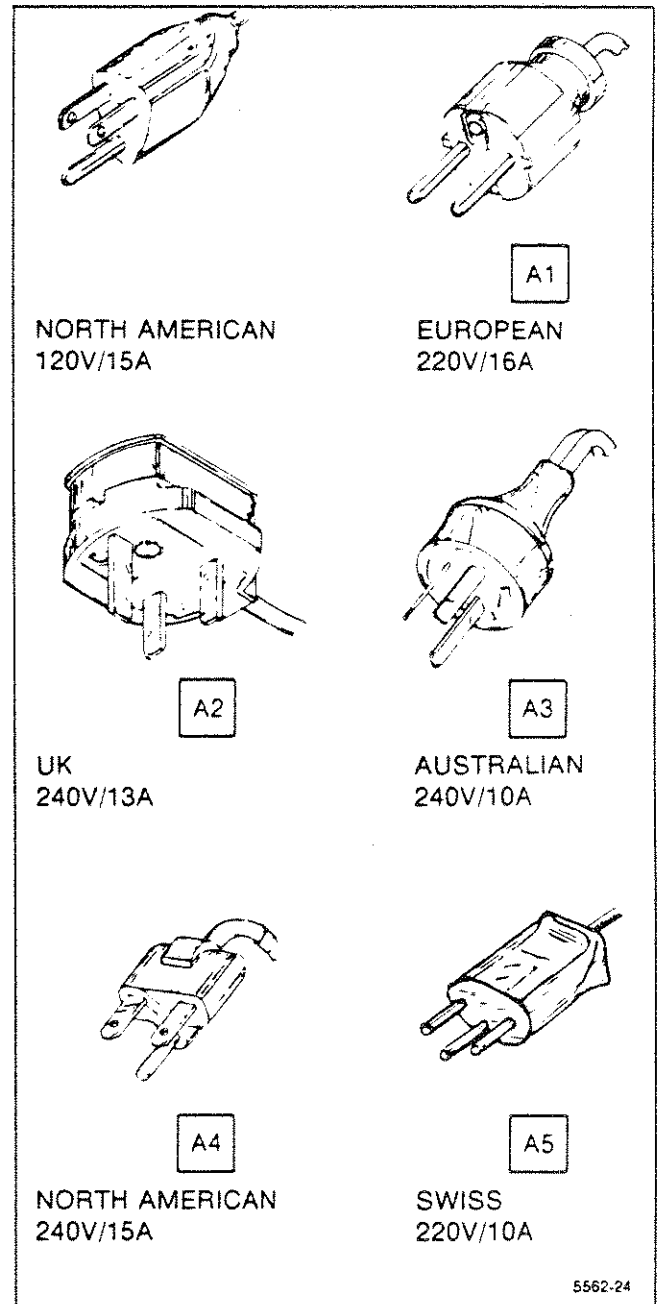

Figure 7-1. International power cord options for the spectrum analyzer.

Options M1, M2, and M3 (Extended Service and Warranty Options)

There are three extended service and warranty options offered for the spectrum analyzer (see Table 7-2) that go beyond the basic one-year coverage. Contact our local Tektronix Field Office or representative for additional information to satisfy your specific requirements.

Option 01

Option 01 adds an internal preselector and limiter. Band 1 input signals are routed through a limiter and low-pass filter. The band 1 frequency range becomes 50 kHz to 1.8 GHz. Band 2-5 input signals (1.7 GHz-21 GHz) are routed through the preselector. Table 7-3 lists the specification changes and additions to the standard instrument electrical characteristics.

Table 7-2
EXTENDED SERVICE
AND WARRANTY OPTIONS

Option	Description
M1	Two routine calibrations to published specifications; one each in years two and three of warranty coverage, plus two years remedial service
M2	Four years remedial service
M3	Four routine calibrations to published specifications; one each in years two, three, four, and five of product ownership, plus four years of remedial service

Table 7-3
OPTION 01 ALTERNATE SPECIFICATIONS

Characteristic	Performance Requirement		Supplemental Information
FREQUENCY			
Response Coaxial (direct) Input			
Band and Freq Range	About the mid-point between two extremes	Referenced to 100 MHz	
1 (50 kHz-1.8 GHz)	±1.5 dB		
2 (1.7-5.5 GHz)	±2.5 dB	±3.5 dB	
3 (3.0-7.1 GHz)	±2.5 dB	±3.5 dB	
4 (5.4-18.0 GHz)	±3.5 dB	±4.5 dB	
5 (15.0-21.0 GHz)	±5.0 dB	±6.5 dB	
AMPLITUDE			
Spurious Responses 3rd Order Intermodulation Products			
50 kHz-21 GHz (Bands 1-5)	At least -70 dBc from any two on-screen signals within any frequency span		≥-100 dBc when signals are separated 100 MHz or more in preselected bands.

Table 7-3 (Continued)
OPTION 01 ALTERNATE SPECIFICATIONS

Characteristic	Performance Requirement	Supplemental Information				
AMPLITUDE (Continued)						
Harmonic Distortion						
50 kHz–1.8 GHz (Band 1)	–60 dBc or less	Measured at –40 dBm input level in Minimum Distortion Mode.				
1.7–21 GHz	Not discernible	Typically –100 dBc				
LO Emission	Less than –70-dBm–21 GHz	With 0 dB RF Attenuation				
INPUT						
Maximum Safe Input Level (Attenuator Maximum Rating)		+30 dBm (1 W) continuous, 75 W peak, pulse width 1 μ s or less with a maximum duty factor of 0.001 (attenuator limit). DO NOT APPLY DC VOLTAGE TO THE RF INPUT. (See Optional Accessories for DC Block)				
SENSITIVITY						
	Equivalent Input Noise in dBm versus Resolution Bandwidth					
Band and Frequency Range	kHz	10 kHz	100 kHz ^a	300 kHz ^a	1 MHz	Equivalent maximum input noise with internal preselection for each resolution bandwidth for frequency bands 1–5 (50 kHz–21 GHz), the NARROW Video filter is activated for resolution bandwidths of 1 kHz or less, and the WIDE filter for resolution bandwidths above 1 kHz.
1 (50 kHz–1.8 GHz)	–119	–110	–100	–90	–85	
2 (1.7–5.5 GHz)	–110	–100	–90	–85	–80	
3 (3.0–7.1 GHz)	–109	–99	–89	–84	–79	
4 (lower part) (5.4–12.0 GHz)	–95	–85	–75	–70	–65	
4 (upper part) (12.0–18.0 GHz)	–90	–80	–70	–65	–60	
5 (15.0–21.0 GHz)	–90	–80	–70	–65	–60	
PHYSICAL						
Weight with standard accessories, except manuals	55 pounds, maximum					

Option 07

Option 07 provides an optional 75 Ω input, replacing the external mixer capability. Table 7-4 lists the changes and additions to the standard instrument electrical characteristics. These characteristics apply to the 75 Ω input.

^a Option 07 replaces the 100 kHz filter with a 300 kHz filter.

Table 7-4

OPTION 07 ALTERNATE SPECIFICATIONS

Characteristic	Performance Requirement	Supplemental Information
INPUT		
Input Impedance of the 75 Ω input		75 Ω
Return Loss		17 dB (1.35:1 VSWR)
5 MHz–800 MHz		
800 MHz–1000 MHz		13 dB (1.6:1 VSWR) with ≥10 dB attenuation
Maximum Input Level		
With 0 dB Attenuation		+75 dBmV
With 20 dB or More Attenuation		+78 dBmV, 100 V _{dc} maximum (dc + peak)
FREQUENCY		
Center Frequency Operating Range		1 MHz–1000 MHz
Static Resolution Bandwidth	Within 20% of 300 kHz bandwidth (6 dB down)	300 kHz resolution filter replaces the standard instrument 100 kHz filter.
Frequency Response of the 75 Ω input	±2.0 dB about the midpoint between two extremes	Frequency response is measured with ≥10 dB RF attenuation. The response figure includes the effects of: ●input vswr ●mixer ●gain variations Variations in display flatness con- tribute about 1 dB to the response figure.
5 MHz–1000 MHz Coaxial Input		
1 MHz to 5 MHz		Typically <3 dB down from the 5 MHz response
AMPLITUDE		
Reference Level Range		+78 dBmV to –75 dBmV +88 dBmV is achievable in MIN NOISE mode
SENSITIVITY		
Equivalent Input Noise Sensitivity		See the main specifications and the Option 01 specifications for 300 kHz sensitivity with the 50 Ω RF INPUT.
5 MHz to 1000 MHz		
100 Hz	–74 dBmV	Typically –83 dBmV
1 kHz	–66 dBmV	Typically –73 dBmV
10 kHz	–56 dBmV	Typically –63 dBmV
300 kHz	–41 dBmV	Typically –48 dBmV
1 MHz	–36 dBmV	Typically –43 dBmV
OUTPUT		
Calibrator Output when in 75 Ω mode (CAL OUT) Level	+20 dBmV ±0.5 dB at 100 MHz ±10 PPM	100 MHz comb of markers provide amplitude calibration at 100 MHz and markers for frequency and span cali- bration to 1.0 GHz
Output Impedance		75 Ω nominal

Options 30 and 31

Option 30 provides the spectrum analyzer installed in a rackmount cabinet. External vibrations, from rack cooling fans or surrounding equipment, may lower the FM-characteristic. Because of different rack frame types, this lowering cannot be specified; in a typical fan-cooled rack, lowering increases by a factor of two.

Option 31 provides the cabling necessary to access all the front-panel connectors at the cabinet rear panel. Because of the extra cabling, lowering may occur in response flatness and sensitivity at the high end of the frequency range; above 3.0 GHz this is typically about 2 dB. measurement capabilities for Digital Microwave Radio.

Option 52

Option 52 provides a North American 220 V configuration with the standard power cord. The fuses are replaced with 2A slow blow.

GLOSSARY

The following glossary is presented as an aid to better understand the terms as they are used in this document and with reference to spectrum analyzers.

GENERAL TERMS

Center Frequency. That frequency which corresponds to the center of a frequency span, expressed in hertz.

dBc. Decibels referenced to carrier level.

Effective Frequency Range. That range of frequency over which the instrument performance is specified. The lower and upper limits are expressed in hertz.

Frequency Band. A part of effective frequency range over which the frequency can be adjusted, expressed in hertz.

Full Span (Maximum Span). A mode of operation in which the spectrum analyzer scans an entire frequency band.

Zero Span. A mode of operation in which the frequency span is reduced to zero.

Envelope Display. The display produced on a spectrum analyzer when the resolution bandwidth is greater than the spacing of the individual frequency components.

BLine Display. The display produced on a spectrum analyzer when the resolution bandwidth is less than the spacing of the signal amplitudes of the individual frequency components.

Line Spectrum. A spectrum composed of signal amplitudes of the discrete frequency components.

Markers. The instrument uses three types of markers:

Waveform Markers. — When the Marker function is enabled, it provides a movable cursor with readout of frequency and amplitude at the marker position. When the delta marker mode is enabled, a second marker allows operations and readout between the two marker positions.

Update Marker. - Marks the current sweep position in a digital storage display as the display is being updated.

Video Markers. - Marker signals applied to the external VIDEOMARKER input from a Tektronix 1405 Television Sideband Analyzer. The Video

Markers mark frequencies of interest on the television signal.

Maximum Safe Input Power

WITHOUT DAMAGE. The maximum power applied at the input which will not cause degradation of the instrument characteristics.

WITH DAMAGE. The minimum power applied at the input which will damage the instrument.

Intermodulation Spurious Response (Intermodulation Distortion). An unwanted spectrum analyzer response resulting from the mixing of the nth order frequencies, due to non-linear elements of the spectrum analyzer, the resultant unwanted response being displayed.

Baseline Clipper (Intensifier). Increasing the brightness of the signal relative to the baseline portion of the display.

Pulse Stretcher. A pulse shaper that produces an output pulse, whose duration is greater than that of the input pulse, and whose amplitude is proportional to that of the peak amplitude of the input pulse.

Signal Identifier. A means to identify the spectrum of the input signal when spurious responses are possible.

Spectrum Analyzer. An apparatus which is generally used to display the power distribution of an incoming signal as a function of frequency.

NOTE

It is useful in analyzing the characteristics of repetitive electrical waveforms in general, since repetitively sweeping through the frequency range of interest will display all components of the signal.

Video Filter. A post detection low-ORpass filter.

Scanning Velocity. Frequency span divided by sweep time and expressed in hertz per second.

FREQUENCY TERMS

Display Frequency. The input frequency as indicated by the spectrum analyzer and expressed in hertz.

Frequency Span (Dispersion). The magnitude of the frequency band displayed, expressed in hertz or hertz per division.

Frequency Linearity Error. The error of the relationship between the frequency of the input signal and the frequency displayed (expressed as a ratio).

Frequency Drift. Gradual shift or change in displayed frequency over the specified time due to internal changes in the spectrum analyzer, and expressed in hertz per second, where other conditions remain constant.

Residual FM (Incidental FM). Short term displayed frequency instability or jitter due to instability in the spectrum analyzer local oscillators, given in terms of peak-to-peak frequency deviation and expressed in hertz or percent of the displayed frequency.

Impulse Bandwidth. The displayed spectral level of an applied pulse divided by its spectral voltage density level assumed to be flat within the pass-band.

Static (Amplifier) Resolution Bandwidth. The specified bandwidth of the spectrum analyzer's response to a cw signal, if sweep time is kept substantially long.

NOTE

This bandwidth is the frequency separation of two down points, usually 6 dB, on the response curve, if it is measured either by manual scan (true static method) or by using a very low speed sweep (quasi-static method).

Shape Factor (Skirt Selectivity). The ratio of the frequency separation of the two (60 dB/6 dB) down points on the response curve to the static resolution bandwidth.

Zero Pip (Response). An output indication which corresponds to zero input frequency.

AMPLITUDE TERMS

Deflection Coefficient. The ratio of the input signal magnitude to the resultant output indication.

NOTE

The ratio may be expressed in terms of volts (rms) per division, decibels per division, watts per division, or any other specified factor.

Display Reference Level. A designated vertical position representing a specified input level.

NOTE

The level may be expressed in decibels (e.g., 1 mW), volts, or any other units.

Sensitivity. Measure of a spectrum analyzer's ability to display minimum level signals, at a given IF bandwidth, display mode, and any other influencing factors, and expressed in decibels (e.g., 1 mW).

Equivalent Input Noise Sensitivity. The average level of a spectrum analyzer's internally generated noise referred to the input.

Display Flatness. The unwanted variation of the displayed amplitude over a specified frequency span, expressed in decibels.

Relative Display Flatness. The display flatness measured relative to the display amplitude at a fixed frequency within the frequency span, expressed in decibels.

NOTE

Display flatness is closely related to frequency response. The main difference is that the spectrum display is not recentered.

Frequency Response. The unwanted variation of the displayed amplitude over a specified center frequency range, measured at the center frequency, expressed in decibels.

Display Law. The mathematical law that defines the input-output function of the instrument.

NOTE

The following cases apply:

1) **Linear** — A display in which the scale divisions are a linear function of the input signal voltage.

2) **Square law (power)** — A display in which the scale divisions are a linear function of the input signal power.

3) **Logarithmic** — A display in which the scale divisions are a logarithmic function of the input signal voltage.

Dynamic Range. The maximum ratio of the levels of two signals simultaneously present at the input which can be measured to a specified accuracy.

Display Dynamic Range. The maximum ratio of the levels of two non-harmonically related sinusoidal signals each of which can be simultaneously measured on the screen to a specified accuracy.

Gain Compression. Maximum input level where the scale linearity error is below that specified.

Spurious Response. A response of a spectrum analyzer wherein the displayed frequency does not conform to the input frequency.

Hum Sidebands. Undesired responses created within the spectrum analyzer, appearing on the display, that are separated from the desired response by the fundamental or harmonic of the power line frequency.

Noise Sidebands. Undesired response caused by noise internal to the spectrum analyzer appearing on the display around a desired response.

Residual Response. A spurious response in the absence of an input signal. (Noise and zero pip are excluded.)

Input Impedance. The impedance at the desired input terminal.

NOTE

Usually expressed in terms of vswr, return loss, or other related terms for low impedance devices and resistance-capacitance parameters for high impedance devices.

DIGITAL STORAGE TERMS

Digitally Stored Display. A display method whereby the displayed function is held in a digital memory. The display is generated by reading the data out of memory.

Digitally Averaged Display. A display of the average value of digitized data computed by combining serial samples in a defined manner.

Multiple Display Memory. A digitally stored display having multiple memory sections which can be displayed separately or simultaneously.

Clear (Erase). Presets memory to a prescribed state, usually that denoting zero.

Save. A function which inhibits storage update, saving existing data in a section of a multiple memory (e.g., Save A).

View (Display). Enables viewing of contents of the

chosen memory section (e.g., "View A" displays the contents of memory A; "View B" displays the contents of memory B).

Max Hold (Peak Mode). Digitally stored display mode which, at each frequency address, compares the incoming signal level to the stored level and retains the greater. In this mode, the display indicates the peak level at each frequency after several successive sweeps.

Scan Address. A number representing each horizontal data position increment on a directed beam type display. An address in a memory is associated with each scan address.

Volatile/Non-volatile Storage. A volatile storage system is one where any total loss of power to the system will result in a loss of stored information. Non-volatile memory is not subject to the instrument power supply for its storage.

Date: 6-01-88
Product: See list

Change Reference: M66071
Manual Part No: See list

Eff/SN B010100
Product Group: 26

INSTRUMENT		PART NO.
494A/AP	Operators	070-5557-01
495/P	Operators	070-5082-00
2753P	Operators	070-6305-00
2754/P	Operators	070-6096-00
2756P	Operators	070-6317-00
492B/BP	Operators	070-5562-01
2755A/AP	Operators	070-6031-01
494A/AP	Service 1	070-5560-00
495/P	Service 1	070-5084-00
2753P	Service 1	070-6306-00
2754/P	Service 1	070-6097-00
2756P	Service 1	070-6318-00
492B/BP	Service 1	070-5565-01
2755A/AP	Service 1	070-6032-01

ADD:

OPTION 43

Option 43 provides a reduced graticule ray tube. This option also enables the main display readout characters to be positioned outside the graticule area.



MANUAL CHANGE INFORMATION

At Tektronix, we continually strive to keep up with latest electronic developments by adding circuit and component improvements to our instruments as soon as they are developed and tested.

Sometimes, due to printing and shipping requirements, we can't get these changes immediately into printed manuals. Hence, your manual may contain new change information on following pages.

A single change may affect several sections. Since the change information sheets are carried in the manual until all changes are permanently entered, some duplication may occur. If no such change pages appear following this page, your manual is correct as printed.

Date: May 11, 1990
Product: 2754P

Change Reference: C1/188 Revised
Manual Part No: 070-6096-00

Effective SN: B030502
Product Group: 2E

This directly replaces C1/188

2754P Spectrum Analyzer with Preselector

The information in this insert covers the new preselector and input limiter standard feature of the 2754P and completely replaces all Option 01 information.

Throughout this material where information is duplicated from the standard text, the changes are highlighted. Bullets (•••) are used where information has been deleted because it no longer applies.

Section 1

There are no changes.

Section 2

The following specifications are changes to the tables in Section 2. Any specification not addressed here remains the same. Specification changes not related to the preselector have been included to reflect improved instrument performance.

Characteristic	Performance Requirement	Supplemental Information
<i>Frequency Related</i>		
Center/Marker Frequency		10 kHz to 21 GHz
Reference Frequency Error		Tuned by the CENTER/MARKER FREQUENCY control or the DATA ENTRY keypad.
Accuracy During Warm-up at +25°C 30 minutes after power up		Within $\pm 1 \times 10^{-5}$
Temperature Sensitivity		Within $\pm 1.5 \times 10^{-5}$ over the operating temperature range, referenced to +25°C
Noise Sidebands	≤ -73 dBc	Measured at an offset of 30 x resolution bandwidth
Frequency Span/Div		
With Multiband Mode		In bands 2 through 5, START/STOP permits entry of a start frequency in one band and the stop frequency in another band. Maximum range is 1.7 GHz to 21 GHz.

Characteristic	Performance Requirement	Supplemental Information	
Frequency Span/Div With Multiband Mode		<p>Start and Stop frequencies are limited to a single band in Band 1.</p> <p>The FREQ RANGE readout displays MULTIBD when in the Multiband mode.</p>	
Maximum Span/Div		With SPAN/DIV Control	With DATA ENTRY Keypad
Band 1 (0-1.8 GHz) Band 2 (1.7-5.5 GHz) Band 3 (3-7.1 GHz) Band 4 (5.4-18 GHz) Band 5 (15-21 GHz)		100 MHz 200 MHz 200 MHz 1 GHz 500 MHz	170 MHz 370 MHz 400 MHz 1.2 GHz 590 MHz
		<p>In addition, MAX SPAN sweeps across an entire band and ZERO SPAN provides a 0 Hz display. With ZERO SPAN, the horizontal axis is calibrated in time/div instead of frequency/div.</p>	
Frequency Response			
Band and Freq Range	About the mid-point between two extremes	Referenced to 100 MHz	
1 (10 kHz-1.8 GHz) 2 (1.7-5.5 GHz) 3 (3.0-7.1 GHz) 4 (5.4-18 GHz) 5 (15-21 GHz)	±2.0 dB ±3.0 dB ±3.0 dB ±4.0 dB ±5.5 dB	±3.0 dB ±4.0 dB ±4.0 dB ±5.0 dB ±7.0 dB	
IF Frequency, LO Range, and Harmonic Number (N)		1st IF (MHz)	LO Range (MHz) (N)
Band and Freq Range			
1 (0-1.8 GHz) 2 (1.7-5.5 GHz) 3 (3.0-7.1 GHz) 4 (5.4-18 GHz) 5 (15-21 GHz)		2072 829 829 829 2072	2072-3872 2529-6329 2171-6271 2072-6276 4309-6309
<i>Amplitude Related</i>			
Reference Level		Top of the graticule	
Range		From -117 dBm to +50 dBm; +50 dBm includes 20 dB of IFgain reduction (+30 dBm is the maximum safe input).	
Log Mode (With 0 Reference Level offset)		Alternate reference levels are: • dBV (-130 dBV to +137 dBV) • dBmV (-70 dBmV to +97 dBmV) • dBµV (-10 dBµV to +157 dBµV)	

Characteristic	Performance Requirement	Supplemental Information															
Reference Level Range Accuracy		<p>Dependent on the following characteristics:</p> <ul style="list-style-type: none"> • RF Attenuation Accuracy • IF Gain Accuracy • Resolution Bandwidth • Frequency Response • Display Mode • Calibrator Accuracy • Frequency Band • <blue-SHIFT> CAL routine reduces error between resolution bandwidths at -20 dBm REF LEVEL. Other REF LEVELs may have larger errors. • Temperature variation (± 0.15 dB/$^{\circ}$C maximum) <p>The input RF attenuator steps 10 dB for reference level changes above -30 dBm (-20 dBm when MIN NOISE is active) unless the MIN RF ATTEN setting is greater than zero.</p> <p>The IF gain increases 10 dB for each 10 dB reference level change below -30 dBm (-20 dBm when MIN NOISE is active)</p>															
IF Gain Range		87 dB of gain increase, 20 dB of gain decrease (MIN NOISE mode), in 10 dB and 1 dB steps															
Decade Transitions -29 to -30 dBm -39 to -40 dBm -49 to -50 dBm -59 to -60 dBm	0.75 dB or less	Maximum 1 dB cumulative error over 10 dB															
Maximum Deviation over the 107 dB Range	± 2 dB																
Gain Variation Between Resolution Bandwidths		Measurement conditions:															
With respect to the 3 MHz Filter	± 0.4 dB	<ul style="list-style-type: none"> • Measured at -20 dBm • MIN DISTORTION mode • After CAL routine @ ambient temperature 															
Between Any Two Filters	≤ 0.8 dB																
Differential Amplitude Measurement Range		Maximum range of 57.75 dB dependent on Reference Level when ΔA mode is activated															
Accuracy		<table border="1"> <thead> <tr> <th>Difference</th> <th>Steps</th> <th>Error</th> </tr> </thead> <tbody> <tr> <td>0.25 dB</td> <td>2</td> <td>0.15 dB</td> </tr> <tr> <td>2 dB</td> <td>8</td> <td>0.4 dB</td> </tr> <tr> <td>10 dB</td> <td>40</td> <td>1.0 dB</td> </tr> <tr> <td>20 dB to 57.75 dB</td> <td>80 to 231</td> <td>2.0 dB</td> </tr> </tbody> </table>	Difference	Steps	Error	0.25 dB	2	0.15 dB	2 dB	8	0.4 dB	10 dB	40	1.0 dB	20 dB to 57.75 dB	80 to 231	2.0 dB
Difference	Steps	Error															
0.25 dB	2	0.15 dB															
2 dB	8	0.4 dB															
10 dB	40	1.0 dB															
20 dB to 57.75 dB	80 to 231	2.0 dB															

Characteristic	Performance Requirement	Supplemental Information
Spurious Responses Residual -95 dBm or less		No input signal, 0 dB RF Attenuation and fundamental mixing Bands 1-3. Input terminated in 50 Ω.
3rd Order Intermodulation Products	-70 dBc or less	From any two on-screen signals within any frequency span in MIN DISTORTION mode.
Harmonic Distortion 10 kHz to 21 GHz	-60 dBc or less	Measured at -40 dBm input level in MIN DISTORTION mode
LO Emissions	Less than -70 dBm to 21 GHz	With 0 dB RF Attenuation
Sensitivity Frequency Range	1 kHz 10 kHz 100 kHz 300 kHz* 1 MHz 3 MHz	Equivalent maximum input noise for each resolution bandwidth
10 kHz-1.8 GHz	-110 -100 -90 -85 -80 -75	Measured at 20°C with: • 0 dB attenuation (Min Atten 0 dB) • Narrow Video Filter on • Vertical Display 2 dB/div • Digital Storage on • Max Hold off • Peak/Average in Average • 1 sec Time/Div • Zero Span • Input terminated in 50 Ω
1.7 GHz-7.1 GHz	-108 -98 -88 -83 -78 -73	
5.4 GHz-12 GHz	-94 -84 -74 -69 -64 -59	
12 GHz-18 GHz	-89 -79 -69 -64 -59 -54	
15 GHz-21 GHz	-88 -78 -68 -63 -58 -53	
	^A Opt 07 replaces the 100 kHz filter with a 300 kHz filter.	
<i>Input Signal</i>		
RF INPUT VSWR With 0 dB RF Attenuation		Measured within 3 MHz of the center of the preselector on Bands 2, 3, 4, and 5
10 kHz-6 GHz		Typically 1.9:1
6-18 GHz		Typically 2.3:1
18-21 GHz		Typically 3.0:1
Maximum Safe Input		+30 dBm (1 W) continuous, 75 W peak
Attenuator Maximum Rating		• Pulse Width = 1 μS or less • Maximum duty factor of 0.001 (attenuator limit) DO NOT APPLY DC VOLTAGE TO THE RF INPUT.
1 dB Compression Point (Minimum)		0 RF Attenuation
MIN DISTortion Mode	-23 dBm	
MIN NOISE Mode	-13 dBm	
HORIZ TRIG Trigger Input Voltage Range Minimum		Typically 1.5 V peak at 1.0 MHz
	≥1.0 V peak from 15 Hz to 500 kHz	

Characteristic	Performance Requirement	Supplemental Information															
<i>Output Signal</i>																	
1st LO and 2nd LO OUTPUTs		Provide access to the output of the respective local oscillators. THESE PORTS MUST BE TERMINATED IN 50 Ω AT ALL TIMES															
1st LO OUTPUT Power 2nd LO OUTPUT Power		≤+6.0 dBm -12 dBm, ±5 dBm															
<i>General</i>																	
MKR/Time Accuracy (In Zero Span mode)		Marker time available only in zero span															
Single Marker ΔMarker		±10% ±5%															
Triggering EXTERNAL Trigger Input Level	1.0 V peak, minimum	EXTERNAL is ac-coupled (15 Hz-500 kHz). Maximum external trigger input is 50 V (dc + peak ac)															
Video Bandwidth		<table border="1"> <thead> <tr> <th>Resolution Bandwidth</th> <th>WIDE Video Filter</th> <th>NARROW Video Filter</th> </tr> </thead> <tbody> <tr> <td>1 & 3 MHz</td> <td>30 kHz</td> <td>3 kHz</td> </tr> <tr> <td>100 kHz</td> <td>3 kHz</td> <td>300 Hz</td> </tr> <tr> <td>10 kHz</td> <td>300 Hz</td> <td>30 Hz</td> </tr> <tr> <td>1 kHz</td> <td>30 Hz</td> <td>3 Hz</td> </tr> </tbody> </table>	Resolution Bandwidth	WIDE Video Filter	NARROW Video Filter	1 & 3 MHz	30 kHz	3 kHz	100 kHz	3 kHz	300 Hz	10 kHz	300 Hz	30 Hz	1 kHz	30 Hz	3 Hz
Resolution Bandwidth	WIDE Video Filter	NARROW Video Filter															
1 & 3 MHz	30 kHz	3 kHz															
100 kHz	3 kHz	300 Hz															
10 kHz	300 Hz	30 Hz															
1 kHz	30 Hz	3 Hz															
Pulse Stretcher Fall Time		30 μS/division typical															
<i>Power</i>																	
Line Frequency Range		47 Hz to 440 Hz — operation over 63 Hz exceeds protective grounding conductor leakage current of 3.5 mA. A redundant protective grounding means is essential to prevent against electric shock															
Line Fuse 115 V Nominal 230 V Nominal		4 A 2 A Medium-Blow															
Leakage Current 47-63 Hz		3.5 mA maximum with the EMI filter at 250 V, 60 Hz															
else		5 mA maximum															
<i>Physical</i>																	
Weight		60 pounds (27 kg) including cover and standard accessories, except manuals															
Dimensions		7.0 x 17.0 x 25.0 inches (17.78 x 43.18 x 63.5 cm)															

Section 3

There are no changes.

Section 4

Page 4-6

- 19 <SHIFT> IDENT — This pushbutton sequence separates real signals from spurious responses The pushbutton causes every other trace to be displaced vertically. The 1st and 2nd local oscillator frequencies shift so that real, or true, signals are not displaced horizontally on alternate sweeps (1/2 division), while spurious signals can be shifted to more than 100 MHz or even off screen. The FREQ SPAN/DIV must be 50 kHz or less before the identify mode can be used.

Page 4-15

56 MIN NOISE/MIN DISTortion

MIN NOISE (pushbutton lit) — In this mode, the noise level is reduced by changing the RF attenuation and IF gain used for a particular reference level. Both are reduced 10 dB so noise generated in the IF stages is decreased; however, intermodulation distortion products will increase. RF attenuation must be at least 10 dB for this control to have any effect. **This is the usual operating mode.**

MIN DISTortion (pushbutton not lit) — In this mode, intermodulation distortion products are minimized. . . .

Page 4-16

- 57 *MANUAL PEAK (PEAKING)* — This control peaks the internal preselector tracking. . . . The control is used to peak signal response.
- 58 <SHIFT> *PEAK MENU* — This pushbutton sequence calls up a menu that lists the available methods to adjust the preselector tracking. The *MANUAL PEAK* control can be selected, peaking code can be stored in memory, and then used in the selected band; a number of 0 to 1023 can be run that replaces the stored peak value for a particular band. The peak code consists of numbers at 500 MHz intervals.

Page 4-23

- 96 *RF INPUT 50 Ω* — This 50 Ω coaxial input connector is for RF signals to 21 GHz. If the input signal has a dc component, use a blocking capacitor in line with the signal.

CAUTION

. . .

The maximum rating of the RF attenuator is +30 dBm (1 W average, 75 W peak pulse width 1 ms or less with a duty cycle that does not exceed 0.001). Burn-out occurs above 1 W. If *MIN NOISE* is activated and the *RF ATTEN* is 60 dB, the +30 dBm rating will be exceeded if the signal level is increased a full-screen display. Under these conditions the input level will be +40 dBm. Reduce the level of high-powered signals with external attenuators. Input signals to the mixer must not contain any dc component. Refer to Signal Application in Section 6.

Page 6 of 10

- 97 *CAL OUT (Calibrator output)* — This connector is the source of a calibrated -20 dBm, ± 0.3 dB, 100 MHz signal and a comb of frequency markers 100 MHz apart. This 100 MHz source is the instrument reference frequency. In Option 07 instruments using 50Ω input, the signal is the same as the standard instrument, and using the 75Ω input, the signal is $+20$ dBmV, ± 0.6 dB.

Page 4-25

107 ... completely removed

Section 5

Page 5-2 (left column, first paragraph)

The spectrum analyzer operating functions and modes will initialize to the following power-up states.

REF LEVEL	0 DBM
CENTER FREQUENCY	900 MHZ
MARKER FREQUENCY	0 MHZ
SPAN/DIV	MAXimum
VERT DISPLAY	10 DB/
RF ATTENUATION	20 DB
FREQ RANGE	0 to 1.8
RESOLUTION BANDWIDTH	3 MHZ
TRIGGERING	FREE RUN
AUTO RES	On
DIGITAL STORAGE	VIEWA/VIEWB On
MIN NOISE	On
All other pushbuttons	Inactive or Off

(right column, second and third paragraphs)

To see the results after the spectrum analyzer has completed a calibration routine, press the <SHIFT> 1 sequence. A message will appear on screen that shows the correction factors used by the spectrum analyzer to center the resolution bandwidth filters to produce a calibrated center frequency. It also shows the correction that was required to bring the amplitude level within 0.4 dB of the 3 MHz filter amplitude.

Press the <SHIFT> CAL sequence to start the calibration routine. Prompt messages on the screen will guide you through setting the four front-panel adjustments of vertical and horizontal POSITION and AMPL and LOG CAL. This sets the absolute reference level for the 3 MHz resolution bandwidth filter. An automatic calibration is then done, which measures and corrects for absolute frequency and amplitude (relative to 3 MHz) errors of the filters. This takes approximately 60 seconds. If a message appears on the screen, refer to Error Message Readout earlier in this section. The correction factors are held in memory. Press FINE to continue calibration as instructed or either SHIFT pushbutton to exit the routine.

Page 5-3

Preliminary Preparation

Perform the procedure described under Preparation for Use, then allow the instrument to warm up for at least 30 minutes before proceeding with this check.

Page 5-5

RESOLUTION BANDWIDTH — As this control is rotated from a fully counterclockwise position, the resolution bandwidth changes in decade steps from 1 kHz to 1 MHz and 3 MHz.

Page 5-7

REPEAK/PEAK Menu — This dual-function pushbutton selects Repeak or when <SHIFT> is pushed, PEAK MENU.

If the spectrum analyzer is operating in the preselector bands (1.7-21 GHz) the preselector initiates a peaking routine on any signal within the center two divisions of the screen. . . . The peak code consists of numbers at 500 MHz intervals. The algorithm will peak the preselector tuning for this center frequency setting, then store this peak setting in battery-operated memory. If a signal is not on screen, the algorithm will revert to the code that was previously stored in memory; or, if there is no settings, to the mid point of the peaking range. After a setting for a band has been stored, you can switch between preselector bands with the assurance that the preselector is peaked well enough to track the oscillator and provide reasonable sensitivity.

Page 5-9 (right column, step (h))

(h) Press <SHIFT> dB BW, and enter 10 with the DATA ENTRY pushbuttons. Press BANDWIDTH and observe that the Delta MKRs have moved down 10 dB from the top of the signal. Delta frequency is a little over 1 MHz wide. . . .

Page 5-10 (left column, step 2)**2. Check Gain Variation Between Resolution Bandwidths**

(less than 0.4 dB with respect to the 3 MHz filter and less than 0.8 dB between any two filters)

- a. Calibrate the Center/Marker Frequency and Reference Level . . . as described earlier in this section.
- b. Set the FREQUENCY readout to 100 MHz by pressing <SHIFT> FREQ 1 0 0 MHz with the DATA ENTRY pushbuttons. Set the FREQUENCY SPAN/DIV control to 500 kHz, the RESOLUTION BANDWIDTH to 3 MHz, the REFERENCE LEVEL control to -20 dBm, and TIME/DIV to AUTO
- c. Apply 100 MHz markers from the CAL OUT connector to the RF INPUT. Set the Vertical Display factor to 1 dB/DIV by <SHIFT> dB/DIV 1 dB
- d. Adjust the AMPL CAL control for a 100 MHz signal 7 divisions high.
- e. Activate SAVE A. This is the reference for checking the other filters.
- f. Change the RESOLUTION BANDWIDTH control to 1 MHz and SPAN/DIV to 100 kHz.
- g. Check the amplitude of the 100 MHz signal. It should be within 0.4 dB of the 3 MHz reference established in part 3.
- h. Set the RESOLUTION BANDWIDTH control to each of the remaining positions and the FREQ SPAN/DIV readout for a readable display. The amplitude accuracy and frequency can now be checked with respect to the 3 MHz reference and between any two filters. Reference level error should not exceed 0.4 dB from the reference and 0.8 dB between any filter.
- i. Turn SAVE A off and perform the front-panel calibration procedure by pressing <SHIFT> CAL.

Page 5-10 (right column, step 3.d)

d. Linearity is accurate when the displacement of successive markers, over the center eight divisions, does not exceed 5% of 100 MHz (the FREQ SPAN/DIV setting) or 0.4 division.

(right column, step 4)

4. Check Resolution Bandwidth and Shape Factor

(bandwidth is within 20% of the selected 3 MHz to 1 kHz range, in decade steps; shape factor is 7.5:1 or less)

- a. With the Calibrator output applied to the RF INPUT and the FREQUENCY readout at 100 MHz, set the REFERENCE LEVEL control to -20 dBm, the FREQ SPAN/DIV control to 1 MHz, RESOLUTION BANDWIDTH to 3 MHz, TIME/DIV to AUTO, VERTICAL DISPLAY to 2 dB/div, and activate MIN NOISE.
- b. Measure the 6 dB down bandwidth (see Figure 5-5A). Bandwidth should equal 3 MHz, ± 600 kHz.
- c. Change VERTICAL DISPLAY to 10 dB/div and measure the 60 dB down bandwidth (see Figure 5-5B).
- d. Calculate the shape factor as the ratio of -60 dB/-6 dB bandwidths (see Figure 5-5). Shape factor should equal 7.5:1 or less.
- e. Change the RESOLUTION BANDWIDTH setting to 1 MHz and the FREQ SPAN/DIV to 500 kHz.
- f. Check the resolution bandwidth and shape factor of the 1 MHz filter by repeating the above process.
- h. Repeat the process to check the resolution bandwidth and shape factor for the 100 kHz, 10 kHz, and 1 kHz filters. Shape factor should equal 7.5:1 for all.

Page 5-12 Table 5-1

SENSITIVITY
Equivalent Input Noise (dBm) Versus Resolution Bandwidth

Frequency	3 MHz	1 MHz	300 kHz	100 kHz*	10 kHz	1 kHz
50 kHz to 1.8 GHz	-75	-80	-85	-90	-100	-110
1.7 GHz to 7.1 GHz	-73	-78	-83	-88	-98	-108
5.4 GHz to 12 GHz	-59	-64	-69	-74	-84	-94
12 GHz to 18.0 GHz	-54	-59	-64	-69	-79	-89
15.0 GHz to 21.0 GHz	-53	-58	-63	-68	-78	-88

* Option 07 replaces the 100 kHz filter with a 300 kHz filter.

(left column, step 6)

a. Remove the calibrator signal from the RF INPUT. Set VERTICAL DISPLAY to 2 dB/DIV, REF LEVEL readout to -75 dBm, FREQ SPAN/DIV readout to MAX, the RESOLUTION BANDWIDTH control to 3 MHz, and the TIME/DIV control to 1 second. Adjust the PEAK/AVERAGE cursor so it is off the top of the screen and activate the NARROW VIDEO FILTER.

b. Activate TUNE MKR and adjust the CENTER/MARKER FREQUENCY control to tune the marker to the highest point on the noise floor. Activate ZERO SPAN and check that the average noise is less than full screen.

- c. Change the REFERENCE LEVEL control to -80 dBm . . . and the RESOLUTION BANDWIDTH control to 1 MHz.
- d. Check that the **average of the noise floor is less than full screen.**
- e. Change the REFERENCE LEVEL control to -90 dBm . . . and the RESOLUTION BANDWIDTH control to 100 kHz.
- f. Check that the average noise level for the 100 kHz resolution bandwidth is **less than full screen.**
- g. Continue checking the sensitivity for each RESOLUTION BANDWIDTH as listed in Table 5-1.

(left column, step 7.c.)

c. Decrease the FREQUENCY SPAN/DIV to 50 kHz and RESOLUTION BANDWIDTH setting to 100 kHz. Keep the 100 MHz calibrator signal centered on the screen with the CENTER/MARKER FREQUENCY control.

Section 6

Page 6-2 (left column, second paragraph)

. . . completely removed

Page 6-4 (left column, first paragraph under Using the Signal Identifier)

. . . completely removed

Page 6-5 (left column)

Using Time Domain Operation

When the FREQ SPAN/DIV is zero, the spectrum analyzer functions as a tunable receiver to display time domain characteristics within the selected resolution bandwidth. Characteristics like modulation pattern and pulse repetition rates can now be analyzed with TIME/DIV selections. Resolution bandwidth is usually maximum (3 MHz) for time domain analysis of the signal.

Section 7

Pages 7-2 and 7-3 Option 01

. . . completely removed

Appendix A

There are no changes

Free Manuals Download Website

<http://myh66.com>

<http://usermanuals.us>

<http://www.somanuals.com>

<http://www.4manuals.cc>

<http://www.manual-lib.com>

<http://www.404manual.com>

<http://www.luxmanual.com>

<http://aubethermostatmanual.com>

Golf course search by state

<http://golfingnear.com>

Email search by domain

<http://emailbydomain.com>

Auto manuals search

<http://auto.somanuals.com>

TV manuals search

<http://tv.somanuals.com>