



---

# User's Manual

[www.vtechphones.com](http://www.vtechphones.com)



Model: i6765

Download from [Www.Somanuals.com](http://www.Somanuals.com). All Manuals Search And Download.

**5.8**  
GHz  
DIGITAL

# Table of contents

<b>Getting started</b> . . . . .	<b>4</b>	Find handset . . . . .	16
Parts checklist . . . . .	4	Directory . . . . .	17
Installation . . . . .	5	Store a new entry . . . . .	17
Choose a location . . . . .	5	Characters by number . . . . .	18
Install handset battery . . . . .	5	Review/dial from the directory . . . . .	19
Connect power to base unit/chargers . . . . .	6	Edit a directory entry . . . . .	19
Check battery indicator . . . . .	7	Delete a directory entry . . . . .	20
Check for dial tone . . . . .	7	Caller ID . . . . .	21
If you subscribe to DSL service . . . . .	8	Caller ID - call waiting ID . . . . .	21
Belt clip . . . . .	8	Review caller ID . . . . .	22
Wall mounting . . . . .	9	Store caller ID . . . . .	22
Handset layout . . . . .	10	Dial from caller ID . . . . .	24
Base unit layout . . . . .	11	Delete caller ID . . . . .	24
<b>Basic operation</b> . . . . .	<b>12</b>	Handset settings . . . . .	25
Handset icons . . . . .	12	Ringer volume . . . . .	25
Handset LEDs . . . . .	12	Ring tone . . . . .	25
Base LEDs . . . . .	12	Key tone . . . . .	25
Handset operation . . . . .	13	Handset name . . . . .	25
Making calls . . . . .	13	Language . . . . .	26
Answering calls . . . . .	13	Clear voicemail . . . . .	26
Adjust handset volume . . . . .	13	Dial type . . . . .	26
Flash function . . . . .	13	Answering system operation . . . . .	27
Redial . . . . .	13	Turn your answering system off and on . . . . .	27
Mute . . . . .	14	Day and time announcements . . . . .	27
Intercom . . . . .	14	To check day and time . . . . .	28
Call forward . . . . .	15	Outgoing announcement . . . . .	29
Call transfer . . . . .	16	Record outgoing announcement . . . . .	29
Conference call . . . . .	16	Menu features . . . . .	29

## Table of contents

Listen to outgoing announcement . . . . .	30	Important safety instructions . . . . .	51
Message playback . . . . .	31	FCC, ACTA and IC regulations . . . . .	52
Announcements . . . . .	31	Technical specifications . . . . .	54
Options during playback . . . . .	31	Index . . . . .	55
Delete all messages . . . . .	32		
Record and play memos . . . . .	32		
Record a memo . . . . .	32		
Playback a memo . . . . .	32		
Call screening . . . . .	33		
Set remote access . . . . .	33		
Remote access. . . . .	34		
Message alert . . . . .	36		
Announcement only mode . . . . .	36		
Turn announcement only mode off or on . . . . .	36		
Customize announcement only message . . . . .	37		
Base ringer. . . . .	37		
Toll saver . . . . .	37		
Message window display . . . . .	39		
Headset operation . . . . .	40		
Headset operation . . . . .	40		
Operating range . . . . .	40		
Batteries . . . . .	41		
Battery care and performance. . . . .	41		
Replace the handset battery. . . . .	41		
<b>Additional information . . . . .</b>	<b>42</b>		
Troubleshooting . . . . .	42		
Maintenance . . . . .	49		
Warranty . . . . .	49		

# NEED HELP?

This manual has all the feature operations and troubleshooting you need to install and operate your new VTech telephone. Please take the time to review this manual thoroughly to ensure proper installation of this VTech innovative and feature rich product. You can also visit our website at [www.vtechphones.com](http://www.vtechphones.com) for support, shopping, and everything new at VTech. In Canada, please visit [www.vtechcanada.com](http://www.vtechcanada.com).

VTech toll free 1-800-595-9511  
In Canada dial 1-800-267-7377

## note

- Before using this telephone, please read the **Important Safety Instructions** on page 51.

## Getting started

### Parts checklist:

1. Telephone base
2. Handsets (2)
3. Charger power adaptors
4. Chargers
5. Telephone line cord
6. Wall mount bracket
7. Belt clips (2)
8. Quick start guide
9. Base power adaptor
10. Batteries (2)
11. User's manual

To purchase replacement batteries, visit us on the web at [www.vtechphones.com](http://www.vtechphones.com) or call VTech Communications, Inc. at 1-800-595-9511. In Canada, contact VTech Telecommunications Canada Ltd. at [www.vtechcanada.com](http://www.vtechcanada.com) or 1-800-267-7377.

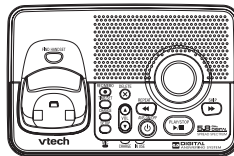

1. Telephone base



2. Handsets (2)

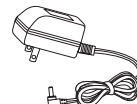

3. Charger power adaptors

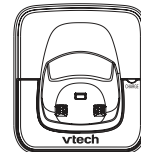

4. Chargers

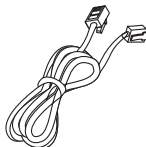

5. Telephone line cord

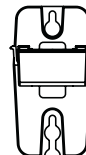

6. Wall mount bracket



7. Belt clips (2)



8. Quick start guide

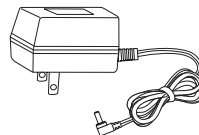

9. Base power adaptor



10. Batteries (2)



11. User's manual

## Installation

### Choose a location

For maximum performance of your cordless telephone system:

1. Choose a central location for your base unit.
2. Install your base unit and extension handset away from electronic equipment such as personal computers, television sets and microwave ovens.
3. In locations where there are multiple cordless telephones, separate base units as far as possible from each other.
4. Install your telephone equipment away from heat sources and direct sunlight.
5. Avoid excessive moisture, dust or extreme cold.

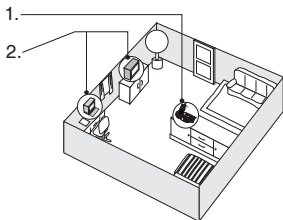

### Install handset battery

1. Align the two holes in the plug with the socket pins, then snap the plug into place.
2. Place the battery in the compartment with the wires in the upper right corner.
3. Replace cover by sliding it upwards until it clicks into place.
4. Be sure to charge the battery for 16 hours before using your phone.

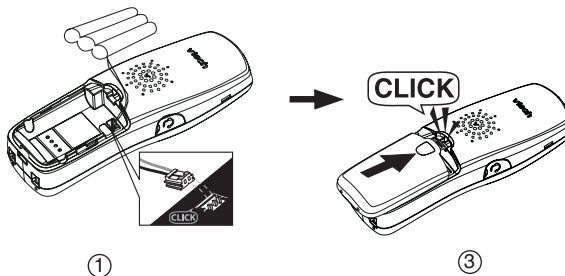

### note

- Use only the provided VTech battery, or equivalent.
- Place the handset in its base or charger when not in use to ensure optimum performance.
- CAUTION: To reduce the risk of fire or injury, read and follow these instructions:
  1. Use only the battery supplied, or equivalent.
  2. Do not open or mutilate the battery. Released electrolyte is corrosive and may cause damage to the eyes or skin. It may be toxic if swallowed.
  3. Exercise care in handling battery in order not to short the battery with conducting materials such as rings, bracelets, and keys. The battery or conductor may overheat and cause burns.

## note

- Connect the power and telephone line cords to the underside of the base as illustrated.
- Plug the AC adaptor into an electrical outlet. If the battery has not been charged, place the handset in the base or charger, and allow it to charge for at least 16 hours.
- Caution: Use only the VTech power supply provided with your phone.

## Installation

### Connect power to base unit/chargers

1. Plug the power adapter into an electrical outlet not controlled by a wall switch, and the connector into the bottom of the base unit.
2. Choose the location for your charger, and plug its power supply into an electrical outlet.

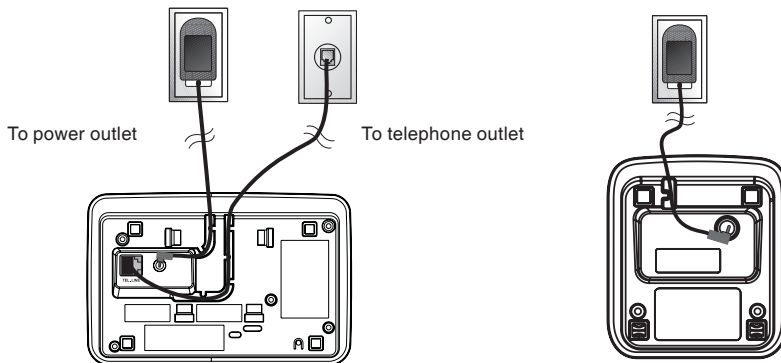

### Connect to phone line

Plug one end of the telephone line cord into the telephone line jack at the bottom of the telephone base. Then plug the other end of the cord into the wall telephone outlet.

# Installation

## Check battery indicator

If you receive a check battery warning, it indicates one of the following:

1. There is no battery in your handset. You need to install the supplied battery into your handset (see **Install handset battery** on page 5.)
2. The battery needs to be replaced.
3. The battery has been installed incorrectly. Please reinstall (see **Install handset battery**) and/or see the diagram in the battery compartment of the handset.

## Check for dial tone

After the battery is charged, press  on the handset. You should hear a dial tone. If not, see **Troubleshooting**.

### note

- If the phone will not be used for a long period of time, remove the battery to prevent possible leakage.
- If you have any trouble installing your phone, please refer to the **Troubleshooting** section near the end of this manual.
- When in low battery mode, the keypad sounds, backlighting and speakerphone features will not work. When the battery has been charged, these features will return to their normal function.



## Installation

### If you subscribe to DSL service

If you hear interference during conversations and/or your caller ID features are not functioning properly, install a noise filter to the telephone line between the base unit and the telephone line jack. Contact your DSL provider to obtain a noise filter.

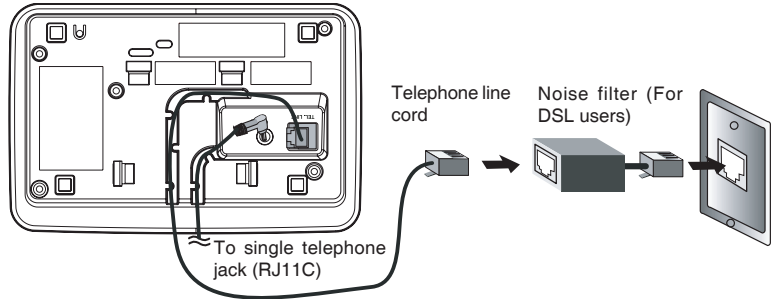

### Belt clip (optional)

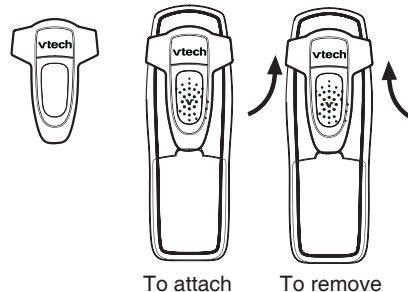

## Wall mounting (optional)

The wall mount brackets are designed for use on standard wall mount plates only.

1. Plug the connector of the base power adaptor to the connector jack at the bottom of the base unit. Then plug the adaptor into an electrical outlet.
2. Connect the telephone line cord to the jack at the bottom of the base unit, and the other end to the wall jack.
3. Line up the tabs on the wall mount adaptors with the holes at the bottom of the base unit/back of the charger. Snap the wall mount bracket firmly in place.
4. Mount the base unit on the wall. Position the base unit so that the mounting studs will fit into the holes on the wall mount bracket. Slide base unit down on the mounting studs until it locks into place.

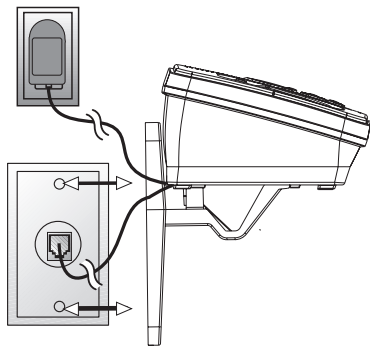

## Handset layout

1. Earpiece
2. Headset jack (2.5mm)
3. CID (scroll down)
4. Talk/flash
5. Dialing keys (0-9, \*, #)
6. Redial/pause
7. Speaker
8. LCD display
9. Directory (scroll up)
10. Volume control
11. Menu/select
12. Off/clear
13. Intercom
14. Mute/remove

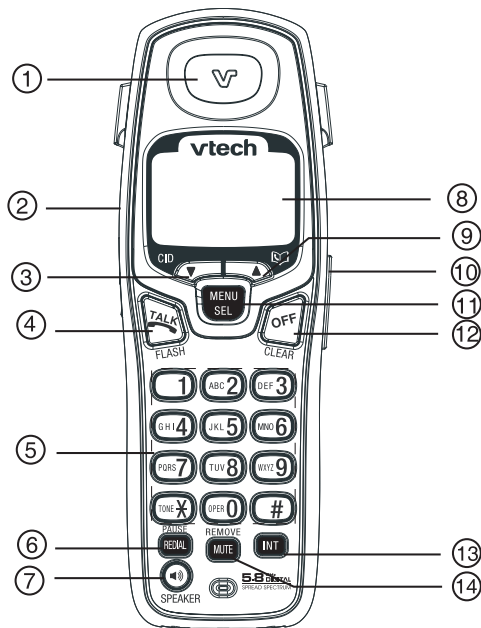

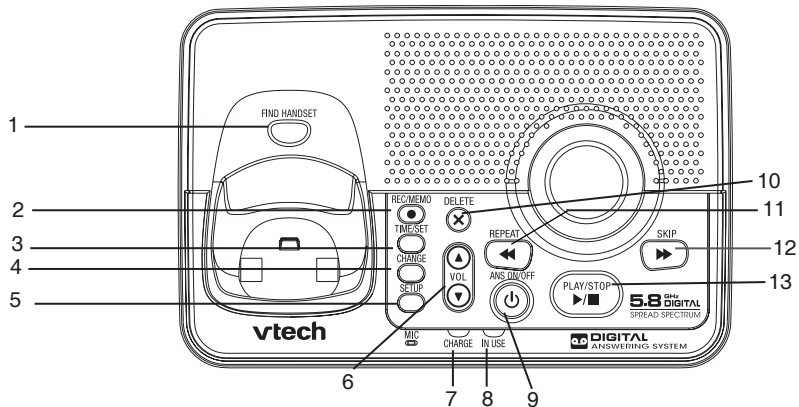

## Base unit layout



- |                   |                       |
|-------------------|-----------------------|
| 1. Find handset   | 10. Delete            |
| 2. Record/memo    | 11. Repeat            |
| 3. Time/set       | 12. Skip              |
| 4. Change         | 13. Mailbox play/stop |
| 5. Setup          |                       |
| 6. Volume control |                       |
| 7. Charging LED   |                       |
| 8. In use LED     |                       |
| 9. Answer on/off  |                       |

## Basic operation

### Handset icons

Icon	Description
MUTE	<ul style="list-style-type: none"><li>On when the microphone is muted.</li></ul>
NEW	<ul style="list-style-type: none"><li>On when there are new call log entries.</li></ul>
	<ul style="list-style-type: none"><li>On when the handset ringer is muted.</li></ul>
	<ul style="list-style-type: none"><li>Low battery indicator or charging indicator.</li></ul>

### Handset LEDs

LED	Description
	<ul style="list-style-type: none"><li>On when in handsfree mode.</li></ul>

### Base LEDs

LED	Description
IN USE	<ul style="list-style-type: none"><li>On when the phone is off the hook.</li><li>Flashes when an extension phone is off the hook.</li></ul>
CHARGE	<ul style="list-style-type: none"><li>On when the handset is charging in the base.</li></ul>
ON/OFF	<ul style="list-style-type: none"><li>On when the answering system power is on.</li></ul>

# Handset operation

## Making calls

- Press **TALK** (or **SPEAKER** to use the handset speakerphone feature), then dial the phone number.

-OR-

Dial the phone number first, then press **TALK** (or **SPEAKER**).

- Press **OFF** to end your call or place the handset in its base or charger.

## Answering calls

- Press **TALK**, **SPEAKER** or any dialing keys.
- Press **OFF** to end your call or place the handset into its base or charger.

## Adjust handset volume

The volume control is on the side of the handset. During a call, press the **VOLUME** + or - keys to adjust the listening volume to a comfortable level. When you reach the maximum or minimum setting, a double beep will sound.

## Flash function

When you subscribe to call waiting service from your telephone company, press **TALK** to switch to the new call when you receive a call waiting signal. Press **TALK** again to switch back to the original call.

## Redial

- Press **REDIAL/PAUSE** to display the last telephone number dialed from the handset (up to 32 digits). Use **▲** or **▼** to scroll through the last five numbers dialed. When the beginning or the end of the redial list is reached, a double beep will sound.

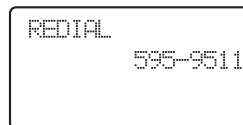
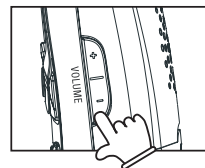
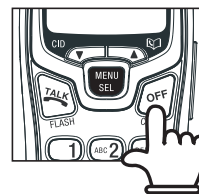
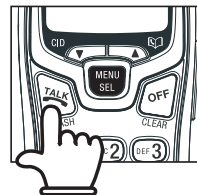

## note

- The procedure to change the volume is the same for the handset earpiece, speakerphone and headset.
- Use **TALK** to access phone company subscriber services, as described by your provider.
- If the redial memory is empty, and **REDIAL** is pressed, a double beep will sound.

## Handset operation

- Press **OFF** to exit the redial review list.
- When the desired number is reached, press **TALK** or **SPEAKER** to dial.
- When the desired entry displays, press **MUTE/REMOVE** to delete it. You'll hear a confirmation beep.

### Mute

- During a call, press the **MUTE/REMOVE** key to disable the microphone. The screen will briefly display **MUTED**:
- Press **MUTE/REMOVE** again to return to normal two-way conversation. **MICROPHONE ON** will briefly display.

### Intercom

- Press **INT** on the originating handset (HS1) and **CALL OTHER HANDSET** will show on the screen.
- The destination handset (HS2) will show **OTHER HANDSET IS CALLING**.
- Press **INT**, **TALK**, **SPEAKER**, or any dialing key on HS2 to pick up the call. The display will change to **INTERCOM**.

```
PHONE    00:00:15
          MUTED
MUTE
```

```
PHONE    00:00:15
MICROPHONE ON
```

```
CALL OTHER
HANDSET
```

```
OTHER HANDSET
IS CALLING
```

```
INTERCOM
```

## Handset operation

### Intercom (continued)

- Press **INT**, **OFF**, or place HS1 or HS2 back in the base or charger to end the call.

If HS2 is out of range, the screen on HS1 will show **NO SIGNAL CALL ENDED**. If HS2 is off, in use or out of range, HS1 will show **UNABLE TO CALL TRY AGAIN**.

### Call forward

An external call can be forwarded or transferred from one handset (HS1) to another system handset (HS2).

- While HS1 is on an external call, you can forward the call to HS2 by pressing and holding **INT**. **CALL FORWARDED** will display on HS1.
- HS2 will begin ringing and display **INCOMING CALL**.
- Press **TALK/FLASH** on HS2 to answer the call.

If the forwarded call is not answered within 30 seconds, the external call will be returned to HS1 and the screen will display **CALL BACK** and ring for 30 seconds. If the returned call is not answered within 30 seconds, the external call will end automatically.

INTERCOM ENDED

UNABLE TO CALL  
TRY AGAIN

CALL FORWARDED



## note

- For the **FIND HANDSET** function to work, the system handsets need to be in idle (off) mode.

## Handset operation

### Call transfer

- The originating handset (HS1) can transfer an external call to another handset (HS2) by pressing **INT**. The external call is put on hold and the screen will display **CALLING OTHER HANDSET**.
- HS2 will ring and display **OTHER HANDSET IS CALLING**.
- HS2 can pick up the transferred call by pressing **TALK/FLASH**.
- An intercom call is established between HS1 and HS2 and they can discuss the call prior to the external call being transferred to HS2. **CALL TRANSFERRED** will display on the HS1.

If the transferred call is not answered within 100 seconds, the external call will be returned to HS1.

### Conference call

It is possible to establish a conference call between two handsets and the external line.

While HS1 is on an external call, HS2 can join the call by pressing **TALK**. A conference call will be established.

PHONE 00:00:25

### Find handset

- To locate a misplaced handset, press **FIND HANDSET** on the base to page all system handsets.
- To end the page at the base, press **FIND HANDSET** again.
- To end the page at the handset, press **TALK**, **SPEAKER**, **OFF** or any dial pad key (0-9, \*, #).

\*\* PAGING \*\*

# Directory

Your phone can store up to 50 numbers with names in the directory. Each directory location can hold up to 32 digits for the number and 16 characters for the name. When one handset is accessing the directory, no other system handsets can access it. If this is attempted, **NOT AVAILABLE AT THIS TIME** will be displayed on the second handset.

## Store a new entry

- Press **MENU**.
- With **DIRECTORY** selected, press **SEL**.
- Press **▼** to select **STORE**. Press **SEL**.
- You will be prompted to **ENTER NUMBER**. Use the dialing keys to enter the number you wish to store in the directory. Press the **MUTE/REMOVE** key to backspace and make corrections. Press **SEL**.
- You will then be prompted to **ENTER NAME**. Use the dialing keys to spell the name. Press **SEL**.
- You'll hear a confirmation tone, and the new directory entry will briefly be displayed.
- If the directory is full, the handset will display **LIST FULL**.

```
>STORE REVIEW
```

```
ENTER NUMBER  
800-595-9511_
```

```
ENTER NAME  
_
```

```
LIST FULL
```

## note

- All handsets share a common directory which is stored in the base. Entries inserted into one handset are available for all handsets, and if one deletes a directory entry, it will disappear from all handsets.
- While entering numbers, press and hold **REDIAL/PAUSE** to add pauses if necessary.
- If there is a duplicated number in directory, the display will show: **ALREADY SAVED**.

## note

- If you wish to store a number from redial memory into the directory, press **REDIAL/PAUSE** then ▲ or ▼ to scroll to the desired redial number from memory. Press **SEL**.

## Directory

### Characters by number

Pressing any particular key causes different characters to be displayed in the following order:

Key	Characters by number of key presses								
	1	2	3	4	5	6	7	8	9
1	1	#	'	,	-	.	&		
2	A	B	C	2	a	b	c		
3	D	E	F	3	d	e	f		
4	G	H	I	4	g	h	i		
5	J	K	L	5	j	k	l		
6	M	N	O	6	m	n	o		
7	P	Q	R	S	7	p	q	r	s
8	T	U	V	8	t	u	v		
9	W	X	Y	Z	9	w	x	y	z
0	0								
✖	✖	?	!	/	(	)	@		
#									

**note**

- When reviewing the directory, the second line of the display will show the number, up to 16 digits. For numbers longer than 16 digits, only the first 13 digits will be shown. Press **★** or **#** to scroll the phone number to see the additional digits.
- If there are no entries in the directory, when it is accessed, **DIRECTORY EMPTY** will display.

# Directory

## Review/dial from the directory

- Press **MENU**, with **DIRECTORY** is displayed, press **SEL**. With **REVIEW** in the first line, press **SEL**.

**-OR-**

With the handset in idle, press **▲** to enter the directory review mode. The first directory entry will be displayed.

- Scroll through the directory entries using **▲** and **▼** or enter the first character of the name to be searched (using the digit keys). Continue navigating using the **▲** or **▼** scroll keys, until you reach the entry to be dialed.
- Press **TALK** or **SPEAKER** to dial the number.

## Edit a directory entry

- Follow the steps in **Review/dial from the directory** (above) to reach the entry to be edited.
- Press **SEL** to enter number edit mode.
- Press **MUTE/REMOVE** to backspace and delete numbers, or press **CID ▼** or **DIR ▲** to move the cursor to the number you wish to change. Then re-enter the correct number(s) by pressing the dialing keys (0-9). Press and hold **REDIAL/PAUSE** to add pauses if necessary.

```
>DIRECTORY
CALL LOG
```

```
EDIT NUMBER
800-595-9511_
```

## Directory

- Press **SEL**.
- Press **MUTE/REMOVE** to backspace and use the digit keys to enter the correct name.
- Press **SEL**. You'll hear a confirmation tone.

```
EDIT NAME  
VTech Con_
```

### Delete a directory entry

- Follow the steps in **Review/dial from the directory** (page 19) to reach the entry to be deleted.
- Press **MUTE/REMOVE** to delete the entry. A confirmation tone will sound.
- The handset will then advance to the next entry, if any.

# Caller ID

## Caller ID - call waiting ID

Your phone is capable of displaying the number of the calling party before you answer the phone (**caller ID** or **CID**). If the number is already in the directory, the name of the caller will also be displayed. It is also capable of displaying CID information in conjunction with a call waiting alert signal (**call waiting caller ID**). With **call waiting caller ID**, the CID data is displayed so you can decide whether to answer the incoming call, or continue with your current conversation. Your phone can hold up to 50 CID entries.

**NOTES ABOUT CALLER ID & CALL WAITING CALLER ID** These are subscription services, provided by most regional telephone service providers. You must subscribe to these services to get the benefits of these features. If you do not subscribe to CID services, you can still use your phone and the other features it offers.

Due to regional incompatibilities, CID information may not be available for every incoming call. In addition, the calling parties may intentionally block their name and/or phone number from being sent.

- As new CID/call waiting ID records are received, your handset displays will alert you to the new CID records, for example:

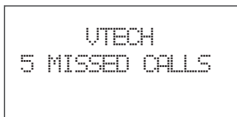

VTECH  
5 MISSED CALLS

- After you review all new CID records, the **NEW** call indicator will be turned off and the screen will show:

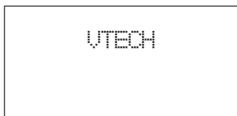

VTECH

### note

- If you answer a call before the information appears on the screen, it will not be in the caller ID log.
- Press **OFF** any time to exit caller ID log.
- The **NEW** icon in the lower left corner indicates the call has not yet been reviewed.

## Caller ID

- If the call log is full, the oldest entry is deleted to make room for the new call. If the call log is empty when you try to enter to call log review, the following message is displayed:

CALL LOG EMPTY

### Review caller ID

You can review the CID records via the menu as described below, or by pressing ▼ while in idle, and the handset moves directly to CID review.

- In idle mode, press **MENU**.
- Press ▼ to scroll to the **CALL LOG** option.
- Press **SEL**. Use ▲ and ▼ to scroll through the call log entries. When the beginning or the end of the call log is reached, a double beep will sound.

XCALL LOG  
RINGER VOLUME

### Store caller ID

- Follow the steps in **Review caller ID** to scroll to the record to be stored.
- To view alternate dialing sequences, press the # key repeatedly. The screen will scroll through the various dialing options (1 + area code + number, area code + number, 1 + number, number only). Press **SEL** to store the displayed number. The dialing options are:
  - If the CID record contains both name and number, the CID will be stored after pressing **SEL**.
  - If the CID record does not contain a name, you will be prompted to **EDIT NAME** and the screen will show:

595-9511  
1-595-9511  
800-595-9511  
1-800-595-9511

EDIT NAME  
Vtech Com\_

## Caller ID

- If the CID record does not contain a number, you will be prompted to **EDIT NUMBER**, and the screen will show:
- A confirmation beep will sound and the screen will display:
- If both name and number are missing, for example, as in a private listing, the request will be rejected with the message:
- If the number already exists in the directory, the entry will not be stored, and the screen will show:
- If the directory is full, the screen will show:



EDIT NUMBER  
800-595-9511\_



SAVED



UNABLE TO SAVE



ALREADY  
SAVED



LIST FULL



## Caller ID

### Dial from caller ID

- Follow the steps in **Review caller ID** (page 22) to scroll to the entry to be dialed.
- To change how the number will be dialed, press # repeatedly. The screen will scroll through the dialing options: Press <sup>Talk</sup> /FLASH or the **SPEAKER** key to dial the number.

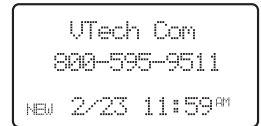

### Delete caller ID

- Follow the steps in **Review caller ID** (page 22) to scroll to the record to be deleted.
- Press the **MUTE/REMOVE** key to delete the desired record. A confirmation beep will sound and the previous CID record will be displayed on the screen.
- To delete all the CID records, press and hold the **MUTE/REMOVE** key. The screen will ask if you want to **DELETE ALL CALLS?** Press **SEL** to confirm. Press **OFF** to return to the CID record previously displayed.



# Handset settings

## Ringer volume

- From the idle (off) mode, press **SEL** then ▲ or ▼ until **RINGER VOLUME** is shown.
- Press **SEL**. The current ringer volume will be shown:
- Press ▲ and ▼ or enter a digit (0 through 6) to the desired ringer volume. The current ring tone will play and the volume bar is increased or decreased each time the setting is adjusted. At the lowest setting the display will show:  
-OR-
- From idle (off) mode, press +/- volume control keys on the side of handset will directly go to the **RINGER VOLUME** menu.
- Press ▲ and ▼ to the desired ringer volume. Ringer volume will be adjusted.

## Ring tone

- From the idle (off) mode, press **SEL** then ▲ or ▼ until **RINGER TONE** is displayed.
- Press **SEL**. You can then use ▲ or ▼ or enter a digit (0 through 9) to sample the ring tone.
- Press **SEL** to confirm.

## Key tone

- From the idle (off) mode, press **SEL** then ▲ or ▼ to **KEY TONE**.
- Press **SEL**. The current setting will be shown. Press ▲ or ▼ to scroll to **ON** or **OFF**. When set to **ON**, the handset will emit a beep whenever a key is pressed.
- When the desired option is shown, press **SEL**.

## Handset name (preset to VTECH)

- You can give each handset its own unique name (such as kitchen or office). The name is shown in the first line when the handset is idle. The name can be a up to 16 characters in length.

```
>RINGER VOLUME
RINGER TONE
```

```
RINGER VOLUME
■■■■■
```

```
RINGER VOLUME
```



```
>RINGER TONE
KEY TONE
```

```
KEY TONE
OFF
```

```
HANDSET NAME
VTECH_
```

## note

- The handset will not ring when a call comes in if ringer volume is in the lowest setting.

## note

- The clear voicemail function only cancels the voicemail indicator on the screen of the handset.
- When the phone is set for pulse dial mode, it is possible to switch to temporary tone mode during an ongoing call by pressing **\*TONE**. Once pressed, tone will be used for rest of the call. After you hang up, the phone will return to pulse dialing for the next call.

## Handset settings

- From idle (off) mode, press **SEL** then **▲** or **▼** to **HANDSET NAME**.
- Press **SEL**. The display will show the current setting, for example:
- Press **DELETE** to backspace then enter the desired name.

**NOTE:** The characters are entered in the same way as for the telephone directory, see the table on page 18.

- Press **SEL** to confirm.

### Language (preset to English)

- From the idle (off) mode, press **MENU** then **▲** or **▼** to **LANGUAGE**.
- Press **SEL**. Press **▲** or **▼** to select from English, Spanish or French.
- Press **SEL** to confirm.

### Clear voicemail

- From the idle (off) mode, press **MENU** then **▲** or **▼** to **CLR VOICEMAIL**.
- Press **SEL**.
- Press **SEL** again to confirm or press **OFF** to exit.

### Dial type (preset to tone)

- From idle (off) mode, press **MENU** then **▲** or **▼** to **DIAL TYPE**.
- Press **SEL** then **▲** or **▼** to scroll to **TONE** or **PULSE**.
- Press **SEL** to confirm.

```
HANDSET NAME  
Kitchen_
```

```
LANGUAGE  
ENGLISH
```

```
>CLR VOICE MAIL  
DIAL TYPE
```

```
TURN INDICATOR  
OFF?
```

```
>DIAL TYPE  
DIRECTORY
```

```
DIAL TYPE  
PULSE
```

# Answering system operation

Your cordless telephone system provides you with leading edge digital technology with an answering system that can record up to 99 messages, or approximately 15 minutes of recording time. Each message can be no longer than four minutes.

## Turn your answering system off and on



Press the **ANS ON/OFF** button on the base to turn the answering system on or off. When the system is on, the **ANS ON/OFF** key will be lit, outgoing messages will be played to the caller, and incoming messages can be recorded.

## Day and time announcements

### To set day and time



Before playing each recorded message, the answering system announces the day and time the message was received. Each time you press **CHANGE**, the day, hour, minute, or year advances by one. When you hear the correct setting, press **TIME/SET** to move to the next setting.

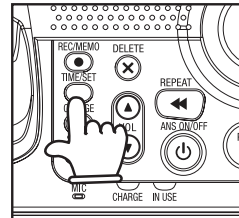
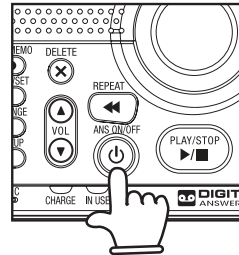

## note

- You can choose to set the time manually following the instruction on this page, or you can allow it to be set automatically with incoming caller ID information. Caller ID is a subscription service, fee required.
- In the event of a power outage, the day and time will need to be reset.

## Answering system operation

Before using the answering system, you should follow the steps to set the day and time, so messages are dated correctly.

1. Press **TIME/SET**, the system announces the current setting.
2. Press **TIME/SET** again.
3. The answering system will announce the day of the current day setting. Press **CHANGE** on the base until you hear the correct setting.
4. Press **TIME/SET**, the system announces the current hour setting.
5. Press **CHANGE** until you hear the correct hour.
6. Press **TIME/SET**, the system announces the current minute setting.
7. Press **CHANGE** until you hear the correct minute.
8. Press **TIME/SET**, the system announces the current year setting.
9. Press **CHANGE** until you hear the correct year.
10. Press **TIME/SET** to confirm, the system will announce the new setting. You'll hear a confirmation tone.

Pressing and holding the **CHANGE** button when setting the time and date will advance the minutes or years by increments of 10.

### To check day and time

Press **TIME/SET** at any time to listen to the current setting without changing it.

# Answering system operation

## Menu features

System Announces	Description
<i>Announcements</i>	Outgoing message to tell callers to leave a message.
<i>Remote access code</i>	Set code to access remotely from a touch tone phone.
<i>Message alert</i>	Beeps every 10 seconds when there are new messages.
<i>Announcement only, record no message</i>	Outgoing message only. No recording of incoming messages.
<i>Base ringer</i>	Turn base ringer on or off.
<i>Number of rings</i>	Answering machine picks up after 2, 4, or 6 rings. (Or set to toll saver mode (see page 37).

## Outgoing announcement

Your telephone answering system is pre-programmed with an announcements for normal (answer and record) mode and for announcement only mode. If the phone is set up to record messages, the phone answers calls with “Hello. Please leave a message after the tone”. You can use this announcement, or replace it with your own recording.

## Record outgoing announcement

1. Press **MENU**, the system announces “Announcement. Press **PLAY** or press **RECORD**. To continue set up, press **SETUP**.”

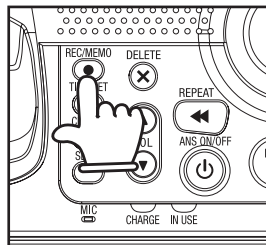

## note

- You can record an announcement for up to 90 seconds. Announcements shorter than 3 seconds will not be recorded.

## Answering system operation

1. Press **REC/MEMO** ●. After you hear “Record after the tone. Press **STOP** when you are done”, speak toward the **MIC** on the base to record an announcement for up to 90 seconds.
2. The elapsed time (in seconds) is shown in the message window when recording.
3. Press **PLAY/STOP** ►/■ when you have finished recording. The system will play back your recorded message and then save it.

### Listen to outgoing announcement

1. Press **SETUP**.
2. Press **PLAY/STOP** ►/■.

### Delete outgoing announcement



1. Press **SETUP**.
2. Press **PLAY/STOP** ►/■ to begin playback.
3. During playback, press **DELETE** X if you wish to delete your announcement.
4. The system will confirm deletion with the prompt “Announcement deleted”.

When your announcement is deleted, calls will be answered with the programmed announcement “Hello. Please leave a message after the tone”.

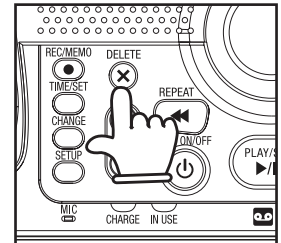
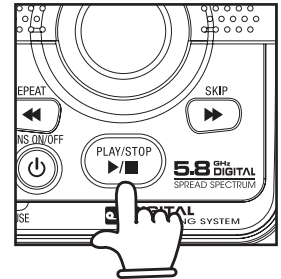

# Answering system operation

## Message playback

Press **PLAY/STOP** ►/■ to listen to new messages. The system will announce the number of new messages recorded and then start playing them. If there are no new messages, all old messages will be played. After the system plays the last message, you'll hear "end of messages".

## Announcements

1. When playback begins, the system announces the total number of messages.
2. Before each message, you will hear the day and time it was received.
3. After the last message, you will hear "end of messages."
4. If the system has less than five minutes of recording time left, the time remaining will also be announced.

## Options during playback

1. Press ▲ and ▼ to adjust the speaker volume.
2. Press **SKIP** ► once to skip to the next message, or press and hold to speed up the message playback, using the voice prompt of day and time as index.
3. Press **REPEAT** ◀ to repeat the message currently playing. Press twice to listen to the previous message, or press and hold to slow down the message playback process.
4. Press **DELETE** X to delete the message currently playing.
5. Press **PLAY/STOP** ►/■ to stop playback.

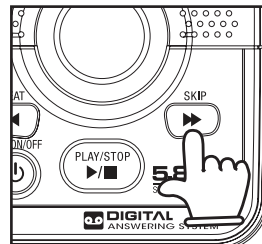
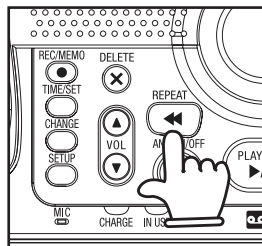



## note

- Memos less than one second will not be recorded. You can record a memo up to four minutes long.

## Answering system operation

### Delete all messages

To delete all messages, press and hold **DELETE X** while the phone is idle (not during a call or message playback) to delete all old messages. New messages will not be deleted.

### Record and play memos

Memos are messages recorded by you or other household members intended for yourself or anyone else who uses the answering system. They are saved, played back, and deleted like incoming messages from other callers.

### Record a memo

1. Press **REC/MEMO ●**.
2. You will hear the voice prompt "Record after the tone. Press **STOP** when you are done".
3. Speak toward the **MIC** on the base to record a memo for up to four minutes.
4. The timer shows the elapsed time (in seconds) in the message window when you are recording.
5. When finished recording, press **PLAY/STOP ►/■** to save the memo. The system announces "Recorded" to confirm.

### Playback a memo

See Section on **Message playback** (page 31) about retrieving memos.

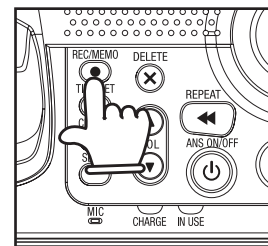
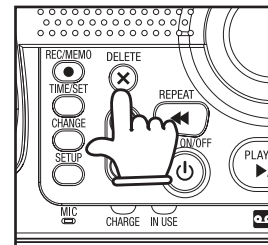

# Answering system operation

## Call screening

If you wish to listen to caller's leaving their message before choosing to answer a call, follow these steps:

1. Set the playback **VOL** on the base unit to a level greater than 1 by pressing **▲** or **▼**.
2. If you decide to answer a call while the caller is leaving a message, simply press **TALK/FLASH** on the handset. The answering system will stop and you can begin speaking to the caller.

## Access code

To retrieve new messages from any touch tone phone from a remote location, an access code is required. The remote access code can be any two digit number between 10 and 99. The remote access code has been set to **19** at the factory but it can be changed at any time for your convenience.

## Setting the remote access

1. Press **SETUP** twice, the system announces "Remote access code. To change the setting, press **CHANGE**."
2. Press **CHANGE**, the system announces the current setting (the default remote access code is 19.)
3. Press and release **CHANGE** to advance the remote access code number by one. Press and hold **CHANGE** to advance the remote access code by 10.
4. When the desired number is announced. Press **SETUP** to save and advance to the next menu option. Or press **PLAY/STOP** **▶/■** to save and exit.

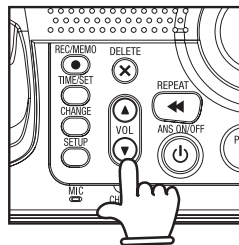

# Answering system operation

## Remote access

1. From any touch tone telephone, dial your telephone number.
2. When the outgoing announcement is playing, enter the two-digit remote access code before taking the following actions.
3. Hang up to end the call and save all messages.

If you pause for more than 10 seconds during remote access, you will hear a help menu listing all features and commands. If no command is entered for the following 20 seconds, the call will end automatically.

Purpose	Press	Action
Play all messages in the mailbox	1	Listen to new messages. If there are no new messages, all messages will be played back.
Play new messages in the mailbox	2	Plays all new (not previously listened to) messages.
Delete a message	3	Delete message currently playing.
Delete all old messages	3 3	Press when any message is playing to delete all old (previously reviewed) messages.
Repeat a message	4	Press to repeat current message.
Repeat the previous message	4 4	Press to repeat previous message.

## Answering system operation

Purpose	Press	Action to follow
Stop	5	Press to stop messages from being played.
Skip a message	6	Press to skip to the next message.
Review Announcement	#7	Listen to current outgoing announcement.
Record Announcement	*7	Press after hearing the beep. Record your new announcement. Press <b>5</b> to stop recording. The system will play back the announcement for confirmation.
Record Memo	8	Press after hearing the beep. Speak after the system announces " <i>Record after the tone. Press <b>STOP</b> when you are done.</i> " Start recording your memo. Press <b>5</b> to stop.
Review remote access code	#9	Listen to current remote access code.
Change remote access code	*9	Change remote access code.
Turn system off	0	When the system announces, " <i>Answering machine off</i> ", press <b>0</b> again to turn the system back on.
Turn system on	0	When the system is off, it answers after 10 rings and announces, " <i>Please enter your remote access code.</i> " Enter your remote access code.

### note

- Your phone may not respond to remote access commands if tones produced by the telephone are too short. Hold the buttons down longer if this occurs.

## note

- In some areas, tone dial phone from a remote location phone may not function due to telephone line conditions such as line noise, echo, etc.

## Answering system operation

### Message alert

The message alert function produces an audio tone to remind you that there are new messages on the answering system.

1. Press **SETUP** three times and you will hear "Message alert. To change the setting, press **CHANGE**".
2. Press **CHANGE** to confirm the current status (on or off) is also displayed on the message window.
3. Press **CHANGE** again to change the setting.
4. Press **SETUP** to save and advance to the next menu option or press **PLAY/STOP** ►/■ to save and exit.

When the message alert function is on, the base unit beeps every 10 seconds. **PLAY/STOP** ►/■ and the number of messages in the message window flash when there are new messages. **PLAY/STOP** ►/■ and the number in the message window are on steadily to indicate there are no new messages.

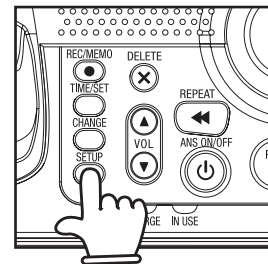

### Announcement only mode

In announcement only mode, callers hear an announcement but cannot leave messages. When announcement only is turned on, calls are answered with the pre-recorded announcement "We're sorry. Messages to this number cannot be accepted".

### Turn the announcement only mode off or on

- Press **SETUP** four times until you hear "Announcement only. Record no messages. To change the setting, press **CHANGE**."
- Press **CHANGE** until you hear the option you want (on or off).
- Press **PLAY/STOP** ►/■ to save and exit.

## Answering system operation

### Customize the announcement only message

1. Press **SETUP** four times, the system announces “*Announcement only. Record no messages. To change the setting, press CHANGE*”.
2. Press **CHANGE** until you hear the desired option.
3. Press **SETUP** three times, the system announces “*Announcement. Press PLAY or press RECORD. To continue, press SETUP*”.
4. Press **REC/MEMO** ●. The system announces, “*Record after the tone. Press STOP when you are done*”. Speak toward the **MIC** on the base to record an announcement for up to 90 seconds.
5. The elapsed time (in seconds) will be shown in the message window as you record.
6. Press **PLAY/STOP** ►/■ when you’ve finished recording. The system will play back your recorded message then save it.

### Base ringer

1. Press **SETUP** five times, the system announces “*Base ringer. To change the setting, press CHANGE*”.
2. Press **CHANGE**.
3. Press **CHANGE** again until the desired base ringer sounds.
4. Press **SETUP** to save your selection and advance to the next setup option, or press **PLAY/STOP** ►/■ to save and exit.

### Toll saver

This function sets the number of rings before the answering system picks up the call. With the **toll saver** setting activated, the answering system alerts you whether there are new messages when calling remotely from a touch tone phone. If there are new messages on the answering system, the system picks up the call after two rings. When retrieving messages from a location where long distance charges apply, you may disconnect your call after three rings to avoid long distance charges.

## Answering system operation

1. Press **SETUP** six times, the system announces *"Number of rings. To change the setting, press CHANGE"*.
2. Press **CHANGE** to confirm (the current setting will display in the message window on the base.)
3. Press **CHANGE** to set the number of rings to 2, 4, 6, or toll saver.
4. Press **SETUP** to save and advance to the next setup option, or press **PLAY/STOP** ►/■ to save and exit.

# Answering system operation

## Message window display

Display	Explanation
0	No incoming messages.
1 - 99	Total number of messages and memos, or message number currently playing. Number flashes if there are new messages.
1 - 8	Playback or ringer volume level selected when + or - is pressed.
10 - 99	Current remote access code while setting
1 - 99 (counting)	Elapsed time while recording a memo or announcement up to 90 seconds.
99 (flashing)	Memo recording exceeds maximum time of 99 seconds.
F (flashing)	Memory is full. Messages must be deleted before new messages can be recorded.
CL (flashing)	Clock needs to be set.
A	Announcement only mode is on.
--	Answering system is answering a call or being accessed from a remote location.
-- (flashing)	System is in programming mode.
On or OFF	Displayed for one second when any answering system setting is turned on or off.
02, 04, 06, tS	Change number of rings until the system answers the call.



## note

- To purchase a headset, visit us on the web at [www.vtechphones.com](http://www.vtechphones.com) or call VTech Customer Service at 1-800-595-9511. In Canada, contact VTech Telecommunications Canada Ltd. at [www.vtechcanada.com](http://www.vtechcanada.com) or 1-800-267-7377.

## Headset operation

### Headset operation

You can use this telephone handsfree when you install any VTech 2.5 mm headset, purchased separately.

Plug the headset into the jack located on the left side of the handset (under the small rubber flap). Do not force the connection, but make sure the plug fits securely.

### Operating Range

This cordless telephone operates within the maximum power allowed by the Federal Communications Commission (FCC). Even so, this handset and base can communicate only over a certain distance - which can vary with the locations of the base and handset, the weather, and the construction of your home or office.

If you receive a call while you are out of range, the handset might not ring or if it does ring, the call might not connect well when you press **TALK**. Move closer to the base, then press **TALK** to answer the call.

If you move out of range during a phone conversation, you might hear noise or interference. To improve reception, move closer to the base.

If you move out of range without pressing **OFF**, the phone will be left off the hook. To hang up properly, walk back into range, periodically pressing **OFF**.



# Batteries

## Battery care and performance

After the battery is fully charged, you can expect the following performance:

Operation	Operating time
While in use (talking)	up to 7 hours
While not in use (standby*)	up to 3 days

\* Handset is off the base unit or charger but not in use.

• The battery needs charging when:

— A new battery is installed in the handset.

— The phone beeps twice every five seconds.

— The screen displays **LOW BATTERY** and the low battery icon.

• Place the handset in the base so the **CHARGE** light turns on. The battery is usually fully charged in about 16 hours.

• You can keep the battery fully charged by returning the handset to the base or charger after each use.

## Replace the handset battery

1. Remove the battery compartment cover on the handset by pressing on the indentation and sliding the cover downward.
2. Lift out the old battery and disconnect.
3. Align the two holes in the new battery's plug with the socket pins, and snap the plug into place. Snap the battery in the compartment, as described in **Installation** on page 5.
4. Replace the cover by sliding it up into place.
5. The new battery must be fully charged before using the phone. Place the handset in the base or charger and allow it to charge for at least 16 hours the first charge. The telephone might operate before that, but for best performance, let the battery charge fully.

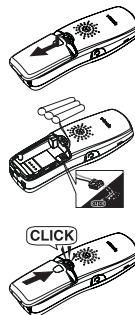

## note

- If you repeatedly get a low battery indicator, even after charging overnight, the battery should be replaced.
- To reduce the risk of fire or injury to persons or damage to the telephone, read and follow these instructions carefully.
- Charge the battery provided or identified for use with this product in accordance with the instructions and limitations specified in this user's manual.

# Troubleshooting

If you have difficulty operating your phone, the suggestions below should solve the problem. If you still have difficulty after trying these suggestions, call VTech Communications at 1-800-595-9511. In Canada, call VTech Telecommunications Canada Ltd. at 1-800-267-7377.

Problem	Suggestion
My phone doesn't work at all.	<ul style="list-style-type: none"><li>• Make sure the power cord is plugged in.</li><li>• Make sure the telephone line cord is plugged firmly into the base unit and the telephone wall jack.</li><li>• Disconnect the AC adaptor for a few minutes, and then reconnect it.</li><li>• Charge the battery in the handset for at least 16 hours. For optimum daily performance, return the handset to its base when not in use.</li><li>• Reset the base. Unplug the unit's electrical power. Wait for 15 seconds then plug it back in. Allow up to one minute for the handset and base to reset.</li><li>• You may need to purchase a new battery, please refer to the <b>Batteries</b> section of this user's manual.</li></ul>
I cannot get a dial tone.	<ul style="list-style-type: none"><li>• Try all the suggestions above.</li><li>• Move the handset closer to the base. You might have moved out of range.</li><li>• Your line cord might be malfunctioning. Try installing a new line cord.</li><li>• If the previous suggestions don't work, disconnect the base unit from the telephone jack and connect a different phone. If there is no dial tone on that phone either, the problem is in your wiring or local service. Contact your local telephone company.</li></ul>

# Troubleshooting

Problem	Suggestion
I cannot dial out.	<ul style="list-style-type: none"><li>• Make sure you have a dial tone before dialing. The handset may take a second or two to find the base and produce a dial tone. This is normal. Wait an extra second before dialing.</li><li>• Make sure your phone is set to the correct dial mode for the type of service that you have (pulse or touch tone). Refer to the <b>Installation</b> section of this user's manual to set the dial mode.</li><li>• If the other phones in your home are having the issue, the problem is in your wiring or local service. Contact your local telephone company.</li><li>• Eliminate any background noise. Noise from a television, radio or other appliance may cause the phone not to dial out properly. If you cannot eliminate the background noise, first try muting the handset before dialing, or dialing from another room in your home with less background noise.</li></ul>
<b>UNABLE TO CALL TRY AGAIN</b> displays on my handset.	<ul style="list-style-type: none"><li>• Only two handsets of your phone system can be in use (off hook) at a time. For example, if HS1 and HS2 are on a call and HS3 presses <b>TALK</b>, <b>UNABLE TO CALL TRY AGAIN</b> will display. Be sure only two handsets are in use at a time.</li><li>• Move the handset closer to the base. You might have moved out of range.</li><li>• If the handset is in its base and the charging light does not light, refer to the <b>Charge light is off</b> section in this troubleshooting guide.</li><li>• Reset the base. Unplug the unit's electrical power. Wait for 15 seconds then plug it back in. Allow up to one minute for the handset and base to reset.</li><li>• Other electronic products can cause interference with your cordless phone. Try installing your phone as far away from these types of electronic devices as possible: wireless routers, radios, radio towers, pager towers, cell phones, intercoms, room monitors, televisions, personal computers, kitchen appliances and other cordless phones.</li></ul>

# Troubleshooting

Problem	Suggestion
The battery does not hold a charge.	<ul style="list-style-type: none"><li>• Charge the battery in the handset for 16 hours. For optimum daily performance, return the handset to its base when not in use.</li><li>• You may need to purchase a new battery, please refer to the <b>Batteries</b> section of this user's manual.</li><li>• Your phone might be malfunctioning. Please refer to the <b>Warranty</b> section of this user's manual for further instruction.</li></ul>
If you subscribe to DSL service	If you hear noise during conversations and/or your caller ID features aren't functioning properly, install a noise filter to the telephone line between the base unit and the telephone line jack. Contact your DSL provider to obtain a noise filter.
I get noise, static, or weak signal even when I'm near the base.	<ul style="list-style-type: none"><li>• Other electronic products can cause interference with your cordless phone. Try installing your phone as far away from these types of electronic devices as possible: wireless routers, radios, radio towers, pager towers, cell phones, intercoms, room monitors, televisions, personal computers, kitchen appliances and other cordless phones.</li><li>• Microwaves operate on the same frequency as your phone. It is normal to experience static on your phone while the microwave is running. Do not install this phone in the same outlet or near the microwave.</li><li>• If your phone is plugged in with a modem or surge protector, plug the phone (or modem/surge protector) into a different location. If this solves the problem, re-locate your phone or modem farther apart from one another, or use a different surge protector.</li><li>• Relocate your phone to a higher location. The phone will likely get better reception not installed in a low area.</li><li>• If the other phones in your home are having the issue, the problem is in your wiring or local service. Contact your local telephone company (charges may apply.)</li></ul>

# Troubleshooting

Problem	Suggestion
I hear other calls while using my phone.	<ul style="list-style-type: none"><li>• Disconnect your base unit from the telephone jack, and plug in a regular telephone. If you still hear other calls, the problem is probably in your wiring or local service. Call your local telephone company.</li></ul>
I hear noise in the handset, and none of the keys or buttons work.	<ul style="list-style-type: none"><li>• Make sure the power cord is plugged in.</li></ul>
My handset does not ring when I receive a call.	<ul style="list-style-type: none"><li>• Make sure you have the ringer activated. Refer to the section(s) on ringer selection in this user's manual.</li><li>• Make sure the telephone line cord is plugged firmly into the base unit and the telephone jack. Make sure the power cord is plugged in.</li><li>• You may be too far from the base unit.</li><li>• Charge the battery in the handset for 16 hours. For optimum daily performance, return the handset to its base when not in use.</li><li>• You may have too many extension phones on your telephone line to allow all of them to ring. Try unplugging some of the other phones.</li><li>• The layout of your home or office might be limiting the operating range. Try moving the base to another location, preferably on an upper floor.</li><li>• If the other phones in your home are having the issue, the problem is in your wiring or local service. Contact your local telephone company (charges may apply.)</li><li>• Test a working phone at the phone jack. If another phone has the same problem, the problem is the phone jack. Contact your local telephone company (charges may apply.)</li></ul>

# Troubleshooting

Problem	Suggestion
My handset does not ring when I receive a call.	<ul style="list-style-type: none"><li>• Other electronic products can cause interference with your cordless phone. Try installing your phone as far away from these types of electronic devices as possible: wireless routers, radios, radio towers, pager towers, cell phones, intercoms, room monitors, televisions, personal computers, kitchen appliances and other cordless phones</li><li>• Your line cord might be malfunctioning. Try installing a new line cord.</li></ul>
My calls fade or cut in and out while I'm using my handset.	<ul style="list-style-type: none"><li>• Other electronic products can cause interference with your cordless phone. Try installing your phone as far away from these types of electronic devices as possible: wireless routers, radios, radio towers, pager towers, cell phones, intercoms, room monitors, televisions, personal computers, kitchen appliances and other cordless phones</li><li>• Microwaves operate on the same frequency as your phone. It is normal to experience static on your phone while the microwave is running. Do not install this phone in the same outlet or near the microwave.</li><li>• If your phone is plugged in with a modem or surge protector, plug the phone (or modem/surge protector) into a different location. If this solves the problem, re-locate your phone or modem farther apart from one another, or use a different surge protector.</li><li>• Relocate your phone to a higher location. The phone will get better reception not installed in a low area.</li><li>• If the other phones in your home are having the issue, the problem is in your wiring or local service.</li></ul>

# Troubleshooting

Problem	Suggestion
The charge light is off.	<ul style="list-style-type: none"><li>• Clean the handset and base charging contact each month using a pencil eraser or cloth.</li><li>• Make sure the power and line cords are plugged in correctly and firmly.</li><li>• Reset the base. Unplug the unit's electrical power. Wait for 15 seconds then plug it back in. Allow up to one minute for the handset and base to reset.</li><li>• Your phone might be malfunctioning. Please refer to the <b>Warranty</b> section of this user's manual for further instruction.</li></ul>
My Caller ID isn't working.	<ul style="list-style-type: none"><li>• Caller ID is a subscription service. You must subscribe to this service for this feature to work on your phone.</li><li>• Your caller must be calling from an area that supports caller ID.</li><li>• Both you and your caller's telephone companies must use caller ID compatible equipment.</li></ul>
My answering machine is not recording messages.	<ul style="list-style-type: none"><li>• Make sure system is turned <b>ON</b> (the <b>ON/OFF</b> key is illuminated).</li><li>• Make sure the announce only feature is set to <b>OFF</b>.</li></ul>
I cannot hear recorded messages.	<ul style="list-style-type: none"><li>• Using the base volume control, raise the volume to a comfortable listening level.</li></ul>
<b>CL</b> is flashing in the base message display window.	<ul style="list-style-type: none"><li>• You need to set the day and time. Refer to the section(s) on setting day and time in this user's manual.</li></ul>



# Troubleshooting

Problem	Suggestion
Common cure for electronic equipment.	<p>If the unit does not seem to be responding normally, then try putting the handset in its base. If it does not seem to respond, do the following (in the order listed):</p> <ol style="list-style-type: none"><li data-bbox="362 298 739 322">1. Disconnect the power to the base.</li><li data-bbox="362 329 1043 353">2. Disconnect the handset battery, and spare battery, if applicable.</li><li data-bbox="362 360 591 384">3. Wait a few minutes.</li><li data-bbox="362 391 672 415">4. Connect power to the base.</li><li data-bbox="362 422 654 446">5. Re-install the battery(ies).</li><li data-bbox="362 453 1325 509">6. Wait for the handset to re-establish its link with the base. To be safe, allow up to one minute for this to take place.</li></ol>

# Maintenance

## Taking care of your telephone

Your cordless telephone contains sophisticated electronic parts, so it must be treated with care.

## Avoid rough treatment

Place the handset down gently. Save the original packing materials to protect your telephone if you ever need to ship it.

## Avoid water

Your telephone can be damaged if it gets wet. Do not use the handset outdoors in the rain, or handle it with wet hands. Do not install your base unit near a sink, bathtub or shower.

## Electrical storms

Electrical storms can sometimes cause power surges harmful to electronic equipment. For your own safety, use caution when using electric appliances during storms.

## Cleaning your telephone

Your telephone has a durable plastic casing that should retain its luster for many years. Clean it only with a soft cloth slightly dampened with water or a mild soap. Do not use excess water or cleaning solvents of any kind.

Remember that electrical appliances can cause serious injury if used when you are wet or standing in water. If your base unit should fall into water, DO NOT RETRIEVE IT UNTIL YOU UNPLUG THE POWER CORD AND TELEPHONE LINE CORDS FROM THE WALL. Then pull the unit out by the unplugged cords.

# Warranty

## What does this limited warranty cover?

- The manufacturer of this VTech product, VTech Communications, warrants to the holder of a valid proof of purchase ("Consumer" or "you") that the product and all accessories provided by VTech in the sales package ("Product") are free from material defects in material and workmanship, pursuant to the following terms and conditions, when installed and used normally and in accordance with operation instructions. This limited warranty extends only to the Consumer for Products purchased and used in the United States of America.

## What will VTech Communications do if the Product is not free from material defects in materials and workmanship during the limited warranty period ("Materially Defective Product")?

- During the limited warranty period, VTech's authorized service representative will repair or replace at VTech's option, without charge, a Materially Defective Product. If we repair this product, we may use new or refurbished replacement parts. If we choose to replace this product, we may replace it with a new or refurbished product of the same or similar design. VTech will return repaired or replacement products to you in working condition. VTech will retain defective parts, modules, or equipment. Repair or replacement of Product, at VTech's option, is your exclusive remedy. You should expect the repair or replacement to take approximately 30 days.

## How long is the limited warranty period?

- The limited warranty period for the product extends for ONE (1) YEAR from the date of purchase if we repair or replace a Materially Defective Product under the terms of this limited warranty. This limited warranty also applies to repaired or replacement Products for a period of either (a) 90 days from the date the repaired or replacement Product is shipped to you or (b) the time remaining on the original one-year warranty; whichever is longer.

## What is not covered by this limited warranty?

This limited warranty does not cover

1. Product that has been subjected to misuse, accident, shipping or other physical damage, improper installation, abnormal operation or handling, neglect, inundation, fire, water or other liquid intrusion; or
2. Product that has been damaged due to repair, alteration or modification by anyone other than an authorized service representative of VTech; or
3. Product to the extent that the problem experienced is caused by signal conditions, network reliability or cable or antenna systems; or
4. Product to the extent that the problem is caused by use with non-VTech electrical accessories; or

# Warranty

5. Product whose warranty/quality stickers, Product serial numbers plates or electronic serial numbers have been removed, altered or rendered illegible; or
6. Product purchased, used, serviced, or shipped for repair from outside the United States, or used for commercial or institutional purposes (including but not limited to Products used for rental purposes ); or
7. Product returned without valid proof of purchase (see 2 below); or
8. Charges for installation or set up, adjustment of customer controls, and installation or repair of systems outside the unit.

## How do you get warranty service?

- To obtain warranty service in the United States of America, call 1-800-595-9511 for instructions regarding where to return the Product. Before calling for service, please check the user's manual. A check of the Product controls and features may save you a service call.
- Except as provided by applicable law, you assume the risk of loss or damage during transit and transportation and are responsible for delivery or handling charges incurred in the transport of Product (s) to the service location. VTech will return repaired or replaced product under this limited warranty to you, transportation, delivery or handling charges prepaid. VTech assumes no risk for damage or loss of the Product in transit.
- If the Product failure is not covered by this limited warranty, or proof of purchase does not meet the terms of this limited warranty, VTech will notify you and will request that you authorize the cost of repair prior to any further repair activity. You must pay for the cost of repair and return shipping costs for the repair of Products that are not covered by this limited warranty.

## What must you return with the Product to get warranty service?

1. Return the entire original package and contents including the Product to the VTech service location along with a description of the malfunction or difficulty;
2. Include "valid proof of purchase" (sales receipt) identifying the Product purchased (Product model) and the date of purchase or receipt; and
3. Provide your name, complete and correct mailing address, and telephone number.

## Other Limitations

- This warranty is the complete and exclusive agreement between you and VTech. It supersedes all other written or oral communications related to this Product. VTech provides no other warranties for this product. The warranty exclusively describes all of VTech's responsibilities regarding the product. There are no other express warranties. No one is authorized to make modifications to this limited warranty and you should not rely on any such modification.

State Law Rights: This warranty gives you specific legal rights, and you may also have other rights which vary from state to state.

Limitations: Implied warranties, including those of fitness for a particular purpose and merchantability (an unwritten warranty that the product is fit for ordinary use) are limited to one year from date of purchase. Some states do not allow limitations on how long an implied warranty lasts, so the above limitation may not apply to you.

- In no event shall VTech be liable for any indirect, special, incidental, consequential, or similar damages (including, but not limited to lost profits or revenue, inability to use the product, or other associated equipment, the cost of substitute equipment, and claims by third parties) resulting from the use of this product. Some states do not allow the exclusion or limitation of incidental or consequential damages, so the above limitation or exclusion may not apply to you.

# Important safety instructions

When using your telephone equipment, basic safety precautions should always be followed to reduce the risk of fire, electric shock and injury, including the following:

1. Read and understand all instructions.
2. Follow all warnings and instructions marked on the product.
3. Unplug this product from the wall outlet before cleaning. Do not use liquid or aerosol cleaners. Use a damp cloth for cleaning.
4. Do not use this product near water (for example, near a bath tub, kitchen sink or swimming pool).
5. Do not place this product on an unstable surface, such as a table, shelf or stand. The product may fall, causing serious damage.
6. Slots and openings in the back or bottom of the base unit and handset are provided for ventilation. To protect them from overheating, these openings must not be blocked by placing the product on a soft surface such as a bed, sofa or rug. This product should never be placed near or over a radiator or heat register. This product should not be placed in any area where proper ventilation is not provided.
7. This product should be operated only from the type of power source indicated on the marking label. If you are not sure of the type of power supply in your home, consult your dealer or local power company.
8. Do not allow anything to rest on the power cord. Do not install this product where the cord may have anyone walking on it.
9. Never push objects of any kind into this product through slots in the base or handset as they may touch dangerous voltage points or short out parts that could result in a risk of fire or electric shock. Never spill liquid of any kind on the product.
10. To reduce the risk of electric shock, do not disassemble this product, but take it to an authorized service facility. Opening or removing parts of the base or handset other than specified access doors may expose you to dangerous voltages or other risks. Incorrect reassembling can cause electric shock when the product is subsequently used.
11. Do not overload wall outlets and extension cords as this can result in the risk of fire or electric shock.
12. Unplug this product from the wall outlet and refer servicing to an authorized service facility under the following conditions:
  - A. When the power supply cord or plug is damaged or frayed.
  - B. If liquid has been spilled onto the product.
  - C. If the product has been exposed to rain or water.
  - D. If the product does not operate normally by following the operating instructions. Adjust only those controls that are covered by the operating instructions, as improper adjustment of other controls may result in damage and often requires extensive work by an authorized technician to restore the product to normal operation.
  - E. If the product has been dropped and the base and/or handset has been damaged.
  - F. If the product exhibits a distinct change in performance.
13. Avoid using a telephone (other than cordless) during an electrical storm. There is a remote risk of electric shock from lightning.
14. Do not use the telephone to report a gas leak in the vicinity of the leak.
15. Only put the handset of your telephone next to your ear when it is in normal talk.

# FCC, ACTA and IC regulations

## FCC Part 15

This equipment has been tested and found to comply with the requirements for a Class B digital device under Part 15 of the Federal Communications Commission (FCC) rules. These requirements are intended to provide reasonable protection against harmful interference in a residential installation. This equipment generates, uses and can radiate radio frequency energy and, if not installed and used in accordance with the instructions, may cause harmful interference to radio communications. However, there is no guarantee that interference will not occur in a particular installation. If this equipment does cause harmful interference to radio or television reception, which can be determined by turning the equipment off and on, the user is encouraged to try to correct the interference by one or more of the following measures:

- \* Reorient or relocate the receiving antenna.
- \* Increase the separation between the equipment and receiver.
- \* Connect the equipment into an outlet on a circuit different from that to which the receiver is connected.
- \* Consult the dealer or an experienced radio/TV technician for help.

Changes or modifications to this equipment not expressly approved by the party responsible for compliance could void the user's authority to operate the equipment.

To ensure safety of users, the FCC has established criteria for the amount of radio frequency energy that can be safely absorbed by a user or bystander according to the intended usage of the product. This product has been tested and found to comply with the FCC criteria. The handset may be safely held against the ear of the user. The base unit shall be installed and used such that parts of the user's body other than the hands are maintained at a distance of approximately 20 cm (8 inches) or more. If you choose to use a clipping device, please make sure to only use the supplied VTech belt clip.

## FCC Part 68 and ACTA

This equipment complies with Part 68 of the FCC rules and with technical requirements adopted by the Administrative Council for Terminal Attachments (ACTA). The label on the back or bottom of this equipment contains, among other things, a product identifier in the format US:AAAEQ##TXXXX. This identifier must be provided to your local telephone company upon request.

The plug and jack used to connect this equipment to premises wiring and the telephone network must comply with applicable Part 68 rules and technical requirements adopted by ACTA. A compliant telephone cord and modular plug is provided with this product. It is designed to be connected to a compatible modular jack that is also compliant. An RJ11 jack should normally be used for connecting to a single line and an RJ14 jack for two lines. See Installation Instructions in the user's manual.

The Ringer Equivalence Number (REN) is used to determine how many devices you may connect to your telephone line and still have them ring when you are called. The REN for this product is encoded as the 6th and 7th characters following the US: in the product identifier (e.g., if ## is 03, the REN is 0.3). In most, but not all areas, the sum of all RENs should be five (5.0) or less. For more information, please contact your local telephone company.

This equipment may not be used with Party Lines. If you have specially wired alarm dialing equipment connected to your telephone line, ensure the connection of this equipment does not disable your alarm equipment. If you have questions about what will disable alarm equipment, consult your telephone company or a qualified installer.

If this equipment is malfunctioning, it must be unplugged from the modular jack until the problem has been corrected. Repairs to this telephone equipment can only be made by the manufacturer or its authorized agents. For repair procedures, follow the instructions outlined under the Limited Warranty.

If this equipment is causing harm to the telephone network, the telephone company may temporarily discontinue your telephone service. The telephone company is required to notify you before interrupting service. If advance notice is not practical, you will be notified as soon as possible. You will be given the opportunity to correct the problem and the telephone company is required to inform you of your right to file a complaint with the FCC. Your telephone company may make changes in its facilities, equipment, operation, or procedures that could affect the proper functioning of this product. The telephone company is required to notify you if such changes are planned.

If this product is equipped with a corded or cordless handset, it is hearing aid compatible.

If this product has memory dialing locations, you may choose to store emergency telephone numbers (e.g., police, fire, medical) in these locations. If you do store or test emergency numbers, please:

## FCC, ACTA and IC regulations

- \* Remain on the line and briefly explain the reason for the call before hanging up.
- \* Perform such activities in off-peak hours, such as early morning or late evening.

### Industry Canada

This equipment complies with regulations RSS210 and CS-03 of Industry Canada. Operation is subject to the following two conditions: (1) this device may not cause interference, and (2) this device must accept any interference, including interference that may cause undesired operation of the device.

The term "IC:" before the certification/registration number only signifies that the Industry Canada technical specifications were met.

The Ringer Equivalence Number (REN) for this terminal equipment is 0.1. The REN is an indication of the maximum number of devices allowed to be connected to a telephone interface. The termination on an interface may consist of any combination of devices subject only to the requirement that the sum of the RENs of all the devices does not exceed five.

## The RBRC® Seal



The RBRC® Seal on the nickel-metal-hydride battery indicates that VTech Communications, Inc. is voluntarily participating in an industry program to collect and recycle these batteries at the end of their useful lives, when taken out of service within the United States and Canada.

The RBRC® program provides a convenient alternative to placing used nickel-metal-hydride batteries into the trash or municipal waste, which may be illegal in your area.

VTech's participation in RBRC® makes it easy for you to drop off the spent battery at local retailers participating in the RBRC® program or at authorized VTech product service centers. Please call **1-800-8-BATTERY™** for information on Ni-MH battery recycling and disposal bans/restrictions in your area. VTech's involvement in this program is part of its commitment to protecting our environment and conserving natural resources.

RBRC® is a registered trademark of Rechargeable Battery Recycling Corporation.

## Technical specifications

Enhanced 5.8GHz technology—your phone operates on a dual band transmission that combines the best of 5.8GHz and 2.4GHz technologies, providing enhanced performance over standard cordless telephones.

<b>Frequency Control</b>	Crystal controlled PLL synthesizer
<b>Transmit Frequency</b>	Base: 5725-5850 MHz Handset: 2400-2483.5 MHz
<b>Receive Frequency</b>	Base: 2400-2483.5 MHz Handset: 5725-5850 MHz
<b>Channels</b>	95
<b>Nominal Effective Range</b>	Maximum power allowed by the FCC and IC. Actual operating range may vary according to environmental conditions at the time of use.
<b>Size</b>	Handset: 150.3mm X 50.3mm X 37.3mm Base: 166.5mm X 108.2mm X 64.5mm Charger: 80mm X 89.3mm X 51mm
<b>Weight</b>	Handset: 120.4 grams                      Base: 308 grams Charger: 64.4 grams
<b>Power Requirements</b>	Handset: 600mAH Ni-MH Battery Base: 9V DC @ 600mA Charger: 9V DC @ 200mA
<b>Memory</b>	Directory: 50 Memory locations, up to 32 digits, 16 characters per location CID: 50 Memory locations

# Index

## A

- Additional information 42-54
- Adjust handset volume 13
- Announcement only mode 36
- Announcements 31
- Answering calls 13
- Answering system
  - operation 27-38

## B

- Base LEDs 12
- Base ringer 37
- Base unit layout 11
- Basic operation 12-41
- Batteries 5, 41
- Belt clip 8

## C

- Caller ID 21-24
- Call forwarding 15
- Call screening 33
- Call transfer 16
- Characters by number 18
- Check battery indicator 7
- Check for dial tone 7
- Choose a location 5
- Clear voicemail 26
- Conference Call 16

- Connect power to base unit/
  - chargers 6
- Connect to phone line 8
- Customize the announcement only
  - message 37

## D

- Day and time announcements 27
- Delete a directory entry 20
- Delete all messages 32
- Delete caller ID 24
- Dial from caller ID 24
- Dial type 26
- Directory 17-20
- DSL 8

## E

- Edit a directory entry 19

## F

- FCC, ACTA and IC regulations 52
- Find handset 16
- Flash 13

## G

- Getting started 4-11

## H

- Handset icons 12
- Handset layout 10
- Handset LEDs 12
- Handset name 25
- Handset operation 13-16
- Handset settings 25-26
- Headset operation 40

## I

- If you subscribe to DSL service 8
- Important safety instructions 11
- Installation 5-8
- Install handset battery 5
- Intercom 14
- Internet 8

## K

- Key tone 25

## L

- Language 26
- Listen to outgoing
  - announcement 30

## M

- Maintenance 49
- Making calls 13



# Index

Menu features 29  
Message alert 36  
Message playback 31  
Message window display 39  
Mute 14

## N

Noise filter 8

## O

Operating range 40  
Options during playback 31  
Outgoing announcement 29

## P

Parts checklist 4  
Playback a memo 32

## R

Record a memo 32  
Record and play memos 32  
Record outgoing announcement 29  
Redial 13  
Remote access 34  
Replace the handset battery 41  
Review/dial from the directory 19  
Review caller ID 22  
Ringer volume 25

56

## S

Setting the remote access 33  
Store a new entry 17  
Store caller ID 22

## T

Technical specifications 54  
To check day and time 28  
Toll saver 37  
Troubleshooting 42–48  
Turn the announcement only mode off or on 36  
Turn your answering system off and on 27

## W

Wall mounting 7  
Warranty 49

VTECH TELECOMMUNICATIONS LTD.

A member of THE VTECH GROUP OF COMPANIES.

Distributed in the U.S.A. by VTech Communications, Inc. Beaverton, Oregon

Distributed in Canada by VTech Telecommunications Canada Ltd., Richmond, B.C.

Copyright ©2005 for VTECH TELECOMMUNICATIONS LTD.

Printed in China.

91-000468-010-000

**vtech**<sup>®</sup>  
Innovation Beyond Technology

## Free Manuals Download Website

<http://myh66.com>

<http://usermanuals.us>

<http://www.somanuals.com>

<http://www.4manuals.cc>

<http://www.manual-lib.com>

<http://www.404manual.com>

<http://www.luxmanual.com>

<http://aubethermostatmanual.com>

Golf course search by state

<http://golfingnear.com>

Email search by domain

<http://emailbydomain.com>

Auto manuals search

<http://auto.somanuals.com>

TV manuals search

<http://tv.somanuals.com>