



User's Manual

www.vtechphones.com



Models:
gz2335/2338

24
GHz
Technology

Table of contents

Getting started	4	Delete a directory entry	21
Parts checklist	4	Dial a directory number	22
Installation	5	Move a directory entry to speed dial.	23
Installing handset battery	5	Caller ID	24
Low battery warning	6	Call log	24
Choose a location	6	Review call log	24
If you subscribe to DSL service	7	Remove records from call history	25
Connection	7	Dial a displayed number	25
Removable handset and base plates	8	Store a call log entry in the directory	25
Handset features	9	Display screen messages	26
Base features	10	Ringer options	27
Basic operation	11	Headset operation	28
Set handset ringer	11	Belt clip	28
Set date and time	11	Additional information	29
Telephone operation	12	Troubleshooting	29
Dial mode	12	Maintenance	36
Temporary tone dialing	12	Warranty	36
Language	13	Important safety instructions	37
Operating range	13	FCC, ACTA and IC regulations	38
Displaying screen messages	14	The RBRC® Seal	40
Speed dial	15	Technical specifications	41
Store a speed dial entry	15	Index	42
Delete a speed dial entry	17		
Dial a speed dial number	18		
Re-assign speed dial locations	18		
Directory	19		
Store a directory entry	19		
Edit a directory entry	21		

www.vtechphones.com

NEED HELP?

This manual has all the feature operations and troubleshooting you need to install and operate your new VTech telephone. Please take the time to review thoroughly to ensure proper installation of this VTech innovative and feature rich product. You can also visit our website at www.vtechphones.com for support, shopping, and everything new at VTech. In Canada, please visit www.vtechcanada.com.

VTech toll free 1-800-595-9511
In Canada dial 1-800-267-7377

note

- Important! Before using this telephone, you must read **Important safety instructions** on pages 37-38.

Before you begin

Parts checklist:

1. Base unit
2. Handset
3. Color handset brackets and base plates
4. AC power adaptor
5. Belt clip
6. Telephone line cord
7. Battery
8. User's manual
9. Battery compartment cover
10. Headset (with model gz2338, see page 28).

To purchase replacement batteries, visit us on the web at www.vtechphones.com or call VTech Communications, Inc. at 1-800-595-9511. In Canada, contact VTech Telecommunications Canada Ltd. at www.vtechcanada.com or 1-800-267-7377.

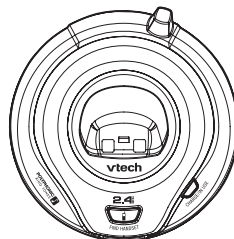

1. Base unit



2. Handset

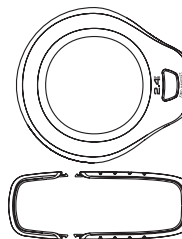

3. Color handset brackets and base plates

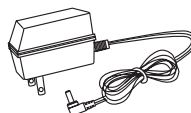

4. AC Power adaptor

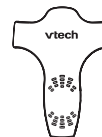

5. Belt clip

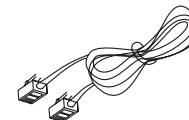

6. Telephone line cord



7. Battery



8. User's manual



9. Battery compartment cover



10. Headset (model gz2338)

Installation

Installing handset battery

1. Plug the battery connector securely into the jack inside the battery compartment according to the color-coded label.
2. Insert battery in the center of the battery compartment.
3. Press down on the wired side until the battery securely snaps into place.
4. Neatly tuck the wires inside the battery compartment.
5. Position the battery compartment cover and slide it towards the unit until it clicks into place.
6. Put the handset in the base unit to start charging the new battery for at least 16 hours.
7. After the battery is fully charged, press **ON** on the handset and you should hear a dial tone.

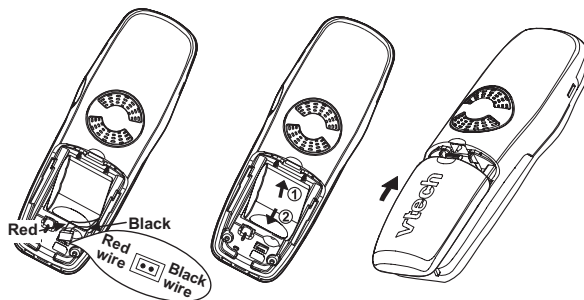

note

- Use only the VTech battery and AC power adaptor supplied with this telephone.
- Recharging of a fully depleted battery may take up to 16 hours. A fully charged battery could provide up to 5 hours of talk time, or up to 5 days of standby time.
- Place the handset in the base unit when not in use to ensure optimum performance.

note

- If the phone will not be used for a long period of time, remove the battery to prevent possible leakage.
- If you have any trouble installing your phone, please refer to the troubleshooting section near the end of this manual.
- Use only the VTech battery and AC power adaptor supplied with this telephone.
- if you need to install your phone within the same room as other cordless phones or wireless products, you may need to select a different channel for your router and or change the channel on your phone's handsets.

Installation

Low battery warning

A low battery warning indicates one of the following:

1. There is no battery in your handset. The supplied battery must be installed in the handset.
2. The battery needs to be replaced, or
3. The battery is installed incorrectly. Re-install according to the instructions on page 5.

When in low battery mode, the **LOW BATTERY** icon will be on and an alarm will sound until the handset is returned to the base unit for recharging. When the phone is on, the words **LOW BATTERY** will replace the words **PHONE ON**. When the battery has been charged, these features will return to normal.

Choose a location

For optimum performance of your cordless telephone system:

1. Choose a central location for your base unit.
2. Install your phone(s) as far away as possible from any other cordless (wireless) device such as cordless telephones, 802.11 wireless router (for example, WiFi).
3. Install your phone(s) as far away as possible from other electronic equipment such as microwave ovens, televisions, computers, etc.
4. Install your telephone equipment away from heat sources and direct sunlight.
5. Avoid excessive moisture, dust or extreme cold.

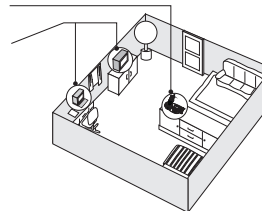

Installation

Connection

1. Choose a location for the base near an electrical outlet and telephone jack.
2. Plug the connector of the base power adaptor to the connector jack at the bottom of the base unit. Then plug the adaptor into a standard electrical outlet (110V AC) not controlled by a wall switch.
3. Connect the telephone line cord to the jack at the bottom of the base unit, and the other end to the wall jack.

If you subscribe to DSL service

If there is interference during telephone conversations and/or your caller ID features are not functioning properly, install a noise filter to the telephone line between the base unit and the telephone wall jack. Contact your DSL provider for a noise filter.

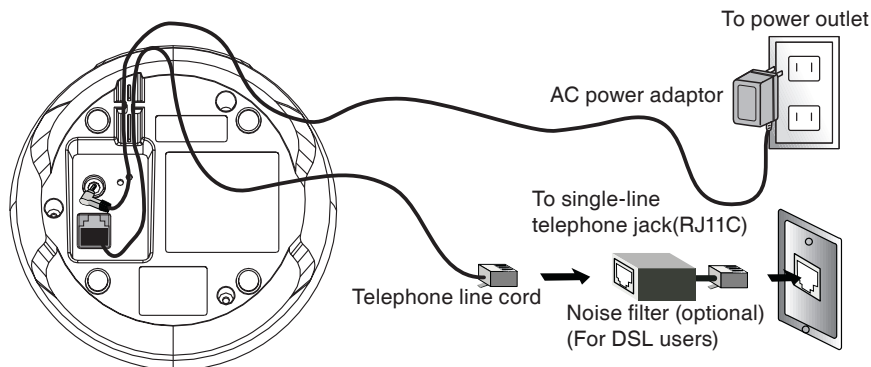

Installation

Removable handset and base plates

Your phone comes with additional handset brackets and base plates of various colors. These brackets and plates are interchangeable to suit your mood or room decor.

Handset brackets

1. Carefully remove the handset's top bracket and/or bottom bracket by pressing inward towards the center of the phone, then pull the bracket off slowly.
2. Attach the new top bracket and/or bottom bracket by aligning the two sides of the plate with the slots on the phone. Gently push the brackets towards the center of the phone until it locks securely into place.

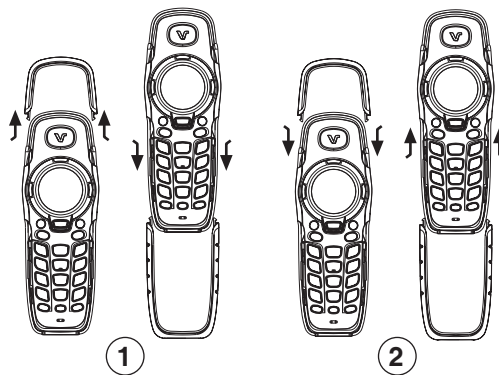

Base plate

1. Carefully remove the base plate by inserting your thumb in the slot just below the **FIND HANDSET** button and lift the color plate from the base.
2. Align the tabs on the back of the new base plate with the appropriate openings in the base unit and then align the two front tabs before snapping the plate into position.

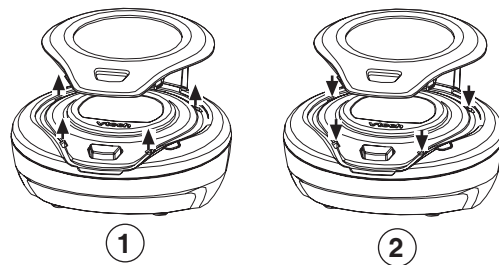

Handset features

▼(CID/VOL-)

- When the phone is not in use, press to display caller ID information.
- Press and hold for two seconds while in idle mode to adjust ringer volume. A double beep will sound at the lowest setting.
- During a call, press to lower listening volume. A double beep will sound at the lowest setting.

TALK

- Press this button before dialing the number to make a call.

-OR-

Dial the number (use ▼ to backspace and correct digits), then press this button to make a call.

- Press any key except **OFF**, **CID/VOL-**, **DIR/VOL+** to answer a call.
- While on a call, when there is a call waiting alert, press this button to take the new call, then press this button again to return to the original call.
- When the phone is in use, this button will glow steadily. When a call is on hold, it will flash.

CHAN/REMOVE

- Switch to a clear channel while on a call.
- While handset is not in use, press and hold to delete all records in the call log. When viewing the call log, press to delete the current record.

PROG

- Press to enter programming mode while the handset is idle (off).

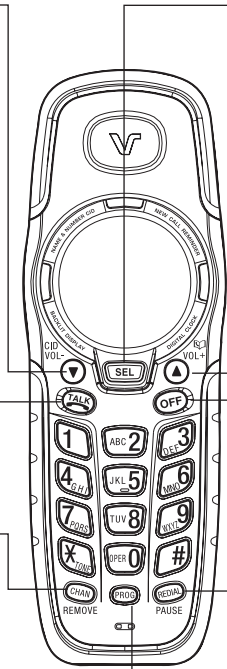

SELECT

- Press to store a programming option, or to store a directory entry.

▲(DIR/VOL+)

- When the phone is not in use, press to display directory entries.
- Press & hold for 2 seconds during idle mode to adjust ringer volume. A double beep will sound when the lowest setting is reached.
- During a call, press to increase listening volume. A double beep will sound when the highest setting is reached.

OFF

- During a call, press to hang up.
- While the handset is ringing, press to silence the ringer.
- Press and hold for two seconds while in idle mode to erase the **MISSED CALLS** display.
- During programming, press to exit without making changes.

REDIAL/PAUSE

- Press **TALK**, then press this button to call the last number dialed. -OR- Press this button, then press **TALK** to call the last number dialed.
- While handset is not in use, press this button twice to delete the last number dialed from this telephone.
- While dialing or entering numbers into the directory, press to insert a four-second dialing pause.

Base features

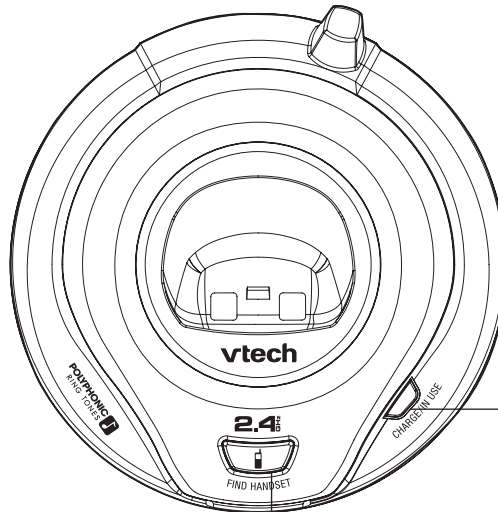

FIND HANDSET

Press to page the handset for up to 60 seconds. Press again, press **OFF**, or place the handset in its base to cancel the page.

CHARGE/IN USE Indicator

- Flashes when the handset is in use.
- Flashes in unison with incoming ringing.
- On steadily when the handset is charging in the base.

Telephone operation

Set handset ringer

You can select from four traditional ringers, thirteen musical ringers, or turn the ringer **OFF**.



1. Make sure the handset is idle (off).
2. Press **PROG**.
3. Press **▲** until the screen displays **RINGER**: and the current setting.
4. Press **SEL**. The current setting blinks, and you will hear a sample of the ring tone.
5. Press **▼** or **▲** to hear a sample of each ring tone.
6. Press **SEL** to choose the desired ring tone. If you chose a musical ringer or one of your personal ring tones, the handset will display, for example:



7. Press **▼** or **▲** to adjust the volume level.
8. Press **SEL** to confirm the volume setting. A confirmation tone will sound. To set ringer volume, press and hold **CID/VOL-** or **DIR/VOL+** keys.

Set date and time

If you subscribe to caller ID service, the date and time will be set automatically with the first incoming call. If you do not have caller ID service, the date and time can be set manually:

1. Make sure the handset is idle (off).
2. Press **PROG**.
3. Press **▲** until the screen displays **DATE/TIME**.
4. Press **SEL**. The current month blinks.
5. Use **▼** or **▲** to adjust the month, then press **SEL**.
6. Repeat step 5 to adjust the **day, hour, minute** and  or  (to indicate am or pm). You'll hear a confirmation beep.

note

- If you set the ringer volume to **OFF**, the phone will not ring during an incoming call.

Telephone operation

Dial mode (preset to tone)

If you have touch tone service, the phone is ready to use as soon as the battery is charged.

If you have pulse (rotary) service, the dial mode must be changed.

1. Make sure the handset is idle (off).
2. Press **PROG**.
3. Press **▲** until the screen displays **DIAL MODE:** and the current setting.
4. Press **SEL**. The current setting blinks.
5. Press **▼** or **▲**. The screen displays **TONE** or **PULSE**.
6. Press **SEL** to save. You'll hear a confirmation beep.

Temporary tone dialing

If you have pulse (rotary) service, you can change from pulse to touch tone dialing during a call by pressing ***TONE**. This is useful if you need to send touch tone signals for access to telephone banking or long distance services.

1. Dial the number.
2. Press ***TONE**. Buttons pressed after this send touch tone signals.
3. After you hang up, the phone automatically returns to pulse dial service.

Language

You can select English, Spanish or French.

1. Make sure the handset is idle (off).
2. Press **PROG**.
3. Press **▼** or **▲** until the screen displays **LANGUAGE**.
4. Press **SEL**. The current setting blinks.
5. Press **▼** or **▲** to select among **ENGLISH**, **SPANISH** or **FRENCH**. When the desired language is displayed, press **SEL** or **PROG**. A confirmation tone will sound.

Telephone operation

Operating range

This cordless telephone operates within the maximum power allowed by the Federal Communications Commission (FCC). Even so, this handset and base can communicate over only a certain distance — which can vary with the locations of the base and the handset, the weather, and the construction of your home or office.

If the handset receives a call while out of range, the handset might not ring — or if it does ring, the call might not connect well when you press **TALK**. Move closer to the base, then press **TALK** to answer the call.

If the handset is moved out of range during a phone conversation, there might be interference. To improve reception, move closer to the base.

If the handset moves out of range without your pressing OFF, the phone will be left off the hook. To hang up properly, walk back within range, periodically pressing **OFF**.

Telephone operation

Displaying screen messages

Screen displays:	When:
** RINGING **	There is a call coming in.
CONNECTING...	The handset is waiting for a dial tone.
PHONE	The handset is in use.
** PAGING **	The base is paging the handset.
LOW BATTERY	The battery needs to be recharged.
SCANNING...	The handset is changing to one of the 30 channels available for better reception.
CAN'T CONNECT	Together with an error tone when the base power is off and TALK is pressed. Displays when handset is out of range and an attempt to dial failed.
NEW VOICE MAIL	There are telephone company voicemail.

Speed dial

You can store as many as nine frequently dialed telephone numbers with names (up to 15 characters and 24 digits in each location) into the speed dial memory locations you assign in the handset.

Store a speed dial entry

1. Press **PROG.**
2. Press **▼** or **▲** until the screen displays **SPEED DIAL.**
3. Press **SEL.** The screen displays **ENTER 1-9.**
4. Press the key (1 through 9) for the memory location for the new entry.
The screen displays **ENTER NAME.**
5. Using the chart below, enter up to 15 characters for the name to be stored with the number. Use **▼** to backspace and make corrections; use **▲** to advance or add a space.
6. When finished entering the name, press **SEL** or **PROG.** The screen displays **ENTER NUMBER.**

Dial Key	Presses					
	Once	Twice	3 Times	4 Times	5 Times	6 Times
1	1					
2	A	B	C	2		
3	D	E	F	3		
4	G	H	I	4		
5	J	K	L	5		
6	M	N	O	6		
7	P	Q	R	S	7	
8	T	U	V	8		
9	W	X	Y	Z	9	
0	0					
*	*					
#	&	'	,	-	.	#

www.vtechphones.com

note

- The entries stored in speed dial memory will be marked 1 through 9 in the telephone directory.
- Press **OFF** anytime to exit the speed dial mode.
- When the memory is full, the screen displays **MEMORY FULL**, an error tone sounds and no new entry can be stored until an entry is deleted from the speed dial memory or the telephone directory.
- Take caution when assigning speed dial location numbers in memory. If the location already has an entry stored, the new entry will overwrite the existing one. Be careful not to save over entries you do not wish to delete from memory.

note

- When an incoming phone number matches an existing number in the directory or speed dial, the stored name will be displayed on the screen.

Speed dial

7. Enter the telephone number. Use ▼ to backspace and make a correction. Press **REDIAL/PAUSE** to store a pause in the dialing sequence.
-OR-
Press **REDIAL/PAUSE** to display the last number dialed.
8. Press **SEL** or **PROG**. The screen displays **DISTINCT RING?** and the current setting.
9. Press ▼ or ▲ to change the setting. Choose **Y** (for yes) if you wish the phone to alert you to calls from this number by changing to a distinctive ring tone after the first or second ring. Choose **N** for a normal ring tone.
10. Press **SEL** or **PROG** to confirm your selection.
If you chose **Y**, the screen displays:
If N is chosen, skip to Step 12.
11. The ringer name will blink. Press ▼ or ▲ for the desired ring tone.
12. Press **SEL** or **PROG** to confirm your selection.

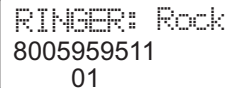

RINGER: Rock
8005959511
01

Speed dial

Edit a speed dial entry

1. Press and hold the memory location key (1 through 9) of the entry to be edited.
2. When the screen displays the desired number, press **SEL**. Then press ▼ or ▲ until **EDIT** flashes, Press **SEL**.
3. The screen displays the name and number. The cursor appears at the end of the name. Use ▼ or ▲ and the dial pad keys to edit the name. Press **SEL** to move to edit the number. Press **SEL** to continue and edit the distinct ring tone. Follow steps 9 through 12 in **Storing an Entry in Speed Dial Memory**.



SPEED EDIT ERASE
8005959511
01

Delete a speed dial number

1. Press and hold the memory location key (1 through 9) of the entry to be deleted.
2. When the screen displays the number to be deleted, press **SEL**. Then press ▼ or ▲ until **ERASE** flashes.
3. Press **SEL**. The screen displays **ERASE NO YES** and the number. The current choice flashes.
4. Press ▼ or ▲ until **YES** flashes.
5. Press **SEL**. A confirmation tone will sound.

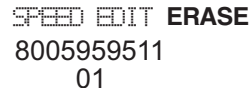

SPEED EDIT ERASE
8005959511
01

Speed dial

Dial a speed dial number

1. Press and hold the memory location key (1 through 9) of the entry you wish to dial.
2. Press **TALK** to dial the displayed memory number.

Re-assign speed dial locations

1. Press and hold the memory location key (1 through 9) of the entry you wish to reassign.
2. When the screen displays the number you want to reassign, press **SEL**. Then press **▼** or **▲** until **SPEED** flashes.
3. Press **SEL**. The screen displays **ENTER 1-9** and the number.
4. Press the keys (1 through 9) to re-assign this entry into another memory location. A confirmation tone will sound.

SPEED EDIT ERASE
8005959511
01

Directory

Your phone can store 20 telephone numbers with names (including nine speed dial entries), each up to 15 characters for the name and 24 digits for the number.

Store a directory entry

1. Press **PROG**. The screen displays **DIRECTORY**.
2. Press **SEL**. The screen displays **ENTER NAME**.
3. Using the chart below, enter up to 15 characters for the name to be stored with the number. Use ▼ to backspace and make corrections, and ▲ to advance or add a space.

Dial key	Press					
	Once	Twice	3 times	4 times	5 times	6 times
1	1					
2	A	B	C	2		
3	D	E	F	3		
4	G	H	I	4		
5	J	K	L	5		
6	M	N	O	6		
7	P	Q	R	S	7	
8	T	U	V	8		
9	W	X	Y	Z	9	
0	0					
*	*					
#	&	'	,	-	.	#

4. When finished entering the name, press **SEL** or **PROG**. The screen displays **ENTER NUMBER**.
5. Enter the telephone number. Use ▼ to backspace and make corrections. Press **REDIAL/PAUSE** to store a pause in the dialing sequence.

note

- Press **OFF** anytime to exit directory.

note

- If you choose N, skip to Step 10.

Directory

-OR-

Press **REDIAL/PAUSE** to display the last number dialed from this phone.

6. Press **SEL** or **PROG**. The screen displays **DISTINCT RING?** and the current setting.
7. Press **▼** or **▲** to change the setting. Choose **Y** (for yes) if you wish the phone to alert you to calls from this number by changing to a distinct ring tone after the first or second ring. Choose **N** for a normal ring tone.
8. Press **SEL** or **PROG** to confirm your selection.
If you choose **Y**, the screen displays:
If **N** is chosen, skip to Step 12.
9. The ring tone name will blink. Press **▼** or **▲** for the desired ring tone.
10. Press **SEL** or **PROG** to confirm your selection.

RINGER: Rock
8005959511
01

Directory

Edit a directory entry

1. Press **▲**. The screen displays **DIRECTORY**.
2. Press **▼** or **▲** to scroll alphabetically through the entries.
-OR-
Press the dial pad key for the first letter of the entry to be edited.
3. When the screen displays the desired entry, press **SEL**. Then press **▲** until **EDIT** flashes.



```
SPEED EDIT ERASE
8005959511
```

4. Press **SEL**. The screen displays the name and number. The cursor appears at the end of the name. Use **▼**, **▲** and the dial pad keys to edit the name. Press **SEL** to move on to edit the number. Use **▼** to backspace and make corrections. Press **SEL** to move on to edit the distinct ring tone. Follow steps 7 through 9 in **Storing an Entry in the Directory**.

Delete a directory entry

1. Press **▲** until the screen displays **DIRECTORY**.
2. Press **▼** or **▲** to scroll alphabetically through entries.
-OR-
Press the dial pad key for the first letter of the entry to be deleted.
3. When the screen displays the desired entry, press **SEL**. Then press **▲** until **ERASE** flashes.

note

- When memory is full, the screen displays **MEMORY FULL**; an error tone sounds, and no new entry can be stored until an existing entry is deleted.

Directory



SPEED EDIT ERASE
99999911

4. Press **SELECT**. The screen displays **ERASE NO YES** and the number. The current setting flashes.
5. Press **▲** until **YES** flashes.
6. Press **SEL**. You will hear a confirmation beep.

Dial a directory number

1. Press **▲**. The screen displays **DIRECTORY**.
2. Press **▼** or **▲** to scroll alphabetically through the entries.

-OR-

Press the dial pad key for the first letter of the entry to be dialed.

3. Press **TALK** to dial the displayed directory number.

Directory

Move a directory entry to speed dial

1. Press **▲**. The screen displays **DIRECTORY**.
2. Press **▼** or **▲** to scroll alphabetically through the directory.
-OR-
Press the dial pad key for the first letter of the entry to be moved.
3. When the screen displays the entry to be moved, press **SEL**.
Then press **▲** until **SPEED** flashes.
4. Press **SEL**. The screen displays **ENTER 1-9** and the number.
5. Press the key (1 through 9) to move this entry from the directory into speed dial and assign it to memory. A confirmation tone will sound. A location number (1 through 9) will be displayed with this entry.



SPEED EDIT BASE
8005959511

note

- When repeat caller ID (CID) data arrives, the newest date, time and caller ID information overwrite the old information, and is displayed during CID review.
- Press **OFF** anytime to exit call log.

Caller ID

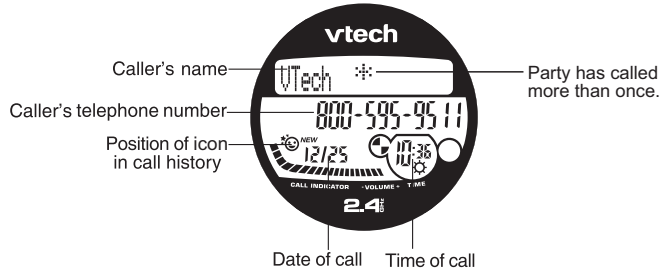

Call log

When the memory is full, the oldest call information is deleted to make room for new incoming call information. For each incoming call, the screen displays the following information between the first and second rings:

- The caller's name (up to 15 letters are sent by your telephone company).
- The caller's area code and telephone number (up to 11 digits).
- The time and date of the call.
- The repeat Tag (:*)) in the upper right corner, indicating this party has called more than once.

Review call log

1. Press ▼ to view call Log.
2. Use ▼ or ▲ to scroll through entries in the call log. Press ▼ to scroll down towards older entries. Press ▲ to scroll up towards newer entries.

Caller ID

Remove records from call history

Removing a Specific Entry:

1. Locate the record to be deleted from the call log.
2. Press **CHAN/REMOVE**, a confirmation tone will sound.

Removing All Entry:

1. With the Handset in idle (off) mode, press and hold **CHAN/REMOVE**. The screen displays **ERASE ALL NO YES**. The current choice flashes.
2. Press **▲** until **YES** flashes.
3. Press **SEL**. A confirmation tone will sound.

Dial a displayed number

1. Locate the desired record in the call log.
2. If you wish to change how the number is dialed, press **#**. The screen displays all dialing sequences available for this entry (1 + area code + number; area code + number; number only; 1+ number). The dialing options are:
3. Press **SEL**. Press **▲** until **DIAL** flashes.
4. Press **SEL** again. The number is automatically dialed.

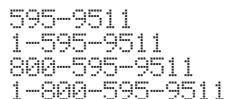

```
595-9511
1-595-9511
800-595-9511
1-800-595-9511
```

-OR-

When the number is correctly displayed for dialing, press **TALK**.

Store a call log entry in the directory

1. Locate the desired entry in the call Log to be stored in the directory.
2. If you wish to change how the number is stored, press **#**. The screen displays all dialing sequences available for this entry (area code + number; 1 + area code + number; number only; 1 + number).
3. Press **SEL**, then press **▲** until **PROGRAM** flashes.

note

- When the memory is full, the screen displays **MEMORY FULL**, an error tone sounds and no new number can be stored until an existing entry is deleted.

Caller ID



DIAL PROGRAM
800-595-9511
OLD 28 5/01 5:40PM

- Press **SEL**. The screen displays the number and name. The cursor appears at the end of the name. Use **▼**, **▲** and the dial pad keys to edit the name. Press **SEL** to continue and edit the number. Use **▼** to backspace and make corrections. Press **SEL** to confirm.
- Follow steps 7 through 9 in **Storing a directory entry**.

Display screen messages

Screen displays:	When:
PRIVATE	The other party is blocking name and/or number information.
UNKNOWN	Your phone company is unable to receive information about this caller's name and/or number.
* (after name)	This caller has called you more than once.

Ringer options

In addition to four traditional ringer options and ringer off, your **gz2335** or **gz2338** handset has thirteen popular pre-programmed ring tones.

Traditional Ring Options:

Ringer 1	Ringer 2
Ringer 3	Ringer 4
Ringer OFF	

Tones:

1. Rotary	2. Siren
3. Bark	4. Hip-Hop
5. Metal	6. Rock
7. Monster	8. Fur Elis
9. Num 40	10. T March
11. Charge	12. Joy
13. B_Day	

note

- Whenever a compatible headset is connected to the cordless handset, the microphone on the handset will be muted to alleviate the effect of background noise.

Headset operation

Your phone handset is equipped with a 2.5mm headset jack for use with an optional accessory headset for handsfree operation. Model gz2338 comes with a headset.

If you've purchased the VTech **gz2335** and wish to obtain a compatible headset, you must purchase it separately. To purchase a headset, visit us on the web at www.vtechphones.com or call VTech Customer Service at 1-800-595-9511.

Once you have a compatible 2.5mm headset, locate the headset jack on the side of the handset. Connect the plug on the headset cord to the jack (under a small rubber flap) on the cordless handset. The plug should fit securely. Do not force the connection.

Belt clip

Your phone is also equipped with a detachable belt clip. Align the pins on the inside edge of the clip with the notches on the sides of the handset. The belt clip should snap securely into place. Do not force the connection.

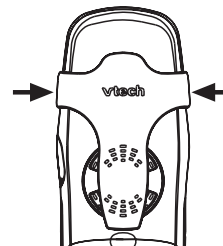
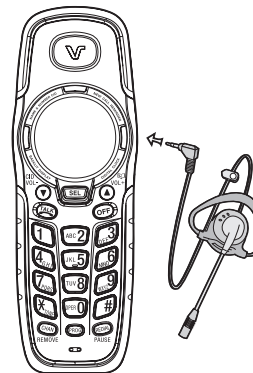

Troubleshooting

If you have difficulty operating your phone, the suggestions below should solve the problem. If you still have difficulty after trying these suggestions, call VTech Communications at 1-800-595-9511. In Canada, call VTech Telecommunications Canada Ltd. at 1-800-267-7377.

Problem	Suggestion
My phone doesn't work at all.	<ul style="list-style-type: none">• Make sure the power adaptor is plugged in.• Make sure the telephone line cord is plugged firmly into the base unit and the telephone wall jack.• Disconnect the power adaptor for a few minutes, and then reconnect it.• Charge the battery in the handset for 16 hours. For optimum daily performance, return the handset to its base when not in use.• Reset the base. Unplug the unit's electrical power. Wait for 15 seconds then plug it back in. Allow up to one minute for the handset and base to reset.• You may need to purchase a new battery, please refer to the battery sections in this user's manual.
I cannot get a dial tone.	<ul style="list-style-type: none">• Try all the suggestions above.• Move the handset closer to the base. You might have moved out of range.• Your line cord might be malfunctioning. Try installing a new line cord.• If the previous suggestions do not work, disconnect the base unit from the telephone jack and connect a different phone. If there is no dial tone on that phone either, the problem is in the wiring or local service. Contact your local telephone company.

Troubleshooting

Problem	Suggestion
I cannot dial out.	<ul style="list-style-type: none">• Make sure there is a dial tone before dialing. It is normal for handset to take a second or two to find the base and produce a dial tone. Wait an extra second before dialing.• Make sure the phone is set to the correct dial mode for the type of service that you have (pulse or touchtone). Refer to the Installation section of this user's manual to set the dial mode.• If the other phones in your home are having the same problem, the problem is in your wiring or local service. Contact your local telephone company.• Eliminate any background noise. Noise from a television, radio or other appliance may cause the phone not to dial out properly. If you cannot eliminate the background noise, first try muting the handset before dialing, or dialing from another room in your home with less background noise.
My handset beeps five times and isn't performing normally.	<ul style="list-style-type: none">• Make sure the power adaptor is securely plugged into the base. Plug the unit into a different, working outlet not controlled by a wall switch.• Move the handset closer to the base. It might have been moved out of range.• If the handset is in its base and the charging light does not light, refer to Charge Light is Off in this troubleshooting guide.• Reset the base. Unplug the unit's electrical power. Wait for 15 seconds then plug it back in. Allow up to one minute for the handset and base to reset.• Other electronic products can cause interference with your cordless phone. Try installing your phone as far away from these types of electronic devices as possible: wireless routers, radios, radio towers, pager towers, cell phones, intercoms, room monitors, televisions, personal computers, kitchen appliances and other cordless phones.

Troubleshooting

Problem	Suggestion
<p>CAN'T CONNECT displays on my handset.</p>	<ul style="list-style-type: none"> • Move the handset closer to the base. You might have moved out of range. • If the handset is in its base and the charging light does not light, refer to the charge light is off in this troubleshooting guide. • Reset the base. Unplug the unit's electrical power. Wait for 15 seconds then plug it back in. Allow up to one minute for the handset and base to reset. • Other electronic products can cause interference with your cordless phone. Try installing your phone as far away from these types of electronic devices as possible: wireless routers, radios, radio towers, pager towers, cell phones, intercoms, room monitors, televisions, personal computers, kitchen appliances and other cordless phones.
<p>The battery does not hold a charge.</p>	<ul style="list-style-type: none"> • Charge the battery in the handset for 16 hours. For optimum daily performance, return the handset to its base when not in use. • You may need to purchase a new battery, please refer to the battery sections in this user's manual. • Your phone might be malfunctioning. Please refer to the Warranty section of this user's manual for further instruction.
<p>If you subscribe to DSL service</p>	<p>If you hear noise during conversations and/or your caller ID features are not functioning properly, install a noise filter to the telephone line between the base unit and the telephone line jack. Contact your DSL provider to obtain a noise filter.</p>
<p>My Caller ID isn't working.</p>	<ul style="list-style-type: none"> • Caller ID is a subscription service. You must subscribe to this service for this feature to work on your phone. • Your caller must be calling from an area that supports caller ID. • Both you and your caller's telephone companies must use caller ID compatible equipment.

Troubleshooting

Problem	Suggestion
<p>I get noise, static, or weak signal even when I'm near the base.</p>	<ul style="list-style-type: none"> • Other cordless phones and 802.11 wireless routers that are used for home computer networks both use internal radios to communicate. The radios may interfere with one another. You can improve the performance of your cordless phones and your router by: <ol style="list-style-type: none"> a. positioning your new phone as far away as possible from any other existing cordless telephone system that is already installed in your home to avoid the two systems interfering with each other. b. positioning your telephone base as far as possible from your router, computer or any other computer devices. c. selecting channels four through 10 for your router (refer to your router's user manual for more information). d. If you still have problems with the phone or the router, make sure the handset is ON and press CHAN until the performance improves. • Press the CHAN button while on a call until the interference has been eliminated. • Other electronic products can cause interference with your cordless phone. Try installing your phone as far away from these types of electronic devices as possible: wireless routers, radios, radio towers, pager towers, cell phones, intercoms, room monitors, televisions, personal computers, kitchen appliances and other cordless phones. • Microwaves operate on the same frequency as your phone. It is normal to experience static on your phone while the microwave is running. Do not install this phone in the same outlet or near the microwave. • If your phone is plugged in with a modem or surge protector, plug the phone (or modem/surge protector) into a different location. If this solves the problem, re-locate your phone or modem farther apart from one another, or use a different surge protector. • Relocate your phone to a higher location. The phone will likely get better reception not installed in a low area. • If the other phones in your home are having the issue, the problem is in your wiring or local service. Contact your local telephone company (charges may apply.)
<p>I hear other calls while using my phone.</p>	<ul style="list-style-type: none"> • Disconnect your base unit from the telephone jack, and plug in a regular telephone. If you still hear other calls, the problem is probably in your wiring or local service. Call your local telephone company.

Troubleshooting

Problem	Suggestion
I hear noise in the handset, and none of the keys or buttons work.	<ul style="list-style-type: none">• Make sure the power cord is plugged in.
My handset does not ring when I receive a call.	<ul style="list-style-type: none">• Make sure you have the ringer activated. Refer to the section(s) on ringer selection in this user's manual.• Make sure the telephone line cord is plugged firmly into the base unit and the telephone jack. Make sure the power cord is plugged in.• You may be too far from the base unit.• Charge the battery in the handset for 16 hours. For optimum daily performance, return the handset to its base when not in use.• You may have too many extension phones on your telephone line to allow all of them to ring. Try unplugging some of the other phones.• The layout of your home or office might be limiting the operating range. Try moving the base to another location, preferably on an upper floor.• If the other phones in your home are having the issue, the problem is in your wiring or local service. Contact your local telephone company (charges may apply.)• Test a working phone at the phone jack. If another phone has the same problem, the problem is the phone jack. Contact your local telephone company (charges may apply.)• Other electronic products can cause interference with your cordless phone. Try installing your phone as far away from these types of electronic devices as possible: wireless routers, radios, radio towers, pager towers, cell phones, intercoms, room monitors, televisions, personal computers, kitchen appliances and other cordless phones• Your line cord might be malfunctioning. Try installing a new line cord.

Troubleshooting

Problem	Suggestion
My calls fade or cut in and out while I'm using my handset.	<ul style="list-style-type: none">• Press the CHAN button while on a call until the interference has been eliminated.• Other electronic products can cause interference with your cordless phone. Try installing your phone as far away from these types of electronic devices as possible: wireless routers, radios, radio towers, pager towers, cell phones, intercoms, room monitors, televisions, personal computers, kitchen appliances and other cordless phones• Microwaves operate on the same frequency as your phone. It is normal to experience static on your phone while the microwave is running. Do not install this phone in the same outlet or near the microwave.• If your phone is plugged in with a modem or surge protector, plug the phone (or modem/surge protector) into a different location. If this solves the problem, re-locate your phone or modem farther apart from one another, or use a different surge protector.• Relocate your phone to a higher location. The phone will get better reception not installed in a low area.• If the other phones in your home are having the issue, the problem is in your wiring or local service.
The charge light is off.	<ul style="list-style-type: none">• Clean the handset and base charging contact each month using a pencil eraser or cloth.• Make sure the power and line cords are plugged in correctly and firmly.• Reset the base. Unplug the unit's electrical power. Wait for 15 seconds then plug it back in. Allow up to one minute for the handset and base to reset.• Your phone might be malfunctioning. Please refer to the Warranty section of this user's manual for further instruction.

Troubleshooting

Problem	Suggestion
Common cure for electronic equipment.	<p>If the unit does not seem to be responding normally, then try putting the handset in its base. If it does not seem to respond, do the following (in the order listed):</p> <ol style="list-style-type: none"><li data-bbox="385 306 744 327">1. Disconnect the power to the base.<li data-bbox="385 334 1030 355">2. Disconnect the handset battery, and spare battery, if applicable.<li data-bbox="385 361 605 383">3. Wait a few minutes.<li data-bbox="385 389 681 410">4. Connect power to the base.<li data-bbox="385 417 663 438">5. Re-install the battery(ies).<li data-bbox="385 444 1295 487">6. Wait for the handset to re-establish its link with the base. To be safe, allow up to one minute for this to take place.

Maintenance

Taking care of your telephone

Your cordless telephone contains sophisticated electronic parts, so it must be treated with care.

Avoid rough treatment

Place the handset down gently. Save the original packing materials to protect your telephone if you ever need to ship it.

Avoid water

Your telephone can be damaged if it gets wet. Do not use the handset outdoors in the rain, or handle it with wet hands. Do not install your base unit near a sink, bathtub or shower.

Electrical storms

Electrical storms can sometimes cause power surges harmful to electronic equipment. For your own safety, use caution when using electric appliances during storms.

Cleaning your telephone

Your telephone has a durable plastic casing that should retain its luster for many years. Clean it only with a soft cloth slightly dampened with water or a mild soap. Do not use excess water or cleaning solvents of any kind.

Remember that electrical appliances can cause serious injury if used when you are wet or standing in water. If your base unit should fall into water, DO NOT RETRIEVE IT UNTIL YOU UNPLUG THE POWER CORD AND TELEPHONE LINE CORDS FROM THE WALL. Then pull the unit out by the unplugged cords.

Warranty

What does this limited warranty cover?

- The manufacturer of this VTech product, VTech Communications, warrants to the holder of a valid proof of purchase ("Consumer" or "you") that the product and all accessories provided by VTech in the sales package ("Product") are free from material defects in material and workmanship, pursuant to the following terms and conditions, when installed and used normally and in accordance with operation instructions. This limited warranty extends only to the Consumer for Products purchased and used in the United States of America.

What will VTech Communications do if the Product is not free from material defects in materials and workmanship during the limited warranty period ("Materially Defective Product")?

- During the limited warranty period, VTech's authorized service representative will repair or replace at VTech's option, without charge, a Materially Defective Product. If we repair this product, we may use new or refurbished replacement parts. If we choose to replace this product, we may replace it with a new or refurbished product of the same or similar design. VTech will return repaired or replacement products to you in working condition. VTech will retain defective parts, modules, or equipment. Repair or replacement of Product, at VTech's option, is your exclusive remedy. You should expect the repair or replacement to take approximately 30 days.

How long is the limited warranty period?

- The limited warranty period for the product extends for ONE (1) YEAR from the date of purchase if we repair or replace a Materially Defective Product under the terms of this limited warranty. This limited warranty also applies to repaired or replacement Products for a period of either (a) 90 days from the date the repaired or replacement Product is shipped to you or (b) the time remaining on the original one-year warranty; whichever is longer.

What is not covered by this limited warranty?

This limited warranty does not cover

1. Product that has been subjected to misuse, accident, shipping or other physical damage, improper installation, abnormal operation or handling, neglect, inundation, fire, water or other liquid intrusion; or
2. Product that has been damaged due to repair, alteration or modification by anyone other than an authorized service representative of VTech; or
3. Product to the extent that the problem experienced is caused by signal conditions, network reliability or cable or antenna systems; or
4. Product to the extent that the problem is caused by use with non-VTech electrical accessories; or

Warranty

5. Product whose warranty/quality stickers, Product serial numbers plates or electronic serial numbers have been removed, altered or rendered illegible; or
6. Product purchased, used, serviced, or shipped for repair from outside the United States, or used for commercial or institutional purposes (including but not limited to Products used for rental purposes); or
7. Product returned without valid proof of purchase (see 2 below); or
8. Charges for installation or set up, adjustment of customer controls, and installation or repair of systems outside the unit.

How do you get warranty service?

- To obtain warranty service in the United States of America, call 1-800-595-9511 for instructions regarding where to return the Product. Before calling for service, please check the user's manual. A check of the Product controls and features may save you a service call.
- Except as provided by applicable law, you assume the risk of loss or damage during transit and transportation and are responsible for delivery or handling charges incurred in the transport of Product (s) to the service location. VTech will return repaired or replaced product under this limited warranty to you, transportation, delivery or handling charges prepaid. VTech assumes no risk for damage or loss of the Product in transit.
- If the Product failure is not covered by this limited warranty, or proof of purchase does not meet the terms of this limited warranty, VTech will notify you and will request that you authorize the cost of repair prior to any further repair activity. You must pay for the cost of repair and return shipping costs for the repair of Products that are not covered by this limited warranty.

What must you return with the Product to get warranty service?

1. Return the entire original package and contents including the Product to the VTech service location along with a description of the malfunction or difficulty;
2. Include "valid proof of purchase" (sales receipt) identifying the Product purchased (Product model) and the date of purchase or receipt; and
3. Provide your name, complete and correct mailing address, and telephone number.

Other Limitations

- This warranty is the complete and exclusive agreement between you and VTech. It supersedes all other written or oral communications related to this Product. VTech provides no other warranties for this product. The warranty exclusively describes all of VTech's responsibilities regarding the product. There are no other express warranties. No one is authorized to make modifications to this limited warranty and you should not rely on any such modification.

State Law Rights: This warranty gives you specific legal rights, and you may also have other rights which vary from state to state.

Limitations: Implied warranties, including those of fitness for a particular purpose and merchantability (an unwritten warranty that the product is fit for ordinary use) are limited to one year from date of purchase. Some states do not allow limitations on how long an implied warranty lasts, so the above limitation may not apply to you.

- In no event shall VTech be liable for any indirect, special, incidental, consequential, or similar damages (including, but not limited to lost profits or revenue, inability to use the product, or other associated equipment, the cost of substitute equipment, and claims by third parties) resulting from the use of this product. Some states do not allow the exclusion or limitation of incidental or consequential damages, so the above limitation or exclusion may not apply to you.

Important safety instructions

When using your telephone equipment, basic safety precautions should always be followed to reduce the risk of fire, electric shock and injury, including the following:

1. Read and understand all instructions.
2. Follow all warnings and instructions marked on the product.
3. Unplug this product from the wall outlet before cleaning. Do not use liquid or aerosol cleaners. Use a damp cloth for cleaning.
4. Do not use this product near water (for example, near a bath tub, kitchen sink or swimming pool).
5. Do not place this product on an unstable surface, such as a table, shelf or stand. The product may fall, causing serious damage.
6. Slots and openings in the back or bottom of the base unit and handset are provided for ventilation. To protect them from overheating, these openings must not be blocked by placing the

Important safety instructions

product on a soft surface such as a bed, sofa or rug. This product should never be placed near or over a radiator or heat register. This product should not be placed in any area where proper ventilation is not provided.

7. This product should be operated only from the type of power source indicated on the marking label. If you are not sure of the type of power supply in your home, consult your dealer or local power company.
8. Do not allow anything to rest on the power cord. Do not install this product where the cord may have anyone walking on it.
9. Never push objects of any kind into this product through slots in the base or handset as they may touch dangerous voltage points or short out parts that could result in a risk of fire or electric shock. Never spill liquid of any kind on the product.
10. To reduce the risk of electric shock, do not disassemble this product, but take it to an authorized service facility. Opening or removing parts of the base or handset other than specified access doors may expose you to dangerous voltages or other risks. Incorrect reassembling can cause electric shock when the product is subsequently used.
11. Do not overload wall outlets and extension cords as this can result in the risk of fire or electric shock.
12. Unplug this product from the wall outlet and refer servicing to an authorized service facility under the following conditions:
 - A. When the power supply cord or plug is damaged or frayed.
 - B. If liquid has been spilled onto the product.
 - C. If the product has been exposed to rain or water.
 - D. If the product does not operate normally by following the operating instructions. Adjust only those controls that are covered by the operating instructions, as improper adjustment of other controls may result in damage and often requires extensive work by an authorized technician to restore the product to normal operation.
 - E. If the product has been dropped and the base and/or handset has been damaged.
 - F. If the product exhibits a distinct change in performance.
13. Avoid using a telephone (other than cordless) during an electrical storm. There is a remote risk of electric shock from lightning.
14. Do not use the telephone to report a gas leak in the vicinity of the leak.
15. Only put the handset of your telephone next to your ear when it is in normal talk.

SAVE THESE INSTRUCTIONS

FCC, ACTA and IC regulations

FCC Part 15

This equipment has been tested and found to comply with the requirements for a Class B digital device under Part 15 of the Federal Communications Commission (FCC) rules. These requirements are intended to provide reasonable protection against harmful interference in a residential installation. This equipment generates, uses and can radiate radio frequency energy and, if not installed and used in accordance with the instructions, may cause harmful interference to radio communications. However, there is no guarantee that interference will not occur in a particular installation. If this equipment does cause harmful interference to radio or television reception, which can be determined by turning the equipment off and on, the user is encouraged to try to correct the interference by one or more of the following measures:

- * Reorient or relocate the receiving antenna.
- * Increase the separation between the equipment and receiver.
- * Connect the equipment into an outlet on a circuit different from that to which the receiver is connected.
- * Consult the dealer or an experienced radio/TV technician for help.

FCC, ACTA and IC regulations

Changes or modifications to this equipment not expressly approved by the party responsible for compliance could void the user's authority to operate the equipment.

To ensure safety of users, the FCC has established criteria for the amount of radio frequency energy that can be safely absorbed by a user or bystander according to the intended usage of the product. This product has been tested and found to comply with the FCC criteria. The handset may be safely held against the ear of the user. The base unit shall be installed and used such that parts of the user's body other than the hands are maintained at a distance of approximately 20 cm (8 inches) or more. If you choose to use a clipping device, please make sure to only use the supplied VTech belt clip.

FCC Part 68 and ACTA

This equipment complies with Part 68 of the FCC rules and with technical requirements adopted by the Administrative Council for Terminal Attachments (ACTA). The label on the back or bottom of this equipment contains, among other things, a product identifier in the format US:AAAEQ##TXXXX. This identifier must be provided to your local telephone company upon request.

The plug and jack used to connect this equipment to premises wiring and the telephone network must comply with applicable Part 68 rules and technical requirements adopted by ACTA. A compliant telephone cord and modular plug is provided with this product. It is designed to be connected to a compatible modular jack that is also compliant. An RJ11 jack should normally be used for connecting to a single line and an RJ14 jack for two lines. See Installation Instructions in the user's manual.

The Ringer Equivalence Number (REN) is used to determine how many devices you may connect to your telephone line and still have them ring when you are called. The REN for this product is encoded as the 6th and 7th characters following the US: in the product identifier (e.g., if ## is 03, the REN is 0.3). In most, but not all areas, the sum of all RENs should be five (5.0) or less. For more information, please contact your local telephone company.

This equipment may not be used with Party Lines. If you have specially wired alarm dialing equipment connected to your telephone line, ensure the connection of this equipment does not disable your alarm equipment. If you have questions about what will disable alarm equipment, consult your telephone company or a qualified installer.

If this equipment is malfunctioning, it must be unplugged from the modular jack until the problem has been corrected. Repairs to this telephone equipment can only be made by the manufacturer or its authorized agents. For repair procedures, follow the instructions outlined under the Limited Warranty.

If this equipment is causing harm to the telephone network, the telephone company may temporarily discontinue your telephone service. The telephone company is required to notify you before interrupting service. If advance notice is not practical, you will be notified as soon as possible. You will be given the opportunity to correct the problem and the telephone company is required to inform you of your right to file a complaint with the FCC. Your telephone company may make changes in its facilities, equipment, operation, or procedures that could affect the proper functioning of this product. The telephone company is required to notify you if such changes are planned.

If this product is equipped with a corded or cordless handset, it is hearing aid compatible.

If this product has memory dialing locations, you may choose to store emergency telephone numbers (e.g., police, fire, medical) in these locations. If you do store or test emergency numbers, please:

- * Remain on the line and briefly explain the reason for the call before hanging up.
- * Perform such activities in off-peak hours, such as early morning or late evening.

Industry Canada

This equipment complies with regulations RSS210 and CS-03 of Industry Canada. Operation is subject to the following two conditions: (1) this device may not cause interference, and (2) this device must accept any interference, including interference that may cause undesired operation of the device.

The term "IC:" before the certification/registration number only signifies that the Industry Canada technical specifications were met.

The Ringer Equivalence Number (REN) for this terminal equipment is 0.1. The REN is an indication of the maximum number of devices allowed to be connected to a telephone interface. The termination on an interface may consist of any combination of devices subject only to the requirement that the sum of the RENs of all the devices does not exceed five.

The RBRC® Seal



The RBRC® Seal on the nickel-cadmium battery indicates that VTech Communications, Inc. is voluntarily participating in an industry program to collect and recycle these batteries at the end of their useful lives, when taken out of service within the United States and Canada.

The RBRC® program provides a convenient alternative to placing used nickel-cadmium batteries into the trash or municipal waste, which may be illegal in your area.

VTech's participation in RBRC® makes it easy for you to drop off the spent battery at local retailers participating in the RBRC® program or at authorized VTech product service centers. Please call **1-800-8-BATTERY™** for information on Ni-Cd battery recycling and disposal bans/restrictions in your area. VTech's involvement in this program is part of its commitment to protecting our environment and conserving natural resources.

RBRC® is a registered trademark of Rechargeable Battery Recycling Corporation.

Technical specifications

Enhanced 2.4GHz Technology - Dual band transmission combines the best of 2.4GHz and 900MHz technologies, providing enhanced performance over standard cordless telephones.

Frequency Control	Crystal controlled PLL synthesizer
Transmit Frequency	Base: 2410.2-2418.9 MHz Handset: 912.75-917.10 MHz
Receive Frequency	Base: 912.75-917.10 MHz Handset: 2410.2-2418.9 MHz
Channels	30
Nominal Effective Range	Maximum power allowed by the FCC and IC. Actual operating range may vary according to environmental conditions at the time of use.
Size	Handset: 167mm X 57mm X 37mm Base: 131mm X 130mm X 84mm (including antenna)
Weight	Handset: 130 grams Base: 165 grams
Power Requirements	Handset: 400mAh Ni-Cd Battery Base: 9V AC @ 250mA
Memory	Directory: 20 Memory locations including the 9 speed dial locations up to 24 digits, 15 characters per location Caller ID: 45 Memory locations

Index

A

Additional information 29-40

B

Base features 10

Basic operation 11-28

Belt clip 28

C

Call log 24

Caller ID 24

Choose a location 6

Connection 7

D

Delete a directory entry 21

Delete a speed dial entry 17

Dial a directory number 22

Dial a displayed number 25

Dial a speed dial number 18

Dial mode 12

Directory 19

Displaying screen
messages 14,26

DSL 7

E

Edit a directory entry 21

42

F

FCC, ACTA and IC
regulations 38

G

Getting started 4-10

H

Handset features 9

Headset operation 28

I

If you subscribe to DSL
service 7

Important safety instructions 37

Index 42

Install handset battery 5

Installation 5-8

Internet 7

L

Language 13

Low battery warning 6

M

Maintenance 36

Move a directory entry to

speed dial 23

N

Noise filter 7

O

Operating range 13

P

Parts checklist 4

R

Re-assign speed dial
locations 18

Removable handset and base
plates 8

Remove records from
call history 25

Review call log 24

Ringer options 27

S

Set date and time 11

Set handset ringer 11

Speed dial 15

Store a call log record in the
directory 25

www.vtechphones.com

Store a directory entry 19
Store a speed dial entry 15

T

Technical specifications 41
Telephone operation 12-14
Temporary tone dialing 12
The RBRC® Seal 40
Troubleshooting 29

W

Warranty 36

VTECH TELECOMMUNICATIONS LTD.

A member of THE VTECH GROUP OF COMPANIES

Distributed in the U.S.A. by VTech Communications, Inc. Beaverton, Oregon
Distributed in Canada by VTech Telecommunications Canada Ltd., Richmond, B.C.

Copyright ©2006 for VTECH TELECOMMUNICATIONS LTD.
Printed in China.

91-000632-010-000

vtech[®]
Innovation Beyond Technology™

Free Manuals Download Website

<http://myh66.com>

<http://usermanuals.us>

<http://www.somanuals.com>

<http://www.4manuals.cc>

<http://www.manual-lib.com>

<http://www.404manual.com>

<http://www.luxmanual.com>

<http://aubethermostatmanual.com>

Golf course search by state

<http://golfingnear.com>

Email search by domain

<http://emailbydomain.com>

Auto manuals search

<http://auto.somanuals.com>

TV manuals search

<http://tv.somanuals.com>