

# **Congratulations**

on purchasing your new VTech product.  
Before using this telephone, please read the  
**Important safety instructions**  
on page 31 of this manual.

This manual has all the feature operations and troubleshooting necessary to install and operate your new VTech telephone. Please review this manual thoroughly to ensure proper installation and operation of this innovative and feature rich VTech product. For support, shopping, and everything new at VTech, visit our website at [www.vtechphones.com](http://www.vtechphones.com). In Canada, please visit [www.vtechcanada.com](http://www.vtechcanada.com).

# Table of contents

Installation . . . . .	1	Call waiting . . . . .	14
Parts checklist . . . . .	1	Intercom call . . . . .	15
Install handset battery . . . . .	2	Multiple handset use . . . . .	15
Telephone base installation . . . . .	3	Answer an external call during an intercom call . . . . .	15
Desk/table bracket installation . . . . .	4	Transfer an external call . . . . .	16
Dial type . . . . .	4	Find handset . . . . .	16
DSL filter . . . . .	5	Advanced operation . . . . .	17
Telephone settings . . . . .	6	Directory . . . . .	17
Handset layout . . . . .	6	Review the directory . . . . .	17
Telephone base layout . . . . .	7	Search the directory . . . . .	17
Date and time . . . . .	8	Character chart . . . . .	18
Ring melody . . . . .	8	Store a directory entry . . . . .	19
Ring volume . . . . .	9	Dial a directory entry . . . . .	19
Battery low tone . . . . .	9	Edit a directory entry . . . . .	20
Out of range tone . . . . .	10	Delete from the directory . . . . .	20
Key tone . . . . .	10	About caller ID . . . . .	21
Edit handset name . . . . .	11	Call log . . . . .	22
Language . . . . .	11	Review the call log . . . . .	22
Dial type . . . . .	12	Dial from the call log . . . . .	23
Clear voicemail . . . . .	12	Store a call log number . . . . .	23
Reset to default settings . . . . .	13	Delete from the call log . . . . .	24
Temporary tone dialing . . . . .	13	Redial . . . . .	25
Basic operation . . . . .	14	Review redial . . . . .	25
Make, answer and end calls . . . . .	14	Store a redial number to the directory . . . . .	25
Options while on calls . . . . .	14	Dial a redial number . . . . .	26
Speakerphone . . . . .	14	Delete from redial . . . . .	26
Mute . . . . .	14	Handset and telephone base indicators . . . . .	27

## Table of contents

Handset light . . . . .	27
Telephone base lights . . . . .	27
Handset icons . . . . .	27
Handset display screen messages. . . . .	28
Call log display screen messages . . . . .	29
Battery . . . . .	30
Important safety instructions. . . . .	31
Troubleshooting . . . . .	32
Operating range . . . . .	41
Maintenance . . . . .	41
About cordless telephones. . . . .	42
Warranty . . . . .	42
FCC, ACTA and IC regulations. . . . .	44
The RBRC® seal . . . . .	45
Technical specifications . . . . .	46
Index . . . . .	47

# Installation

## Parts checklist

Remember to save your sales receipt and original packaging in case it is necessary to ship your telephone for warranty service. Check to make sure the telephone package includes the following:

1. Handsets  
(2 for 6041/6044, 3 for 6051)
2. Chargers  
(1 for 6041/6044, 2 for 6051)
3. Charger adapters  
(1 for 6041/6044, 2 for 6051)
4. Base power adapter
5. Telephone line cord
6. Batteries  
(2 for 6041/6044, 3 for 6051)
7. Battery compartment covers  
(2 for 6041/6044, 3 for 6051)
8. Telephone base
9. User's manual



1. Handsets

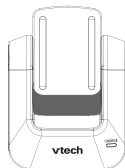

2. Chargers



3. Charger adapters

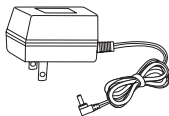

4. Base power adapter



5. Telephone line cord



6. Batteries

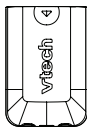

7. Battery compartment covers

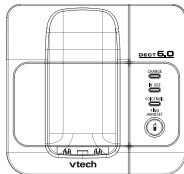

8. Telephone base



9. User's manual

## note

- To purchase replacement batteries, or obtain a replacement power adapter, visit our website at [www.vtechphones.com](http://www.vtechphones.com) or call 1 (800) 595-9511. In Canada go to [www.vtechcanada.com](http://www.vtechcanada.com) or dial 1 (800) 267-7377.
- For 6044, the battery compartment covers are attached to the handsets.

## note

- If the handset will not be used for a long period of time, remove the battery to prevent possible leakage.
- To purchase replacement batteries, visit our website at [www.vtechphones.com](http://www.vtechphones.com) or call 1 (800) 595-9511. In Canada go to [www.vtechcanada.com](http://www.vtechcanada.com) or dial 1 (800) 267-7377.

## Installation

### Install handset battery

- Remove battery compartment cover by pressing on the indentation and sliding it downwards (only for 6044).
- Align the two holes in the plug with the socket pins according to the color-coded label in the battery compartment, then snap the plug into place.
- Place the battery into the compartment.
- Position the battery compartment cover and slide it upwards until it clicks into place.
- Put the handset in the telephone base or the charger to charge the new battery for at least 16 hours. The battery may have enough charge for short calls. For best performance, charge it for at least 16 hours.

You can keep the battery charged by returning the handset to the telephone base or charger after each use. When the battery power is fully depleted, a full recharge takes about 16 hours.

For further information on batteries, please see the **Battery** section on page 30.

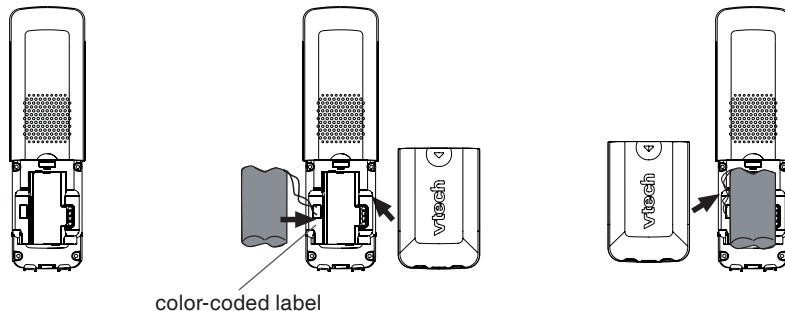

# Installation

## Telephone base installation

Install the telephone base and the charger as shown below. Choose a location away from any electronic equipment and appliances such as personal computers, computer routers, television sets, microwave ovens, and refrigerators. Avoid excessive heat, cold, dust or moisture.

1. Plug the telephone line cord into a telephone wall jack.

2. Plug the power adapter into an electrical outlet not controlled by a wall switch.

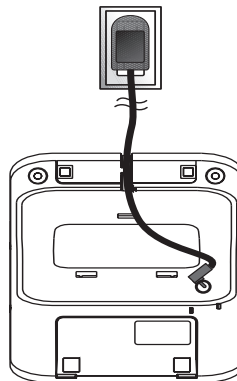
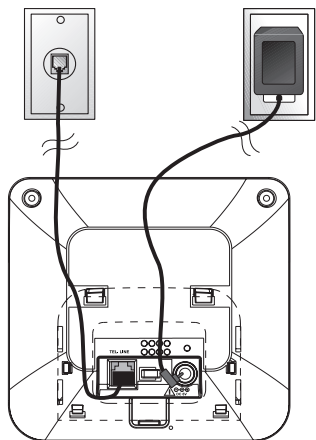

### note

- Use only the VTech batteries and power adapters (or equivalent) supplied with this telephone. To obtain a replacement, visit our website at [www.vtechphones.com](http://www.vtechphones.com) or call 1 (800) 595-9511. In Canada go to [www.vtechcanada.com](http://www.vtechcanada.com) or dial 1 (800) 267-7377.
- This power unit is intended to be correctly oriented in a vertical or floor mount position. The prongs are not designed to hold the plug in place if it is plugged into a ceiling, under-the-table or cabinet outlet.

# Installation

## Desk/table bracket installation

The telephone base comes with the desk/table bracket installed and ready for tabletop use.

To remove the bracket:

1. Push the bracket away from the telephone base as shown below. Do not remove the bracket by force to avoid breakage of the tabs.

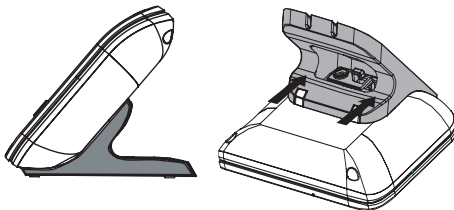

To install the bracket:

1. Align the tabs of the bracket with the slots at the bottom of the telephone base as shown in the diagram.
2. Slide the bracket towards the center of the telephone base until it clicks into place.

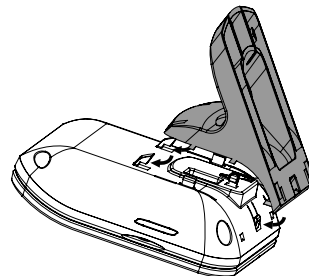

## Dial type

If you have touch-tone service, your telephone is ready to use as soon as the battery is charged. If you have pulse (rotary) service, the dial type must be changed. To change the dial type, see **Dial type** on page 12.

## Installation

### If you subscribe to DSL service

If you receive high speed internet through your telephone line (commonly referred to as DSL), and you are experiencing interference during telephone conversations and/or your caller ID features are not functioning properly, install a DSL filter to the telephone line between the telephone base and the telephone wall jack. Contact your DSL provider for a DSL filter.

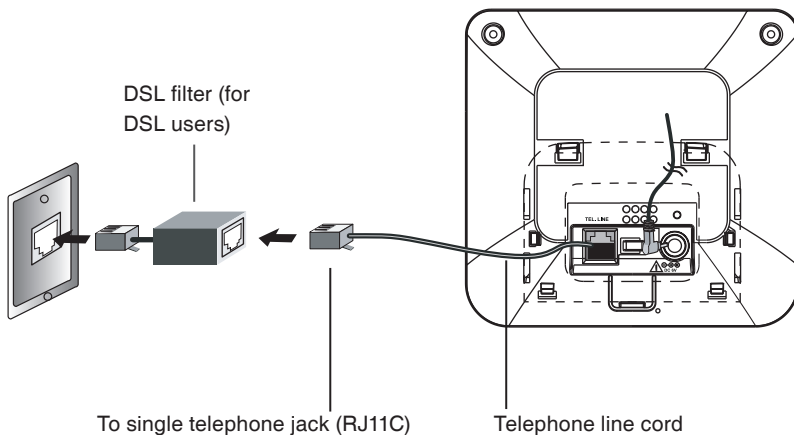



# Telephone settings

## Handset layout

1. Earpiece
2. /▲ (directory/volume)
3. (speakerphone)
4. /FLASH
5. Dialing keys (0-9, \*, #)
6. REDIAL/PAUSE
7. Microphone
8. Handset display
9. MENU/SELECT
10. CID/▼ (caller ID/volume)
11. OFF/CLEAR
12. MUTE/REMOVE
13. INT (intercom)

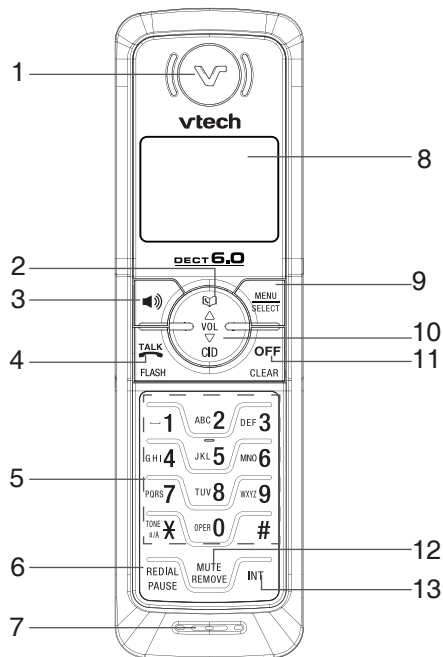

# Telephone settings

## Telephone base layout

1. CHARGE light
2. IN USE light
3. VOICEMAIL light
4. FIND HANDSET

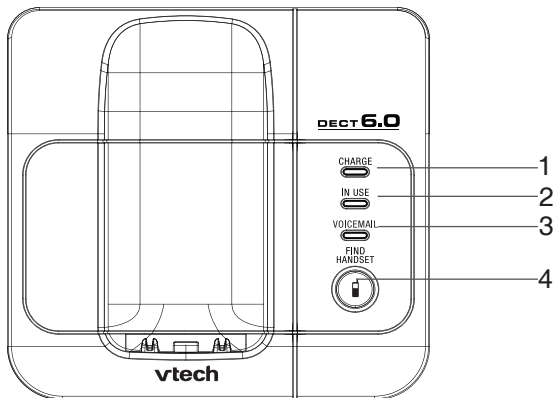

## note

- When entering the date or time, if the digit is single, a zero must be entered first (i.e. if the time is 6:08, you must enter **0608**).
- If you have more than one handset, setting the date and time on one handset will apply to all other handsets.

# Telephone settings

## Date and time

- Press **MENU/SELECT** to display menu when in idle mode.
- Press ▼ or ▲ to reach **DATE/TIME**. Press **MENU/SELECT**.
- Use the keypad to set the year. Press **MENU/SELECT**.
- Use the keypad to set the date. Press **MENU/SELECT**.
- Use the keypad to set the time. Press ▼ or ▲ to select a.m. or p.m. Press **MENU/SELECT**.
- The screen displays **STORED** and you'll hear a confirmation beep.

## Ring melody

There are ten ring melodies for the handset to choose from.

- Press **MENU/SELECT** to display menu when in idle mode.
- Press ▼ or ▲ to reach **SETUP HS**. Press **MENU/SELECT**.
- Press ▼ or ▲ to reach **RING MELODY**. Press **MENU/SELECT**, and a checkmark is shown next to the current ring melody.
- Press ▼ or ▲ to scroll through the choices and a sample of each ring melody will be played. Press **MENU/SELECT**.
- The screen displays **STORED** and you'll hear a confirmation beep.



## Telephone settings

### Ring volume

The handset ringer volume can be adjusted from five levels.

- Press **MENU/SELECT** to display menu when in idle mode.
- Press **▼** or **▲** to reach **SETUP HS.** Press **MENU/SELECT.**
- Press **▼** or **▲** to reach **RING VOLUME.** Press **MENU/SELECT.**
- Press **▼** or **▲** to scroll through the choices and a sample of each ring volume will be played. Press **MENU/SELECT** to confirm.
- The screen displays **STORED** and you'll hear a confirmation beep.



### Battery low tone

The handset is preset to beep when the battery level is low. If you wish to change this setting:

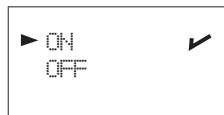
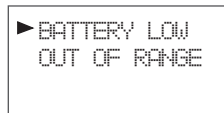
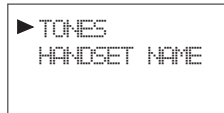
- Press **MENU/SELECT** to display the menu when in idle mode.
- Press **▼** or **▲** to reach **SETUP HS.** Press **MENU/SELECT.**
- Press **▼** or **▲** to reach **TONES.** Press **MENU/SELECT.**
- Press **▼** or **▲** to reach **BATTERY LOW.** Press **MENU/SELECT.**
- A checkmark is shown next to the current selection. Press **▼** or **▲** to choose **ON** or **OFF.** Press **MENU/SELECT.**
- The screen displays **STORED** and you'll hear a confirmation beep.



### note

- The handset will not ring when the ringer volume is at the lowest setting. A ringer off icon  will be displayed.
- While the telephone is ringing, you can temporarily silence the ringer by pressing **OFF/CLEAR** or **MUTE/REMOVE.** The ringer off icon  will display on the handset. The next call will ring normally.

## note

- Press **OFF/CLEAR** at anytime to return to the previous screen.
- Press and hold **OFF/CLEAR** at anytime to exit the menu.

# Telephone settings

## Out of range tone

The handset will beep during a conversation when it is out of range from the telephone base. This tone is preset to **ON**. If you wish to change this setting:

- Press **MENU/SELECT** to display the menu when in idle mode.
- Press ▼ or ▲ to reach **SETUP HS**. Press **MENU/SELECT**.
- Press ▼ or ▲ to reach **TONES**. Press **MENU/SELECT**.
- Press ▼ or ▲ to reach **OUT OF RANGE**. Press **MENU/SELECT**.
- A checkmark is shown next to the current selection. Press ▼ or ▲ to choose **ON** or **OFF**. Press **MENU/SELECT**.
- The screen displays **STORED** and you'll hear a confirmation beep.

## Key tone

The handset is preset to beep whenever any button is pressed. To change this setting:

- Press **MENU/SELECT** to display the menu when in idle mode.
- Press ▼ or ▲ to reach **SETUP HS**. Press **MENU/SELECT**.
- Press ▼ or ▲ to reach **TONES**. Press **MENU/SELECT**.
- Press ▼ or ▲ to reach **KEY BEEPS**. Press **MENU/SELECT**.
- A checkmark is shown next to the current selection. Press ▼ or ▲ to select **ON** or **OFF**. Press **MENU/SELECT**.
- The screen displays **STORED** and you'll hear a confirmation beep.



▶ TONES  
HANDSET NAME



▶ OUT OF RANGE  
KEY BEEPS



▶ ON      ✓  
OFF

## Telephone settings

### Edit handset name

- Press **MENU/SELECT** to display the menu when in idle mode.
- Press **▼** or **▲** to reach **SETUP HS.** Press **MENU/SELECT.**
- Press **▼** or **▲** to reach **HANDSET NAME.** Press **MENU/SELECT.**
- Press **MUTE/REMOVE** to backspace and erase characters. Press and hold **MUTE/REMOVE** to delete the entire entry. Press **\*** to alternate between uppercase and lowercase.
- Use the keypad to enter characters (see the chart on page 18). Press **MENU/SELECT.**
- The screen displays **STORED** and you'll hear a confirmation beep.

### Language

To change the language for all screen displays:

- Press **MENU/SELECT** to display menu when in idle mode.
- Press **▼** or **▲** to reach **SETUP HS.** Press **MENU/SELECT.**
- Press **▼** or **▲** to reach **LANGUAGE.** Press **MENU/SELECT.**
- A checkmark is shown next to the current selection. Press **▼** or **▲** to choose the desired language.
- Press **MENU/SELECT.**
- The screen displays **STORED** and you'll hear a confirmation beep.

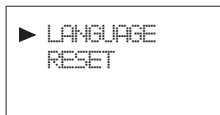
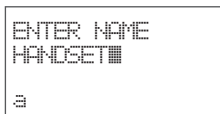
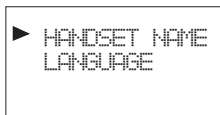

### note

- A handset name can be up to 14 characters.
- Only handset display screens are affected by the language setting.

## note

- The clear voicemail feature only turns off the displayed **NEW VOICEMAIL** message and **VOICEMAIL** light on the telephone base. It does not delete your voicemail message(s). Use this feature when the telephone indicates there is voicemail when you have none or you have accessed your voicemail from a remote location (while away from home). If there is actually a new voicemail message, your local telephone company will continue to send a signal which will cause the **NEW VOICEMAIL** message in the handset and the telephone base **VOICEMAIL** light to flash.

## Telephone settings

### Dial type

The dial type is preset to touch tone. If you have pulse (rotary) service, the dial type must be changed.

- Press **MENU/SELECT** to display menu when in idle mode.
- Press ▼ or ▲ to reach **SETUP BS.** Press **MENU/SELECT.**
- Press ▼ or ▲ to reach **DIAL TYPE.** Press **MENU/SELECT.**
- A checkmark is shown next to the current selection. Press ▼ or ▲ to choose between **TONE** and **PULSE.** Press **MENU/SELECT.**
- The screen displays **STORED** and you'll hear a confirmation beep.

### Clear voicemail

If you subscribe to voicemail services provided by your local telephone company, **NEW VOICEMAIL** will appear on the handset display and the **VOICEMAIL** light on the telephone base will flash when you have a new voicemail message. This feature allows you to turn off these indicators.

- Press **MENU/SELECT** to display the menu when in idle mode.
- Press ▼ or ▲ to reach **SETUP BS.** Press **MENU/SELECT.**
- Press ▼ or ▲ to reach **CLR VOICEMAIL.** Press **MENU/SELECT.**
- The screen displays **INDICATOR OFF?** Press **MENU/SELECT.**
- The screen displays **STORED** and you'll hear a confirmation beep.

► DIAL TYPE  
CLR VOICEMAIL

► TONE  
PULSE ✓

► CLR VOICEMAIL  
RESET

INDICATOR OFF?

## Telephone settings

### Reset to default settings

The handset and the telephone base can be individually reset to their default settings by selecting **RESET** in the **SETUP HS** or **SETUP BS** menus respectively.

- Press **MENU/SELECT** to display menu when in idle mode.
- Press **▼** or **▲** to reach **SETUP HS** or **SETUP BS**. Press **MENU/SELECT**.
- Press **▼** or **▲** to reach **RESET**. Press **MENU/SELECT**.
- The screen displays **RESET?** Press **MENU/SELECT** to confirm or **OFF/CLEAR** to exit to the previous menu.
- The screen displays **STORED** and you'll hear a confirmation beep.

### Temporary tone dialing

If you have pulse (rotary) service, you can change from pulse to touch tone dialing during a call by pressing **\*TONE**. This is useful if you need to send touch tone signals for access to telephone banking or long distance services.

- Press **TALK/FLASH**.
- Press **\*TONE**. Buttons pressed after this send touch tone signals.
- Dial the number.
- After hanging up, the telephone automatically returns to pulse dial service.

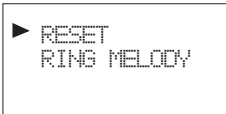

▶ RESET  
RING MELODY



RESET?

### note

- When the handset or telephone base settings are reset to default, all items stored in memory will be deleted. This includes the directory and call log entries.





## note

- Press ▼ or ▲ to adjust the listening volume during a conversation.

## Basic operation

### Make, answer and end calls

- Press **TALK/FLASH** or , then use the keypad to dial a number.  
-OR-
- Dial a number (press **MUTE/REMOVE** to make corrections) and then press **TALK/FLASH** or .
- Press **TALK/FLASH**,  or any dialing keys (0-9, \* or #) to answer an incoming call.
- Press **OFF/CLEAR** or put the handset back in the telephone base or charger to end a call.
- The call timer will be activated during a call to show call duration.

### Options while on calls

#### Speakerphone

- Press  to alternate between speakerphone and normal handset use.

#### Mute

- Press **MUTE/REMOVE** on the handset to silence the microphone during a conversation. You can still hear the caller but the caller cannot hear you.
- The screen displays **MUTE**.
- Press **MUTE/REMOVE** again to resume conversation.

#### Call waiting

If you subscribe to call waiting service and you are on a call when a new call comes in, you will hear a beep. The caller ID information will be displayed if you subscribe to caller ID service from your local telephone company.

- Press **TALK/FLASH** on the handset to answer the incoming call and put the current call on hold.
- Press **TALK/FLASH** at anytime to alternate between calls.

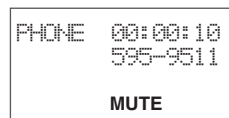
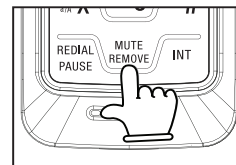
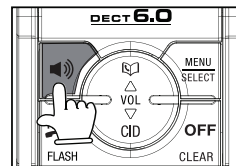
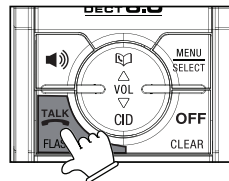

## Basic operation

### Intercom call

This feature allows conversation between handsets.

- For 6051, press **INT** on a handset and its screen displays **NUMBER**.
- Use the keypad to select a destination handset. The screen of the originating handset displays **CALLING HANDSET X**.
- For 6041/6044, press **INT** on a handset and its screen displays **CALLING HANDSET X**.
- The destination handset rings and its screen displays **CALLING FROM: HANDSET X**.
- Press **TALK/FLASH** or **Ⓜ** on the destination handset to answer the call.
- To end an intercom call, press **OFF/CLEAR** on the handset or by placing the handset back on the telephone base or charger.

```
CALLING  
HANDSET X
```

```
CALLING FROM:  
HANDSET X
```

```
CONF 00:02:48
```

### Multiple handset use

While on a call, the person on the other handset can join the conversation.

- Press **TALK/FLASH** or **Ⓜ** to join the conversation. (Only two handsets can join the conference conversation at the same time.)
- Press **OFF/CLEAR**, or place the handset in the telephone base or charger to drop out of the call. The external call will not be terminated until both handsets hang up.

### Answer an external call during an intercom call

There will be an alert tone to signify an incoming external call during an intercom call and the screen displays **CALL WAITING**.

- Disconnect the intercom call by pressing **OFF/CLEAR** and the handset will ring.
- Press **TALK/FLASH, Ⓜ** or any dialing keys (**0-9, \* or #**) to answer the incoming call.

## note

- If the destination handset does not answer, press **OFF/CLEAR** on the originating handset to return to the external call.

## Basic operation

### Transfer an external call

An external call can be forwarded to another handset during a conversation.

- For 6041/6044, press **INT** on the originating handset and its screen displays **CALLING HANDSET X** while putting the external call on hold.
- For 6051, press **INT** on the originating handset and its screen displays **NUMBER** while putting the external call on hold. Use the keypad to select a destination handset and its screen will display **CALLING HANDSET X**.
- The destination handset rings and its screen displays **CALLING FROM: HANDSET X**.
- After the destination handset answers, press **MENU/SELECT** and then press **▼** or **▲** to reach **CONFERENCE**.
- Press **MENU/SELECT** to let the destination handset join the conversation.
- Press **MENU/SELECT** and the screen displays **END CONFERENCE** and then press **MENU/SELECT** to return to the intercom conversation.
- During the intercom conversation, press **MENU/SELECT** and **▼** or **▲** to reach **OTHER CALL** to return to the external call and put the intercom on hold. Repeat this step to switch between the external and intercom calls.
- Press **OFF/CLEAR** on the originating handset to forward the external call to the destination handset.

### Find handset

- Press **FIND HANDSET** on the telephone base to locate the handset. All handsets will ring and **PAGING** will flash on the screen of all handsets.
- Press **FIND HANDSET** again or put the handsets back on the telephone base or charger to stop the paging tone.

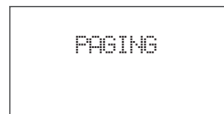
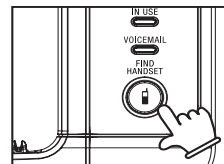
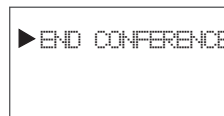
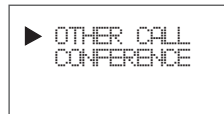
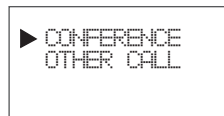

# Advanced operation

## Directory

The directory can store up to 50 entries. Each entry may consist of a number up to 24 digits and a name up to 15 characters.

- The screen displays **EMPTY** if there is no record in the directory.
- The screen displays **FULL** if the directory is full.

## Review the directory

- Press / to enter the directory.
  - Press or to browse and press **OFF/CLEAR** to exit.
- OR-**
- Press **MENU/SELECT** to display menu when in idle mode.
  - Press or to reach **DIRECTORY**. Press **MENU/SELECT**.
  - Press or to reach **REVIEW**. Press **MENU/SELECT**.
  - Press or to browse and press **OFF/CLEAR** to exit.

## Search the directory

Entries are sorted alphabetically and names beginning with numbers are listed first.

An alphabetical search can be done after entering the directory. Enter the first letter of the name using the chart on page 18. The first name beginning with that letter will be displayed.

For example, press 5 (JKL) once to find Jenny, twice to find Kristen, or three times to find Linda.

**-OR-**

You can search the directory by pressing or on the handset.



EMPTY



▶ DIRECTORY  
CALL LOG



▶ REVIEW  
STORE



VTECH  
1-595-9511

## note

- Press \* repeatedly to alternate between uppercase and lowercase when entering characters.

# Advanced operation

## Character chart

Use the keypad and the chart below to enter a name (up to 15 characters). Each press of a particular key causes the characters to be displayed in the following order:

Number key	Characters by number of key presses								
	1	2	3	4	5	6	7	8	9
1	space	1	*	?	!	/	(	)	
2	A	B	C	2					
3	D	E	F	3					
4	G	H	I	4					
5	J	K	L	5					
6	M	N	O	6					
7	P	Q	R	S	7				
8	T	U	V	8					
9	W	X	Y	Z	9				
0	0								
*	Uppercase/lowercase								
#	#	'	,	-	.	&			

- Press **MUTE/REMOVE** to backspace and erase a single character.
- Press and hold **MUTE/REMOVE** to delete the entire entry.
- Press and hold **REDIAL/PAUSE** to insert a dialing pause (**P** will be displayed on screen) when entering a telephone number.

## Advanced operation

### Store a directory entry

- Press **MENU/SELECT** twice to enter the **DIRECTORY**.
- Press **▼** or **▲** to reach **STORE** and then press **MENU/SELECT**.
- The screen displays **ENTER NUMBER**. Use the keypad to enter the number and then press **MENU/SELECT**.
- The screen displays **ENTER NAME**. Use the keypad to enter the characters and then press **MENU/SELECT**.
- The screen displays **STORED** and you'll hear a confirmation beep.

### Dial a directory entry

- Press **📖/▲** to enter the directory.
  - Press **▼** or **▲** to scroll to the desired entry, or use the alphabetical search to find it.
  - Press **TALK/FLASH** or **📞** to dial.
- OR-**
- Press **MENU/SELECT** to display menu when in idle mode.
  - Press **▼** or **▲** to reach **DIRECTORY**. Press **MENU/SELECT**.
  - Press **▼** or **▲** to reach **REVIEW**. Press **MENU/SELECT**.
  - Press **▼** or **▲** to scroll to the desired entry, or use the alphabetical search to find it.
  - Press **TALK/FLASH** or **📞** to dial.

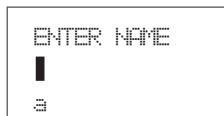
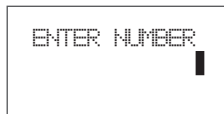
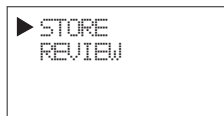





## note

- Press **OFF/CLEAR** to return to the previous screen. Press and hold OFF/CLEAR to exit the menu if you do not want to delete all the entries.



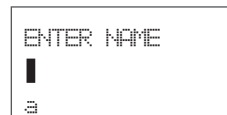
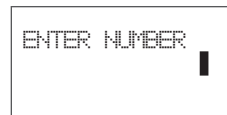

# Advanced operation

## Edit a directory entry

- Press  /  or **MENU/SELECT** three times to enter the directory.
- Press  or  to scroll to the desired entry or use the alphabetical search to find the number. Press **MENU/SELECT**.
- The screen displays **ENTER NUMBER**. Use **MUTE/REMOVE** and the keypad to edit the number and press **MENU/SELECT**.
- The screen displays **ENTER NAME**. Use **MUTE/REMOVE** and the keypad to edit the name and then press **MENU/SELECT**.
- The screen displays **STORED** and you'll hear a confirmation beep.



## Delete from the directory

- Press  /  or **MENU/SELECT** three times to enter the directory.
- Press  or  to scroll to the desired entry.

### To delete one entry

- Press **MUTE/REMOVE**.
- The screen displays **DELETED** and you'll hear a confirmation beep.

### To delete all entries

- Press and hold **MUTE/REMOVE**.
- The screen displays **DELETE ALL?** Press **MENU/SELECT**.
- The screen displays **DELETED** and there is a confirmation beep.

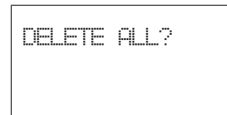
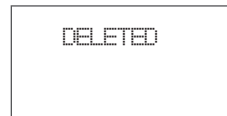
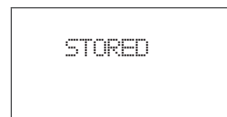

# Advanced operation

## About caller ID

If you subscribe to caller ID service from your local telephone company, this feature displays the name and telephone number of the caller before answering a call (even when you are on another call). The caller ID features of this product will work only if you subscribe to caller ID service and both you and the caller are in areas offering caller ID service, and if both telephone companies use compatible equipment.

Contact your local telephone company if:

- you have both caller ID and call waiting, but as separate services (you may need combined service),
- you have only caller ID service, or only call waiting service,
- you do not subscribe to caller ID or call waiting services but wish to try them.

There may be fees for these services, and they may not be available in all areas.

This product can be used without subscribing to either caller ID or combined caller ID with call waiting service, although the caller ID features of this product will not function.



## note

- Due to regional service differences, the caller ID information may not be available for every incoming call. In addition, the callers may intentionally block their name and/or telephone number.
- The time is automatically set and updated with incoming caller ID information if you subscribe to this service.

## Advanced operation

### Call log

The information of the caller will be displayed if you subscribe to caller ID service from your local telephone company.

- The call log can store up to 50 entries.
- Each entry may consist of a number up to 20 digits and a name up to 15 characters. If the number consists of more than 20 digits, the last 20 digits will be displayed and stored. If the name consists of more than 15 characters, the first 15 characters will be displayed and stored.
- Entries are displayed in chronological order with the most recent entry first.
- When the call log is full, the oldest entry will be deleted to make room for the new incoming call information.
- The screen displays **EMPTY** if there is no record in the call log.
- The screen displays **NEW** if there are new call log entries (missed and unread calls).
- Duplicate or anonymous calls (no caller ID information) will be stored in the call log.

### Review the call log

- Press **CID/▼** to enter the call log.
- OR-
- Press **MENU/SELECT**. Press **▼** or **▲** to select **CALL LOG**.
- Press **MENU/SELECT** and then press **▼** or **▲** to browse through the entries.
- The name (if available), number, date and time of the incoming call are displayed on the screen.



JOHNNY FU  
2-345-6789  
NEW  
05:27PM 11/23



EMPTY

## Advanced operation

### Dial a call log number

- Press **CID/▼** to enter the call log.
- OR-
- Press **MENU/SELECT**. Press ▼ or ▲ to select **CALL LOG**.
- Press **MENU/SELECT** and then press ▼ or ▲ to scroll to the desired entry.
- Press **TALK/FLASH** or **📞** to dial.

### Store a call log number

- Press **CID/▼** to enter the call log.
- OR-
- Press **MENU/SELECT**. Press ▼ or ▲ to select **CALL LOG**.
- Press **MENU/SELECT** and then press ▼ or ▲ to scroll to the desired entry.
- Press **MENU/SELECT** and the screen displays **ENTER NAME**.
- Use the keypad to enter the name and then press **MENU/SELECT**.
- The screen displays **STORED** and you'll hear a confirmation beep.

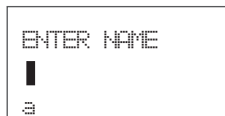

```
ENTER NAME
|
a
```



```
STORED
```

### note

- While reviewing the call log, press **#** repeatedly to display the other dialing options. Available options are: 1 + area code + number, area code + number, 1 + number, number only. The various dialing options are:



```
595-9511
1-595-9511
800-595-9511
1-800-595-9511
```

## note

- Press and hold OFF/CLEAR to exit the menu if you do not want to delete all the entries or press **OFF/CLEAR** to return to the previous screen.

## Advanced operation

### Delete from the call log

- Press **CID/▼** to enter the call log.  
-OR-
- Press **MENU/SELECT**. Press **▼** or **▲** to select **CALL LOG**, then press **MENU/SELECT**.

#### To delete one entry

- Press **▼** or **▲** to scroll to the desired entry and then press **MUTE/REMOVE**.
- The screen displays **DELETED** and you'll hear a confirmation beep.

#### To delete all entries

- Press and hold MUTE/REMOVE when in the **CALL LOG**.
- The screen displays **DELETE ALL?** Press **MENU/SELECT**.
- The screen displays **DELETED** and you'll hear a confirmation beep.

DELETED

DELETE ALL?

# Advanced operation

## Redial

The redial list can store up to 10 of the most recently dialed numbers.

- When there are already 10 entries in the redial list, the oldest entry will be deleted to make room for the new one.
- The screen displays **EMPTY** if there is no record on the list.

## Review redial

- Press **REDIAL/PAUSE** to enter the redial list.
- Press ▼ or ▲ to browse through the entries.

## Store a redial number to the directory

- Press **REDIAL/PAUSE** to enter the redial list.
- Press ▼ or ▲ to scroll to the desired entry. Press **MENU/SELECT**.
- The screen displays **ENTER NAME**.
- Use the keypad to enter the name and then press **MENU/SELECT**.
- The screen displays **STORED** and you'll hear a confirmation beep.

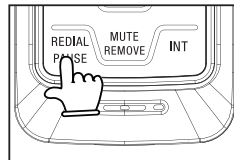

## note

- Press and hold OFF/CLEAR to exit the menu if you do not want to delete all the entries. Press **OFF/CLEAR** to return to the previous screen.

## Advanced operation

### Dial from redial

- Press **REDIAL/PAUSE** to enter the redial list.
- Press ▼ or ▲ to scroll to the desired entry.
- Press **TALK/FLASH** or **FLASH** to dial.

### Delete from redial

- Press **REDIAL/PAUSE** to enter the redial list.

#### To delete one entry

- Press ▼ or ▲ to scroll to the desired entry and then press **MUTE/REMOVE**.
- The screen displays **DELETED** and you'll hear a confirmation beep.

#### To delete all entries

- Press and hold MUTE/REMOVE.
- The screen displays **DELETE ALL?** Press **MENU/SELECT**.
- The screen displays **DELETED** and you'll hear a confirmation beep.



DELETED



DELETE ALL?

# Handset and telephone base indicators



## Handset light

	<ul style="list-style-type: none"><li>• On when the handset speakerphone is in use.</li></ul>
----------------------------------------------------------------------------------	-----------------------------------------------------------------------------------------------

## Telephone base lights

<b>IN USE</b>	<ul style="list-style-type: none"><li>• Flashes when there is an incoming call.</li><li>• On when the handset is in use.</li></ul>
<b>VOICEMAIL</b>	<ul style="list-style-type: none"><li>• Flashes when there is a new network message (a subscription service from your local telephone company is required).</li></ul>
<b>CHARGE</b>	<ul style="list-style-type: none"><li>• On when the handset is in the telephone base.</li></ul>

## Handset icons

	<ul style="list-style-type: none"><li>• Ringer off.</li></ul>
 (Battery indicator)	<ul style="list-style-type: none"><li>• Cycles (low, medium, and full) when handset battery is charging.</li><li>• Flashes when the battery power is low.</li></ul>
<b>MUTE</b>	<ul style="list-style-type: none"><li>• The microphone is muted temporarily during a conversation.</li></ul>

## Handset display screen messages

Display:	When:
CALL	There is an incoming call.
CALLING HANDSET X	Calling another handset.
CALLING FROM: HANDSET X	Other handset is calling.
CHARGING	A handset with low battery has been placed on the telephone base to recharge.
CONNECTING...	The cordless handset is searching for the telephone base.
EMPTY	There are no entries in the call log, directory, or redial list.
ENDED	You have just ended a call.
FULL	The directory is full.
INTERCOM	The handset is on an intercom call.
LINE IN USE	Another handset connected to the same line is in use.
LOW BATTERY	The battery needs to be recharged.
RINGER MUTE	The ringer is muted temporarily when there is an incoming call.
NEW	There are un-reviewed calls in the call log.
NEW VOICEMAIL	There is new voicemail message.
NOT AVAILABLE	There is no line or the handset is out of range from the telephone base. <b>-OR-</b> If one handset is already viewing the call log and another handset attempts to review it.
NO LINE	There is no telephone line connected.

## Handset display screen messages

Display:	When:
PAGING	The handset locator has been activated or the handset is being paged.
PHONE	The handset is in use.
PLACE IN CHARGER	The battery is very low. The handset should be placed on the telephone base to recharge.
WARNING CHECK BATTERY!	The battery is not installed or not installed properly in the handset. -OR - The battery needs to be replaced. -OR - An incorrect battery has been installed by mistake. Use only the supplied VTech battery.

## Call log display screen messages

Display:	When:
PRIVATE NAME	The caller is blocking name information.
PRIVATE NUMBER	The caller is blocking telephone number information.
PRIVATE CALLER	The caller is blocking name and number information.
UNKNOWN NAME	This caller's name is unavailable.
UNKNOWN NUMBER	This caller's number is unavailable.
UNKNOWN CALLER	No call information is available about this caller.
LONG DISTANCE or L (before caller's number)	This is a long distance call.



# Battery

After the battery is fully charged for 16 hours, you can expect the following performance:

Operation	Operating time
While in use (talking)	10 hours
While not in use (standby*)	100 hours

\*Handset is off the telephone base but not in use.

The battery needs charging when:

- A new battery is installed in the handset.
- Battery indicator on screen is flashing.

## CAUTION:

1. Use only the supplied battery (part number 89-1326-00-00) or equivalent. To order a replacement, visit our website at [www.vtechphones.com](http://www.vtechphones.com) or call 1 (800) 595-9511. In Canada go to [www.vtechcanada.com](http://www.vtechcanada.com) or dial 1 (800) 267-7377.
2. Do not dispose of the battery in a fire. Check with local waste management codes for special disposal instructions.
3. Do not open or mutilate the battery(ies). Released electrolyte is corrosive and may cause burns or injury to the eyes or skin. The electrolyte may be toxic if swallowed.
4. Exercise care in handling batteries in order not to create a short circuit by letting them come into contact with conductive materials such as rings, bracelets, and keys. The battery and/or conductor may overheat and cause burns.
5. Charge the battery(ies) provided with or identified for use with this product only in accordance with the instructions and limitations specified in this manual.

## WARNING:

TO PREVENT FIRE OR SHOCK HAZARD, DO NOT EXPOSE THIS PRODUCT TO WATER OR ANY TYPE OF MOISTURE.

# Important safety instructions

When using your telephone equipment, basic safety precautions should always be followed:

1. Read and understand all instructions.
2. Follow all warnings and instructions marked on the product.
3. Unplug this product from the wall outlet before cleaning. Do not use liquid or aerosol cleaners. Use a damp cloth for cleaning.
4. Do not use this product near water (for example, near a bathtub, kitchen sink, or swimming pool).
5. Do not place this product on an unstable surface such as a table, shelf or stand. This product may fall, causing serious damage.
6. Slots and openings in the back or bottom of the telephone base and handset are provided for ventilation. To protect them from overheating, these openings must not be blocked by placing the product on a soft surface such as a bed, sofa or rug. This product should never be placed near or over a radiator or heat register. This product should not be placed in an area where proper ventilation is not provided.
7. This product should be operated only from the type of power source indicated on the marking label. If you are not sure of the type of power supply in your home, consult your dealer or local power company.
8. Do not allow anything to rest on the power cord. Do not install this product where the cord may be walked on.
9. Never push objects of any kind into this product through slots in the telephone base or handset as they may touch dangerous voltage points or create a short circuit that could result in a risk of fire or electric shock. Never spill liquid of any kind on the product.
10. To reduce the risk of electric shock, do not disassemble this product, but take it to an authorized service facility. Opening or removing parts of the telephone base or handset other than specified access doors may expose you to dangerous voltages or other risks. Incorrect reassembling can cause electric shock when the product is subsequently used.
11. Do not overload wall outlets and extension cords as this can result in the risk of fire or electric shock.
12. Unplug this product from the wall outlet and refer servicing to an authorized service facility under the following conditions:
  - A. When the power supply cord or plug is damaged or frayed.
  - B. If liquid has been spilled onto the product.
  - C. If the product has been exposed to rain or water.
  - D. If the product does not operate normally by following the operating instructions. Adjust only those controls that are covered by the operation instructions, as improper adjustment of other controls may result in damage and often requires extensive work by an authorized technician to restore the product to normal operation.
  - E. If the product has been dropped and the telephone base and/or handset has been damaged.
  - F. If the product exhibits a distinct change in performance.
13. The power unit is intended to be correctly oriented in a vertical or floor mount position. The prongs are not designed to hold the plug in place if it is plugged into a ceiling, under-the-table or cabinet outlet.
14. Avoid using a telephone (other than cordless) during an electrical storm. There is a remote risk of electric shock from lightning.
15. Do not use the telephone to report a gas leak in the vicinity of the leak.
16. Only put the handset of your telephone next to your ear when it is in normal talk mode.

CAUTION: Use only the power adapter provided with this product. To purchase, visit our website at [www.vtechphones.com](http://www.vtechphones.com) or call 1 (800) 595-9511. In Canada go to [www.vtechcanada.com](http://www.vtechcanada.com) or dial 1 (800) 267-7377.

## SAVE THESE INSTRUCTIONS

[www.vtechphones.com](http://www.vtechphones.com)

Download from [Www.Somanuals.com](http://Www.Somanuals.com). All Manuals Search And Download.

## Troubleshooting

If you have difficulty with your telephone, please try the suggestions below. For Customer Service, visit our website at [www.vtechphones.com](http://www.vtechphones.com), or call 1 (800) 595-9511; in Canada go to [www.vtechcanada.com](http://www.vtechcanada.com) or dial 1 (800) 267-7377.

Problem	Suggestion
My telephone does not work at all.	<ul style="list-style-type: none"><li>• Make sure the battery is installed and charged correctly (page 2). For optimum daily performance, return the cordless handset to the telephone base or charger after use.</li><li>• Make sure the power adapter is securely plugged into an outlet not controlled by a wall switch.</li><li>• Make sure the telephone line cord is plugged firmly into the telephone base and the wall jack.</li><li>• Unplug the unit's electrical power. Wait for approximately 15 seconds, then plug it back in. Allow up to one minute for the cordless handset and telephone base to synchronize.</li><li>• Charge the battery in the cordless handset for at least 16 hours.</li><li>• Remove and re-insert the battery. If that still does not work, it may be necessary to purchase a new battery.</li><li>• Disconnect the telephone base from the jack and plug in a working telephone. If this telephone does not work, the problem is probably in the wiring or the local service. Call the local telephone company.</li></ul>
<b>LOW BATTERY</b> is displayed on screen.	<ul style="list-style-type: none"><li>• Place the handset in the telephone base or charger for recharging.</li><li>• Remove and re-install the battery and use it normally until fully discharged, then recharge the handset on the telephone base or charger for 16 hours.</li><li>• If the above measures do not correct the problem, the battery may need to be replaced.</li></ul>

# Troubleshooting

Problem	Suggestion
<p>The battery does not charge in the handset or the handset battery does not accept charge.</p>	<ul style="list-style-type: none"> <li>• Make sure the handset is placed in the telephone base or charger correctly. The <b>CHARGE</b> light on the telephone base or charger should be on.</li> <li>• Remove the battery from the handset and then re-install it in the handset. Put the handset back to the telephone base or charger and charge for 16 hours.</li> <li>• If the cordless handset is in the charger or in the telephone base but the <b>CHARGE</b> light is not on, see <b>The CHARGE light is off</b> in this section.</li> <li>• It may be necessary to purchase a new battery. Please see the <b>Battery</b> section of this user's manual (page 30).</li> <li>• The telephone might be malfunctioning. Please see the <b>Warranty</b> section of this user's manual (page 42) for further instruction.</li> </ul>
<p>The <b>CHARGE</b> light is off.</p>	<ul style="list-style-type: none"> <li>• Clean the charging contacts on the cordless handset(s) and telephone base each month using a pencil eraser or a dry non-abrasive fabric.</li> <li>• Make sure the power adapter and telephone line cords are plugged in correctly and securely.</li> <li>• Unplug the power adapter. Wait for 15 seconds before plugging it back in. Allow up to one minute for the cordless handset and telephone base to reset.</li> <li>• The telephone might be malfunctioning. Please see the <b>Warranty</b> section of this user's manual (page 42) for further instruction.</li> </ul>

## Troubleshooting

Problem	Suggestion
There is no dial tone.	<ul style="list-style-type: none"><li>• First, try all the above suggestions.</li><li>• Move the cordless handset closer to the telephone base. It might be out of range.</li><li>• The telephone line cord might be malfunctioning. Try installing a new telephone line cord.</li><li>• Disconnect the telephone base from the telephone jack and connect a different telephone. If there is no dial tone on the other telephone either, the problem is in your wiring or local service. Contact your local telephone company.</li></ul>
My handset displays <b>CONNECTING...</b>	<ul style="list-style-type: none"><li>• Move the handset closer to the telephone base. You might have moved out of range.</li></ul>
My handset displays <b>NOT AVAILABLE.</b>	<ul style="list-style-type: none"><li>• Move the handset closer to the telephone base. You might have moved out of range.</li><li>• Make sure no other handset is reviewing the call log when an attempt is denied.</li></ul>

# Troubleshooting

Problem	Suggestion
<p>The telephone does not ring when there is an incoming call.</p>	<ul style="list-style-type: none"><li>• Make sure the ringer is on (see page 9).</li><li>• Make sure the telephone line cord and power adapter are plugged in properly (page 3).</li><li>• The cordless handset may be too far from the telephone base. Move it closer to the telephone base.</li><li>• There may be too many extension telephones on the telephone line to allow all of them to ring simultaneously. Try unplugging some of them.</li><li>• If the other telephones in your home are having the same problem, the problem is in the wiring or local service. Contact the local telephone company (charges may apply).</li><li>• Other electronic products can cause interference to your cordless telephone. Try installing your telephone as far away as possible from the following electronic devices: wireless routers, radios, radio towers, pager towers, cellular telephones, digital telephones, intercoms, room monitors, televisions, VCRs, personal computers, kitchen appliances, and other cordless telephones.</li><li>• Test a working telephone at the telephone jack. If another telephone has the same problem, the problem is in the telephone jack. Contact your local telephone company (charges may apply).</li><li>• The telephone line cord might be malfunctioning. Try installing a new telephone line cord.</li><li>• Remove and re-insert the battery and place the cordless handset in the telephone base.</li><li>• Wait for the cordless handset to synchronize with the telephone base. Allow up to one minute for this to take place.</li></ul>

# Troubleshooting

Problem	Suggestion
I cannot dial out.	<ul style="list-style-type: none"><li>• First, try all the above suggestions.</li><li>• Make sure there is a dial tone before dialing. It is normal if the cordless handset takes a second or two to synchronize with the telephone base before producing a dial tone. Wait an extra second before dialing.</li><li>• Make sure the telephone is set to the correct dial type (pulse dial or tone dial) for the service in your area. See the <b>Dial type</b> section on page 12 to set the dial type.</li><li>• If the other telephones in your home are having the same problem, the problem is in the wiring or local service. Contact your local telephone company (charges may apply).</li><li>• Eliminate any background noise. Noise from a television, radio, or other appliances may cause the telephone not to dial out properly. If you cannot eliminate the background noise, first try muting the cordless handset before dialing, or dialing from another room in your home with less background noise.</li></ul>

# Troubleshooting

Problem	Suggestion
<p data-bbox="97 215 294 323">There is noise or interference during a telephone conversation.</p> <p data-bbox="97 366 329 445">My calls cut in and out when I am using the cordless handset.</p>	<ul data-bbox="349 215 1320 814" style="list-style-type: none"><li data-bbox="349 215 1105 239">• The handset may be out of range. Move it closer to the telephone base.</li><li data-bbox="349 246 1320 298">• Appliances or other cordless telephones plugged into the same circuit as the telephone base can cause interference. Try moving the appliance or telephone base to another outlet.</li><li data-bbox="349 305 1320 445">• Other electronic products can cause interference to your cordless telephone. Try installing your telephone as far away as possible from the following electronic devices: wireless routers, radios, radio towers, pager towers, cellular telephones, digital telephones, intercoms, room monitors, televisions, VCRs, personal computers, kitchen appliances, wireless routers, and other cordless telephones.</li><li data-bbox="349 452 1320 531">• If your telephone is plugged in with a modem or a surge protector, plug the telephone (or modem/surge protector) into a different location. If this solves the problem, re-locate your telephone or modem farther apart from each other, or use a different surge protector.</li><li data-bbox="349 538 1320 590">• The layout of your home or office might be limiting the operating range. Try moving the telephone base to another location, preferably a higher location for better reception.</li><li data-bbox="349 597 1320 689">• Disconnect the telephone base from the modular jack and plug in a corded telephone. If calls are still not clear, the problem is probably in the wiring or local service. Contact the local telephone company (charges may apply).</li><li data-bbox="349 697 1320 749">• If the other telephones in your home are having the same problem, the problem is in the wiring or local service. Contact the local telephone company (charges may apply).</li><li data-bbox="349 756 1320 808">• Do you have DSL service? If yes, you need to have a DSL filter installed at every telephone jack that has a telephone connected to it. Contact your DSL service provider for filter information.</li></ul>



# Troubleshooting

Problem	Suggestion
I hear other calls when using the telephone.	<ul style="list-style-type: none"><li>• Disconnect the telephone base from the telephone jack. Plug in a different telephone. If there are still other calls, the problem is probably in the wiring or local service. Call your local telephone company.</li></ul>
I hear noise in the cordless handset, and none of the keys or buttons work.	<ul style="list-style-type: none"><li>• Make sure the telephone line cord is plugged in securely.</li><li>• Remove and re-insert the battery.</li></ul>
My caller ID features are not working properly	<ul style="list-style-type: none"><li>• Caller ID is a subscription service. You must subscribe to this service from your local telephone company for this feature to work on your telephone.</li><li>• The caller may not be calling from an area which supports caller ID.</li><li>• Both you and the caller's telephone companies must use equipment which are compatible with caller ID service.</li><li>• If you subscribe to DSL service, install a DSL filter to the telephone line between the telephone base and the telephone line jack. Contact your DSL service provider for filter information.</li></ul>

## Troubleshooting

Problem	Suggestion
The system does not receive caller ID or the system does not display caller ID during call waiting.	<ul style="list-style-type: none"><li>• Make sure you subscribe to caller ID with call waiting features provided by the local telephone company.</li><li>• The caller may not be calling from an area which supports caller ID.</li><li>• Both you and the caller's telephone companies must use equipment which are compatible with caller ID service.</li><li>• If you subscribe to DSL service, install a DSL filter to the telephone line between the telephone base and the telephone line jack. Contact your DSL service provider for filter information.</li></ul>

## Troubleshooting

Problem	Suggestion
My cordless handset beeps and is not performing normally.	<ul style="list-style-type: none"><li>• Make sure the power cord is securely plugged into the telephone base. Plug the unit into a different working electrical outlet not controlled by a wall switch.</li><li>• Move the cordless handset closer to the telephone base. It may be out of range.</li><li>• Reset the telephone base by unplugging the unit's electrical power. Wait for 15 seconds and plug it back in again. Allow up to one minute for the cordless handset and the telephone base to synchronize.</li><li>• Other electronic products can cause interference to your cordless telephone. Try installing your telephone as far away from these electronic devices as possible: wireless routers, radios, radio towers, pager towers, cellular telephones, intercoms, room monitors, televisions, personal computers, kitchen appliances and other cordless telephones.</li></ul>
Common cure for electronic equipment	<ul style="list-style-type: none"><li>• If the unit is not responding normally, try putting the cordless handset in the telephone base or the charger. If it does not seem to respond, try the following (in the order listed):</li><li>• Disconnect the power to the telephone base.</li><li>• Disconnect the battery on the cordless handset.</li><li>• Wait a few minutes before connecting power to the telephone base.</li><li>• Re-install the battery and place the cordless handset into the telephone base or charger.</li><li>• Wait for the cordless handset to synchronize its connection with the telephone base. Allow up to one minute for this to take place.</li></ul>

# Operating range

This cordless telephone operates with the maximum power allowed by the Federal Communications Commission (FCC). Even so, this handset and telephone base can communicate over only a certain distance --- which can vary with the locations of the telephone base and handset, the weather, and the layout of your home or office. When the handset is out of range, the handset will display **CONNECTING**. The user can access the handset directory, and certain parts of the menu system, i.e. handset setting, but not the time setting and telephone base setting. **NOT AVAILABLE** will be displayed if access is denied.

If there is a call while the handset is out of range, it might not ring, or if it does ring, the call might not connect well when you press **TALK/FLASH**. Move closer to the telephone base, then press **TALK/FLASH** to answer the call. If the handset moves out of range during a telephone conversation, there might be interference. To improve reception, move closer to the telephone base.

# Maintenance

## Taking care of your telephone

Your cordless telephone contains sophisticated electronic parts, so it must be treated with care.

## Avoid rough treatment

Place the handset down gently. Save the original packing materials to protect your telephone if you ever need to ship it.

## Avoid water

Your telephone can be damaged if it gets wet. Do not use the handset outdoors in the rain, or handle it with wet hands. Do not install the telephone base near a sink, bathtub or shower.

## Electrical storms

Electrical storms can sometimes cause power surges harmful to electronic equipment. For your own safety, take caution when using electric appliances during storms.

## Cleaning your telephone

Your telephone has a durable plastic casing that should retain its luster for many years. Clean it only with a soft cloth slightly dampened with water or a mild soap. Do not use excess water or cleaning solvents of any kind.

Remember that electrical appliances can cause serious injury if used when you are wet or standing in water. If the telephone base should fall into water, **DO NOT RETRIEVE IT UNTIL YOU UNPLUG THE POWER CORD AND TELEPHONE LINE CORDS FROM THE WALL**. Then pull the unit out by the unplugged cords.

# About cordless telephones

- **Privacy:** The same features that make a cordless telephone convenient create some limitations. Telephone calls are transmitted between the telephone base and the cordless handset by radio waves, so there is a possibility that the cordless telephone conversations could be intercepted by radio receiving equipment within range of the cordless handset. For this reason, you should not think of cordless telephone conversations as being as private as those on corded telephones.
- **Electrical Power:** The telephone base of this cordless telephone must be connected to a working electrical outlet. The electrical outlet should not be controlled by a wall switch. Calls cannot be made from the cordless handset if the telephone base is unplugged or switched off, or if the electrical power is interrupted.
- **Potential TV Interference:** Some cordless telephones operate at frequencies that may cause interference to televisions and VCRs. To minimize or prevent such interference, do not place the telephone base of the cordless telephone near or on top of a TV or VCR. If interference is experienced, moving the cordless telephone farther away from the TV or VCR will often reduce or eliminate the interference.
- **Rechargeable Batteries:** This product contains either Nickel-Cadmium or Nickel-Metal Hydride rechargeable batteries. Exercise care in handling batteries in order not to create a short circuit with conducting material such as rings, bracelets, and keys. The battery or conductor may overheat and cause harm. Observe proper polarity between the battery and the battery charger.
- **Nickel-Metal Hydride Rechargeable Batteries:** Dispose of these batteries in a safe manner. Do not burn or puncture. Like other batteries of this type, if burned or punctured, they could release caustic material which could cause injury.

## Warranty

### What does this limited warranty cover?

The manufacturer of this VTech Product warrants to the holder of a valid proof of purchase ("Consumer" or "you") that the Product and all accessories provided in the sales package ("Product") are free from defects in material and workmanship, pursuant to the following terms and conditions, when installed and used normally and in accordance with the Product operating instructions. This limited warranty extends only to the Consumer for Products purchased and used in the United States of America and Canada.

### What will VTech do if the Product is not free from defects in materials and workmanship during the limited warranty period ("Materially Defective Product")?

During the limited warranty period, VTech's authorized service representative will repair or replace at VTech's option, without charge, a Materially Defective Product. If we repair the Product, we may use new or refurbished replacement parts. If we choose to replace the Product, we may replace it with a new or refurbished Product of the same or similar design. We will retain defective parts, modules, or equipment. Repair or replacement of the Product, at VTech's option, is your exclusive remedy. VTech will return repaired or replacement Products to you in working condition. You should expect the repair or replacement to take approximately 30 days.

### How long is the limited warranty period?

The limited warranty period for the Product extends for ONE (1) YEAR from the date of purchase. If VTech repairs or replaces a Materially Defective Product under the terms of this limited warranty, this limited warranty also applies to repaired or replacement Product for a period of either (a) 90 days from the date the repaired or replacement Product is shipped to you or (b) the time remaining on the original one-year warranty; whichever is longer.

### What is not covered by this limited warranty?

This limited warranty does not cover:

1. Product that has been subjected to misuse, accident, shipping or other physical damage, improper installation, abnormal operation or handling, neglect, inundation, fire, water or other liquid intrusion; or
2. Product that has been damaged due to repair, alteration or modification by anyone other than an authorized service representative of VTech; or
3. Product to the extent that the problem experienced is caused by signal conditions, network reliability, or cable or antenna systems; or

# Warranty

4. Product to the extent that the problem is caused by use with non-VTech accessories; or
5. Product whose warranty/quality stickers, product serial number plates or electronic serial numbers have been removed, altered or rendered illegible; or
6. Product purchased, used, serviced, or shipped for repair from outside the United States of America or Canada, or used for commercial or institutional purposes (including but not limited to Products used for rental purposes); or
7. Product returned without valid proof of purchase (see item 2 below); or
8. Charges for installation or set up, adjustment of customer controls, and installation or repair of systems outside the unit.

## How do you get warranty service?

To obtain warranty service in the United States of America, please call 1 (800) 595-9511; In Canada, please call 1 (800) 267-7377. NOTE: Before calling for service, please review the user's manual - a check of the Product controls and features may save you a service call.

Except as provided by applicable law, you assume the risk of loss or damage during transit and transportation and are responsible for delivery or handling charges incurred in the transport of the Product(s) to the service location. VTech will return repaired or replaced Product under this limited warranty to you, transportation, delivery or handling charges prepaid. VTech assumes no risk for damage or loss of the Product in transit. If the Product failure is not covered by this limited warranty, or proof of purchase does not meet the terms of this limited warranty, VTech will notify you and will request that you authorize the cost of repair prior to any further repair activity. You must pay for the cost of repair and return shipping costs for the repair of Products that are not covered by this limited warranty.

## What must you return with the Product to get warranty service?

1. Return the entire original package and contents including the Product to the VTech service location along with a description of the malfunction or difficulty; and
2. Include "valid proof of purchase" (sales receipt) identifying the Product purchased (Product model) and the date of purchase or receipt; and
3. Provide your name, complete and correct mailing address, and telephone number.

## Other Limitations

This warranty is the complete and exclusive agreement between you and VTech. It supersedes all other written or oral communications related to this Product. VTech provides no other warranties for this Product. The warranty exclusively describes all of VTech's responsibilities regarding the Product. There are no other express warranties. No one is authorized to make modifications to this limited warranty and you should not rely on any such modification.

**State/Provincial Law Rights:** This warranty gives you specific legal rights, and you may also have other rights, which vary from state to state or province to province. Limitations: Implied warranties, including those of fitness for a particular purpose and merchantability (an unwritten warranty that the Product is fit for ordinary use) are limited to one year from date of purchase. Some states/provinces do not allow limitations on how long an implied warranty lasts, so the above limitation may not apply to you. In no event shall VTech be liable for any indirect, special, incidental, consequential, or similar damages (including, but not limited to lost profits or revenue, inability to use the Product or other associated equipment, the cost of substitute equipment, and claims by third parties) resulting from the use of this Product. Some states/provinces do not allow the exclusion or limitation of incidental or consequential damages, so the above limitation or exclusion may not apply to you.

**Please retain your original sales receipt as proof of purchase.**

# FCC, ACTA and IC regulations

## FCC Part 15

This equipment has been tested and found to comply with the requirements for a Class B digital device under Part 15 of the Federal Communications Commission (FCC) rules. These requirements are intended to provide reasonable protection against harmful interference in a residential installation. This equipment generates, uses and can radiate radio frequency energy and, if not installed and used in accordance with the instructions, may cause harmful interference to radio communications. However, there is no guarantee that interference will not occur in a particular installation. If this equipment does cause harmful interference to radio or television reception, which can be determined by turning the equipment off and on, the user is encouraged to try to correct the interference by one or more of the following measures:

- Reorient or relocate the receiving antenna.
- Increase the separation between the equipment and receiver.
- Connect the equipment into an outlet on a circuit different from that to which the receiver is connected.
- Consult the dealer or an experienced radio/TV technician for help.

Changes or modifications to this equipment not expressly approved by the party responsible for compliance could void the user's authority to operate the equipment.

To ensure safety of users, the FCC has established criteria for the amount of radio frequency energy that can be safely absorbed by a user or bystander according to the intended usage of the product. This product has been tested and found to comply with the FCC criteria. The handset may be safely held against the ear of the user. The telephone base shall be installed and used such that parts of the user's body other than the hands are maintained at a distance of approximately 20 cm (8 inches) or more. If you choose to use a clipping device, please make sure to only use the supplied VTech belt clip.

This device complies with part 15 of the FCC Rules. Operation is subject to the following two conditions: (1) This device may not cause harmful interference; and (2) This device must accept any interference received, including interference that may cause undesired operation.

Privacy of communications may not be ensured when using this telephone.

## FCC Part 68 and ACTA

This equipment complies with Part 68 of the FCC rules and with technical requirements adopted by the Administrative Council for Terminal Attachments (ACTA). The label on the back or bottom of this equipment contains, among other things, a product identifier in the format US:AAAEQ##TXXXX. This identifier must be provided to your local telephone company upon request.

The plug and jack used to connect this equipment to premises wiring and the telephone network must comply with applicable Part 68 rules and technical requirements adopted by ACTA. A compliant telephone cord and modular plug is provided with this product. It is designed to be connected to a compatible modular jack that is also compliant. An RJ11 jack should normally be used for connecting to a single line and an RJ14 jack for two lines. See Installation Instructions in the user's manual.

The Ringer Equivalence Number (REN) is used to determine how many devices you may connect to your telephone line and still have them ring when you are called. The REN for this product is encoded as the 6th and 7th characters following the US: in the product identifier (e.g., if ## is 03, the REN is 0.3). In most, but not all areas, the sum of all RENs should be five (5.0) or less. For more information, please contact your local telephone company.

This equipment may not be used with Party Lines. If you have specially wired alarm dialing equipment connected to your telephone line, ensure the connection of this equipment does not disable your alarm equipment. If you have questions about what will disable alarm equipment, consult your telephone company or a qualified installer.

If this equipment is malfunctioning, it must be unplugged from the modular jack until the problem has been corrected. Repairs to this telephone equipment can only be made by the manufacturer or its authorized agents. For repair procedures, follow the instructions outlined under the Limited Warranty.

# FCC, ACTA and IC regulations

If this equipment is causing harm to the telephone network, the telephone company may temporarily discontinue your telephone service. The telephone company is required to notify you before interrupting service. If advance notice is not practical, you will be notified as soon as possible. You will be given the opportunity to correct the problem and the telephone company is required to inform you of your right to file a complaint with the FCC. Your telephone company may make changes in its facilities, equipment, operation, or procedures that could affect the proper functioning of this product. The telephone company is required to notify you if such changes are planned.

If this product is equipped with a corded or cordless handset, it is hearing aid compatible.

If this product has memory dialing locations, you may choose to store emergency telephone numbers (e.g., police, fire, medical) in these locations. If you do store or test emergency numbers, please:

- Remain on the line and briefly explain the reason for the call before hanging up.
- Perform such activities in off-peak hours, such as early morning or late evening.

## Industry Canada

This equipment complies with regulations RSS-213 and CS-03 of Industry Canada. Operation is subject to the following two conditions: (1) this device may not cause interference, and (2) this device must accept any interference, including interference that may cause undesired operation of the device.

The term "IC: " before the certification/registration number only signifies that the Industry Canada technical specifications were met.

The Ringer Equivalence Number (REN) for this terminal equipment is 0.1. The REN is an indication of the maximum number of devices allowed to be connected to a telephone interface. The termination on an interface may consist of any combination of devices subject only to the requirement that the sum of the RENs of all the devices does not exceed five.

This Class B digital apparatus complies with Canadian ICES-003.

## The RBRC® seal



The RBRC® Seal on the nickel-metal-hydride battery indicates that VTech Communications, Inc. is voluntarily participating in an industry program to collect and recycle these batteries at the end of their useful lives, when taken out of service within the United States and Canada.

The RBRC® program provides a convenient alternative to placing used nickel-metal-hydride batteries into the trash or municipal waste, which may be illegal in your area.

VTech's participation in RBRC® makes it easy for you to drop off the spent battery at local retailers participating in the RBRC® program or at authorized VTech product service centers. Please call **1-800-8-BATTERY™** for information on Ni-MH battery recycling and disposal bans/restrictions in your area. VTech's involvement in this program is part of its commitment to protecting our environment and conserving natural resources.

**RBRC® is a registered trademark of Rechargeable Battery Recycling Corporation.**

[www.vtechphones.com](http://www.vtechphones.com)

Download from [Www.Somanuals.com](http://Www.Somanuals.com). All Manuals Search And Download.



## Technical specifications

Frequency control	Crystal controlled PLL synthesizer
Frequency	Handset: 1921.536 - 1928.448 MHz Telephone base: 1921.536 - 1928.448 MHz
Channels	5
Nominal effective range	Maximum power allowed by FCC and IC. Actual operating range may vary according to environmental conditions at the time of use.
Size	Handset: 170.9mm X 48.1mm X 25.8mm Telephone base: 129.5mm X 123.8mm X 95.0mm Charger: 84.0mm X 99.0mm X 102.0mm
Weight	Handset: 131.0 grams (including battery) Telephone base: 181.6 grams Charger: 101.4 grams
Power requirements	Handset: DC 2.4V 600mAh NiMH battery Telephone base: DC 6V @ 300mA Charger: AC 6V @ 300mA
Memory	Directory: 50 memory locations; up to 24 digits and 15 characters Call log: 50 memory locations; up to 20 digits and 15 characters

# Index

## A

- About caller ID 21
- About cordless telephones 42
- Advanced operation 17
- Answer an external call during an intercom call 15

## B

- Basic operation 14
- Battery 9, 30

## C

- Caller ID 21
- Call log 22, 29
- Call waiting 14
- Character chart 18
- Clear voicemail 12

## D

- Date and time 8
- Delete from redial 26
- Delete from the call log 24
- Delete from the directory 20
- Desk/table bracket installation 4
- Dial a call log number 23
- Dial a directory entry 19
- Dial a redial number 26

- Dial type 4, 12
- Directory 17
- DSL filter 5

## E

- Edit a directory entry 20
- Edit handset name 11

## F

- FCC, ACTA and IC regulations 44
- Find handset 16

## H

- Handset and telephone base indicators 27
- Handset display screen messages 28
- Handset icons 27
- Handset layout 6
- Handset light 27

## I

- Important safety instructions 31
- Index 47
- Installation 1
- Install handset battery 2
- Internet 4
- Intercom call 15

# Index

- K**  
Key tone 10  
Language 11
- M**  
Maintenance 41  
Make, answer and end calls 14  
Multiple handset use 15  
Mute 14
- O**  
Operating range 41  
Options while on calls 14  
Out of range tone 10
- P**  
Parts checklist 1
- R**  
Redial 25  
Reset to default settings 13  
Review redial 25  
Review the call log 22  
Review the directory 17  
Ring melody 8  
Ring volume 9
- S**  
Search the directory 17  
Speakerphone 14  
Store a directory entry 19  
Store a redial number to the directory 25  
Store a call log number 23
- T**  
Technical specifications 46  
Telephone base 3, 7  
Telephone base lights 27  
Telephone settings 6  
Temporary tone dialing 13  
The RBRC® seal 45  
Transfer an external call 16  
Troubleshooting 32
- V**  
Volume 9
- W**  
Warranty 42

VTECH TELECOMMUNICATIONS LTD.

A member of THE VTECH GROUP OF COMPANIES.

Distributed in the U.S.A. by VTech Communications, Inc. Beaverton, Oregon

Distributed in Canada by VTech Telecommunications Canada, Ltd., Richmond, B.C.

Copyright ©2007 for VTECH TELECOMMUNICATIONS LTD.

Printed in China.

91-001081-090-100



# User's manual

[www.vtechphones.com](http://www.vtechphones.com)



Models:  
6041/6044/6051

Download from [Www.Somanuals.com](http://www.Somanuals.com). All Manuals Search And Download.

**DECT 6.0**

## Free Manuals Download Website

<http://myh66.com>

<http://usermanuals.us>

<http://www.somanuals.com>

<http://www.4manuals.cc>

<http://www.manual-lib.com>

<http://www.404manual.com>

<http://www.luxmanual.com>

<http://aubethermostatmanual.com>

Golf course search by state

<http://golfingnear.com>

Email search by domain

<http://emailbydomain.com>

Auto manuals search

<http://auto.somanuals.com>

TV manuals search

<http://tv.somanuals.com>