

2.4GHz CORDLESS TELEPHONE
ADVANCED DUAL - BAND TECHNOLOGY



2428

CALL WAITING ID

USER'S MANUAL



vtech

VTECH TELECOMMUNICATIONS LTD.
www.vtechphones.com

2.4
GHZ

Download from www.Somanuals.com

To help protect the environment, this product may contain recycled or reconditioned parts and materials.

CONTENTS

Important Safety Instructions	1	CALLER ID OPERATION	13
BEFORE YOU BEGIN	2	About Call History	13
About Caller Identification	2	Review Call History	13
Parts Check List	2	Delete Records from Call History	13
INSTALLATION	3	Dial a Displayed Number.....	14
Before You Install	3	Store a Call History Record in the Directory.....	14
Table/Desk Installation	4	Display Screen Messages.....	14
Wall Installation	4	BATTERIES	15
TELEPHONE OPERATION	5	Charge the Handset Battery Pack	15
Make a Call.....	5	Replacing the Handset Battery Pack	15
Answer a Call	5	IN CASE OF DIFFICULTY	16
End a Call	5	MAINTENANCE	18
Change Channel.....	5	WARRANTY STATEMENT	19
Redial	5	FCC AND IC REGULATIONS	20
Handset Volume	5	The RBRC™ Seal	22
Flash/Call Waiting.....	5	TECHNICAL SPECIFICATIONS	23
Hold	5		
Page/Handset Locator	6		
Message Waiting Indicator	6		
In Use/Charging Indicator	6		
Handset Ringer Style/ Battery Save.....	7		
Temporary Tone Dialing.....	7		
Headset Jack.....	7		
Operating Range	8		
Display Screen Messages.....	8		
TELEPHONE MEMORY	9		
Store a Number or Name in Memory	9		
Edit a Number/Name Stored in Memory	10		
Delete a Number/Name Stored in Memory	10		
Dial a Memory Number	10		
TELEPHONE DIRECTORY	11		
Store a Number/Name in the Directory	11		
Edit a Number/Name Stored the Directory	12		
Delete a Number/Name Stored the Directory	12		
Dial a Number from the Directory	12		

Important Safety Instructions

When using your telephone equipment, basic safety precautions should always be followed to reduce the risk of fire, electric shock and injury to persons, including the following:

1. Read and understand all instructions.
2. Follow all warnings and instructions marked on the product.
3. Unplug this product from the wall outlet before cleaning. Do not use liquid cleaners or aerosol cleaners. Use a damp cloth for cleaning.
4. Do not use this product near water (for example, near a bath tub, kitchen sink, or swimming pool).
5. Do not place this product on an unstable cart, stand, or table. The product may fall, causing serious damage to the product.
6. Slots and openings in the cabinet and the back or bottom are provided for ventilation. To protect it from overheating, these openings must not be blocked by placing the product on the bed, sofa, rug, or other similar surface. This product should never be placed near or over a radiator or heat register. This product should not be placed in a built-in installation where proper ventilation is not provided.
7. This product should be operated only from the type of power source indicated on the marking label. If you are not sure of the type of power supply to your home, consult your dealer or local power company.
8. Do not allow anything to rest on the power cord. Do not locate this product where the cord will be abused by persons walking on it.
9. Never push objects of any kind into this product through cabinet slots as they may touch dangerous voltage points or short out parts that could result in a risk of fire or electric shock. Never spill liquid of any kind on the product.
10. To reduce the risk of electric shock, do not disassemble this product, but take it to a VTech authorized service facility. Opening or removing cabinet parts other than specified access doors may expose you to dangerous voltages or other risks. Incorrect reassembly can cause electric shock when the appliance is subsequently used.
11. Do not overload wall outlets and extension cords as this can result in the risk of fire or electric shock.
12. Unplug this product from the wall outlet and refer servicing to a VTECH authorized service facility under the following conditions:
 - A. When the power supply cord or plug is damaged or frayed.
 - B. If liquid has been spilled into the product.
 - C. If the product has been exposed to rain or water.
 - D. If the product does not operate normally by following the operating instructions. Adjust only those controls that are covered by the operating instructions, because improper adjustment of other controls may result in damage and will often require extensive work by a VTech authorized technician to restore the product to normal operation.
 - E. If the product has been dropped and the cabinet has been damaged.
 - F. If the product exhibits a distinct change in performance.
13. Avoid using a telephone (other than a cordless type) during an electrical storm. There may be a remote risk of electric shock from lightning.
14. Do not use the telephone to report a gas leak in the vicinity of the leak.

VTECH COMMUNICATIONS INC

SERVICE DEPT. at 1-800-595-9511. In Canada, call VTech Electronics Ltd at 1-800-267-7377.

SAVE THESE INSTRUCTIONS

BEFORE YOU BEGIN

About Caller Identification (Caller ID)

This product has a Caller ID with Call Waiting feature that works with service from your local phone service provider.

Caller ID with Call Waiting lets you see who's calling before you answer the phone, even when you're on another call.

You may need to change your phone service to use this feature. Contact your phone service provider if:

- You have both Caller ID and Call Waiting, but as separate services (you may need combined service)
- You have only Caller ID service, or only Call Waiting service
- You don't subscribe to any Caller ID or Call Waiting services.

You can use this product with regular Caller ID service, and you can use this product's other features without subscribing to either Caller ID or combined Caller ID with Call Waiting service.

There are fees for Caller ID services, and they may not be available in all areas.

This product can provide information only if both you and the caller are in areas offering Caller ID service, and if both telephone companies use compatible equipment.

Parts Check List:

1. Base Unit
2. Handset
3. AC Power Adapter
4. Telephone Line Cord
5. Battery Pack
6. Wall Mount
7. Belt clip
8. Owner's Manual

To purchase replacement battery packs, call VTech Communications Inc at 1-800-595-9511. In Canada, call VTech Electronics Ltd at 1-800-267-7377.



INSTALLATION

Before You Install

1. Choose a location for the base near an electrical outlet and a telephone jack.
This phone requires a modular telephone jack and a standard electrical outlet (110V AC) not controlled by a wall switch.
2. Install the handset battery pack. Use only battery pack provided or recommended by VTECH.

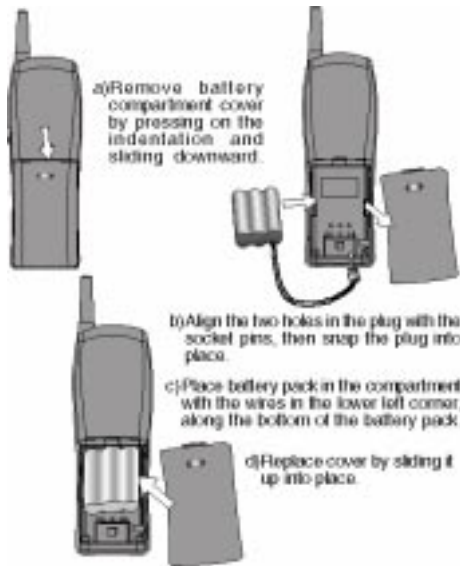

- 3 Attach the belt clip to the cordless handset (optional).

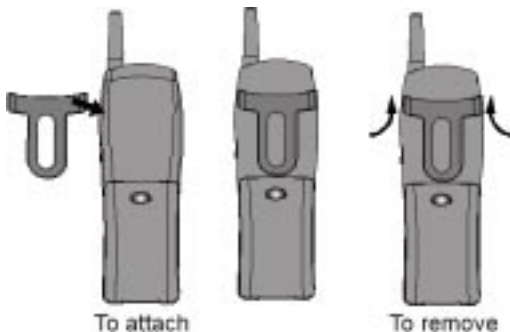

NOTE: Install the Base Unit away from electronic equipment, such as personal computers, television sets or microwave ovens. Avoid excessive heat, cold, dust or moisture.

INSTALLATION

Table/Desk Installation

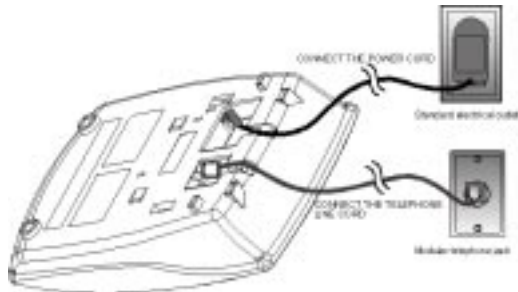

4. Charge the handset battery.

Place the handset in the base. Charge the battery for at least 12 hours the first time.

5. Check for dial tone.

After the batteries are charged, pick up the handset and press **PHONE**; you should hear a dial tone.

6. Set the dial mode.

If you have touch tone service, the phone is ready to use as soon as the batteries are charged.

If you have dial pulse (rotary) service, you'll need to change the dial mode.

- Press **PROG/CHAN** on the handset to enter programming mode.
- Press **◀** or **▶** until the screen displays **DIAL MODE**: and the currently selected mode.
- Press **SELECT**. The current setting blinks.
- Press **▶** to select **TONE** or **PULSE**.
- Press **SELECT**, to save the displayed mode.

Wall Installation Using a standard modular Wall Plate

- 1 Connect the T-shaped wall mount bracket to the slots on the underside of the Base Unit. as shown in the illustration.
- 2 Connect the power cord to the Base Unit.
- 3 Connect the telephone line cord to the Base Unit.

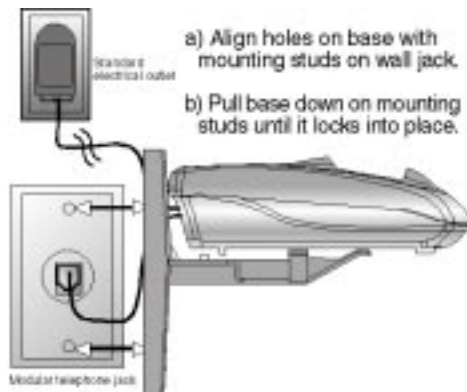

- 4 Mount the Base Unit onto the wall plate.
- 5 Follow the steps in Table/Desk installation.

TELEPHONE OPERATION

Answer a Call

Press any key except **OFF**

Hold

Press to put a call on hold, press again to release hold OR Lift the handset of an extension

Make a Call

Press **PHONE** then dial the number OR Dial the number (use to backspace and correct digits), then press **PHONE** to call

Flash/Call Waiting

Access special telephone company subscriber services

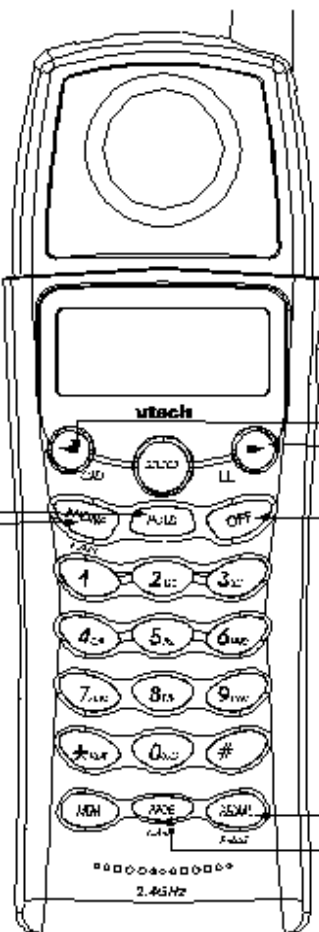

Handset Volume

While on a call, adjust the volume of what you hear

End a Call

Press **OFF** or Place handset in base

Exit programin

Cancel a page

Redial

Press **PHONE**, then press **REDIAL / PAUSE** to call last number dialed (up to 32 digits)

Program /CHAN

Switch to a clearer channel while on a call. Enter programming mode with Handset idle (on hook)

TELEPHONE OPERATION

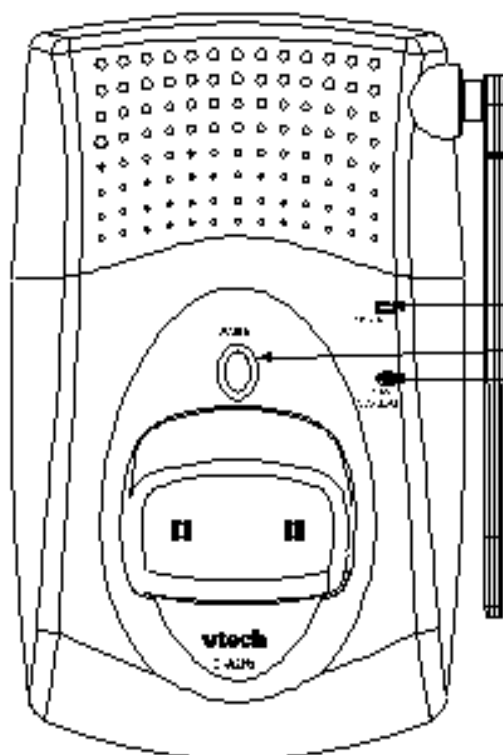

Message Waiting Indicator

If you subscribe to telephone company voice mail with a visual message waiting signal, this light flashes when you have voice mail waiting.

PAGE/Handset Locator

Press to page the handset for up to 60 seconds. Press again to cancel, or press OFF on handset.

IN USE/CHARGING Indicator

Flashes when the Handset is in use, or on steady when the Handset is charging in the Base.

TELEPHONE OPERATION

Handset Ringer Style/Battery Save

You can select from four different handset ringer styles, or turn the ringer off and extend the battery life.

- 1 Make sure the handset is off.
- 2 Press **PROG/CHAN** to enter programming mode.
- 3 Press **▶** until the screen displays **RINGER:**.
- 4 Press **SELECT** The screen displays the current setting.
- 5 Press **◀** or **▶** to select 1, 2, 3, 4, or **OFF**. You will hear a sample of each ring.
- 6 Press **SELECT** to choose the displayed ringer setting.

Temporary Tone Dialing

If you have dial pulse (rotary) service, you can change from dial pulse to touch tone dialing during a call by pressing *****. This is useful if you need to send touch tone signals for access to telephone banking or long-distance services.

- 1 Dial the number.
- 2 Press *****. Buttons pressed after this send touch tone signals.
- 3 After you hang up, the phone automatically returns to dial pulse (rotary) service.

Headset Jack

You can use this telephone hands-free when you install any VTECH 2.5mm headset, purchased separately.

Plug the headset into the jack located on the right side of the handset (under the small rubber flap). Do not force the connection, but make sure the plug fits securely.



TELEPHONE OPERATION

Operating Range

This cordless telephone operates within the maximum power allowed by the Federal Communications Commission (FCC). Even so, this handset and base can communicate over only a certain distance — which can vary with the locations of the base and handset, the weather, and the construction of your home or office. For best performance, keep the base antenna fully upright.

If you receive a call while you are out of range, the handset might not ring — or if it does ring, the call might not connect when you press **PHONE** . Move closer to the base, then press **PHONE** to answer the call.

If you move out of range during a phone conversation, you might hear noise or interference. To improve reception, move closer to the base.

If you move out of range without pressing OFF, your phone will be left “off the hook.” To hang up properly, walk back into range, periodically pressing **OFF** .

Display Screen Messages

Screen Displays:	When:
NO LINE	The base is not connected to the telephone line, or the line is not working.
RINGING	There is a call coming in.
CONNECTING	The handset is waiting for dial tone.
PHONE ON	The handset is in use.
MESSAGES WAITING	You have received telephone company voice mail.
PAGING	The base is paging the handset.
HOLD	There is a call on hold.
EXTENSION IN USE	Another extension on this line is off hook.
BATTERY LOW	The battery needs to be recharged.

TELEPHONE MEMORY

This cordless phone can store 10 telephone numbers with names, each up to 16 digits long in memory locations you assign (0-9).

Note: Press **OFF** at any time to exit memory dial mode.

Store a Number or Name in Memory

- 1 Press **PROG/CHAN**, then press **▶** until the screen displays **MEM DIAL**.
- 2 Press **MEM**. The screen displays **ENTER 0-9**.
- 3 Press the key (0-9) for the memory location where you're storing this entry. If the selected location is empty, the screen displays **ENTER NAME**.

Note: If the location is not empty, the current entry is displayed. Press **OFF** to exit memory dial mode and start again, or follow the instructions to dial, edit or erase the current entry.

- 4 Using the chart below, enter up to 15 characters for the name you're storing with the number. Use **◀** to backspace and make corrections; use **▶** to advance and add a space.

Dial Key:	Presses					
	1	2	3	4	5	6
1	1					
2	A	B	C	2		
3	D	E	F	3		
4	G	H	I	4		
5	J	K	L	5		
6	M	N	O	6		
7	P	Q	R	S	7	
8	T	U	V	8		
9	W	X	Y	Z	9	
0	0					
*	*					
#	&	'	,	-	.	#

- 5 When you finish entering the name, press **SELECT** or **PROG/CHAN**. The screen displays **ENTER NUMBER**.
- 6 Enter the telephone number. Use **◀** to backspace and make a correction. Press **REDIAL/PAUSE** to store a pause in the dialing sequence.
- 7 Press **SELECT** or **PROG/CHAN** to store your entry. The screen displays **DISTINCT RING?** and the current setting.

TELEPHONE MEMORY

- 8 Press ◀ or ▶ to change the setting. Choose Y (for Yes) if you wish the phone to alert you to calls from this number by changing to a distinctive ringing pattern after the first ring. Choose N (for NO) for a normal ringing pattern.
- 9 Press **SELECT** or **PROGRAM** to confirm your selection. If you choose Y, a D will be displayed with the directory entry.

Note: When memory is full the screen displays MEMORY FULL, an error tone sounds, and you will not be able to store a new number until you delete a stored number.

Edit a Number/Name Stored in Memory

- 1 Press **MEM**. The screen displays ENTER 0-9.
- 2 Press the memory location key of the entry you wish to edit.
- 3 When the screen displays the number you want to edit, press **SELECT**. Then press ◀ or ▶ until EDIT flashes.



- 4 Press **SELECT**. The screen displays the name and number. The flashing cursor appears at the end of the name. Use ◀, ▶ and the dial pad keys to edit the name. Press **SELECT** to move on to edit the number. Press **SELECT** to move on to edit the Distinctive Ring setting.
- 5 Press **SELECT** to save the edited information.

Delete a Number/Name Stored in Memory

- 1 Press **MEM**. The screen displays ENTER 0-9.
- 2 Press the memory location key of the entry you wish to edit.
- 3 When the screen displays the number you want to delete, press **SELECT**. Then press ◀ or ▶ until ERASE flashes.

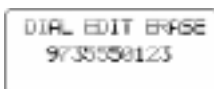

- 4 Press **SELECT**. The screen displays ERASE NO YES and the number.
- 5 Press ◀ or ▶ until YES flashes.
- 6 Press **SELECT**.

Dial a Memory Number

- 1 Press **MEM**. The screen displays ENTER 0-9.
- 2 Press the memory location key of the entry you wish to edit.
- 3 When the screen displays the number you want to dial, press **SELECT**. Then press ◀ or ▶ until DIAL flashes.

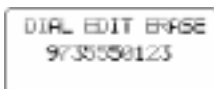

- 4 Press **SELECT**. The phone automatically dials the number.

TELEPHONE DIRECTORY

This cordless phone can store 40 telephone numbers with names, each up to 16 digits long. Entries are stored alphabetically. For consistency with Caller ID entries, you may wish to enter last names first.

Note: Press **OFF** at any time to exit directory.

Store a Number/Name in the Directory

- 1 Press **PROG/CHAN** . The screen displays **DIRECTORY** .
- 2 Press **SELECT** . The screen displays **ENTER NAME** .
- 3 Using the chart below, enter up to 15 characters for the name you're storing with the number. Use **◀** to backspace and make corrections; use **▶** to advance and add a space.

Dial Key:	Presses					
	1	2	3	4	5	6
1	1					
2	A	B	C	2		
3	D	E	F	3		
4	G	H	I	4		
5	J	K	L	5		
6	M	N	O	6		
7	P	Q	R	S	7	
8	T	U	V	8		
9	W	X	Y	Z	9	
0	0					
*	*					
#	&	'	,	-	.	#

- 4 When you finish entering the name, press **SELECT** or **PROG/CHAN**. The screen displays **ENTER NUMBER** .
- 5 Enter the telephone number. Use **◀** to backspace and make a correction. Press **REDIAL/PAUSE** to store a pause in the dialing sequence.
-OR-
Press **REDIAL/PAUSE** to display the last number dialed from this phone.
- 6 Press **SELECT** or **PROG/CHAN**. The screen displays **DISTINCT RING?** and the current setting.
- 7 Press **◀** or **▶** to change the setting. Choose **Y** (for Yes) if you wish the phone to alert you to calls from this number by changing to a distinctive ringing pattern after the first ring. Choose **N** (for NO) for a normal ringing pattern.

TELEPHONE DIRECTORY

- 8 Press **SELECT** or **PROG/CHAN** to confirm your selection. If you chose $\sqrt{\square}$, a \square will be displayed with the directory entry.

Note: When memory is full the screen displays MEMORY FULL, an error tone sounds, and you will not be able to store a new number until you delete a stored number.

Edit a Number/Name Stored in the Directory

- 1 Press \blacktriangleright ($\square\square$). The screen displays DIRECTORY.
- 2 Press \blacktriangleleft or \blacktriangleright to scroll alphabetically through entries stored in memory
-OR-
Press the dial pad key for the first letter of the entry you want to edit.
- 3 When the screen displays the number you want to edit, press **SELECT**. Then press \blacktriangleleft or \blacktriangleright until EDIT flashes.



- 4 Press **SELECT**. The screen displays the name and number. The flashing cursor appears at the end of the name. Use \blacktriangleleft , \blacktriangleright and the dial pad keys to edit the name. Press **SELECT** to move on to edit the number. Press **SELECT** to move to edit the Distinctive Ring setting.
- 5 Press **SELECT** to save the edited information.

Delete a Number/Name Stored in the Directory

- 1 Press \blacktriangleright ($\square\square$). The screen displays DIRECTORY.
- 2 Press \blacktriangleleft or \blacktriangleright to scroll alphabetically through entries stored in memory
-OR-
Press the dial pad key for the first letter of the entry you want to delete.
- 3 When the screen displays the number you want to delete, press **SELECT**. Then press \blacktriangleleft or \blacktriangleright until ERASE flashes.



- 4 Press **SELECT**. The screen displays ERASE NO YES and the number. The current choice flashes.
- 5 Press \blacktriangleleft or \blacktriangleright until YES flashes.
- 6 Press **SELECT**. You'll hear a series of beeps confirming the deletion.

Dial a Number from the Directory

- 1 Press \blacktriangleright ($\square\square$). The screen displays DIRECTORY.
- 2 Press \blacktriangleleft or \blacktriangleright to scroll alphabetically through entries stored in memory
-OR-
Press the dial pad key for the first letter of the entry you want to dial.
- 3 When the screen displays the number you want to dial, press **SELECT**. Then press \blacktriangleleft or \blacktriangleright until DIAL flashes.

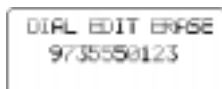

- 4 Press **SELECT**. The phone automatically dials the number.

CALLER ID OPERATION

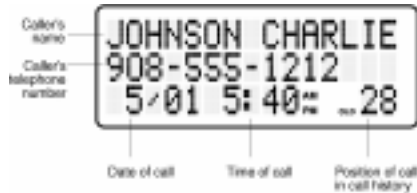

About Call History

This phone assigns each incoming call a number from 1 to 99. The most recent call will have the highest number. When the memory is full, the oldest call information is deleted to make room for new incoming call information.

For each call that comes in, the screen displays the following information between the first and second rings:

- Your caller's name (15 letters are sent by your telephone company)
- The caller's area code and telephone number
- The time and date of the call
- The position of the call in call history.

If you answer a call before the information appears on the screen, it will not be in the call history.

*Note: Press **OFF** at any time to exit call history.*

Review Call History

The screen displays call information for about 15 seconds after it has been received.

- 1 Press **◀** (CID) to view call history.
- 2 Use **◀** or **▶** to scroll through records in call history.

Delete Records from Call History

Delete a Specific Call

- 1 Locate the record you want to delete from call history.
- 2 Press **SELECT**, then press **◀** or **▶** until **ERASE** flashes.

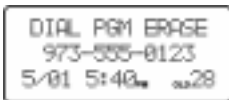

- 3 Press **SELECT**. The screen displays **ERASE NO YES ALL** and the phone number. The current choice flashes.
- 4 Press **◀** or **▶** until **YES** flashes.
- 5 Press **SELECT**. You'll hear a series of beeps confirming the deletion.

Delete All Calls

- 1 While viewing call history, press **SELECT**, then press **◀** or **▶** until **ERASE** flashes.

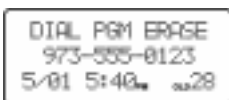

- 2 Press **SELECT**. The screen displays **ERASE NO YES ALL** and the phone number. The current choice flashes.
- 3 Press **◀** or **▶** until **ALL** flashes, then press **SELECT**. The screen displays **ERASE ALL NO YES**. The current choice flashes.

CALLER ID OPERATION

- 4 Press ◀ or ▶ until YES flashes.
- 5 Press **SELECT**. You will hear a series of beeps confirming the deletion.

NOTE: If there are new CID records not yet reviewed, the "ALL" option will not be displayed as a selection.

Dial a Displayed Number

- 1 Locate the record in call history that you want to dial.
- 2 If you wish to change how the number is dialed, press # .
The screen displays any alternate dialing sequences available for this call (area code + number; 1 + area code + number; 1+ number; number only).
- 3 Press **SELECT**, then press ◀ or ▶ until DIAL flashes.

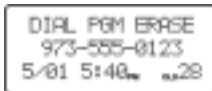

The phone number will be displayed in the format it was received.

- 4 Press **SELECT** when the number is correctly displayed for dialing.

Store a Call History Record in the Directory

- 1 Locate the record in call history you want to store in memory.
- 2 If you wish to change how the number is stored, press # . The screen displays any alternate dialing sequences available for this call (area code + number; 1 + area code + number; 1+ number; number only).
- 3 Press **SELECT**, then press ◀ or ▶ until PGM flashes.

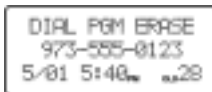

The phone number will be displayed in the format it was received.

- 4 Press **SELECT** four times to store the call record in memory. You'll hear a beep confirming that the name number were stored.

Display Screen Messages

Screen Displays:	When:
PRIVATE	The other party is blocking name information.
	The other party is blocking name and number information.
OUT OF AREA	Your phone company is unable to receive information about this caller's name.
	Your phone company is unable to receive information about this caller's name and number.

BATTERIES

Charge the Handset Battery Pack

- This battery should remain charged up to six days with the ringer turned on and up to 12 days with the ringer off. A fully charged battery provides an average talk time of about six hours.
- The battery pack needs charging when:
 - A new battery is installed in the handset.
 - The phone beeps twice every 5 seconds.
 - The screen displays **BATTERY LOW** and the low battery icon.
- Place the handset in the base so the **CHARGING** light turns on. The battery pack is typically fully charged in eight hours.
- You can keep the battery fully charged by returning the handset to the base after each use.
- If you repeatedly get a low battery indicator, even after charging overnight, the battery should be replaced. Use VTECH Battery.



CAUTION: To reduce the risk of fire or injury to persons or damage to the telephone, read and follow these instructions carefully:

Charge the battery provided with or identified for use with this product only in accordance with the instructions and limitations specified in this User's Manual.

Replacing the Handset Battery Pack

- 1 Remove the battery compartment cover on the handset by pressing on the indentation and sliding the cover downward.
- 2 Lift out the old battery pack and disconnect.
- 3 Align the two holes in the new battery pack's plug with the socket pins, and snap the plug into place. Place the battery pack in the compartment with the wires in the lower left corner, along the bottom of the battery pack.
- 4 Replace the cover by sliding it up into place.
- 5 The new battery pack must be charged before using the phone. Place the handset in the base and allow it to charge for at least 12 hours the first charge. The telephone might operate before that, but for best performance, let the battery pack charge fully.

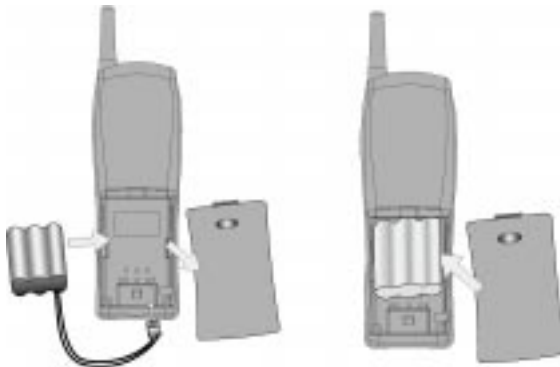

IN CASE OF DIFFICULTY

If you have difficulty operating this phone, try the suggestions below.

For Customer Service, call 1-800-595-9511. Please retain your receipt as your proof of purchase

If the phone doesn't work at all, check these items first:

- Make sure the AC adapter is plugged into an outlet not controlled by a wall switch.
- Make sure the telephone line cord is plugged firmly into the base unit and the modular jack.
- Make sure the base antenna is fully upright.
- If the handset does not beep when you press **PHONE**, the battery might need charging.
- Make sure the battery pack is installed correctly.
- If you have dial pulse (rotary) service on your phone line, make sure the dial mode is set to dial pulse (see INSTALLATION).
- Microwave appliances may cause interference with this phone. If you experience interference, move away from the microwave

If the above suggestions don't solve the problem, try re-initializing the handset and base:

- 1 Disconnect the power to the base.
- 2 Remove the handset battery pack.
- 3 Wait a few minutes.
- 4 Connect the power to the base.
- 5 Insert the handset battery pack.
- 6 Put the handset in the base to re-initialize.

If you hear a two-beep signal when you try to use the handset:

- You might be out of range. Move closer to the base and try again.
- If moving closer to the base doesn't help, try following the directions above for re-initializing the handset and base.

If the phone does not ring when you receive a call:

- Make sure the handset ringer is on.
- Make sure the telephone line cord is connected firmly to the base and the telephone jack.
- Make sure the AC adapter is plugged firmly into an outlet not controlled by a wall switch.
- You might be too far from the base; move closer.
- You might have too many extension phones on your telephone line to allow all of them to ring. Try unplugging some of them.

If you hear noise or interference when using the phone:

- Make sure the base antenna is fully upright.
- You may be out of range. Move closer to the base.
- Press and release **PROG/CHAN** to change to another of the 30 channels available. If noise is exceptionally loud, move closer to the base before changing channels.
- Household appliances plugged into the same circuit as the base can sometimes cause interference. Try moving the appliance or the base to another outlet.

IN CASE OF DIFFICULTY

- Using the handset near household appliances (microwaves, computers, television, stereos, etc.) can sometimes cause interference. Move away from appliances while using the handset.
- The layout of your home or office might be limiting the operating range. Try moving the base to another location, preferably on an upper floor.
- If the buttons don't work, try placing the handset in the base for at least 15 seconds.

If you hear other calls while using your phone:

- Press **PROG/CHAN** to change to another channel.
- Disconnect the base from the modular jack and plug in a corded telephone. If you still hear other calls, the problem is probably in your wiring or local service. Call your local telephone service company.

If you lose a call after changing channels:

You were probably almost out of range. Move closer to the base before changing channels. Before placing another call, set the handset in the base for at least 15 seconds.

If you are unable to operate special telephone services or other equipment requiring touch tone signals:

If you have dial pulse (rotary) service, follow the directions under "Temporary Tone Dialing" in the TELEPHONE OPERATION section of this manual.

If the MESSAGE light on the base does not go off even after you've listened to voice mail messages:

- 1 Press **PROG/CHAN**.
- 2 Press  until the screen displays MESSAGES WAITING .
- 3 Press **SELECT**. The screen displays LIGHTS OFF: YES .
- 4 Press **SELECT** again to turn off the MESSAGE light on base.

Maintenance

Taking Care Of Your Telephone

Your GIGAPHONE cordless telephone contains sophisticated electronic parts, so it must be treated with care.

Avoid rough treatment

Place the Handset down gently. Save the original packing materials to protect your telephone if you ever need to ship it.

Avoid water

Your telephone can be damaged if it gets wet. Do not use the Handset outdoors in the rain, or handle it with wet hands. Do not install your Base Unit near a sink, bathtub or shower.

Electrical storms

Electrical storms can sometimes cause power surges harmful to electronic equipment.

For your own safety, use caution when using electric appliances during storms.

Cleaning your telephone

Your telephone has a durable plastic casing that should retain its luster for many years. Clean it only with a soft cloth slightly dampened with water or a mild soap. Do not use excess water or cleaning solvents of any kind.

Remember that electrical appliances can cause serious injury if used when you are wet or standing in water. If your Base Unit should fall into water, **DO NOT RETRIEVE IT UNTIL YOU UNPLUG THE POWER CORD AND TELEPHONE LINE CORDS FROM THE WALL.** Then pull the unit out by the unplugged cords.

Warranty Statement

What does this limited warranty cover?

- The manufacturer of this VTECH product, **VTECH Communications**, warrants to the holder of a valid proof of purchase ("Consumer" or "you") that the product and all accessories provided by **VTECH** in the sales package ("Product") are free from material defects in material and workmanship, pursuant to the following terms and conditions, when installed and used normally and in accordance with operation instructions. This limited warranty extends only to the Consumer for Products purchased and used in the United States of America.

What will VTECH Communications do if the Product is not free from material defects in materials and workmanship during the limited warranty period ("Materially Defective Product")?

- During the limited warranty period, VTECH's authorized service representative will repair or replace at VTECH's option, without charge, a Materially Defective Product. If we repair this product, we may use new or refurbished replacement parts. If we choose to replace this product, we may replace it with a new or refurbished product of the same or similar design. VTECH will return repaired or replacement products to you in working condition. VTECH will retain defective parts, modules, or equipment. Repair or replacement of Product, at VTECH'S option, is your exclusive remedy. you should expect the repair or replacement to take approximately 30 days.

How Long is the limited warranty period ?

- The limited warranty period for the product extends for ONE(1)YEAR from the date of purchase if we repair or replace a Materially Defective Product the terms of this limited warranty. this limited warranty also applies to repaired or replacement Products for a period of either (a) 90 days from the date the repaired or replacement Product is shipped to you or (b) the time remaining on the original one-year limited warranty, whichever is longer.

What is not covered by this limited warranty ?

This limited warranty does not cover

1. Product that has been subjected to misuse, accident, shipping or other physical damage improper installation, abnormal operation or handling, neglect, inundation fire, water, or other liquid intrusion; or
2. Product that has been damaged due to repair, alteration, or modification by anyone other than an authorized service representative of VTECH; or
3. Product to the extent that the problem experienced is caused by signal conditions network reliability or cable or antenna systems; or
4. Product to the extent that the problem is caused by use with non_VTECH electrical accessories; or
5. Product whose warranty/quality stickers, Product serial numbers plates or electronic serial numbers have been removed, altered or rendered illegible; or
6. Product purchased, used, serviced, or shipped for repair from outside the United States, or used for commercial or institutional purposes (including but not limited to Products used for rental purposes) ;or
7. Product returned without valid proof of purchase (see 6 below); or
8. Charges for installation or set up , adjustment of customer controls. and installation or repair of systems outside the unit.

How do you get warranty service?

- To obtain warranty service in the United States of America. call 1 800-595-9511 for instructions regarding where to return the Product. Before calling for service, please check

Warranty Statement

the user's manual, A check of the Product controls and features may save you a service call.

- Except as provided by applicable law, you assume the risk of loss or damage during transit and transportation and are responsible for delivery or handling charges incurred in the transport of Product(s) to the service location . VTECH will return repaired or replaced product under this limited warranty to you , transportation, delivery or handling charges prepaid .VTECH assumes no risk for damage or loss of the Product in transit.
- If the Product failure is not covered by this limited warranty,or proof of purchase does not meet the terms of this limited warranty , VTECH will notify you and will request that you authorize the cost of repair prior to any further repair activity. you must pay for the cost of repair and return shipping costs for the repair of Products that are not covered by this limited warranty.

What must you return with the Product to get warranty service?

you must

1. Return the entire original package and contents including the Product to the VTECH service location along with a description of the malfunction or difficulty:
2. Include "valid proof of purchase" (sales receipt) identifying the Product purchased (Product model) and the date of purchase or receipt; and
3. Provide your name, complete and correct mailing address, and telephone number.

Other Limitations

- This warranty is the complete and exclusive agreement between you and VTECH. It supersedes all other written or oral communications related to this Product. VTECH provides no other warranties for this product. The warranty exclusivelydescribes all of VTECH's responsibilities regarding the product. There are no other express warranties. No one is authorized to make modifications to this limited warranty and you should not rely on any such modification.

State Law Rights: This warranty gives you specific legal rights, and you may also have other rights which vary from state to state.

Limitations: Implied warranties, including those of fitness for a particular purpose and merchantability (an unwritten warranty that the product is fit for ordinary use) are limited to one year from date of purchase. Some states do not allow limitations on how long an implied warranty lasts, so the above limitation may not apply to you.

- In no event shall VTECH be liable for any indirect, special, incidental, consequential, or similar damages (including, but not limited to lost profits or revenue, inability to use the product, or other associated equipment, the cost of substitute equipment, and claims by third parties) resulting from the use of this product. Some states do not allow the exclusion or limitation of incidental or consequential damages, so the above limitation or exclusion may not apply to you.

FCC and IC Regulations

This equipment complies with Parts 15 of the Federal Communications Commission (FCC) rules for the United States. It also complies with regulations RSS210 and CS-03 of Industry and Science Canada. Operation is subject to the following two conditions: (1) this device may not cause interference, and (2) this device must accept any interference, including interference that may cause undesired operation of the device.

A label is located on the underside of the Base Unit containing either the FCC registration number and Ringer Equivalence Number (REN) or the IC registration number and Load Number. You must, upon request, provide this information to your local telephone company.

This equipment is compatible with inductively coupled hearing aids.

Should you experience trouble with this telephone equipment, please contact:

VTech Communication Inc SERVICE DEPT. at 1-800-595-9511.

In Canada, call VTECH Electronics at 1-800-267-7377.

For repair/warranty information. The telephone company may ask you to disconnect this equipment from the line network until the problem has been corrected.

FCC Part 15

Warning: Changes or modifications to this unit not expressly approved by the party responsible for compliance could void the user's authority to operate the equipment.

The equipment has been tested and found to comply with part 15 of the FCC rules. These limits are designed to provide reasonable protection against harmful interference in a residential installation. This equipment generates, uses and can radiate radio frequency energy and, if not installed and used in accordance with the instructions, may cause harmful interference to radio communications. However, there is no guarantee that interference will not occur in a particular installation. If this equipment does cause harmful interference to radio or television reception, which can be determined by turning the equipment off and on, the user is encouraged to try and correct the interference by one or more of the following measures:

- Reorient or relocate the receiving antenna.
- Increase the separation between the equipment and receiver.
- Connect the equipment into an outlet or on a circuit different from that to which the receiver is connected.
- Consult the dealer or an experienced radio/TV technician for help.

FCC Part 68

The FCC requires that you connect your cordless telephone to the nationwide telephone network through a modular telephone jack (USOC RJ11C, RJ11W or RJ14).

Your telephone company may discontinue your service if your equipment causes harm to the telephone network. They will notify you in advance of disconnection, if possible. During notification, you will be informed of your right to file a complaint with the FCC.

Occasionally, your telephone company may make changes in its facilities, equipment, operation, or procedures that could affect the operation of your equipment. If so, you will be given advance notice of the change to give you an opportunity to maintain uninterrupted service.

The Base Unit contains no user serviceable parts. The Handset contains a user replaceable battery pack.

FCC and IC Regulations

If it is determined that your telephone equipment is malfunctioning, the FCC requires that it not be used and that it be unplugged from the modular jack until the problem has been corrected. Repairs to this telephone equipment can only be made by the manufacturer or its authorized agents or by others who may be authorized by the FCC. For repair procedures, follow the instructions outlined under the VTECH Limited Warranty.

This equipment may not be used on coin service provided by the phone company or Party Lines.

The REN is useful in determining the number of devices you may connect to your telephone line and still enable the devices to ring when you receive a call. The general rule is that the REN value should not exceed 5.0A total; however, contact your local telephone company for the specific number in your area.

IC (Industry Canada)

This telephone is registered for use in Canada.

Notice :

The REN assigned to this device denotes the number of devices you may connect to the telephone loop which is used by the device to prevent overloading. The termination on a loop may consist of any combination of devices subjected only to the requirement that the sum of the REN does not exceed five (5.0)

Notice :

The Industry Canada label identifies certified equipment. This certification means that the equipment meets certain telecommunications network protective, operational and safety requirements. The Department does not guarantee the equipment will operate to the user's satisfaction.

Before installing this equipment, users should ensure that it is permissible to be connected to the facilities of the local telecommunications company. The equipment must also be installed using an acceptable method of connection. The customer should be aware that compliance with the above conditions may not prevent degradation of services in some situations.

Repairs to certified equipment should be made by an authorized Canadian maintenance facility designated by the supplier. Any repairs or alterations made by the user to this equipment, or equipment malfunctions, may give the telecommunications company cause to request the user to disconnect the equipment.

Users should ensure for their own protection that the electrical ground connections of the power utility, telephone lines and internal metallic water pipe system, if present, are connected together. This precaution may be particularly important in rural areas.

Caution :

Users should not attempt to make such connections themselves, but should contact the appropriate electrical inspection authority, or electrician, as appropriate.

Your VT 2428 is designed to operate at the maximum power allowed by the FCC and IC. This means your Handset and Base Unit can communicate only over a certain distance - which will depend on the location of the Base Unit and Handset, weather, and the construction and layout of your home or office.

The RBRC™ Seal



The **RBRC®** Seal on the nickel-cadmium battery contained in our product indicates that VTech Communications, Inc. is voluntarily participating in an industry program to collect and recycle these batteries at the end of their useful lives, when taken out of service within the United States and Canada.

The **RBRC®** program provides a convenient alternative to placing used nickel-cadmium batteries into the trash or municipal waste, which may be illegal in your area.

VTech's participation in **RBRC®** makes it easy for you to drop off the spent battery at local retailers participating in the **RBRC®** program or at authorized VTech product service centers. Please call **1-800-8-BATTERY™** for information on Ni-Cd battery recycling and disposal bans/restrictions in your area. VTech's involvement in this program is part of its commitment to protecting our environment and conserving natural resources.

Remove the nickel-cadmium battery pack by pressing on the Handset battery cover and sliding downward.

RBRC® is a registered trademark of Rechargeable Battery Recycling Corporation.

FREQUENCY CONTROL

Crystal controlled PLL synthesizer

TRANSMIT FREQUENCY

Base: 2411.15 - 2418.4 MHz

Handset: 912.75 - 917.10 MHz

RECEIVE FREQUENCY

Base: 912.75 - 917.10 MHz

Handset: 2411.15 - 2418.4 MHz

CHANNELS

30 Channels

NOMINAL EFFECTIVE RANGE

Maximum power allowed by FCC and IC. Actual operating range may vary according to environmental conditions at the time of use.

SIZE

Handset : 35mm x 58mm x 165mm

Base : 166mm x 109mm x 50mm

WEIGHT

Handset : 170 grams

Base : 206 grams

POWER REQUIREMENTS

Handset : 600mAh NI-CD Battery Pack

Base : 9V DC @ 400mA

MEMORY

Speed Dial: 10 Memory locations, into 16 digits per location.

CID : Alpha Numeric Display 99

Memory locations

SPECIFICATIONS ARE TYPICAL AND MAY CHANGE WITHOUT NOTICE.

Printed in China

91-5236-10-00
ISSUE 0

Free Manuals Download Website

<http://myh66.com>

<http://usermanuals.us>

<http://www.somanuals.com>

<http://www.4manuals.cc>

<http://www.manual-lib.com>

<http://www.404manual.com>

<http://www.luxmanual.com>

<http://aubethermostatmanual.com>

Golf course search by state

<http://golfingnear.com>

Email search by domain

<http://emailbydomain.com>

Auto manuals search

<http://auto.somanuals.com>

TV manuals search

<http://tv.somanuals.com>