

Important Safety Instructions

When using your telephone equipment, basic safety precautions should always be followed to reduce the risk of fire, electric shock and injury, including the following:

1. Read and understand all instructions.
2. Follow all warnings and instructions marked on the product.
3. Unplug this product from the wall outlet before cleaning. Do not use liquid cleaners or aerosol cleaners. Use a damp cloth for cleaning.
4. Do not use this product near water (for example, near a bath tub, kitchen sink, or swimming pool).
5. Do not place this product on an unstable cart, stand, or table. The product may fall, causing serious damage to the product.
6. Slots and openings in the cabinet and the back or bottom are provided for ventilation. To protect it from overheating, these openings must not be blocked by placing the product on the bed, sofa, rug, or other similar surface. This product should never be placed near or over a radiator or heat register. This product should not be placed in a built-in installation where proper ventilation is not provided.
7. This product should be operated only from the type of power source indicated on the marking label. If you are not sure of the type of power supply to your home, consult your dealer or local power company.
8. Do not allow anything to rest on the power cord. Do not locate this product where the cord will be abused by persons walking on it.
9. Never push objects of any kind into this product through cabinet slots as they may touch dangerous voltage points or short out parts that could result in a risk of fire or electric shock. Never spill liquid of any kind on the product.
10. To reduce the risk of electric shock, do not disassemble this product, but take it to an authorized service facility. Opening or removing cabinet parts other than specified access doors may expose you to dangerous voltages or other risks. Incorrect reassembling can cause electric shock when the appliance is subsequently used.
11. Do not overload wall outlets and extension cords as this can result in the risk of fire or electric shock.

Important Safety Instructions

12. Unplug this product from the wall outlet and refer servicing to an authorized service facility under the following conditions:
 - A. When the power supply cord or plug is damaged or frayed.
 - B. If liquid has been spilled into the product.
 - C. If the product has been exposed to rain or water.
 - D. If the product does not operate normally by following the operating instructions, because improper adjustment of other controls may result in damage and will often require extensive work by an authorized technician to restore the product to normal operation.
 - E. If the product has been dropped and the cabinet has been damaged.
 - F. If the product exhibits a distinct change in performance.
13. Avoid using a telephone (other than a cordless type) during an electrical storm. There may be a remote risk of electric shock from lightning.
14. Do not use the telephone to report a gas leak in the vicinity of the leak.

VTECH COMMUNICATIONS INC.

CUSTOMER SERVICE at 1-800-595-9511. In Canada, call VTech Telecommunications, Ltd. at 1-800-267-7377.

SAVE THESE INSTRUCTIONS

Introduction

The **v 2656** is an advanced cordless telephone that operates in the 2.4GHz frequency range. Your **v 2656** is capable of supporting up to a maximum of 4 Handsets. Using additional Handsets, 2 people can be conferenced on a call, while two other extensions can be talking internally, using the Intercom feature.

This manual is designed to familiarize you with the **v 2656** cordless telephone. We strongly recommend you read the manual before using your phone.

To order additional Handsets (model v 2600), battery packs, or headsets, call VTech Communications Inc at 1-800-595-9511.

IMPORTANT

Please record the Base ID#(BS ID) printed on the underside of the **v 2656** Base in the space below. Please be certain to include all 15 digits/characters.

Base ID# _____



If you have questions about this product, or if you're having difficulty with setup or operation, do not return your phone to the store. Call our Customer Support Center at 1-800-595-9511

In Canada, call 1-800-267-7377

Parts Check List

1. Base Unit
2. Handset
3. AC Power Adapter
4. Telephone Cord
5. Battery Pack
6. Wall Mounting Bracket
7. User's Manual

To purchase replacement battery packs, call Vtech Communications, Inc. at 1-800-595-9511. In Canada, call VTech Telecommunications Canada Ltd. at 1-800-267-7377.



Handset

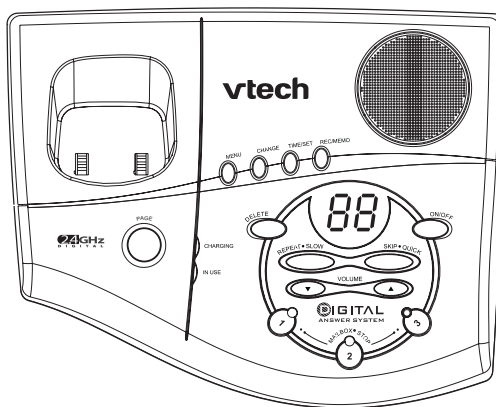

Base Unit

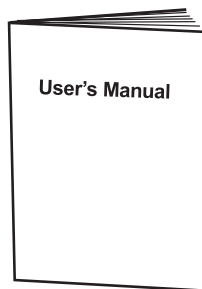

User's Manual

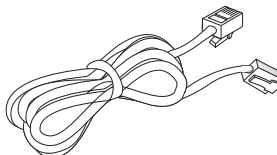

Telephone Cord

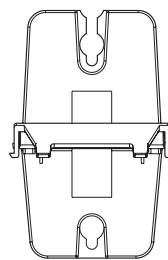

Wall Mounting Bracket

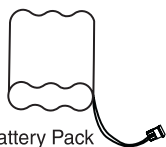

Battery Pack

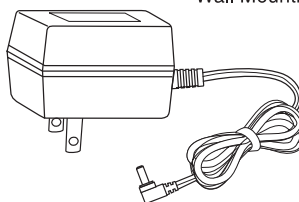

AC Power Adapter

The Handset Layout

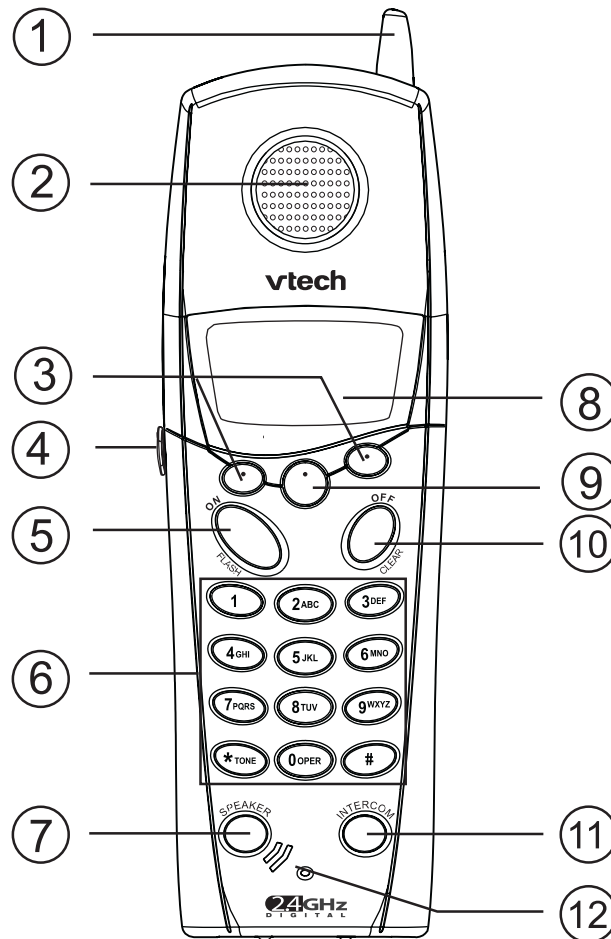

- | | |
|-----------------------------|---------------------------|
| 1. Antenna | 7. Handsfree Speakerphone |
| 2. Earpiece | 8. LCD Display |
| 3. Scroll Keys | 9. Select /Menu |
| 4. Headset Jack (2.5mm) | 10. Off (Clear) |
| 5. On (Flash) | 11. Intercom |
| 6. Dialing Keys (0-9, *, #) | 12. Microphone |

The Base Unit Layout

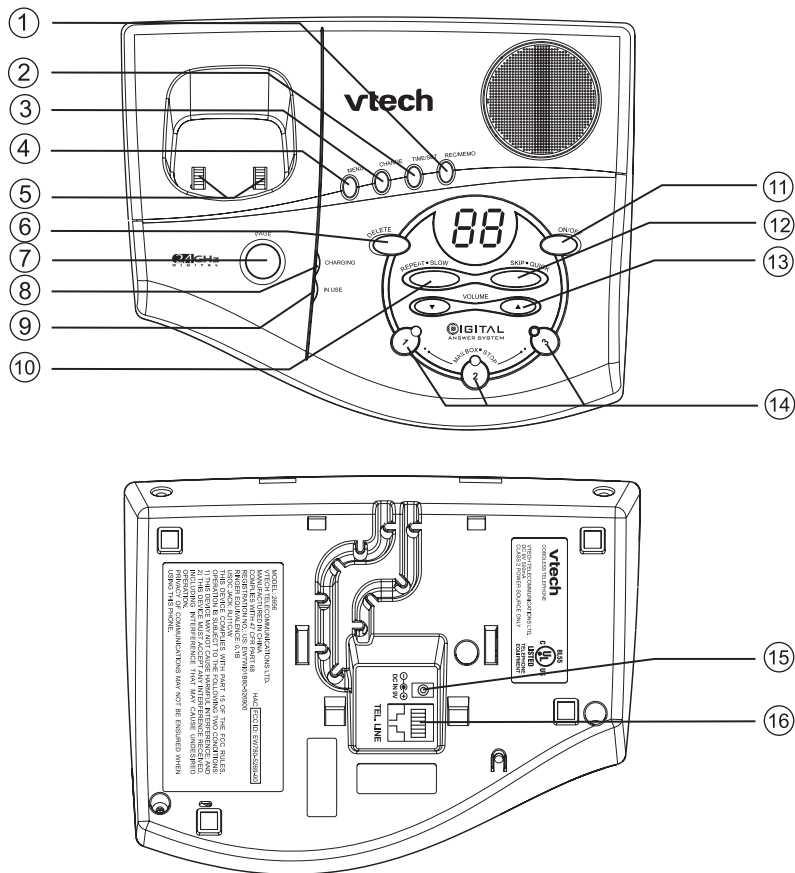

- | | |
|-----------------------|-----------------------|
| 1. Record/Memo | 9. In Use Indicator |
| 2. Time/Set | 10. Repeat/Slow key |
| 3. Change | 11. Answer ON/OFF key |
| 4. Menu | 12. Skip/Quick key |
| 5. Charge Contacts | 13. Volume Keys |
| 6. Delete | 14. Mailbox Keys |
| 7. Page | 15. DC Connector |
| 8. Charging Indicator | 16. Telephone Jack |

Connecting Power to Base Unit

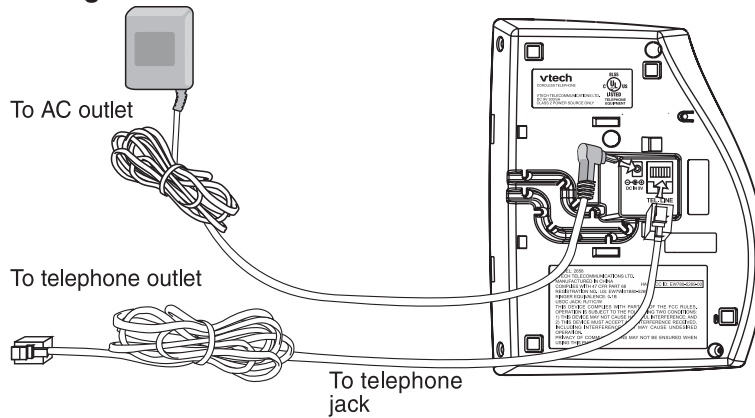

Plug the AC power adapter into an electrical outlet, and the DC connector into the jack on the bottom of the Base Unit.



CAUTION: Use only the VTech power supply provided with your VTech Unit.

IMPORTANT:

FOR MAXIMUM PERFORMANCE OF YOUR CORDLESS TELEPHONE SYSTEM:

1. Choose a central location for your Base Unit.
2. Install your Base Unit and Extension Handsets away from electronic equipment, such as personal computers, television sets and microwave ovens.
3. In locations where there are multiple cordless telephones, separate base units as much as possible.
4. Install your telephone equipment away from heat sources and sunlight.
5. Avoid excessive moisture, dust or extreme cold.

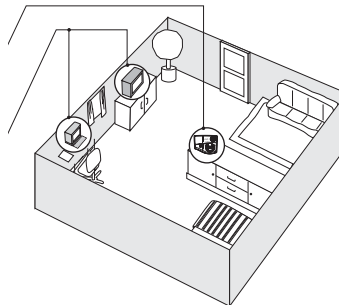

Installation of Battery Pack in Handset

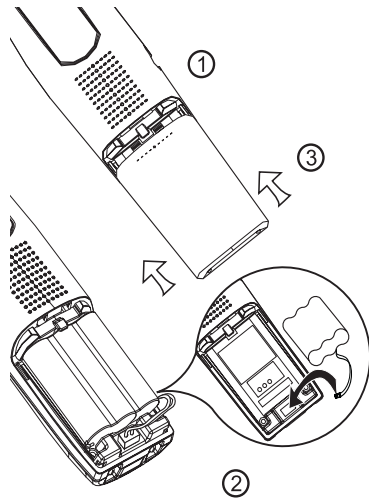

Follow the steps below:

1. Remove the battery cover by pressing on the indent and sliding downward.
2. Align the two holes in plug with the socket pins. Insert the plug into socket. Place the battery pack into the compartment with the wires in one of the bottom corners of the battery pack.
3. Replace the battery cover by sliding it upwards.
4. If the new battery pack is not already charged, place the Handset in the Base unit, or a remote charging stand, and allow it to charge for 12 hours. After initial charge, a maintenance charge of 8 hours should be sufficient.

The original Handset that is shipped with your **v 2656** system will be automatically registered to the Base. This Handset is **HANDSET 1**.

As you register additional Handsets to the system, they will be assigned extension numbers in the following order: **HANDSET 2**, **HANDSET 3**, and finally **HANDSET 4**.

After a Handset battery pack is installed, the Handset will automatically begin **SEARCHING FOR BASE** (if previously registered), or it will prompt you to **ENTER BASE ID** to register the new Handset.

Charging Of Handset Battery Pack

The Handset of your **v 2656** cordless telephone is powered by a rechargeable battery pack. It charges automatically whenever the Handset is in the Base Unit. Maximum talk time on a full charge is 7.5 hours. Maximum standby time is 5 days.

You should charge the battery pack for 12 hours when you first receive your phone. You'll know the battery pack needs charging when:

- The low battery message is displayed:
- The handset seems completely dead, the LCD is completely clear and does not activate when you press the keys.

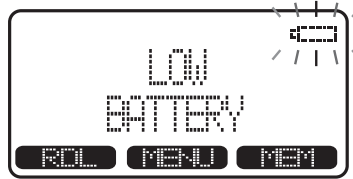

IMPORTANT:

1. Do not dispose of a battery pack in a fire, the cell may explode.
2. Do not open or mutilate the battery pack. Toxic substances may be released, causing harm to eyes or skin.
3. Exercise care in handling battery packs in order to prevent an accidental short of the charge contacts, potentially causing the battery pack to overheat.
4. Do not dispose of this battery pack into household garbage. Please refer to the following information concerning proper battery recycling.

Connecting to phone line

Plug one end of the telephone line cord into the jack on the bottom of the Base unit. Plug the other end of this cord into the wall jack.

Checking for dial tone

After the battery is charged press **ON** on the Handset. The Phone icon  will appear on the Handset display, and you will hear dial tone. If not, see **In Case of Difficulty**.

Wall Mounting

The Wall Mount bracket is designed for use on standard Wall Mount plates only.

1. Line up the tabs on the wall mount adapter with the holes on the bottom of the base unit. Snap the wall mount bracket firmly in place.
2. Plug the AC adapter into an electrical outlet, and the DC connector to the jack on the bottom of the Base Unit. If the handset battery pack has not been charged previously, place the handset in the base unit cradle, and allow it to charge for 12 hours.
3. Connect the telephone line cord to the jack on the bottom of the base unit, and the other end to the wall jack.
4. Mount the base unit on the wall. Position the base unit so the mounting studs will fit into the holes on the wall mount bracket. Slide base unit down on the mounting studs until it locks into place.

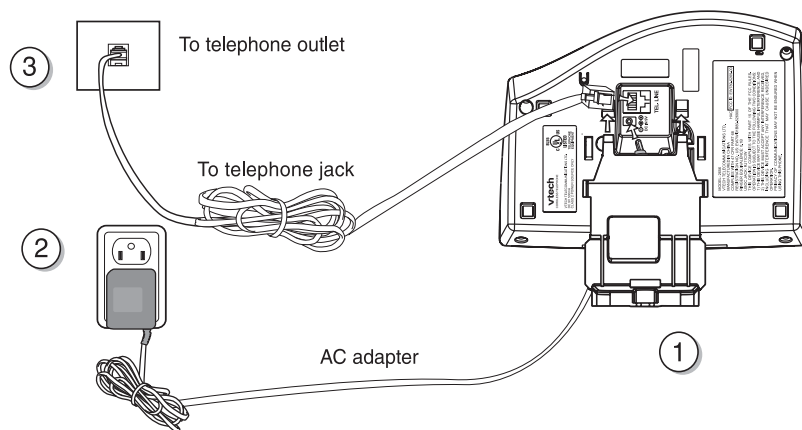

Registration of Additional Handsets

Registration and Operation of the v 2600 Accessory Handset

Your **v 2656** system can operate up to 4 Handsets.

The VTech accessory Handset consists of the following:

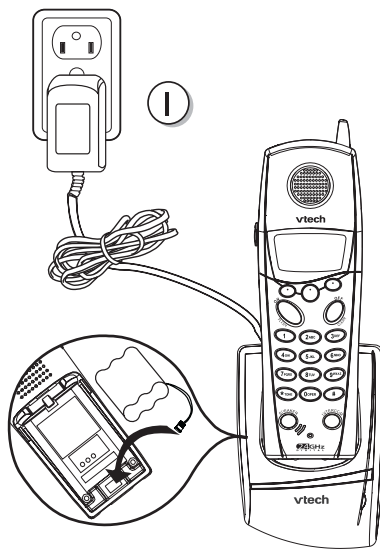
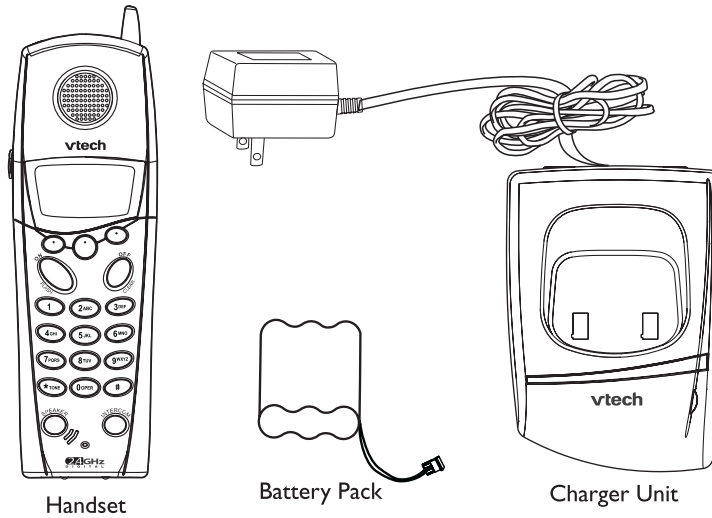

Setup of the v 2600 Accessory Handset

1. Plug the AC power adapter into an electrical outlet.
2. Install the battery, as described previously.

Registration of Additional Handsets

Enter Base ID Code

1. After charging the Handset, if the screen displays **SEARCHING FOR BASE**, press **NEW**. You will see **ENTER BASE ID**. If the screen already says **ENTER BASE ID**, go to step 2.
2. Enter the 15 digit Base Unit ID code, located on the underside of the Base Unit.
3. Press **OK**. The Handset will display: **PLEASE WAIT!!**
Then put the Handset onto the cradle.
4. Wait approximately 15 seconds. The Handset will display: **FOUND BASE**

If the Handset displays: **BASE BUSY TRY LATER**, this indicates that the system is in use. Wait until the Base Unit is in the idle (on hook) mode, and repeat steps 2 to 4.





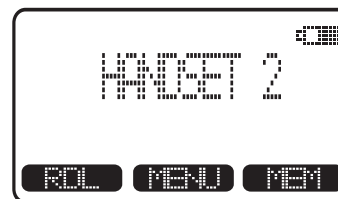
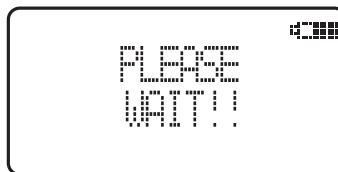
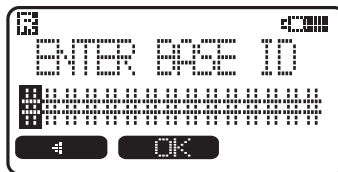
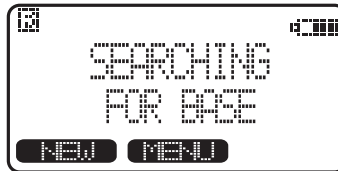

NOTE: Occasionally, it may take longer than 15 seconds for the Handset to confirm registration to the Base Unit. This is normal.

Congratulations! You can now enjoy the benefits of your multi-Handset system.



Handset and Base Indicators

Handset Icons

Icon	Description
	<u>Line In Use indicator</u> On steady with no number next to it when a parallel set is in use. On steady with one or more numbers next to it, indicating which extensions are using the line. For example,  12 indicates that Handset 1 and Handset 2 are on an outside call.
	<u>Intercom indicator</u> On steady with the extension numbers currently on an intercom call. For example,  12 indicates that the Handset 1 and Handset 2 are on an intercom call.
	<u>Battery indicator</u> Cycles (Low, Medium, and High) when Handset battery is charging. Flashes when a low battery condition is detected.
M	<u>Mute indicator</u> On steady when the Handset microphone is muted.
H	<u>Hold indicator</u> On steady when the line is on hold.
E	<u>Enhanced Mode indicator</u> On steady when active Handset and Base are in Enhanced mode.
	<u>Handset Registration indicator</u>  is displayed when a Handset is either not registered, or is searching for a Base unit.

Base LEDS

LED	Description
In Use	<ul style="list-style-type: none"> Lights when line is being used by a Handset of the v 2656 system.
Mailbox/Stop	<ul style="list-style-type: none"> Glows when there are only old messages in the mailbox. Flashes when there are new messages in the mailbox. Is not illuminated when a mailbox is empty.
Charging	<ul style="list-style-type: none"> Lights whenever the handset is placed in the base unit charging cradle.
ON/OFF	<ul style="list-style-type: none"> Lights when the answering machine is on.

Soft Menu Functions

The **v 2656** has an advanced design that uses a menu structure and soft keys to access all of the built-in features.

Example of the idle mode display:

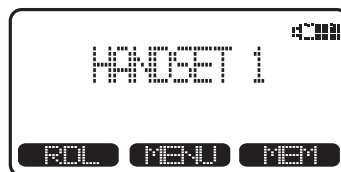

RDL (Redial)

Press **RDL** to display the last 5 telephone numbers dialed. The number on top line is the most recent number dialed.

- Use the / scroll keys to select the desired number.
- To dial the number, you can simply press the **ON** or **SPEAKER** key.
- To erase (or save) the number, select this option to delete (or save) it.

MENU

With the Handset in the idle (OFF) mode, press the **MENU** key to access the following options:

- **CALLS LOG (CALLER ID)**
- **HANDSET SETTINGS**
- **RANGE EXTENDER**
- **STONE/PULSE**
- **REGISTER**

Use the / scroll keys to select the desired option, then press **OK**.

Caller ID - Call Waiting ID



Your **v 2656** is capable of displaying the name and/or number of the party calling before you answer the phone (**Caller ID**). It is also capable of displaying Caller ID information in conjunction with a Call Waiting alert signal (**Call Waiting Caller ID**). With Call Waiting Caller ID, the Caller ID data is displayed so you can decide whether to answer the incoming call, or continue with your current conversation.

NOTES ABOUT CALLER ID & CALL WAITING CALLER ID



These are subscription services, provided by most regional telephone service providers. You must subscribe to these services to get the benefits of these features. If you do not subscribe to Caller ID services, you can still use your **v 2656** and the other features it offers.

Due to regional incompatibilities, Caller ID information may not be available for every call you receive. In addition, the calling party may intentionally block their name and phone number from being sent.

Calls Log (Caller ID)

From the idle (OFF) mode, press **MENU**, use the  /  scroll keys to select **CALLS LOG**, then press **OK**. The Caller ID information of the most recently received call will be displayed. For example:



To scroll to other records, use the  /  scroll keys.



To dial the number displayed, you can simply press the **ON** or **SPEAKER** key.

You can also press the **CID** key to access the following options (DEL, OPT#, SAVE):

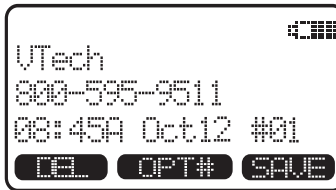
DEL : Select this option to delete **THIS** or **ALL** records in Caller ID memory.



OPT# : Select this option to display up to four possible dialing strings of the number stored in Caller ID memory. If a number is provided in the Caller ID data, the possible options to choose from will be either 7, 8, 10, or 11 digits. For example, if the original number in Caller ID memory was 808-880-8808, then the display options will be:

Use the  /  keys to make selection, and then press **DIAL**, **ON** or **SPEAKER** to dial the number.





SAVE : Select this option to save the displayed Caller ID record into Memory. Only Caller ID records with telephone numbers can be saved into Memory. If you need to modify the number after saving, see **To Edit a Number/Name**, on page 21.



Your **v 2656** stores the 50 most recent Caller ID and Call Waiting ID records in its memory. As new records are stored, the oldest records are automatically deleted to make room. Therefore, you do not have to manually delete CID records.

Handset Settings

From the Handset Settings menu you can select the following options to modify:

- **RINGER VOLUME**



Select this option to adjust the ringer volume. Use the  /  scroll keys to adjust the volume up or down. A Handset will display a graphic indicator of the selected volume setting. Press **OK** to confirm your selection and return to the Handset Settings menu.
- **RINGER MELODY**



Select this option to adjust the ringer melody or tone. Use the  /  scroll keys to select from the six available tones. Press **SAVE** to confirm your selection and return to the Handset Settings menu.
- **LOW BATT TONE (preset to ON)**

Select this option to turn the Low Battery warning tone **ON** or **OFF**. Press the **OFF** or **ON** soft keys, to make your selection. Press **OK** to confirm your selection and return to the Handset Settings menu. When set to **ON**, the Handset will emit a warning tone when a Low Battery condition is detected.
- **RANGE TONE (preset to ON)**

Select this option to turn the Out of Range warning tone **ON** or **OFF**. Press the **OFF** or **ON** soft keys, to make your selection. Press **OK** to confirm your selection and return to the Handset Settings menu. When set to **ON**, the Handset will emit a warning tone whenever the Handset is taken out of range of the Base.
- **KEYPAD TONE (preset to ON)**

Select this option to turn the Keypad tones **ON** or **OFF**. Press the **OFF** or **ON** soft keys, to make your selection. Press **OK** to confirm your selection and return to the Handset Settings menu. When set to **ON**, the Handset will emit a beep whenever a key is pressed.
- **CONTRAST**

Select this option to adjust the contrast level of the Handset display. Use the  /  scroll keys to make your selection. The handset display will automatically adjust as you make your selection. Press **OK** to confirm your selection and return to the Handset Settings menu.
- **LANGUAGE (preset to ENGLISH)**

Select this option to change the display to appear in English, Spanish or French. Use the  /  scroll keys to select language, then press **OK** to confirm your choice.

Range Extender (preset to AUTO)

Your **v 2656** has an enhanced feature that is designed to improve performance. If you are using your **v 2656** in an area with excessive interference, or you require a moderate increase in operating range, the Range Extender feature can help to improve both the sound quality and range. Actual range will depend on your environment.

To select the Range Extender setting, follow the procedure listed below:

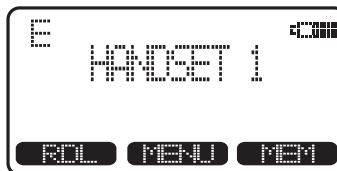
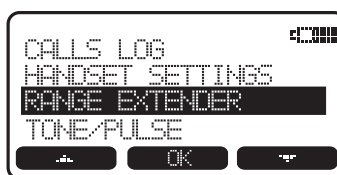

- In the idle(OFF) mode, press **MENU** and use the scroll keys to select **RANGE EXTENDER**, then press **OK**.
- There are 3 option settings in the **RANGE EXTENDER** menu:
 1. Select **OFF** to disable **RANGE EXTENDER**
 2. Select **ON** to enable **RANGE EXTENDER**. An "E" icon will appear in the upper left corner of Handset display, indicating that **RANGE EXTENDER** is **ON**.
 3. Select **AUTO** to allow your **v 2656** to automatically monitor the signal strength between the Handset and Base unit, and activate whenever necessary. When **RANGE EXTENDER** is enabled, an "E" icon will appear in the upper left corner of the Handset display.
- Use the scroll keys to select the desired setting, and then press **OK** to confirm the selection.



Note: When Range Extender mode is enabled, your **v 2656** will consume more battery power. That means the standby and talk time of your Handset will be shorter.

Tone/Pulse Selection (preset to TONE)

Use this option to select Tone dialing or Pulse dialing.

- The phone must be in the idle (OFF) mode.
- Select **TONE/PULSE** option from the **MENU**. then press **OK**.
- Use the  /  scroll keys to select the desired option, then press **OK**.

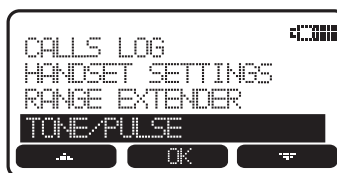

Register and Memory

Use this option to register additional Handsets to the **v 2656** Base. You can register a total of four Handsets.

You will be prompted to enter the 15-digit Base ID code printed on the underside of the base unit. After entering this code, press **OK**. The Handset will display **SEARCHING FOR BASE**, and then **FOUND BASE** when the process is complete. See **Registration of Additional Handsets**, page 11, for details.

Note : Base ID codes are 15 digits long and can include the following characters : 0, 1, 2, 3, 4, 5, 6, 7, 8, 9 or *****.

Memory

The **v 2656** can store up to 50 names/numbers in memory. Each memory location can hold up to 32 digits and up to 16 characters for the name.

When prompted to **ENTER NAME**, use the digit keys to 'spell' the name. Each press of a particular key causes characters to be displayed in the following order:

Number Key	Characters (in order)
1	& ' , . 1
2	A B C a b c 2
3	D E F d e f 3
4	G H I g h i 4
5	J K L j k l 5
6	M N O m n o 6
7	P Q R S p q r s 7
8	T U V t u v 8
9	W X Y Z w x y z 9
0	0
*	*
#	#

Memory

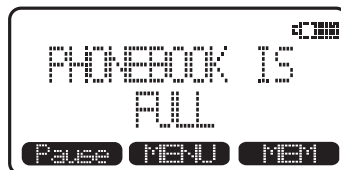
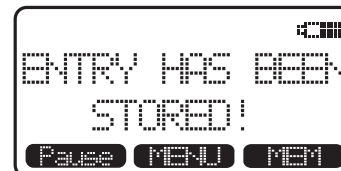
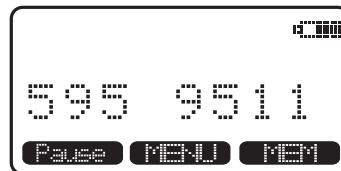
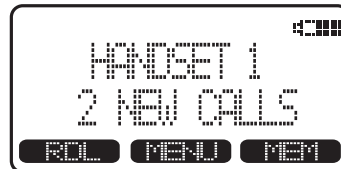

To Store a Number/Name:

- Starting from the idle screen, enter the number you want to store in memory.
- Be sure to include long distance codes and pauses (using the **PAUSE** soft key) if necessary. When finished, press the **MEM** soft key.
- You will then be prompted to **ENTER NAME**. Use the digit keys to 'spell' the name. If you make a mistake, press the **CLR** soft key. To enter a space press **SPACE**. When finished, press **SAVE**.
- If there is space available in memory, the number/name will be saved and the Handset will return to the idle mode.
- If the memory is full the Handset will display **PHONEBOOK IS FULL** and exit to the dial mode without saving the entry.



Memory

To Search For and Dial a Number/ Name:

- Starting from the idle screen, press the **MEM** soft key to review memory contents.
- Using the  /  soft keys scroll through the memory contents in alphabetical order.
- Or, you can press the **FIND** soft key, enter the first few characters of the name. If you make a mistake, press **CLR** soft key. Then press **FIND** to search. The closest match, in alphabetical order, will be displayed.
- Once you find the entry you want, simply press **ON** or **SPEAKER** to dial the number.

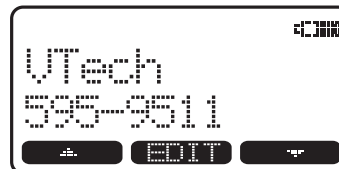
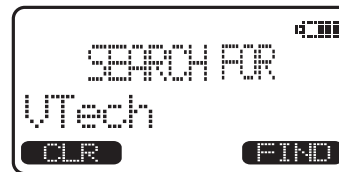
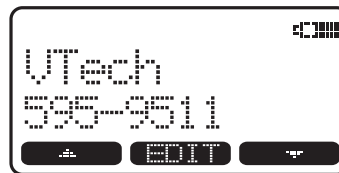

To Delete a Number/Name:

- Using the steps from 1 to 3 in **To Search For and Dial a Number/ Name**, locate the entry you want to delete.
- Press the **EDIT** soft key. The Handset will display:
- Press the **DEL** soft key. The Handset will display:

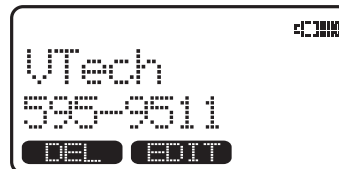

Memory

- To delete the displayed records, press **THIS**.
- To delete all the records, press **ALL**. To confirm the deletion of **ALL** records, press **YES**. To exit without deleting press **NO**.

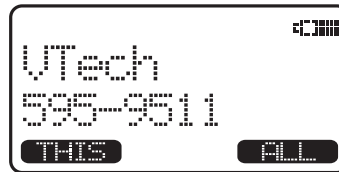

To Edit a Number/Name

- Using the steps from 1 to 3 in **To Search For and Dial a Number/Name**, locate the entry you want to edit.
- Press the **EDIT** soft key twice.
- Press either **NAME** or **NUM** for editing.
- Using the **←** soft key, move the cursor to the character you want to edit and then enter the corrections as needed. Press **MORE** to access **DEL**, **BACK** and **PAUSE** (when editing the name - **DEL**, **BACK** and **SPACE**) functions. When finished press the **SAVE** soft key. To exit without saving press **OFF** on the Handset.
- When finished the Handset will display the edited entry.

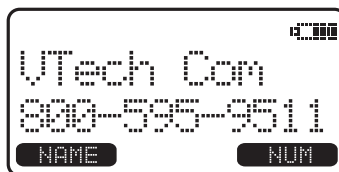
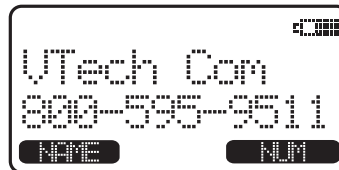
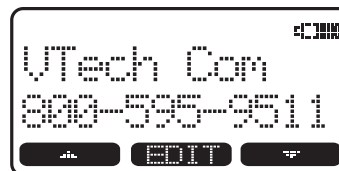

Handset and Base Operation

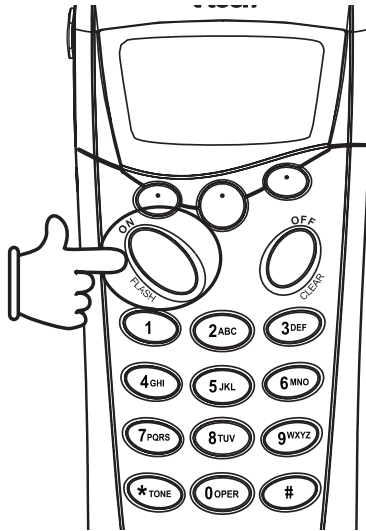

Making Calls



- Press **ON** (or, **SPEAKER** to use the Handset Speakerphone feature). Dial the phone number.
- OR-
- Dial the phone number first; then press **ON** (or **SPEAKER**).
- Press **OFF** to end your call.
- OR-
- Place the Handset in the Base cradle to end your call.

Answering Calls



- Press any key except **OFF** and the soft keys. If you press **OFF** when the Handset is ringing, the ringer will be temporarily muted.
- Press **OFF** to end your call.
- OR-
- Place the Handset in the Base cradle to end your call.

Mute Function

During an active call, press the **MUTE** soft key on the Handset to disable the microphone. Press **MUTE** again to return to the 2-way conversation.

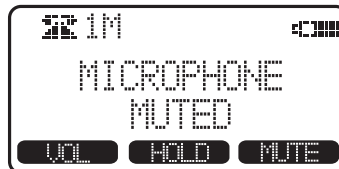

Hold Function

- Press the **HOLD** soft key to place a call on hold. To return to the call press the **ON** (or **SPEAKER**) key.

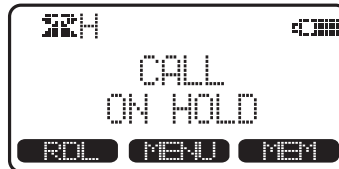

Handset and Base Operation

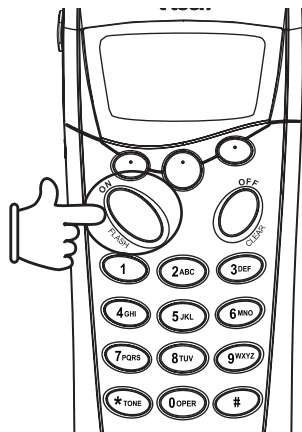

Flash Function



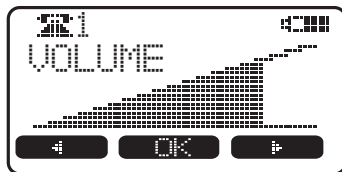

You can use your **v 2656** with services such as Call Waiting. Simply press the **ON** key on the Handset to **FLASH** the line.



Volume Control

From the Handset:

During an active call, press the **VOL** soft key, then use the  and  soft keys to adjust the earpiece (or Handset Speaker) volume.

Notice the change in the display graph as you adjust the volume. An increase in volume will be represented by an increase in shaded area on the graph. A decrease in volume will result in a reduction in the shaded area.

Press **OK** to confirm your setting.

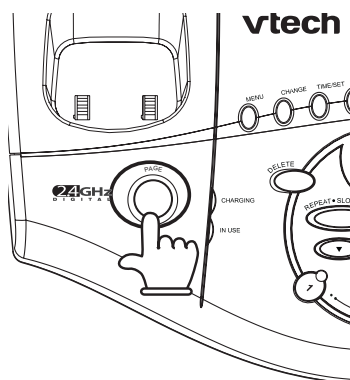

Page



From Base to ALL Handsets:

- To page all Handsets from the Base press the **PAGE** key. This will cause all Handsets linked with this Base to ring.
- Each Handset will display **PAGE FROM BASE**.
- To end a **PAGE** call, press any digit key on the Handset or **PAGE** on the Base.

Handset and Base Operation

From Handset to Handset:

- Press the **INTERCOM** key followed by the number of the other Handset you wish to call (e.g. **INTERCOM 3**).
- Handset 3 can then answer the intercom call by pressing the **INTERCOM** key.
- To end the intercom call press **OFF** on either Handset.

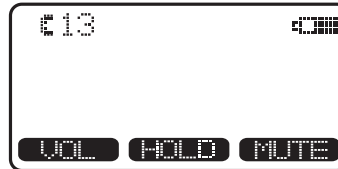

NOTE: If only one Handset is registered, the LCD will display "Feature Not Available" when INTERCOM key is pressed.

Global Page

- Press **INTERCOM**. Then scroll down to **GLOBAL PAGE**. Press **OK**.
- Any Handset can answer by pressing **INTERCOM**.
- To end the intercom call press **OFF** on Handset.

Handsfree Speakerphone Operation

Your **v 2656** Handset has a built-in handsfree speakerphone. This feature allows you to stand the Handset upright on a table or desktop and have handsfree conversations. For more information, refer to **MAKING CALLS** in **HANDSET AND BASE OPERATION**.

Switching between the Handset Earpiece and Speakerphone

If you are using the Handset earpiece, press **SPEAKER** to continue your call using the Handset Speakerphone.

To return to the earpiece, press **SPEAKER** again.

In Use Indication

On the Handset:

When the telephone line is currently being used by a **v 2656** Handset, a status message similar to this will display on idle Handset(s):

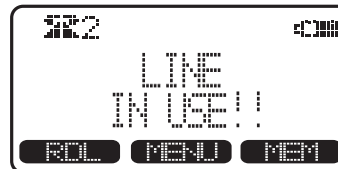

When the telephone line is currently being used by a parallel set (a telephone device other than the **v 2656** on the same line); the phone icon will remain on steadily, and **EXTENSION IN USE** will be displayed.

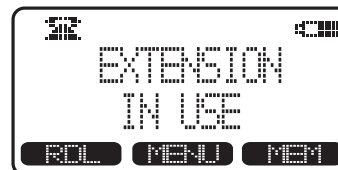

On the Base:

When the telephone line is currently being used by a **v 2656** Handset, the **IN USE** LED on the Base will illuminate steadily.

When the telephone line is currently being used by a parallel set (a telephone device other than the **v 2656** on the same line), the **IN USE** LED on the Base will flash.

When the answering system answers a call, the **IN USE** LED on the Base will flash, too.

Handset and Base Operation

Low Battery Indication

When a low battery is detected, the Battery icon will flash and a warning beep is played. The status message **LOW BATTERY** will also be displayed when the Handset is in idle mode. To prevent an unexpected call drop, a drained Handset battery should be replaced by a fully charged spare battery.

Conference Calling

The **v 2656** is capable of supporting conference calls with up to two registered Handsets.

To enter a conference call, simply access the line with two extensions by pressing **ON** (or **SPEAKER**) on the Handset.

The phone icon  and two extension numbers will be displayed in the upper left corner of the Handset LCD.

Transferring Calls

You can transfer calls on the **v 2656** system from the Handset to Handset.

Blind Transfer

You can directly transfer any active call to another **v 2656** extension without notification by doing the following steps:

- Handset must be on an active call.
- Press the **INTERCOM** key followed by the number of the Handset (**1,2,3,4**) that you wish to transfer the call to.
- When the other extension answers by pressing **INTERCOM**, the call will automatically be connected to the other extension.
- An unanswered call will ring back to the originating Handset if not answered within 30 seconds. And if still not answered within 30 seconds, the call will automatically end.

Announced Transfer:

You can perform an announced transfer (call and advise another extension) of an active call by doing the following steps:

- Handset must be on an active call.
- Place the active call on **HOLD**.
- Press the **INTERCOM** key followed by the number of the Handset (**1,2,3,4**) that you wish to transfer the call to.
- When the other extension answers the intercom call, explain they have an active call waiting.
- The transferring extension presses **OFF** to end the intercom call.
- The other extension presses **ON** (or **SPEAKER**) on the Handset to pick up the call on hold.

Answering System Operation

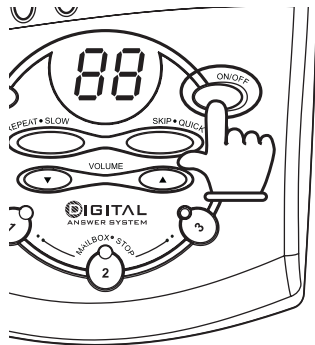

Audible Indicators

This system gives you voice prompts for feature operations and voice confirmations when you press a button or complete an operation.

Turn Answering System On or Off



When you supply power to the Base Unit, the Answering System will be turned ON. Press **ON/OFF** to turn the system on or off.

The message window shows the total number of messages in all mailboxes. When the system is turned on, you will hear "Answering machine on" and the **ON/OFF** light will be lit.

When the system is off, you will hear "Answering machine off" and the **ON/OFF** light will not be lit. The system will still answer after 10 rings if it is off, then announce "Please enter your security code" and wait for you to enter your two-digit code to access remote functions. (See **Remote Access** on page 34 for details.)

Set the Clock

This system comes preset to Monday, 12:00 AM, and **CL** will flash in the message window. You will need to set the correct day and time at the Base.

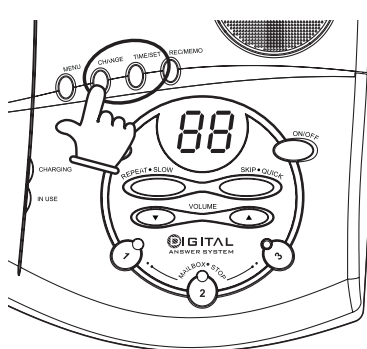

- 1 Press **TIME/SET**. The time and day will be announced, followed by "To set day and time, press TIME/SET." Press **TIME/SET** again. The day will be announced.
- 2 Press **CHANGE** until the system announces the correct day, then press **TIME/SET**. The system announces the current hour setting.
- 3 Press **CHANGE** until the system announces the correct hour, press **TIME/SET**. The system announces the current minute setting.

- 4 Press **CHANGE** to advance the minutes one at a time
- OR -

Press and hold **CHANGE** to advance the minutes in increments of 10. When the system announces the correct minute, press **TIME/SET**. The system announces the current clock setting.

NOTE: Press a **MAILBOX/STOP** button to exit programming at any time.

Answering System Operation

About Mailboxes

This answering system has three voice mailboxes. Callers using a touch tone phone can select the mailbox in which their messages will be recorded by pressing 1, 2, or 3 while the system plays the outgoing announcement. Otherwise, messages will be recorded in Mailbox 1.

About Announcements

- You can record two different announcements ---- one for normal answering and one for when you've set the system to play the announcement only.
- Use normal answering when you want the system to record callers' messages. Use Announce only when you want to give information to callers without accepting messages.
- If you choose not to record an announcement, the system answers with a pre-recorded announcement.
- The normal answering pre-recorded announcement says: "Hello. I'm unable to answer your call right now. Please leave your name, number and a message after the tone." The Announce Only pre-recorded announcement says: "Hello, I'm unable to answer your call right now. Please call again. Thanks you."
- By setting Announce Only to On or Off, you decide which announcement your callers will hear when the system answers a call (the system comes set for normal answering, with Announce Only turned off). See **Set Announce Only** on page 29 to change your announcement selection.

Record Your Announcement

NOTE: If you have assigned different mailboxes to different people, be sure to tell callers in your announcement to press 1, 2, or 3 to leave a message in the appropriate mailbox. Remember to leave a few seconds blank at the end of your recorded announcement to allow callers time to select a mailbox. An example of an announcement:

"Thank you for calling. To leave a message for Bob, press **1** now; to leave a message for Sue, press **2** now; to leave a message for Elmo, press **3** now; or, wait for the beep and leave your message."

The system will record your announcement for the currently selected answer mode (normal or Announce Only). To confirm or change the answer mode, follow the directions under **Answering System Feature Setup** and **Feature Summary** on pages 28 and 29.



- 1 With the system set for the desired answer mode (normal or Announce Only) press **MENU** until you hear "Set Outgoing Message."
- 2 Press **REC/MEMO**. After you hear "Now recording" followed by a beep, speak toward the base to record an announcement up to 90 seconds long.

Answering System Operation

- 3 Press any **MAILBOX/STOP** button to stop recording. The system plays back your recorded message.

To review your announcement:

- 1 Press **MENU** until you hear "Set Outgoing Messages."
- 2 Press any **MAILBOX/STOP** button. The system plays the current announcement.

To delete your announcement:



Press **DELETE** during announcement playback.

The system will use the pre-recorded announcement until you record a new one.

Answering System Feature Setup

You can set up one feature at a time, or

you can set up a feature and then move on to set up another feature.

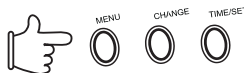

- 1 Make sure the answering system is on.
- 2 Press and release **MENU** until you hear the system announce the feature you want to set. Refer to **Feature Summary** on page 29 for a description of the features and your choices.
- 3 Press **TIME/SET** to hear the current setting.
- 4 Press **CHANGE** until you hear your desired setting.
- 5 Press **TIME/SET** to confirm your selection.

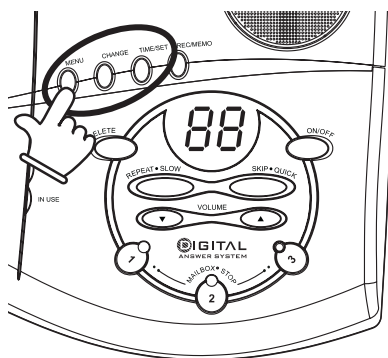
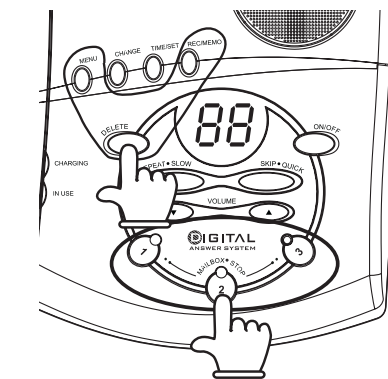

Answering System Operation

FEATURE SUMMARY	Default setting indicated by*:
SYSTEM ANNOUNCES:	DESCRIPTION/DIRECTIONS:
"Set Security Code" 50*	Set the remote access code you will use to access features and functions of the answering system from a touch tone phone. Choose a two-digit number from 40 to 99 .
"Set Audible Message Alert" Off* On	When Message Alert is turned on, the Base beeps once every 10 seconds when new messages have been received.
"Set Announce Only" Off* On	When you turn Announce Only on, callers hear your announcement but cannot leave a message.
"Set Base Ringer" On* Off	Turn the Base ringer on or off.
"Set Number of Rings" 2 4* 6 Toll Saver	Choose how many times the phone will ring before the system answers a call. With Toll Saver active, the system answers after two rings when you have new messages and after four rings when you have no new messages.

NOTE: Exit Feature Setup at any time by pressing a **MAILBOX/STOP** button.

Answering System Operation

This system automatically saves your messages until you delete them, and can store approximately 15 minutes of messages, memos, and announcements (up to a maximum of 99 messages). A message or memo can be up to 4 minutes long.

If the system has less than 30 seconds of recording time left, it automatically turns off. The system will still answer after 10 rings, announce "Memory full. Please enter your security code" and wait for the caller to enter the code to access remote functions. (See Remote Access beginning on page 34 for details.)

When you have new messages or memos, the **MAILBOX/STOP** light for each mailbox with new messages flashes.

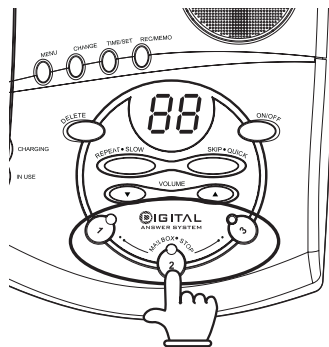

Listen to Messages



A Mailbox key will flash if you have new messages. If all messages in that Mailbox are old, the key will glow steadily.

Press a **MAILBOX/STOP** button for the mailbox you want to review. The system announces the mailbox number, the number of new messages

and the number of old messages. The system then plays only new messages in the Mailbox. After all new messages are played, press the **MAILBOX/STOP** button again to hear all (old) messages.

Before each message or memo playing, the system announces the day and time it was received.

While a message plays, the message window displays the number of that message.

Press **REPEAT/SLOW** during playback to hear a message again. If you press **REPEAT/SLOW** twice in the first two seconds of a message, the system will backup to replay the previous message.

Press **SKIP/QUICK** during playback to skip to the next message.

Press and hold **SKIP/QUICK** or **REPEAT/SLOW** during message playback to speed up or slow down playback of a message.

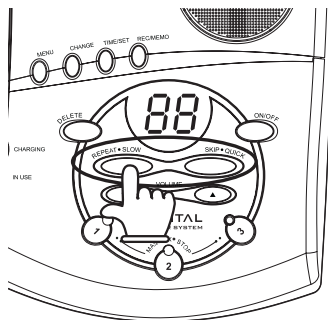

After playing the last message in a mailbox, the system announces "End of messages." If the system has less than five minutes of recording time left, it announces the remaining time.

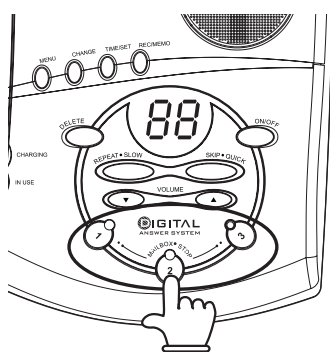

Answering System Operation

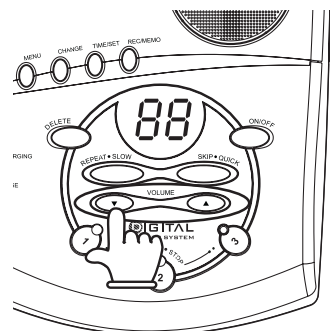

Press the **MAILBOX/STOP** button at any time during playback to exit message playback. You will hear a long beep.



Adjust Playback Volume

Press **VOLUME**  or **VOLUME**  to adjust playback volume to a comfortable level. If volume is set to level 1, you will not hear incoming messages as they are received.

The system beeps three times when you reach the highest or lowest volume setting.

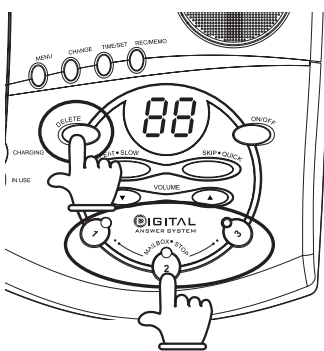

Delete Messages

NOTE: Deleted messages cannot be recovered.



Delete a Specific Message

Press **DELETE** while a message is playing to delete only that message.

Delete All Old Messages in a Mailbox

Press **DELETE**. The system announces, "Please select mailbox." Press the desired **MAILBOX/STOP** button. The system erases all old (previously reviewed) messages and memos in that mailbox.

Answering System Operation

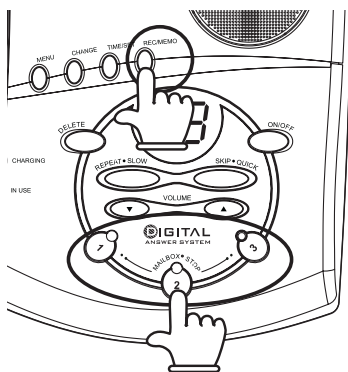

Record a Memo

You can record a memo up to four minutes long to store as an incoming message.

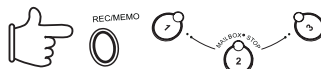



- 1 Press and release **REC/MEMO**. The system announces "Please select mailbox."
- 2 Press a **MAILBOX/STOP** button to select a mailbox for the memo. After the system announces "Now recording," speak towards the Base. The message window displays the length of your memo, up to 99 seconds. If you are recording a longer memo, 99 continues to flash until you finish.
- 3 To stop recording, press the **MAILBOX/STOP** button again.

Call Screening

- 1 Set the Base playback volume to a level greater than **1** to hear messages as your callers leave them.
- 2 If you press **ON** on the Handset, the Answering System will stop recording, and you can talk to your caller.
- 3 If you do not want to screen messages as your callers leave them, set the playback volume on the Base to **1**.

Answering System Operation

MESSAGE WINDOW DISPLAY

WINDOW DISPLAYS	TO INDICATE:
0	No messages in any mailbox
1-98	Total number of messages in all mailboxes
0-99 ↔ F	Memory is full or total number of messages is 99
Counting 1 to 99	Duration of announcement or memo recording. (Maximum length of announcement is 90 seconds.)
99, flashing	Length of recording is more than 99 seconds
1-99, flashing	New message number during message playback
1-8, steady for one second	Indicates volume level selected when VOLUME  or VOLUME  is pressed
40-99	Current Remote Access Code while setting
A	Announce Only mode
On or OF, steady for one second	Displayed when any setting is changed from on or off
CL ↔ normal display	Clock needs to be set
--	System is answering a call or is in remote operation
--, Flashing	System is in programming mode or initializing

Answering System Operation

Remote Access

You can access many features of this system remotely from a touch tone phone.

- 1 Dial your telephone number.
- 2 When the system answers enter your Remote Access Code (preset to 50). The system beeps once and announces the number of new messages on the system.
- 3 Enter a remote command (see "Remote Access Commands").
- 4 Press * 0 to exit remote operation.

Voice Menu

The system has voice prompts to help you with remote operation.

Press * 5 to hear the menu while remotely connected to the answering system.

REMOTE ACCESS COMMANDS

FUNCTION:	COMMAND:
Play messages in a mailbox	Press #, then the appropriate mailbox number (1, 2, 3). The system plays new messages. If there are no new messages, the system plays old messages.
Repeat a message	Press # 4 while message is playing; press #4 twice to backs up another message.
Skip a message	Press # 6 while message is playing; each press advances another message.
Stop	Press # 5.
Save messages	Hang up.
Delete message	Press # 9 while message is playing.
Review announcement	Press # 7; system plays announcement, then beeps.
Record announcement	Press *7; after beep, record announcement, press # 5 to stop. System plays back announcement.
Record memo	Press * 8, then the mailbox number where you want memo recorded; speak after the system announces "Now recording." Press # 5 to stop.
End remote access call	Press * 0.
Turn system off	Press #0; the system announces, "Answering machine off. " Press # 0 again to turn the system back on.
Turn system on	When system is off, it answers after 10 rings and announces, "Please enter your security code." Enter your remote access code.

NOTE: If no key is pressed within 10 seconds of entering remote access, the voice menu will be announced. After the voice menu announcement, if no key is pressed within 20 seconds, the remote access call will automatically end.

Headset Operation

Your **v 2656** cordless telephone is equipped with a 2.5mm Headset Jack for use with an optional accessory Headset for hands-free operation. If you choose to use the Headset option, you must obtain an optional accessory Headset, which is compatible with the **v 2656**.

To purchase a Headset, call VTech Customer Service at 1-800-595-9511. In Canada, call 1-800-267-7377.

Once you have a compatible 2.5mm Headset, locate the Headset Jack on the Handset. Connect the plug on the Headset cord to the jack on the cordless Handset (under a small rubber flap). The plug should fit securely. Do not force the connection.

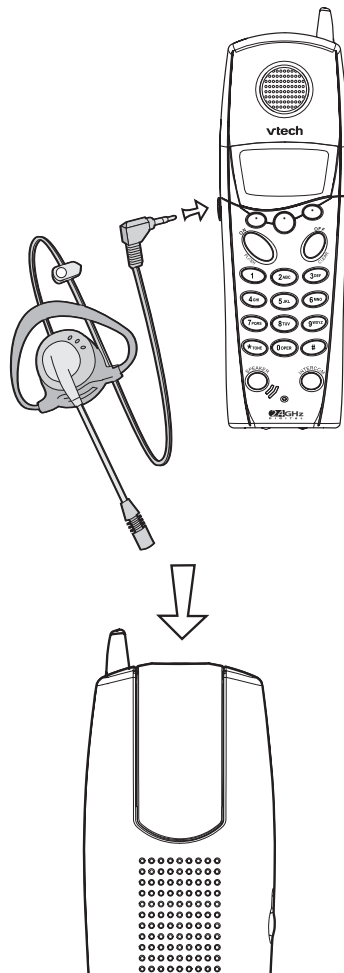

NOTE :

Whenever a compatible Headset is connected to the cordless Handset, the microphone on the Handset will be muted. This is done to limit the effect of background noise.

Belt Clip

Your **v 2656** is equipped with an attached belt clip. At the top of the Handset, slide the clip away from the body of the Handset by pushing on the indent with your finger.

CAUTION: The Belt Clip is designed to remain attached to the Handset. Do not attempt to remove it.

Maintenance

Taking Care Of Your Telephone

Your v 2656 cordless telephone contains sophisticated electronic parts, so it must be treated with care.

Avoid rough treatment

Place the Handset down gently. Save the original packing materials to protect your telephone if you ever need to ship it.

Avoid water

Your telephone can be damaged if it gets wet. Do not use the Handset outdoors in the rain, or handle it with wet hands. Do not install your Base Unit near a sink, bathtub or shower.

Electrical storms

Electrical storms can sometimes cause power surges harmful to electronic equipment.

For your own safety, use caution when using electric appliances during storms.

Cleaning your telephone

Your telephone has a durable plastic casing that should retain its luster for many years. Clean it only with a soft cloth slightly dampened with water or a mild soap. Do not use excess water or cleaning solvents of any kind.

Remember that electrical appliances can cause serious injury if used when you are wet or standing in water. If your Base Unit should fall into water, **DO NOT RETRIEVE IT UNTIL YOU UNPLUG THE POWER CORD AND TELEPHONE LINE CORDS FROM THE WALL.** Then pull the unit out by the unplugged cords.

For optimum performance, regularly clean the metal charge contacts located in the Base Unit charge cradle and on the bottom of the Handset. Gently rub the contacts with a clean pencil eraser. In most environments, monthly contact maintenance is sufficient.

In Case Of Difficulty

If you have difficulty operating your phone, the suggestions below should solve the problem. If you still have difficulty after trying these suggestions, call VTech Communications at 1-800-595-9511. In Canada, call VTech Telecommunications Canada Ltd. at 1-800-267-7377.

The Phone Doesn't Work At All

- Make sure the Power Cord is plugged in.
- Make sure the telephone line cord is plugged firmly into the Base Unit and the telephone wall jack.
- Make sure the batteries are properly charged. If the **LOW BATTERY** message is shown, the battery pack needs charging.

No Dial Tone

- First check all the suggestions above.
- If you still don't hear a dial tone, disconnect the Base Unit from the telephone jack and connect a different phone. If there is no dial tone on that phone either, the problem is in your wiring or local service. Contact your local telephone company.

You Get Noise, Static, Or A Weak Signal Even When You're Near The Base Unit

- Household appliances plugged into the same circuit as the Base Unit can sometimes cause interference. Try moving the appliance or the Base Unit to another outlet.

You Get Noise, Static, Or A Weak Signal When You're Away From The Base Unit

- You may be out of range. Either move closer to the Base, or relocate the Base Unit.
- The layout of your home may be limiting the range. Try moving the Base Unit to another position.

The Handset Does Not Ring When You Receive A Call

- Make sure you have the Handset ringer activated. To set the ringer, see **HANDSET SETTINGS**.
- Make sure the telephone line cord is plugged firmly into the Base Unit and the telephone jack. Make sure the power cord is plugged in.
- You may be too far from the Base Unit.
- You may have too many extension phones on your telephone line to allow all of them to ring. Try unplugging some of the other phones.

In Case Of Difficulty

You Hear Other Calls While Using Your Phone

- Disconnect your Base Unit from the telephone jack, and plug in a regular telephone. If you still hear other calls, the problem is probably in your wiring or local service. Call your local telephone company.

You Hear Noise In The Handset, And None Of The Keys Or Buttons Work

- Make sure the power cord is plugged in.

Common Cure For Electronic Equipment

If the unit does not seem to be responding normally, then try putting the Handset in the cradle. If it does not seem to respond, do the following (in the order listed) :

1. Disconnect the power to the Base.
2. Disconnect the Handset battery.
3. Wait a few minutes.
4. Connect power to the Base.
5. Re-install the battery pack
6. Watch for Handset to display



then



Your Answering System is not recording messages

- Make sure your answering system is turned on (**ON/OFF** light should be glowing.)
- Make sure Announce Only is set to **OFF**.

CL is flashing on the Base Unit

- The Day and Time must be set. See **Set the Clock** on page 26

You can't hear your messages

- Make sure the Base volume is set above level 1.

Warranty Statement

What does this limited warranty cover?

- The manufacturer of this VTech product, VTech Communications, warrants to the holder of a valid proof of purchase ("Consumer" or "you") that the product and all accessories provided by VTech in the sales package ("Product") are free from material defects in material and workmanship, pursuant to the following terms and conditions, when installed and used normally and in accordance with operation instructions. This limited warranty extends only to the Consumer for Products purchased and used in the United States of America.

What will VTECH Communications do if the Product is not free from material defects in materials and workmanship during the limited warranty period ("Materially Defective Product")?

- During the limited warranty period, VTech's authorized service representative will repair or replace at VTech's option, without charge, a Materially Defective Product. If we repair this product, we may use new or refurbished replacement parts. If we choose to replace this product, we may replace it with a new or refurbished product of the same or similar design. VTech will return repaired or replacement products to you in working condition. VTech will retain defective parts, modules, or equipment. Repair or replacement of Product, at VTech's option, is your exclusive remedy. You should expect the repair or replacement to take approximately 30 days.

How long is the limited warranty period?

- The limited warranty period for the product extends for ONE(1) YEAR from the date of purchase if we repair or replace a Materially Defective Product under the terms of this limited warranty. This limited warranty also applies to repaired or replacement Products for a period of either (a) 90 days from the date the repaired or replacement Product is shipped to you or (b) the time remaining on the original one-year warranty; whichever is longer.

What is not covered by this limited warranty?

This limited warranty does not cover

1. Product that has been subjected to misuse, accident, shipping or other physical damage, improper installation, abnormal operation or handling, neglect, inundation, fire, water or other liquid intrusion; or
2. Product that has been damaged due to repair, alteration or modification by anyone other than an authorized service representative of VTech; or
3. Product to the extent that the problem experienced is caused by signal conditions, network reliability or cable or antenna systems; or
4. Product to the extent that the problem is caused by use with non-VTech electrical accessories; or
5. Product whose warranty/quality stickers, Product serial numbers plates or electronic serial numbers have been removed, altered or rendered illegible; or
6. Product purchased, used, serviced, or shipped for repair from outside the United States, or used for commercial or institutional purposes (including but not limited to Products used for rental purposes); or
7. Product returned without valid proof of purchase (see 2 below); or

Warranty Statement

- Charges for installation or set up, adjustment of customer controls, and installation or repair of systems outside the unit.

How do you get warranty service?

- To obtain warranty service in the United States of America, call 1- 800-595-9511 for instructions regarding where to return the Product. Before calling for service, please check the user's manual. A check of the Product controls and features may save you a service call.
- Except as provided by applicable law, you assume the risk of loss or damage during transit and transportation and are responsible for delivery or handling charges incurred in the transport of Product(s) to the service location. VTech will return repaired or replaced product under this limited warranty to you, transportation, delivery or handling charges prepaid. VTech assumes no risk for damage or loss of the Product in transit.
- If the Product failure is not covered by this limited warranty, or proof of purchase does not meet the terms of this limited warranty, VTech will notify you and will request that you authorize the cost of repair and return shipping costs for the repair of Products that are not covered by this limited warranty.

What must you return with the Product to get warranty service?

- Return the entire original package and contents including the Product to the VTech service location along with a description of the malfunction or difficulty;
- Include "valid proof of purchase" (sales receipt) identifying the Product purchased (Product model) and the date of purchase or receipt; and
- Provide your name, complete and correct mailing address, and telephone number.

Other Limitations

- This warranty is the complete and exclusive agreement between you and VTech. It supersedes all other written or oral communications related to this Product. VTech provides no other warranties for this product. The warranty exclusively describes all of VTech's responsibilities regarding the product.

There are no other express warranties. No one is authorized to make modifications to this limited warranty and you should not rely on any such modification.

State Law Rights: This warranty gives you specific legal rights, and you may also have other rights which vary from state to state.

Limitations: Implied warranties, including those of fitness for a particular purpose and merchantability (an unwritten warranty that the product is fit for ordinary use) are limited to one year from date of purchase. Some states do not allow limitations on how long an implied warranty lasts, so the above limitation may not apply to you.

- In no event shall VTech be liable for any indirect, special, incidental, consequential, or similar damages(including, but not limited to lost profits or revenue, inability to use the product, or other associated equipment, the cost of substitute equipment, and claims by third parties) resulting from the use of this product, some states do not allow the exclusion or limitation of incidental or consequential damages, so the above limitation or exclusion may not apply to you.

FCC, ACTA and IC Regulations

This equipment complies with Parts 15 of the Federal Communications Commission (FCC) rules for the United States. It also complies with regulations RSS210 and CS-03 of Industry and Science Canada. Operation is subject to the following two conditions: (1) this device may not cause interference, and (2) this device must accept any interference, including interference that may cause undesired operation of the device.

A label is located on the underside of the Base Unit containing either the FCC registration number and Ringer Equivalence Number (REN) or the IC registration number and Load Number. You must, upon request, provide this information to your local telephone company.

This equipment is compatible with inductively coupled hearing aids.

Should you experience trouble with this telephone equipment, please contact:

VTech Communications Inc.

CUSTOMER SERVICE at 1-800-595-9511. In Canada, call VTech Telecommunications Canada Ltd. at 1-800-267-7377.

For repair/warranty information, the telephone company may ask you to disconnect this equipment from the line network until the problem has been corrected.

FCC Part 15

Warning: Changes or modifications to this unit not expressly approved by the party responsible for compliance could void the user's authority to operate the equipment.

The equipment has been tested and found to comply with part 15 of the FCC rules. These limits are designed to provide reasonable protection against harmful interference in a residential installation. This equipment generates, uses and can radiate radio frequency energy and, if not installed and used in accordance with the instructions, may cause harmful interference to radio communications. However, there is no guarantee that interference will not occur in a particular installation. If this equipment does cause harmful interference to radio or television reception, which can be determined by turning the equipment off and on, the user is encouraged to try and correct the interference by one or more of the following measures:

- Reorient or relocate the receiving antenna.
- Increase the separation between the equipment and receiver.
- Connect the equipment into an outlet or on a circuit different from that to which the receiver is connected.
- Consult the dealer or an experienced radio/TV technician for help.

To comply with FCC RF exposure requirements, the Base Unit should be installed with its antenna located at 5 cm or more from persons.

FCC, ACTA and IC Regulations

FCC and ACTA Information

If this equipment was approved for connection to the telephone network prior to July 23,2001, it was registered with the Federal Commissions (FCC) in accordance with Part 68 of its rules. If the equipment was approved after that date, it complies with the Part 68 rules and with Technical Requirements for Connection of Equipment to the Telephone Network adopted by the Administrative Council for Terminal Attachments (ACTA). We are required to provide you with the following information.

1. Connection and use with the nationwide telephone network

The plug and jack used to connect this equipmet to the premises wiring and the telephone network must comply with the applicable Part 68 rules and technical requirements adopted by ACTA. A compliant telephone cord and modular plug is provided with this product. It is designed to be connected to a compatible modular jack that is also compliant. An RJ11 jack should normally be used for connecting to a single line and an RJ14 jack for two lines. See Installation Instructions in the user's manual. This equipment may not be used with Coin Telephone Lines or with Party Lines. If you have specially wired alarm dialing equipment connected to your telephone line, ensure the connection of this equipment does not disable your alarm equipment. If you have questions about what will disable alarm equipment, consult your telephone company or a qualified installer.

2. Product identifier and REN information

The label on the back or bottom of this equipment contains, among other things, an identifier indicating product approval and the Ringer Equivalence Number (REN). This information must be provided to your local telephone company upon request. For equipment approved prior to July 23,2001, the product identifier is preceded by the phrase "FCC Reg No." and the REN is listed separately. For equipment approved after that date, the product identifier is preceded by "US" and a colon (:), and the REN is encoded in the product identifier as the sixth and seventh characters following the colon. For example, the product identifier US: AAAEQ03T123XYZ would indicate an REN of 0.3.

The REN is used to determine how many devices you may connect to your telephone line and still have them ring when you are called. In most, but not all areas, the sum of all RENS should be five (5.0) or less. You may want to connect your local telephone company for more information.

3. Repair instructions

If the equipment is malfunctioning, it must be unplugged from the modular jack until the problem has been corrected. Repairs to this telephone equipment can only be made by the manufacturer or its authorized agents. For repair procedures, follow the instructions outlined under the Limited Warranty.

4. Rights of the telephone company

If this equipment is causing harm to the telephone network, the telephone company may temporarily discontinue your telephone service. The telephone company is required to notify you before interrupting service. If advance notice is not practical, you will be notified as soon as possible. You will be given the opportunity to correct the problem and the telephone company is required to inform you of your right to file a complaint with the FCC. Your telephone company may make changes in facilities, equipment, operation, or procedures that could affect the proper functioning of this product. The telephone company is required to notify you if such changes are planned.

FCC, ACTA and IC Regulations

5. Hearing aid compatibility

If this product is equipped with a corded or cordless handset, it is hearing aid compatible.

6. Programming/testing of emergency numbers

If this product has memory dialing locations, you may choose to store police, fire department and emergency medical service telephone number in this locations. If you do, please keep three things in mind:

- a. We recommend that you also write the telephone number on the directory card, so that you can still dial the emergency number manually if the memory dialing feature doesn't work.
- b. This feature is provided only as a convenience, and the manufacturer assumes no responsibility for customer reliance upon the memory feature.
- c. Testing the emergency telephone numbers you have stored is not recommended. However, if you do make a call to an emergency number:
 - You must remain on the line and briefly explain the reason for the call before hanging up.
 - Programming/testing of emergency numbers should be performed during off-peak hours, such as in the early morning or late evening, when the emergency services tend to be less busy.

IC (Industry Canada)

This telephone is registered for use in Canada.

Notice:

This equipment meets the applicable Industry Canada Terminal Equipment Technical Specifications. This is confirmed by the registration number. The abbreviation, IC, before the registration number signifies that registration was performed based on a Declaration of Conformity indicating that Industry Canada technical specifications were met. It does not imply that Industry Canada approved the equipment.

Notice:

The Ringer Equivalence Number (REN) for this terminal equipment is 0.1. The REN assigned to each terminal equipment provides an indication of the maximum number of terminals allowed to be connected to a telephone interface. The termination on an interface may consist of any combination of devices subject only to the requirement that the sum of the Ringer Equivalence Numbers of all the devices does not exceed five.

Before installing this equipment, users should ensure that it is permissible to be connected to the facilities of the local telecommunications company. The equipment must also be installed using an acceptable method of connection. The customer should be aware that compliance with the above conditions may not prevent degradation of services in some situations.

Repairs to certified equipment should be made by an authorized Canadian maintenance facility designated by the supplier. Any repairs or alterations made by the user to this equipment, or equipment malfunctions,

FCC, ACTA and IC Regulations

may give the telecommunications company cause to request the user to disconnect the equipment.

Users should ensure for their own protection that the electrical ground connections of the power utility, telephone lines and internal metallic water pipe system, if present, are connected together. This precaution may be particularly important in rural areas.

Caution :

Users should not attempt to make such connections themselves, but should contact the appropriate electrical inspection authority, or electrician, as appropriate.

Your **v 2656** is designed to operate at the maximum power allowed by the FCC and IC. This means your Handset and Base Unit can communicate only over a certain distance - which will depend on the location of the Base Unit and Handset, weather, and the construction and layout of your home or office.

The RBRC[®] Seal



The RBRC[®] Seal on the nickel-cadmium battery indicates that VTech Communications, Inc. is voluntarily participating in an industry program to collect and recycle these batteries at the end of their useful lives, when taken out of service within the United States and Canada.

The RBRC[®] program provides a convenient alternative to placing used nickel-cadmium batteries into the trash or municipal waste, which may be illegal in your area.

VTech's participation in RBRC[®] makes it easy for you to drop off the spent battery at local retailers participating in the RBRC[®] program or at authorized VTech product service centers. Please call **1-800-8-BATTERY[™]** for information on Ni-Cd battery recycling and disposal bans/restrictions in your area. VTech's involvement in this program is part of its commitment to protecting our environment and conserving natural resources.

RBRC[®] is a registered trademark of Rechargeable Battery Recycling Corporation.

Technical Specifications

FREQUENCY CONTROL

Crystal controlled
PLL synthesizer

TRANSMIT FREQUENCY

2401.056 - 2482.272 MHz

RECEIVE FREQUENCY

2401.056 - 2482.272 MHz

CHANNELS

95 Channels

NOMINAL EFFECTIVE RANGE

Maximum power allowed by FCC.
Actual operating range may vary
according to environmental conditions
at the time of use.

SIZE

Handset : 171.5mm x 53mm x 45mm

Base : 184.2mm x 142mm x
70.10mm

WEIGHT

Handset : 134 grams
Base : 392 grams

POWER REQUIREMENTS

Handset: 600mAh NiCd Battery
Pack

Base : 9 VDC @ 500mA

MEMORY

Directory: 50 Memory locations;
32 digits per location.

CID: Alphanumeric Display;
50 Memory locations

**SPECIFICATIONS ARE TYPICAL
AND MAY CHANGE WITHOUT
NOTICE.**

Additional Information

Table Of Contents

1. Important Instructions	Safety	23. Page
3. Introduction		24. Handsfree Speakerphone Operation
4. Parts Check List		24. In Use Indication
5. The Handset Layout		25. Low Battery Indication
6. The Base Unit Layout		25. Conference Calling
		25. Transferring Calls
7. Getting Started		26. Answering System Operation
7. Setup		26. Audible Indicators
9. Charging Of Handset Battery Pack		26. Turn Answering System On or Off
10. Wall Mounting		26. Set the Clock
11. Registration of Additional Handsets		27. About Mailboxes
		27. About Announcements
13. Basic Operation		27. Record Your Announcement
13. Handset and Base Indicators		28. Answering System Feature Setup
14. Soft Menu Functions		29. Feature Summary
14. Redial		30. Listen to Messages
15. Calls Log (Caller ID)		31. Adjust Playback Volume
16. Handset Settings		31. Delete Messages
17. Range Extender		32. Record a Memo
17. Tone/Pulse Selection		32. Call Screening
18. Register and Memory		33. Message Window Display
19. To Store a Number/Name		34. Remote Access
20. To Search For and Dial a Number/Name		34. Voice Menu
20. To Delete a Number/Name		34. Remote Access Commands
21. To Edit a Number/Name		35. Additional Information
22. Advanced Operation		35. Headset Operation
22. Handset and Base Operation		35. Belt Clip
22. Making Calls		36. Maintenance
22. Answering Calls		37. In Case Of Difficulty
22. Mute Function		39. Warranty Statement
22. Hold Function		41. FCC, ACTA and IC Regulations
23. Flash Function		44. The RBRC® Seal
23. Volume Control		45. Technical Specifications



vtech

VTECH TELECOMMUNICATIONS LTD.
A member of THE VTECH GROUP OF COMPANIES.

Distributed in the U.S.A. by VTech Communications, Inc.; Beaverton, Oregon.

Distributed in Canada by VTech Telecommunications Canada, Ltd.; Suite 200,7671
Alderbridge Way, Richmond, B.C. V6X 1Z9.

Copyright 2003 for VTECH TELECOMMUNICATIONS LTD.
Printed in China

91-005358-050-000
ISSUE 0



Free Manuals Download Website

<http://myh66.com>

<http://usermanuals.us>

<http://www.somanuals.com>

<http://www.4manuals.cc>

<http://www.manual-lib.com>

<http://www.404manual.com>

<http://www.luxmanual.com>

<http://aubethermostatmanual.com>

Golf course search by state

<http://golfingnear.com>

Email search by domain

<http://emailbydomain.com>

Auto manuals search

<http://auto.somanuals.com>

TV manuals search

<http://tv.somanuals.com>