

VOX

Valvetronix

ToneLab



Owner's Manual

Precautions

Location

Using the unit in the following locations can result in a malfunction.

- In direct sunlight
- Locations of extreme temperature or humidity
- Excessively dusty or dirty locations
- Locations of excessive vibration
- Close to magnetic fields

Power supply

Please connect the designated AC/AC power supply to an AC outlet of the correct voltage. Do not connect it to an AC outlet of voltage other than that for which your unit is intended.

Interference with other electrical devices

Radios and televisions nearby may experience reception interference. Operate this unit at a suitable distance from radios and televisions.

Handling

To avoid breakage, do not apply excessive force to the switches or controls.

Care

If the exterior becomes dirty, wipe it with a clean, dry cloth. Do not use liquid cleaners such as benzene or thinner, cleaning compounds or flammable polishes.

Keep this manual

After reading this manual, please keep it for later reference.

Keeping foreign matter out of your equipment

Never set any container with liquid on this equipment. If liquid gets into the equipment, it could cause a breakdown, fire, or electrical shock.

Be careful not to let metal objects get into the equipment. If something does slip into the equipment, unplug the AC/AC power supply from the wall outlet. Then contact your nearest Korg dealer or the store where the equipment was purchased.

THE FCC REGULATION WARNING (for U.S.A.)

This equipment has been tested and found to comply with the limits for a Class B digital device, pursuant to Part 15 of the FCC Rules. These limits are designed to provide reasonable protection against harmful interference in a residential installation. This equipment generates, uses, and can radiate radio frequency energy and, if not installed and used in accordance with the instructions, may cause harmful interference to radio communications. However, there is no guarantee that interference will not occur in a particular installation. If this equipment does cause harmful interference to radio or television reception, which can be determined by turning the equipment off and on, the user is encouraged to try to correct the interference by one or more of the following measures:

- Reorient or relocate the receiving antenna.
- Increase the separation between the equipment and receiver.
- Connect the equipment into an outlet on a circuit different from that to which the receiver is connected.
- Consult the dealer or an experienced radio/TV technician for help.

Unauthorized changes or modification to this system can void the user's authority to operate this equipment.

CE mark for European Harmonized Standards

CE mark which is attached to our company's products of AC mains operated apparatus until December 31, 1996 means it conforms to EMC Directive (89/336/EEC) and CE mark Directive (93/68/EEC). And, CE mark which is attached after January 1, 1997 means it conforms to EMC Directive (89/336/EEC), CE mark Directive (93/68/EEC) and Low Voltage Directive (73/23/EEC). Also, CE mark which is attached to our company's products of Battery operated apparatus means it conforms to EMC Directive (89/336/EEC) and CE mark Directive (93/68/EEC).

IMPORTANT NOTICE TO CONSUMERS

This product has been manufactured according to strict specifications and voltage requirements that are applicable in the country in which it is intended that this product should be used. If you have purchased this product via the internet, through mail order, and/or via a telephone sale, you must verify that this product is intended to be used in the country in which you reside.

WARNING: Use of this product in any country other than that for which it is intended could be dangerous and could invalidate the manufacturer's or distributor's warranty.

Please also retain your receipt as proof of purchase otherwise your product may be disqualified from the manufacturer's or distributor's warranty.

Data Handling

Incorrect operation or malfunction may cause the contents of memory to be lost, so we recommend that you save important data on a floppy disk or other media source. Please be aware that Korg will accept no responsibility for any damages which may result from loss of data.

- * A United States patent has been obtained for Valve Reactor technology. Patents are pending in other countries. (As of March 2003)
- * Company names, product names, and names of formats etc. are the trademarks or registered trademarks of their respective owners.

Quick Start

A GUIDE FOR THOSE WHO WANT TO PLAY GUITAR FIRST, AND READ THE MANUAL LATER!

Yep, you're right, the vast majority of manuals are about as interesting as watching paint dry and we know that you're anxious to plug in to your new ToneLab and give it a whirl in the comfort of your home. So, here's a "Quick Start" to get you up and running in a heartbeat.

First we'll get you started quickly using the preset programs. Then we'll explain how to use the knobs and switches of the amp and effect sections to create your own sounds.

Once you've satisfied your primal urge to play, I'd like to urge you to give this manual a chance - it's been written by a fellow guitar nut and boasts some killer bells "n" whistles that'll warrant your interest. In short, it'll be worth your while, we promise. I look forward to talking you through the ToneLab in more detail once you're done....

HINT: Want life to be easy? Of course you do! For this reason I suggest you fold out the inside back cover of this manual before you go any further.

HINT: Why? So you can see the pretty pictures of the Top Panel and Rear Panel it contains while you're going through the "Quick Start," that's why!

SETUP

1. If you're going to connect ToneLab to a mixer or recorder, set the rear panel AMP/LINE switch (9.1) to "LINE," and connect the OUTPUT jacks (L/MONO and R) (9.2) to the input jacks of your mixer or recorder. If you're monitoring through headphones, connect them to the PHONES jack (5.2).

If you're connecting ToneLab to a guitar amp for playing live, set the rear panel AMP/LINE switch to "AMP" and connect the L/MONO output jack to the input jack of your guitar amp.

NOTE: If you're connecting ToneLab to something that only has a mono input, just use the L/MONO jack.

NOTE: If you're connecting ToneLab to two amplifiers to run in stereo, take the L/MONO and R output jacks and connect them to the inputs on each amplifier.

HINT: Rear panel area  (at the end of this manual) shows an illustration of this.

2. Turn the LEVEL knob (9.3) on the rear panel of ToneLab all the way to the left, setting the volume to 0.
3. Plug the supplied AC/AC power supply into ToneLab's rear panel AC9V power inlet (6.1), and plug the power supply into an AC wall socket.
4. Plug your guitar into the front panel INPUT jack (5.1).

-
5. Before you turn ToneLab on, lower the volume of your amp or mixer so you don't hear any potentially speaker-damaging pops or buzzes. Then turn on the STANDBY switch (6.2) to power up ToneLab.
 6. Turn up the volume controls of your amp or mixer, and ToneLab's rear panel LEVEL knob (9.3) to adjust the volume.

NOTE: You won't hear sound for several seconds while the valve (a.k.a. "vacuum tube" if you live on the west side of the Atlantic) warms up. This isn't a malfunction – it's a real analogue valve!

LISTEN TO THE PROGRAMS

7. Use the BANK ▲, ▼ buttons (3.2) to select a bank 1–24.
Notice that the number in the bank display (3.1) blinks and changes.

HINT: ToneLab has 96 programs, organized into 24 banks with four channels in each bank ($24 \times 4 = 96$). When shipped from the factory, banks 1–12 contain 48 programs. (The programs in banks 13–24 are identical to the programs in banks 1–12.) Program Select mode lets you select these programs. ToneLab also has a Manual mode that simply reflects the current settings (positions) of the selectors and knobs.

HINT: For an illustration, look at [\[3\]](#) "Bank/Manual/Write/Tuner/Channel Section" in the diagram at the end of this manual.

8. Use the CHANNEL SELECT 1–4 buttons (3.3) to select a channel.
The selected channel will light, and the number in the bank display will stop blinking and stay lit. The program is now selected. Play your guitar to try it out! For example if you want to select program 1-2 (bank 1, channel 2), use the BANK ▲, ▼ buttons to make the bank display show "1," and then press the SELECT CHANNEL 2 button to make the button light.
To select another program in the same bank, simply press one of the CHANNEL SELECT buttons 1–4. To select a program from a different bank, perform steps 7 and 8.

NOTE: If you can't select a program, you're probably not in Program Select mode. Get back into Program Select mode as described in "Getting to Program Select Mode" (p.16).

HINT: The preset programs cover an amazing range of sounds; fat hi-gain lead sounds, nostalgic clean sounds that work best with your rhythm (neck) pickup, aggressive modern crunch sounds for heavy riffing with your lead (bridge) pickup, and much more. P.57 has a list of the preset programs.

STEP ON IT!: If you have the optional VOX Valvetronix foot controller, you can use it to switch programs.

CREATE YOUR OWN SOUNDS

9. To create your own sounds, use the knobs and buttons of the amp and effects sections – just as you would expect!

The controls of the amp section work basically the same as on your favorite guitar amp. Simply turn the GAIN (1.3), TREBLE, MIDDLE, BASS, PRESENCE (1.5–1.8), and VR GAIN (1.4) (which corresponds to MASTER) knobs to get your desired sound. To get the most distortion, turn up the VR GAIN knob. CH VOLUME (1.9) regulates the volume while preserving the overall sound, including the distortion produced by the Valve Reactor. When you use the AMP TYPE (1.1) and CABINET TYPE selectors (1.2), it's just as though a different guitar amp materialized right in front of you!

HINT: If you want to hear the amp section with absolutely no effects, set the PEDAL selector to the “OFF” position to turn off the PEDAL section. Then hold down the TAP button (2.4) for at least one second to bypass the MODULATION, DELAY, and REVERB effects. (The effect LEDs that had been lit will start blinking.)

HINT: P.33 lists recommended combinations of amp and cabinet models but others are fine too.

HINT: If you want to replicate the sound of the original amp, set [VR GAIN] to the maximum setting on vintage-type models that do not have a master volume control (i.e., AC15, AC15TB, AC30, AC30TB, UK BLUES, UK 68P, BLACK 2x12, TWEED 1x12, and TWEED 4x10). For modern-type amps that have a master volume control, adjust [VR GAIN] in the same way that you would on the original amp. When the [VR GAIN] setting is low, preamp-type distortion will occur. As you raise the [VR GAIN] setting, the pre-amp will begin loading the Valve Reactor to cause clipping, and the warmth and distortion of the Valve Reactor will be added.

HINT: For an illustration, look at area 1 in the top panel diagram at the end of this manual.

10. ToneLab provides a PEDAL effect that is placed before the amp, and MODULATION, DELAY, and REVERB effects that are placed after the cabinet.

If the MODULATION, DELAY, or REVERB effects are bypassed, press the TAP button (2.4) to activate them. For example if you want to use the MODULATION effect CHORUS, press the MODULATION TYPE button (2.3) several times to make the CHORUS LED light. Notice that the TYPE button is lit. In this state, you can adjust the chorus settings by turning the three value knobs 1–3 located at the right; these knobs will adjust the speed, amount of effect mixed into your sound, and the depth of modulation. You can adjust the DELAY and REVERB effects in the same way. To set the delay time for the DELAY effect, press the TAP button (2.4) twice at the delay interval you want.

HINT: Some effect settings may cause unwanted distortion. If this happens, lower the CH VOLUME (1.9).

HINT: For an illustration, look at area 2 in the top panel diagram at the end of this manual.

If you want to keep your settings, you can either save the program as described on p.20, or write down the settings on the “Program Sheet” provided at the back of this manual.

Table of Contents

Precautions	ii
Data Handling	iii
Quick Start.....	iv
Introduction	1
Welcome Aboard!	1
Main Features	1
Valve Reactor Technology.....	2
An Overview of ToneLab.....	3
A Guitarist's Guided Panel Tour	5
The Top Panel	5
Rear Panel.....	11
Setup.....	12
Basic Connections	12
Using ToneLab For Direct-Line Recording.....	13
Using ToneLab For Live Performance	14
Using the Optional Foot Controller.....	14
Using ToneLab with a MIDI Device or Computer.....	14
Selecting Programs or Manual Settings (Program Select Mode / Manual Mode)	15
Programs (Program Select Mode)	15
MANUAL MODE: What You See is What You Get!.....	16
Creating and Storing Your Own Program(s) ... & More.....	17
Creating Your own Program(s)	17
Adjusting the Noise Reduction (UTILITY "NR SENS").....	19
Naming a Program (UTILITY "Program Name")	19
Storing a Program.....	20
Restoring a Setting to its Original Value (Original Value)	20
Explanations of the Amp and Effect Types.....	21
A. AMP Models	21
1. AC15.....	23
2. AC15TB	24
3. AC30.....	25
4. AC30TB	25

5. UK BLUES	26
6. UK 68P	26
7. UK '80s	27
8. UK '90s	27
9. UK MODERN (UK MODRN).....	27
10. RECTO	28
11. US HIGAIN (US HI-G)	28
12. BOUTIQUE OD (BTQ OD)	28
13. BOUTIQUE CL (BTQ CL)	28
14. BLACK 2x12 (BLK 2X12).....	29
15. TWEED 1x12 (TWD 1X12)	29
16. TWEED 4x10 (TWD 4X10).....	30
B. CABINET Models	31
1. TWEED 1x12 (TWD 1X12).....	31
2. TWEED 4x10 (TWD 4X10).....	31
3. BLACK 2x10 (BLK 2X10).....	31
4. BLACK 2x12 (BLK 2X12).....	31
5. VOX AC15 (AC15).....	32
6. VOX AC30 (AC30).....	32
7. VOX AD412 (AD412).....	32
8. UK H30 4x12 (UK H30)	32
9. UK T75 4x12 (UK T75)	32
10. US V30 4x12 (US V30).....	32
11. OFF.....	33
WHAT GOES WITH WHAT?	33
C. PEDAL Effects.....	34
1. OFF.....	34
2. COMP	34
3. ACOUSTIC	35
4. VOX WAH.....	35
5. AUTO WAH	35
6. U-VIBE.....	36
7. OCTAVE	36
8. TREBLE BOOST (TREB BST)	36
9. TUBE OD.....	36
10. FAT OD.....	36
11. FUZZ.....	36
D. MOD (Modulation) Effects	37
1. OFF.....	37
2. CHORUS	37
3. FLANGER.....	37
4. PHASER	38
5. TREMOLO	38
6. ROTARY	38
E. DELAY Effects.....	38
1. OFF.....	39
2. DELAY	39
3. TAPE ECHO (T ECHO).....	39
4. MULTI HEAD (MULTI HD).....	39

F. REVERB Effects	40
1. OFF	40
2. SPRING	40
3. ROOM	40
4. PLATE	40
Tuner	41
Tuning Procedure	41
Calibrating the Tuner	41
Using the Optional Foot Controller	42
Expression Pedal Settings (UTILITY “EXP Δ ***” — “EXP INIT”)	42
Control via MIDI	45
Connecting a MIDI Device or Computer	45
Setting the MIDI Channel (GLOBAL “MIDI CH”)	46
Program Change (GLOBAL “PCHG OUT”)	46
Control Change (GLOBAL “CCHG I/O”)	47
Parameter Change (GLOBAL “SYEX OUT”)	48
Backing up and Restoring Program Data (GLOBAL “DUMP CUR,” DUMP ALL”)	48
Adjusting the Digital Output Level (GLOBAL “DOUT LVL”)	50
Restoring the Factory Preset Programs	51
Troubleshooting	52
MIDI Implementation Chart	54
Specifications	56
Program list	57
Index	63
Top/Rear Panel	End of this manual
TOP PANEL	End of this manual
Bank/Manual/Write/Tuner/Channel Section	End of this manual
REAR PANEL	End of this manual
Program Sheet	End of this manual

Introduction

WELCOME ABOARD!

Many thanks for adding the **VOX Valvetronix ToneLab** to your sonic arsenal. We're sure it'll give you countless hours of great guitar tones that will *feel* as good as they sound!

To maximize your chances of enjoying a long and happy relationship with your ToneLab, please read this manual at least once, and (as they say), "use the product as directed." Keep the manual for future reference after you've read it; you'll want to re-read it later at some point to pick up cool tips you may have missed the first time around.

MAIN FEATURES

- ToneLab features Valve Reactor technology that switches between Class A and Class AB power amp circuits with an actual 12AX7 (ECC 83) miniature triode valve (vacuum tube) to create the sound of an actual tube power amp, delivering the response and tone of classic amps.
- ToneLab uses sophisticated modeling technology to create amp, cabinet, and effect sounds. You can choose from sixteen amp types that include classic vintage amps and expensive high-end valve amps, and ten different cabinet types. By combining amp types and cabinet types you can create an amazing range of sounds, some of which have never been heard before.
- Since high-quality effects are built in, ToneLab is all you need to create a completely finished sound. Ten types of pedal effects are placed before the amp. And after the cabinet are placed five types of modulation effects, three types of delay effects, and three types of reverb effects. You can choose one type for each effect plus Noise Reduction, and use them simultaneously.
- You can store all of your own amp settings and effect model settings as a "program" in one of 96 program memories. ToneLab comes with 48 preset programs for instant gratification.
- Manual Mode lets you use ToneLab just like a conventional guitar amp. The sound will be exactly as specified by the physical positions of the amp section knobs. In other words...what you see is what you get!
- For convenient tuning, an Auto Chromatic Tuner is built-in.
- If the optional VOX Valvetronix foot controller is connected, you can use it to switch programs, turn effects on/off, or set the tap tempo for the delay time. Since the foot controller also lets you control the wah and volume pedals, it's a must-have item for live performance.
- ToneLab plays nicely with other equipment – it has a digital output jack and MIDI IN/OUT jacks.

-
- ToneLab Sound Editor is an editor/librarian software that lets you visually edit ToneLab's numerous parameters, and save and manage programs. To obtain the "ToneLab Sound Editor," please contact the VOX distributor in your country or download the latest version from:
"http://www.voxamps.co.uk" or "http://www.valvetronix.com/"
To find your local Distributor go to:
"http://www.voxamps.co.uk/dealers/worldwid.htm"

VALVE REACTOR TECHNOLOGY

THE POWER (AMP) AND THE GLORY!

Valve Reactor technology was first used on the VOX AD60/120VT Valvetronix amps. The Valve Reactor circuitry in ToneLab however has been tuned-up especially for line recording.

Since conventional modeling effects for line recording are not used directly with a speaker, they do not include a power amp circuit, output transformer, or speaker. In other words, they only have a preamp circuit.

A real valve amp sound, however, is produced not just by the preamp, but also by the tone and distortion of the power amp, and by the constant changes in impedance that are created by the power amp driving the speakers. ToneLab contains an actual low-wattage valve power amp circuit, a virtual output transformer (patent applied for) that uses solid-state components to simulate an output transformer, and a dummy speaker circuit that simulates the varying impedance of a real speaker. This means that although it's low-power, ToneLab has the same circuit structure of an actual all-valve amp.

While much of the tone creation and shaping carried out is done in the digital domain, its *Valve Reactor* power amp is 100% analogue. The resulting journey your guitar's signal takes through the analogue world of the power stage plays a major role in providing the all-important feel and tone of the original amps we modelled.

The *Valve Reactor* power stage is, to all intents and purposes, a bona fide valve (tube) push-pull power amplifier, but in miniature. It utilizes a 12AX7 (ECC83) valve (a dual triode device - meaning "two valves in one") and is equipped with an output transformer, just like a "real" valve amp.

The power amp output of ToneLab's Valve Reactor is designed to "read" the constantly changing impedance curve of the dummy speaker circuit system and feed this information back to the virtual output transformer – just like real valve amplifiers do. This information permits the behavior of the valve stage of the amp to vary with the speaker load (impedance), which is another important part of "real world" valve tone.

Apart from the vital valve tone this ingenious power amp design provides, it also allows us to replicate various “circuit characteristics” that are unique to the all-valve power stages of the amps we’ve modelled. These “characteristics” include: Class A or Class AB operation, Presence and Resonance (low end) control circuitry (both found in the negative feedback circuit that some, but not all, valve power amps have) and power output. Being able to match such vital characteristics helps ensure that each and every one of our models is as tonally authentic as possible - as opposed to the usual “close but definitely no cigar” norm of digital modeling. And just so you know, this patented in USA power amp technology is unique to VOX Valvetronix.

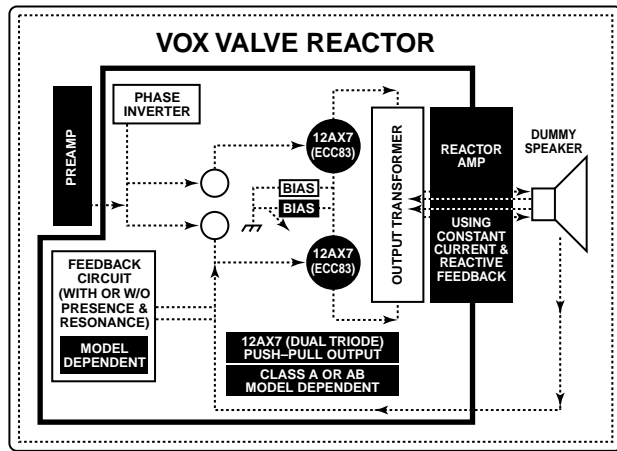

AN OVERVIEW OF ToneLab

Let’s talk about how ToneLab is structured.

SIGNAL ROUTE

When you plug into ToneLab the signal passes through the following stages.

You might want to glance at the explanations in “A Guitarist’s Guided Panel Tour” (p.5) while you read this section.

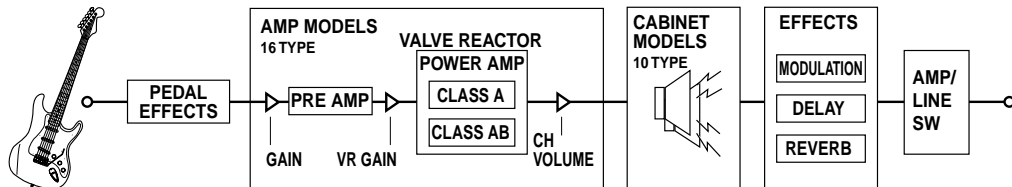

STRUCTURE

You will perform or create sounds using one of ToneLab’s two modes; Program Select mode or Manual mode.

Additional functions are provided by UTILITY and GLOBAL modes (where you can make settings for the optional foot controller and for MIDI), WRITE mode where you can save your original programs, and TUNER mode which lets you tune your guitar. (To access these modes, just press the corresponding button.)

Program Select mode:

- Choose, play, and edit any of the 96 programs.

Manual mode:

- Use ToneLab just like a guitar amp, where the sound will be exactly as the knobs are set. As we said before...what you see is what you get!

UTILITY:

- Adjust the noise reduction (the higher the settings the more noise will be suppressed).
- Name a program.
- Choose the function that will be controlled by the expression pedal of the optional foot controller.

GLOBAL:

- MIDI-related settings.
- Adjust the digital output level.

WRITE:

- Save a program.

TUNER:

- Use the auto chromatic tuner to tune your guitar.

But hey, talk is cheap and ultimately the proof of this particular pudding lies in the way ToneLab sounds and feels when you play it. So, let's cut to the chase and get started. Grab your guitar, turn to "Quick Start" (p.iv), and prepare to experience some great sounds!

A Guitarist's Guided Panel Tour

Here we're going to learn about the knobs, buttons, and jacks on ToneLab's top and rear panel.

To help make this manual as painless to use as possible, we've given it an inside back cover that folds out. And, when you fold it out you'll see nice big pictures of the Top Panel, Rear Panel and more. Why did we do this? So you can have pictures of both panels staring you in the face while you read about 'em - thus avoiding the annoying "flicking between pages" that most manual's require you to do because there's only one picture of a panel and it's never on the same page you're reading! So, fold out that useful back cover and let's go...

THE TOP PANEL

1 AMP SECTION

These control the settings for the amp.

1.1 AMP TYPE Selector

This allows you to select an amp type. The amp type you select will determine the operation of the power amp (Class A or AB), the response of the tone controls, and the wiring of the circuitry, causing the controls to function just as you would expect on the actual amp being modeled. The sixteen stunningly accurate amp models - each of which is based on an accepted all-tube classic - include the legendary VOX AC30TBX. (For details, see p.21.) As already mentioned in the intro to this manual, each model not only replicates the exact gain and tonal characteristics of the original amp's preamp circuit, it also simulates the all-important power amp stage, in terms of both Class (A or AB) and negative feedback circuit (or lack thereof).

1.2 CABINET TYPE Selector

This selects one of ten cabinet models that replicate the shape and size of the cabinet plus the type and number of its speakers. (For details, refer to p.31.)

HINT: Notice that the AMP TYPE, CABINET TYPE, and PEDAL selectors have the instantly recognizable "chicken-head" (pointer) knobs in the true VOX tradition.

Preamp Controls

1.3 GAIN Control

This adjusts the preamp gain of the selected amp model.

1.4 VR GAIN Control

This adjusts the volume from the preamp to the Valve Reactor circuit. This setting will affect the amount of distortion produced by the Valve Reactor. (For details, refer to p.22.)

NOTE: The amount of Valve Reactor distortion is also affected by the GAIN control. With some settings, you'll notice less distortion.

1.5 TREBLE Control

1.6 MIDDLE Control

1.7 BASS Control

This trio of controls allows you to dial-in the exact amount of high, mid, and low frequencies. The manner in which each one of these controls behaves and interacts with the others is dependent on the amp type selected.

NOTE: In keeping with the originals, certain models will produce almost no sound when these three tone controls are turned all the way down (counterclockwise).

NOTE: Not all of the original amps that we modeled have controls for Treble, Middle and Bass. In such cases, rather than simply leaving the non-existent control unem-ployed, we allow you to use all three to effectively increase the tonal range of the original. For more details, see the explanation of each amp type starting on p.21.

Power Amp Controls

1.8 PRESENCE Control

This control allows you to adjust the amount of Presence (high frequency “sparkle”) in your sound.

If the original amp doesn’t have a Presence control, this will have a different function.

NOTE: Presence is a function of a power amp containing a negative feedback circuit, and not all the original amps we modeled contain one – for example, none of the four Vox amps we modeled (AC15, AC15TB, AC30 & AC30TB) feature a negative feedback circuit. Furthermore, not all amps that have a negative feedback circuit necessarily feature a Presence control. For example, the original BLACK 2x12 – negative feedback in the power amp? Yes. Presence Control? Nope. Whenever a modeled amp didn’t have a Presence control, rather than have this knob do absolutely nothing, we used it to control something else. For more details on exactly what the PRESENCE control does on each model, see the explanation of each amp type starting on p.21.

1.9 CH VOLUME Control

This knob allows you to adjust the overall volume of your ToneLab. You can use this to adjust the volume while preserving the tonal character, including the distortion created by the Valve Reactor circuit.

NOTE: Some effect settings may produce unwanted distortion. If this occurs, turn down the CH VOLUME.

2 EFFECTS SECTION

The PEDAL effects are connected in “front” of the amp, and allow you to add one pedal effect to your setup, if you wish. All ten (10) of the effects on offer here are models of classic stompbox effects and, therefore, are meant to be added to your guitar’s signal before it hits the actual amp.

Modulation, delay, and reverb are placed after the cabinet, which is the way it’s done in a studio.

HINT: The reason that modulation, delay, and reverb effects are invariably set up after the amp rather than in front of the amp as a “stompbox” is simple. To most people’s ears, they sound better and more realistic that way. Think about it – REVERB emulates the sound created by a room or a hall. So, logic dictates that if we’re going to add it to our sound, the closer to the end of the signal chain we put it, the more “real” and natural it’s going to sound. The same is true for DELAY and for many MODULATION effects too – their very nature dictates that they should be added near the end of your signal path, not at its beginning.

Also, if you’re using a crunch or high gain lead sound then it makes much more sense to add effects like ROTARY, ROOM (reverb) or DELAY to the signal after it’s been distorted, rather than before. I mean, does it make any sense to add an effect like reverb and then mash the heck out of your signal (i.e., distort it)? Not really...right!? Good, case closed. Now our little detour’s over – let’s get on with the front panel tour...

2.1 Effect Type LEDs

These show the type of effect you are using. (For the PEDAL effect, the LED will be lit unless the selector is set to OFF.) If an LED is dark, that effect is OFF.

2.2 PEDAL Selector

This lets you select one of the ten stompboxes on offer, or bypass the section. When you turn the PEDAL selector, the TYPE button will light, and you can use the three value knobs 1–3 to adjust the parameters. If you don’t want to use a pedal effect, select OFF. (For more information on each of the pedals models here, start on p.34.)

2.3 TYPE Buttons

These select the types of effects. You will also use these to select the effect that value knobs 1–3 will edit.

When you press a button once, it will light; now you can use value knobs 1–3 to edit the parameters of that effect. By pressing an already-lit button once again, you can switch to a different effect type. If you don’t want to use an effect, press the button repeatedly until all of the effect type LEDs for that effect are off.

2.4 TAP Button (HOLD: EFFECT BYPASS)

This button enables you to set the delay time by merely tapping your finger on it at the desired tempo (speed). Hitting the TAP button twice or more will set the delay time. The button will blink at the time interval you tapped in.

If you press and hold the TAP button for one second or longer, the three effects Modulation, Delay, and Reverb will be bypassed. (When bypassed, the effect type LEDs that were lit will blink.)

HINT: To set a precise delay time that matches a song's tempo, tap your finger on the TAP button in time with the song. If it's slightly off, use the Fine Control to match it perfectly.

STEP ON IT! If the optional foot controller is connected, you can set the delay time by tapping your foot.

HINT: To defeat Bypass, press the TAP button once again.

2.5 Value Knobs 1–3

In Program Select mode and Manual mode, these knobs adjust the effect. The knobs will edit the effect you selected by its TYPE button (i.e., the effect whose button is lit). For details on the parameters that these three knobs adjust, refer to p.34 and following. (From the left, these knobs are called value knobs 1–3.)

When you are making UTILITY or GLOBAL settings, you can use value knob 3 to edit the value.

NOTE: For some effect settings, undesired distortion may occur. If this happens, lower the CH VOLUME.

3 BANK/MANUAL/WRITE/TUNER/CHANNEL SECTION

Phew, the “Bank/Manual/Write/Tuner/Channel Section?” What a mouthful! Don't stress though – just because this area houses a few different things doesn't mean it's complicated. In fact, as you're about to discover, it's both logical and simple ... honest! This section is simply where you select and view programs, and see the names and values of the amp and effect section parameters that are creating your sound. This is also where you make UTILITY and GLOBAL settings.

3.1 BANK Display

This displays the program bank.

3.2 BANK/VALUE ▲, ▼ Buttons

In Program Select mode, use these buttons to select one of the eight (8) program banks. When making UTILITY or GLOBAL settings, use these buttons to edit parameters or values.

If you press ▲ and ▼ simultaneously, you will enter Manual mode.

3.3 CHANNEL SELECT/MENU & CURSOR 1/PREV, 2/NEXT, 3/◀, 4/▶ Buttons

In Program Select mode, use these buttons to select a channel within each bank. When making UTILITY or GLOBAL settings, use these buttons to select a menu or parameter.

3.4 UTILITY Button

This lets you assign a name to a program, adjust the Noise Reduction and set up the optional foot controller.

Press the UTILITY button to make the button light, and then use the 1/PREV or 2/NEXT buttons to move through the menu items listed below.

After selecting the desired menu item, use value knob 3 or the ▲, ▼ buttons to change the value.

NR SENS:	Noise reduction	(p.19)
*****:	Program name	(p.19)
EXP Δ:	Expression target	(p.42)
EXP MIN:	Expression target range (minimum value)	(p.42)
EXP MAX:	Expression target range (maximum value)	(p.42)
EXP INIT:	Initialization setting for the expression pedal	(p.42)

3.5 GLOBAL Button

This is where you adjust settings for MIDI or the digital output.

Press the GLOBAL button to make it light, and then use the 1/PREV and 2/NEXT buttons (3.3) to move through the menu items listed below.

After selecting the desired menu item, use value knob 3 or the ▲, ▼ buttons to change the value. For some menu items, you will also use the 3/◀ and 4/▶ buttons.

MIDI CH:	Set the MIDI channel	(p.46)
PCHG OUT:	Output settings for program change messages	(p.46)
CCHG I/O:	Output settings for control change messages	(p.47)
SYEX OUT:	Output settings for system exclusive messages	(p.48)
DUMP CUR:	Sends the current program data from the MIDI OUT jack	(p.48)
DUMP ALL:	Sends all ToneLab data from the MIDI OUT jack	(p.48)
DOUT LVL:	Digital output level	(p.50)

3.6 WRITE/ENTER Button

This button is used when you want to store a new program. (p.20)

3.7 TUNER/CANCEL Button

This button turns the built-in chromatic tuner on/off.

You will also use this to abort saving a program, or to cancel a GLOBAL or UTILITY operation.

3.8 Name Display

This displays program names, effect names, and parameter names.

3.9 Valve Icon

This indicates the number and type of power valves (vacuum tubes used in the power stage) in the original amp that is being modeled.

3.10 Value Display

This indicates the value of the parameter.

If the displayed parameter value matches the value before you edited it (i.e., the value that is stored in the program), the ORIG (original value) icon will appear.

If you have modified (edited) any parameter of the program, the EDIT icon will appear.

4 VALVE

4.1 Valve window

ToneLab contains a 12AX7 (ECC83) valve (vacuum tube).

The valve is a key part of the Valve Reactor power amp.

NOTE: The valve window may break if it is subjected to impact. Be particularly careful not to let it be struck directly, since this may also break the valve itself. If the valve window is broken, have it repaired immediately, since the valve itself may break or other damage may occur if this is not fixed.

5 INPUT/PHONES (The Front Panel)

5.1 INPUT Jack

Connect your guitar to this jack.

5.2 PHONE Jack (stereo)

Connect your headphones here. The rear panel LEVEL knob adjusts the headphone volume.

REAR PANEL

6 POWER SUPPLY

6.1 -AC9V

Connect the included AC/AC power supply here.

6.2 STANDBY Switch

This switches the unit between operating and standby conditions.

7 MIDI

7.1 MIDI OUT Jack

This jack transmits MIDI data to control a connected external MIDI device.

7.2 MIDI IN Jack

This jack receives MIDI data to control ToneLab from a connected external MIDI device.

8 PEDAL

8.1 VOX BUS Jack

For connecting an optional VOX Valvetronix Foot Controller pedal...a must have item, as you'll soon discover!

NOTE: Don't ever connect anything other than a compatible VOX foot controller to this jack!

9 OUTPUT

9.1 AMP/LINE Switch

Set this switch for the device that the OUTPUT jack (or S/P DIF OUT jack) is connected to. You should set this to the "LINE" position if the output jack is connected to a mixer, recording device, if you are using headphones, or if ToneLab is connected to a power amp. Set this to the "AMP" position if ToneLab is connected to a guitar amp.

9.2 OUTPUT Jacks (L/MONO, R)

These are analogue output jacks (balanced/unbalanced TRS). Connect the L/MONO jack if you are running in mono.

9.3 LEVEL Knob

This adjusts the level of the OUTPUT jacks and PHONE jack.

9.4 S/P DIF OUT Jack (Digital Output)

This is an optical-type digital output jack in S/P DIF format (IEC60958, EIAJ CP-1201). It digitally sends the same audio as the OUTPUT jacks at a sampling rate of 44.1 kHz. You can connect it to the input jack of a digital recorder or other digital audio device.

NOTE: The LEVEL knob does not control the digital output level. Refer to "Adjusting the digital output level," p.50.

Setup

NOTE: You MUST turn off the power of all your equipment before you make connections. If you ignore this warning, you may damage your speaker system or experience malfunctions!

BASIC CONNECTIONS

1. Use audio cables to connect the ToneLab's OUTPUT L/MONO (9.2) to your mixer/recorder or guitar amp. (p.13, 14)

NOTE: If you're making connections in mono, use the OUTPUT L/MONO jack. However to take the fullest advantage of ToneLab's sound, we strongly recommend that you use stereo connections.

If you are using headphones, plug them into the PHONES jack (5.2).

NOTE: Signal from the OUTPUT jack will still be heard even if headphones are plugged in.

If you want to use an optical cable to connect ToneLab to a digital mixer or recorder, connect the cable to the S/P DIF OUT jack (9.4). (p.13)

2. If you connect ToneLab to a mixer or recorder, set the AMP/LINE switch (9.1) to "LINE." If you connect it to a guitar amp, set the switch to "AMP."
3. Turn the LEVEL knob (9.3) located on the rear of ToneLab all the way toward the left (as seen from the rear), setting the volume to 0.
4. Connect the included AC/AC power supply to the rear panel AC9V power supply jack (6.1), and then connect the plug to an AC outlet.
5. Plug your guitar into the INPUT jack (5.1).
6. First, turn down the volume of your amp or mixer so you don't hear crackles or pops when the power is turned on! Then turn on the STANDBY switch (6.2) to turn on the power.
7. Adjust the volume by using the controls of your amp or mixer, and ToneLab's rear panel LEVEL knob (9.3).

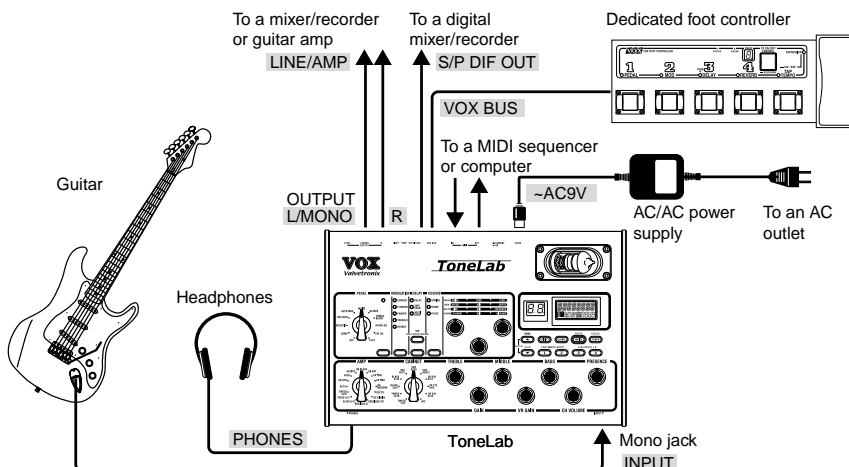

NOTE: Since ToneLab uses an actual valve (vacuum tube), it will produce no sound for several seconds until the valve warms up. This isn't a malfunction – it's just the nature of valves.

USING ToneLab FOR DIRECT-LINE RECORDING

EXAMPLE OF ANALOGUE CONNECTIONS

- When using ToneLab for analogue recording, set the rear panel AMP/LINE switch (9.1) to the "LINE" position, and connect the OUTPUT L/MONO and R jacks (9.2) to the channel input jacks of your mixer or recorder.

HINT: If you're using a mono connection, use the OUTPUT L/MONO jack.

HINT: If you're using stereo connections, pan the input channels of your mixer/recorder to the far left and right respectively.

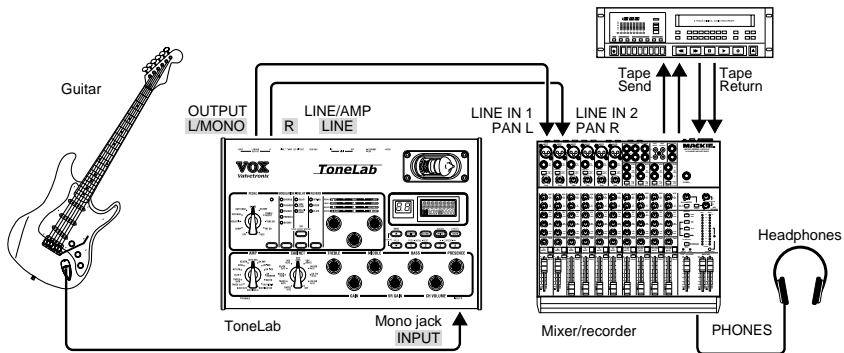

EXAMPLE OF DIGITAL CONNECTIONS

- When using ToneLab for digital recording, set the rear panel AMP/LINE switch (9.1) to the "LINE" position, and connect ToneLab's S/P DIF OUT jack (9.4) to the digital input jack (S/P DIF format IEC60958 EIAJ CP-1201) of your mixer or recorder.

NOTE: The volume of the S/P DIF OUT jack is adjusted by the GLOBAL setting "DOUT LVL." See p.50 for details.

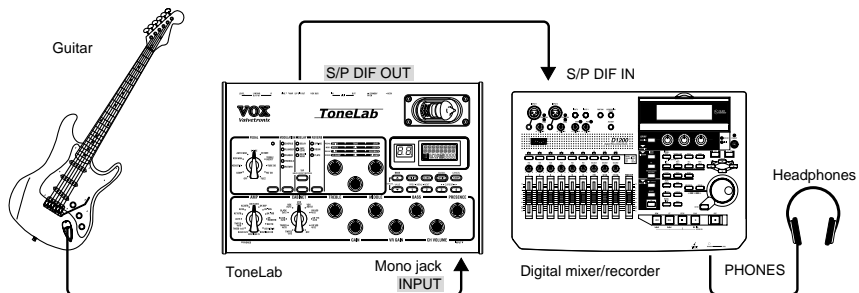

USING ToneLab FOR LIVE PERFORMANCE

EXAMPLE OF CONNECTION TO A GUITAR AMP (Or Amps)

- If you are connecting ToneLab to one or more guitar amps for use in a live performance etc., set the rear panel AMP/LINE switch (9.1) to “AMP,” and connect the OUTPUT L/MONO and R jacks (9.2) to the input jacks of your amp(s).

HINT: If ToneLab is connected to a guitar amp first, set the tone controls to their center positions and adjust them until ToneLab sounds right through your amp. The “AMP” setting on ToneLab has been voiced to sound correct with guitar amps that have a bright switch or a “bright” capacitor across the volume control. Set the rear panel LEVEL knob so that the sound does not distort.(starting with a “clean” program on ToneLab).

HINT: If you are connecting ToneLab to a guitar amp that has a jack allowing you to connect directly before the power amp (such as Return or Main In), set the AMP/ LINE switch to “LINE” and connect ToneLab to that jack. If you want to take advantage of the tonal character of that amp (and cabinet), you may want to turn ToneLab’s CABINET setting “OFF.”

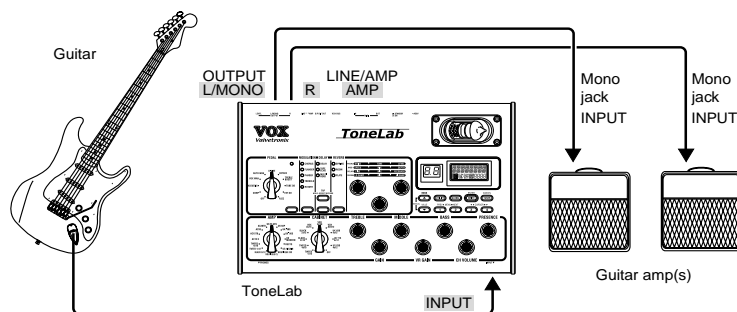

USING THE OPTIONAL FOOT CONTROLLER

The optional VOX foot controller lets you use your foot to switch programs, control the volume, switch effects on/off, and control various values.

- Connect the optional foot controller to ToneLab’s VOX BUS jack (8.1). For details on connections and operation, refer to the owner’s manual included with the controller.
- You’ll need to specify the function that will be controlled by the expression pedal of the controller, and the range in which the value will change. Refer to p.42.

USING ToneLab WITH A MIDI DEVICE OR COMPUTER

By using MIDI you can control ToneLab from a sequencer or control an external MIDI device from ToneLab. You can also save ToneLab programs on a sequencer or MIDI data filer that is able to transmit and receive MIDI exclusive data, and then load the program data back into ToneLab when desired.

HINT: For details on MIDI connections refer to p.45.

Selecting Programs or Manual Settings (Program Select Mode / Manual Mode)

When playing your guitar through ToneLab, you can either select one of the 96 programs, or Manual mode. To learn how to select a program – or Manual mode – read on!

PROGRAMS (Program Select Mode)

ToneLab has 96 programs (24 banks x 4 channels). Every one of these programs can be totally rewritten or “custom tweaked” to your heart’s content. With the factory settings, the channels in banks 1–12 contain a total of 48 preset programs. (Banks 13–24 contain the same preset programs as banks 1–12.)

In order to select programs, you need to be in Program Select Mode.

SELECTING A PROGRAM

As an example, here’s how to select program 2-3 (bank 2, channel 3).

1. Make sure that ToneLab is in Program Select Mode.

If the bank display shows a “” (Manual Mode) or if any of the UTILITY (3.4), GLOBAL (3.5), WRITE (3.6) or TUNER (3.7) buttons are lit, ToneLab is NOT in Program Select Mode. Switch to Program Select Mode as described in “Getting to Program Select Mode” (p.16).

2. Use the BANK ▲, ▼ buttons (3.2) located below the bank display to select bank 2. The bank number will be blinking in the display.
3. Hit the channel 3 select button, and program 2-3 will be instantly recalled.

COOL PLAYING HINT: When you’re halfway through switching programs (i.e. you’ve selected the Bank but not the Channel), the program you’re about to change is still selected and will remain this way until you select the channel. So, if you’re playing live and your next program change requires you to switch to a different bank, you can select that bank ahead of time, ensuring a timely change.

STEP ON IT! If you’ve got the optional foot controller, you can recall a program with your foot.

GETTING TO PROGRAM SELECT MODE

Here's how to get to Program Select Mode. When you enter Program Select Mode, the bank number (1–24) will appear in the bank display (3.1).

If the bank display shows " " (Manual Mode)

This means that ToneLab is in Manual Mode. Do one of the following actions to return to Program Select Mode.

- Press any one of the channel select 1–4 buttons (3.3).
- Simultaneously press the BANK ▲ and ▼ buttons (3.2).

If any of the UTILITY (3.4), GLOBAL (3.5), WRITE (3.6), or TUNER (3.7) buttons are lit or if the bank display is blinking (3.1)

- Press the TUNER/CANCEL button (3.7). You will return to the mode you were previously in.

If Manual Mode is selected, get to Program Select Mode by doing any of the above actions.

MANUAL MODE: What You See is What You Get!

When ToneLab is in MANUAL MODE it behaves like a “regular” amp – meaning that the sound you hear is a direct reflection of all the knob settings of the amp section.

NOTE: Any changes you make in Manual Mode to the effect section and UTILITY parameters (other than “EXP INIT”) will be remembered. The next time you enter Manual Mode, those settings will be recalled.

SWITCHING TO MANUAL MODE

In Manual Mode, the bank display (3.1) shows "  ".

If ToneLab is in Program Select Mode (the bank display shows a number).

- Simultaneously press the BANK ▲ and ▼ buttons (3.2).

If any of the UTILITY (3.4), GLOBAL (3.5), WRITE (3.6), or TUNER (3.7) buttons are lit

- Press the TUNER/CANCEL button (3.7). You will return to the mode you were previously in.

If ToneLab is in Program Select Mode, switch to Manual Mode as described above.

Creating and Storing Your Own Program(s) ... & More

This is a cakewalk, honest! There are two ways you can go about doing this – by “tweaking an existing program” or by “starting from scratch.” Let’s tweak an existing program first.

HINT: When you change the type or parameters in the amp or effect section, the display will show the type name or parameter name, and its value (a). A short time after you make a change, the display will return to the program name (b), but the state of the TYPE buttons and the function of the value knobs will be preserved.

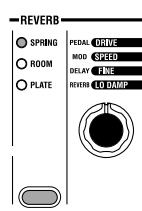

CREATING YOUR OWN PROGRAM(S)

If you want to tweak an existing program, select one that's close to the sound you want, and start by adjusting the GAIN (1.3), TREBLE, MIDDLE, BASS (1.5–1.8), PRESENCE, and VR GAIN (1.4) (which is equivalent to the MASTER control). You can also use TYPE (2.3) to select the effect you want to adjust, and use value knobs 1–3 to adjust the effect.

For example, you might start with a certain preset that has a crunchy, modern rhythm sound that you like, and create a complimentary lead sound that is louder, has a bit more gain, more mids, Chorus and Tape Echo.

Now here's how to create your own program from scratch.

1. Select any program, or choose Manual Mode. (p.15)

HINT: It doesn't matter which program you select, because we're starting from scratch.

2. Set the PEDAL Selector (2.2) to “OFF.” If you want to use a pedal, we'll add it last.
3. Hold down the TAP button (2.4) for at least one second so that MODULATION, DELAY, and REVERB are bypassed. (When bypassed, effect type LEDs that had been lit will blink.)

We'll add modulation and other effects later.

4. Using the AMP TYPE selector (1.1), choose the amp you want to use.

HINT: For details on amp types, cabinet types, and effect types, refer to “Explanations of the Amp and Effect Types” (p.21).

-
- Using the CABINET TYPE selector (1.2), choose the cabinet you want to use.

HINT: For recommended combinations of amp and cabinet types, refer to p.33.

- Adjust the GAIN (1.3), TREBLE, MIDDLE, BASS, PRESENCE (1.5–1.8) and VR GAIN (1.4) to taste. CH VOLUME (1.9) adjusts the volume while preserving the overall character of the distortion produced by the power stage.

HINT: To get the most distortion, raise VR GAIN to a desired level.

- If you want to add modulation, delay, or reverb, press the TAP button (2.4) once again to defeat bypass.

- Now let's try adjusting one of the effects. For example if you want to add tape echo, press the DELAY TYPE button (2.3) to make the "TAPE ECHO" LED (2.1) light.

To set the delay time, press the TAP button (2.4) twice at the desired tempo. Make sure that the DELAY TYPE button is lit. In this state, you can turn the three value knobs 1–3 (2.5) located at the right to make fine adjustments to the time, set the mix amount of the echo sound, and set the amount of feedback for the echo.

You can adjust the MODULATION and REVERB effects in the same way. (However you can't use TAP to make settings.)

NOTE: Some effect settings may cause unwanted distortion. If so, lower the CH VOLUME (1.9).

HINT: If you want to turn modulation, delay, or reverb off individually, simply press its TYPE button (2.3) until the corresponding effect type LED goes dark.

- If you want to use a pedal effect, use the PEDAL selector (2.2) to select the desired effect.

- Make sure that the PEDAL TYPE button (2.3) is lit, and turn value knobs 1–3 (2.5) to make adjustments.

HINT: Since you'll probably find it easier to adjust the pedal effect if modulation, delay, or reverb are not being applied to the sound, press and hold the TAP button (2.4) for at least one second to bypass those effects. When you're finished adjusting the pedal effect, press the TAP button once again to disable bypass.

- When you've got a sound you like, store it!

NOTE: If you switch to a different program (or to manual mode) or turn off the power without saving, your settings will be lost!

HINT: If noise bothers you, you can minimize it by adjusting the noise reduction (p.19). Also, it's a good idea to assign a name to your program so that you can find it later when you want! The name is saved as part of a program's settings.

ADJUSTING THE NOISE REDUCTION (UTILITY "NR SENS")

Here's how you can minimize any noise that might be heard during intervals when you're not playing.

NOTE: When using high Gain settings on amp types such as RECTO or US HIGAIN, NR is highly recommended! Why? Because high gain = noise (hiss)! Just like on the originals!

NOTE: The noise reduction setting is saved as part of each program. If you switch to a different program or to manual mode, or turn off the power without storing, your settings will be lost.

1. Press the UTILITY button (3.4) to make the button light.
2. The name display (3.8) will show "NR SENS" (noise reduction sensitivity). If anything else is selected, press the 1/PREV button (3.3) to make the display show NR SENS.
3. Use value knob 3 (2.5) or the ▲, ▼ buttons (3.2) to adjust the noise reduction setting. The value display (3.10) shows the depth of noise reduction. As the value increases (0.2, 0.4, ..., 10.0), the effect will become stronger. With a setting of "OFF" there will be no noise reduction.

NOTE: Depending on the guitar you are using, raising the noise reduction setting too high may cause the decay of some notes to be cut off.

4. Press the TUNER/CANCEL button (3.7). You will return to the mode you were in.

NAMING A PROGRAM (UTILITY "Program Name")

Here's how you can name a program.

NOTE: The program name is saved as part of each program. If you switch to a different program, to manual mode, or turn off the power without saving, your settings will be lost.

1. Press the UTILITY button (3.4) to make the button light.
2. Press the 1/PREV or 2/NEXT buttons (3.3) to make the name display (3.8) show the program name. The display will change each time you press a button.
3. Use the 3/◀, 4/▶ buttons (3.3) to move the cursor to the character you want to change (the selected character will blink), and use value knob 3 or the ▲, ▼ buttons (3.2) to change the character. You can use the following characters.

!"#\$%&'()*+,-./0123456789-:;=>?@
 ABCDEFGHIJKLMNOPQRSTUVWXYZ[\]^_`

4. Repeat step 3 to finish entering a name for your program.
5. When you have finished entering a name, press the TUNER/CANCEL button (3.7) to return to the mode you were in.

STORING A PROGRAM

When your tweaking has resulted in a sound you're happy with, store it!

1. Press the WRITE button (3.6).
The name display (3.8) shows “*WRITE*,” and the bank display (3.1) and CHANNEL SELECT 1–4 buttons (3.3) will blink.
2. Use value knob 3 (2.5) or the ▲, ▼ buttons (3.2) to select the bank you want to use, and use the CHANNEL SELECT 1–4 buttons (3.3) to select the channel. For example if you want to store your program in 13-1 (bank 13, channel 1), you would use value knob 3 or the ▲, ▼ buttons to make the bank display (3.1) show “13,” and then press CHANNEL SELECT button 1 to make the button blink.
3. Press the WRITE button (3.6) again and you're done!
The display will indicate “COMPLETE.” Your program is now stored, and you'll be back in Program Select Mode.

NOTE: The program is written over the previous contents of that bank/channel location; in other words, the program in the number you selected in step 2 will be erased.

NOTE: If you decide not to store your new program, just hit the TUNER/CANCEL button (3.7) to abort this operation.

NOTE: If you're tweaking your sound in Program Select Mode, your tweaks will be lost if you switch to a different program (or to manual mode) or turn off the power without storing.

If you're tweaking your sound in Manual Mode, and switch to a different program or turn off the power without storing, the settings you made in the effect section and UTILITY parameters (e.g., noise reduction) will remember the values you set last; the next time you enter Manual Mode, these settings will be recalled. The settings of the amp section will reflect the current positions of the selectors and knobs.

RESTORING A SETTING TO ITS ORIGINAL VALUE (Original Value)

The Original Value icon in the value display (3.10) gives you a way to find out the parameter values that are stored in a program.

When you are using a knob or button to change the value of a parameter, the ORIG (Original Value) icon will appear when the value you are adjusting matches the “original value” stored in the program.

HINT: So, you're flipping through the programs on your new ToneLab, and you come across one you really like. It's easy to find out exactly what settings are dialed in to get such an awesome tone – just use this original value display feature!

Explanations of the Amp and Effect Types

This section explains the sixteen amp models, ten cabinet models, ten pedal effects, and five modulation, three delay, and three reverb effects.

A. AMP MODELS

Which amps did we painstakingly model for our seductive selection of 16? Believe me when I say it wasn't easy 'cos, as I'm sure you know, there's a plethora of great sounding amps out there. After countless hours of soul searching, earnest discussions (not to mention the occasional friendly argument!), calls to tone-wise friends (some professional players, some not...but all blessed with great ears) plus, of course, listening and playing, a top 16 list was finally drawn up. As you're about to discover, the ones we went with are not only the cream of the crop but also offer up the widest possible array of the greatest guitar tones known to man - from pristine clean to outrageous overdrive and all points in-between. First though, some stuff you should know...

Controlling Factors

As already touched on in this manual, although the top panel of your ToneLab houses controls for GAIN, VR GAIN, TREBLE, MIDDLE, BASS, PRESENCE and CH VOLUME, not all of the amps we've modelled have as many controls. In such cases, rather than leave you with knobs that do nothing (what on earth would be the point of that!?), we've made full use of all six (6) ToneLab controls *without* compromising the accuracy of any of our models. This means you'll be able to mimic the full tonal spectrum of each and every one of the originals we've modelled...and then some, thanks to the extra flexibility and additional control the six ToneLab controls give you.

For example, if an original amp doesn't have a complete 3 band EQ network then we'll set up the "missing" tone controls on our model to be "neutral" (i.e. as the original) when set it at 12 o'clock - thus giving you extra tonal flexibility in those EQ areas, if you so wish. Just so you know, the amps we modelled that don't have individual controls for Treble, Middle and Bass are:

AMP	ORIGINAL TONE CONTROLS
AC15	Top Cut & Bass Cut Switch
AC15TB	Treble & Bass
AC30	Top Cut only
AC30TB	Treble, Bass and Cut
TWEED 1x12	Just one, called Tone!

Also, as you'd probably expect, we do the same exact thing with the ToneLab's PRESENCE control too - namely, if one isn't present (bad pun, not intended!)

on the original then PRESENCE will be an added control on our model. This time though, the “neutral” position is when the control is all the way off (turned fully counterclockwise). The two models this applies to are BLACK 2x12 and TWEED 1x12.

IMPORTANT NOTE: As you’ll discover when you read their descriptions, in the case of the AC15, AC15TB, AC30 and AC30TB models, we’ve utilized the PRESENCE control to mimic the TOP CUT control - whether it was present on the original or not.

About the Gain and Volume knobs

Your ToneLab is equipped with 3 programmable Gain or Volume type controls – GAIN, VR GAIN and CHANNEL VOLUME. These controls do specific jobs, and how these are set up, with each different model, will make dramatic differences to your sound. As some of you will know, most vintage amps only have one VOLUME control to set up the sound, whilst more modern amps usually have two types of level controls – GAIN (or sometimes PREAMP VOLUME) that controls the input level of the preamp section, and MASTER VOLUME that controls how much signal is (and how loud it is going to be) passed from the preamp to the power amp. With many vintage amps there is no MASTER VOLUME, the preamp feeds directly into the power amp without any type of control.

The ToneLab’s controls are designed to cover all these points:

ToneLab GAIN: On vintage type models that do not have a master volume (i.e., AC15, AC15TB, AC30, AC30TB, UK BLUES, UK 68P, BLACK 2x12, TWEED 1x12, TWEED 4x10), the GAIN control works like the VOLUME of the original amp. On other model amps that do have a master volume, the GAIN control works like GAIN or PREAMP VOLUME.

ToneLab VR GAIN: MASTER VOLUME that controls how much preamp signal level is passed to the power amp, which in our case is the VALVE REACTOR stage. (Your ToneLab works like a real amp.)

ToneLab CH VOLUME: For want of a better way of putting it, this is like a power attenuator that you would add between the output of your amp and the input of your speaker cabinet. This controls the level of the final mix and allows you to balance all your programmed amp sounds to each other.

As in how the original amps work, we have made the relationship between preamp and power amp work in the same way. Therefore to obtain truly authentic tones please use the VR GAIN control in the same way, i.e. with VINTAGE type models that do not have Master Volume control’s, turn the VR GAIN control up to maximum. With modern Master type amp models, use the VR GAIN as you would the Master Volume on the original – at low settings you will hear more of a preamp type distortion, on higher settings you will hear the preamp start to push the Valve Reactor to clip and add its own distortion and warmth.

Lastly, if an original amp features a unique switch or control we make sure that we cover it! Such things will be revealed in the model descriptions that follow shortly...

Tube Talk

Us Brits call 'em valves while our US cousins call 'em tubes...as the saying goes: England and America are merely two countries divided by a common language! Anyway, call 'em what you will, these wondrous glass bottles lie at the tonal heart of each of our 16 models. As all the amps we've modelled hail from one of the two countries just mentioned, in honour of their heritage, the descriptions of all English amps will employ the words "valve" and "valves," while the American ones will be tubular!

QUESTION: What's the difference between an ECC83 preamp valve and a 12AX7 preamp tube?

ANSWER: Nothing! They're the same exact thing – namely the most popular preamp tube in ampland. ECC83 is the British name, 12AX7 (a.k.a. 7025) is the American. See, I told you we were two countries divided by a common language!

Power Amp Accuracy

What happens in the power stage of any good tube amp is of *paramount importance* to the way the amp sounds, feels and behaves. The way the power amp operates (Class A or Class AB), the power tubes used (EL84s, EL34s, 6L6s, 6V6s), the exact nature of the negative feedback loop circuitry (if one even exists) and how the power stage interacts (a relationship called damping) with the speaker(s) it is driving - all these things play a vital role in the creation of *tone*. That is why we have fitted your ToneLab with our patented **Valve Reactor Technology** – a modelling breakthrough that is unique to VOX and infuses our critically acclaimed Valvetronix range of amps with life and feel. This revolutionary technology emulates a tube power-amp by using real tubes in a real tube amp circuit and ensures that all the important bases inherent in a tube amp are faithfully and accurately covered. For example: if you choose amp model AC30TB - an amp with a Class A power stage, EL84 output tubes and no negative feedback, that's exactly what your *Valve Reactor* power amp reconfigures itself to be.

This all said, let's take a look at each of our amp models...

1. AC15

This is modelled on Channel 2 of an amazing sounding 1962 VOX AC15, which is part of our vast amp collection. This 1x12", 15 Watt, valve driven, dual channel combo was unleashed on the market in 1958 and was the first ever VOX amplifier. The reason for it being named the AC15 is simple: AC stands for Amplifier Combination, while 15 indicates the Wattage. Thanks to its compactness, power, built in tremolo/vibrato effects (on Channel 1 only) and tremendous tone, this combo was a huge hit with the popular British guitar bands of the time, including several chart topping acts, the majority of whom were only too happy to endorse Vox.

One of the biggest reasons for the unique, signature tone of this amp is the fact that it employs EL84 output valves in a Class A circuit with no negative feedback. This is also true of the other three VOX amps, we've modelled - the AC15TB,

AC30 and AC30TB. In a nutshell, the result of this design is more power and more distortion - the latter of which gets thick with second and third order harmonics that become more and more prevalent as the amp is cranked. Thanks to our unique *Valve Reactor Technology* the power stage of your ToneLab is automatically switched to its "EL84s in a Class A circuit with no feedback" emulation whenever AC15, or any of the other three Vox models, is chosen.

Like most amps of its era, the AC15 is the very essence of simplicity. In fact, the Channel we modelled, Channel 2 (remember!?), only has three controls - Volume, Brilliance (really a bass cut) and Top Cut. When you select AC15, the ToneLab's GAIN control mimics the original's Volume control, while the PRESENCE control acts as the Top Cut.* FYI, the AC15's Top Cut control affects the high frequencies in a very different way than a "regular" Treble control. Deft use of it will help you dial in the exact amount of that instantly recognizable, world-famous VOX "sparkle." The BASS control acts as the Bass Cut (Originally labelled Brilliance) with total variability instead of the Original two position switch.

As for what the "extra" TREBLE and MIDDLE controls on our AC15 model do: as already mentioned earlier, they're exactly that - "extra!" Set them at 12 o'clock and they're "neutral" (i.e. they mimic the exact tone of the original) or tweak them for extra tonal flexibility.

***CONTROL NOTE:** The original AC15's Top Cut control works in the opposite way you'd expect - it "cuts" when you turn it up! You'll be glad to read that our model of the Top Cut control (the PRESENCE knob) works in a much more logical fashion - turn it up for more "sparkle," turn it down for less.

Original's valve compliment: 1 x EF86, 3 x ECC83s, 1 x ECC82 in the preamp, 1 x EZ81 rectifier, 2 x EL84s in the power amp.

2. AC15TB

While the AC15 was born in the late '50s, the AC15TB is a modern-day child of the '90s which combines the sweet "n" desirable tonal characteristics of the AC15's low Wattage power stage, with the increased tonal flexibility that the Top Boost (TB) channel of an AC30 has to offer. Then, to sweeten the pot even further, a 12" Celestion "Blue" speaker (what else?), Reverb and a Master Volume control were thrown in too. The result is a highly flexible 15 Watt, all-valve, 1x12 combo that successfully marries the pureness of great vintage VOX tone with modern features.

The original has two tone controls - Treble and Bass. So, as is the norm, the ToneLab's TREBLE and BASS controls mimic their namesakes while the MIDDLE ("neutral" at 12 o'clock) and PRESENCE add further tonal flexibility...should you want it. To ensure maximum "Voxiness," we've made sure that the PRESENCE control behaves exactly like the "Top Cut" on the original AC15 - except in reverse ("off" = cut) to make it more logical, just like on our AC15 model.

In trademark VOX fashion, our AC15TBX model oozes clean tones that "jangle" and "chime," while its overdrives are smooth yet pulsating with desirable harmonic overtones. Enjoy!

Original's valve compliment: 5 x ECC83s in the preamp, 1 x 5Y3GT rectifier, 2 x EL84s in the power amp.

3. AC30

As already stated, the VOX AC15 was a huge hit with the British guitar bands of the late '50s. However, as the popularity of the AC15 using bands grew, so did their need for a more powerful amp. Sure, the AC15 was loud for a 15 Watt amp - darned loud in fact - but it was no match for 1,000 + screaming fans! Remember folks, back in the late '50s/early '60s, guitar amps weren't being fed through the PA - that was reserved purely for vocals, the band's back-line had to do the rest. Clearly VOX needed to come up with a louder amp and the company was only too happy to rise to the challenge...

The fruit of VOX's labour was unveiled to the world in 1959 - the 30 Watt, 2x12, AC30. Several top British bands graduated up to the AC30 instantly and, within months, one of them had scored a number one single with a stirring guitar instrumental. Not surprisingly, pretty much every other UK act worth its salt immediately followed suit and the AC30 became the amp behind the so-called "Beat Boom" of the time. More importantly, it also became *the* driving force behind the now legendary "British Invasion" - the name given to the huge wave of success that several English bands enjoyed in America during the '60s. This charge was led by a quartet hailing from Liverpool who quickly became VOX's most famous ambassadors ever.

We've modelled the sterling sounds of the AC30's Normal channel as they definitely encapsulate those classic tones that defined the aforementioned British invasion. Just like its smaller brother, the AC15, the AC30's Normal channel boasts the bare minimum of knobs - Volume and Top Cut (modelled by GAIN and PRESENCE* respectively).

***CONTROL NOTE:** Once again, our PRESENCE control models the "Top Cut" on the original AC30 exactly - except in reverse ("off" = cut) to make it more logical, just like on our AC15 model.

Original's valve compliment: 4 x ECC83s, 1 x ECC82 in the preamp, 1 x GZ34 rectifier, 4 x EL84s in the power amp.

4. AC30TB

Even though the AC30 was a runaway success, several artists expressed a desire for the amp to have more tonal flexibility and a pinch of extra gain too. VOX reacted quickly and came up with some clever extra tone circuitry that featured an additional ECC83 valve and was called "Top Boost."* When "Top Boost" was added to an AC30 it increased the gain of the combo's Brilliant channel, and added two extra EQ controls, giving the amp three tone controls - Treble, Bass and Cut. To say it was an instant hit with the guitar playing public would be a gross understatement! In fact, its gutsy tone became an instantly recognisable signature sound of many major groups in the mid '60s.

NERDY HISTORICAL NOTE: VOX initially called this their "Brilliance Unit" but it quickly became known as "Top Boost." When Top Boost was first introduced it was only available as a retrofit assembly. Even though this modification was not particularly difficult to add, it was beyond most folk (hey, I don't know about you, but messing around with electricity is hardly my idea of fun!). Consequently, in 1964, Top Boost was fitted to the AC30 as standard.

Once again, the PRESENCE control of our model acts as the original's Cut (but in reverse: "off" = cut) while the GAIN, TREBLE and BASS mimic the original's Volume, Treble and Bass controls. The MIDDLE is an "extra" with 12 o'clock being its "neutral" position.

Our AC30TB model produces clean sounds that are rich and jangly with a smooth yet detailed top end, and overdrives that have a glorious, throaty bark - just like those classic, "Class A" tones that have made the original a "must have" in any serious player's amp collection.

Original's valve compliment: 5 x ECC83s & 1 x ECC82 in the preamp, 1 x GZ34 rectifier, 4 x EL84s in the power amp.

5. UK BLUES

Our UK BLUES model is based on the "High Treble" channel of an extremely rare, hand-wired head made in jolly old England in the early '60s. Although the TWEED 4x10 circuit was used as a basic template for this amp, several fundamental changes (e.g. different tubes, different transformers, a higher output impedance and vastly different speakers in a closed-back cab), give UK BLUES its own unique and highly desirable character. Indeed, when cranked-up this 30 Watt baby produces a crunch that forever changed the sound of rock "n" roll - which is why it is still highly revered to this very day.

Original's valve compliment: 3 x ECC83s in the preamp, 1 x GZ34 rectifier, 2 x KT66s in the power amp.

6. UK 68P

This is based on the "High Treble" channel of a 1968, 50 Watt, all-valve head, boasting a Plexiglas front panel and four (4) inputs. The no-nonsense original doesn't feature a Master Volume control so the best and, arguably, only way to set it up is to max out the volume and let rip! And, that's exactly what everyone did - and still does!

This amp was chosen because the tone was incredibly rich and warm, instant classic heaven! As this amp has no master volume facility, the only, and greatest, way of using it to its full potential was to wind the volume up to maximum. In real life this was pretty darn loud. Fortunately the ToneLab gives you full control in the quiet of your own studio.

To achieve the same response as the original, remember to turn the VR Gain control to maximum. The ToneLab works EXACTLY like the original. This goes for all non-master type amp models.

So, wind the GAIN control all the way up and immerse yourself in an instantly recognizable, organic overdrive that responds beautifully to the subtle dynamics of your playing and dominates "classic rock." Rolling back your guitar's volume control results in a unique and highly useable clean sound.

Original's valve compliment: 3 x ECC83s in the preamp, 2 x EL34s in the power amp.

7. UK '80s

This is modelled on a 1983, all tube, single channel 100 Watt head that boasts a Master Volume control - a wonderful feature that allows the user to dial in a decent crunch tone without having to max out the amp's volume. Invariably played with it's (preamp) Gain control cranked to the max, this amp was responsible for the fat, roaring sound that dominated '80s hard rock and heavy metal. Yes sir, from span-dex clad Europeans who rocked like hurricanes, to American speed freaks who rode the lightning and reigned in blood, UK '80s was the *only* amp of choice...and, for many, still is!

Although UK '80s became famous for it's distinctive, cranium-crushing crunch, it isn't merely a "one trick pony" and neither is our model - just like the original, when you roll back your guitar's volume knob you'll get a bright, clean sound that's perfect for chord work and will cut through any mix like a hot knife through butter.

Original's valve compliment: 3 x ECC83s in the preamp, 4 x EL34s in the power amp.

8. UK '90s

This model is based on the "lead" channel of a 100 Watt, dual channel head that is capable of so much preamp distortion it houses a Gain control that goes all the way up to a Nigel Tufnel approved "20, dunnit!" This amp replaced UK '80s and was developed to satisfy the ever-evolving rock guitarists' insatiable lust for more gain, features and flexibility. Was this amp popular? Judging by the fact it quickly became the "industry standard" for the decade in question, the answer is a resounding "yes!"

Original's valve compliment: 4 x ECC83s in the preamp, 4 x EL34s in the power amp.

9. UK MODERN (UK MODRN)

This is modelled on the High Gain channel of a modern, all-tube 100 Watter that is effectively a hybrid of the UK '80s and UK '90s amps. It combines the toneful high gain preamp stage and modern features of UK '90s with the unmistakable, "snarling" punch and girth the UK '80s power stage had to offer. The result is a highly aggressive, tone-breathing monster capable of mondo-gain while retaining individual note definition. With the GAIN control on full, UK MODERN allows lead lines to soar into soulful feedback, while its low-end "chunk" remains tight and punchy. Wimps beware!

Original's valve compliment: 4 x ECC83s in the preamp, 4 x EL34s in the power amp.

10. RECTO

This bad boy is based on the “Modern High Gain” channel of a brutal, 100 Watt, armour-plated beast hailing from California. Its deep, dark, loose low-end, some what “fizzy” top and Monster-like gain has made this all-tuber a mainstay for many modern, metal acts who either tune their guitars down as low as they can possibly go, or wield 7-string axes.

At low GAIN settings, RECTO produces a distinctive, bright clean sound bolstered by some rich, upper harmonics that add fullness and dimension. This said, RECTO is definitely not recommended for Country “n” Western picking. But, if you play slamming, “nu-metal” that’s tuned lower than whale droppings, then RECTO could well be the only way to go!

Original’s tube compliment: 5 x 12AX7s in the preamp, 2 x 5U4G rectifier tubes, 4 x 6L6s in the power amp.

11. US HIGAIN (US HI-G)

This is modelled on the Overdrive Channel of an all-tube, 100 Watt head built in 1991 and covered in snakeskin! This high gain, power house was designed by a guy who also builds and drives Hot Rod cars so it should come as no surprise that the originals controls all go to eleven - after all, “that’s one louder innit!” (© Nigel Tufnell!)

US HIGAIN is capable of a powerful, heavily saturated sound that combines an open low-end with compressed mids and highs. The result is a tone that remains focused and well defined at even the most extreme gain settings. These attributes have made this head a favourite with several of the world’s leading players, and its versatility make it ideal for a wide variety of purposes and styles.

Original’s tube compliment: 4 x 12AX7s in the preamp, 4 x 6L6s in the power amp.

12. BOUTIQUE OD (BTQ OD)

For this one we modelled the Overdrive channel of a very rare, very expensive and very respected 100 Watt head named the Overdrive Special. This custom-order, hand-wired beauty has a spectacular overdriven sound that’s perfect for sax-like, legato soloing. With its GAIN control wide-open, BOUTIQUE OD produces a stunning sustain which is very smooth and very soulful - can you say “woman tone!?”

Original’s tube compliment: 3 x 12AX7s in the preamp, 4 x EL34s in the power amp.

13. BOUTIQUE CL (BTQ CL)

For this amp type, we modelled the Clean channel of another very expensive, hand-wired, custom amp made by the same boutique builder as BOUTIQUE OD. We auditioned several top-shelf boutique amps for this model but this amp was the clear winner. Even though its garish, fuzzy red covering wasn’t to everyone’s taste, it’s beautiful clean sound was! Its beautifully rounded low-end, delightfully transient mid-range attack and sweet treble make it the perfect partner for single-coil pick-

ups. It is also incredibly responsive and extremely sensitive to picking styles and pickup selection. And, as an added bonus, strummed chords just ring out and blossom.

Original's tube compliment: 3 x 12AX7s in the preamp, 4 x 6L6s in the power amp.

14. BLACK 2x12 (BLK 2X12)

The dual channel, blackfaced beauty we modelled here is considered a "must-have" 2x12 combo for country and blues players, and rightfully so - after all, its celebrated clean sound is very tight "n" twangy, with a deep, taut, piano-like bass.

Pristine clean tones aside, BLACK 2x12 is also capable of producing that classic Chicago blues tone - especially with single coil pickups. In keeping with the original, when pushed hard the bass on our model tends to crumble. So, to emulate this classic, BLACK 2x12 overdrive, here's what you dial in on your ToneLab: full GAIN and VR GAIN, not much BASS, full MIDDLE and set TREBLE to taste. Because the EQ network of BLACK 2x12 lies before the main gain stage of its preamp y'see, pushing the mids in this way emphasizes the distortion in that frequency range and the result is a lovely, singing blues tone.

As already mentioned elsewhere, the original amp doesn't have a Presence control but does have a **Bright Switch**. The PRESENCE control on your ToneLab emulates this switch when "off" and "on," plus all points in-between!

Original's tube compliment: 4 x 12AX7s & 2 x 12AT7 (a.k.a. ECC81) in the preamp, 4 x 6L6s in the power amp.

TONAL HINT: BLACK 2x12 is the perfect partner for ACOUSTIC (Acoustic Guitar Simulator) in the Pedal section.

15. TWEED 1x12 (TWD 1X12)

The original we modelled here was born in Fullerton, California, in 1958, and clad in "tweed" - hence its name! Just like the AC15, this 18 Watt, 1x12, all-tube combo is the very essence of simplicity. Aside from the obligatory Volume knob, it only housed one other knob - a single Tone control creatively named (wait for it!) Tone! This Tone control is merely a treble cut and boost, and its behaviour can be mimicked by using the Valvetronix's TREBLE, MIDDLE and BASS EQ network as follows:

Original Tone control turned all the way down (off) = BASS on full; TREBLE and MIDDLE at 9 o'clock (PRESENCE "off").

Original Tone control turned up "full" (on 10) = TREBLE on full; MIDDLE and BASS at 9 o'clock (PRESENCE "off").

NOTE: As the original doesn't have a Presence control, PRESENCE is "neutral" when "off," but can be used to add "extra" sparkle and cut to the model if you so wish.

In keeping with the original, the TWEED 1x12 produces an open, relatively uncoloured sound when clean, but starts to "snarl" beautifully when pushed into overdrive. Its highly desirable "snarl" is rich with harmonic content and cranking this

puppy up will produce those classic, old rockabilly and rock “n” roll sounds of the '50s and '60s, at the drop of a 10 gallon hat - especially when a single coil pickup is used.

Original's tube compliment: 1 x 12AY7, 1 x 12AX7s in the preamp, 1 x 5Y3GT rectifier, 2 x 6V6s in the power amp.

16. TWEED 4x10 (TWD 4X10)

The 4x10 combo we modelled here was built in 1959 and originally intended for bass guitar. This said, six-stringers were quick to embrace its smooth-yet-cutting overdrive which is perfect for R&B (rhythm “n” blues) guitar. TWEED 4x10 is also very sensitive and responsive to both picking strength and the volume setting on your guitar. This means that by backing-off your axe's volume when the amp is cranked, you can produce a beautifully clean and full tone. It also means that dynamic picking control allows you to make notes or chords more distorted or clean than others, depending on how hard or how soft you pick 'em.

Another cool tonal quirk of TWEED 4x10 is the classic, vintage tube amp sag its GZ34 rectifier tube adds to your notes whenever the amp is driven really hard. “What is sag?” Do I hear you ask? Well, crank the Gain and VR GAIN controls on this model, dig in hard with your pick and you'll soon find out! Can you hear how the note literally “sags” when you first hit it and then it opens up? That's sag, geddit?

TONAL NOTE: Just like on the original, the Middle and Treble control of TWEED 4x10 are highly interactive and high settings of the Middle control automatically add treble to your sound. As a result, you may want to turn down the Treble control as a counter measure. Conversely, low Middle settings reduce treble so you might want to crank the Treble a little more in such instances.

Original's tube compliment: 1 x 12AY7, 2 x 12AX7s in the preamp, 1x GZ34 rectifier, 2 x 5881s in the power amp.

B. CABINET MODELS

Now let's look at the CABINET models:

CABINET AND SPEAKER ACCURACY

There's not much point in having incredibly accurate amp models if the speaker cabinet models on offer aren't of the same exacting standards. As you may know, in real life, the output stage of a tube amp works in close harmony with the varying impedance curve of the speaker(s) it is driving. This intimate and vital relationship plays a major role in producing the warm, punchy sound and pleasing feel that we all know and love. In a nutshell, modelling a speaker cabinet is not just a case of frequency response, but is a combination of frequency response, transient response (how a speaker reacts to the strength of how a note is played), and the all-important interaction of the amps output to the speaker's impedance curve. In addition, other vitally important factors that have to be taken into account when modelling a cabinet are the actual physical dimensions of the enclosure (cabinet), the unique tonality of said enclosure (which will be affected by both the type and thickness of the wood it is made of) and whether it boasts an open, semi-open or closed-back design. Special circuitry and unique modelling technology ensures that all of these factors are well taken care of in the cabinet models built into your ToneLab.

Amp/Effect

1. TWEED 1x12 (TWD 1X12)

This speaker is the other half of our Tweed 1x12 Amp model. As the name suggests it is a single 12" speaker, uses an Alnico magnet and made in the USA by one of the US's revered names in vintage loudspeakers.

CABINET
TYPE

2. TWEED 4x10 (TWD 4X10)

Keeping with the US made Alnico magnet speakers, this cabinet partnered our TWEED 4x10 modelled amp. It is an open backed cab using four 10" 8 Ohm speakers, wired in parallel for a total of 2 Ohms impedance. Although originally intended for bass guitar, this speaker rocks for many different styles.

3. BLACK 2x10 (BLK 2X10)

Although we did not model the amp that goes exactly with this cabinet, we loved the tone of this mid-60s Fullerton, California made open backed 2x10" ceramic magnet (of US origin) 35 Watt combo. So here it is. Great for blues, jazz and country. As with all cabinet models it can be mixed and matched with any amp model to produce some interesting tonal combinations. But for some recommended uses, please see the following charts.

4. BLACK 2x12 (BLK 2X12)

As you've probably guessed by now, this speaker system accompanied the amp that was modelled for the BLACK 2x12 amp. Featuring two 12" Ceramic magnet speakers, again made in USA in the mid '60s. They are 8 Ohm units wired in parallel for a 4 Ohm total load. These speakers have been featured on countless

recordings of many styles of music, but very predominantly Country and Blues based Rock.

5. VOX AC15 (AC15)

This is a 1x12" open backed combo using the famed VOX Blue Alnico speaker, manufactured by Celestion in Ipswich, England. The one we used was a modern re-issue that was housed in the VOX AC15TB combo. This speaker, which is 8 Ohms impedance, 15 Watts power handling, is amazingly full-bodied for a 1x12 open back cab, and, of course, helps bring the famous VOX chime to the forefront.

6. VOX AC30 (AC30)

Obviously, double the power – double the speakers. 2x12" VOX Blue Alnicos, wired in series for 16 Ohms, adds even more of that great VOX tone. This time we modelled some great sounding originals from way back in the '60s. As speakers get old their tone changes, so this configuration adds a different slant on how these speakers sound.

7. VOX AD412 (AD412)

This cabinet is one of VOX's latest products, and due to the fact we are extremely proud of it, and that it is without a doubt an exceedingly great sounding cabinet, we just had to include it with our cabinet models. The cabinet itself features custom designed Celestion speakers using Neodymium magnets, one of the first, if not the first, cabinet to use this technology. It also uses some special cabinet acoustic design technology that is also a first for VOX and 4x12s in general. Use it as a valid tonal option with any model, but especially the amp head models. We think you will like it!

8. UK H30 4x12 (UK H30)

This is an older, heavy-duty cabinet (with 30 Watt speakers, from the late '60s) made by the same famous UK amp company as the UK T75 4x12. Many of these cabinets have been used on countless classic rock recordings throughout the past. Now you can get that great tone direct to tape.

9. UK T75 4x12 (UK T75)

This 4x12" model is of a famous, UK built, black box loaded with modern, 75 Watt British speakers. Normally seen stacked, this is probably the biggest selling guitar cabinet ever and is eminently suitable for most rock styles. How could we not model it?!

10. US V30 4x12 (US V30)

This black beast of a cabinet hails from the same home in California as our RECTO amp. It uses four UK made "Vintage" named speakers.

It is renowned for its deep bass and high-end detail and is extremely popular amongst today's "nu-metal" exponents. We think you know what we mean!

11. OFF

OK, this not a cabinet. The OFF position turns off the cabinet modelling area of the ToneLab, and allows the direct amp models to be sent directly to the outputs. When would you use this? When you are connecting directly to a guitar system (guitar amp input or power amp/speaker cab system).

WHAT GOES WITH WHAT?

Basically, with your ToneLab you can mix any amp model to any cabinet model, and create many varied tones. But to give you a starting point, here is a listing of historically correct matches:

AMP MODEL	HISTORICALLY CORRECT CABINET MODEL
TWEED 1x12	TWEED 1x12
TWEED 4x10	TWEED 4x10
BLACK 2X12	BLACK 2x12
AC15	VOX AC15
AC15TB	VOX AC15
AC30	VOX AC30
AC30TB	VOX AC30
UK BLUES	UK H30
UK 68P	UK H30
UK 80's	UK T75
UK 90's	UK T75
UK MODERN	UK T75 or US V30
US HiGAIN	US V30 or UK T75
RECTO	US V30
BOUTIQUE OD	UK H30 is a good choice
BOUTIQUE CLN	UK H30 is a good choice

Please Note! The VOX AD412 is so new that there is no historical connection with any of the modelled amps (yet! as of March 2003).

SOME RECOMMENDATIONS

As some of the manufacturers of the original amps that we modelled also used similar amps with different speaker configurations to make other models, so can you with your ToneLab to approximate these other amps. For instance:

Amp Model	Cabinet Model	Equivalent Model
BLACK 2x12	BLACK 2x10	Blackface Vibrolux type combo
BLACK 2x12	TWEED 4x10	Blackface Super type combo
TWEED 1x12	BLACK 2x10	Tweed Super
UK BLUES	VOX AC30	Early BluesBreaker type combo
VOX AC15	VOX AC30	VOX AC15 Supertwin

Please note that these amps will be approximations only as original power ratings, output transformers and speaker manufacturer and types, might have been different in the original products.

Due to the flexibility of your ToneLab, mixing and matching all of the amp and cabinet models can be done with the turn of a switch, without any risk of blowing the speakers up. Something that cannot be done in real life (unfortunately!). This capability can lead to some very interesting combinations, some useful, perhaps some not, but only you can decide what is useful to you, as your tone requirements are unique. Please feel free to explore all combinations of amps and cabinets. That is the beauty of ToneLab.

NOTE: Product names appearing in this manual are trademarks of their respective owners, which are not associated or affiliated with VOX in any way. Names and descriptions of these products are provided only for the purpose of identifying specific products that were studied by VOX in the course of developing this product.

C. PEDAL EFFECTS

The pedal effects are placed in front of the amp.

PEDAL	DRIVE: knob 1	TONE: knob 2	LEVEL: knob 3
COMP	"SENS" 1.0...10.0	"ATTACK" 1.0...10.0	"LEVEL" 0.0...10.0
ACOUSTIC	"BASS" 0.0...10.0	"BODY" 1.0...10.0	"TREBLE" 0.0...10.0
VOX WAH	"CLOSE" 1.0...10.0	"PEDAL" 0.0...10.0	"OPEN" 1.0...10.0
AUTO WAH	"SENS" 0.0...10.0	"ATTACK" 1.0...10.0	"POLARITY" uP, dn
U-VIBE	"SPEED" 1.00...10.00	"MIX" 0.0...10.0	"DEPTH" 0.0...10.0
OCTAVE	"1OCTAVE" 0.0...10.0	"DIRECT" 0.0...10.0	"2OCTAVE" 0.0...10.0
TREBLE BOOST	"DRIVE" 1.0...10.0	"TONE" 1.0...10.0	"LEVEL" 0.0...10.0
TUBE OD	"DRIVE" 1.0...10.0	"TONE" 1.0...10.0	"LEVEL" 0.0...10.0
FAT OD	"DRIVE" 1.0...10.0	"TONE" 1.0...10.0	"LEVEL" 0.0...10.0
FUZZ	"DRIVE" 1.0...10.0	"TONE" 1.0...10.0	"LEVEL" 0.0...10.0

1. OFF

Select this when you don't want to use a PEDAL effect.

2. COMP

Gotta play a clean passage that needs to be nice, smooth and even? Need a hair more sustain on a lead line? Then, look no further; COMP is the pedal for you. Modelled on a compressor pedal that is hugely popular due to the percussive clean sound it can produce - making it perfect for '80s and '90s pop and funk rhythm work. It can also add a singing, mellow sustain to lead lines - clean or dirty.

- [1] "SENS" 1.0...10.0 Adjusts the sensitivity of the compressor (i.e. when its "smoothing" effect kicks in). The amount of compression/sustain will increase the more you turn this control up.
- [2] "ATTACK" 1.0...10.0 Adjusts the strength of the attack.
- [3] "LEVEL" 0.0...10.0 Adjusts the output level.

3. ACOUSTIC

Wanna go “unplugged” without the hassle of switching guitars and amps? Enter the acoustic guitar simulator - a clever effect that magically converts an electric guitar’s sound into that of an acoustic. It works best with a single coil (read: low output) pickup in the neck position, especially when paired with the BLACK 2x12 amp model.

- [1] “BASS” 0.0...10.0 Adjusts the bass.
- [2] “BODY” 1.0...10.0 Adjusts the body resonance. You’ll need to adjust the BASS along with this parameter to keep a balance.
- [3] “TREBLE” 0.0...10.0 Adjusts the treble.

4. VOX WAH

This effect is modelled on the legendary VOX Wah pedal, the V847. Thanks to its unique “throaty” tone, the V847 is the only Wah pedal many professionals will consider stepping on. When used wisely, this pedal can either make your guitar cry like a baby or howl like a man possessed!

- [1] “CLOSE” 1.0...10.0 Adjusts the tone when the wah pedal is closed.
- [2] “PEDAL” 0.0...10.0 Mimics the “sweep” of the wah pedal — from open to closed.
- [3] “OPEN” 1.0...10.0 Adjusts the tone when the wah pedal is open.

USEFUL TONE HINT: A great tonal trick that’s employed by many guitarists, including some who are household names, is to find a “sweet spot” within the range of their Wah pedal and then leave it there. This is often called *stuck-Wah* (imagine that!) and, when used tastefully, can be very effective as it produces a very distinctive sound that will cut through any mix. You can dial in a stuck-Wah “sweet spot” with your TONE control in a heartbeat. Try it, it’s cool...

STEP ON IT! Yet another reason to buy the optional foot controller! Yep, you’ve guessed it — you can use the pedal of the foot controller to control VOX WAH.

5. AUTO WAH

The lazy man’s Wah pedal! Only kidding...this quirky but useful effect allows you to create an automatic “Wah” effect that varies with your picking dynamics (i.e. how hard or soft you hit the strings).

- [1] “SENS” 0.0...10.0 Adjusts the sensitivity of the effect.
- [2] “ATTACK” 1.0...10.0 Adjusts the Auto Wah’s response speed.
- [3] “POLARITY” uP(UP), dn(DOWN) Sets the direction in which the auto wah will operate.

6. U-VIBE

Modelled on the famous Univox Uni-Vibe - a phase/vibrato effect that was designed to simulate a rotating speaker and produces a wonderfully seductive and “watery” tone. Interestingly enough, the guy responsible for this great pedal is also responsible for the birth of the remarkable *Valve Reactor Technology* used in the power amp of your ToneLab.

- [1] “SPEED” 1.00...10.00 [Hz] Adjusts the speed of the Uni-Vibe effect.
- [2] “MIX” 0.0...10.0 Adjusts the mixture of direct sound and vibrato.
- [3] “DEPTH” 0.0...10.0 Adjusts the depth of the Uni-Vibe effect.

STEP ON IT! With the pedal of the optional foot selector (you’ve bought one by now, right!?) you can control the speed of the vibrato.

7. OCTAVE

This effect generates a note one octave lower than the one you’re playing, adding thickness and “weight” to single note lines.

- [1] “1OCTAVE” 0.0...10.0 Adjusts the mix level of the note one octave below.
- [2] “DIRECT” 0.0...10.0 Adjusts the level of the original note.
- [3] “2OCTAVE” 0.0...10.0 Adjusts the mix level of the note two octaves below.

WARNING! Like all pedals of this type, OCTAVE *only* works with single notes...chords confuse the heck out of it! NOT a fault - that’s just the way these pedals are...deal with it, dude!

8. TREBLE BOOST (TREB BST)

This pedal effect is modelled after a treble booster that was designed with the VOX AC30 specifically in mind. It is a great way of adding “teeth” to an overdriven sound.

9. TUBE OD

This model is based on an overdrive pedal that’s housed in a garish, “seasick green” box and is considered an all-time classic due to the wonderfully warm tones it produces.

10. FAT OD

Based on a pedal named after one of the most disliked rodents to ever walk the planet! The result is a smooth distortion rich in harmonics...nasty but nice.

11. FUZZ

Retro, rude “n” raw...get the picture!?! The name says it all.

- [1] “DRIVE” 1.0...10.0 Adjusts the amount of distortion (boost).
- [2] “TONE” 1.0...10.0 Adjusts the tone.
- [3] “LEVEL” 0.0...10.0 Adjusts the output level.

D. MOD (Modulation) EFFECTS

This section enables you to add a modulation effect after the cabinet. You can choose one of the five types of modulation effects. Here you can also assign external control over the SPEED control.

- (EX): This indicates a parameter that you can control from the expression pedal of the optional foot controller.
- (*): This indicates a parameter that you can set when using the Sound Editor. These parameters cannot be edited when using ToneLab alone.

MOD	SPEED: knob 1	MIX: knob 2	DEPTH: knob 3
CHORUS	"SPEED" 0.100...10.00	"MIX" 0.0...10.0	"DEPTH" 0.0...10.0
FLANGER	"SPEED" 0.100...10.00	"RESO" 0.0...10.0	"DEPTH" 0.0...10.0
PHASER	"SPEED" 0.100...10.00	"RESO" 0.0...10.0	"DEPTH" 0.0...10.0
TREMOLO	"SPEED" 1.00...10.00	"SPREAD" 0.0...10.0	"DEPTH" 0.0...10.0
ROTARY	"SPEED" 0.80...10.00	"TIME" 1.0...10.0	"DEPTH" 0.0...10.0

1. OFF

Select this if you don't want to use a MOD effect.

2. CHORUS

This models the rich sound of a standard analog chorus unit — in full stereo!

- [1] "SPEED" 0.100...10.00 [Hz](EX) Adjusts the modulation speed.
- [2] "MIX" 0.0...10.0 Adjusts the mix amount of the effect sound.
- [3] "DEPTH" 0.0...10.0 Adjusts the modulation depth.
- (*) MANUAL 1.0...10.0 Adjusts the center frequency of the sweep.

3. FLANGER

A model of a truly classic analogue Flanger that "unchained" a highly influential modern guitarist who many hail as the "godfather of two handed tapping."

- [1] "SPEED" 0.100...10.00 [Hz] Adjusts the modulation speed.
- [2] "RESO(RESONANCE)" 0.0...10.0 Adjusts the amount of resonance.
- [3] "DEPTH" 0.0...10.0 Adjusts the modulation depth.
- (*) MANUAL 1.0...10.0 (EX) Adjusts the center frequency of the sweep.
When using the foot controller to control this, it is effective to set DEPTH to 0. If DEPTH is set to 10, MANUAL will not function — just like on the original flanger.
- (*) MIX 0.0...10.0 Adjusts the mix amount of the effect sound.

4. PHASER

A model of a much respected and popular analogue phaser, housed in a banana yellow box!

- [1] "SPEED" 0.100...10.00 [Hz](EX) Adjusts the modulation speed.
- [2] "RESO(RESONANCE)" 0.0...10.0 Adjusts the amount of resonance.
- [3] "DEPTH" 0.0...10.0 Adjusts the modulation depth.
- (*) MANUAL 1.0...10.0 Adjusts the center frequency of the sweep.

5. TREMOLO

This effect is based on the highly acclaimed tremolo circuit found in a BLACK 2x12.

The SPREAD setting lets you create panning effects that are spread to left and right.

- [1] "SPEED" 1.00...10.00 [Hz](EX) Adjusts the tremolo speed.
- [2] "SPREAD" 0.0...10.0 Adjusts the left/right spaciousness.
- [3] "DEPTH" 0.0...10.0 Adjusts the tremolo depth.

6. ROTARY

This models a stereo rotary speaker.

When you adjust the SPEED control of the ROTARY effect (either via the front panel or the optional foot controller) the effect takes awhile to reach the specified speed - just like a real rotating speaker. Why? Because, in the real world, it takes a second or two for the motor controlling the speaker rotation to speed up or slow down! (You can use TIME to adjust the length of this transition.)

- [1] "SPEED" 0.80...10.00 [Hz](EX) Adjusts the rotational speed of the speaker.
- [2] "TIME" 1.0...10.0 Adjusts the time required for the rotational speed to change.
- [3] "DEPTH" 0.0...10.0 Adjusts the modulation depth.

E. DELAY EFFECTS

Here you can make settings for a delay effect inserted after the cabinet. You can choose one of three (3) distinctly different delay effects. In all three cases, the maximum delay time possible is two seconds.

(EX): This indicates a parameter that you can control from the expression pedal of the optional foot controller.

(*): This indicates a parameter that you can set when using the Sound Editor. These parameters cannot be edited when using ToneLab alone.

DELAY	FINE: knob 1	MIX: knob 2	FEEDBACK: knob 3
DELAY/TAPE ECHO/MULTI HEAD	"TIME" 0...2000 [ms]	"MIX" 0.0...10	"FEEDBACK" 0.0...10

1. OFF

Select this if you don't want to use the delay effect.

2. DELAY

When this high quality digital delay effect is employed, the tone of each repeat is so good it is indistinguishable from the original note(s).

3. TAPE ECHO (T ECHO)

This is an incredibly accurate model of one of the most respected analogue tape echo machines ever made. In the original the "echo" is produced by a playback head and the exact "delay time" is set by varying the motor speed. Many professionals prefer these "lo-fi" units because of the warm, dark echoes they produce.

4. MULTI HEAD (MULTI HD)

This is a model of a tape echo unit boasting three playback heads. Here we use two out of the three for a classic sound. Furthermore, each of the two resulting "echoes" (one from each head) has its own feedback loop. The result? A complex and warm "multi-tap" echo effect.

- [1] "TIME" 0...2000 Makes a fine adjustment in a range of -64...+63[ms] relative to the current delay time.
- [2] "MIX" 0.0...10.0 Adjusts the mix amount of the delayed sound.
- [3] "FEEDBACK" 0.0...10.0 Adjusts the amount of feedback.

WARNING! WARNING! If you crank up the FEEDBACK knob too much, an uncontrollable, cascading "runaway" of echoes will occur. So, use your ears and your common sense when setting this!

TAP 0...2000 Sets the delay time. Press the TAP button twice at the desired interval.

(*) TONE 1.0...10.0 (TAPE ECHO/MULTI HEAD) Adjusts the tone of the delay.

(*) MODE 1, 2, 3, 4, 5 (MULTI HEAD) Specifies the combination of heads that will be used.

1: Conventional echo.

2:  The delayed sound produces a rhythm of "ta-ta-ta (rest)."

3:  The delayed sound produces a rhythm of "ta (rest) ta-ta."

4:  The delayed sound produces a rhythm of "ta-ta (rest) ta."

5:  The delayed sound produces a rhythm of "ta-ta-ta-ta."

INPUT LEVEL: (EX) This is the input level of the delay controlled by the optional foot controller.

F. REVERB EFFECTS

Here you can make settings for the reverb effect that is played after the cabinet. You can choose one of three types of reverb.

(EX): This indicates a parameter that you can control from the expression pedal of the optional foot controller.

REVERB	LO DAMP: knob 1	MIX: knob 2	HI DAMP: knob 3
SPRING/ROOM/PLATE	"LO DAMP" 0.0...10.0	"MIX" 0.0...10.0	"HI DAMP" 0.0...10.0

1. OFF

Select this if you don't want to use the reverb effect.

2. SPRING

A model of the most popular spring reverb system used in guitar amps.

3. ROOM

Emulates the natural reverberation that takes place in a medium sized room/small hall.

4. PLATE

An unerringly accurate model of the plate reverb used in countless, professional recording studios.

- [1] "LO DAMP" 0.0...10.0 Adjusts the dampening of the low-frequency range.
 - [2] "MIX" 0.0...10.0 Adjusts the mix amount of the reverb sound.
 - [3] "HI DAMP" 0.0...10.0 Adjusts the dampening of the high-frequency range.
- INPUT LEVEL (EX) This is the input level of the reverb controlled by the optional foot controller.

Tuner

For your convenience, ToneLab houses a built-in auto chromatic tuner that can be calibrated between 438 Hz and 445 Hz.

TUNING PROCEDURE

1. Simply press the TUNER button (3.7) and the auto chromatic tuner will be activated.
2. When you play a note on your guitar, the nearest pitch and a tuning meter will appear in the name display (3.8).

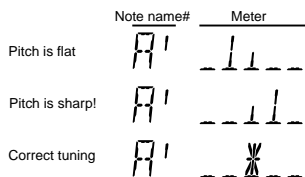

The note names are displayed as follows.

C	C#	D	D#	E	F	F#	G	G#	A	A#	B
C	C'	D	D'	E	F	F'	G	G'	A	A'	B

3. Watch the meter, and tune your guitar.
4. When you're finished tuning, press the TUNER button once again to return to the mode you were in.

STEP ON IT! If the optional foot controller is connected, you can use it to activate the tuner. In this case you'll be able to tune with the output muted (Silent Tuning Mode). If you're using silent tuning mode, defeating the tuner function will simultaneously defeat muting, and your sound will once again be heard. ToneLab's tuner function will be defeated when you press any button other than the TAP button, or operate the PEDAL selector.

CALIBRATING THE TUNER

The built-in tuner is automatically calibrated to A = 440 Hz (a.k.a. "concert pitch") every time you switch ToneLab on. If desired, you can recalibrate the tuner in the range of A = 438Hz to A = 445Hz. Here is how you do it:

- While the Tuner is active, the value display (3.10) shows the frequency of the reference pitch. Use value knob 3 (2.5) to set the desired frequency.

IMPORTANT NOTE: When you turn on the amp's power, the tuner automatically calibrates itself to A = 440Hz. So, if you've recalibrated the tuner please remember that your recalibration will be "lost" as soon as you switch the amp off.

Using the Optional Foot Controller

The optional VOX Valvetronix foot controller lets you control the following functions.

- Select programs using foot switches
- Control the volume using the volume pedal
- Control effect parameters using the expression pedal
- Turn individual effects on/off using foot switches
- Activate the tuner from a foot switch
- Set the delay time using a foot switch (Tap)

NOTE: For details on connecting and using the foot controller, refer to the owner's manual for your foot controller.

NOTE: When using the foot controller to switch programs, you are limited to four adjacent banks, as follows.

ToneLab	VC-4
1-1-4-4	1-1-4-4
5-1-8-4	1.-1-4.-4
9-1-12-4	1-1-4-4
13-1-16-4	1.-1-4.-4
17-1-20-4	1-1-4-4
21-1-24-4	1.-1-4.-4

← From the VC-4 you can select within the range enclosed by each frame (16 programs)

HINT: You can operate the foot controller to simultaneously control another MIDI device. For details, refer to "Control via MIDI" (p.45).

EXPRESSION PEDAL SETTINGS (UTILITY "EXP ∆ ***" — "EXP INIT")

In order to use the expression pedal of the optional foot controller to control ToneLab, you need to make settings in ToneLab to specify which effect will be controlled, and how it will be controlled. You can make the following settings.

- "EXP ∆ ***" Expression target (the effect that will be controlled)
"EXP MIN" Expression target range (minimum value)
"EXP MAX" Expression target range (maximum value)
"EXP INIT" Expression pedal control value initialization setting

NOTE: When you change the setting of "EXP INIT," the new setting is stored automatically. Settings other than "EXP INIT" are made individually for each program. These settings will be lost if you switch to another program or switch to Manual Mode without saving.

1. Press the UTILITY button (3.4) to make the button light.
2. Press the 1/PREV or 2/NEXT button (3.3) to make the name display (3.8) read "EXP _***". The parameter will change each time you press a button.
3. Use value knob 3 (2.5) or the ▲, ▼ buttons (3.2) to specify the target.
"EXP _***" selects the expression target (i.e., the effect that will be controlled). The parameter that will be controlled will depend on the effect you select.

Expression target		Type	Parameter that is controlled
"EXP _---	Control nothing	-----	-----
"EXP _PDL"	PEDAL effect	VOX WAH	"PEDAL" parameter of VOX WAH
		U-VIBE	"SPEED" parameter of U-VIBE
"EXP _MOD"	MODULATION effect	Other than FLANGER	"SPEED" parameter
		FLANGER	"MANUAL" parameter
"EXP _DLY"	DELAY effect	All types	Input level to DELAY effect
"EXP _REV"	REVERB effect	All types	Input level to REVERB effect

HINT: If you set the PEDAL effect type to "VOX WAH" or "U-VIBE," the expression target will automatically be set to "EXP _PDL." In this case if you set the PEDAL effect back to another type without performing any other operation, the target setting will also automatically return to its previous setting.

NOTE: If the target effect is OFF, nothing will be controlled. In the case of the PEDAL effect, nothing will be controlled except for "VOX WAH" or "U-VIBE."

4. To set the minimum (MIN) value for the foot controller, press the 2/NEXT button (3.3) to make the name display (3.8) show "EXP MIN."
5. Use value knob 3 (2.5) or the ▲, ▼ buttons (3.2) to specify the minimum value of the target range.

This determines the range in which the target parameter will vary when you operate the expression pedal. "EXP MIN" sets the lower limit, and "EXP MAX" sets the upper limit.

When you operate the expression pedal, the target parameter will change within the range that you specify here.

6. To set the maximum (MAX) value for the foot controller, set "EXP MAX" as described in steps 4 and 5.
7. To set the initialization (INIT) value for the foot controller, press the 2/NEXT button (3.3) to make the name display (3.8) show "EXP INIT."

-
8. Use value knob 3 (2.5) or the ▲, ▼ buttons (3.2) to specify how the expression pedal control value will be initialized.

“EXP INIT” specifies whether the control data (pedal position) of the expression pedal will be maintained when you switch programs.

If this is “OFF,” the parameter selected as the expression target will immediately change to the current position of the pedal at the moment you switch programs.

If this is “On,” and you switch programs, the newly-selected program will sound just as it did when it was saved (i.e., the control data will be initialized).

NOTE: The “EXP INIT” setting is not saved for individual programs; it applies to all of the programs.

NOTE: Even if this is “OFF,” the target parameter will not change if the expression pedal has not been operated even once since the power was turned on.

9. Press the TUNER/CANCEL button (3.7) to return to the mode you were in.

Control via MIDI

MIDI stands for Musical Instrument Digital Interface, and is a world-wide standard for exchanging various types of musical data between electronic musical instruments and computers. When MIDI cables are used to connect two or more MIDI devices, performance data can be exchanged between the devices, even if they were made by different manufacturers.

ToneLab can use MIDI to communicate in the following ways with another MIDI device. You can:

- Operate ToneLab or a connected optional foot controller to switch programs on an external MIDI device, or switch ToneLab programs from an external MIDI device. →“Program change”
- Operate a connected optional foot controller to control an external MIDI device, or use an external MIDI device to control ToneLab’s volume or effects. →“Parameter change”
- Use Sound Editor to edit parameters. →“Parameter change”
- Backup (save) and restore (load) ToneLab program data. →“Backing up and restoring program data”

NOTE: In order to do the above things, you need to use a MIDI cable to connect ToneLab and your external MIDI device, and set the MIDI channels appropriately. →“Connecting a MIDI device or computer,” “Setting the MIDI channel”

NOTE: When you change the settings described in this section, they will be saved automatically. When you have finished making settings, simply press the TUNER/ CANCEL button (3.7) to return to the mode you were in.

NOTE: If your external MIDI device does not recognize certain types of MIDI message, those messages cannot be used for control. Check the “MIDI implementation chart” of ToneLab and of your external MIDI device.

CONNECTING A MIDI DEVICE OR COMPUTER

If you want to use a connected foot controller to control an external MIDI device from ToneLab, connect a MIDI cable from ToneLab’s MIDI OUT jack to the MIDI IN jack of your external MIDI device.

If you want to control ToneLab from a MIDI sequencer or other external MIDI device, connect a MIDI cable from your external MIDI device’s MIDI OUT jack to ToneLab’s MIDI IN jack.

When you connect ToneLab with a MIDI sequencer or sound editor, data will normally be sent in both directions, so you will need to connect MIDI cables from ToneLab’s MIDI OUT jack to the external MIDI device’s MIDI IN jack, and from the external MIDI device’s MIDI OUT jack to ToneLab’s MIDI IN jack.

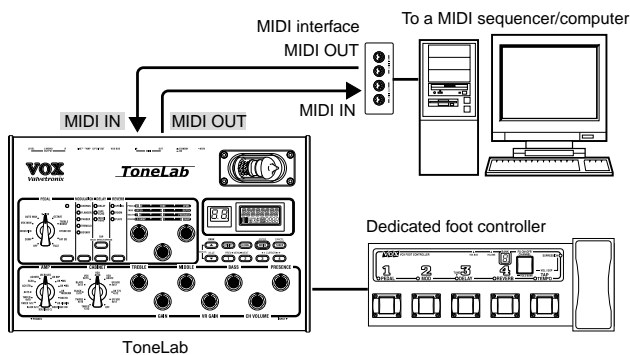

NOTE: You will need a MIDI interface in order to connect your computer with ToneLab.
Some USB-MIDI interface devices may not be able to transmit/receive the ToneLab's MIDI exclusive messages.

SETTING THE MIDI CHANNEL (GLOBAL "MIDI CH")

In order to exchange data with an external MIDI device, ToneLab's MIDI channel must match the MIDI channel of your external MIDI device. Here's how to set the MIDI channel.

1. Press the GLOBAL button (3.5) to make the button light.
2. The name display (3.8) will show "MIDI CH." If a different parameter is selected, press the 1/PREV or 2/NEXT button (3.3) to change the display.
3. Use the value knob 3 (2.5) or the ▲, ▼ buttons (3.2) to set ToneLab's MIDI channel.
4. Set the MIDI channel of your connected external MIDI device.
For details on how to set the MIDI channel of your external MIDI device, refer to its owner's manual.

PROGRAM CHANGE (GLOBAL "PCHG OUT")

When you switch programs on ToneLab or on a connected foot controller, a program change message is transmitted from the MIDI OUT jack, causing an external MIDI device to switch programs. Similarly, when ToneLab receives a program change message, its program will switch automatically. Here's how you can specify whether a program change message will be transmitted from the MIDI OUT jack when you switch programs on ToneLab or on a connected foot controller.

NOTE: Program change numbers not used by ToneLab will be ignored. For details on the range of program change numbers used by ToneLab, refer to "MIDI Implementation Chart" (p.54).

NOTE: When ToneLab is in Manual Mode, it will ignore program change messages; programs will not be switched. In Program Select Mode, program changes are always received.

1. Press the GLOBAL button (3.5) to make the button light.

-
2. Press the 1/PREV or 2/NEXT button (3.3) to make the name display (3.8) show "PCHG OUT."
 3. Specify whether program change messages will be transmitted. Use value knob 3 (2.5) or the ▲, ▼ buttons (3.2) to make the desired setting.
"OFF": Program change messages will not be transmitted.
"On": Program change messages will be transmitted.

CONTROL CHANGE (GLOBAL "CCHG I/O")

When you operate the EXPRESSION pedal, VOLUME pedal, or TAP switch of an optional foot controller connected to ToneLab, control change messages will be transmitted. This means that functions for the corresponding control change numbers on an external MIDI device can be controlled in realtime.

Similarly, when ToneLab receives control change messages from an external MIDI device, it will be controlled in the same way as if its own foot controller were operated.

For a list of the functions that can be controlled from an external MIDI device, refer to step 4.

Here you can specify whether ToneLab will transmit and receive control change messages.

1. Press the GLOBAL button (3.5) to make the button light.
2. Press the 1/PREV or 2/NEXT button (3.3) to make the name display (3.8) read "CCHG I/O."
3. Specify whether all control change messages will be transmitted or received. Use value knob 3 (2.5) or the ▲, ▼ buttons (3.2) to make your choice.
"On" allows transmitting and receiving. "OFF" disables transmitting and receiving.

NOTE: If this setting is "OFF," no control change messages will be transmitted or received even if you specify individual control change numbers in step 4.

4. Use the 3/◀ or 4/▶ buttons to select the controller for which you want to transmit or receive settings. The controllers will be selected in the following order.

"EXP PDL": EXPRESSION pedal control

"VOL PDL": VOLUME pedal control

"TAP SW": TAP switch on/off

"PEDAL FX": PEDAL effect on/off

"MOD FX": MODULATION effect on/off

"DELAY FX": DELAY effect on/off

"REVRB FX": REVERB effect on/off

5. For each controller, specify whether ToneLab will transmit and receive control change messages. If you want ToneLab to transmit and receive messages for a controller, specify the control change number. Select a controller, and use value knob 3 (2.5) or the ▲, ▼ buttons (3.2) to make the desired setting.

"OFF": Control change messages will not be transmitted or received.

“CC00”–“CC95”: When you operate a controller, messages of the specified control change number 00–95 will be transmitted. Similarly, ToneLab will be controlled when it receives messages of the same control change number from an external MIDI device.

PARAMETER CHANGE (GLOBAL “SYEX OUT”)

When you operate ToneLab’s knobs or buttons to edit the value of a parameter, system exclusive such as parameter changes are transmitted.

If you want ToneLab’s parameters to be transmitted to an external device, turn the “SYEX OUT” setting “On.” Normally, you will turn “SYEX OUT” on when using the Sound Editor.

This setting specifies whether ToneLab will transmit parameter changes.

1. Press the GLOBAL button (3.5) to make the button light.
2. Press the 1/PREV or 2/NEXT button (3.3) to make the name display (3.8) read “SYEX OUT.”
3. Specify whether parameter change messages will be transmitted. Use value knob 3 (2.5) or the ▲, ▼ buttons (3.2) to make your choice.

“OFF”: Parameter change messages will not be transmitted.

“On”: Parameter change messages will be transmitted.

NOTE: When ToneLab receives parameter changes or other system exclusive messages, its parameters, modes, or program numbers will change — regardless of the “SYEX OUT” setting.

BACKING UP AND RESTORING PROGRAM DATA (GLOBAL “DUMP CUR,” DUMP ALL”)

All of ToneLab’s data (including its programs) can be transmitted and received in the form of system exclusive messages. Exchanging this type of data with an external device via system exclusive messages is known as a “data dump.” By performing a data dump, ToneLab programs you created can be backed up (saved) on an external device such as a MIDI data filer or a sequencer that is able to transmit and receive system exclusive messages. Then when necessary, you can retransmit that data back to ToneLab to restore it. This provides a way for you to organize large numbers of programs. You can also use this method to copy program data between two connected ToneLabs.

You can transfer program data in one of two ways; one program at a time, or all programs at once. When you transmit all programs at once, all of ToneLab’s data will also be transmitted, including Manual Mode settings and MIDI settings.

NOTE: You can transmit data dumps regardless of the “SYEX OUT” setting. In fact, if you want to transfer program data between two ToneLabs, we recommend that you turn the “SYEX OUT” setting “OFF.” If “SYEX OUT” is “On,” operating the knobs or other controls may change the parameters of the other ToneLab in unintended ways.

BACKING UP

1. Connect ToneLab's MIDI OUT to the MIDI IN of the device that will receive the data dump.
2. If you want to transmit only one program, use Program Select Mode to select the program you want to transmit. If you want to transmit the Manual Mode settings, select Manual Mode.
3. Press the GLOBAL button (3.5) to make the button light.
4. Press the 1/PREV or 2/NEXT switch (3.3) to make the name display (3.8) read "DUMP CUR" or "DUMP ALL."

"DUMP CUR" (Dump current program data): The data of the currently selected program will be dumped. If you are editing the program (and have not yet saved it), the current settings will be transmitted.

"DUMP ALL" (Dump all data): All of the ToneLab's data will be dumped.

5. Put the receiving device in a state in which it can record the data dump.

NOTE: For details, refer to the owner's manual of the device that will receive the data dump.

6. Press ToneLab's WRITE/ENTER button (3.6) to begin transmission. When transmission is completed, the display will indicate "COMPLETE," and you will return to the screen of step 4. (While "DUMP ALL" is being transmitted, the display will indicate "SEND.")

NOTE: While data is being transmitted, do not touch the buttons or knobs of ToneLab or its foot controller, and never turn off the power.

RESTORING

1. Connect the transmitting device's MIDI OUT to ToneLab's MIDI IN.
2. Set the transmitting MIDI device and ToneLab to the same MIDI channel. If ToneLab will be receiving data that was previously transmitted to the external MIDI device, select the same MIDI channel as was used when transmitting.
3. Transmit the data dump from the external device.
While ToneLab is receiving all data, its display will indicate "RECEIVE." When reception has been successfully completed, it will indicate "COMPLETE." If an error occurs, the display will indicate "ERROR"; in this case, try transmitting the data again.

NOTE: For details, refer to the owner's manual of the device that will be transmitting the data dump.

NOTE: While data is being received, do not touch the buttons or knobs of ToneLab or its foot controller, and never turn off the power.

4. If ToneLab received data for just one program in Program Select Mode, select the store-destination bank and channel, and store the program. (p.20)

NOTE: The program data will not be written into ToneLab's program memory unless you store it.

If you received data in Manual Mode, settings other than for the amp section will be overwritten automatically, so you don't need to store the settings yourself. (Since

the settings of the amp section are determined by the physical positions of the selectors and controllers, they will not change.)

HINT: If ToneLab received all data, all data other than the amp section settings of Manual Mode will be overwritten automatically. However if the data was received in Program Select Mode, the data being edited (i.e., the edit buffer) will not be changed.

Adjusting the Digital Output Level (GLOBAL "DOUT LVL")

Here's how to adjust the output volume of the DIGITAL OUT jack.

1. Press the GLOBAL button (3.5) to make the button light.
2. Press the 1/PREV or 2/NEXT button (3.3) to make the name display (3.8) read "DOUT LVL."
3. Adjust the digital output level from the DIGITAL OUT jack in a range of "-12"–"12" (dB). "0" is the normal level. Use value knob 3 (2.5) or the ▲, ▼ buttons (3.2) to make the desired setting.

NOTE: If you raise the level above "0" (dB), the digital output may distort for some programs.

NOTE: The setting you change here is remembered automatically. When you have finished making the setting, press the TUNER/CANCEL button (3.7) to return to the mode you were in.

Restoring the Factory Preset Programs

Here's how you can restore ToneLab's programs and all its other settings to the state in which it was shipped from the factory.

NOTE: This operation will permanently erase all the programs you've written or tweaked yourself. MIDI settings and settings you made in Manual Mode will also be erased. If there are any settings you want to keep, use Data Dump to back them up, or use a copy of the "Program Sheet" foldout at the end of this manual to make a note of your settings.

1. While holding down the three buttons ▲, ▼ (3.2), and TUNER/CANCEL (3.7), press the STANDBY button to turn on the power. The bank display (3.1) "P" and the CHANNEL SELECT 1–4 buttons (3.3) will blink, and the name display (3.8) will ask "RELOAD?" Release the three buttons you were holding down.
2. If at this point you decide that you really don't want to execute this operation, you can press the TUNER/CANCEL button.
3. Press the WRITE/ENTER button (3.6). The name display (3.8) will show "LOADING," and the factory-set data will begin being reloaded. When reloading has been completed, the name display will indicate "COMPLETE," and ToneLab will automatically switch to Program Select Mode.

NOTE: Never turn off the power while this reload operation is occurring.

Troubleshooting

If you suspect a malfunction, please check the following points first. If this does not resolve the problem, contact a nearby dealer.

1. The amp isn't powering up when the STANDBY switch is "on"

- Is the AC/AC power supply connected to the rear panel ~AC9V jack?
- Is the AC/AC power supply plugged into an AC outlet?
- Is the STANDBY switched on?
- Could the AC/AC power supply be damaged?

2. There's no sound

- Is your guitar turned up?
- Are both ends of your guitar cable plugged into the correct jacks?
- Is your guitar cable working?
- Could the rear panel OUTPUT LEVEL knob be turned down?
- Using the ORIGINAL VALUE LED, check the settings of the GAIN, TREBLE, MIDDLE, BASS, VR VOLUME and CH VOLUME (on certain AMP TYPES, if the EQ controls are all turned down, there will be little or no sound coming from the amp due to the way the circuit of the original works). And, if a PEDAL is being used, check the DRIVE and LEVEL settings.
- Are you in MANUAL MODE? If yes, turn the following controls above their minimum setting: PEDAL DRIVE & PEDAL LEVEL [3], GAIN, TREBLE, MIDDLE, BASS, VR GAIN & CH VOLUME.
- Could you have activated Mute on a connected foot controller? Defeat the Mute function.

3. There's no sound from the OUTPUT or PHONES jacks when you use them.

- Check that the LEVEL knob that adjusts their output isn't turned all the way down.

4. No signal (or a distorted signal) is heard from the DIGITAL OUT jack.

- Could the GLOBAL "DOUT LVL" be set to a low or excessively high value?

5. You can't hear any MODULATION, DELAY or REVERB effects even though they're dialed in...

- Are the effect LEDs lit?
If an LED is dark, the corresponding effect is off. Press the TYPE button to select an effect type.
- Could the modulation "DEPTH" or the delay/reverb "MIX" be set to a low value?
Press the TYPE button to select an effect and use the value knobs to adjust the appropriate parameters.
- Could the effect be bypassed? Is the effect type LED blinking?
If so, press the TAP button to cancel bypass. The effect type LED will stop blinking and remain lit.

6. You're using the ACOUSTIC pedal effect and getting nasty high frequency distortion.

- Could the Drive setting be excessively high?
- Are you using a very high output humbucking pickup?
Either turn down the volume of your guitar, or turn down the GAIN setting.

7. The sound connected to your guitar amp is distorted, or sounds wrong.

- Could the AMP/LINE switch be set to "LINE"?
- Could LEVEL be raised excessively?

MIDI Implementation Chart

[VOX Valvetronix]

Date : 2002. 12.20

MIDI Implementation Chart

ToneLab

Function	Transmitted	Recognized	Remarks
Basic Channel Default Changed	1 - 16 1 - 16	1 - 16 1 - 16	Memorized
Mode Memorized Messages Altered	X X *****	3 X X	
Note Number: True Voice	X *****	X *****	
Velocity Note On Note Off	X X	X X	
Aftertouch Polyphonic (Key) Monophonic (Channel)	X X	X X	
Pitch Bend	X	X	
Control Change 0-95	○	○	Effect Control *C

Program Change	Variable Range	<input type="radio"/> 0 – 95 *****	<input type="radio"/> 0 – 95 0 – 95	* P
System Exclusive		<input type="radio"/>	<input type="radio"/>	Parameter Control Program Data Damp * E * 1
System Common	Song Position Song Select Tune	<input checked="" type="checkbox"/> <input checked="" type="checkbox"/> <input checked="" type="checkbox"/>	<input checked="" type="checkbox"/> <input checked="" type="checkbox"/> <input checked="" type="checkbox"/>	
System Real Time	Clock Command	<input checked="" type="checkbox"/> <input checked="" type="checkbox"/>	<input checked="" type="checkbox"/> <input checked="" type="checkbox"/>	
Aux Messages	Local On/Off All Notes Off Active Sense Reset	<input checked="" type="checkbox"/> <input checked="" type="checkbox"/> <input checked="" type="checkbox"/> <input checked="" type="checkbox"/>	<input checked="" type="checkbox"/> <input checked="" type="checkbox"/> <input checked="" type="checkbox"/> <input checked="" type="checkbox"/>	
Notes				

*P: Transmitted if GLOBAL "PCHG OUT" is On.

*C: Transmitted and received according to the setting of each controller if GLOBAL "CCHG I/O" is On.

*E: Transmitted if GLOBAL "SYEX OUT" is On. (Responses to Request messages are always transmitted regardless of the "SYEX OUT" setting.)

*1: In addition to messages specifically for this device, Device Inquiry is also supported.

Mode 1: OMNI ON, POLY

Mode 2: OMNI ON, MONO

: Yes

Mode 3: OMNI OFF, POLY

Mode 4: OMNI OFF, MONO

: No

Consult your local Korg distributor for more information on MIDI IMPLEMENTATION.

Specifications

NUMBER OF AMP TYPES: 16

NUMBER OF CABINET TYPES: 10

NUMBER OF EFFECTS

PEDAL TYPES: 10

MODULATION TYPES: 5

DELAY TYPES: 3

REVERB TYPES: 3

NOISE REDUCTION: 1

NUMBER OF PROGRAMS: 96 (24 BANKS x 4 CHANNELS)

AUDIO INPUTS

INPUT x 1

AUDIO OUTPUTS

OUTPUT x 2 (balanced/unbalanced TRS)

DIGITAL OUT x 1 (S/P DIF format: IEC60958, EIAJ CP-1201)

PHONES x 1

AMP/LINE switch, LEVEL knob (adjusts OUTPUT and PHONES)

VALVE

12AX7 (ECC83) x 1

SIGNAL PROCESSING

A/D conversion: 20bit

D/A conversion: 20bit

Sampling frequency: 44.1KHz

TUNER

TUNING RANGE: A0–C7 (27.5Hz–2093Hz)

TUNER CALIBRATION: A = 438Hz–445Hz

OTHER

VOX BUS x 1, MIDI IN x 1, MIDI OUT x 1, ~AC9V x 1, STANDBY switch

POWER CONSUMPTION: 18 W

DIMENSIONS (W x D x H): 319 x 213 x 79 (mm)/ 12.56 x 8.39 x 3.11 (inches)

WEIGHT: 2.5 Kg / 5.51 lbs.

INCLUDED ITEMS: AC/AC power supply 9VAC 3.0A

OPTIONS: VOX Valvetronix foot controller

* Appearance and specifications of this product are subject to change without notice.

Program list

1-1 BLIZZARD

AMP	CABINET	TREBLE	MIDDLE	BASS	PRESENCE	GAIN	VR GAIN	CH VOLUME
UK MODERN	UK H30 4x12	4.8	6.4	5	3.7	7.9	5	3.4
PEDAL	DRIVE	STONE	LEVEL	MOD	SPEED	MIX	DEPTH	NR
OFF	—	—	—	CHORUS	0.27	3.3	1.3	7.6
DELAY	TIME	MIX	FEEDBACK	REVERB	LO DAMP	MIX	HI DAMP	
TAPE ECHO	440	4	4	ROOM	3	4.4	3.4	

1-2 HYSTERIA

AMP	CABINET	TREBLE	MIDDLE	BASS	PRESENCE	GAIN	VR GAIN	CH VOLUME
BLACK 2X12	BLACK 2X12	3.3	3.3	2.5	2	2.6	10	4
PEDAL	SENS	ATTACK	LEVEL	MOD	SPEED	RESO	DEPTH	NR
COMP	1	4.4	6.4	FLANGER	0.12	0	7.5	2.4
DELAY	TIME	MIX	FEEDBACK	REVERB	LO DAMP	MIX	HI DAMP	
TAPE ECHO	501	3.3	2.9	ROOM	2.4	3.2	2.7	

1-3 BIZKIT

AMP	CABINET	TREBLE	MIDDLE	BASS	PRESENCE	GAIN	VR GAIN	CH VOLUME
RECT	US V30 4X12	6.2	1	3.2	6.3	7.4	6.4	3.5
PEDAL	DRIVE	STONE	LEVEL	MOD	SPEED	MIX	DEPTH	NR
OFF	—	—	—	OFF	—	—	—	7.4
DELAY	TIME	MIX	FEEDBACK	REVERB	LO DAMP	MIX	HI DAMP	
OFF	—	—	—	SPRING	2.7	2.4	2.6	

1-4 MAYTONE

AMP	CABINET	TREBLE	MIDDLE	BASS	PRESENCE	GAIN	VR GAIN	CH VOLUME
AC30	VOX AC30	4.7	4.9	4.4	5.3	10	10	2
PEDAL	DRIVE	STONE	LEVEL	MOD	SPEED	MIX	DEPTH	NR
TREBLE BOOST	6.7	7.6	6.5	CHORUS	0.2	4.8	1.4	3.8
DELAY	TIME	MIX	FEEDBACK	REVERB	LO DAMP	MIX	HI DAMP	
OFF	—	—	—	OFF	—	—	—	

2-1 CLN-EDGE

AMP	CABINET	TREBLE	MIDDLE	BASS	PRESENCE	GAIN	VR GAIN	CH VOLUME
AC30	VOX AC30	7.1	5.2	4.6	4.8	2.1	10	7.7
PEDAL	SENS	ATTACK	LEVEL	MOD	SPEED	MIX	DEPTH	NR
COMP	1.5	6.4	4.9	CHORUS	0.24	6.4	1.3	4
DELAY	TIME	MIX	FEEDBACK	REVERB	LO DAMP	MIX	HI DAMP	
MULTI HEAD	540	3.1	2.6	PLATE	1.6	1.2	2	

2-2 AC15TREM

AMP	CABINET	TREBLE	MIDDLE	BASS	PRESENCE	GAIN	VR GAIN	CH VOLUME
AC15	VOX AC15	6.3	3.3	6.6	10	4.2	10	4.8
PEDAL	DRIVE	STONE	LEVEL	MOD	SPEED	SPREAD	DEPTH	NR
TREBLE BOOST	4.4	10	10	TREMOLO	3.6	0	3.3	2.6
DELAY	TIME	MIX	FEEDBACK	REVERB	LO DAMP	MIX	HI DAMP	
OFF	—	—	—	SPRING	2.8	2.8	2.7	

2-3 BEETLE

AMP	CABINET	TREBLE	MIDDLE	BASS	PRESENCE	GAIN	VR GAIN	CH VOLUME
AC30TB	VOX AC30	4.5	3.5	3.5	4.8	4.7	10	3
PEDAL	DRIVE	STONE	LEVEL	MOD	SPEED	MIX	DEPTH	NR
OFF	—	—	—	OFF	—	—	—	3.4
DELAY	TIME	MIX	FEEDBACK	REVERB	LO DAMP	MIX	HI DAMP	
TAPE ECHO	164	3.6	0	OFF	—	—	—	

2-4 QUEEN FL

AMP	CABINET	TREBLE	MIDDLE	BASS	PRESENCE	GAIN	VR GAIN	CH VOLUME
AC30	VOX AC30	4.8	4.7	7.9	4.5	6.1	10	2.2
PEDAL	DRIVE	STONE	LEVEL	MOD	SPEED	RESO	DEPTH	NR
TREBLE BOOST	5.9	9.2	8.1	FLANGER	0.115	0	7.4	2.6
DELAY	TIME	MIX	FEEDBACK	REVERB	LO DAMP	MIX	HI DAMP	
OFF	—	—	—	ROOM	2.5	5	4.4	

3-1 THRASH

AMP	CABINET	TREBLE	MIDDLE	BASS	PRESENCE	GAIN	VR GAIN	CH VOLUME
UK MODERN	UK T75 4X12	5.6	0	10	3.6	9.3	4.4	5.5
PEDAL	DRIVE	TONE	LEVEL	MOD	SPEED	MIX	DEPTH	NR
OFF	—	—	—	OFF	—	—	—	8
DELAY	TIME	MIX	FEEDBACK	REVERB	LO DAMP	MIX	HI DAMP	
OFF	—	—	—	OFF	—	—	—	

3-2 ANGUS

AMP	CABINET	TREBLE	MIDDLE	BASS	PRESENCE	GAIN	VR GAIN	CH VOLUME
UK BLUES	UK H30 4X12	3.6	6.7	7.9	3.6	10	10	1.4
PEDAL	DRIVE	TONE	LEVEL	MOD	SPEED	MIX	DEPTH	NR
OFF	—	—	—	OFF	—	—	—	3.4
DELAY	TIME	MIX	FEEDBACK	REVERB	LO DAMP	MIX	HI DAMP	
OFF	—	—	—	ROOM	6	1.5	7.1	

3-3 VIABLE

AMP	CABINET	TREBLE	MIDDLE	BASS	PRESENCE	GAIN	VR GAIN	CH VOLUME
UK '90S	UK T75 4X12	2.6	7.2	8.1	3.1	7.6	5	3.5
PEDAL	SENS	ATTACK	POLARITY	MOD	SPEED	MIX	DEPTH	NR
AUTO WAH	5	5	UP	OFF	—	—	—	3
DELAY	TIME	MIX	FEEDBACK	REVERB	LO DAMP	MIX	HI DAMP	
TAPE ECHO	527	3.7	2.7	SPRING	2.4	2.5	2.3	

3-4 PRIEST

AMP	CABINET	TREBLE	MIDDLE	BASS	PRESENCE	GAIN	VR GAIN	CH VOLUME
UK '80S	UK T75 4X12	4	5.3	10	2.8	10	10	2.2
PEDAL	DRIVE	TONE	LEVEL	MOD	SPEED	MIX	DEPTH	NR
OFF	—	—	—	OFF	—	—	—	5
DELAY	TIME	MIX	FEEDBACK	REVERB	LO DAMP	MIX	HI DAMP	
OFF	—	—	—	ROOM	2.9	2.8	2.7	

4-1 NASHVILL

AMP	CABINET	TREBLE	MIDDLE	BASS	PRESENCE	GAIN	VR GAIN	CH VOLUME
TWEED 1X12	TWEED 1X12	3.7	2.6	5	4.3	3.3	10	6.1
PEDAL	SENS	ATTACK	LEVEL	MOD	SPEED	MIX	DEPTH	NR
COMP	2	4.4	4	OFF	—	—	—	3
DELAY	TIME	MIX	FEEDBACK	REVERB	LO DAMP	MIX	HI DAMP	
DELAY	160	4.8	0	PLATE	0.8	2.6	0	

4-2 JIMIROTO

AMP	CABINET	TREBLE	MIDDLE	BASS	PRESENCE	GAIN	VR GAIN	CH VOLUME
BLACK 2X12	BLACK 2X12	3.3	3.7	6.2	2.6	3.1	10	3.8
PEDAL	SPEED	MIX	DEPTH	MOD	SPEED	MIX	DEPTH	NR
U-VIBE	1	5	8.9	OFF	—	—	—	3
DELAY	TIME	MIX	FEEDBACK	REVERB	LO DAMP	MIX	HI DAMP	
OFF	—	—	—	SPRING	4	1.5	1.2	

4-3 X-FIRE

AMP	CABINET	TREBLE	MIDDLE	BASS	PRESENCE	GAIN	VR GAIN	CH VOLUME
TWEED 4X10	TWEED 4X10	1.8	8.8	6.1	6.5	3.7	10	2.2
PEDAL	DRIVE	TONE	LEVEL	MOD	SPEED	MIX	DEPTH	NR
TUBE OD	6.7	5.8	8.6	OFF	—	—	—	4
DELAY	TIME	MIX	FEEDBACK	REVERB	LO DAMP	MIX	HI DAMP	
TAPE ECHO	340	2.2	0	SPRING	4	2.2	2.1	

4-4 CLN-TREM

AMP	CABINET	TREBLE	MIDDLE	BASS	PRESENCE	GAIN	VR GAIN	CH VOLUME
BLACK 2X12	BLACK 2X10	4.4	4.4	4.4	1.3	3.7	10	6
PEDAL	DRIVE	TONE	LEVEL	MOD	SPEED	SPREAD	DEPTH	NR
COMP	1.1	6.8	3.2	TREMOLO	4.2	0	3.2	4
DELAY	TIME	MIX	FEEDBACK	REVERB	LO DAMP	MIX	HI DAMP	
OFF	—	—	—	SPRING	5.6	2	3.4	

5-1 DIRT

AMP	CABINET	TREBLE	MIDDLE	BASS	PRESENCE	GAIN	VR GAIN	CH VOLUME
RECTO	US V30 4X12	5.3	5.6	5.2	3.4	7.7	4.7	4.4
PEDAL	DRIVE	TONE	LEVEL	MOD	SPEED	MIX	DEPTH	NR
OFF	—	—	—	OFF	—	—	—	6.4
DELAY	TIME	MIX	FEEDBACK	REVERB	LO DAMP	MIX	HI DAMP	
OFF	—	—	—	OFF	—	—	—	

5-2 MR.CLEAN

AMP	CABINET	TREBLE	MIDDLE	BASS	PRESENCE	GAIN	VR GAIN	CH VOLUME
BOUTIQUE CL	VOX AD412	4.5	2.9	7.6	3.1	3.4	10	2.7
PEDAL	DRIVE	TONE	LEVEL	MOD	SPEED	MIX	DEPTH	NR
OFF	—	—	—	CHORUS	0.23	6.4	6.1	3
DELAY	TIME	MIX	FEEDBACK	REVERB	LO DAMP	MIX	HI DAMP	
OFF	—	—	—	SPRING	2	1.4	1.8	

5-3 UNCHAIN

AMP	CABINET	TREBLE	MIDDLE	BASS	PRESENCE	GAIN	VR GAIN	CH VOLUME
US HIGAIN	UK T75 4X12	2.6	7.9	8.8	1.5	4.2	5.7	2.6
PEDAL	DRIVE	TONE	LEVEL	MOD	SPEED	RESO	DEPTH	NR
TUBE OD	6.1	8.1	4.8	FLANGER	0.145	0.6	7.1	8
DELAY	TIME	MIX	FEEDBACK	REVERB	LO DAMP	MIX	HI DAMP	
TAPE ECHO	250	4.4	2.8	ROOM	2.1	3.1	1.8	

5-4 SLASHED

AMP	CABINET	TREBLE	MIDDLE	BASS	PRESENCE	GAIN	VR GAIN	CH VOLUME
BOUTIQUE OD	UK H30 4X12	3.8	3.9	9.7	2.8	7.4	10	2.2
PEDAL	DRIVE	TONE	LEVEL	MOD	SPEED	MIX	DEPTH	NR
TUBE OD	7.8	5.2	4.7	OFF	—	—	—	7
DELAY	TIME	MIX	FEEDBACK	REVERB	LO DAMP	MIX	HI DAMP	
TAPE ECHO	334	4.4	4.8	ROOM	4	2.5	5.2	

6-1 SKYNYRD

AMP	CABINET	TREBLE	MIDDLE	BASS	PRESENCE	GAIN	VR GAIN	CH VOLUME
TWEED 1X12	TWEED 1X12	4.8	5.3	7.6	2.9	2.9	10	7.8
PEDAL	SENS	ATTACK	LEVEL	MOD	SPEED	RESO	DEPTH	NR
COMP	1.3	4.4	3.9	PHASER	0.23	0	7.1	4
DELAY	TIME	MIX	FEEDBACK	REVERB	LO DAMP	MIX	HI DAMP	
OFF	—	—	—	SPRING	7.4	1.9	3	

6-2 ZEP

AMP	CABINET	TREBLE	MIDDLE	BASS	PRESENCE	GAIN	VR GAIN	CH VOLUME
UK68P	UK H30 4X12	8.8	0.6	2.1	8.6	10	10	1.8
PEDAL	DRIVE	TONE	LEVEL	MOD	SPEED	MIX	DEPTH	NR
OFF	—	—	—	OFF	—	—	—	7
DELAY	TIME	MIX	FEEDBACK	REVERB	LO DAMP	MIX	HI DAMP	
OFF	—	—	—	ROOM	6.4	4	5.7	

6-3 VULGAR

AMP	CABINET	TREBLE	MIDDLE	BASS	PRESENCE	GAIN	VR GAIN	CH VOLUME
US HIGAIN	VOX AD412	2.4	6.4	8.9	4.5	10	5.2	3.3
PEDAL	DRIVE	TONE	LEVEL	MOD	SPEED	MIX	DEPTH	NR
TREBLE BOOST	3.9	9.2	7.1	CHORUS	0.48	3.6	1.8	7.6
DELAY	TIME	MIX	FEEDBACK	REVERB	LO DAMP	MIX	HI DAMP	
OFF	—	—	—	OFF	—	—	—	

6-4 BLUES

AMP	CABINET	TREBLE	MIDDLE	BASS	PRESENCE	GAIN	VR GAIN	CH VOLUME
BOUTIQUE OD	UK T75 4X12	4.6	4.5	6.3	2.6	3	8.1	3.3
PEDAL	DRIVE	TONE	LEVEL	MOD	SPEED	MIX	DEPTH	NR
OFF	—	—	—	CHORUS	0.27	4.2	3.8	6.6
DELAY	TIME	MIX	FEEDBACK	REVERB	LO DAMP	MIX	HI DAMP	
OFF	—	—	—	PLATE	2.5	1.9	1.8	

7-1 TASTY-FL

AMP	CABINET	TREBLE	MIDDLE	BASS	PRESENCE	GAIN	VR GAIN	CH VOLUME
TWEED 4X10	TWEED 4X10	3.7	9.7	8.4	1.8	2.2	10	7
PEDAL	DRIVE	tone	LEVEL	MOD	SPEED	RESO	DEPTH	NR
COMP	1.9	1	3.9	FLANGER	0.19	1.7	7.4	3
DELAY	TIME	MIX	FEEDBACK	REVERB	LO DAMP	MIX	HI DAMP	
OFF	—	—	—	PLATE	2.5	2.1	1.8	

7-2 EC BADGE

AMP	CABINET	TREBLE	MIDDLE	BASS	PRESENCE	GAIN	VR GAIN	CH VOLUME
UK 68P	UK H30 4X12	2.8	1.8	6.7	1.7	2.3	10	5.3
PEDAL	DRIVE	tone	LEVEL	MOD	SPEED	TIME	DEPTH	NR
OFF	—	—	—	ROTARY	0.8	5	5	3
DELAY	TIME	MIX	FEEDBACK	REVERB	LO DAMP	MIX	HI DAMP	
OFF	—	—	—	SPRING	7.7	4.1	2.6	

7-3 SABBATH

AMP	CABINET	TREBLE	MIDDLE	BASS	PRESENCE	GAIN	VR GAIN	CH VOLUME
US HIGAIN	UK T75 4X12	3.2	0.3	8.9	2.7	10	10	2.9
PEDAL	DRIVE	tone	LEVEL	MOD	SPEED	MIX	DEPTH	NR
TREBLE BOOST	4.1	9.2	7.1	OFF	—	—	—	6.4
DELAY	TIME	MIX	FEEDBACK	REVERB	LO DAMP	MIX	HI DAMP	
OFF	—	—	—	OFF	—	—	—	

7-4 CARLOS

AMP	CABINET	TREBLE	MIDDLE	BASS	PRESENCE	GAIN	VR GAIN	CH VOLUME
RECTO	TWEED 1X12	4	3.1	8	4.4	6.3	10	2.2
PEDAL	DRIVE	tone	LEVEL	MOD	SPEED	MIX	DEPTH	NR
TUBE OD	3.2	7.7	7.5	CHORUS	0.23	6.4	6.1	6.2
DELAY	TIME	MIX	FEEDBACK	REVERB	LO DAMP	MIX	HI DAMP	
OFF	—	—	—	PLATE	3.6	3.6	5.5	

8-1 FUNKY

AMP	CABINET	TREBLE	MIDDLE	BASS	PRESENCE	GAIN	VR GAIN	CH VOLUME
BLACK 2X12	BLACK2X10	3.6	6.7	6.4	1	2.6	10	7.7
PEDAL	SENS	ATTACK	LEVEL	MOD	SPEED	RESO	DEPTH	NR
COMP	1	4.4	3.7	PHASER	0.96	1.4	7.1	3.8
DELAY	TIME	MIX	FEEDBACK	REVERB	LO DAMP	MIX	HI DAMP	
TAPE ECHO	244	4.4	0	PLATE	1.8	2	4.4	

8-2 MR. SCARY

AMP	CABINET	TREBLE	MIDDLE	BASS	PRESENCE	GAIN	VR GAIN	CH VOLUME
US HIGAIN	VOX AD412	5.3	4.8	6.8	1	7.6	4.5	4.6
PEDAL	DRIVE	tone	LEVEL	MOD	SPEED	MIX	DEPTH	NR
OFF	—	—	—	OFF	—	—	—	6
DELAY	TIME	MIX	FEEDBACK	REVERB	LO DAMP	MIX	HI DAMP	
MULTI HEAD	339	4	1.7	ROOM	5.2	3.8	5.6	

8-3 JIMIFUZZ

AMP	CABINET	TREBLE	MIDDLE	BASS	PRESENCE	GAIN	VR GAIN	CH VOLUME
UK 68P	UK H30 4X12	6.5	4.4	3.3	10	6	10	1.6
PEDAL	DRIVE	tone	LEVEL	MOD	SPEED	RESO	DEPTH	NR
FUZZ	4.1	10	7.5	PHASER	0.27	0	7.1	3.4
DELAY	TIME	MIX	FEEDBACK	REVERB	LO DAMP	MIX	HI DAMP	
OFF	—	—	—	PLATE	1.8	3.4	2.8	

8-4 FOLK

AMP	CABINET	TREBLE	MIDDLE	BASS	PRESENCE	GAIN	VR GAIN	CH VOLUME
BLACK 2X12	BLACK 2X12	3.7	4.8	5.3	4.4	2.8	8.2	8
PEDAL	BASS	BODY	TREBLE	MOD	SPEED	MIX	DEPTH	NR
ACOUSTIC	5.2	8.6	3.7	CHORUS	0.14	7.9	2.1	2
DELAY	TIME	MIX	FEEDBACK	REVERB	LO DAMP	MIX	HI DAMP	
OFF	—	—	—	ROOM	7.7	6.1	5.3	

9-1 OLDGUY

AMP	CABINET	TREBLE	MIDDLE	BASS	PRESENCE	GAIN	VR GAIN	CH VOLUME
TWEED 4X10	BLACK 2X10	3.5	5.9	2.8	6.6	1.8	10	7
PEDAL	DRIVE	TONE	LEVEL	MOD	SPEED	MIX	DEPTH	NR
OFF	—	—	—	CHORUS	0.23	6.4	6.1	2
DELAY	TIME	MIX	FEEDBACK	REVERB	LO DAMP	MIX	HI DAMP	
OFF	—	—	—	SPRING	3.6	3.3	4.2	

9-2 CRUNCH 1

AMP	CABINET	TREBLE	MIDDLE	BASS	PRESENCE	GAIN	VR GAIN	CH VOLUME
AC30TB	VOX AC30	4.9	5.9	2.3	5.2	6.5	10	3
PEDAL	DRIVE	TONE	LEVEL	MOD	SPEED	MIX	DEPTH	NR
OFF	—	—	—	OFF	—	—	—	3.6
DELAY	TIME	MIX	FEEDBACK	REVERB	LO DAMP	MIX	HI DAMP	
OFF	—	—	—	SPRING	3.6	3.3	4.2	

9-3 CRUNCH 2

AMP	CABINET	TREBLE	MIDDLE	BASS	PRESENCE	GAIN	VR GAIN	CH VOLUME
AC15TB	VOX AC30	7.3	5.9	10	3.8	7.4	10	2.2
PEDAL	DRIVE	TONE	LEVEL	MOD	SPEED	MIX	DEPTH	NR
OFF	—	—	—	CHORUS	0.23	6.4	6.1	3
DELAY	TIME	MIX	FEEDBACK	REVERB	LO DAMP	MIX	HI DAMP	
OFF	—	—	—	SPRING	3.6	3.3	4.2	

9-4 SOLO

AMP	CABINET	TREBLE	MIDDLE	BASS	PRESENCE	GAIN	VR GAIN	CH VOLUME
UK 68P	UK H30 4X12	8.8	8.2	2.9	8.7	8.7	10	2
PEDAL	DRIVE	TONE	LEVEL	MOD	SPEED	MIX	DEPTH	NR
TUBE OD	5.3	10	7.5	OFF	—	—	—	7.8
DELAY	TIME	MIX	FEEDBACK	REVERB	LO DAMP	MIX	HI DAMP	
TAPE ECHO	470	5.2	4.1	PLATE	3.6	3.3	4.2	

10-1 VOXMAN

AMP	CABINET	TREBLE	MIDDLE	BASS	PRESENCE	GAIN	VR GAIN	CH VOLUME
AC30TB	VOX AC30	7.2	6.7	6.1	10	6.2	7.8	2.4
PEDAL	DRIVE	TONE	LEVEL	MOD	SPEED	MIX	DEPTH	NR
OFF	—	—	—	OFF	—	—	—	3
DELAY	TIME	MIX	FEEDBACK	REVERB	LO DAMP	MIX	HI DAMP	
TAPE ECHO	250	3.3	3.2	PLATE	4.1	3.7	2.9	

10-2 WET AC15

AMP	CABINET	TREBLE	MIDDLE	BASS	PRESENCE	GAIN	VR GAIN	CH VOLUME
AC15	VOX AC15	10	0	6.6	10	4.6	7.9	2.6
PEDAL	DRIVE	TONE	LEVEL	MOD	SPEED	RESO	DEPTH	NR
TREBLE BOOST	10	5	8.2	FLANGER	0.26	3.1	0	2.8
DELAY	TIME	MIX	FEEDBACK	REVERB	LO DAMP	MIX	HI DAMP	
MULTI HEAD	351	3.8	2	OFF	—	—	—	

10-3 HEAVEN

AMP	CABINET	TREBLE	MIDDLE	BASS	PRESENCE	GAIN	VR GAIN	CH VOLUME
BOUTIQUE CL	VOX AD412	5.1	8.9	9.1	3.7	6.2	8.9	1.4
PEDAL	DRIVE	TONE	LEVEL	MOD	SPEED	MIX	DEPTH	NR
OFF	—	—	—	CHORUS	0.13	4.8	3.3	2.4
DELAY	TIME	MIX	FEEDBACK	REVERB	LO DAMP	MIX	HI DAMP	
TAPE ECHO	400	4.2	5.2	PLATE	3.7	6	3.7	

10-4 UK-US

AMP	CABINET	TREBLE	MIDDLE	BASS	PRESENCE	GAIN	VR GAIN	CH VOLUME
UK 68P	US V30 4X12	4.9	0	6.4	0	8	8.9	2.9
PEDAL	DRIVE	TONE	LEVEL	MOD	SPEED	MIX	DEPTH	NR
TUBE OD	10	5.1	3.5	OFF	—	—	—	6
DELAY	TIME	MIX	FEEDBACK	REVERB	LO DAMP	MIX	HI DAMP	
TAPE ECHO	227	3.8	2.2	ROOM	7.4	4.2	3.2	

11- 1 WILDMAN

AMP	CABINET	TREBLE	MIDDLE	BASS	PRESENCE	GAIN	VR GAIN	CH VOLUME
UK '80S	USV30 4X12	0	2.1	8.1	6.3	9.2	7.7	3.7
PEDAL	DRIVE	TONE	LEVEL	MOD	SPEED	MIX	DEPTH	NR
TUBE OD	5.8	7.5	5.2	CHORUS	0.26	3.7	1.9	6.6
DELAY	TIME	MIX	FEEDBACK	REVERB	LO DAMP	MIX	HI DAMP	
TAPE ECHO	539	5.8	0.2	OFF	—	—	—	

11-2 THEATER

AMP	CABINET	TREBLE	MIDDLE	BASS	PRESENCE	GAIN	VR GAIN	CH VOLUME
BOUTIQUE CL	VOX AD412	7.4	6.1	10	7.1	4.3	8	2.4
PEDAL	BASS	BODY	TREBLE	MOD	SPEED	MIX	DEPTH	NR
ACOUSTIC	7.8	8.1	2.6	CHORUS	0.54	5	2.5	3.6
DELAY	TIME	MIX	FEEDBACK	REVERB	LO DAMP	MIX	HI DAMP	
DELAY	590	5.4	2.1	PLATE	6.2	7	6	

11-3 JOSHUA

AMP	CABINET	TREBLE	MIDDLE	BASS	PRESENCE	GAIN	VR GAIN	CH VOLUME
AC30TB	VOX AC30	7.7	5	7.4	6.3	6.9	7.9	2.6
PEDAL	DRIVE	TONE	LEVEL	MOD	SPEED	MIX	DEPTH	NR
OFF	—	—	—	CHORUS	1.8	3.5	1.4	4.8
DELAY	TIME	MIX	FEEDBACK	REVERB	LO DAMP	MIX	HI DAMP	
TAPE ECHO	551	3.2	5.9	PLATE	2.6	3	5	

11-4 POLICE

AMP	CABINET	TREBLE	MIDDLE	BASS	PRESENCE	GAIN	VR GAIN	CH VOLUME
UK 68P	UK H30 4X12	6.7	8.2	10	7	4.1	9.2	3
PEDAL	SENS	ATTACK	LEVEL	MOD	SPEED	MIX	DEPTH	NR
COMP	3.6	2.5	3.8	CHORUS	0.2	6.4	4.6	6.8
DELAY	TIME	MIX	FEEDBACK	REVERB	LO DAMP	MIX	HI DAMP	
DELAY	860	2.5	1.1	PLATE	3.1	4	0.7	

12-1 JOHNNY \$

AMP	CABINET	TREBLE	MIDDLE	BASS	PRESENCE	GAIN	VR GAIN	CH VOLUME
TWEED 4X10	TWEED 4X10	5	4.9	8.1	7.1	2.4	8	6.1
PEDAL	BASS	BODY	TREBLE	MOD	SPEED	MIX	DEPTH	NR
ACOUSTIC	5.6	8	3.6	OFF	—	—	—	3
DELAY	TIME	MIX	FEEDBACK	REVERB	LO DAMP	MIX	HI DAMP	
OFF	—	—	—	SPRING	0	5.2	2.1	

12-2 JAZZMAN

AMP	CABINET	TREBLE	MIDDLE	BASS	PRESENCE	GAIN	VR GAIN	CH VOLUME
BLACK 2X12	BLACK 2X12	1.3	6.1	9.2	0	3.6	7	6
PEDAL	DRIVE	TONE	LEVEL	MOD	SPEED	MIX	DEPTH	NR
OFF	—	—	—	CHORUS	0.17	6.8	5.7	2
DELAY	TIME	MIX	FEEDBACK	REVERB	LO DAMP	MIX	HI DAMP	
OFF	—	—	—	ROOM	9.3	7.1	4.8	

12-3 TEXTREM

AMP	CABINET	TREBLE	MIDDLE	BASS	PRESENCE	GAIN	VR GAIN	CH VOLUME
TWEED 1X12	TWEED 1X12	7	4.1	6.4	5.2	5.6	4	8
PEDAL	DRIVE	TONE	LEVEL	MOD	SPEED	SPREAD	DEPTH	NR
OFF	—	—	—	TREMOLO	4	6.3	3.9	2.8
DELAY	TIME	MIX	FEEDBACK	REVERB	LO DAMP	MIX	HI DAMP	
OFF	—	—	—	SPRING	2.3	5	2.8	

12-4 OCTAMAN

AMP	CABINET	TREBLE	MIDDLE	BASS	PRESENCE	GAIN	VR GAIN	CH VOLUME
BOUTIQUE OD	BLACK 2X10	6.7	4.2	6.8	3.5	5	10	2.4
PEDAL	1 OCTAVE	DIRECT	2 OCTAVE	MOD	SPEED	MIX	DEPTH	NR
OCTAVE	4.1	9.5	2.2	OFF	—	—	—	7.6
DELAY	TIME	MIX	FEEDBACK	REVERB	LO DAMP	MIX	HI DAMP	
TAPE ECHO	1024	7.4	3	PLATE	3.6	3	4.1	

Index

Symbols

 16

Numerics

1OCTAVE 36
2OCTAVE 36

A

AC15 23
AC15TB 24
AC30 25
AC30TB 25
ACOUSTIC 35
AMP Models 21
ATTACK 34, 35
AUTO WAH 35

B

Backing Up 49
BASS 21, 35
BLACK 2x10
(BLK 2X10) 31
BLACK 2x12
(BLK 2X12) 29, 31
BODY 35
BOUTIQUE CL
(BTQ CL) 28
BOUTIQUE OD
(BTQ OD) 28
BYPASS 7

C

Cabinet 31
CABINET Models 31
Calibrating 41
CC 48
CCHG I/O 47
CH VOLUME 6, 22
CHORUS 37
CLOSE 35
COMP 34
Connection 12, 45
Control Change 47
Creating Your Program
17

D

DELAY 39
DELAY Effects 38
DELAY FX 47
DEPTH 36, 37, 38
Digital Output 50
DIRECT 36

DOUT LVL 50
DRIVE 36
DUMP ALL 49
DUMP CUR 49

E

EDIT icon 9
EXP Δ 42
EXP INIT 43
EXP MAX 43
EXP MIN 43
EXP PDL 47
Expression Pedal 42

F

FAT OD 36
FEEDBACK 39
FLANGER 37
Foot Controller 42
FUZZ 36

G

GAIN 22
GLOBAL 9

H

HI DAMP 40
How the original amps
work 22

I

INPUT LEVEL 39, 40

L

LEVEL 34, 36
LO DAMP 40

M

Manual Mode 4, 16
MASTER VOLUME 22
MIDDLE 21
MIDI 45
MIDI CH 46
MIDI Channel 46
MIX 36, 37, 39, 40
Mix any amp model to
any cabinet model
33
MOD Effects 37
MOD FX 47
MULTI HEAD
(MULTI HD) 39

N

Name 19
Noise Reduction 19
NR SENS 19

O

OCTAVE 36
OFF (CABINET) 33
OFF (DELAY) 39
OFF (MOD) 37
OFF (PEDAL) 34
OFF (REVERB) 40
OPEN 35
Original tone controls
21
ORIG icon 20
Original Value 20

P

Parameter Change 48
PCHG OUT 46
PEDAL 35
PEDAL Effects 34
PEDAL FX 47
PHASER 38
PLATE 40
POLARITY 35
PRESENCE 6, 21
Program 15
Program Change 46
Program Select Mode
4, 15
Getting to 16

R

RECTO 28
RELOAD? 51
RESO 37, 38
Restoring 49
Restoring a Setting to
its Original Value 20
Restoring the Factory
Preset 51
REVERB Effects 40
REVRB FX 47
ROOM 40
ROTARY 38

S

SENS 34, 35
Sound Editor 2, 48
SPEED 36, 37, 38
SPREAD 38

SPRING 40
Store 20
SYEX OUT 48

T

TAP 7, 39
TAP SW 47
TAPE ECHO
(T ECHO) 39
TIME 38, 39
TONE 36
TREBLE 21, 35
TREBLE BOOST
(TREB BST) 36
TREMOLO 38
TUBE OD 36
Tuner 41
TWEED 1x12
(TWD 1X12) 29, 31
TWEED 4x10
(TWD 4X10) 30, 31

U

UK '80s 27
UK '90s 27
UK 68P 26
UK BLUES 26
UK H30 4x12
(UK H30) 32
UK MODERN
(UK MODRN) 27
UK T75 4x12
(UK T75) 32
US HIGAIN
(US HI-G) 28
US V30 4x12
(US V30) 32
UTILITY 8
U-VIBE 36

V

Valve Reactor 2
Valve window 10
VOL PDL 47
VOX AC15 (AC15) 32
VOX AC30 (AC30) 32
VOX AD412
(AD412) 32
VOX WAH 35
VR GAIN 22

W

WRITE 20

TOP PANEL:

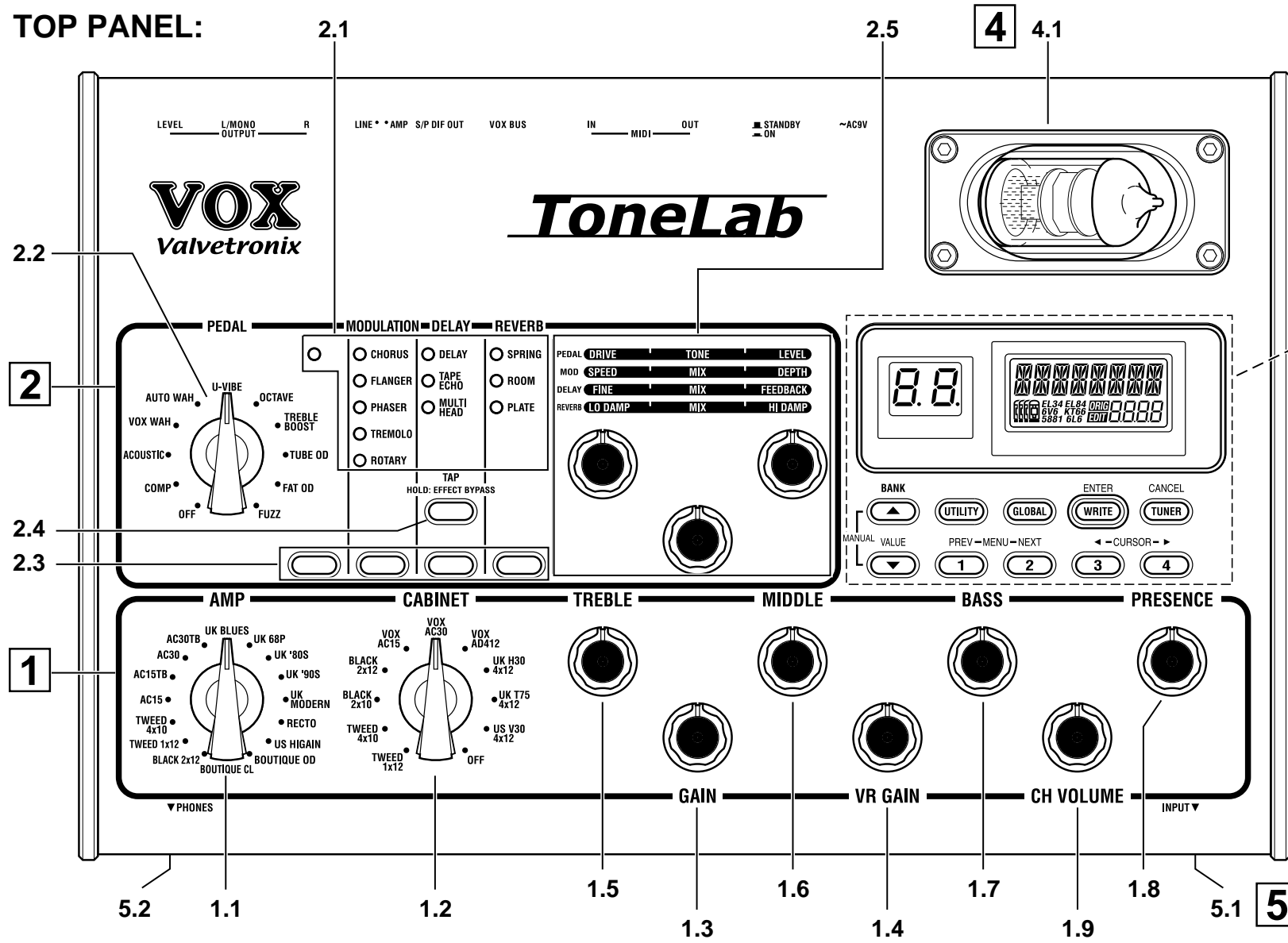

3 Bank/Manual/Write/Tuner/ Channel Section

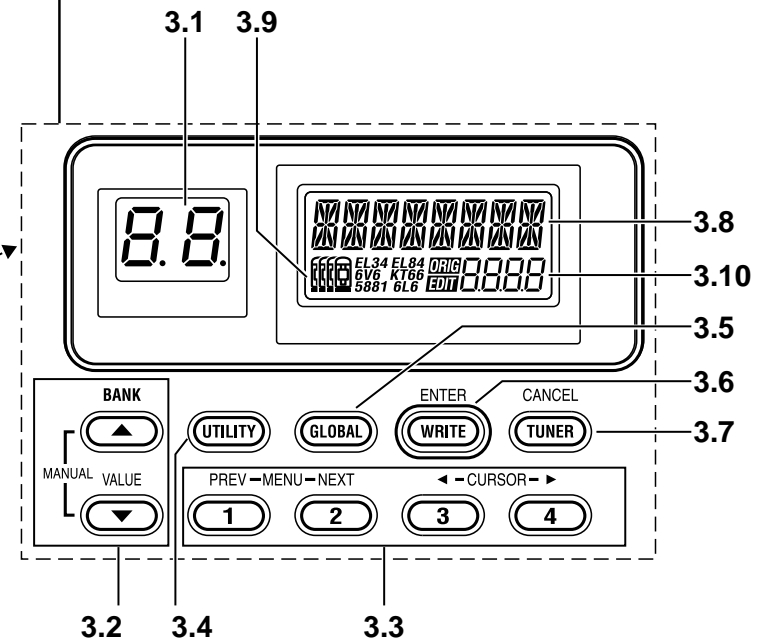

REAR PANEL:

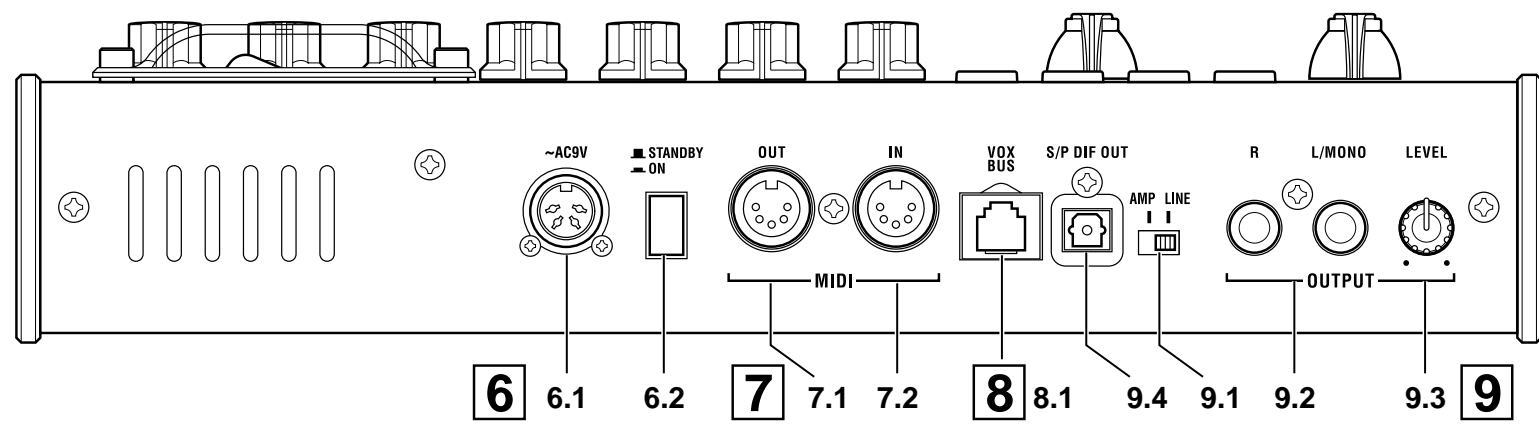

Program Sheet

This sheet is for you to write down your favorite settings. When you come up with a sound you like, write it down for future use. We suggest that you photocopy the program sheet below, and use the copies.
 Don't forget to write down the DELAY TIME setting (use FINE [1] to check it) and the UTILITY settings.

PROGRAM NAME:				
PEDAL <input type="radio"/> PEDAL DRIVE TONE LEVEL AUTO WAH • U-VIBE • OCTAVE VOX WAH • TREBLE BOOST ACOUSTIC • TUBE OD COMP • FAT OD OFF • FUZZ	MODULATION <input type="radio"/> CHORUS <input type="radio"/> FLANGER MOD SPEED MIX DEPTH <input type="radio"/> PHASER <input type="radio"/> TREMOLO <input type="radio"/> ROTARY	DELAY <input type="radio"/> DELAY <input type="radio"/> TAPE ECHO <input type="radio"/> MULTI HEAD DELAY FINE MIX FEEDBACK TAP HOLD: EFFECT BYPASS	REVERB <input type="radio"/> SPRING <input type="radio"/> ROOM <input type="radio"/> PLATE REVERB LO DAMP MIX HI DAMP	
AMP AC30TB • UK BLUES • UK 68P AC30 • UK '80S AC15TB • UK '90S AC15 • UK MODERN TWEED 4x10 • RECTO TWEED 1x12 • US HIGAIN BLACK 2x12 • BOUTIQUE CL BOUTIQUE OD	CABINET VOX AC15 • VOX AC30 • VOX AD412 BLACK 2x12 • UK H30 4x12 BLACK 2x10 • UK T75 4x12 TWEED 4x10 • US V30 4x12 TWEED 1x12 • OFF	TREBLE [Knob]	MIDDLE [Knob]	BASS [Knob]
GAIN		VR GAIN	CH VOLUME	
NR (NOISE REDUCTION):	TAP TEMPO:	NOTE:		

PROGRAM NAME:				
PEDAL <input type="radio"/> PEDAL DRIVE TONE LEVEL AUTO WAH • U-VIBE • OCTAVE VOX WAH • TREBLE BOOST ACOUSTIC • TUBE OD COMP • FAT OD OFF • FUZZ	MODULATION <input type="radio"/> CHORUS <input type="radio"/> FLANGER MOD SPEED MIX DEPTH <input type="radio"/> PHASER <input type="radio"/> TREMOLO <input type="radio"/> ROTARY	DELAY <input type="radio"/> DELAY <input type="radio"/> TAPE ECHO <input type="radio"/> MULTI HEAD DELAY FINE MIX FEEDBACK TAP HOLD: EFFECT BYPASS	REVERB <input type="radio"/> SPRING <input type="radio"/> ROOM <input type="radio"/> PLATE REVERB LO DAMP MIX HI DAMP	
AMP AC30TB • UK BLUES • UK 68P AC30 • UK '80S AC15TB • UK '90S AC15 • UK MODERN TWEED 4x10 • RECTO TWEED 1x12 • US HIGAIN BLACK 2x12 • BOUTIQUE CL BOUTIQUE OD	CABINET VOX AC15 • VOX AC30 • VOX AD412 BLACK 2x12 • UK H30 4x12 BLACK 2x10 • UK T75 4x12 TWEED 4x10 • US V30 4x12 TWEED 1x12 • OFF	TREBLE [Knob]	MIDDLE [Knob]	BASS [Knob]
GAIN		VR GAIN	CH VOLUME	
NR (NOISE REDUCTION):	TAP TEMPO:	NOTE:		



Free Manuals Download Website

<http://myh66.com>

<http://usermanuals.us>

<http://www.somanuals.com>

<http://www.4manuals.cc>

<http://www.manual-lib.com>

<http://www.404manual.com>

<http://www.luxmanual.com>

<http://aubethermostatmanual.com>

Golf course search by state

<http://golfingnear.com>

Email search by domain

<http://emailbydomain.com>

Auto manuals search

<http://auto.somanuals.com>

TV manuals search

<http://tv.somanuals.com>