



C24EA3 BASIC SHOWN

## C24EA SERIES ATMOSPHERIC STEAMERS

10704

**C24EA3 208/240V PRO**  
**C24EA3 480V PRO**  
**C24EA5 208/240V PRO**  
**C24EA5 480V PRO**  
**C24EA3 208/240V BASIC**  
**C24EA3 480V BASIC**  
**C24EA5 208/240V BASIC**  
**C24EA5 480V BASIC**

**ML-136037**  
**ML-136044**  
**ML-136038**  
**ML-136047**  
**ML-136043**  
**ML-136045**  
**ML-136046**  
**ML-136048**

**- NOTICE -**

**This Manual is prepared for the use of trained Vulcan Service Technicians and should not be used by those not properly qualified. If you have attended a Vulcan Service School for this product, you may be qualified to perform all the procedures described in this manual.**

**This manual is not intended to be all encompassing. If you have not attended a Vulcan Service School for this product, you should read, in its entirety, the repair procedure you wish to perform to determine if you have the necessary tools, instruments and skills required to perform the procedure. Procedures for which you do not have the necessary tools, instruments and skills should be performed by a trained Vulcan Service Technician.**

**Reproduction or other use of this Manual, without the express written consent of Vulcan, is prohibited.**

For additional information on Vulcan-Hart Company or to locate an authorized parts and service provider in your area, visit our website at [www.vulcanhart.com](http://www.vulcanhart.com)

# TABLE OF CONTENTS

GENERAL .....	3
COVERS AND PANELS .....	6
DOOR .....	8
DRAIN .....	12
COOKING COMPARTMENT .....	13
THERMOSTATS .....	15
Hold Thermostat .....	15
High-Limit Thermostat .....	15
Condensate Thermostat .....	16
TIMER .....	17
HEATING ELEMENT .....	18
SUPER HEATER .....	20
WATER LEVEL CONTROL COMPONENTS .....	22
Water Level Controls .....	22
Water Level Control Board .....	23
Water Level Probes .....	23
Filtered and Non-Filtered Water Solenoid Valves .....	24
Manual Drain Valve (Basic) .....	25
Motorized Drain Valve (Professional) .....	26
SWITCHES, BUZZER AND SOLENOIDS .....	28
On/Off Switch .....	28
Door Switch .....	29
Pressure Switch .....	30
Vacuum Relief Solenoid .....	32
Buzzer .....	33
STEAM GENERATOR TANK .....	34
ELECTRICAL OPERATION .....	36
Component Function .....	36
Component Location .....	38
Sequence of Operation .....	42
Wiring Diagrams .....	45
TROUBLESHOOTING .....	50
CONDENSED SPARE PARTS LIST .....	52

©VULCAN 2006

# GENERAL

## INTRODUCTION

This manual is applicable to the models and ML numbers listed on the cover page. Procedures apply to all models unless specified otherwise.

### Steam Cooking

Atmospheric steamers offer an efficient way to produce many foods in either small portions or larger batches. Atmospheric convection steam cooking will steam cook fresh foods or will steam defrost and cook frozen foods providing the maximum color, flavor and nutritional value with the least expenditure of energy and labor. The atmospheric steaming compartment allows the operator to open and close the door anytime during a cooking cycle. The generator element will shut off when the door is opened then re-start when the door is closed.

## MODELS COVERED



### Model Designations (based on 2.5 inch pan depth)

C24EA3 Three pan - Basic or Professional

C24EA5 Five pan - Basic or Professional

**SPECIFICATIONS**

**NOTE:** All C24EA steamers, with exception of 480V steamers, are shipped pre-wired for 208/60/3 operation. Steamer heating element wiring connection change is required if connecting to 208/60/1, 240/60/1 or 240/60/3 electrical service.

ELECTRICAL SPECIFICATIONS													
MODEL	TOTAL kW	Hz.	AMPERAGE										
			3 PHASE									1 PHASE	
			208V			240V			480V			208V	240V
			L1	L2	L3	L1	L2	L3	L1	L2	L3		
C24EA3 - Basic	8.5	50/60	26.5	26.5	17.7	20.5	20.5	20.5	10.3	10.3	10.3	40.9	35.4
C24EA5 - Basic	15.0	50/60	46.8	46.8	31.2	36.1	36.1	36.1	18.0	18.0	18.0	72.1	62.5
C24EA3 - Pro	9.25	50/60	26.5	28.9	20.0	20.5	23.2	23.2	10.2	11.6	11.6	43.6	38.5
C24EA5 - Pro	15.75	50/60	46.8	49.2	33.6	36.1	38.8	38.8	18.0	19.4	19.4	74.8	65.6

WATER SUPPLY REQUIREMENTS	
● Supply pressure should be .....	20-60 psig
● In line strainer for supply line (Supplied)	
● Total dissolved solids (TDS)* .....	less than 60 ppm
● Total alkalinity .....	less than 20 ppm
● Silica .....	less than 13 ppm
● Chloride .....	less than 4.0 ppm
● PH factor .....	6.5 to 8
● Undissolved Solids.....	less than 5 microns

\*17.1 ppm = 1 grain of hardness

Water hardness below 4 grains/gal requires water treatment to reduce potential corrosion. Hardness above 6 grains/gal should be treated by water conditioner, water softener or in-line treatment.

**Water Conditioning**

It is recommended that a local water treatment specialist be consulted before the installation of any steam generating equipment.

Furnishing the steam generator with properly conditioned water to reduce scale formation is important. Scale formation will reduce steam output, cause premature component failure and shorten equipment life. Most water supplies contain scale producing minerals such as calcium and magnesium. As steam is generated, the minerals remain and dissolve into the remaining water. As the concentration of these minerals increases past a certain point, they precipitate from the water and coat the inside of the tank, heating elements, thermostat bulbs and water level probes. Because of the high temperature of these surfaces, the precipitated minerals bake onto them and become very difficult to remove.

This phenomenon causes several problems:

1. Reduces the heat transfer efficiency of the heaters.
2. Causes premature failure of the heaters.
3. Water level probes will give false readings.
4. Thermostat bulbs will sense temperature incorrectly.

These problems are common to any manufacturer's steamer regardless of design, but they can all be prevented by furnishing the steam generator tank with properly conditioned water. Vulcan recommends the water contain less than 60ppm of total dissolved solids (TDS) and have a PH factor between 6.5 to 8.

Other chemical properties in water supplies can also affect good steam generation and vary from within each state and locality.

The water level probes in the steam generator tank use ions in the water to detect the water level. **Do not use** fully demineralized or de-ionized water since it is non-conductive and the water level can not be detected.

**NOTE:** The use of strainers, or filters will not remove minerals from the water.

Steamers that operate over a long period of time without the benefit of properly conditioned water, which have developed a heavy scale build up, should be cleaned before connecting to a conditioned water supply.

## REFERENCE MATERIAL

For replacement parts, refer to Catalog of Replacement Parts F-43123.

For operation, care and cleaning instructions, refer to Installation and Operation Manual F-35428.

## LUBRICATION

Component	Lubrication Type
Heating Element Screws	Never Seez
All NPT Fittings	Pipe Thread Sealant, Loctite 565
Door Handle Sliding Bracket	Lubriplate 630AA

## TOOLS

- Standard set of hand tools.
- VOM with A/C current tester (any quality VOM with a sensitivity of at least 20K ohms per volt can be used).
- Anti Static Kit, part no. TL - 84919.

### Special

- Torque Wrench - Capable of measuring 70 in\*lb.
- Aluminum Foil Tape - (McMaster-Carr Part No. 7631A21) or equivalent.

- Pressure Gauge Assembly
  - Low Pressure Gauge - 0 to 5 psi. recommended (Grainger Part No. 2C641).
  - Water Hose Coupling - swivel type (Grainger Part No. 4KG87).
  - Reducer Bushing (Grainger Part No. 6MN61).
  - Pipe thread sealant (as required).

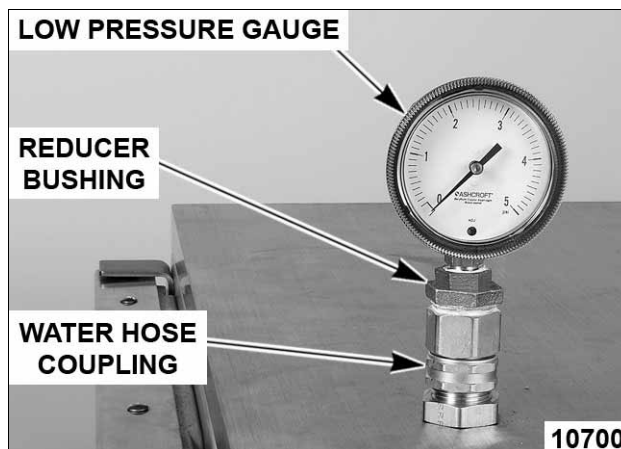

# COVERS AND PANELS



**WARNING:** DISCONNECT THE ELECTRICAL POWER TO THE MACHINE AND FOLLOW LOCKOUT / TAGOUT PROCEDURES.

## RIGHT AND LEFT SIDE PANELS

**NOTE:** Removal of left side panel is identical to the procedure for the right side panel.

1. Remove screws from the bottom of panel being removed.

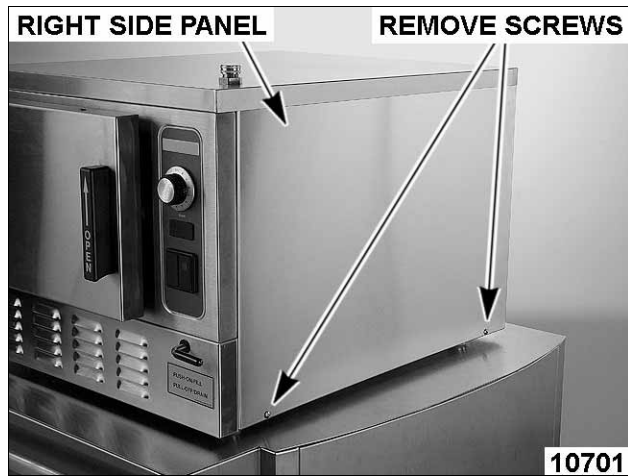

2. Pull bottom of panel out and slide down to clear top cover.
3. Reverse procedure to install.

## TOP COVER

1. Remove RIGHT AND LEFT SIDE PANELS.
2. Remove the screws securing top cover to rear panel.

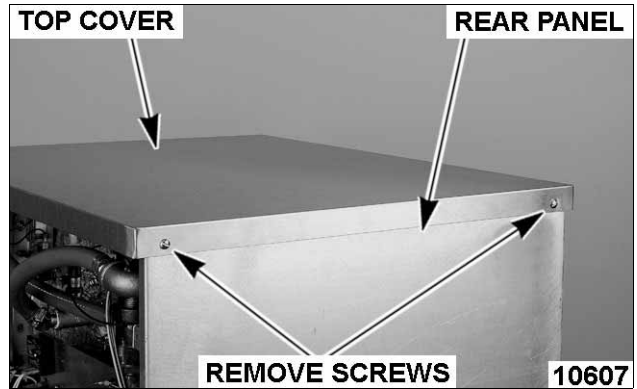

3. Remove the screws securing top cover to front panel. Screws are located on either side of the cooking cavity.
4. Disconnect the delime hose from delime port fitting.

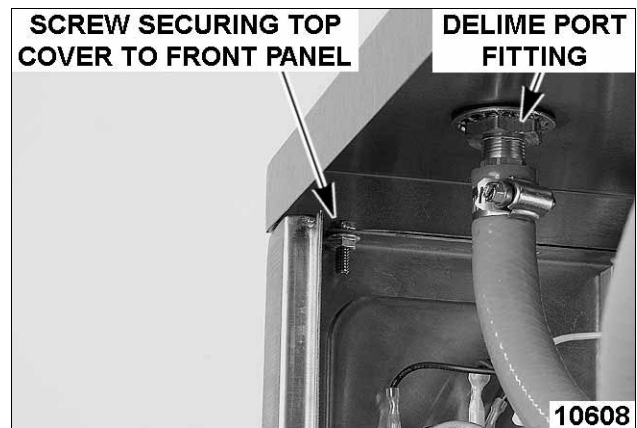

RIGHT SIDE SHOWN

5. Lift top cover off machine.
6. Reassemble parts removed in reverse order.
7. Check machine for proper operation.

## REAR PANEL



**WARNING:** DISCONNECT THE ELECTRICAL POWER TO THE MACHINE AND FOLLOW LOCKOUT / TAGOUT PROCEDURES.

1. Remove screws securing top cover to rear panel and rear panel to steamer frame.

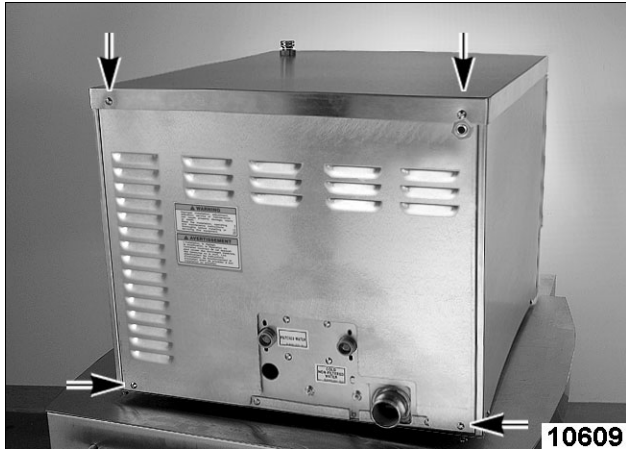

SCREW LOCATION

**NOTE:** If incoming plumbing or drain interferes with rear panel removal, turn off water supply and disconnect plumbing to machine.

2. Remove LEFT SIDE PANEL.
3. Disconnect vacuum relief hose from fitting.



TOP COVER REMOVED FOR CLARITY

4. Pull bottom of rear panel away from machine and plumbing.
5. Reassemble parts removed in reverse order.

# DOOR



**WARNING:** DISCONNECT THE ELECTRICAL POWER TO THE MACHINE AND FOLLOW LOCKOUT / TAGOUT PROCEDURES.

## REMOVAL

1. Close door.
2. Remove LEFT SIDE PANEL as outlined in COVERS AND PANELS.
3. Remove nuts from upper hinge located inside front panel.

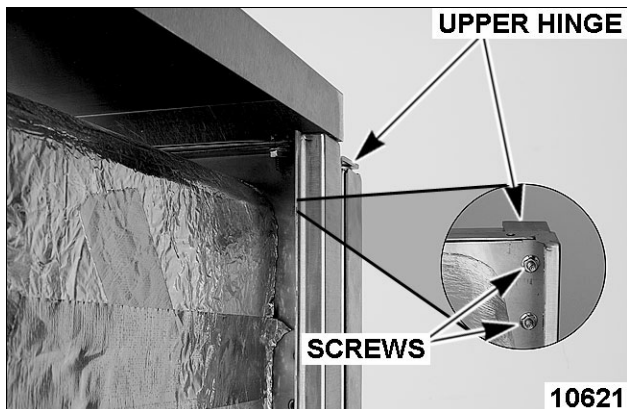

4. Open door slightly, and while holding door, pull upper hinge away from front panel.
5. Pull upper hinge out of upper door hinge bushing.
6. Lift door assembly up and off lower door hinge.
7. Reinstall parts removed in reverse order of removal.
8. Check door for fit and proper sealing of gasket.

## GASKET

1. Open door.
2. Remove the shoulder screws and pan pusher bracket from gasket plate.

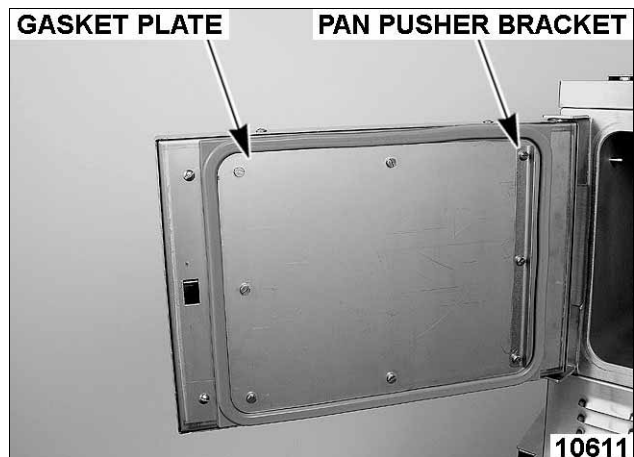

3. Remove gasket plate.
4. Remove gasket from inner door panel.
5. Remove RTV from bottom part of inner door panel. Apply new RTV 109 to bottom of door where shown when assembling gasket to door.

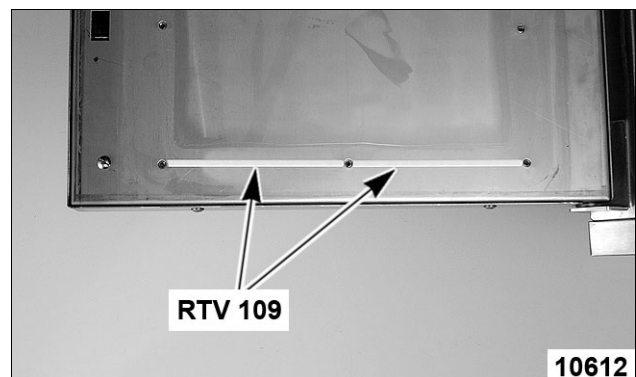

6. Place a small amount of RTV109 into the inner door panel gasket screw holes before assembly.
7. Position the new gasket on gasket plate and reverse procedure to install.



## DOOR HANDLE

### Removal

1. Open door.
2. Remove screws from top and bottom of door assembly.

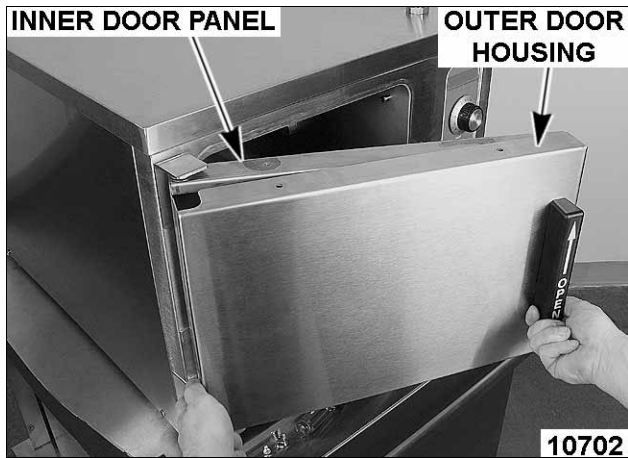

3. Pull outer door housing away from inner door panel starting at the hinge side of door to separate the door halves.

**NOTE:** The smaller radius of the step spacers fit into the slots of the outer door housing and is used to provide clearance for handle operation.

4. Remove lock nuts and stepped spacers from threaded studs of door handle.

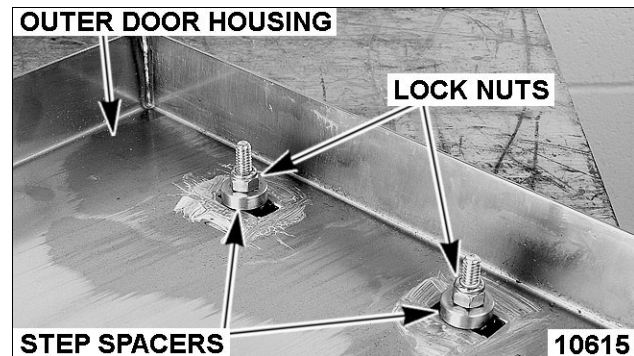

### Installation

1. Apply Lubriplate 630AA around slots of outer door housing where step spacers contact housing.
2. Install door handle into outer door housing such that hinge side of door housing is to the left and arrow on handle is pointed upward.
3. Install step spacer with smaller radius toward handle and door housing. Smaller radius is a slip fit with outer door housing slot.

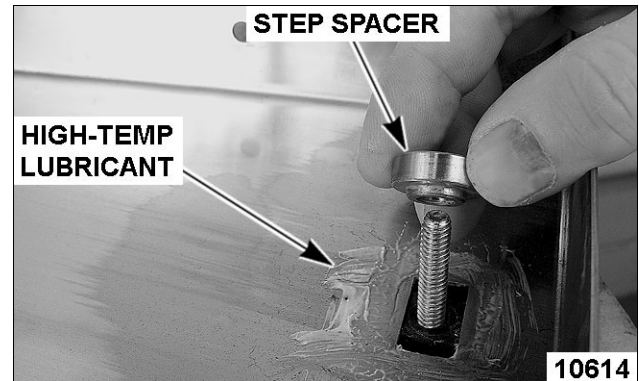

4. Install lock nuts and tighten until no gap exists between handle, step spacer and lock nut. Do not over-tighten lock nuts.
5. Close inner door panel so that latch mechanism engages striker on front panel.
6. Install outer door housing onto inner door panel.
7. Align the top and bottom screw holes of outer door housing with inner door panel.

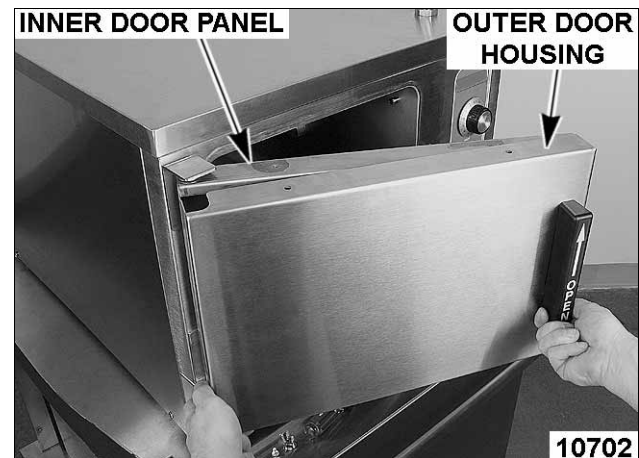

8. Apply Loctite 242 to threads of screws before assembling.
9. Install screws to secure door halves together.
10. Check opening and closing operation of door.

## LATCH ASSEMBLY

### Removal and Disassembly

1. Separate outer door housing assembly from inner door panel as outlined under DOOR HANDLE.
2. Remove screws securing latch assembly to inner door panel and remove latch mechanism.

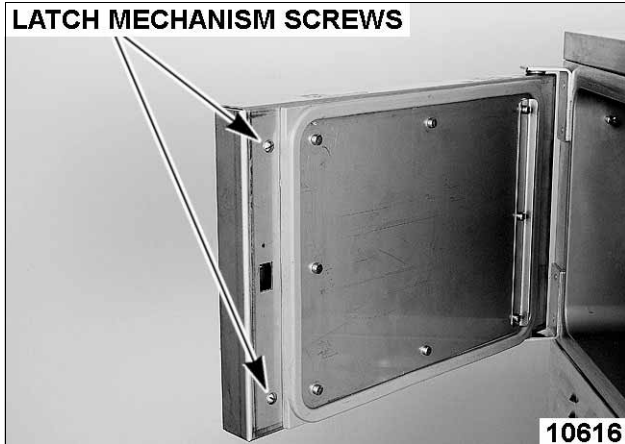

3. Remove E-clip from latch assembly pins and pull pins from latch mechanism.

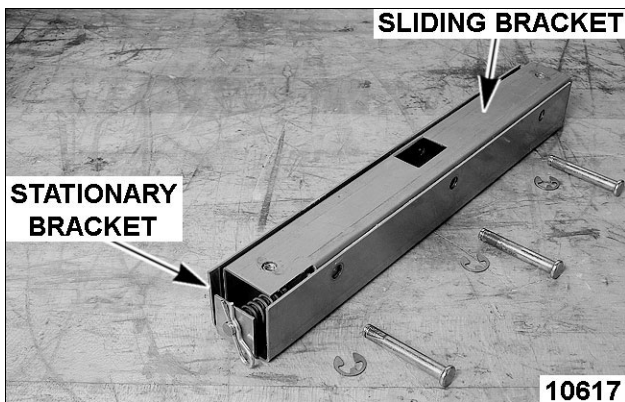

4. Remove retaining pin from spring pin.
5. Separate sliding bracket from stationary bracket.

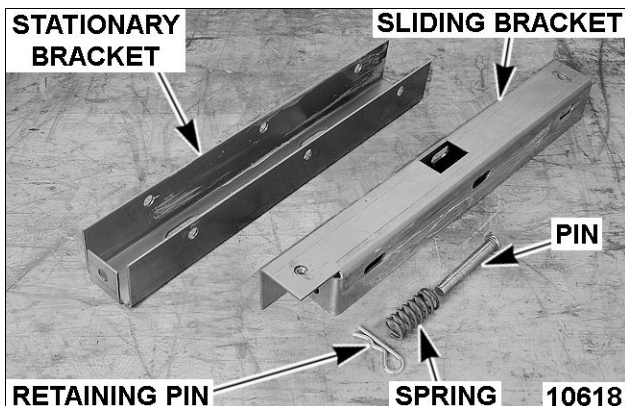

### Assembly

1. Apply Lubriplate 630AA to sides of sliding bracket.
2. Insert spring pin into bottom of sliding bracket.
  - A. Place spring over spring pin.
3. Assemble sliding bracket into stationary bracket.
4. While holding head of spring pin against bottom of sliding bracket, insert spring pin into keeper hole in bottom of stationary bracket.

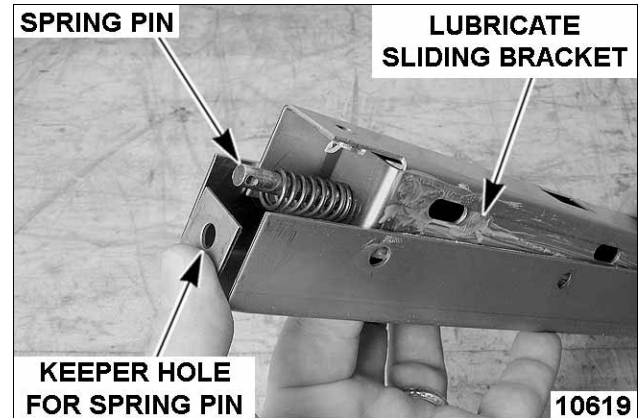

- A. Secure spring pin in place with retaining pin.

**NOTE:** Install pins such that heads of pins will be facing inward toward hinge side of inner door panel when latch assembly is installed.

5. Install pins to assemble stationary and sliding brackets together.
  - A. Secure pins into position with E-clip.

### Installation

1. Install latch assembly onto inner door panel with spring pin toward bottom of door panel.
  - A. Apply Loctite 271 to threads of screws before assembly and secure latch assembly to inner door panel.

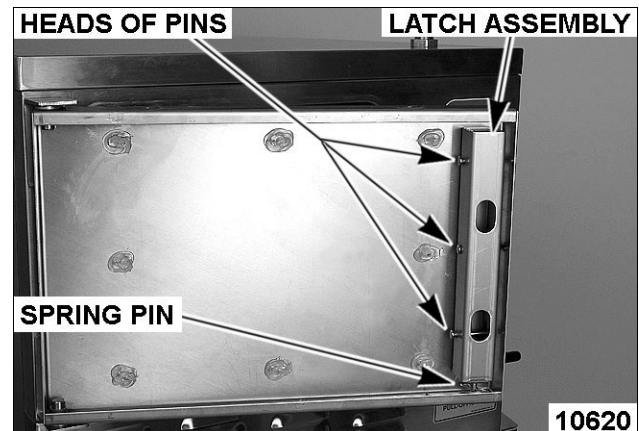

2. Install outer door housing assembly as outlined in DOOR HANDLE.
3. Check opening and closing operation of door.
4. Check steamer for proper operation and leaks around door seal.

## HINGE BEARINGS

1. Close door.
2. Remove LEFT SIDE PANEL as outlined in COVERS AND PANELS.
3. Remove nuts from upper hinge located inside front panel.

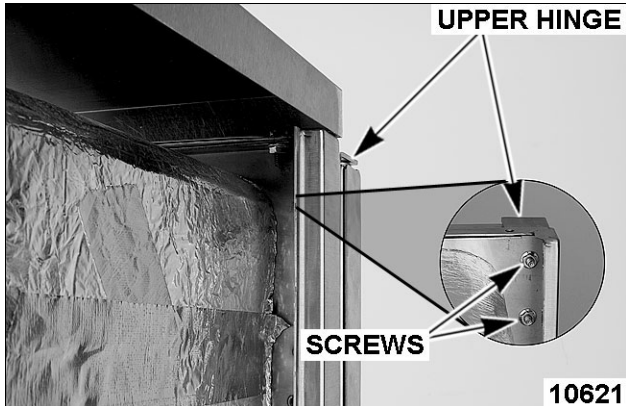

4. Open door slightly, and while holding door, pull upper hinge away from front panel.
5. Pull upper hinge out of upper door hinge bearing.
6. Lift door assembly up and off lower door hinge.
7. Pry hinge bearing out from door assembly.
8. Remove outer door housing.

**CAUTION:** Do not drive bearing into place. The inner door panel could be damaged. Press bearing into position.

**NOTE:** When replacing door hinge bearings, replace both hinge bearings.

9. Position replacement hinge bearing over hinge opening in door assembly.



- A. Press hinge bearing fully into door assembly using a C-clamp or equivalent.

10. Reassemble parts removed in reverse order.
11. Check door for fit and proper door gasket sealing.

## DOOR LATCH ADJUSTMENT

### Opening a Jammed Door

**CAUTION:** Should the steamer door jam and cannot be opened, **DO NOT FORCE OR PRY** the door as damage will occur.

1. Lift up on bottom of door at the handle end to disengage latch.
  - A. If door does not open, remove the right side panel as outlined in RIGHT AND LEFT SIDE PANELS.
  - B. Locate the striker that catches on door latch near steam chamber on front panel.

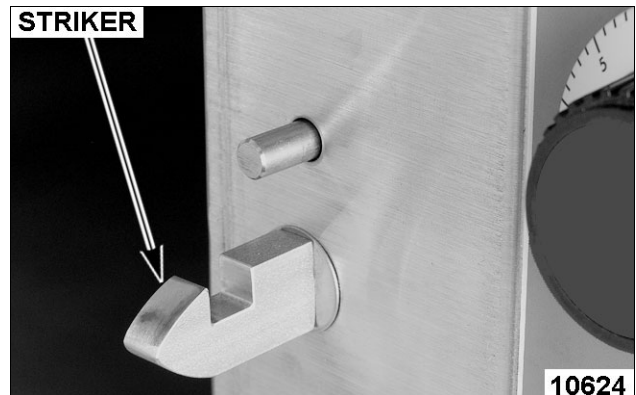

- C. Remove the nut from striker and this should release it from the panel.

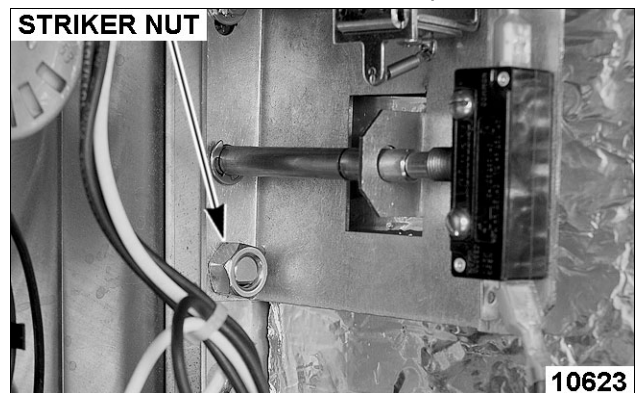

- D. Open door.
2. Remove striker.
3. Remove any burrs on striker that may cause latch to stick.
4. Apply Loctite 271 to threads of striker.
5. Reinstall striker with slotted side up. Snug striker nut. Perform Adjustment, so door will not jam.

**Adjustment**

1. Reinstall striker with slot pointing upward and hand tighten nut only.
2. Close door to center striker in front panel mounting hole.
3. Open door and check striker slot for horizontal alignment. The slot on striker must be kept horizontal in order for door latch to catch properly and latch.

4. Once proper slot alignment has been set, hold striker close to its base then tighten the striker nut. Be careful not to damage striker slot when tightening or door may not latch properly.

**NOTE:** Do not over-tighten nut. If over-tightened, striker may turn and change alignment.

**NOTE:** If door does not open easily, add shims between striker and cabinet front. When adding shims make certain that door gasket seals properly and steamer does not leak. Remove shims as necessary until leaking stops.

## DRAIN BOX



**WARNING:** DISCONNECT THE ELECTRICAL POWER TO THE MACHINE AND FOLLOW LOCKOUT / TAGOUT PROCEDURES.

### REMOVAL AND REPLACEMENT

1. Turn off machine to drain steam generator tank. Allow steamer to complete drain cycle.
  - A. Turn off water supply.
2. Disconnect the drain plumbing from drain box outlet fitting.
3. Remove the RIGHT AND LEFT SIDE PANELS as outlined in COVERS AND PANELS.

**NOTE:** Use plumbing sealant when reinstalling condensate thermostat.

4. Disconnect the condensate thermostat electrical wiring.
  - A. Remove the condensate thermostat from drain box.
5. Disconnect the cooling solenoid and cooking compartment drain hoses.

6. Disconnect the steam generator drain hose.

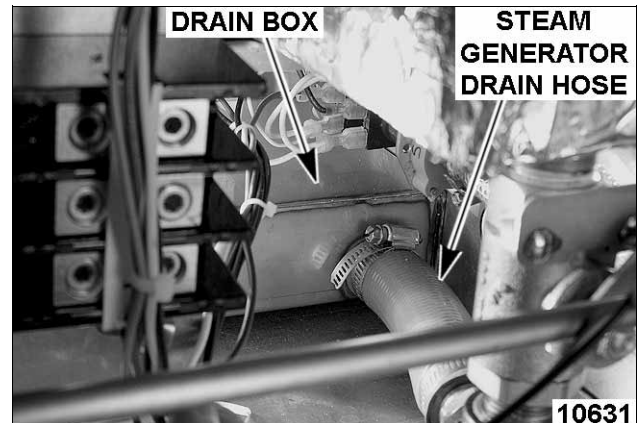

CLOSE-UP FROM RIGHT SIDE OF STEAMER

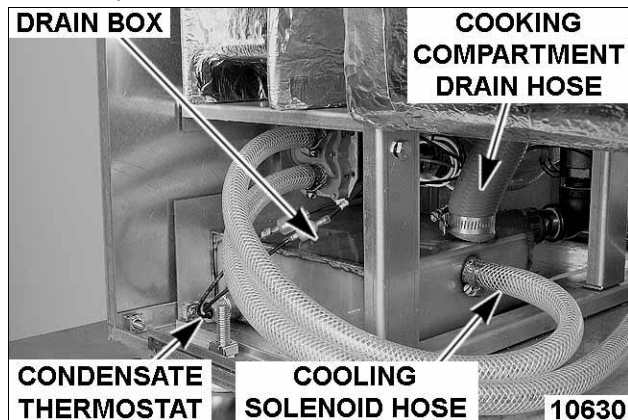

**NOTE:** The steam generator drain hose is accessed from right side of machine.

7. Remove the nuts securing drain box to back plate at rear of steamer.

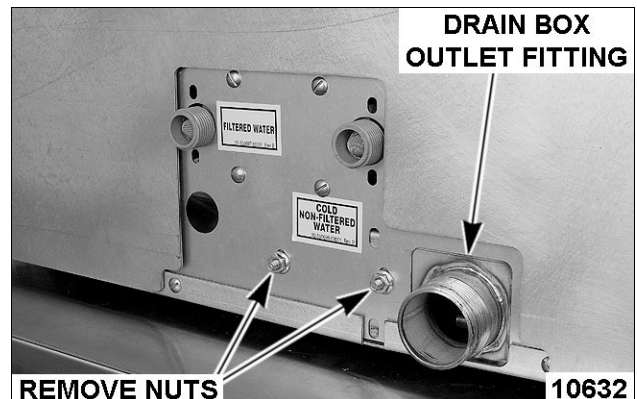

8. Remove drain box from steamer.
9. Reassemble parts removed in reverse order.
10. Check steamer for proper operation and leaks around condensate thermostat and hose connection points.

# COOKING COMPARTMENT



**WARNING:** DISCONNECT THE ELECTRICAL POWER TO THE MACHINE AND FOLLOW LOCKOUT / TAGOUT PROCEDURES.

## REMOVAL AND REPLACEMENT

**NOTE:** The cooking compartment and front panel are constructed as an assembly and cannot be separated.

1. Turn off machine to drain steam generator tank. Allow steamer to complete drain cycle.
  - A. Turn off water supply.
2. Remove the RIGHT AND LEFT SIDE PANELS and TOP COVER as outlined in COVERS AND PANELS.
3. Remove the DOOR as outlined in HINGE BUSHING.
  - A. Remove both hinges.
4. Remove the timer, indicator light, on/off switch (Professional models only), striker and door switch assembly.

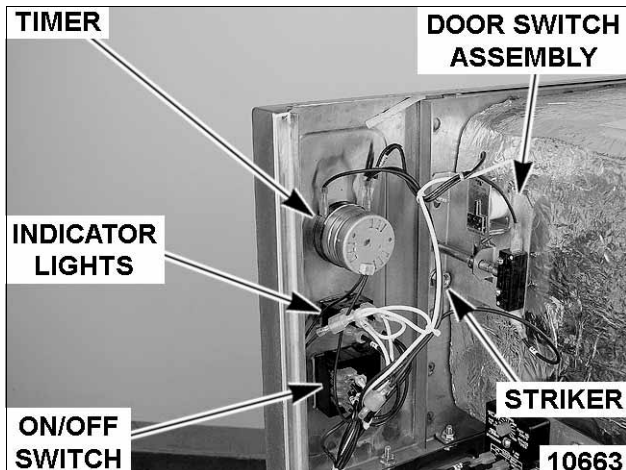

PROFESSIONAL MODEL SHOWN

5. Remove the vacuum breaker and hose as an assembly.
6. Disconnect steam inlet hose from the steam inlet port.
  - A. Remove the steam inlet port.

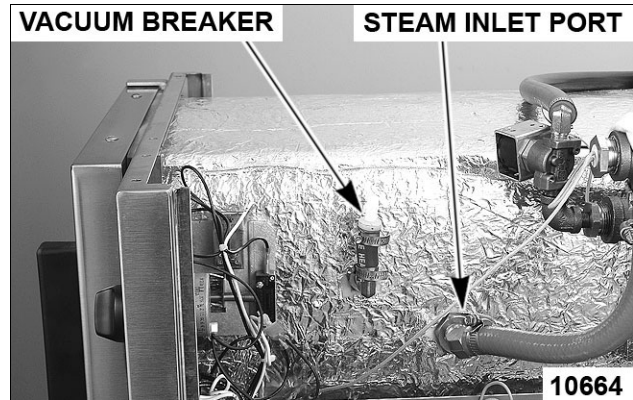

7. Disconnect the drain hose from rear of cooking compartment.

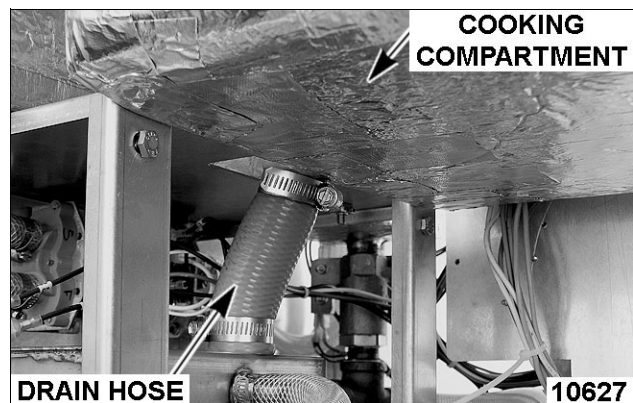

**NOTE:** Screws are located on either side of cooking compartment securing front panel to lower louvered panel.

8. Remove the screws securing front panel to lower louvered panel.

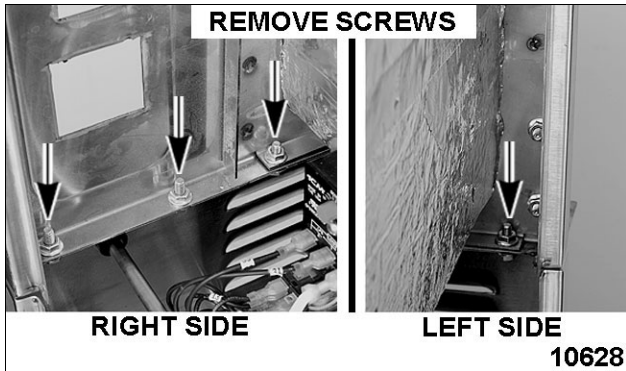

9. Remove the nuts securing rear of cooking compartment to the vertical mounting brackets (four places - located between cooking compartment and steam generator).

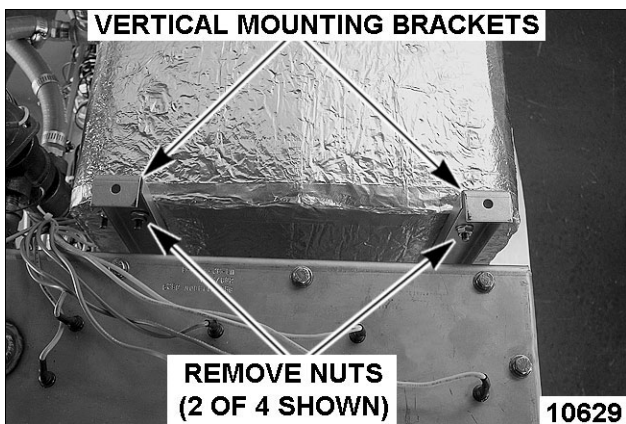

10. Remove cooking compartment assembly.
11. If removed or replacing cooking compartment, install insulation around cooking compartment. Secure insulation into position using high temperature aluminum foil tape.
12. Reinstall parts removed in reverse order.
13. Check DOOR LATCH ADJUSTMENT.

# THERMOSTATS

## HOLD THERMOSTAT



**WARNING:** DISCONNECT THE ELECTRICAL POWER TO THE MACHINE AND FOLLOW LOCKOUT / TAGOUT PROCEDURES.

1. Turn off machine to drain steam generator tank. Allow steamer to complete drain cycle.
  - A. Turn off water supply.
2. Remove RIGHT SIDE PANEL as outlined under COVERS AND PANELS.
3. Disconnect electrical lead wires from hold thermostat.
4. Remove hold thermostat from steam generator tank.

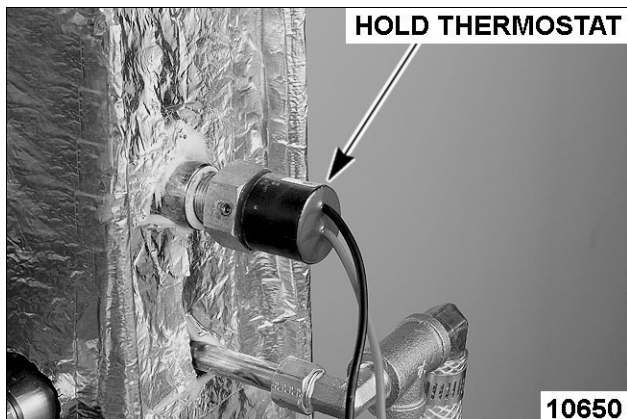

**NOTE:** Apply Loctite 565 to threads of hold thermostat before assembly.

5. Reassemble parts removed in reverse order of removal.
6. Check steamer for proper operation and leaks around hold thermostat.

## HIGH-LIMIT THERMOSTAT



**WARNING:** DISCONNECT THE ELECTRICAL POWER TO THE MACHINE AND FOLLOW LOCKOUT / TAGOUT PROCEDURES.

### Removal

1. Turn off machine to drain steam generator tank. Allow steamer to complete drain cycle.
  - A. Turn off water supply.

2. Remove RIGHT SIDE PANEL and TOP COVER as outlined under COVERS AND PANELS.
3. Remove HEATING ELEMENT.
4. Loosen hose clamp securing capillary bulb to top of heating element.
5. Fully loosen the small capillary tube compression nut and slide it away from heating element.
6. Remove large capillary nut from heater base plate and slide it away from heating element.

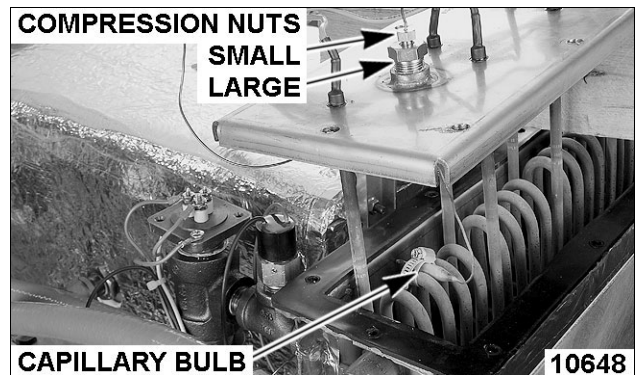

7. Remove capillary tube from heating element.
8. Disconnect electrical wiring to high-limit thermostat.
9. Remove high-limit thermostat from mounting bracket.

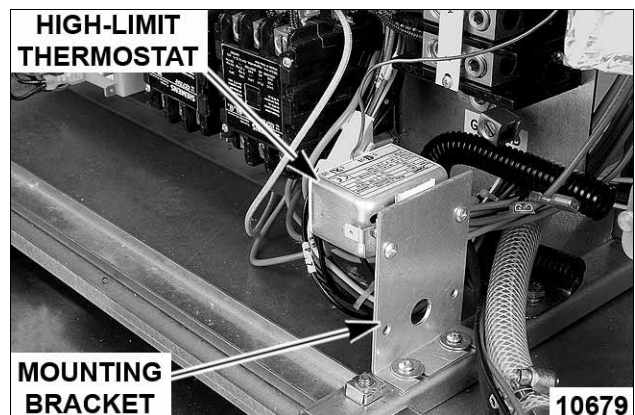

**Installation**

1. Insert capillary bulb through large compression nut.
  - A. Route capillary bulb through top of heating element.
  - B. Position capillary bulb between top of second and third heating element coils. Secure with hose clamp to second coil as shown.
2. Apply pipe thread sealant to threads of large capillary nut then install large compression nut.
  - A. Pull excess capillary tubing out of heating element through large nut. Route capillary tubing such that there are no sharp bends.
  - B. Tighten the small capillary compression nut into the large compression nut.

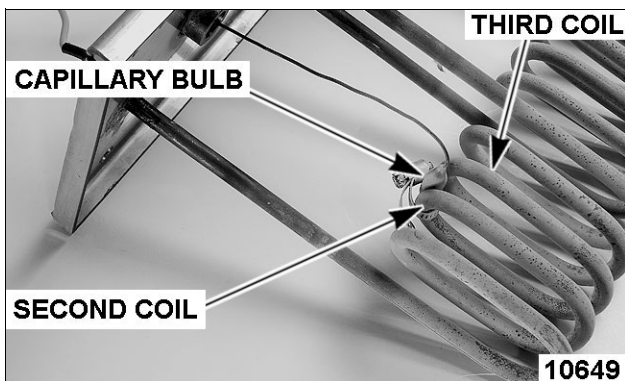

**NOTE:** Install a new gasket when reassembling steam generator tank. Temporarily secure gasket in place with RTV109.

3. Reinstall remaining parts removed in reverse order.
4. Torque heating element screws to 70 in\*lb following the heating element tightening sequence as found under HEATING ELEMENT.
5. Check steamer for proper operation and leaks around heating element gasket and high-limit thermostat.

**CONDENSATE THERMOSTAT**



**WARNING:** DISCONNECT THE ELECTRICAL POWER TO THE MACHINE AND FOLLOW LOCKOUT / TAGOUT PROCEDURES.

1. Turn off machine to drain steam generator tank. Allow steamer to complete drain cycle.
  - A. Turn off water supply.
2. Remove LEFT SIDE PANEL as outlined in COVERS AND PANELS.
3. Disconnect electrical wiring to condensate thermostat.

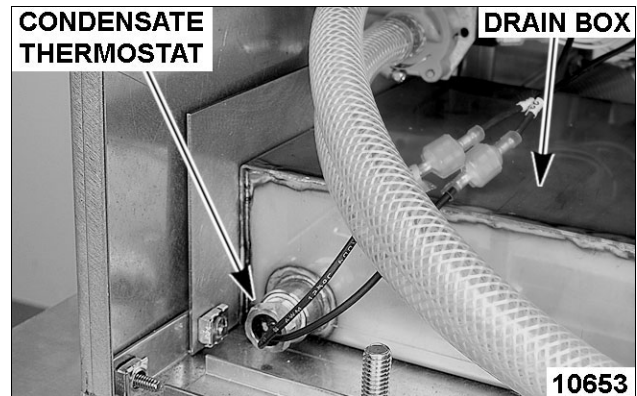

4. Remove condensate thermostat from drain box.
5. Reassemble parts removed in reverse order of removal. Make certain to apply Loctite 565 thread sealant to threads of thermostat before assembly.
6. Check steamer for proper operation and leaks around condensate thermostat.



# TIMER



**WARNING:** DISCONNECT THE ELECTRICAL POWER TO THE MACHINE AND FOLLOW LOCKOUT / TAGOUT PROCEDURES.

## REMOVAL AND REPLACEMENT

**NOTE:** The basic and professional model steamers use the same 60 minute timer. When the timer reaches zero, an external buzzer will sound and steam will stop entering the cooking compartment. The Professional steamer has extra components to utilize the constant steam setting allowing the steamer to operate continuously.

1. Remove RIGHT SIDE PANEL as outlined under COVERS AND PANELS.
2. Note electrical connections then disconnect wiring to timer.

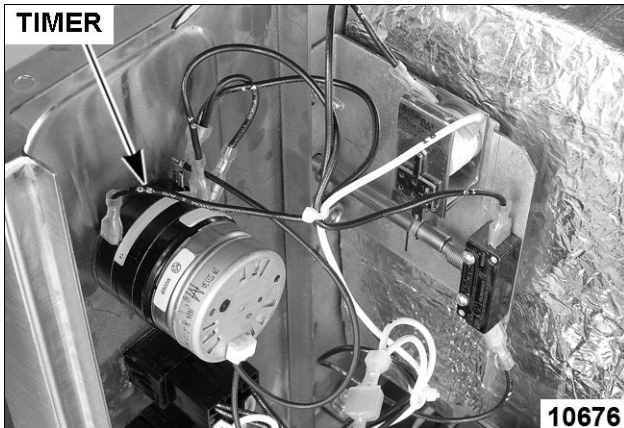

PROFESSIONAL MODEL SHOWN

3. Pull knob from timer shaft.
  - A. Remove rotary shaft seal from timer shaft then remove timer from front panel.
  - B. Inspect rotary shaft seal. Replace if damaged, worn or signs of moisture migration into control area around timer shaft is evident.

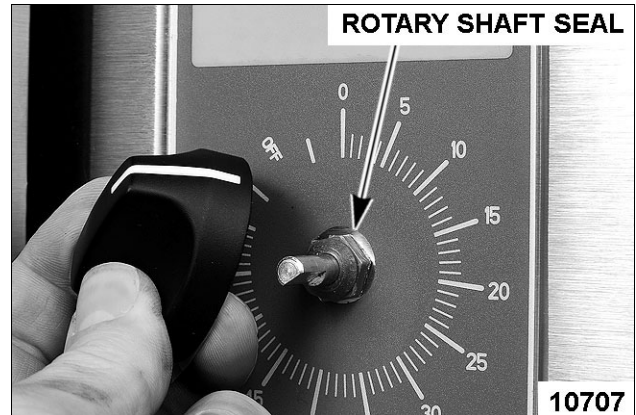

4. Reverse procedure to install.
5. Check steamer for proper operation.

# HEATING ELEMENT



**WARNING:** DISCONNECT THE ELECTRICAL POWER TO THE MACHINE AND FOLLOW LOCKOUT / TAGOUT PROCEDURES.

## REMOVAL AND REPLACEMENT

1. Turn off machine to drain steam generator tank. Allow steamer to complete drain cycle.
  - A. Turn off water supply.
2. Remove RIGHT SIDE PANEL and TOP COVER as outlined under COVERS AND PANELS.
3. Note heating element wire connection points then disconnect heating element lead wires from contactors.

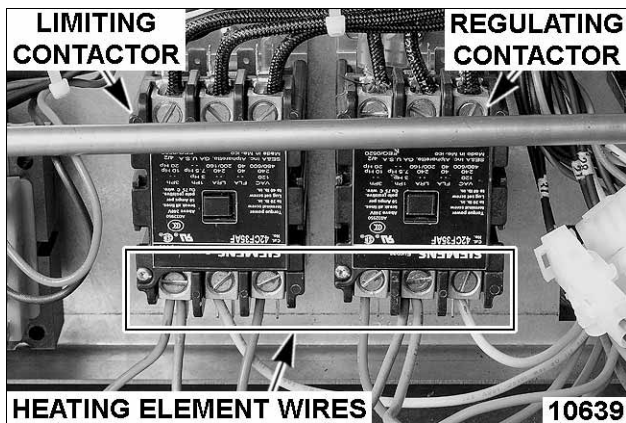

BASIC MODEL SHOWN

4. Carefully position high-limit thermostat capillary tube to facilitate heating element removal. Avoid creating sharp bends or kinks in the capillary tube.
5. Remove screws and lock washers securing heating element to tank.

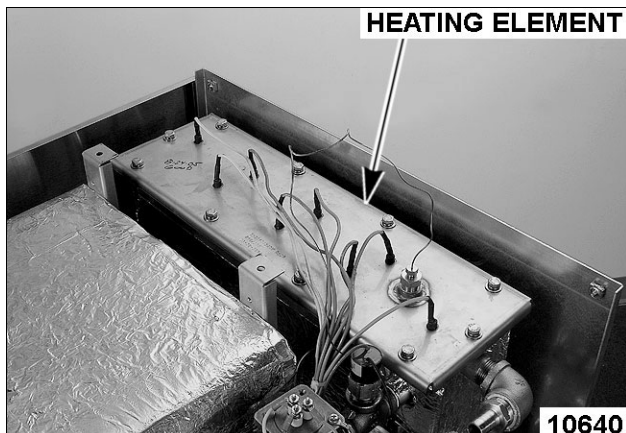

6. Pull heating element out of steam generator tank.
7. Note mounting position of high-limit thermostat bulb then remove bulb from heating element.
  - A. Remove high-limit capillary tube compression fitting and remove high-limit capillary and bulb from heating element.

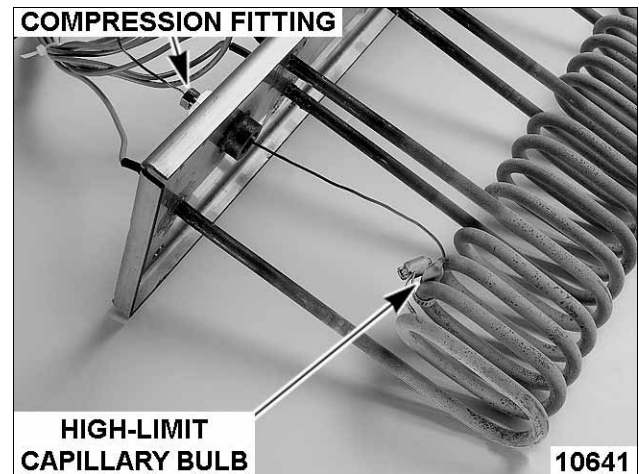

**NOTE:** Install a new gasket when reassembling steam generator tank. Temporarily secure gasket in place with RTV109.

8. Remove gasket from steam generator tank.
  - A. Clean remaining sealant from top lip of steam generator tank.

**NOTE:** Refer to HIGH-LIMIT THERMOSTAT for proper placement of capillary bulb.

9. Reassemble parts removed in reverse order of removal. Tighten heating element screws evenly to 70 in\*lbs. Follow tightening sequence pattern as shown in illustration.

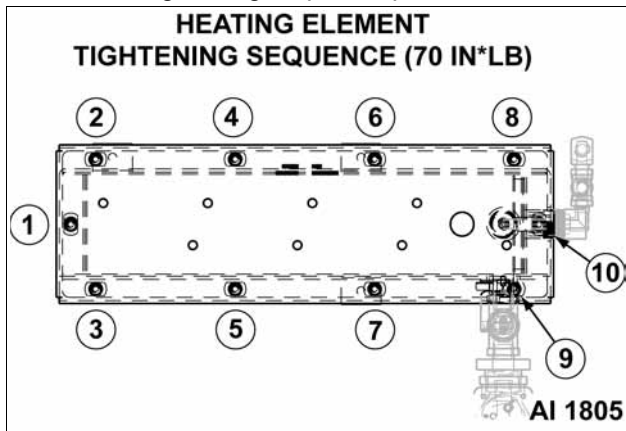

OVERHEAD VIEW OF HEATING ELEMENT

10. Check steamer for proper operation and leaks around heating element.

### DIAGNOSTIC CHECKS

**WARNING:** CERTAIN PROCEDURES IN THIS SECTION REQUIRE ELECTRICAL TEST OR MEASUREMENTS WHILE POWER IS APPLIED TO THE MACHINE. EXERCISE EXTREME CAUTION AT ALL TIMES. IF TEST POINTS ARE NOT EASILY ACCESSIBLE, DISCONNECT POWER AND FOLLOW LOCKOUT / TAGOUT PROCEDURES, ATTACH TEST EQUIPMENT AND REAPPLY POWER TO TEST.

1. Check voltage across heating element wires at limiting and regulating contactor terminals.
  - A. If voltage is correct, check current draw (step 2).
  - B. If voltage is not correct, check the following:
    - 1) Voltage supply to steamer.
    - 2) Fuses or breaker blown.
    - 3) Power to contactor coils.
    - 4) Contactors not pulling in. (Mechanical)
2. Check current draw (amps) through heating element lead wires using an amp clamp meter.
  - A. If current is correct, then heating element is ok.
  - B. If current is not correct, check element resistance (step 3).
3. Remove one lead wire of each heating element from the regulating contactor and check the individual element resistance using a VOM.
  - A. If resistance readings are not correct, replace heating element.

MODEL	VOLTAGE	TOTAL kW	CURRENT PER ELEMENT	RESISTANCE PER ELEMENT (OHMS)
3 Pan	208 <sup>1</sup>	8.5	10.2	20.4
	240 <sup>2</sup>	8.5	11.8	20.4
	480Y/277 <sup>3</sup>	8.5	10.2	27.1
5 Pan	208	15	18.0	11.5
	240	15	20.8	11.5
	480Y/277 <sup>3</sup>	15	18.1	15.3

<sup>1</sup> Four elements used.

<sup>2</sup> Three elements used.

<sup>3</sup> Elements of 480V machines are connected in Wye configuration for 277V across each element.

**NOTE:** Values in table are nominal. Tolerance is ±10 %.

4. Check steamer for proper operation.

# SUPER HEATER



**WARNING:** DISCONNECT THE ELECTRICAL POWER TO THE MACHINE AND FOLLOW LOCKOUT / TAGOUT PROCEDURES.

## REMOVAL AND REPLACEMENT

1. Turn off machine to drain steam generator tank. Allow steamer to complete drain cycle.
  - A. Turn off water supply.
2. Remove RIGHT SIDE PANEL as outlined under COVERS AND PANELS.
3. Note super heater wiring connection points then disconnect heating element lead wires from the relay (K4) and the regulating contactor.

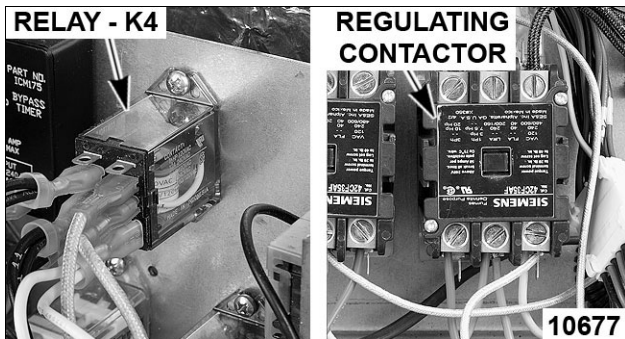

4. Peel back insulation from head of heater element.
5. Remove super heater element from insulated piping assembly.

**NOTE:** Top cover removed for clarity. Removal of top cover is not necessary to service super heater.

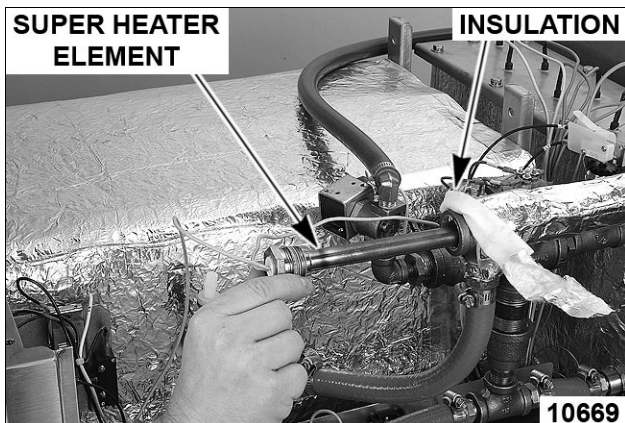

6. Reassemble parts removed in reverse order of removal.
  - A. Apply pipe thread sealant to threads of super heater element before assembly.

- B. Tape insulation around head of heater element using high-temperature aluminum foil tape.
7. Check to make sure insulated piping assembly is horizontal or element head end of assembly is slightly elevated.

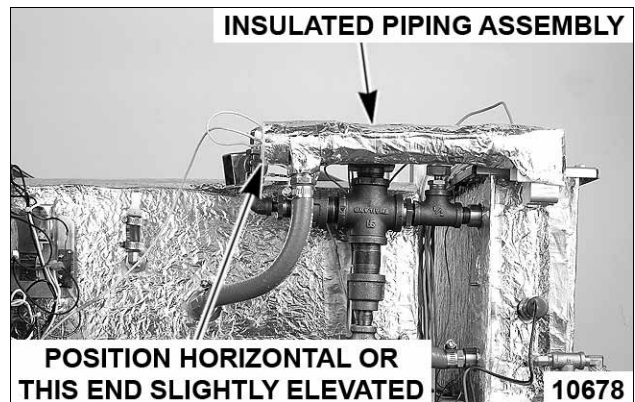

8. Check steamer for proper operation and leaks around super heater.
9. Reinstall panels and top cover.

## DIAGNOSTIC CHECKS

**WARNING:** CERTAIN PROCEDURES IN THIS SECTION REQUIRE ELECTRICAL TEST OR MEASUREMENTS WHILE POWER IS APPLIED TO THE MACHINE. EXERCISE EXTREME CAUTION AT ALL TIMES. IF TEST POINTS ARE NOT EASILY ACCESSIBLE, DISCONNECT POWER AND FOLLOW LOCKOUT / TAGOUT PROCEDURES, ATTACH TEST EQUIPMENT AND REAPPLY POWER TO TEST.

1. Check voltage across super heater wires at limiting and regulating contactor terminals.
  - A. If voltage is correct, check current draw (step 2).
  - B. If voltage is not correct, check the following:
    - 1) Voltage supply to steamer.
    - 2) Fuses or breaker open.
    - 3) Relay K4.
    - 4) Power to contactor coils.
    - 5) Contactors not pulling in. (Mechanical)
2. Check current draw (amps) through super heater lead wires using an amp clamp meter.
  - A. If current is correct, then super heater is ok.
  - B. If current is not correct, check resistance (step 3).
3. Remove one of the super heater lead wires from the regulating contactor and check resistance using a VOM.
  - A. If resistance is not correct, replace super heater.

VOLTAGE	TOTAL kW	CURRENT	RESISTANCE (OHMS)
208/240	0.75	3.1	76.8
480Y/277 <sup>1</sup>	0.75	2.7	102.3

<sup>1</sup> Elements of 480V machines are connected in Wye configuration for 277V across super heater.

**NOTE:** Values in table are nominal. Tolerance is  $\pm 10\%$ .

4. Check steamer for proper operation.

# WATER LEVEL CONTROL COMPONENTS

## WATER LEVEL CONTROLS

### Low Level Cut-Off & Differential Control

The steamer is equipped with three water level sensing probes (high, low and low level cut-off) and a water level control board. The water level control board performs two functions: 1) Provide low level cut-off protection to shut off the heat source in case the water level drops below the low level cut-off (LLCO) probe. 2) Perform as a differential level control to maintain the water level between the low and high water level probes.

The water level control (WLC) board has input voltage (120VAC) across terminals 11 and 12 which powers the primary side of the transformer. On one side of the transformer secondary, power is provided to the control by a series path through chassis ground (terminal 10). The other side of the transformer secondary (12VAC) is attached to the probe that directs power to the other side of WLC board relay coils (LLCO and HL) and to the inverse latching relay (ILR) electronic circuit on the WLC board. As water enters the generator, it becomes part of the WLC board circuit. When the water level in the generator reaches a probe, that circuit is completed.

The inverse latching relay of the WLC board is de-energized, leaving the ILR-1 (N.O.) and ILR-2 (N.C.) contacts in their shelf state.

When the main power switch is turned on, power is supplied to the WLC board which energizes the high level (HL) relay, closes HL-1 normally open contacts, and illuminates the HL relay LED. With the HL-1 contacts closed, the slow fill solenoid is energized and water begins filling the generator.

When the water level reaches the low level cut-off (LLCO) probe, the LLCO relay is energized and illuminates the LLCO LED. With the LLCO-1 contacts closed, the heat source can be energized provided the auxiliary control(s) in the heating circuit are satisfied. The LLCO relay will remain energized and its LED will stay lit until the water level in the generator drops below the LLCO probe.

When the water level reaches the low level (LL) probe, power to terminal 2 on the WLC board is present but no switching occurs.

After the water level reaches the high level (HL) probe, the inverse latching relay of the WLC board is energized and locked through the low level probe (LL) and ILR-1 contacts. With ILR-2 contacts open, HL relay is de-energized and the HL LED goes out. With the HL-1 contacts open, the slow fill solenoid is de-energized, stopping the flow of water into the generator.

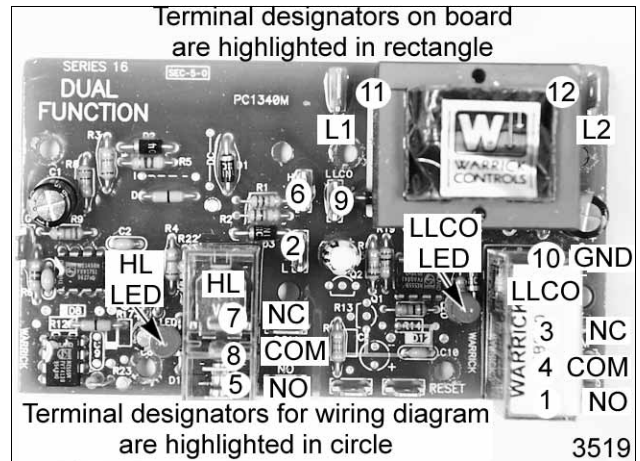

When the water level drops below the low level (LL) probe, power is removed from the inverse latching relay, the HL relay energizes through ILR-2 and HL contacts change state. The slow fill solenoid is energized through HL-1 to refill the generator and the HL LED is lit. The HL relay and LED will toggle on and off during a cooking cycle as needed.

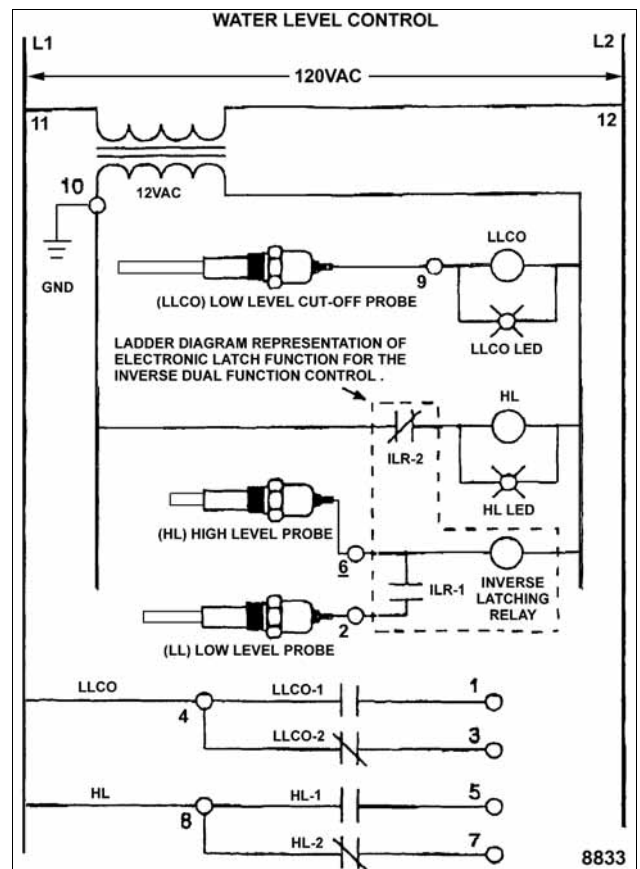

## WATER LEVEL CONTROL BOARD



**WARNING:** DISCONNECT THE ELECTRICAL POWER TO THE MACHINE AND FOLLOW LOCKOUT / TAGOUT PROCEDURES.

**CAUTION:** Certain components in this system are subject to damage by electrostatic discharge during field repairs. A field service grounding kit is available to prevent damage. The field service grounding kit must be used anytime the control board is handled.

1. Remove RIGHT SIDE PANEL as outlined under COVERS AND PANELS.
2. Squeeze tab on plastic standoff to release circuit board from standoff. Water level control board is secured with pins in five locations.

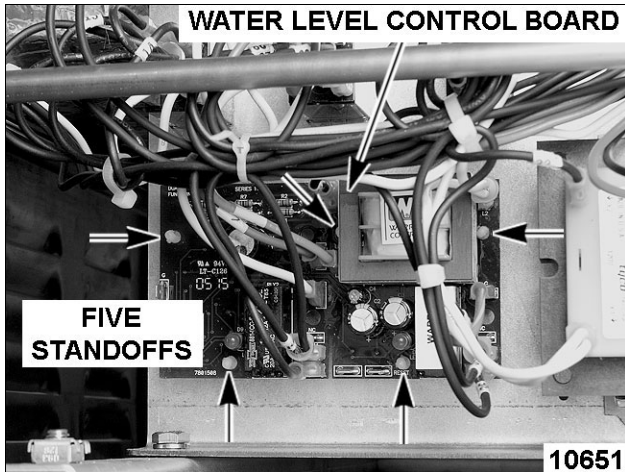

3. Note electrical wiring connection points then disconnect lead wires from water level control board (WLC). Refer to the machine wiring diagram when installing water level control board.
4. Reassemble parts and wiring removed in reverse order of removal.
5. Check steamer for proper operation.

## WATER LEVEL PROBES



**WARNING:** DISCONNECT THE ELECTRICAL POWER TO THE MACHINE AND FOLLOW LOCKOUT / TAGOUT PROCEDURES.

1. Remove RIGHT SIDE PANEL and TOP COVER as outlined under COVERS AND PANELS.
2. Note locations of electrical wiring and disconnect lead wires to water level probes.

WATER LEVEL PROBE ELECTRICAL CONNECTIONS		
Water Level Controller	Wiring	Water Level Probe
H	# 5 A - Blue	HL - High Level Probe
L	# 6 B - Yellow	LL - Low Level Probe
LLCO	# 7 C - Red	LLCO - Low Level Cut Off
G	# 8 - Green	Ground

A. Disconnect ground wire.

3. Remove probe assembly from piping assembly.

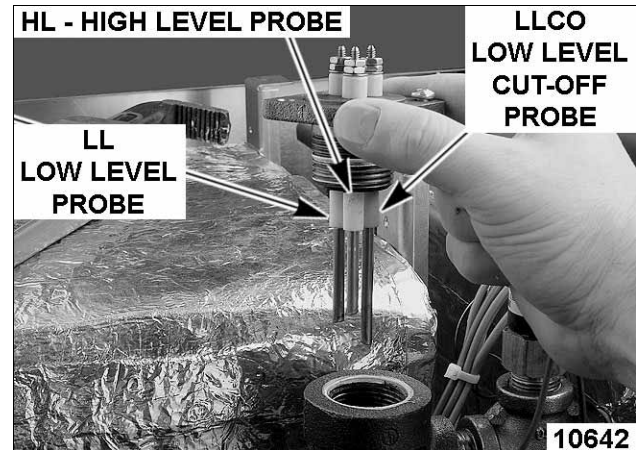

**NOTE:** Probes should be cleaned thoroughly. Remove all accumulated deposits from insulator using a soft cloth. Do not use anything abrasive on insulators. If probes are dirty, delime steam generator tank after assembling.

**NOTE:** Apply Loctite 565 to threads of probe assembly before installation.

4. Reverse procedure to install.
  - A. Set spacing between probe assembly flange and reducing Tee between 0.490" to 0.550".

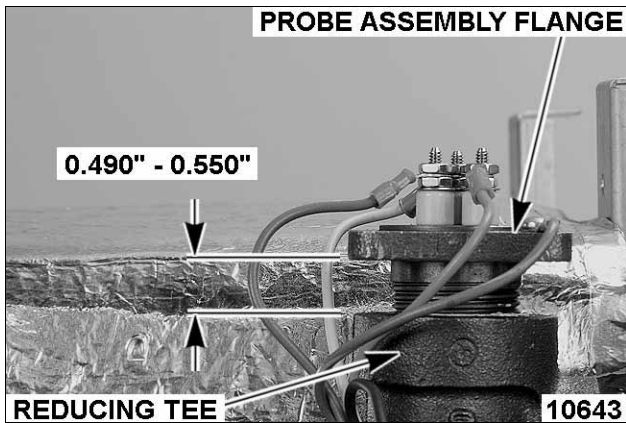

**NOTE:** Perform a steam generator tank cleaning as outlined under STEAM GENERATOR TANK - CLEANING.

### FILTERED AND NON-FILTERED WATER SOLENOID VALVES



**WARNING:** DISCONNECT THE ELECTRICAL POWER TO THE MACHINE AND FOLLOW LOCKOUT / TAGOUT PROCEDURES.

**NOTE:** The filtered and non-filtered water solenoid valves are constructed as dual water valve assemblies. To differentiate between the fast and slow fill valves, hold the dual water valve assembly with the inlet up and the outlets facing forward. The fast flow valve is the left valve and the slow flow valve is the right valve. The two dual assemblies used on the steamer have different flow rates and should not be interchanged.

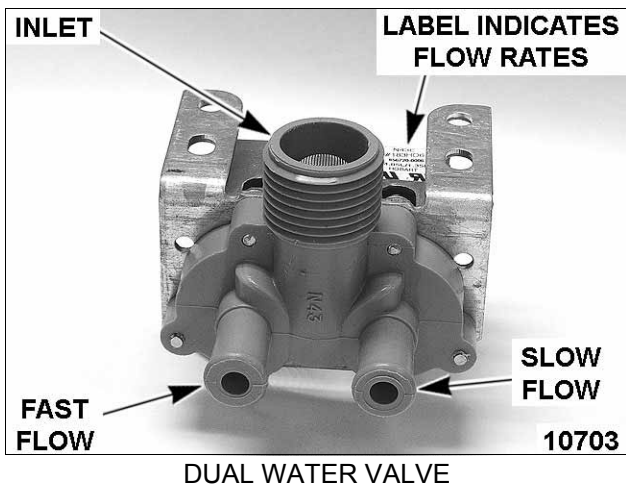

DUAL WATER VALVE FLOW RATES			
Valve Type	Machine Type	Flow Rate (GPM)	
		Fast Flow Valve	Slow Flow Valve
Fill (Filtered Water)	3 & 5 Pan	4.8	0.15
Condensate (Non-Filtered Water)	3 - Pan	4.8	0.75
	5 - Pan	4.8	1.35

#### Filtered Water Solenoid Valve

- Turn off machine to drain steam generator tank. Allow steamer to complete drain cycle.
  - Turn off water supply.
- Disconnect the incoming filtered water hose to machine.
- Remove the REAR PANEL as outlined under COVERS AND PANELS.
- Remove the screws securing the solenoid valve to the back plate.

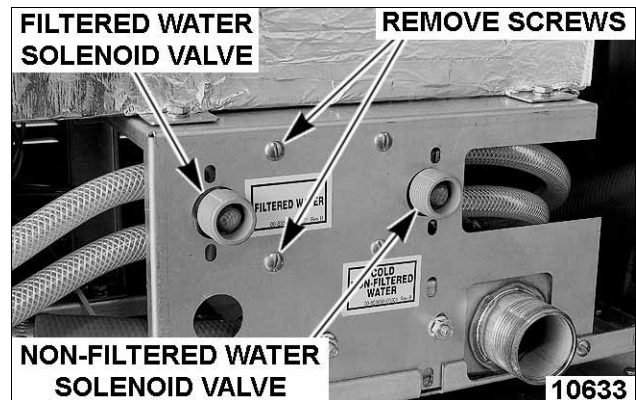

- Pull solenoid valve toward right side of machine enough to access electrical connections.
  - Note connection points of electrical wires then disconnect wires from solenoid valve.
  - Disconnect hoses from solenoid valve then remove solenoid valve from steamer.

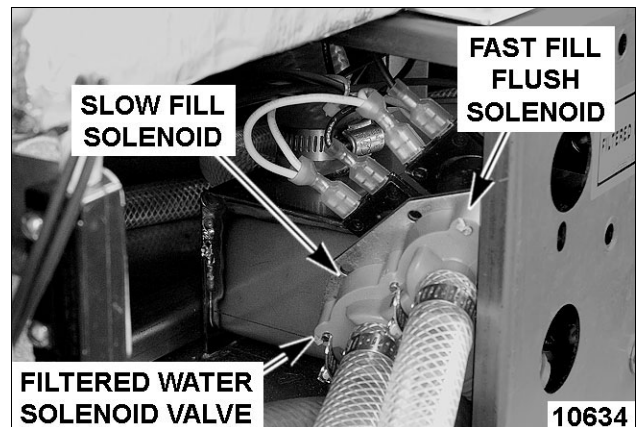



6. Reassemble parts removed in reverse order of removal.
7. Verify that the filtered water supply is connected to the input of the filtered water solenoid valve.
8. Check steamer for leaks and proper operation.

**Non-Filtered Cold Water Solenoid Valve**

1. Turn off machine to drain steam generator tank. Allow steamer to complete drain cycle.
  - A. Turn off water supply.
2. Disconnect incoming water hose to non-filtered cold water solenoid valve.
3. Remove LEFT SIDE PANEL as outlined in COVERS AND PANELS.
4. Note connection points of electrical connections then disconnect wiring from solenoid valve.

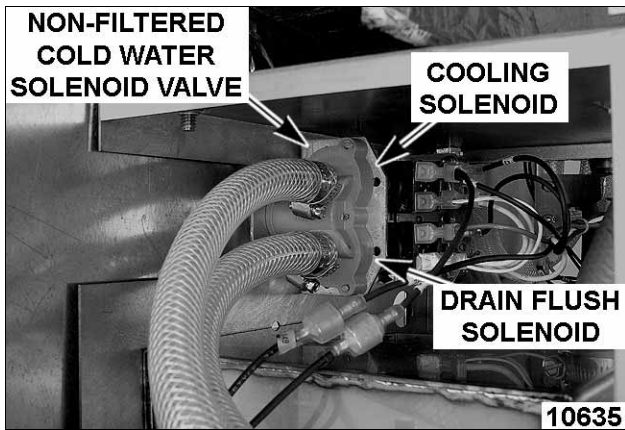

VIEW FROM LEFT SIDE OF STEAMER

5. Remove the screws securing non-filtered cold water solenoid valve to back plate.
6. Note hose connections to solenoid valve then disconnect hoses from valve.
  - A. Remove solenoid valve from steamer.
7. Reassemble parts removed in reverse order of removal.
  - A. Connect the outputs of the non-filtered water cooling solenoid to the drain box and Tee mounted to the drain valve under the steam generator.
8. Verify that the non-filtered water supply is connected to the input of the non-filtered water solenoid valve.
9. Check steamer for leaks and proper operation.

**MANUAL DRAIN VALVE (BASIC)**



**WARNING:** DISCONNECT THE ELECTRICAL POWER TO THE MACHINE AND FOLLOW LOCKOUT / TAGOUT PROCEDURES.

**Removal**

1. Pull out handle to turn off machine and drain steam generator tank. Allow steamer to complete drain cycle.
  - A. Turn off water supply.
2. Remove the RIGHT SIDE PANEL as outlined in COVERS AND PANELS. Rear panel can also be removed for added accessibility.
3. Remove the pin and disconnect the handle linkage from linkage bracket.

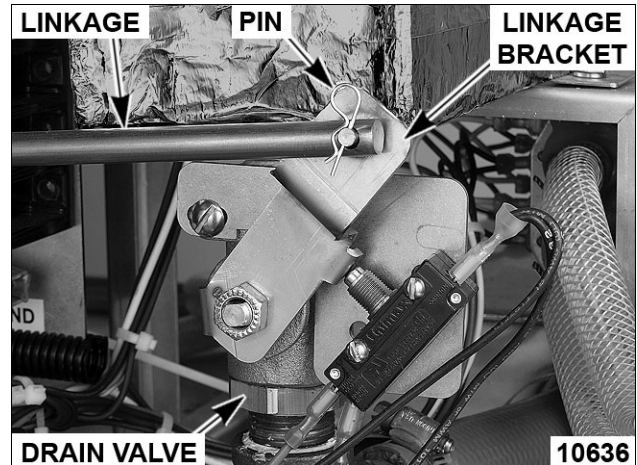

4. Remove the on/off switch and bracket as an assembly.
5. Disconnect the drain and drain flush hoses from the Tee located below the drain valve.

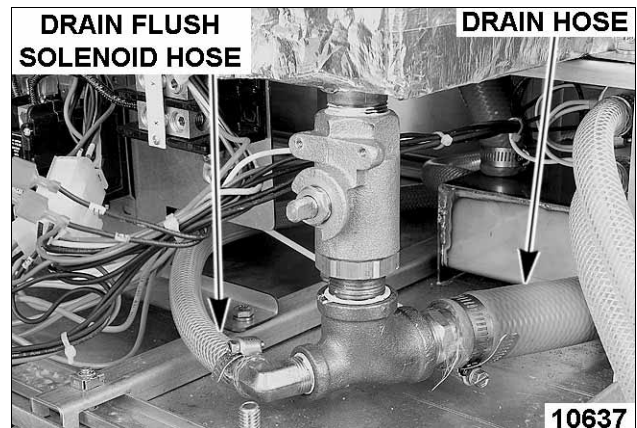

6. Remove the drain valve from the steam generator tank.

**NOTE:** Apply pipe thread sealant to plumbing threads before assembly.

7. Reassemble parts removed in reverse order of removal.
8. For Basic model steamers, perform ON/OFF SWITCH ADJUSTMENT as outlined in ON/OFF SWITCH.
9. Check steamer for leaks and proper operation.

## MOTORIZED DRAIN VALVE (PROFESSIONAL)



**WARNING:** DISCONNECT THE ELECTRICAL POWER TO THE MACHINE AND FOLLOW LOCKOUT / TAGOUT PROCEDURES.

1. Turn steamer off by using the on/off switch on the front panel of steamer.
  - A. Allow steamer to complete drain cycle.
  - B. If motorized drain valve has malfunctioned such that tank will not drain normally, refer to Drain Tank Manually for draining procedure.

### Drain Tank Manually

1. Turn off water supply to steamer.
2. Disconnect power to steamer allowing time for water in steam generator tank to cool to 140°F before attempting to manually open drain valve.
3. Remove the RIGHT SIDE PANEL as outlined in COVERS AND PANELS. Rear panel can also be removed for added accessibility.
4. Locate the motorized drain valve found at lower right side of steam generator tank.

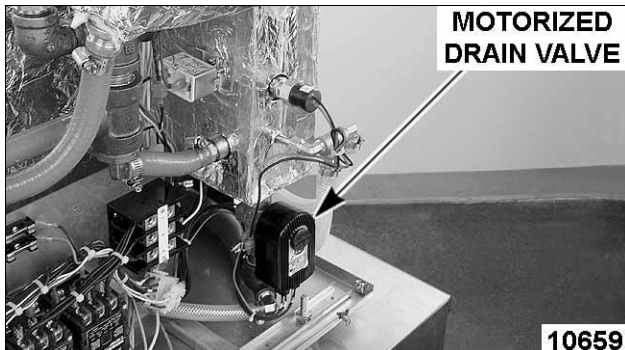

5. Push in on the manual drain override knob to disengage the gear set.

- A. Rotate knob CW to manually open the drain valve. Turning knob such that the slot in knob is in a vertical orientation indicates the drain valve is open. If slot in knob is in a horizontal orientation, the drain valve is closed.

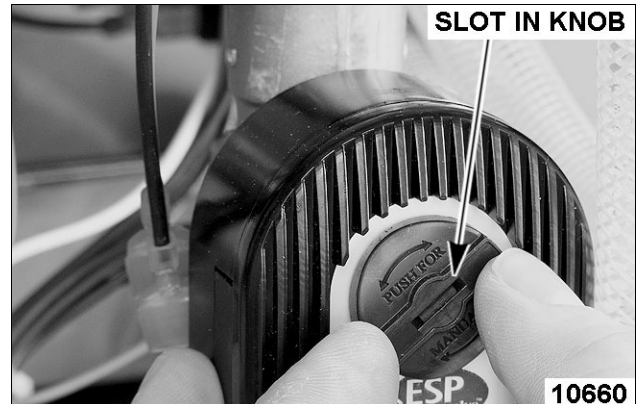

- B. Return manual drain override knob to the closed position (slot in horizontal position).

### Removal

1. Turn off water supply to steamer.
2. Remove the RIGHT SIDE PANEL as outlined in COVERS AND PANELS. Rear panel can also be removed for added accessibility.
3. Rotate body of motorized control assembly CCW approximately 1/8 turn to disengage assembly from drain valve.

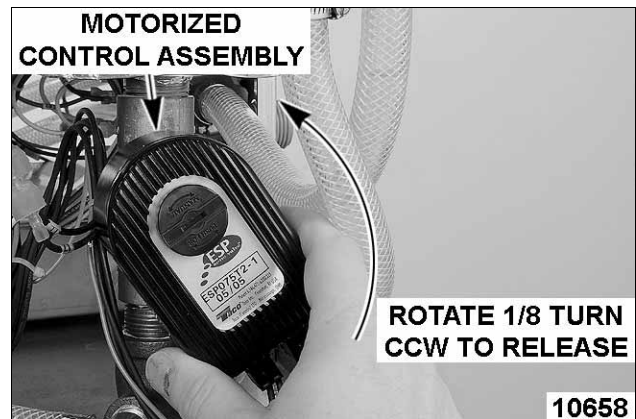

4. Remove the motorized control assembly.

**NOTE:** The two electrical plugs on the motorized control assembly are the same type connector. If the electrical wiring is not connected correctly, the motorized drain valve will not function.

- A. Note location of electrical connections then disconnect electrical wiring from motorized control assembly.

5. Disconnect the drain and drain flush hoses from the Tee located below the drain valve.

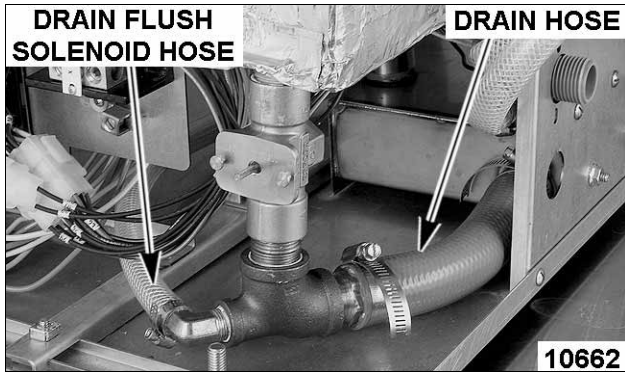

6. Remove the drain valve body from the steam generator tank.
7. Separate the Tee and nipple from the drain valve body.
8. Reassemble parts removed in reverse order. Apply liquid pipe thread sealant to threads of plumbing connections.

**NOTE:** If motorized drain valve is in the open position when power is applied to the steamer with the power switch on, drain valve will not close and fill water will flow through the generator into the drain.

9. Verify On/Off switch is in the off position and the motorized drain valve is closed before applying power to steamer.

**NOTE:** When power is applied and power switch is off steamer will enter a drain cycle.

10. Check steamer for proper operation and leaks around drain valve.

# SWITCHES, BUZZER AND SOLENOIDS

## ON/OFF SWITCH



**WARNING:** DISCONNECT THE ELECTRICAL POWER TO THE MACHINE AND FOLLOW LOCKOUT / TAGOUT PROCEDURES.

### Basic Models

1. Pull out on handle to turn steamer off and drain generator tank.
2. Remove the RIGHT SIDE PANEL.
3. Locate the on/off switch assembly mounted to the manual drain valve.

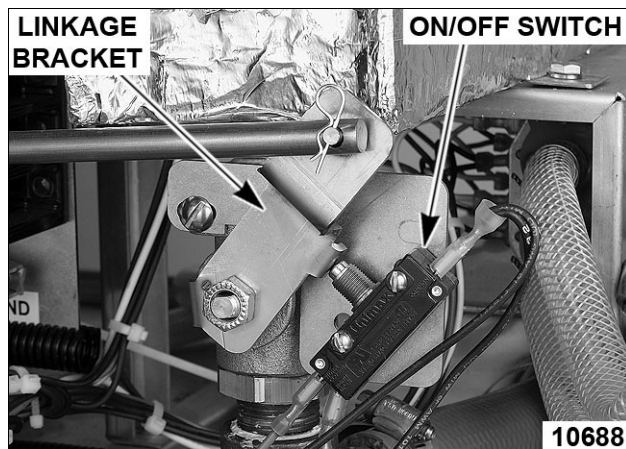

4. Note wiring locations and disconnect electrical wiring from switch.
5. Remove switch from switch mounting bracket. Retain hardware.
6. Loosely install switch onto switch mounting bracket.
7. Perform Basic Model On/Off Switch - Adjustment as outlined in this section.
8. Connect electrical wiring to switch.
9. Check steamer for proper operation.

### Basic Model On/Off Switch - Check Switch Actuation

**NOTE:** Handle must be pushed all the way in to avoid nuisance tripping.

1. Push handle in until switch contacts close. This can be checked with a meter set to measure resistance or continuity with meter probes across the COMMON and NORM OPEN terminals of switch.

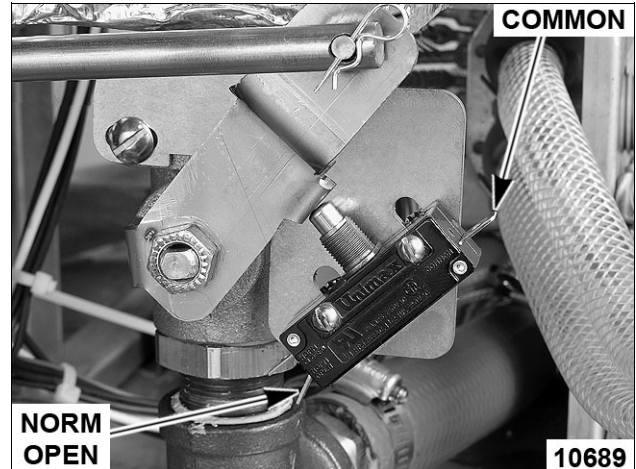

2. Continue pushing handle in until handle is at physical stop.
  - A. If switch plunger over-travel range is between 0.060" - 0.090" once switch N.O. contacts close, switch setting is correct.

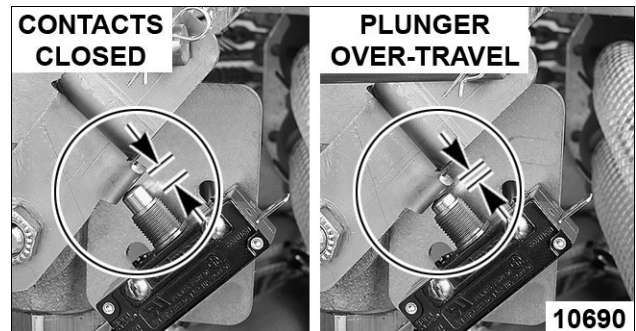

- B. If contacts did not close, or, there was no over-travel of switch plunger once contacts closed, switch position must be adjusted. Refer to Basic Model On/Off Switch - Adjustment for procedure.

### Basic Model On/Off Switch - Adjustment

1. Position switch mounting bracket on drain valve in middle of adjustment slot.
  - A. Tighten switch bracket to drain valve.

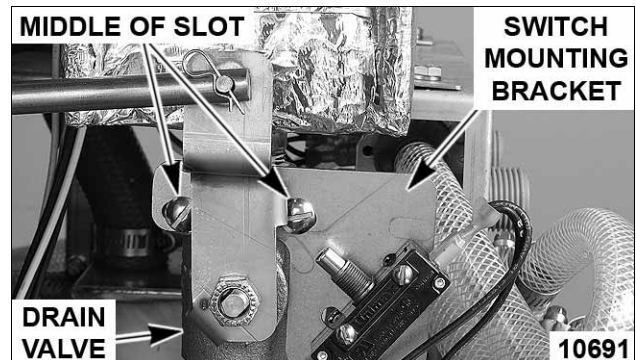

2. Loosen on/off switch mounting screws.

3. Push handle fully in and keep in position.
4. Position plunger of on/off switch against linkage bracket such that plunger is fully engaged.



A. Adjust switch such that switch plunger is perpendicular with linkage bracket when handle is pushed in fully.



B. Tighten switch mounting screws.

**Professional Models**

1. Remove the RIGHT SIDE PANEL.
2. Locate the on/off switch mounted to the front panel.

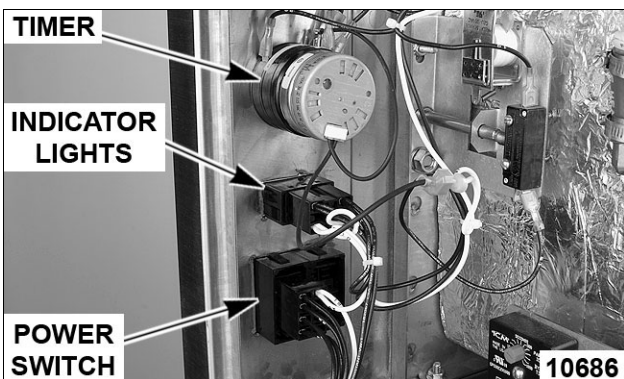

3. Disconnect electrical plug from switch.
4. Remove switch from front panel.
5. Reassemble parts removed in reverse order.

**DOOR SWITCH**



**WARNING:** DISCONNECT THE ELECTRICAL POWER TO THE MACHINE AND FOLLOW LOCKOUT / TAGOUT PROCEDURES.

**Removal**

1. Remove the RIGHT SIDE PANEL.
2. Open cooking compartment door.
3. Note wiring connections and disconnect electrical wiring from switch.

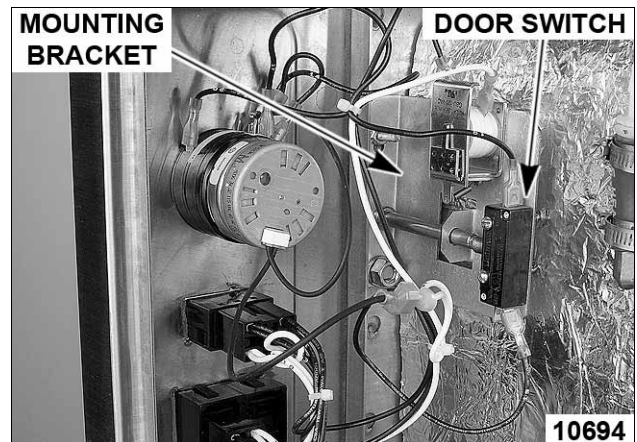

4. Remove switch from door switch mounting bracket. Retain hardware.

**Installation**

1. Verify E-clip is installed on door switch linkage in groove nearest front panel (if two grooves in linkage are present).

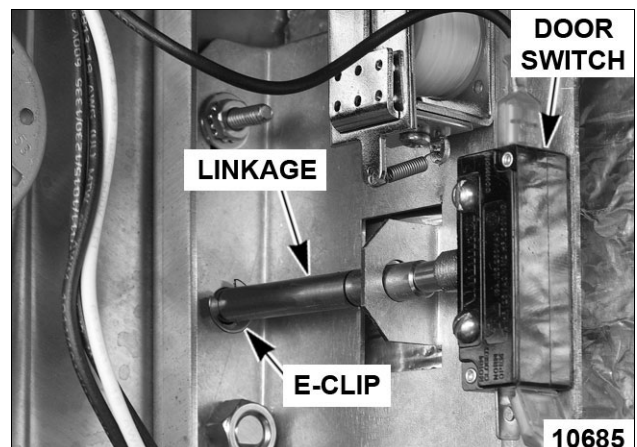

2. Loosely install door switch onto door switch mounting bracket.

- A. Close door.
  - B. Push switch up against switch linkage as far as possible.
  - C. Tighten switch mounting hardware.
3. Check door switch operation.
    - A. Set meter to measure resistance and place meter leads across the COMMON and NORM OPEN terminals of switch. With door closed, meter should indicate a closed circuit.
    - B. Open door. Meter should indicate an open circuit as door is opened.
  4. Check steamer for proper operation.
  5. Reinstall RIGHT SIDE PANEL.

## PRESSURE SWITCH



**WARNING:** DISCONNECT THE ELECTRICAL POWER TO THE MACHINE AND FOLLOW LOCKOUT / TAGOUT PROCEDURES.

**WARNING:** CERTAIN PROCEDURES IN THIS SECTION REQUIRE ELECTRICAL TEST OR MEASUREMENTS WHILE POWER IS APPLIED TO THE MACHINE. EXERCISE EXTREME CAUTION AT ALL TIMES. IF TEST POINTS ARE NOT EASILY ACCESSIBLE, DISCONNECT POWER AND FOLLOW LOCKOUT / TAGOUT PROCEDURES, ATTACH TEST EQUIPMENT AND REAPPLY POWER TO TEST.

### Removal

**NOTE:** For basic models, the pressure switch can be accessed by removing the right side panel. It is not necessary to remove the top cover.

1. Turn off machine to drain steam generator tank. Allow steamer to complete drain cycle.
  - A. Turn off water supply.
2. Remove RIGHT SIDE PANEL as outlined in COVERS AND PANELS. Locate pressure switch on top of water level probe piping assembly.
  - A. If servicing a Professional model, remove the TOP COVER as outlined in COVERS AND PANELS.

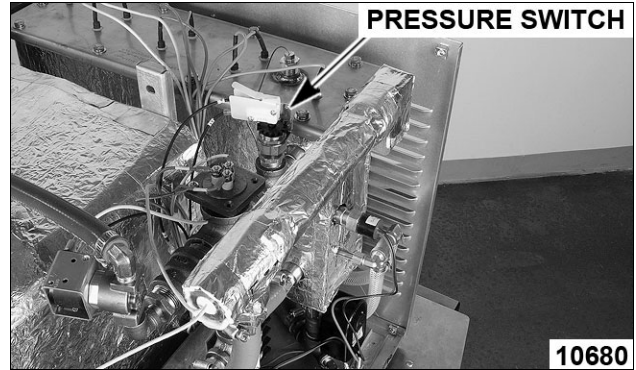

PROFESSIONAL MODEL SHOWN

3. Disconnect electrical wiring to pressure switch.
4. Remove pressure switch from piping.
5. Reassemble parts removed in reverse order.
  - A. Apply pipe thread sealant to threads of pressure switch before installation.
  - B. Verify mylar cover is in position covering electrical connections.



**NOTE:** Refinement of pressure switch cut out setting is found under Adjustment. Always check and adjust pressure switch setting whenever pressure switch is being serviced.

- C. If pressure switch is being replaced, make an initial pressure switch setting by aligning the top surface of adjustment wheel with the 5 psi reference scale mark on pressure switch.

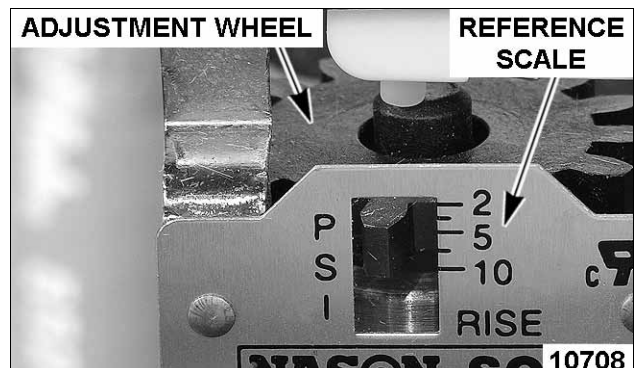

6. Perform pressure switch Check.

**Check**

**NOTE:** Pressure can be checked with the small air pocket that exists between the delime port cap and water level probe housing in the delime hose. Make certain that no leaks exist in generator tank or pressure gauge fittings.

1. Turn off machine to drain steam generator tank. Allow steamer to complete drain cycle.
  - A. Turn off water supply.
2. Remove RIGHT SIDE PANEL as outlined in COVERS AND PANELS.
3. Remove cap from delime port and install pressure gauge.

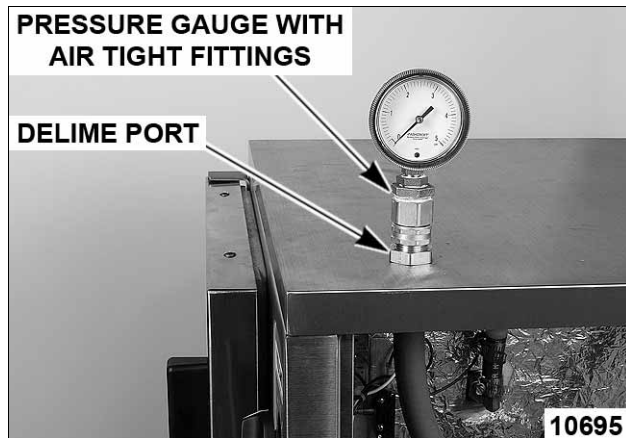

4. Close cooking compartment door.
5. Mark one tooth of pressure switch adjustment wheel to aid in identifying position of wheel. Make a second mark on body of pressure switch in alignment with mark on adjustment wheel.

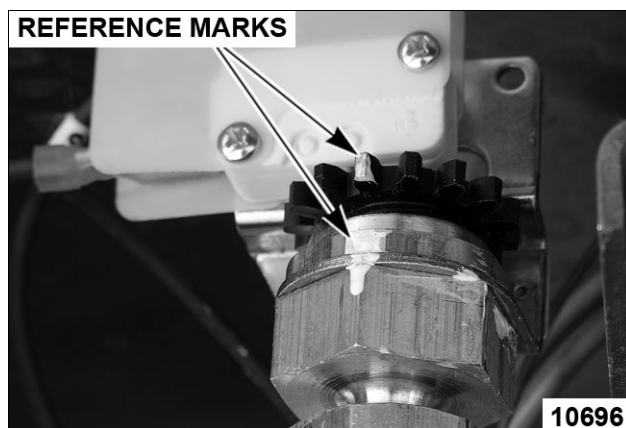

6. Turn steamer on.
  - A. Set timer for approximately 10 minutes.

- B. Wait for full steam production to stabilize. This is accomplished by allowing approximately five cycles of fill to occur once steam is being produced by the generator tank. Observe LED on water control board to count cycles.

**NOTE:** Operating pressures will vary slightly between machine being serviced and gauge used.

- C. Observe pressure gauge once steam begins to be generated. Gauge should level out at approximately 1.25 to 2.0 psi, but will oscillate with respect to fill water entering generator tank.



TYPICAL OPERATING PRESSURE

**NOTE:** If pressure should rise above 5.0 psi when performing check, release clamp. Pressure switch is out of tolerance and must be adjusted. Refer to Adjustment for procedure.

7. While observing pressure gauge, clamp steam outlet hose closed.
  - A. Listen for contactors to release indicating that pressure switch contacts have opened. Correct range for pressure switch cut out is between 4.5 to 4.7 psi.

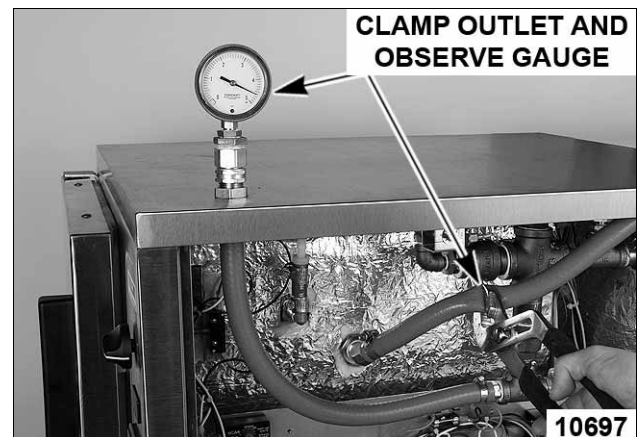

- B. Release clamp from steam outlet hose. Listen for switch contacts to close (contactors will energize).

- C. Repeat clamping of steam outlet hose a total of three times to find the average cut-out pressure. Record pressure.
- D. If pressure is outside tolerance (4.5 to 4.7 psi), adjustment is necessary. Refer to Adjustment.
- E. If cut-out pressure is within specifications, shut off steamer. Allow time for steamer to drain.

8. Remove test gauge and reinstall delime cap.

**Adjustment**

- 1. Allow full steam production to stabilize. This is accomplished by allowing approximately five cycles of fill to occur once steam is being produced by the generator tank. Observe LED on water control board to count cycles.

**NOTE:** Make small incremental adjustments (1/8 turn of toothed adjustment wheel) when adjusting cut-out pressure. Wear a heat resistant glove when working near hot surfaces such as when adjusting pressure switch.

- 2. Referring to cut-out pressure recorded in Check procedure, turn adjustment wheel to bring cut-out pressure into tolerance.
  - A. From looking down on pressure switch:
    - 1) Turn adjustment wheel CCW to decrease cut-out pressure.
    - 2) Turn adjustment wheel CW to increase cut-out pressure.

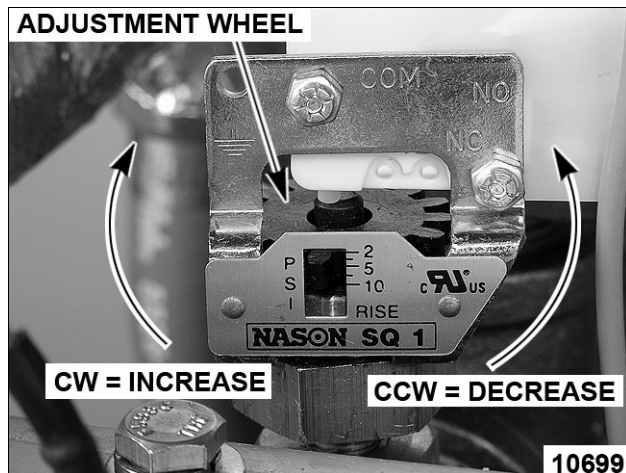

- B. Check cut-off pressure after making adjustment. Repeat Check and Adjustment as necessary until cut-out pressure is within 4.5 to 4.7 psi.

**VACUUM RELIEF SOLENOID**



**WARNING:** DISCONNECT THE ELECTRICAL POWER TO THE MACHINE AND FOLLOW LOCKOUT / TAGOUT PROCEDURES.

**NOTE:** The vacuum relief solenoid on Professional models is positioned with the solenoid coil toward the cooking chamber away from the super heater. For Basic models, the vacuum relief solenoid is positioned with the coil toward the right side of machine for easier serviceability.

- 1. Turn off machine to drain steam generator tank. Allow steamer to complete drain cycle.
  - A. Turn off water supply.
- 2. Remove RIGHT SIDE COVER as outlined in COVERS AND PANELS. Locate vacuum relief solenoid on top of water level probe piping assembly.



PROFESSIONAL MODEL SHOWN

- 3. Disconnect hose from solenoid valve.
- 4. Disconnect electrical wiring to solenoid coil.
- 5. Remove retaining clip securing coil to valve body then remove coil and wavy washer.

**CAUTION:** Do not force the super heater piping assembly out of position to make clearance for vacuum relief solenoid valve removal. Damage to generator tank weldment could occur.

**NOTE:** It may be necessary to turn the piping elbow that connects the vacuum relief solenoid to the water level piping assembly in order to clear the super heater piping assembly when removing the valve body.

- 6. Remove the valve body from piping assembly.
- 7. Reassemble parts removed in reverse order.



- A. Install valve with the inlet (ON) side of valve connected to the back panel port and the outlet (OFF) side of valve connected to the water level control plumbing. Apply liquid thread sealant to threads of piping before assembly.

7. Reassemble parts removed in reverse order. Perform DOOR LATCH ADJUSTMENT as outlined under DOOR.

## BUZZER



**WARNING:** DISCONNECT THE ELECTRICAL POWER TO THE MACHINE AND FOLLOW LOCKOUT / TAGOUT PROCEDURES.

1. Remove the RIGHT SIDE PANEL.
2. Locate the buzzer which is mounted above the door switch near the front of steamer.

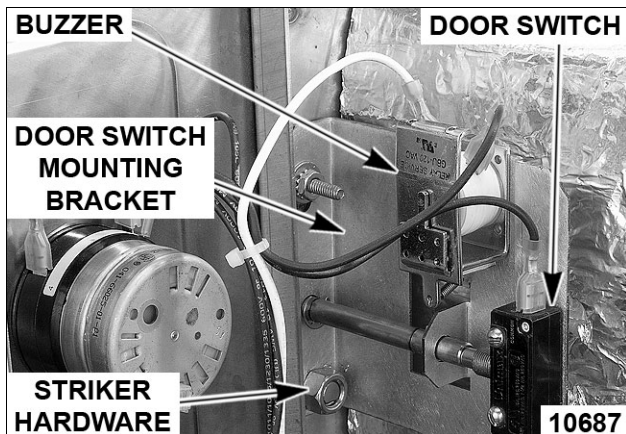

3. Disconnect electrical wiring from the buzzer and door switch.
4. Remove door striker.

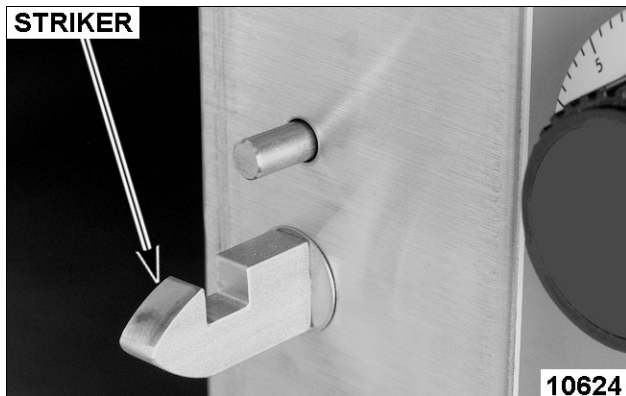

5. Remove remaining hardware securing door switch mounting bracket to front panel then remove door switch mounting bracket, door switch and buzzer as an assembly.
6. Remove buzzer from door switch mounting bracket.

# STEAM GENERATOR TANK



**WARNING:** DISCONNECT THE ELECTRICAL POWER TO THE MACHINE AND FOLLOW LOCKOUT / TAGOUT PROCEDURES.

## REMOVAL AND REPLACEMENT

1. Turn off machine to drain steam generator tank. Allow steamer to complete drain cycle.
  - A. Turn off water supply.
2. Remove the TOP COVER, RIGHT and REAR PANEL as outlined under COVERS AND PANELS.
3. Disconnect electrical wiring then remove HOLD THERMOSTAT.
4. Disconnect the fill union fitting.

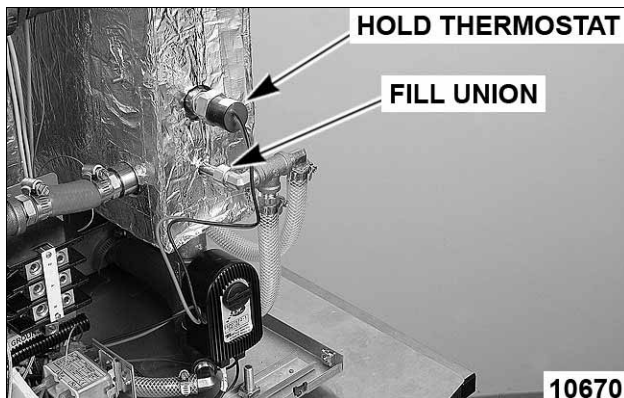

**NOTE:** It is not necessary to disconnect the electrical wiring to the motorized drain valve in order to remove the motor section of valve.

5. Remove the drain valve controlling mechanism.
  - A. For Pro models, refer to MOTORIZED DRAIN VALVE and remove the motor section of valve.
  - B. For Basic models, refer to MANUAL DRAIN VALVE and disconnect the linkage from valve. Remove the on/off power switch and bracket as an assembly.

**NOTE:** Water level probe assembly is to be removed from the steam generator tank once the steam generator is removed from the steamer.

6. Disconnect the drain flush solenoid hose and drain hose from the Tee located below the drain valve.

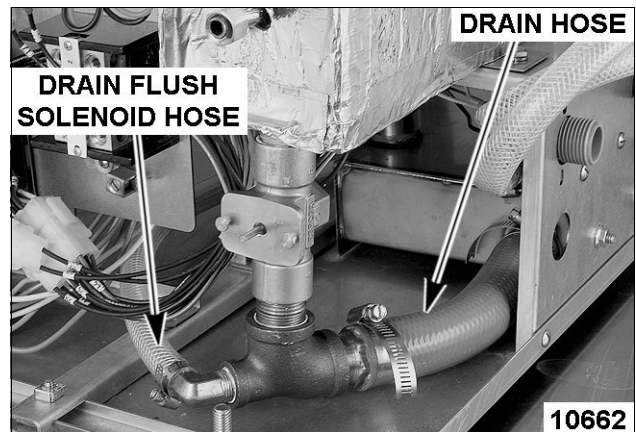

7. Disconnect steam outlet hose from tank fitting or super heater fitting (super heater on Professional model only).
8. Remove HEATING ELEMENT.

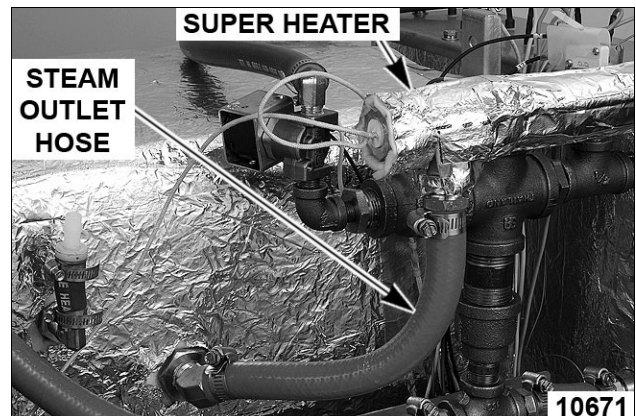

PROFESSIONAL MODEL SHOWN

9. If Pro model, disconnect the super heater electrical wiring.
  - A. Remove the super heater element and super heater housing as an assembly at the top machined elbow.

10. Remove remaining steam outlet elbow plumbing from steam generator tank.

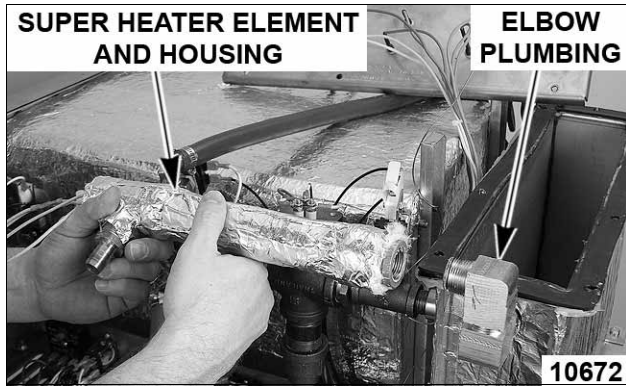

18. Reinstall parts removed in reverse order of removal. Apply liquid thread sealant to all pipe threads connected to the steam generator tank. Do not apply thread sealant to fill union fitting.
19. Torque heating element screws to 70 in\*lb following the heating element tightening sequence as found under HEATING ELEMENT.
20. Check steamer for proper operation. Inspect inlets/outlets and gasket seal of steam generator tank for leaks.

11. Remove delime hose from water level probe assembly.
12. Remove hose from the vacuum relief solenoid.
13. Note wiring connection points and remove the electrical wires from the VACUUM RELIEF SOLENOID, WATER LEVEL PROBES and PRESSURE SWITCH.

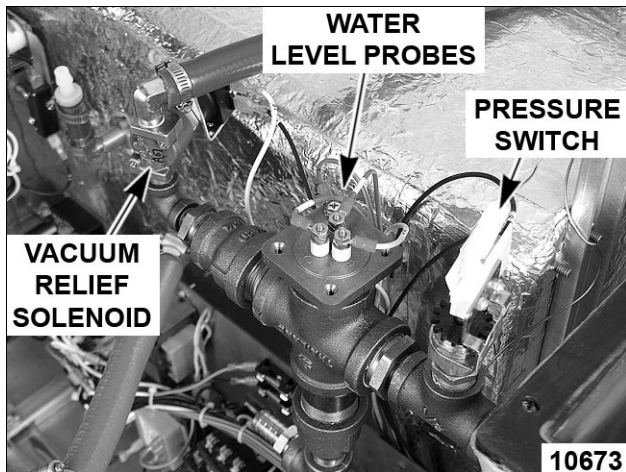

**NOTE:** Install a new gasket when reassembling steam generator tank. Temporarily secure gasket in place with RTV109.

14. Remove gasket from steam generator tank.
  - A. Clean remaining sealant from top lip of steam generator tank.
15. Remove hardware securing steam generator tank to machine frame (three places) then remove tank from machine.
16. Remove water level probe assembly from tank.
17. If removed or replacing generator tank, install insulation around generator tank. Secure into position using high temperature aluminum foil tape.

# ELECTRICAL OPERATION

## COMPONENT FUNCTION

<b>Water Level Control (WLC) Board</b> . . . . .	Controls water level by monitoring conditions of the three water level probes H, L and LLCO.
<b>Buzzer</b> . . . . .	Creates audible signal when timed cook cycle is complete.
<b>Contactors, Limiting</b> . . . . .	Connects one side of heating elements to incoming power. Energized whenever WLC (LLCO) coil is energized.
<b>Contactors, Regulating</b> . . . . .	Connects one side of heating elements to power. On constantly during cooking cycle.
<b>Drain Valve, Motorized (Ball type)</b> . . . . .	(Professional models only) Motorized control for opening and closing drain valve.
<b>Element, Heating</b> . . . . .	Located in steam generator tank. Heats water to produce steam.
<b>Element, Super-heater</b> . . . . .	(Professional models only) Located in piping from steam generator tank to cooking chamber. Provides additional energy to raise steam temperature.
<b>Fuse, (1FU)</b> . . . . .	Slow blow 4A fuse. Located on primary side of main transformer. Protects control circuitry from over-currents.
<b>Fuse, (2FU)</b> . . . . .	Slow blow 4A fuse. Located on primary side of main transformer. Protects control circuitry from over-currents.
<b>Lamp (3LT), Power</b> . . . . .	Amber (AM) colored lamp. On when power switch is on.
<b>Lamp (2LT), Cook</b> . . . . .	Red (RD) colored lamp (Professional models only). On when hold thermostat is satisfied and door is closed and timer is set.
<b>Lamp (1LT), Ready</b> . . . . .	Green (GN) colored lamp (Professional models only). On when cycling thermostat is satisfied. Latches on when hold thermostat is satisfied.
<b>Probe (H)</b> . . . . .	High water level probe connected to internal latch relay circuit. Water must reach this level before internal latch relay is energized.
<b>Probe (L)</b> . . . . .	Low water level probe connected to internal latch relay circuit.
<b>Probe (LLCO)</b> . . . . .	Low Level Cut-Off (LLCO) probe. Controls power to heating and timer circuitry. Controls fast fill solenoid (Professional models only).
<b>Relay (K1)</b> . . . . .	Controlled by hold thermostat. Enables timer circuit.
<b>Relay (K2), LLCO</b> . . . . .	Low Level Cut-Off (LLCO) external relay. Only energized during drain. Controls Flush, Fast Fill and Vacuum Relief solenoids.
<b>Relay (K3), Drain Relay</b> . . . . .	Controlled by Time Delay Relay. Only energized during drain cycle. Controls WLC board and LLCO relay K2 during drain. Disables heating and timer circuitry.
<b>Relay (K4)</b> . . . . .	(Professional models only) Latches Ready light on. Allows power to superheater.
<b>Relay, Time Delay</b> . . . . .	Controlled by the power switch. Output becomes active for 90 seconds when power switch is turned to off. Only used during drain cycle.
<b>Solenoid (1SOL), Cooling</b> . . . . .	Controlled by the condensate thermostat. Mixes cold water with hot condensate water from cooking chamber to reduce water temperature at drain.
<b>Solenoid (2SOL), Flush</b> . . . . .	On only during drain cycle. Mixes cold water with tank water before entering drain box. Keeps drain hose clear of debris.
<b>Solenoid (3SOL), Fast Fill</b> . . . . .	Initial tank fill for Professional machines. Used during last stage of drain cycle to flush drain opening free of debris.

<b>Solenoid (4SOL), Slow Fill</b> .....	Primary fill for Basic machines and secondary fill for Professional machines. Energized as necessary during operation to replenish water in generator tank.
<b>Solenoid (5SOL), Vacuum Relief</b> .....	Provides open air line for vacuum relief during drain cycle to prevent cooking chamber flex.
<b>Switch (1S), Power</b> .....	Rocker switch on Professional machines and linkage activated plunger switch on Basic machines. Two position switch that controls machine steam and drain operations.
<b>Switch (2S), Door</b> .....	Plunger activated, switch is wired in series with timer. When switch is closed and timer is set to a time or constant, regulating contactor will be energized 100% of the time once ready light is on (hold thermostat satisfied).
<b>Switch (1PAS), Pressure</b> .....	Pressure cut-out protection. Range is between 4.5 to 4.7 psi. Cuts off electrical energy to controls circuit if pressure is above set pressure.
<b>Thermostat (1TAS), Condensate</b> .....	Monitors temperature of water entering the facility drain system. Controls the cooling solenoid during cooking operation and the cooling and flush solenoids during drain cycle (135° F cut-in).
<b>Thermostat (2TAS), High-Limit</b> .....	Protects against heating element over-temperatures generally caused by tank boiling dry. Capillary style device. Bulb is mounted directly to the heating element and body is bracket mounted to frame rail (257° F cut-out).
<b>Thermostat (3TAS), Hold</b> .....	Controls temperature of water in steam generator tank to 195°F (closes at 195° F).
<b>Timer (1TR)</b> .....	Used for timed cook cycles from 0 to 60 minutes. Professional models have a CONSTANT position for continuous steam operation.
<b>Transformer (1T), Main</b> .....	Step down transformer from line voltage to control voltage level (120VAC).
<b>Transformer (2T), Drain</b> .....	(Professional models only) Provides 24VAC for motorized drain valve during drain cycle.

## COMPONENT LOCATION

### Electrical Control Panel

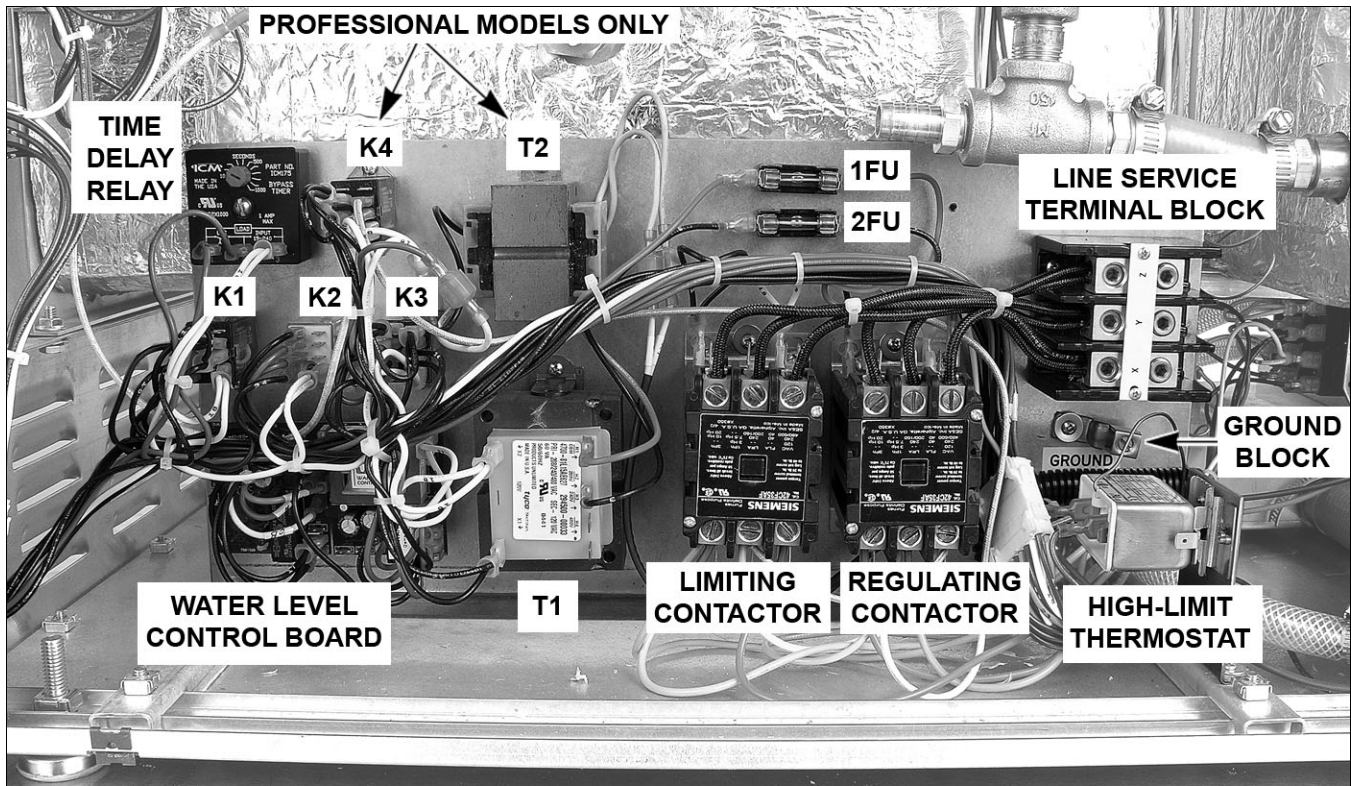

**K1 THRU K4 = RELAYS**

**T1 = LINE VOLTAGE IN, 120V OUT TRANSFORMER**

**T2 = 120V IN / 24V OUT TRANSFORMER**

**10655**

**NOTE:** Relay K4 and transformer T2 are present on Professional models only.

Water Level Control Board

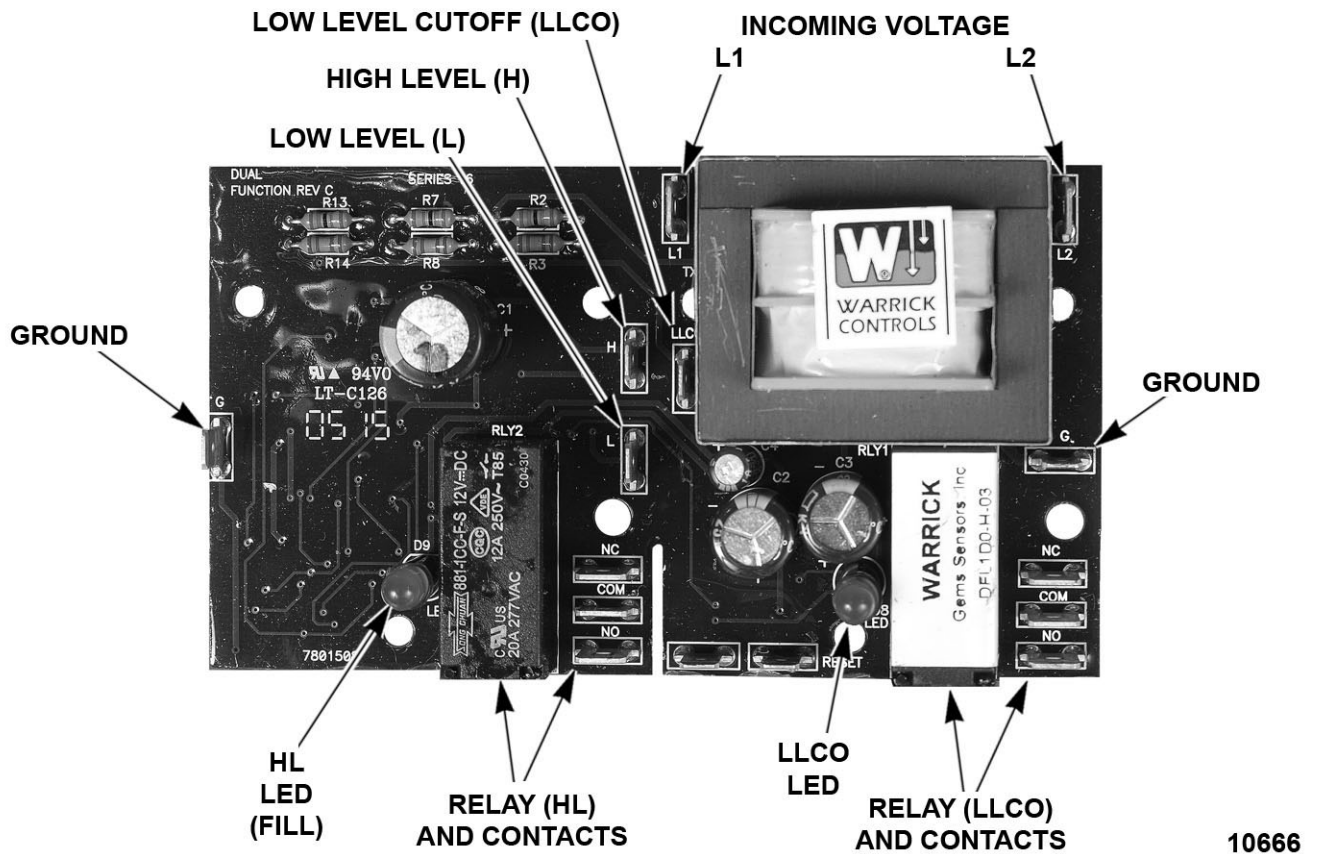

10666

Front Panel

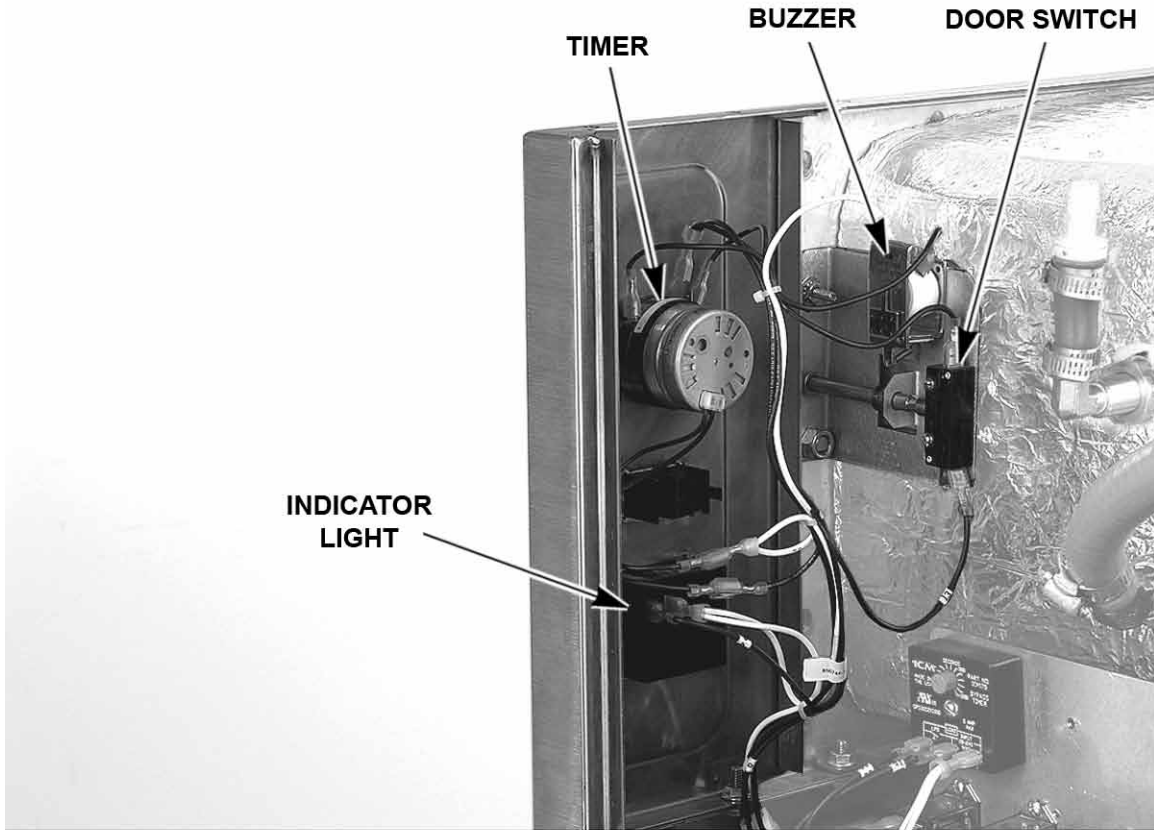

BASIC MODEL

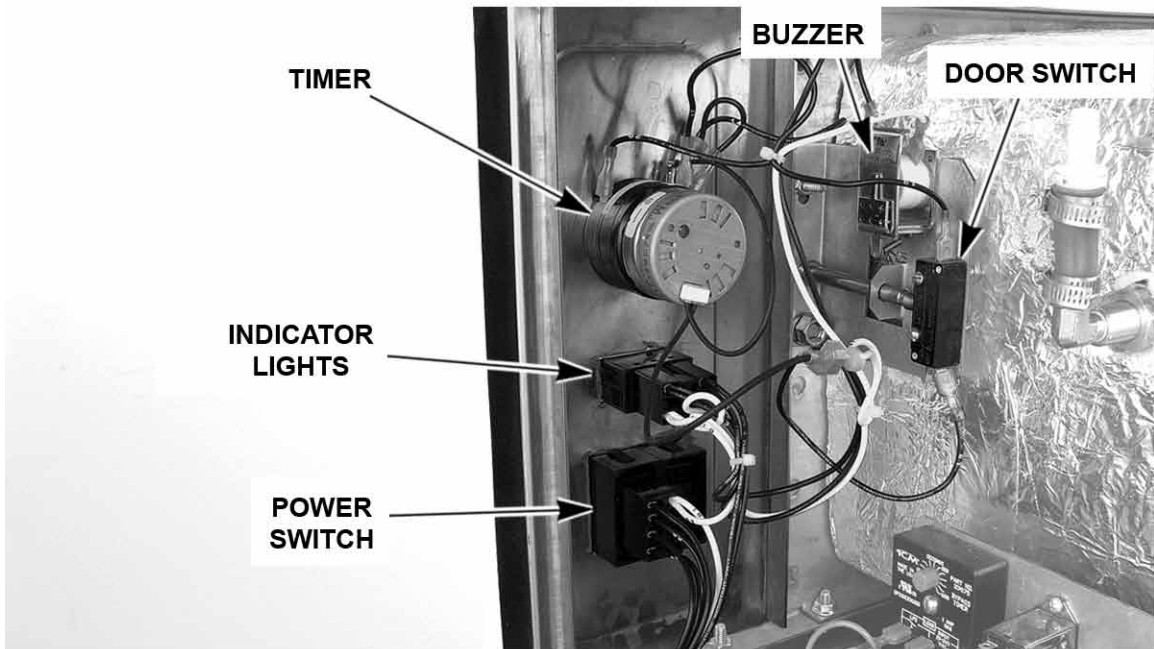

PROFESSIONAL MODEL

10667



Steam Generator and Back Panel

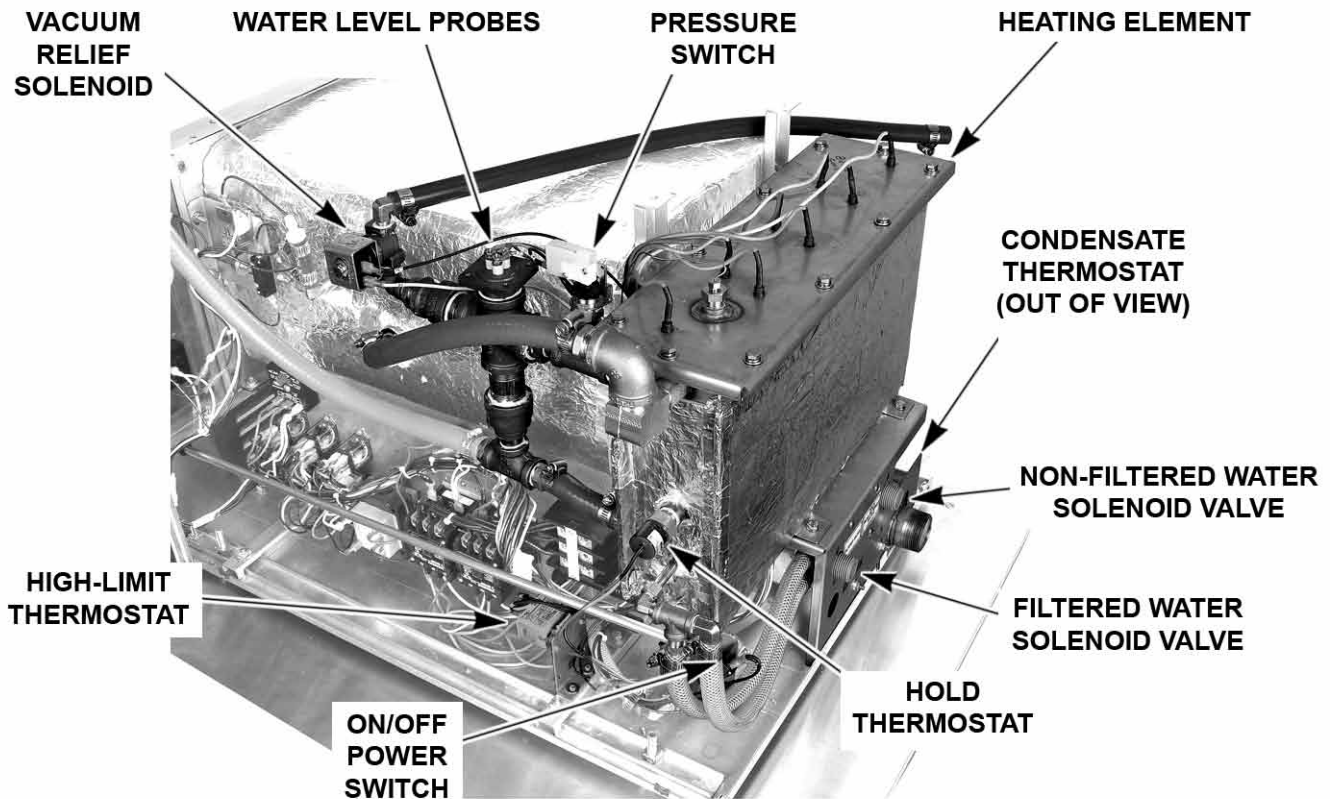

BASIC MODEL

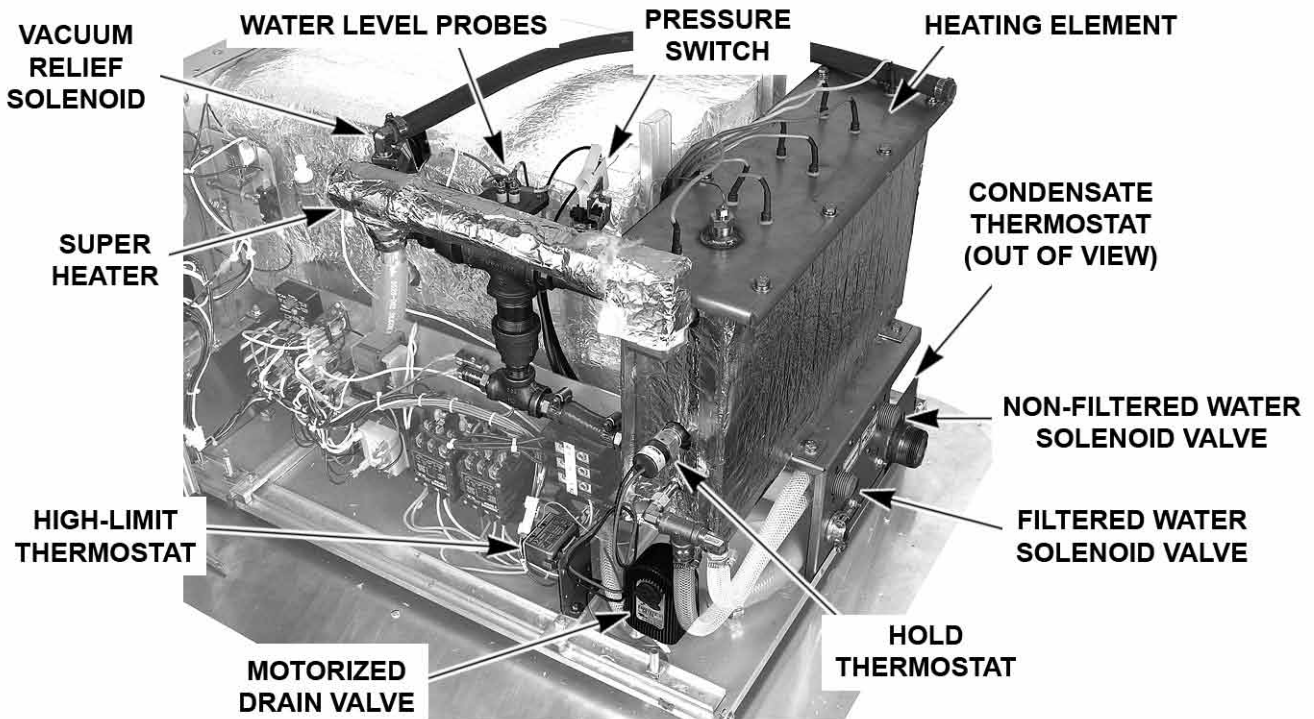

PROFESSIONAL MODEL

10668

## SEQUENCE OF OPERATION

Refer to the correct wiring diagram for model being serviced when reviewing sequence of operation.

**NOTE:** If power switch is set to off when service voltage is applied, steamer will enter the timed drain cycle.

### Basic Model

1. Conditions
  - A. Steamer connected to correct voltage.
    - 1) 120VAC present across X1 & X2 on secondary side of main transformer.
  - B. Steamer connected to water supply with correct water requirements.
  - C. Power switch is off (drain handle pulled out).
    - 1) Time delay relay timed out. Timer has no output on terminal 1.
  - D. Condensate thermostat is open.
  - E. High limit thermostat closed.
  - F. Pressure switch is closed.
  - G. Hold thermostat open.
  - H. Drain open and steam generator tank (referred to as tank) is empty.
  - I. Steamer door open.
  - J. Timer is off.
  - K. Water level control (WLC) and tank properly grounded.
2. ON/OFF lever pushed in.
  - A. Manual linkage closes drain valve and operates power switch.
    - 1) N.O. contacts close.
  - B. Amber power light illuminates.
  - C. X1 potential to L1 of WLC board.
    - 1) 120VAC across L1 & L2 of WLC board.
    - 2) High level coil (HL) energized on WLC board. HL LED on WLC board lights.
3. Slow fill solenoid energized through closure of HL contacts. Tank fills.
4. Water level reaches Low Level Cut-Off (LLCO) probe.
  - A. LLCO coil is energized. LLCO LED on WLC board lights.
  - B. LLCO N.O. contacts close enabling heating element circuit.
5. Limiting and regulating contactor coils energize. Power to heating element. Tank water heats.
6. Water level reaches Low level (L) probe.
  - A. No action as internal latching relay (ILR-1) contacts are open.
7. Water level reaches high level (H) probe.
  - A. Internal latching relay (ILR) coil on WLC board energizes.
  - B. High level (HL) coil de-energized by ILR-2 contacts opening.
  - C. Slow fill solenoid de-energized by opening of HL contacts on WLC board.
8. Tank water reaches 195° F. Hold thermostat contacts close.
  - A. Relay K1 energizes. Timer circuit is enabled through closure of N.O. contacts K1-5/3 and K1-6/4.
  - B. Temperature in tank is maintained at 195° F by hold thermostat control of regulating contactor through relay contacts K1-1/5.
9. Timer knob set to time other than zero.
  - A. Timer motor energized through closure of N.O. contacts K1-6/4 when time set is greater than zero. Door switch closure allows 120VAC across timer wires 18 & 19. Timer counts down from set time.
  - B. Tank temperature maintained by control of regulating contactor coil through N.O. contacts K1-6/4 and (Timer -1/3, door switch, K1-5/3).
10. Steamer door is closed.
  - A. Regulating contactor remains energized as long as time remains on Timer and door is closed.
    - 1) Heating element energized continuously.
11. Temperature of condensate exiting cooking cavity increases to above 135°F.
  - A. Condensate thermostat closes energizing cooling solenoid 1SOL. Condensate is cooled in drain box before entering facility drain system.
12. Door opened during timed cook cycle.
  - A. Timer continues count down until time equals zero even if steamer door is opened.
  - B. Regulating contactor de-energized until below 195°F.
13. Time reaches zero.
  - A. Buzzer is energized through N.O. contacts K1-6/4 and Timer - 1/4.
    - 1) Buzzer remains energized until timer knob is turned to OFF, new time is set or drain handle is pulled out (power switch off).
14. Drain handle pulled out. Tank drains.
  - A. Power light (1LT-Amber) turns off.

- B. Time delay relay is energized through terminals 2 & 3 for set time (90 seconds). Output (120VAC) on terminal 1.
  - C. Time delay relay output energizes K3 coil.
    - 1) X1 potential to L1 of WLC board through N.O. contacts K3-5/3
    - 2) LLCO relay K2 coil energized through closed N.O. contacts K3-5/3, WLC board N.O. contacts LLCO and N.O. contacts K3-6/4.
      - a. Drain Flush Solenoid enabled by closure of N.O. contacts K2-3/5.
    - 3) Heating element and timer control circuits are disabled by opening of N.C. contacts K3-6/2.
15. Condensate Thermostat reaches 135° F cut-in temperature, contacts close. Drain water temperature is regulated through condensate thermostat.
- A. Cooling Solenoid and Drain Flush Solenoid energized through cycling of Condensate Thermostat.
16. Tank water level drops below L probe.
- A. Internal latching relay (ILR) de-energizes.
    - 1) High level coil (HL) energized on WLC board. HL LED on WLC board lights.
17. Tank water level drops below LLCO probe.
- A. LLCO relay K2 de-energized through opening of WLC board LLCO N.O. contacts.
    - 1) Drain Flush Solenoid energized through N.C. contacts (K2-6/2).
    - 2) Flush/Fast Fill Solenoid energized through N.C. contacts K2-6/2 and K2-5/1.
    - 3) Vacuum Relief Solenoid is energized through closed N.O. contacts K2-2/6.
18. Time Delay Relay time elapses.
- A. Power (120VAC) removed from output of Time Delay Relay terminal 1.
    - 1) All solenoids, coils and WLC board are de-energized.
- Professional Model**
1. Conditions
- A. Steamer connected to correct voltage.
    - 1) 120VAC potential across X1 & X2 on secondary side of main transformer.
  - B. Steamer connected to water supply with correct water requirements.
  - C. Power switch is in off position.
    - 1) Time delay relay timed out. Timer has no output on terminal 1.
  - D. Condensate thermostat is open.
- E. High limit thermostat closed.
  - F. Pressure switch is closed.
  - G. Hold thermostat open.
  - H. Drain closed and steam generator tank (referred to as tank) is empty.
  - I. Steamer door open.
  - J. Timer is off.
  - K. Water level control (WLC) and tank properly grounded.
2. Power switch (1S) is turned on.
- A. Power light (3LT - Amber) illuminates.
  - B. X1 potential to L1 of WLC board.
    - 1) 120VAC across L1 & L2 of WLC board.
    - 2) High level coil (HL) energized on WLC board. HL LED on WLC board lights.
  - C. Fast Fill Solenoid (3SOL) energized through N.C. contacts K3-1/5, N.C. contacts WLC (LLCO) and N.C. contacts K2-5/1. Tank begins to fill with water.
3. Water level reaches Low Level Cut-Off (LLCO) probe.
- A. LLCO coil is energized. LLCO LED on WLC board lights.
  - B. LLCO N.C. contacts open de-energizing Fast Fill Solenoid.
  - C. LLCO N.O. contacts close enabling timer and heating element circuits.
4. Limiting contactor coil energizes.
5. Regulating contactor coil energizes through N.C. contacts K1-1/5. Power to heating element. Tank water heats.
6. Tank water reaches 195° F. Hold thermostat contacts close.
- A. Slow Fill Solenoid is energized through closure of Cycling Thermostat (3TAS) and closed WLC (HL) N.O. contacts. Tank continues to fill.
  - B. Relay K1 energizes. Timer circuit is enabled through closure of N.O. contacts K1-6/4 and K1-5/3.
    - 1) Ready light (1LT - Green) illuminates.
    - 2) Relay K4 energizes.
      - a. Super Heater energizes through closure of N.O. contacts K4-6/4.
      - b. Ready light (1LT - green) lights.
      - c. Latch circuit is completed by closure of N.O. contacts K4-5/3.
  - C. Temperature in tank is maintained at 195° F by Cycling Thermostat control of regulating contactor through N.C. contacts K1-1/5.
7. Water level reaches Low level (L) probe.

- A. No action as internal latching relay (ILR-1) contacts are open.
8. Water level reaches high level(H) probe.
  - A. Internal latching relay (ILR) coil on WLC board energizes.
  - B. High level (HL) coil de-energized by ILR-2 contacts opening.
  - C. Slow Fill Solenoid de-energized by opening of HL contacts on WLC board.
  - D. HL LED on WLC board turns off.
9. Timer knob set to CONSTANT for continuous steam operation or Timer knob is turned to a timed setting.
  - A. Power (120VAC) present to Door Switch wire #19.
  - B. If Timer is set to a timed setting, Timer motor is energized through closure of N.O. contacts K1-6/4. Count down time begins.
10. Steamer door is closed.
  - A. Door Switch (2S) contacts close. Cook light (2LT - Red) illuminates.
  - B. Regulating contactor remains energized as long as door is closed and Timer is set to CONSTANT or time remains on timed cycle.
11. Temperature of condensate exiting cooking cavity increases to above 135°F.
  - A. Condensate thermostat closes energizing cooling solenoid 1SOL. Condensate is cooled in drain box before entering facility drain system.
12. Door opened during timed cook cycle.
  - A. Timer continues count down until time equals zero even if steamer door is opened.
  - B. Regulating contactor de-energizes and cook light turns off.
13. Time reaches zero.
  - A. Buzzer is energized through N.O. contacts K1-6/4 and Timer - 11/14.
    - 1) Buzzer remains energized until timer knob is turned to OFF, new time or CONSTANT is selected or steamer is turned off.
14. Power Switch (1S) pushed to off.
  - A. Power (3LT), Cook (2LT) and Ready (1LT) lights turn off.
  - B. Time delay relay is energized through terminals 2 & 3. Output (120VAC) on terminal 1 for 90 seconds.
- C. Time delay relay output energizes K3 coil.
  - 1) X1 potential to L1 of WLC board through N.O. contacts K3-3/5.
  - 2) Relay K2 coil energized through WLC N.O. contacts LLCO and N.O. contacts K3-6/4.
  - 3) Heating element and timer control circuits are disabled by opening of N.C. contacts K3-6/2.
- D. Power (120VAC) across primary of drain transformer. Motorized drain valve energized. Drain valve opens and tank begins to drain.
  - 1) Drain valve N.O. contacts close.
15. Condensate Thermostat reaches 135°F, contacts close. Drain water temperature is regulated through condensate thermostat.
  - A. Cooling Solenoid (1SOL) energized through closure of Condensate Thermostat contacts.
  - B. Flush Solenoid (2SOL) energized through closure of N.O. contacts K2-3/5 and drain valve N.O. contacts.
16. Tank water level drops below L probe.
  - A. Internal latching relay (ILR) de-energizes.
    - 1) High level coil (HL) energized on WLC board. HL LED on WLC board lights.
17. Tank water level drops below LLCO probe.
  - A. Relay K2 de-energized through opening of WLC board LLCO N.O. contacts.
  - B. Vacuum Relief Solenoid energized through N.C. contacts K2-2/6.
  - C. Fast Fill Solenoid energized through WLC (LLCO) N.C. contacts and N.C. contacts K2-5/1.
  - D. Flush Solenoid (2SOL) remains energized through WLC (LLCO) N.C. contacts.
18. Time Delay Relay time elapses.
  - A. Power (120VAC) removed from output of Time Delay Relay terminal 1.
    - 1) All Solenoids, coils and WLC board are de-energized.
    - 2) Motorized drain valve de-energized. Drain valve closes.

**WIRING DIAGRAMS**

**Heating Element Wiring**

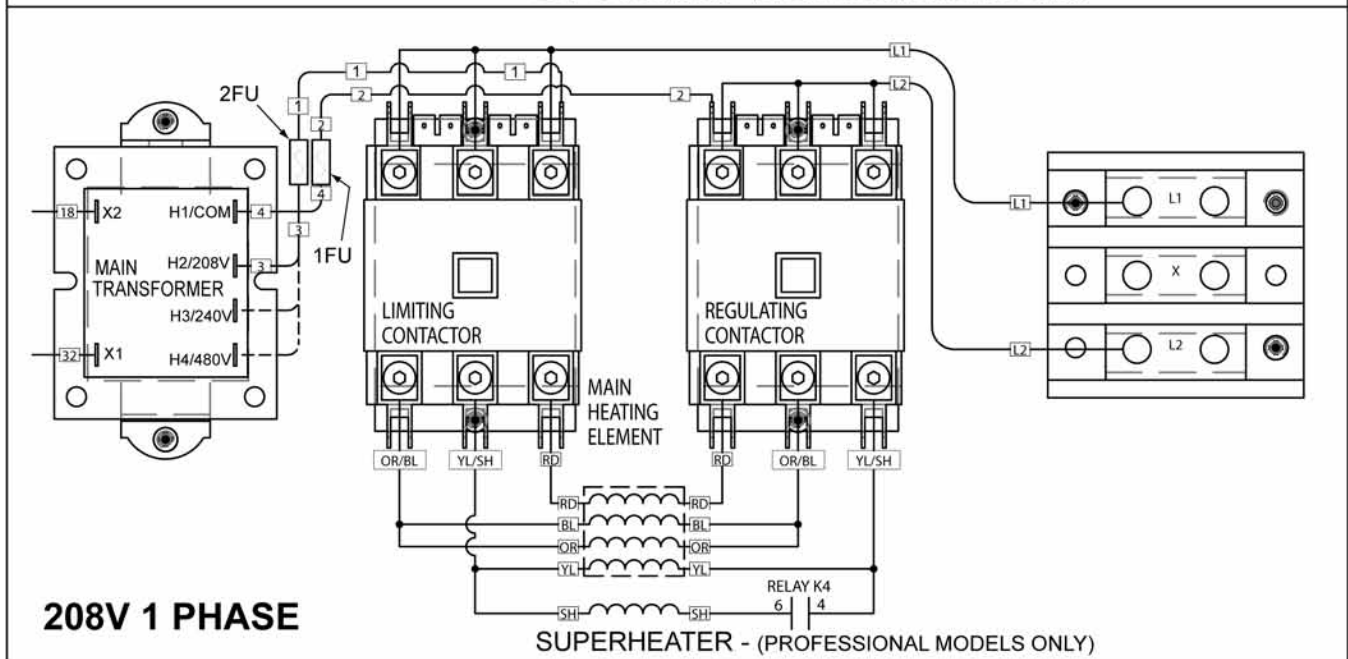
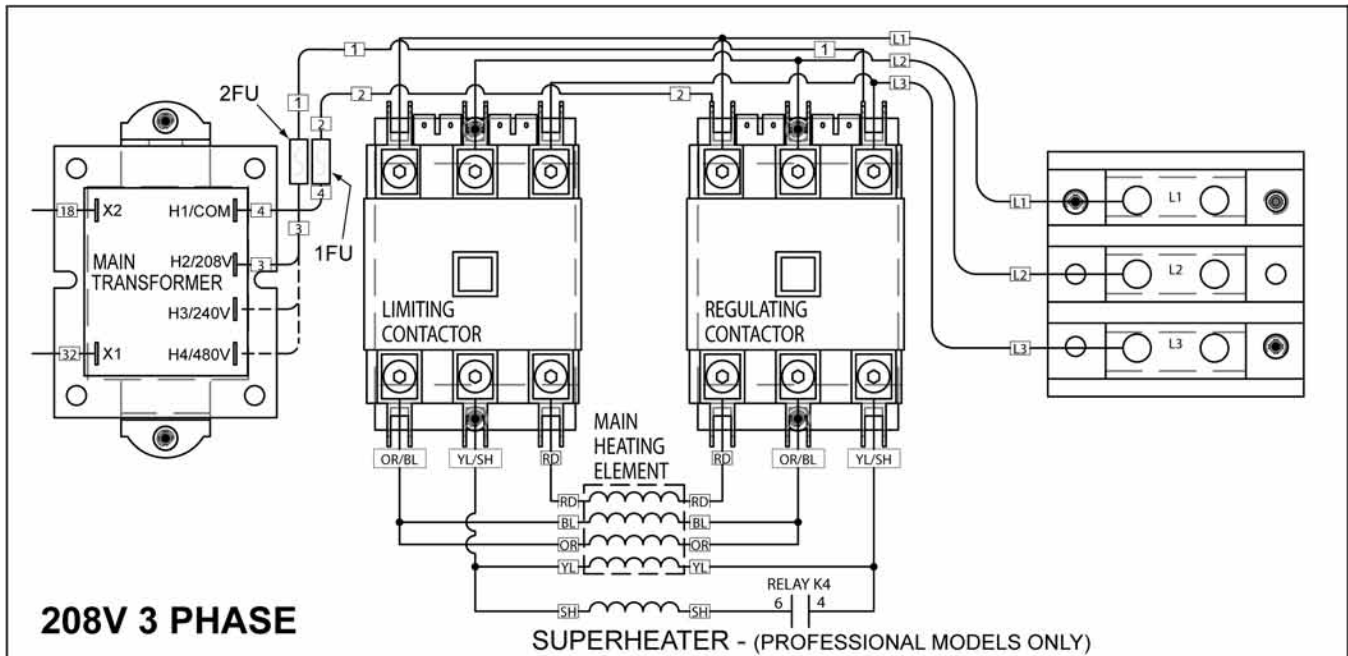

**FIELD CONVERSION TO 240V:**

- 1) ONLY THREE ELEMENTS WILL BE UTILIZED.
- 2) DISCONNECT AND CAP THE ORANGE WIRES OF MAIN HEATING ELEMENT AND CHANGE WIRE #3 TO THE 240V VOLTAGE TAP ON TRANSFORMER.
- 3) FOR BASIC MACHINES, THERE IS NO SUPERHEATER.

DERIVED FROM 856653-1 REV. C

AI 1796

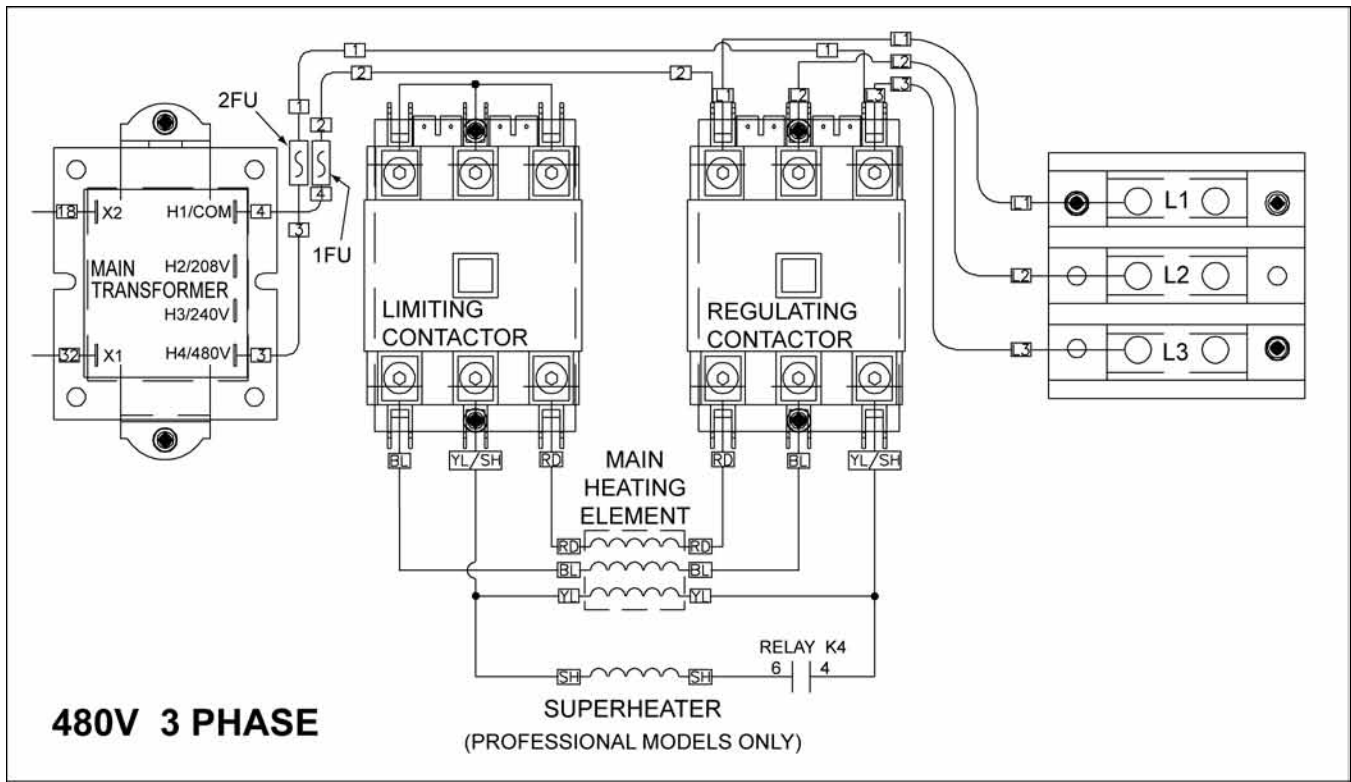















**NOTES:**

- 1) FOR BASIC MACHINES, THERE IS NO SUPERHEATER.

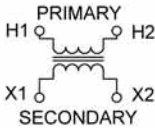
DERIVED FROM 856676-1

AI 1803

**LEGEND OF ELECTRICAL SYMBOLS**

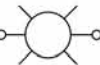
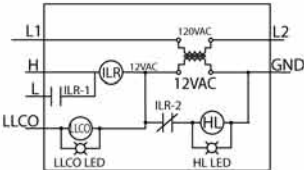
	TERMINAL BLOCK (TB)		TIME DELAY RELAY
	FUSE (FU)		SOLENOID (SOL)
	SWITCH, SPDT		DRAIN VALVE, MOTORIZED
	SWITCH, N.O.		COIL, RELAY (K) OR CONTACTOR
	THERMOSTAT, N.O.		TRANSFORMER (T)
	PRESSURE SWITCH, N.C.		TIMER (TR)
	CONTACTS, N.C.		
	CONTACTS, N.O.		
	WATER PROBE ASSEMBLY		
	LAMP AM = AMBER GN = GREEN RD = RED		WATER LEVEL CONTROL BOARD (WLC)

N.C. = NORMALLY CLOSED  
N.O. = NORMALLY OPEN

AI 1804

MODEL C24EA - ELECTRICAL OPERATION

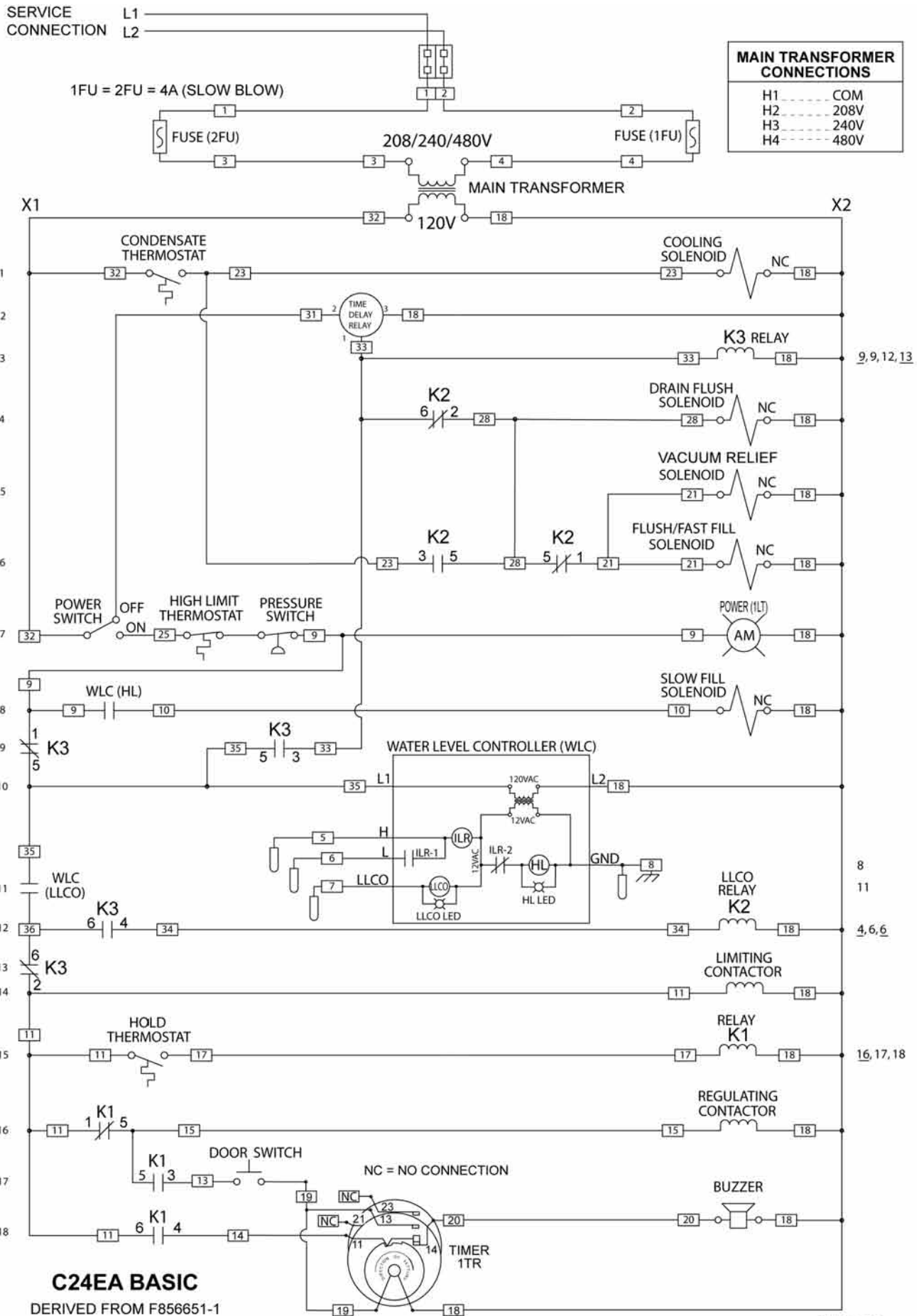

AI 1797



MODEL C24EA - ELECTRICAL OPERATION

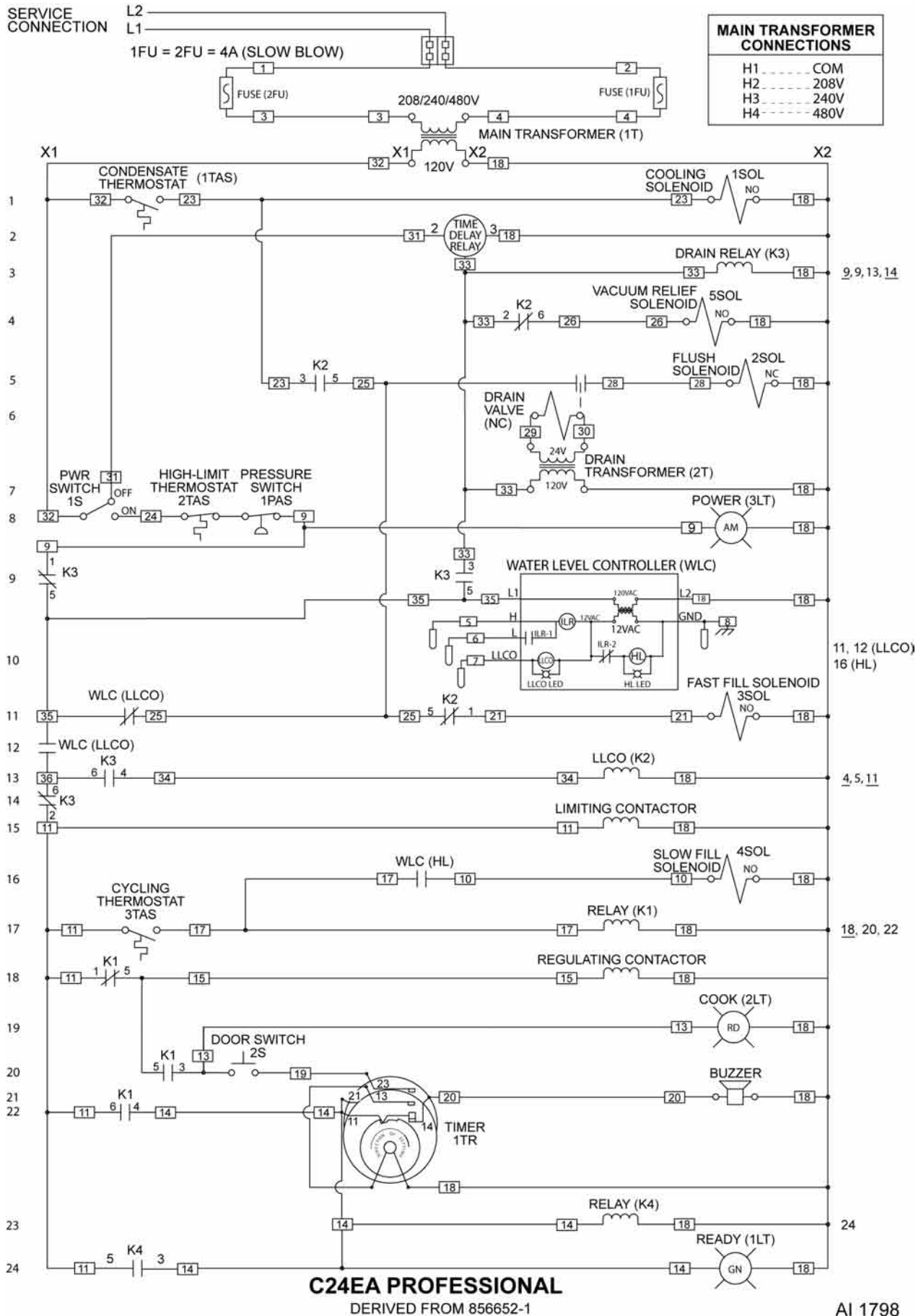

AI 1798

# TROUBLESHOOTING

SYMPTOM	POSSIBLE CAUSES
Compartment leaks water around door.	<ol style="list-style-type: none"> <li>1. Unit not level.</li> <li>2. Drain line obstructed or not to an open gap drain.</li> <li>3. Door gasket damaged.</li> </ol>
Cold water condenser not operating properly.	<ol style="list-style-type: none"> <li>1. Solenoid (2SOL) inoperative or plugged.</li> <li>2. Lack of water supply.</li> <li>3. Drain water thermostat stuck open.</li> <li>4. Drain cold water condensate valve malfunction.</li> </ol>
Steam leaks around door.	<ol style="list-style-type: none"> <li>1. Worn gasket - See DOOR section.</li> <li>2. Damaged gasket.</li> <li>3. Drain line obstructed or not to an open drain.</li> </ol>
Steam generated inside cooking compartment when timer is off.	<ol style="list-style-type: none"> <li>1. Cycling thermostat (2TAS) or related heat control circuitry malfunction.</li> <li>2. Relay K1 malfunction.</li> </ol>
Steam leaking inside panels.	<ol style="list-style-type: none"> <li>1. Tank gasket not sealing.</li> <li>2. Loose steam line.</li> </ol>
Heat coming on without water in tank.	<ol style="list-style-type: none"> <li>1. Dirty low level cut-off probe (shorted to ground).</li> <li>2. Contactor malfunction.</li> <li>3. WLC- LLCO contacts stuck closed. Water level controller (WLC) malfunction.</li> </ol>
Machine will not heat.	<ol style="list-style-type: none"> <li>1. Check incoming voltage.</li> <li>2. Tank not filled.</li> <li>3. Power switch malfunction.</li> <li>4. Water Level Control malfunction.</li> <li>5. Relay (K1) malfunction.</li> <li>6. High-limit thermostat open (2TAS).</li> <li>7. Heating element inoperative.</li> <li>8. Limiting or regulating contactor malfunction.</li> <li>9. Control thermostat open (2TAS).</li> <li>10. Relay (K3) malfunction.</li> <li>11. Water too pure for probes to properly conduct electricity.</li> </ol>
Steamer leaks water.	<ol style="list-style-type: none"> <li>1. Loose connections in water, steam or drain lines.</li> </ol>
Tank water level too high.	<ol style="list-style-type: none"> <li>1. Slow fill solenoid (4SOL) or fast fill solenoid (3SOL) does not shut off.</li> <li>2. High level probe malfunction (open circuit).</li> <li>3. Water level control board inoperative (WLC).</li> </ol>
Tank does not fill.	<ol style="list-style-type: none"> <li>1. Water supply not on.</li> <li>2. Slow fill solenoid (4SOL) or fast fill solenoid (3SOL) not being energized or plugged.</li> <li>3. Water level control board malfunction (WLC).</li> <li>4. Water level probes shorted to ground.</li> </ol>
Timer motor does not run	<ol style="list-style-type: none"> <li>1. Relay K1-6/4 contacts not closing.</li> <li>2. Timer malfunction.</li> </ol>
Water running out of drain during fill.	<ol style="list-style-type: none"> <li>1. Manual drain open (Basic only).</li> <li>2. Motorized drain valve stuck open (Professional only).</li> <li>3. Time delay relay malfunction.</li> <li>4. Condensate thermostat malfunction.</li> </ol>
Door not closing properly.	<ol style="list-style-type: none"> <li>1. Door latch assembly.</li> <li>2. Striker adjustment.</li> </ol>
Door won't open.	<ol style="list-style-type: none"> <li>1. Latch won't release. Refer to DOOR LATCH ADJUSTMENT as outlined in DOOR.</li> </ol>
Buzzer not operating.	<ol style="list-style-type: none"> <li>1. Timer malfunction.</li> <li>2. Buzzer malfunction.</li> </ol>

**- NOTES -**

**CONDENSED SPARE PARTS LIST****C24EA**

<b>PART NO.</b>	<b>DESCRIPTION</b>	<b>Basic</b>	<b>Professional</b>	<b>Qty.</b>
844069-1	Water Level Control Board (WLC)	X	X	1
856658-1	Cavity Vacuum Breaker	X	X	1
294500-33	Transformer	X	X	1
410472-8	Terminal Block - Main	X	X	1
411500-12	Transformer (2T)		X	1
416535-6	Relay	X	X	3
855661-1	Time Delay Relay	X	X	1
881654	Contactora	X	X	2
FE-024-94	Fuse, 250V, 4A (slow blow)	X	X	2
294436-3	Fuse Block	X	X	1
856621-1	Timer	X	X	1
856773-1	Timer Knob	X	X	1
411499-4	Buzzer	X	X	1
856718-1	Drain Valve Assembly, Motorized		X	1
FP-090-57	Drain Valve, Manual	X		1
857022-1	Pressure Switch	X	X	1
850736-2	Water Level Probe Assembly	X	X	1
856716-1	Temperature Probe Hold Thermostat	X	X	1
856720-2	Dual Water Valve, Fill (3 & 5 pan)	X	X	1
856720-4	Dual Water Valve, Condensate (3 pan)	X	X	1
856720-6	Dual Water Valve, Condensate (5 pan)	X	X	1
856756-1	High-Limit Thermostat	X	X	1
856710-1	Heating Element Assy 208/240, 15 kW (5 pan)	X	X	1
856710-2	Heating Element Assy 208/240, 8.5 kW (3 pan)	X	X	1
856709-1	Heating Element - Super Heater 208/240V		X	1
856711-1	Generator Tank Gasket	X	X	1
842049-1	Switch, Door (also power switch for Basic steamer)	X	X	2
855677-1	Switch, Power (Professional only)		X	1
857021-1	Solenoid, Vacuum Relief	X	X	1
855286-1	Gasket, Door (3 pan)	X	X	1
855286-2	Gasket, Door (5 pan)	X	X	1

## Free Manuals Download Website

<http://myh66.com>

<http://usermanuals.us>

<http://www.somanuals.com>

<http://www.4manuals.cc>

<http://www.manual-lib.com>

<http://www.404manual.com>

<http://www.luxmanual.com>

<http://aubethermostatmanual.com>

Golf course search by state

<http://golfingnear.com>

Email search by domain

<http://emailbydomain.com>

Auto manuals search

<http://auto.somanuals.com>

TV manuals search

<http://tv.somanuals.com>