



DONE TO PERFECTION.

INSTALLATION & OPERATIONAL MANUAL

GRD & GRC SERIES GAS FRYERS With KleenScreen *PLUS*® Filtration Systems

MODELS:



1GR45D	ML-136411
1GR45C	ML-136414
1GR65D	ML-136412
1GR65C	ML-136415
1GR85D	ML-136413
1GR85C	ML-136416
1GR45DF	ML-136778
1GR45CF	ML-136791
1GR65DF	ML-136789
1GR65CF	ML-136792
1GR85DF	ML-136790
1GR85CF	ML-136793
2GR45DF	ML-136424
2GR45CF	ML-136431
3GR45DF	ML-136427
3GR45CF	ML-136434
4GR45DF	ML-136430
4GR45CF	ML-136437
2GR65DF	ML-136425
2GR65CF	ML-136432
3GR65DF	ML-136428
3GR65CF	ML-136435
4GR65DF	ML-136662
4GR65CF	ML-136663
2GR85DF	ML-136426
2GR85CF	ML-136433
3GR85DF	ML-136429
3GR85CF	ML-136436

For additional information on Vulcan-Hart or to locate an authorized parts and service provider in your area, visit our website at www.vulcanhart.com

VULCAN-HART
DIVISION OF ITW FOOD EQUIPMENT GROUP, LLC
WWW.VULCANHART.COM

3600 NORTH POINT BLVD.
BALTIMORE, MD 21222
F-32933 REV. J (August 2012)

IMPORTANT FOR YOUR SAFETY

THIS MANUAL HAS BEEN PREPARED FOR PERSONNEL QUALIFIED TO INSTALL GAS EQUIPMENT, WHO SHOULD PERFORM THE INITIAL FIELD START-UP AND ADJUSTMENTS OF THE EQUIPMENT COVERED BY THIS MANUAL.

POST IN A PROMINENT LOCATION THE INSTRUCTIONS TO BE FOLLOWED IN THE EVENT THE SMELL OF GAS IS DETECTED. THIS INFORMATION CAN BE OBTAINED FROM THE LOCAL GAS SUPPLIER.

IMPORTANT

IN THE EVENT A GAS ODOR IS DETECTED, SHUT DOWN UNITS AT THE MAIN SHUTOFF VALVE AND CONTACT THE LOCAL GAS COMPANY OR GAS SUPPLIER FOR SERVICE.

FOR YOUR SAFETY

DO NOT STORE OR USE GASOLINE OR OTHER FLAMMABLE VAPORS OR LIQUIDS IN THE VICINITY OF THIS OR ANY OTHER APPLIANCE.

WARNING

Improper installation, adjustment, alteration, service or maintenance can cause property damage, injury or death. Read the installation, operating and maintenance instructions thoroughly before installing or servicing this equipment.

TABLE OF CONTENTS

IMPORTANT FOR YOUR SAFETY.....	2
INTRODUCTION.....	4
GENERAL.....	4
ORDERING PARTS.....	4
FRYER CAPACITIES.....	4
UNPACKING.....	5
INSTALLATION.....	5
Clearances.....	6
Location.....	6
CODES AND STANDARDS.....	6
ASSEMBLY.....	7
FLUE CONNECTION.....	7
GAS CONNECTION.....	8
Quick-Disconnect for Units on Casters.....	8
GAS PRESSURE.....	8
TEST GAS SUPPLY.....	8
FRYERS WITH CASTERS.....	8
LEVELING THE FRYER.....	10
OPERATION.....	10
OVER-TEMPERATURE SHUTDOWN.....	10
BEFORE FIRST USE.....	10
Cleaning.....	10
FILLING TANK WITH SHORTENING.....	11
BASIC FRYING INSTRUCTIONS.....	11
Fry Basket Guidelines.....	12
EXTENDED SHORTENING LIFE.....	12
PROGRAMMING THE SOLID STATE CONTROL.....	13
PROGRAMMING THE COMPUTER CONTROL.....	14
FILTERING THE OIL.....	15
DRAINING THE TANK.....	16
BOIL OUT PROCEDURE.....	16
CLEANING.....	17
Daily.....	17
KLEENSCREEN <i>PLUS</i> ® INSTALLATION & OPERATION MANUAL....	16
GAS KLEENSCREEN <i>PLUS</i> ® MODELS.....	16
FILTERING INSTRUCTIONS FOR KLEENSCREEN <i>PLUS</i> ® FRYERS...	18
GENERAL.....	19
ASSEMBLY.....	19
OPERATION.....	20
FILTERING PROCEDURE.....	22
FILTERING SOLID STATE CONTROLS.....	23
FILTERING COMPUTER CONTROLS.....	24
FILTERING TIP.....	25
REMOVING EXCESS DEBRIS FROM THE FILTER.....	25
FLUSH AND DISCARD.....	25
BOIL OUT PROCEDURE.....	26
THERMAL OVERLOAD PROTECTION RESET BUTTON.....	25
MAINTENANCE.....	27
FLUE VENT INSPECTION.....	27
Service in the US and Canada.....	27
In Australia.....	27
Alarms and Error Messages.....	27
TROUBLESHOOTING.....	28
Troubleshooting Chart.....	28

INTRODUCTION

GENERAL

Vulcan Fryers are produced with quality workmanship and material. Proper installation, usage and maintenance will result in years of satisfactory performance.

Before installing the fryer, thoroughly read this manual and carefully follow all instruction.

This manual is applicable to model listed on the cover page. Procedures in this manual will apply to all models unless specified. Pictures and illustrations can be of any model unless the picture or illustration needs to be model specific.

ORDERING PARTS

Customers may order parts directly from their local authorized service center. If not known, call Vulcan Customer Service at 800-814-7028.

To speed up your order, provide the model number, serial number, gas type, part needed, item part number (if known) and quantity needed.

UNPACKING

This fryer was carefully inspected before leaving the factory. Upon acceptance of the shipment, the transportation company assumes full responsibility for safe delivery.

Immediately after unpacking the fryer, check for possible shipping damage. If the fryer is damaged, save the packaging material and contact the carrier within 15 days of delivery.

Check that the following have been included:

- ◆ Crumb Rack(s)
- ◆ Basket Hanger(s)
- ◆ Tank Brush
- ◆ Adjustable Casters (4) two locking, two non-locking for freestanding fryers. Fryer Batteries with the KleenScreen *PLUS*® Filtration System have casters installed from the factory.
- ◆ Drain Pipe Extension for freestanding fryers only.
- ◆ Twin Fry Baskets (2) per fry tank
- ◆ Cleanout Rod
- ◆ Crumb Scoop
- ◆ Fryer Batteries with the KleenScreen *PLUS*® Filtration System
 - Filter Pan
 - Suction Tube
 - Screen Assembly
 - Complimentary Pack of Micro-Filtration Envelopes
 - 6' high temperature discard hose
- ◆ Manual, Quick Start Guide(s), and Warranty – Keep in safe place for future reference.

INSTALLATION

Do not use the door or its handle to lift the fryer.

Before installing the fryer, verify that the type of gas (natural or propane) agrees with the specifications on the fryer data plate, which is located on the inside of the door panel. Make sure the fryer is configured for the proper elevation.

Record your fryer model, device, and serial numbers for future reference in the space provided below. This information can be found on the fryer data plate.

Fryer Model No: _____

Device: _____

Serial No: _____

Clearances

- ◆ Minimum clearance from combustible construction:
 - 6" (15 cm) from the sides of the fryer
 - 6" (15 cm) from the back of the fryer
 - The fryer may be installed on combustible floors
- ◆ Minimum clearance from noncombustible construction:
 - 0" from the sides of the fryer
 - 0" from the back of the fryer
- ◆ Between the fryer and any open-top flame units:
 - 16" (41 cm)
- ◆ Allow space for servicing and operation.

Location

- ◆ Install fryer in an area with sufficient air supply for gas combustion at fryer burners.
- ◆ Do not obstruct the flow of combustion and ventilation air.
- ◆ Provide adequate clearance for air openings into the combustion chamber.
- ◆ Do not permit fans to blow directly onto fryer.
- ◆ Avoid wall-type fans, which create cross-currents within a room. Avoid open windows next to sides or back.

CODES AND STANDARDS

The fryer must be installed in accordance with:

In the United States:

- ◆ State and local codes, or in the absence of local codes, with:
- ◆ National Fuel Gas Code, ANSI-Z223.1/NFPA #54 (latest edition). Copies may be obtained from The American Gas Association Accredited Standards Committee Z223, @ 400 N. Capital St. NW, Washington, DC 20001 or the Secretary Standards Council, NFPA, 1 Batterymarch Park Quincy, MA 02169-7471.
- ◆ NFPA Standard #96 Vapor Removal from Cooking Equipment, latest edition, available from the National Fire Protection Association, Batterymarch Park, Quincy, MA. 02169-7471.
- ◆ National Electrical Code, ANSI/NFPA-70 (latest edition). Copies may be obtained from The National Fire Protection Association, Batterymarch Park, Quincy, MA. 02169-7471.
- ◆ In the commonwealth of Massachusetts all gas appliances vented through a ventilation hood or exhaust system with a damper or with a power means of exhaust shall comply with 248 CMR.

In Canada:

- ◆ Local codes
- ◆ CAN/CSA-B149.1 Natural Gas Installation (latest edition).
- ◆ CAN/CSA-B149.2 Propane Installation Code (latest edition), available from the Canadian Gas Association 178 Rexdale Blvd., Etobicoke, Ontario Canada M9W 1R3.
- ◆ CSA C22.1 Canadian Electric Code L4W 5N6.

ASSEMBLY

The fryer must be restrained to prevent tipping and the splashing of hot liquid. The means of restraint may be the manner of installation, such as connection to a battery of appliances, installing the fryer in an alcove, or by separate means such as adequate ties.

FLUE CONNECTION

Make the flue connection as follows:

- ◆ Comply with *Vapor Removal from Cooking Equipment*, ANSI-NFPA Standard #96 (latest edition), available from the National Fire Protection Association, Batterymarch Park, Quincy, MA 02269.
- ◆ Locate the fryer under a hood with adequate connection to an exhaust duct. The hood must extend 6" (15 cm) beyond fryer on both sides.
- ◆ Clearance above the fryer should be adequate for combustion byproducts to be removed efficiently.
- ◆ An 18" (46 cm) minimum clearance should be maintained between the flue vent and the filters of the hood venting system.
- ◆ Never make flue connections directly to the fryer.
- ◆ Do not obstruct the flow of the gases from the appliance. Proper air balance should be maintained in the room.

ELECTRICAL CONNECTION

WARNING

Electrical Grounding Instructions:

This appliance is equipped with a three prong (grounding) plug for your protection against shock hazard and should be plugged directly into a properly grounded three-prong receptacle. Do not cut or remove the grounding prong from this plug.

Electrical diagram located on inside of door.

GAS CONNECTION

NOTICE All gas supply connections and any pipe joint compound must be resistant to the action of propane gases.

The gas inlet is located on the lower rear of the fryer. Codes require that a gas shutoff valve be installed in the gas line ahead of the fryer.

The gas supply line must be at least the equivalent of ½" (12.7 mm) iron pipe for single units and 1-1/4" (31.75 mm) for batteries. If using the optional quick-disconnect flex hose, ¾" (19 mm) iron pipe for single units and 1-1/4" (31.75 cm) iron pipe for batteries.

Make sure the pipes are clean and free of obstructions, dirt, and piping compound. A battery requires one or two connections of appropriate size for the gas requirement.

 WARNING Prior to lighting, check all joints in the gas supply line for leaks. Use soap and water solution. Do not use an open flame.

After piping has been checked for leaks, fully purge gas pipes to remove air.

GAS PRESSURES (ALL MODELS):

The gas pressure should be set at 4" W.C. (Water Column) (0.8 kPa) for natural gas and 10" W.C. (2.75 kPa) for propane gas. If incoming pressure exceeds ½ PSI (3.45 kPa), an additional pressure regulator must be installed.

TESTING THE GAS SUPPLY PIPING SYSTEM:

When test pressures exceed ½ PSI (3.45 kPa), the fryer and its individual shutoff valve must be disconnected from the gas supply piping system.

When test pressures are ½ PSI (3.45 kPa) or less, the fryer must be isolated from the gas supply piping system by closing its individual shutoff valve.

Fryers with Casters:

Separate instructions for installing casters are included with the casters:

- ◆ The installation shall be made with a connector that complies with the Standard for Connectors for Movable Gas Appliances, ANSI Z21.69 or Connectors for Moveable Gas Appliances, CAN/CGA-6.16, and a quick-disconnect device that complies with the Standard for Quick-Disconnect Devices for Use with Gas Fuel, ANSI z21.41 or Quick-Disconnect Devices for Use with Gas Fuel, CANI-6.9.
- ◆ When installing a quick disconnect you must also install a means for limiting the movement of the fryer. This device will prevent the gas line or quick disconnect from being strained. The restraining device should be attached to the cutout on the back panel. See illustration for location.

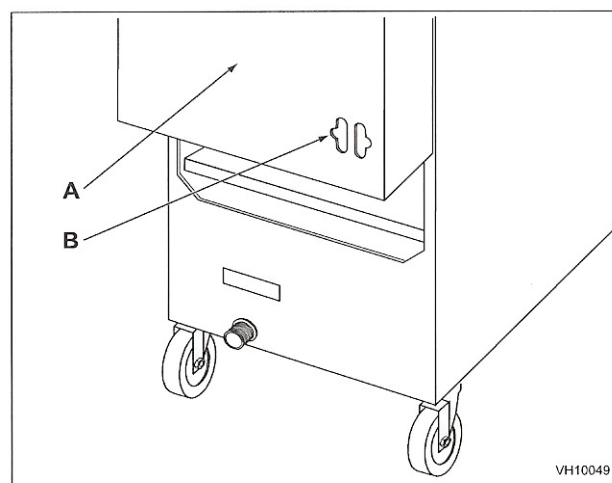

- A Rear of Fryer**
- B Strain Relief Chain Connection
(Chain supplied by others)**

- ◆ In Australia, use only the caster supplied by the manufacturer for the fryer device. The fryer must be installed using a hose assembly restraining device to limit the movement of the appliance in accordance with AS1869.
- ◆ The fryer must be installed with a connector (not supplied by Vulcan) complying with the above codes.
- ◆ The fryer must be installed with restraining means to guard against transmission of strain to the connector. See illustration.
- ◆ The fryer must be installed with the casters provided.
- ◆ If the restraint is ever to be disconnected, first turn the gas supply off.

LEVELING THE FRYER

Check the level of the fryer by placing a level on top of the fryer after gas connections have been made.

Ensure that the fryer is level front-to-back and side-to-side in the final installed position.

If using casters, lock the wheels after unit is level.

OPERATION

⚠ WARNING Hot oil and parts can cause burns. Use care when operating, cleaning and servicing the fryer.

⚠ WARNING Spilling hot frying compound can cause severe burns. Do not move fryer without draining all frying compound from the tank.

OVER-TEMPERATURE SHUTDOWN

If the shortening becomes overheated, a high-temperature shutoff device will turn the gas valve off and extinguish the pilot.

If the fryer shuts down due to overheating, DO NOT power up the pilot until the shortening temperature is below 300°F (149°C).

If an overheating situation persists, contact your local Vulcan-Hart authorized service office.

BEFORE FIRST USE

Cleaning

New units are wiped down at the factory to remove any visible signs of dirt, oil, grease, etc. remaining from the manufacturing process.

Before any food preparation, thoroughly wash the protective oil from all surface parts and the tank interior with hot soapy water to remove any film residue and dust or debris.

NOTICE Do not use chlorine or sulfate/sulfide cleaners.

- ◆ Wash any accessories shipped with unit.
- Rinse fryer and accessories thoroughly and drain the fryer.
- ◆ Wipe tank completely dry with a soft, clean cloth.

FILLING TANK WITH SHORTENING

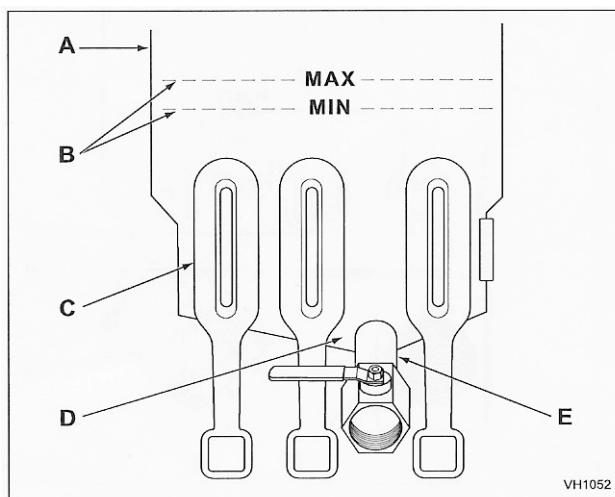

- A Fryer Tank
- B MIN and MAX Fill Level Lines
- C Heat Pipes
- D Cold Zone
- E Drain Pipe

- ◆ Close the drain valve.
- ◆ Fill the fryer tank with liquid shortening.
- ◆ Shortening level should be between the min and max lines in the fryer tank.
- ◆ Shortening will expand when heated. Do not fill the fryer tank past the MAX line.
- ◆ Add fresh shortening as needed to maintain oil level.

BASIC FRYING INSTRUCTION

- ◆ Set the desired temperature and allow shortening to heat up to that temperature.
- ◆ Fry items that are the same size to ensure equal doneness.
- ◆ Drain or wipe dry raw or wet foods to minimize splatter when lowering into hot shortening.
- ◆ Add fresh shortening as needed.

Fry Basket Guidelines

- ◆ Do not overfill baskets. (See table for recommended basket capacities below) Carefully lower basket into oil.
- ◆ When frying doughnuts and fritters, turn product only once during frying.
- ◆ When cooking French fries or onion rings, shake the basket several times.
- ◆ Batter covered foods should be dropped carefully, one by one, into shortening or basket. If you use the basket, first dip the basket into the shortening to reduce batter-build up on basket surfaces.
- ◆ When frying is completed, remove basket or product. Hang basket on rear hanger.

Fry Basket Capacity:

1GR45D / C: Recommended pounds per basket are 2.5 lbs. (1.1 kg).

1GR65D / C: Recommended pounds per basket are 3.0 lbs. (1.4 kg).

1GR85D / C: Recommended pounds per basket are 3.5 lbs. (1.6 kg).

EXTENDING SHORTENING LIFE

Shortening life can be extended by the following guidelines:

- ◆ Do not salt foods over the fryer.
- ◆ Use good-quality shortening.
- ◆ Filter shortening daily (at a minimum).
- ◆ Replace shortening if it becomes poorly flavored.
- ◆ Keep equipment and surrounding clean. Use tank covers when not in use. (accessory).
- ◆ Set thermostat correctly.
- ◆ Remove excess moisture and particles from food products before placing on fryer.

TURNING ON THE FRYER

- ◆ Open the door to the fryer. Turn the power switch to the on position.
- ◆ Set temperature by turning the knob to the desired temperatures. The burners will light automatically.
- ◆ The burners will cycle on and off, maintaining the set temperature.

EXTENDED SHUTDOWN

1. Thoroughly drain the fryer. Refer to DRAINING THE FRYER.
2. Clean the fryer according to CLEANING.
3. Turn off the main gas shutoff valve.

FILTERING THE OIL

▲ WARNING Hot oil and hot parts can cause burns. Use care when operating, cleaning, and servicing the fryer.

Filter shortening at least once a day.

1. Do NOT turn off the power to the fryer. Leave power on.
2. Insert the drain extension into the drain valve. Tighten only hand tight.
3. Direct the drain extension into the mobile filtering device that you want to use.
4. A cold fryer will not drain properly. Always filter shortening between 250°F and 350°F. The shortening in the cold zone area will remain hard if the heat is only on for a few minutes. If necessary, use the clean-out rod to carefully move the hard shortening to an area above the cold zone where it will melt.
5. Use the provided crumb scoop to remove the heavy debris lying on the bottom of the tank.
6. Slowly open the drain valve to allow oil to flow from the fry tank to the filter pan. Then open the drain valve all the way. Please note the gas burners will automatically turn off at this point and DRAINING will appear on the digital display for solid state models and DRAINING OIL will display on computer models.
7. When fry tank is empty use the tank brush to remove any additional debris.
8. Close the drain valve. The display will change to; FILL TANK for solid state models and FILL TANK for computer models.
9. Fill tank with new shortening. Fill to a minimum of the MIN level but no high that halfway between MIN and MAX. Oil will expand as it is heated.
10. Press the Temp button on the display. The display will ask if the tank is full;
TANK FULL
11. Press the TEMP button on the display a second time to confirm that the oil level is correct in the fry tank. Once pressed, the gas burners will ignite and begin heating the oil to desired temperature.

Programming the Solid State Control

Programming in 7 Easy Steps (for revisions V3.00 or higher)

STEP 1

Fill fry tank with oil and then turn power on





Display will scroll through VULCAN > FRYERS > Rev. No. > MELT CYCLE LIQUID

STEP 2-7

PROGRAMMING MODES

To make changes to your program:

1. If display is locked it must be unlocked using the unlock code.

To UNLOCK this control you must quickly press the

LEFT LEFT RIGHT RIGHT

buttons while the word 'LOCKED' is displayed

UNLOCK CODE

2. After unlocking go to steps 2 - 7

2 Press  program button to enter the program mode: **LEFT TIMER** displays

Press  to increase time.

Press  to decrease time.

Press  to go to Step 3.

3 **RIGHT TIMER** displays

Press  to increase time.

Press  to decrease time.

Press  to go to Step 4.

4 **TEMPERATURE SETTING** displays

Press  to increase temp.

Press  to decrease temp.

Press  to go to Step 5.

5 **MELT CYCLE** displays

Press  to change to "S" Solid.

Press  to change to NO MELT.

Press  to change to "L" Liquid.

Press  to go to Step 6.

6 **UNLOCK** displays

Press  to LOCK.

Press  to UNLOCK.

Press  to go to Step 7.

7 Press  button and **HOLD FOR 3-5 seconds** to save and exit program mode.

Note: Programming modes can be initiated while the fryer is ON by pressing the  button. If 'LOCKED' appears refer to 'UNLOCK' code.

Note: VULCAN recommends keeping the controls LOCKED after programming to prevent altering

OPTIONAL DISPLAY MODES

After the program mode is completed, one of the following screens will be displayed.

TEMPERATURE SETTING RESULTS

Results of programming for oil temperature is at set temperature



Display shows ACTUAL TEMPERATURE

MELT CYCLE RESULTS

Results of programming MELT L



Display says MELT L

Results of programming MELT S



Display says MELT S

Results of programming NO MELT



Display says HEATING if oil temperature is below 135 ° F

TO STOP A TIMER ONCE THE COUNTDOWN SEQUENCE HAS STARTED:

Press and hold the timer button until timer is reset and flashing light goes OFF.

LEFT TIMER BUTTON



LEFT

LIGHTS

RIGHT TIMER BUTTON



RIGHT

Programming the Computer Control



PROGRAMMING in 7 Easy Steps (for revisions V1.06 or higher)

START
Fill fry tank with oil and then turn power on.

Display will scroll through VULCAN FRYER ▶ Rev. No. ▶ MELT CYCLE LIQUID

DISPLAY PANEL CONTROL GUIDE

TEMPERATURE BUTTON, PROGRAM BUTTON, RED LED LIGHT, TOGGLE BUTTON, MENU ITEMS, LEFT & RIGHT ARROW KEYS, DISPLAY, FILTER BUTTON

STEP 1-7 PROGRAMMING MODES

UNLOCK CODE
1. If display is locked it must be unlocked using the unlock code.

To UNLOCK this control, press buttons 1 2 3 4 while the word 'LOCKED' is displayed

2. After unlocking go to steps 1 - 7

TO REVIEW SETTINGS:

To REVIEW SETTINGS, press the OIL TEMP button. ACT temperature displays. Set temperature displays.

Hit ◀ LEFT or RIGHT ▶ arrow, followed by desired product key 1 - 0. Display will scroll through settings for Time, Shake, Hold, and Cook Cycle.

1 Press program button (P). USER SETTINGS displays. To set cook temperature, press 1. The current temperature will begin to flash. Type in the revised temperature. Press (P) to save your new cook temperature.

2 To set the melt cycle, press 2. The LIQUID display will begin to flash. Press the (L) button to select, LIQUID, SOLID, and NO MELT options. Press (P) to save your melt cycle.

3 To set Cook Time manually, press 3. SELECT MENU ITEM will display.

4 Press the program button (P). USER SETTINGS displays. To Lock control or keep the computer UNLOCKED press 4. The current setting will flash and will sound. Press the (L) button to select YES or NO. Press (P) to save your selection.

5 To adjust the Beeper VOLUME, press 5. The current setting will flash and will sound. Press the (L) button to select 1, 2 or 3. Press (P) to save your selection.

6 To set Language, press 6. The current setting will flash. Press the (L) button to select ENGLISH, SPANISH, or FRENCH. Press (P) to save your selection.

7 To set the IDLE SETBACK, press 7. The current time will flash. Type in the new IDLE TIME (10-99 minutes). Press (P) to save your new IDLE SETBACK time. Press (P) again to SAVE ALL OF YOUR SETTINGS and exit the programming mode. MENU ITEMS will display.

NAME EDITING KEYS
1. MOVE CURSOR
2. CHANGE TEXT
3. SPACE

3a Press 1 to edit the NAME of the menu item and follow the directions on the right display. To change the letters press button 1 move towards the beginning of the alphabet and button 2 to move towards the end of the alphabet. The LED above the button selected for the menu item to be edited will be lit and the available parameters for editing will be listed in the right display. Press (P) to save the new NAME of the menu item.

3b Press 2 to change the COOK TIME. The current time will flash. Type in the new COOK TIME. Press (P) to save your new COOK TIME.

3c Press 3 to edit the SHAKE TIME. The current shake time will flash. Type in the new SHAKE TIME. Press (P) to save your new SHAKE TIME.

3d Press 4 to change the HOLD TIME. The HOLD TIME will flash. Type in the new HOLD TIME. Press (P) to save your new HOLD TIME.

3e Press 5 to choose COMPENSATING TIME or ACTUAL TIME. YES will begin to flash. Press the (L) button to select YES for COMP TIME or NO for ACTUAL TIME. Press (P) to save your selection. Press (P) again to exit MENU ITEM SELECTION and return to SELECT MENU ITEMS.

MENU ITEM SETTINGS
1. NAME
2. COOK
3. SHAKE
4. HOLD
5. COMP

Select an item to be edited by pressing the corresponding number 1-10. The menu will change to allow edits to the menu item selected using the MENU ITEM SETTINGS in the right display.

OFFLINE PROGRAMMING WITH SOFTWARE MENU PROGRAM:
(Desktop or Laptop computer required. Menu Programming Software supplied with fryer.)

To load a new product menu using the software menu program offline with a desktop or laptop computer:

- Press (P) USER SETTING displays.
- Select 3. MENU ITEMS.
- Insert USB memory drive with the new product menu files into USB Port.
- Press (L) button to display available product menu files by saved name.
- Press 1 - 0 to select the new product menu name.
- Press arrows ◀ ▶ to confirm selection within 23 seconds while the menu selected is flashing.
- Remove USB memory drive.

OPERATION TIPS:

- To scroll through Menu Items 1-10 press the (L) button.
- To activate a cook cycle timer press a button 1 - 0. First push the desired cook timer button and then press (L) or (R) corresponding to which basket is being used. Example: 2 (L), 5 (R). NOTE: You can use the same button for both (L) and (R) baskets. For example, 4 (L), 4 (R).
- To cancel a cook timer, press and release the (L) or (R) button and the corresponding number button 1 - 0. The timer will stop and reset.
- With single basket lift fryers only press timer buttons 1 - 0 to activate the basket lift. There is no need to use the (L) and (R) buttons. To cancel the timer, press the same button again and the basket will raise up.
- Product keys blink when activated and are solid when programming.
- To silence alarm when timer is complete, press flashing menu item.
- VULCAN recommends keeping the controls LOCKED after programming to prevent altering.

F-32979 (August 2010)

www.vulcanequipment.com • Fryer Technical Support: 1-800-814-2028

DRAINING THE TANK

1. Turn off fryer.
2. Insert the drain extension into the drain valve. Tighten only hand tight.
3. Direct the drain spout into the container that you want to drain the shortening into.
4. Open the drain valve. The oil will drain into the container. When the container is full or the fryer tank is empty, close the drain valve. Repeat this step until the fryer is empty. Remove the drain extension and place it back into the provided holder.
5. It is recommended to now Boil Out your fry tank. Follow the Boil Out procedure. Then perform the weekly clean-out as described under CLEANING.
6. Once tank is completely empty, boiled out and cleaned, add new shortening. Turn on the power switch to begin heating the oil to desired temperature.

BOIL OUT PROCEDURE

Weekly or when oil is replaced:

1. Drain the tank as described under FILTERING THE OIL and instead of replacing the shortening with new oil fill with water
2. Close the drain valve and fill tank with water. Use recommended Vulcan's Boil-Out solid degreaser low foaming cleaner tablets part number 956812-1 which can be ordered from your local dealer. Follow the instructions on the side of the package.

NOTICE Do not use chlorine or sulfate/sulfide cleaners.

3. Solution level must be between the MIN and MAX levels on the fryer tank.
4. After pressing the TEMP button for the second time confirming that the boil out solution level is correct the gas burners will begin to heat the water solution. The fryer controls will be able to sense that there is a water mix solution vs. oil and will automatically set the correct temperature. There is NO need to change the set temperature from the last set operating temperature. Allow solution to simmer for about 15 to 20 minutes. Use a tank brush to clean the sides, back, front, and heat exchanger tubes.
5. With the drain extension tightened into the drain valve, drain and discard the cleaning solution from the tank.
6. Close the drain valve and refill the tank with water. Add 1 cup (1/4 L) of vinegar to neutralize alkaline left by the cleaner. Solution level must be between the MIN and MAX level on the fryer tank. Press the TEMP button to confirm the vinegar level is correct.

7. Press the TEMP button again and the gas burners will heat the solution. Bring the solution to a simmer only. Allow to stand for a few minutes.
8. Turn OFF the power to the fryer. Drain the tank according to DRAINING THE TANK. Rinse thoroughly with clear, hot water. All traces of cleaner must be removed. Dry the tank thoroughly.
9. Close the drain valve and add shortening. Follow the FILLING TANK WITH SHORTENING procedure in this manual. The fryer is now ready for use.

CLEANING

⚠ WARNING Hot oil and hot parts can cause burns. Use care when operating, cleaning, and servicing the fryer.

Daily

Clean your fryer regularly with the tank brush along with a damp cloth, and polish with a soft dry cloth. If regular cleaning is neglected, grease will be burned on and discolorations may form.

Fingerprints are sometimes a problem on highly polished surfaces of stainless steel. They can be minimized by applying a cleaner that will leave a thin oily or waxy film.

- ◆ Clean all exterior surfaces of your fryer at least once daily.
- ◆ Use a damp cloth with warm water and a mild soap or detergent.

NOTICE Do not use chlorine or sulfate/sulfide cleaners.

- ◆ Rinse thoroughly, and then polish with a soft dry cloth.
- ◆ Keep the fryer exterior clean and free of accumulated grease to prevent stubborn stains from forming. If regular cleaning is neglected, grease will be burned on and discolorations may form.
- ◆ Remove discolorations by washing with any detergent or soap and water.
- ◆ Use a self-soaping, non-metallic scouring pad for particularly stubborn discolorations.
- ◆ Always rub with the grain of the stainless steel.
- ◆ Do not use a metallic scoring pad or harsh cleaners.

KleenScreen *Plus*® Filtration System Installation and Operational Manual for “DF” and “CF” Models GRD/CF



2GR45DF Shown

GAS KleenScreen *PLUS*® Models:

1GR45DF	ML-136778
1GR45CF	ML-136791
1GR65DF	ML-136789
1GR65CF	ML-136792
1GR85DF	ML-136790
1GR85CF	ML-136793
2GR45DF	ML-136424
2GR45CF	ML-136431
2GR65DF	ML-136425
2GR65CF	ML-136432
2GR85DF	ML-136426
2GR85CF	ML-136433
3GR45DF	ML-136427
3GR45CF	ML-136434
3GR65DF	ML-136428
3GR65CF	ML-136435
3GR85DF	ML-136429
3GR85CF	ML-136436
4GR45DF	ML-136430
4GR45CF	ML-136437

Filtering Instructions for KleenScreen *PLUS*® Fryers

General

The KleenScreen *PLUS*® filtration system filters the oil as it is pumped back into its' respective tank(s). Only one tank can be drained and filtered at a time. Under no circumstances should both tanks be drained at the same time.

Assembly

- After unpacking, wash the filter pan, crumb basket and filter screen assembly. Make sure you remove the insert located inside the filter screen. Use dishwashing detergent and warm water, (parts are dishwasher safe). Rinse the filter pan, crumb basket and filter screen components completely and wipe all parts dry with a clean cloth.
- Pull out the filter drawer all the way leaving the filter pan opening exposed.
- Place the filter tank into the filter drawer making sure that the pins on the bottom of the filter pan line up with the holes in the filter drawer. Position the filter screen assembly into the suction tube clip in the filter pan positioning the filter screen assembly flat on the bottom of the filter pan. Place the primary crumb basket onto the left handle of the filter pan.
- Carefully line up the suction tube nozzle so that it mates with the oil receptacle block mounted on the frame of the fryer battery. Close the drawer. See Figures 1, 2 3 and 4.

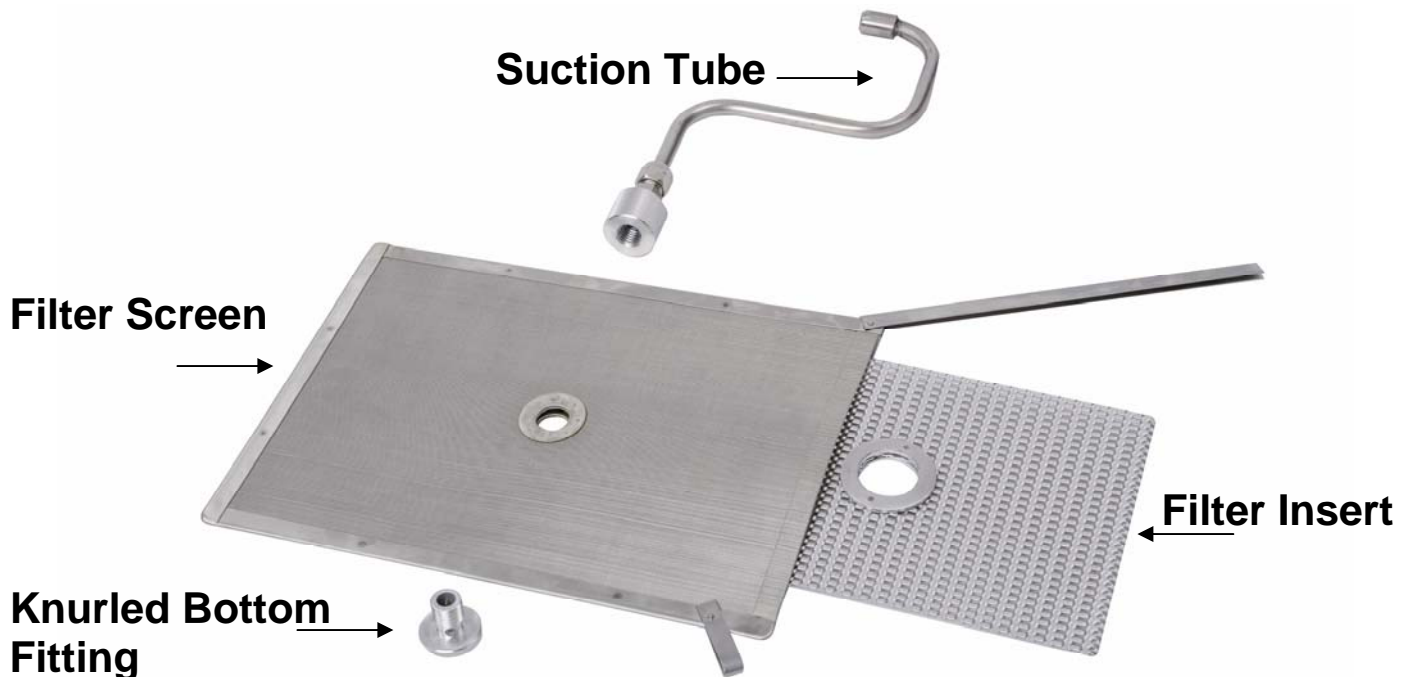

Fig. 1

Fully assembled filter screen assembly:



Fig. 2

Secure Tube with Suction Tube Clip

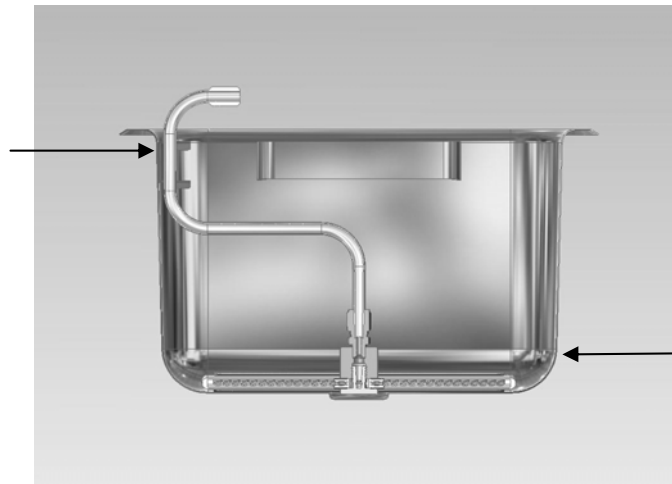

Filter Screen Lays Flat On Bottom of Filter Pan

Fig. 3

Micro-Filtration Fabric Envelope Assembly:

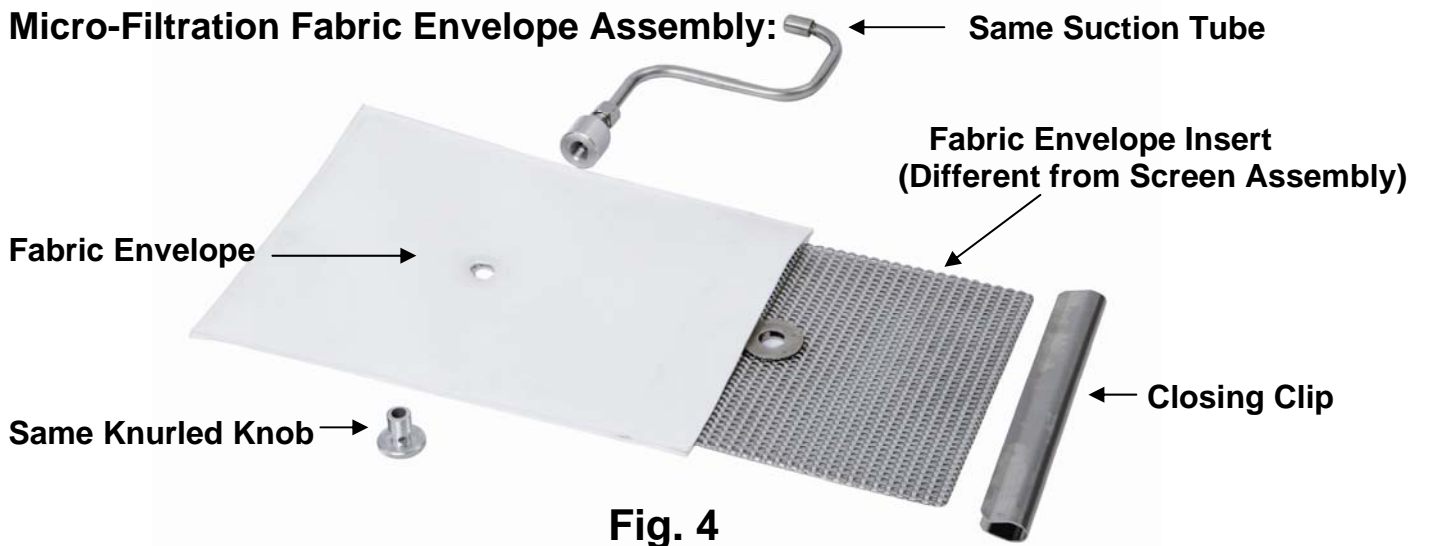

Fig. 4

INSTRUCTIONS TO REMOVE & REPLACE KLEENSCREEN *PLUS*® FILTER ENVELOPE

FOR ABSOLUTE FILTRATION & MAXIMUM FLOW RATE WE RECOMMEND YOU CHANGE YOUR FILTER ENVELOPES AT EVERY OIL CHANGE (10-14 DAYS DEPENDING ON OIL USAGE).



Step 1

Discard all oil from the filter vessel, (see pages 23 or 24). When the filter pan is empty, use a spatula and scrape off all debris left on the filter envelope and in the filter pan.



Step 2

Unscrew "S" Tube from filter by turning the Bottom Knurled fitting counter- clockwise.



Step 3

Remove SST Closure Clip by lifting off one side.



Step 4

Remove SST Filter Screen Insert and wash insert with hot water and dry thoroughly. The Filter Screen Insert is dishwasher safe. Place the insert into a new KleenScreen *PLUS*® Filter envelope.

DO NOT WASH FABRIC ENVELOPE



Step 5

Place Filter Screen Insert into the fabric envelope making sure that the holes line up. Fold over the other end of the envelope and place SST Closure Clip on – hinge over and firmly press clip all the way down to secure and seal filter assembly. Making sure that the folded end is face down; screw "S" Tube Assembly onto the Filter Assembly. Tighten the Bottom Knurled fitting. When tightened, the "S" Tube assembly should be perpendicular to the long side of the filter assembly.

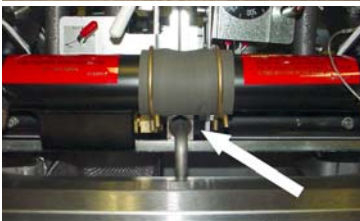

Step 6

Reposition the filter tube into the provided clip. Align filter tube so that the end of the "S" Tube engages the Oil Receptacle fitting each time the drawer is opened and closed.

Operation

⚠ WARNING Hot oil and parts can cause burns. Use care when operating, cleaning and servicing the fryer.

⚠ WARNING Spilling hot frying compound can cause severe burns. Do not move fryer without draining all frying compound from the tank.

NOTICE Never run water or boil out solution through filter and motor / pump. Doing so will void your fryer warranty.

FILTERING PROCEDURE

Oil Temperature should be 300-350° F. Use the provided crumb scoop to remove and suspend crumbs on the bottom of the tank before proceeding to Step 1.

1. Do not turn off the Fryer. The power must be on throughout the entire filtering process.

NOTICE Do **NOT** heat the fryer during the filtering procedure. Permanent damage to your fry tank may occur and warranty may be voided.

2. Vulcan recommends adding an oil treatment media to the oil prior to filtering.
3. Make sure that the filter drawer is closed completely and that the suction tube and receptacle block are in the correct position. Fig. 5

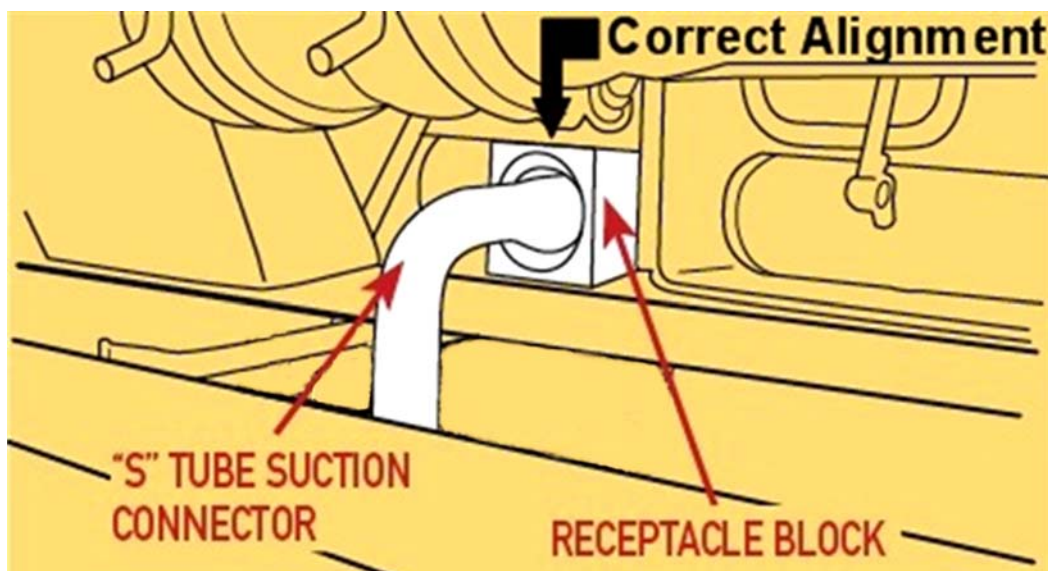

Fig. 5

Filtering Instructions for KleenScreen PLUS® Fryers with Solid State Controls

VULCAN FRYERS

SOLID STATE CONTROLS GUIDE



FILTERING in 7 Easy Steps (for revisions V3.00 or higher)

STEPS 1-3

TIP: Use provided crumb scoop to remove and suspend crumbs on the bottom of tank before proceeding to Step 1.

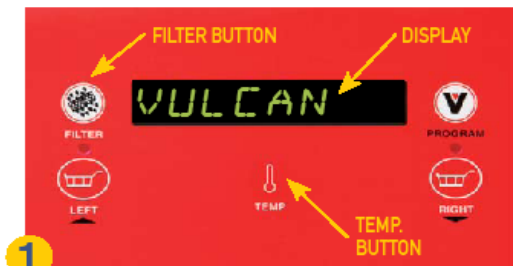

1 Make sure that the Power Switch is in the "ON" position. Fryer must have power to operate the motor/pump. Fryer Temperature should be between 300-350 Degrees Fahrenheit. **RECOMMENDED: ADD OIL TREATMENT MEDIA.**

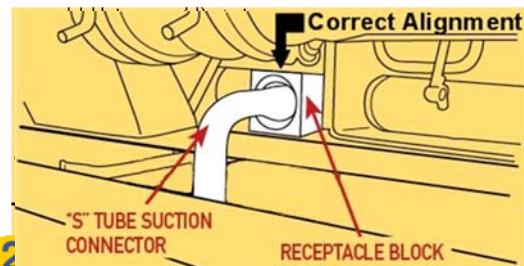

2 Open the fryer doors and ensure that the filter drawer is pushed back into place under the fryer with the "S" Tube Suction Connector and Receptacle Block engaged.



- Turn the drain valve to allow the oil to drain into the filter pan below. The burners will automatically turn off.
 - While draining the tank, use the provided tank brush to move the residue at the bottom and sides of the tank down into drain tube.
 - To turn on the filter motor/pump, push the FILTER button located on the control panel, holding it for approximately 3 seconds.
 - Allow the oil to cycle through the filtering operation for about 3 minutes or until satisfied that the oil and fry tank are clean. **DRAINING** displays.
- TIP:** Use provided tank brush to clean and remove food particles on the fry tank.

STEPS 4-7



4 When filtering is finished, close the red drain valve by turning the red drain handle. **FILL VAT** displays.

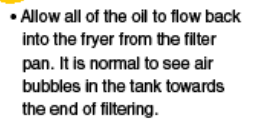

- Allow all of the oil to flow back into the fryer from the filter pan. It is normal to see air bubbles in the tank towards the end of filtering.
- When the filter pan is empty, push the FILTER button to turn off the motor/pump.
- Oil level should be between the Min/Max lines on the tank back. **VAT FULL** displays. (Display is asking if the tank is full).



Once the oil level has been checked and verified, press the TEMP button. The burners will automatically turn back on and the fryer will resume heating. **HIT TEMP** displays.



After pressing the TEMP button the fryer resumes heating. **HEATING** displays.

DRAINING AND DISCARDING OIL FROM THE FRYER

- Follow filtering instructions steps **2-4**, however **DO NOT** put oil treatment media into fryer. Drain the fryer oil into the filter pan.
- Attach the quick disconnect hose to the discard male quick disconnect fitting, (hose not supplied with fryer - Accessory option).
- Place other end of the discard hose into a container that is large enough to retain the discarded shortening.
- To start the discard operation, pull the yellow "DISCARD" handle lever rod towards you.
- Look for the decal on the front control panel that reads: **ATTENTION: USE THIS FILTER BUTTON WHEN DISCARD/FLUSHING FRY TANK.**
YOU MUST USE THIS FILTER BUTTON TO DISCARD THE OIL.
 Press the FILTER button and hold for approximately 3 seconds to activate the motor/pump. Oil will begin to flow through the hose and into the container. PLEASE NOTE that the display will not change for this operation.
- To turn off the motor/pump, simply push the FILTER button again and then push the yellow "DISCARD" lever rod back in. Disconnect the discard hose. Be careful to let the hose drain before putting away. Close the drain valve and refill the fry tank with new oil.

NOTE: If discard vessel is not large enough to hold the entire shortening amount, stop the flow by pushing the FILTER button to turn the motor/pump off. Empty the container and resume discard operation by pushing the FILTER button and holding it for approximately 3 seconds. **THESE INSTRUCTIONS ARE FOR FRYERS WITHOUT REAR OIL RECLAMATION CONNECTIONS.**

WARNING:

- **HOT FRYING COMPOUND AND PARTS CAN CAUSE BURNS. USE CARE WHEN OPERATING, CLEANING, OR SERVICING THE FRYER. USE CARE WHEN FILTERING. DO NOT LEAVE UNATTENDED.**
- **SPILLING HOT FRYING COMPOUND CAN CAUSE SEVERE BURNS. DO NOT MOVE THE FRYER WITHOUT FIRST DRAINING ALL FRYING COMPOUND FROM TANK.**

IMPORTANT: IF POWER IS MISTAKENLY TURNED OFF DURING THE FILTERING OPERATION, THE CORRECTIVE ACTION IS AS FOLLOWS:

1. CLOSE DRAIN VALVE
2. TURN POWER SWITCH ON
3. **IMMEDIATELY OPEN DRAIN VALVE**
4. CONTINUE FILTERING OPERATION PER STEPS 1-7

NOTE: WHEN USING SOLID SHORTENING, THE SHORTENING MUST BE LIQUIFIED BEFORE FILTERING.

VULCAN FRYERS

COMPUTER CONTROLS GUIDE



FILTERING in 6 Easy Steps (for revisions V1.06 or higher)

STEPS 1-3

TIP: Use provided crumb scoop to remove and suspend crumbs on the bottom of tank before proceeding to Step 1.



Make sure that the Power Switch is in the "ON" position. Fryer must have power to operate the motor/pump. Fryer Temperature should be between 300-350 Degrees Fahrenheit. **RECOMMENDED: ADD OIL TREATMENT MEDIA.**

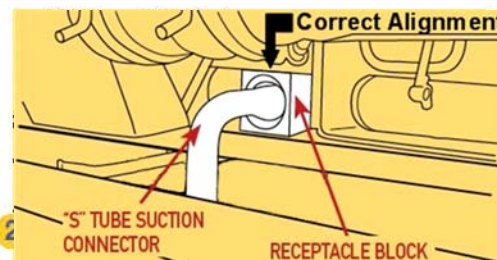

Open the fryer doors and ensure that the filter drawer is pushed back into place under the fryer with the "S" Tube Suction Connector and Receptacle Block engaged. Filter switch behind the door must be in the filter position (not on hose).



- Turn the drain valve to allow the oil to drain into the filter pan below. The fryer will automatically turn off.
- While draining the tank, use a crumb scoop to move the residue at the bottom and sides of the tank down into drain tube.
- To turn on the filter motor/pump, push the FILTER button located on the control panel, holding it for approximately 3 seconds.
- Allow the oil to cycle through the filtering operation for about 3 minutes or until satisfied that the oil and fry tank are clean. **DRAINING OIL** displays.

TIPS: Use provided tank brush to clean and remove food particles on the fry tank. Use provided clean-out rod to clear drain if clogging occurs.

STEPS 4-6



- When filtering is finished, close the red drain valve by turning the red drain handle. **FILL VAT** displays.
- Allow all of the oil to flow back into the fryer from the filter pan. It is normal to see air bubbles in the tank toward the end of filtering.



- When the filter pan is empty, push the FILTER button to turn off the motor/pump.
- Oil level should be between the Min/Max lines on the tank back. **VAT FULL ? PUSH TEMP** displays. (Display is asking if the tank is full.)



Once the oil level has been checked and verified, press the TEMP button. The fryer will automatically turn back on and the fryer will resume heating. **HEATING** displays if oil temperature is below set temperature.

DRAINING AND DISCARDING OIL FROM THE FRYER

- A** Follow filtering instructions steps 2 - 4, however DO NOT put oil treatment media into fryer. Drain the fryer oil into the filter pan.
- B** Attach the quick disconnect hose to the discard male quick disconnect fitting.
- C** Place other end of the discard hose into a container that is large enough to retain the discarded shortening.



D To start the discard operation, filter switch behind door must be in the hose position.

YOU MUST USE THE FILTER BUTTON ON THE COMPUTER CONTROL TO DISCARD THE OIL. Press the FILTER button on the computer control and hold for approximately 3 seconds to activate the motor/pump. Oil will begin to flow through the hose and into the container. PLEASE NOTE that the display will not change for this operation.



E To turn off the motor/pump, simply push the FILTER button on the computer control again. Push the filter switch behind door back to the filter position. Disconnect the discard hose. Be careful to let the hose drain before putting away. Close the drain valve and refill the fry tank with new oil.

WARNING: Hose connection will be HOT. Use protective heat resistant gloves when handling.

NOTE: If discard vessel is not large enough to hold the entire shortening amount, stop the flow by pushing the FILTER button to turn the motor/pump off. Empty the container and resume discard operation by pushing the FILTER button and holding it for approximately 3 seconds. **THESE INSTRUCTIONS ARE FOR FRYERS WITHOUT REAR OIL RECLAMATION CONNECTIONS.**

WARNING

HOT FRYING COMPOUND AND PARTS CAN CAUSE BURNS. USE CARE WHEN OPERATING, CLEANING, OR SERVICING THE FRYER. USE CARE WHEN FILTERING. DO NOT LEAVE UNATTENDED.

SPILLING HOT FRYING COMPOUND CAN CAUSE SEVERE BURNS. DO NOT MOVE THE FRYER WITHOUT FIRST DRAINING ALL FRYING COMPOUND FROM TANK.

IMPORTANT:

IF POWER IS MISTAKENLY TURNED OFF DURING THE FILTERING OPERATION, THE CORRECTIVE ACTION IS AS FOLLOWS:

1. CLOSE DRAIN VALVE
2. TURN POWER SWITCH ON
3. IMMEDIATELY OPEN DRAIN VALVE
4. CONTINUE FILTERING OPERATION PER STEPS 1-6

NOTE: NOT RECOMMENDED TO BE USED WITH SOLID SHORTENING.

FILTERING TIP:

Open the filtering drawer approximately 1" to allow any oil in the return line to run back into the filter pan. This will take about 30 seconds to complete. Then open the drawer completely to clean filter components.

REMOVING EXCESS DEBRIS FROM THE SCREEN FILTER:

1. Pull the filter drawer out and remove the crumb basket and empty any debris into the trash.
2. Remove the filter screen assembly. Scrape debris from the filter screen. Then remove the insert by unlatching the latch. Clean all parts thoroughly as mentioned in the Assembly section on page 19.
3. Scrape debris from the bottom of the filter pan and discard in the trash. Clean all parts thoroughly as mentioned in the Assembly section on page 19. Clean all parts thoroughly as mentioned in the Assembly section on page 19.
4. Reassemble all filter components after being dried thoroughly as in the Assembly section on page 19.

FLUSH AND DISCARD:

1. Follow filtering instructions 1-3, however do not put oil treatment media into the fryer. Drain the fryer oil into the filter pan.
2. Attach the quick disconnect hose to the discard male quick disconnect fitting, (hose not supplied with fryer – Accessory Option).
3. Place other end of the discard hose into a container that is large enough to retain the discarded shortening.
4. With the power switch still ON; pull the Yellow Discard Handle Lever Rod towards you. Use the control that is directly above the discard connection when flushing or discarding shortening. Press and hold the filter button for at least 3 seconds and the Motor/Pump will begin to operate. NOTE: Oil will come out immediately out of the nozzle end of the hose.
5. Once the oil has been discarded completely and the filter pan is empty, press the filter button to turn off the Motor/ Pump. Then push the Discard Lever back in.
6. Disconnect the discard hose. The hose connection will be hot due to the temperature of the oil that was discarded. Be careful to let the hose drain before putting away. Close the drain valve and fill the fry tank with new oil.

BOIL OUT PROCEDURE:

Use the Boil Out By-Pass™ drain extension allowing the boil out solution to exit the fry tank without using the filtering system. Do not allow water to run through the motor / pump. Drain the boil out solution into a bucket or place a hose on the end of the drain extension allowing the other end to flow into a floor drain. In Fig. 6 the arrow is pointing to the drain extension. It is threaded into the top coupling of the oil drain tube. Drain extension needs to be only hand tightened.



Fig. 6



Standard Hose End

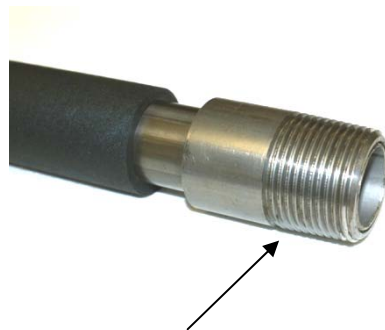

Drain Tube End

THERMAL OVERLOAD PROTECTION BUTTON:

The motor/pump supplied with the filtering system has a thermal overload protection circuit that senses when excess heat occurs due to filtering for long periods of time or under heavy load prior to discarding debris buildup. If the thermal overload protection is tripped, wait 5 minutes and then reset the motor by pushing in the red button. The arrow in Figure 7 shows the location of the reset button; located on the front off the motor / pump facing towards you.

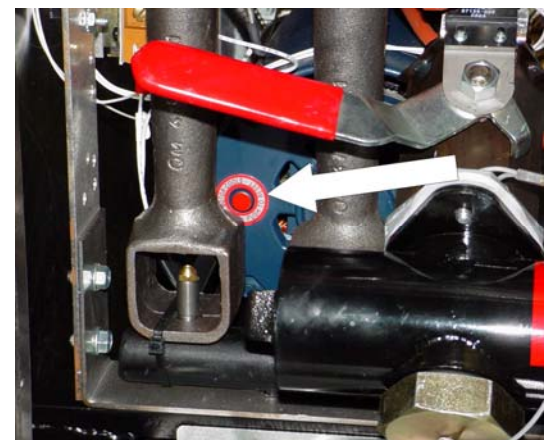

Fig. 7

MAINTENANCE

▲ WARNING Hot oil and hot parts can cause burns. Use care when operating, cleaning, and servicing the fryer.

▲ WARNING Spilling hot fryer compound can cause severe burns. Do not move fryer without draining all frying compound from the tank.

FLUE VENT INSPECTION

When the fryer is cool, inspect annually. Check the flue and clear any obstructions.

Service in the US and Canada

Contact you local Vulcan-Hart Service office or address on the front of this manual.

In Australia

Contact Hobart Food Equipment PTY. LTD., 16 Hilly Street Morlake, N.S.W. 2137 Australia; P.O. Box 100, Concord N.S.W. 2137; Tel: (02) 9736 1200; Fax: (02) 9736 1555.

www.hobartfood.com.au

ALARMS AND ERROR MESSAGES

PILOT OUT – If the pilot is out, the digital control displays the following message:

“D” Solid State – NO PLIOT

“C” Computer – PILOT OUT

If no action is taken after 90 seconds, an alarm sounds continuously, the heat demand is disabled and any running cooking cycles are cancelled. The digital display the following message:

“D” Solid State – IGNITION LOCKOUT

“C” Computer – IGNITION LOCKOUT

The fryer must be turned off, then back on before the pilot can be re-initialized and normal functions resumed.

OPEN PROBE – If an open probe is detected, the heat demand is disabled and any running cooking cycles are cancelled. All operator buttons are disabled. The digital control displays the following message:

“D” Solid State – OPEN PROBE

“C” Computer – PROBE OPEN

SHORTED PROBE – If a shorted probe is detected, the heat demand is disabled and any running cooking cycles are cancelled. All operator buttons are disabled. The digital control displays the following message:

“D” Solid State – SHORTED PROBE

“C” Computer – PROBE SHORT

Hi TEMPERATURE – If the temperature is greater than or equal to 415°F (212°C), the heat demand is disabled and any running cooking cycles are cancelled. All operator buttons are disabled. The control displays the following message:

“D” Solid State – HIGH TEMP

“C” Computer – HIGH TMP HIGH TMP

Troubleshooting Chart:	
Problem:	Probable Cause:
No Heat:	Power switch not turned on. Gas supply not turned on. Wire connections loose (call service) Wires connections need cleaning High Limit (call service)
Insufficient or too much heat:	Temperature not set to desired temperature. High limit tripped (call service) Temperature probe (call service)
Tank will not drain:	Shortening too cold. Drain pipe clogged with debris.
Motor / pump will not pump oil:	Suction tube not seated correctly in receptacle block. Filter screen is clogged and needs cleaning. Shortening is too thick / cold. Heat oil up to min. 300° F. Discard valve lever not fully engaged either for filtering or discarding.

Free Manuals Download Website

<http://myh66.com>

<http://usermanuals.us>

<http://www.somanuals.com>

<http://www.4manuals.cc>

<http://www.manual-lib.com>

<http://www.404manual.com>

<http://www.luxmanual.com>

<http://aubethermostatmanual.com>

Golf course search by state

<http://golfingnear.com>

Email search by domain

<http://emailbydomain.com>

Auto manuals search

<http://auto.somanuals.com>

TV manuals search

<http://tv.somanuals.com>