

TQ 1.0
“Q-Pon Cutter”
12-000-01

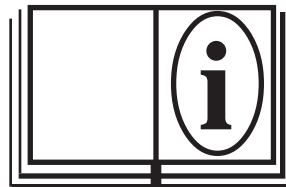

	TUBE & PIPE	
	CUT-OFF MACHINES	
Mod. TQ 1.0	Ser.No. <input type="text"/> <input type="text"/> <input type="text"/> <input type="text"/> <input type="text"/> <input type="text"/>	
E.H. WACHS COMPANIES 100 Shepard St. Wheeling Il. 60090 — Patent Pending —		

Part Number: 12-MAN-01

Revision No: 0



Q-PON CUTTER

TABLE OF CONTENTS

SECTION I.	STANDARD EQUIPMENT	5
SECTION II.	SAFETY	
	Safety Instructions	6-9
SECTION III.	CE DECLARATION OF CONFORMITY	10
SECTION IV.	MACHINE SPECIFICATIONS	11
SECTION V.	SET UP & OPERATING PROCEDURES	14-16
SECTION VI.	MAINTENANCE	16
SECTION VII.	TROUBLE SHOOTING	18
SECTION VIII.	PARTS LISTS & EXPLODED VIEW DRAWINGS	20-21
SECTION IX.	ORDERING INFORMATION	22

Q-PON CUTTER

SECTION I

STANDARD EQUIPMENT



- TQ 1.0 Machine
- Operating Hand Tools
- Operating Manual
- Storage Case

Q-PON CUTTER

SECTION II

SAFETY INSTRUCTIONS



Read the Following thoroughly before proceeding

Since 1883, EHWachs has built a reputation for quality and a commitment to consumer satisfaction. In accordance with this, Wachs must take on the added responsibility of doing our best to assure the safest use of our equipment.

We have assembled a list of safety reminders to aid in creating the safest possible working environment. We recommend that the precautionary steps listed there be closely observed.

1. **READ THE OPERATING MANUAL!!**

Reading the setup and operating instructions prior to beginning the setup procedures can save valuable time and help prevent injury to operators or damage to machines.

2. **INSPECT MACHINE & ACCESSORIES!**

Prior to machine setup physically inspect the machine and it's accessories. Look for worn tool slides, loose bolts or nuts, lubricant leakage, excessive rust, etc. A properly maintained machine can greatly decrease the chances for injury.

3. **ALWAYS READ PLACARDS & LABELS!**

All placards, labels and stickers must be clearly legible and in good condition. Replacement labels can be purchased from the manufacturer.

4. **KEEP CLEAR OF ROTATING PARTS!**

Keep hands, arms and fingers clear of all rotating or moving parts. Always turn machine off before attempting any adjustments requiring contact with the machine or it's accessories.

5. **SECURE LOOSE CLOTHING & JEWELRY!**

Loose fitting clothing, jewelry; long, unbound hair can get caught in the rotating parts on machines. By keeping these things secure or removing them you can greatly reduce the chance for injury.

6. **KEEP WORK AREA CLEAR!**

Be sure to keep the work area free of clutter and nonessential materials. Only allow those personnel directly associated with the work being performed to have access to the area if possible.

ALWAYS WEAR PROTECTIVE EQUIPMENT:

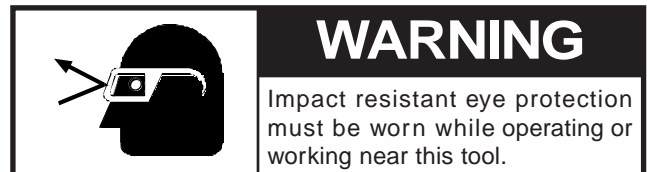

For additional information on eye and face protection, refer to federal OSHA regulations, 29 Code of Federal Regulations, Section 1019.133., Eye and Face Protection and American National Standards Institute, ANSI Z87.1, Occupational and Educational Eye and Face Protection. Z87.1 is available from the American National Standards Institute, Inc., 1430 Broadway, New York, NY 10018

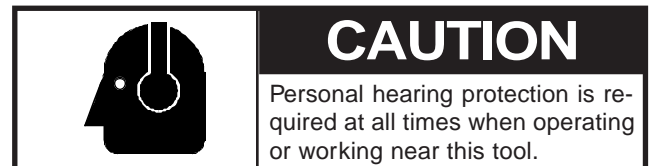

Hearing protectors are required in high noise areas, 85dBA or greater. The operation of other tools and equipment in the area, reflective surfaces, process noises and resonant structures can substantially contribute to and increase the noise level in the area. For additional information on hearing protection, refer to federal OSHA regulations, 29 Code of Federal Regulations, section 1910.95, Occupational Noise Exposure and ANSI S12.6 Hearing Protectors.

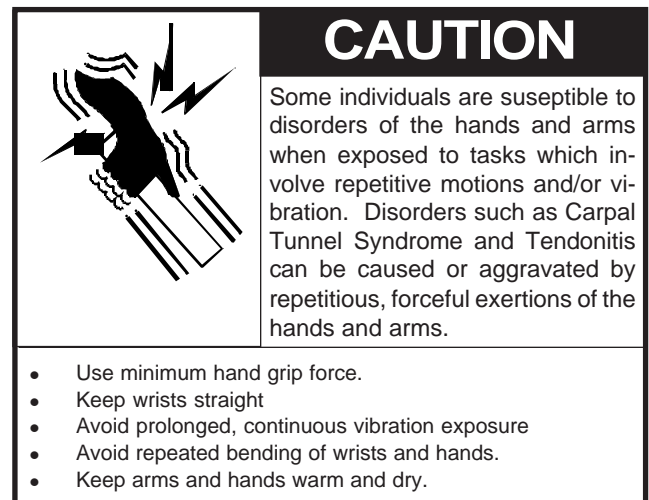

SICHERHEITSVORSCHRIFTEN

D

Seit 1883 hat EH Wachs seinen Ruf für Qualität und Zufriedenstellung seiner Kunden aufgebaut. Wachs übernimmt demgemäß die zusätzliche Verantwortung, sein Bestes zu tun, einen möglichst sicheren Umgang mit seiner Ausrüstung zu gewährleisten, und hat daher eine Liste von Sicherheits-Gedächtnisstützen zusammengestellt, die den Kunden in der Erschaffung einer möglichst sicheren Arbeitsumgebung zu unterstützen. Wir empfehlen, die aufgeführten Vorsichtsmaßnahmen genau zu beachten.



BITTE NACHFOLGENDES SORGFÄLTIG VOR DEM FORTFAHREN DURCHLESEN !

1. DIE BETRIEBSANLEITUNG LESEN!

Bedienungsanleitungen können wertvolle Zeit einsparen und Verletzungen und Beschädigungen der Maschine vermeiden, wenn Sie die Aufbau- und Betriebsanleitungen vor dem Aufbau durchlesen.

2. MASCHINE UND ZUSATZGERÄTE ÜBERPRÜFEN!

Vor dem Aufbau der Maschine sollte diese und die Zusatzgeräte physisch überprüft werden. Prüfen Sie, ob abgenutzte Werkzeugschlitzen, lockere Bolzen und Schraubenmütter, Schmiermittelabgänge, übermäßiger Rost, usw. bestehen. Mit einer ordnungsgemäß gewarteten Maschine kann die Wahrscheinlichkeit eines Unfalls stark verringert werden.

3. IMMER INFORMATIONEN UND ETIKETTEN LESEN!

Alle Informationen, Etiketten und Aufkleber müssen gut lesbar und in gutem Zustand sein. Vom Hersteller können Ersatzetiketten angefordert werden.

4. BLEIBEN SIE ROTIERENDEN TEILEN FERN!

Die Hände, Arme und Finger sollten von allen sich drehenden Teilen ferngehalten werden. Vor der Durchführung von Nachstellungen, die Sie in Berührung mit der Maschine oder deren Zusatzgeräte bringen, die Maschine stets abschalten!

5. WEITE KLEIDUNG UND SCHMUCK BEFESTIGEN!

Weite Kleidung, Schmuck und lange, nicht gelöste Haar können in den rotierenden Teilen der Maschine hängenbleiben. Die Wahrscheinlichkeit einer Verletzung kann stark herabgesetzt werden, wenn Sie diese Dinge befestigen bzw. abnehmen.

6. ARBEITSBEREICH FREIHALTEN!

Stets darauf achten, daß sich keine unnötigen Materialien, usw. im Arbeitsbereich befinden. Nur dem direkt mit der zu leistenden Arbeit in Zusammenhang stehenden Personal Zugang zum Arbeitsbereich gestatten!

STETS SCHUTZAUSRÜSTUNG TRAGEN!

	WARNUNG! Schlagbiegefeste Augenschutzbrillen müssen stets bei Betrieb dieses Werkzeugs oder in der Nähe dieses Werkzeugs getragen werden.
--	---

	ACHTUNG! Ein Ohrenschutz muß stets bei Betrieb dieses Werkzeugs oder in der Nähe dieses Werkzeugs getragen werden.
--	--

	ACHTUNG! Manche Personen leiden an Funktionsstörungen der Hände und Arme, wenn sie sich dauernd wiederholende Aufgaben auszuführen haben, die andauernde Bewegungen und/oder Schwingungen mit sich führen. Funktionsstörungen, wie beispielsweise Handwurzels- und Sehnenentzündungen, können durch eine sich wiederholende und mit viel Kraft ausgeübte Anwendung der Hände und Arme entweder hervorgerufen oder verschlimmert werden.
--	---

CONSIGNE DE SÉCURITÉ

F

Depuis 1883, la société EH Wachs a bâti sa réputation sur la qualité de ses produits et son engagement à satisfaire la clientèle. Conformément à ces principes, Wachs se doit également d'être aussi responsable pour faire de son mieux afin d'assurer l'utilisation la plus sûre de son matériel. Nous avons réuni une liste de rappels de sécurité pour aider à créer un cadre de travail aussi sûr que possible. Nous vous recommandons d'observer scrupuleusement les vérifications préalables indiquées ci-dessous.



Lisez ce qui suit avant d'aller plus avant

1. LIRE LE MANUEL D'UTILISATION !!

En lisant les instructions de réglage et de fonctionnement avant de commencer les procédures de réglage, vous pourrez économiser un temps précieux et vous éviterez aux machinistes de se blesser et d'abîmer les machines.

2. INSPECTER LA MACHINE ET LES ACCESSOIRES !

Avant de régler la machine, inspectez-la à l'œil nu ainsi que ses accessoires. Recherchez les outils couillants usagés, les boulons ou les écrous desserrés, les fuites de lubrifiant, les dépôts de rouille excessifs, etc. Avec une maintenance adéquate, vous diminuerez sensiblement les risques d'accidents.

3. LIRE SYSTÉMATIQUEMENT LES AFFICHES ET ÉTIQUETTES !

Toutes les affiches, étiquettes et autocollants doivent être parfaitement lisibles et en bon état. Vous pouvez acheter de nouvelles étiquettes auprès du fabricant.

4. SE TENIR À DISTANCE DES PIÈCES ROTATIVES !

Tenez vos mains, bras et doigts éloignés de toutes pièces rotatives ou mobiles. Arrêtez toujours la machine avant de tenter de procéder au moindre réglage nécessitant un contact avec la machine ou ses accessoires.

5. PRENDRE GARDE AUX VÊTEMENTS AMPLES ET AUX BIJOUX !

Les vêtements amples, les bijoux, et les cheveux longs qui ne sont pas attachés peuvent être pris dans les pièces rotatives des machines. Enlevez ou attachez ce qui gêne de façon à réduire au maximum les risques d'accident.

6. CONSERVER UNE AIRE DE TRAVAIL DÉGAGÉE !

Ayez bien soin d'enlever les débris et les matériaux qui ne sont pas indispensables. N'autorisez que la présence des employés chargés du travail en cours d'exécution pour dégager au mieux l'aire de travail.

PORTER TOUJOURS UN ÉQUIPEMENT DE PROTECTION

	AVERTISSEMENT Protégez vos yeux avec des lunettes de sécurité antichoc lorsque cet outil est en marche ou si vous travaillez à proximité.
--	---

	ATTENTION Il est absolument indispensable de vous protéger contre les oreilles lorsque cet outil est en marche ou si vous travaillez à proximité.
--	---

	ATTENTION Certaines personnes sont particulièrement sujettes aux troubles articulaires des mains et des bras lorsqu'elles sont soumises à des tâches nécessitant des gestes très répétitifs ou/et lorsqu'elles sont exposées à des vibrations. Le syndrome du canal carpien et les tendinites peuvent résulter ou être aggravés par des efforts rigoureux des bras et des mains.
--	--

INSTRUCCIONES DE SEGURIDAD

E

Desde 1883, EH Wachs ha ido forjando una reputación de calidad y compromiso hacia la satisfacción del cliente. De acuerdo con esto, Wachs debe aceptar la responsabilidad adicional de hacer todo lo posible para asegurar el uso seguro de nuestros equipos. Hemos reunido una lista de recordatorios de seguridad para ayudarle a crear el ambiente de trabajo más seguro posible. Recomendamos se observen cuidadosamente los pasos de precaución enumerados en la misma.



Lea lo siguiente detenidamente antes de proceder

1. ¡ LEA EL MANUAL DE OPERACIONES!!

La lectura de las instrucciones de instalación y operación antes de comenzar los procedimientos de instalación puede ahorrarle tiempo valioso y ayudarle a evitar daños a operarios o daño a las máquinas.

2. ¡ INSPECCIONA LA MÁQUINA Y LOS ACCESORIOS!

Antes de la instalación de la máquina inspeccione físicamente la máquina y sus accesorios. Busque muescas de herramientas usadas, pernos o tuercas flojas, fugas de lubricante, excesiva corrosión, etc. Una máquina mantenida adecuadamente puede disminuir grandemente las ocasiones de daños.

3. ¡ LEA SIEMPRE LOS LETREROS Y ETIQUETAS!

Todos los letreros, etiquetas y adhesivos deben ser claramente legibles y estar en buenas condiciones. Pueden comprarse etiquetas de repuesto del fabricante.

4. ¡ MANTENGASE ALEJADO DE PIEZAS GIRATORIAS!

Mantenga las manos, brazos y dedos alejados de todas las piezas rotativas o en movimiento. Desconecte siempre la máquina antes de intentar ningún ajuste que requiera entrar en contacto con la máquina o sus accesorios.

5. ¡ ASEGURE LA ROPA SUELTA Y JOYERÍA!

La ropa suelta, joyería, pelo largo y sin atar pueden engancharse en las partes rotatorias de las máquinas. Usted puede reducir grandemente las oportunidades de un accidente asegurando estas cosas o despojándose de ellas.

6. ¡ MANTENGA LIMPIA EL ÁREA DE TRABAJO!

Asegúrese de mantener el área de trabajo libre de obstáculos y materiales no esenciales. Si es posible permita solamente el acceso al área a aquellas personas directamente asociadas con el trabajo que se está realizando.

USE SIEMPRE EQUIPO PROTECTOR:

	AVISO Debe usarse protección ocular resistente al impacto mientras se opere o trabaje cerca de esta herramienta.
--	--

	PRECAUCION e requiere en todo momento protección auditiva personal cuando opere o trabaje cerca de esta herramienta.
--	--

	PRECAUCION Algunos individuos son susceptibles a desórdenes de brazos y manos cuando son sometidos a tareas que llevan consigo movimientos altamente repetitivos y/o vibración. Desórdenes tales como el síndrome del túnel carpiano y ten-donitis pueden ser causados o agravados por esfuerzos repetitivos y energéticos de las manos y brazos.
--	---

INDICAZIONI PER LA SICUREZZA D'USO

I

Fin dal 1883, l'EH Wachs si è guadagnata una reputazione per quanto riguarda qualità e impegno nella soddisfazione dei clienti. In questa ottica, alla Wachs dobbiamo anche assumerci la responsabilità di fare del nostro meglio per garantire la massima sicurezza d'uso dei nostri apparecchi. Abbiamo preparato un elenco di avvisi di sicurezza come ausilio nel creare il più sicuro ambiente di lavoro possibile. Raccomandiamo di seguire attentamente le precauzioni elencate.



Leggere attentamente quanto segue prima di proseguire.

1. LEGGERE IL MANUALE D'USO!!

Leggere le istruzioni per la messa a punto e l'uso prima di iniziare la messa a punto per risparmiare tempo prezioso e prevenire lesioni e danni al macchinario.

2. CONTROLLARE LA MACCHINA E GLI ACCESSORI!

Prima di mettere a punto la macchina, controllare sia la macchina che gli accessori. Verificare che le slitte portautensili non siano consumate, che i bulloni e i dadi non siano allentati, che non vi siano perdite di lubrificante, ruggine eccessiva, ecc. Una macchina ben mantenuta può ridurre notevolmente le possibilità di danni.

3. LEGGERE SEMPRE TARGHETTE ED ETICHETTE!

Tutte le targhette, le etichette e gli adesivi devono essere chiaramente leggibili e in buone condizioni. Si possono acquistare etichette di ricambio presso il produttore.

4. NON AVVICINARSI A PARTI IN MOVIMENTO!

Tenere mani, braccia e dita ben lontane da tutte le parti in movimento. Spegnerne sempre la macchina prima di effettuare regolazioni che richiedono il contatto con la macchina o i suoi accessori.

5. FISSARE INDUMENTI E GIOIELLERIA!

Indumenti larghi, gioielli pendenti o lunghi; capelli lunghi sciolti possono rimanere incastrati nelle parti rotanti sulle macchine. Fissandoli o rimuovendoli si può ridurre notevolmente il rischio di lesioni.

6. MANTENERE L'AREA DI LAVORO SGOMBRA!

Mantenere l'area di lavoro sgombra da materiale non essenziale. Se possibile, consentire l'accesso solamente al personale direttamente interessato nel lavoro svolto.

INDOSSARE SEMPRE INDUMENTI PROTETTIVI:

	ATTENZIONE Indossare occhiali di sicurezza resistenti all'urto durante l'uso di questo strumento o quando si lavora in sua prossimità.
--	--

	AVVERTENZA Indossare sempre protezione auricolare durante l'uso di questo strumento o quando si lavora in sua prossimità.
--	---

	AVVERTENZA Alcuni individui possono soffrire disturbi alle mani e alle braccia nell'esecuzione di mansioni che comportino movimenti altamente ripetitivi e/o vibrazione. Disturbi quali la sindrome del tunnel carpale e tendiniti possono essere causati o aggravati da sforzi ripetuti delle mani e delle braccia.
--	--

VEILIGHEIDSRICHTLIJNEN

N

Sinds 1883 heeft de firma E.H.Wachs een reputatie opgebouwd voor kwaliteit en heeft zich geëngageerd om voldoening te schenken aan de gebruiker. Dienovereenkomstig heeft E.H.Wachs de bijkomende verantwoordelijkheid op zich genomen het uiterste te betrekken om het gebruik van onze apparatuur onder de meest veilige omstandigheden te verzekeren.

We hebben een lijst samengesteld van veiligheidsaanbevelingen teneinde de meest veilige werkomgeving te scheppen.



We raden aan de hieronder vermeldde voorzorgsmaatregelen strikt na te leven. Lees het volgende aandachtig vooraleer verder te gaan.

1. LEES HET BEDRIJNGSHANDBOEK!

Lees de opstel- en bedieningsrichtlijnen vooraleer met de opstelwerkzaamheden te beginnen om kostbare tijd te besparen en om persoonlijke letsels en schade aan de machines te voorkomen.

2. INSPECTEER DE MACHINE EN TOEBEHOREN

Vooraleer de machine op te stellen, inspecteer de machine en haar toebehoren. Kijk uit voor versleten gereedschapsleden, losse bouten en moeren, olie lekken, overmatige roest, enz. Een goed onderhouden machine kan de kans voor kwetsuren aanzienlijk verminderen.

3. LEES ALTIJD DE PLAKKAATEN EN ETIKETTES

Alle plakkaaten, etiketten en zelfklevers moeten duidelijk leesbaar zijn en in goede staat. Vervangingsetiketten kunnen bij de fabrikant gekocht worden.

4. HOUD AFSTAND VAN DRAAIENDE ONDERDELEN

Houd handen, armen en vingers weg van alle draaiende of bewegende onderdelen. Schakel de machine uit vooraleer afregelingen te verrichten die contact vereisen met de machine of haar toebehoren.

5. VERMIJD LOSSE KLEDING EN SIERADEN

Los zittende kleding, sieraden, en lang los haar kunnen door draaiende machineonderdelen gegrepen worden. Door ze vast te maken of ze te verwijderen kunt u de kans op verwondingen aanzienlijk verkleinen.

6. HOUD DE WERKRUIMTE VRIJ

Zorg ervoor dat de werkruimte vrij is van rommel en onnodige materialen. Toegang tot de werkruimte moet indien mogelijk enkel verleend worden aan personen die direct betrokken zijn bij het uit te voeren werk.

DRAAG ALTIJD BESCHERMENDE UITRUSTING

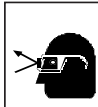

WAARSCHUWING

Een veiligheidsbril moet gedragen worden bij het bedienen van dit gereedschap of bij het werken in de buurt van dit gereedschap.



VOORZICHTIG

Persoonlijke gehoorbescherming is aangeraden bij het bedienen van dit gereedschap of bij het werken in de buurt van dit gereedschap.



VOORZICHTIG

Sommige personen zijn vatbaar voor hand-en armletsels wanneer zij blootgesteld zijn aan trillingen of handelingen die hoog repetitieve bewegingen vergen. Letsels zoals Carpal tunnel syndroom en tendinitis kunnen veroorzaakt worden of verergeren door repetitieve krachtspanningen van handen en armen.

SÄKERHETSANVISNINGAR

S

EH Wachs har sedan 1883 etablerat ett gott anseende när det gäller kvalitet och kundtillfredsställelse. Wachs känner sig därför förpliktigt att göra sitt yttersta för att garantera såkrast möjliga användning av Wachs-utrustning.

Vi har ställt samman en lista av säkerhetsanvisningar som ett led i vår strävan att skapa såkrast möjliga arbetsmiljö. Vi rekommenderar att de försiktighetsåtgärder som förtecknats följs noggrant.



Läs igenom nedanstående ordentligt innan du fortsätter.

1. LÄS IGENOM BRUKSANVISNINGEN!

Genomläsning av anvisningarna för klargöring och drift innan klargöringen påbörjas kan medföra en värdefull tidsbesparing och bidra till att person- och maskinskador undviks.

2. KONTROLLERA MASKINEN OCH DESS TILLBEHÖR!

Kontrollera maskinen och besiktiga dess tillbehör. Se efter om verktyghållare är slöta, skruvar och muttrar lösa, smörjmedel läcker, kraftigt rost förekommer o.d. En korrekt underhållen maskin medför kraftigt minskat risk för personskador.

3. LÄS ALLTID SKYLTYR OCH ETIKETTER!

Alla skyltyr och etiketter måste vara helt läsliga och i gott skick. Utbytesetiketter kan inköpas från tillverkaren.

4. HÅLL DIG BORTA FRÅN Roterande DELAR!

Håll händer, armar och fingrar borta från roterande eller rörliga delar. Slå alltid av maskinen innan justering som kräver kontakt med maskinen eller dess tillbehör utförs.

5. STOPPA IN LÖST SITTANDE KLÄDER OCH SMYCKEN!

Löst sittande kläder och smycken samt långt, hängande hår kan fastna i maskinens roterande delar. Genom att säkra dessa eller avlägsna kläder och smycken kan du minska risken för skador avsevärt.

6. HÅLL ARBETSSTÄLLET RENT!

Var noga med att hålla arbetsstället fritt från skräp och ej behövligt material. Ge om möjligt tillgång till arbetsstället endast till personal som är direkt inbegripen i det arbete som utförs.

ANVÄND ALLTID SKYDDSUSTRUSTNING:

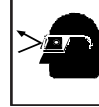

VARNING!

Stötsäkra skyddsglasögon måste bäras vid användning av eller arbete nära detta redskap.



OBS!

Hörselskydd krävs alltid vid användning av eller arbete nära detta redskap.



OBS!

Vissa personer är känsliga för de effekter som kan uppstå i händer och armar när de utför rörelser som är i hög grad repetitiva och/eller utsätts för vibrationer. Tillstånd såsom karpal tunnel syndrom och seninflammation kan orsakas eller förvärras om händer och armar används för att utföra repetitivt och ansträngande arbete.

INSTRUÇÕES DE SEGURANÇA

P

Já desde 1883 que a EH Wachs tem vindo a criar uma reputação de qualidade e um compromisso de satisfação dos consumidores. Nesta linha de conduta, a Wachs tem que assumir a acrescida responsabilidade de fazer o seu melhor para garantir a máxima segurança na utilização dos nossos equipamentos.

Acabámos de compilar uma lista de lembretes de segurança destinados a ajudar na criação de um ambiente de trabalho o mais seguro possível. Aconselhamos que sejam observadas com todo o cuidado as várias fases precaucionárias descritas a seguir.



Ante de continuar, leia com o máximo cuidado o que vai a seguir

1. Leia o Manual de Operações!

A leitura das instruções de montagem e de funcionamento antes de iniciar os procedimentos de montagem poderá poupar um tempo precioso e prevenir ferimentos no operador ou danos nas máquinas.

2. Inspeccione a máquina e respectivos acessórios!

Antes de efectuar a sua montagem, faça uma inspeção física da máquina e seus acessórios. Dirija a sua busca para peças desluzadas já usadas, parafusos e porcas soltos, derrame de lubrificantes, ferrugem excessiva, etc. A manutenção adequada do maquinismo diminuirá os riscos de ferimentos.

3. Leia sempre os cartazes e as etiquetas!

Todos os cartazes, etiquetas e autocolantes deverão ser claramente legíveis e estar em perfeitas condições. Etiquetas acessórias de substituição poderão ser encomendadas directamente do fabricante.

4. Mantenha-se fora do alcance de peças rotatórias!

Mantenha as mãos, braços e dedos fora do alcance de todas as peças rotatórias ou em movimento. Desligue, primeiro, a máquina sempre que tiver de proceder a ajustamentos que requirem contacto com a máquina ou com as suas peças.

5. Aperte bem a roupa folgada e peças de joalheria!

Roupas folgadas, joalheria e cabelo solto e comprido poderão ser apanhados pelas peças rotatórias das máquinas. Manter estes artigos amarrados ou desfazer-se deles será a melhor maneira de reduzir a possibilidade de ferimentos.

6. Mantenha livre a área de trabalho!

Procure manter a área de trabalho livre de ajustamentos e de materiais não essenciais. O acesso a essa área só deverá ser permitido ao pessoal directamente envolvido no trabalho que estiver a ser executado, tanto quanto possível.

USE SEMPRE EQUIPAMENTO DE PROTECÇÃO:



AVISO!

Sempre que trabalhar com esta ferramenta ou perto dela deverá usar uma protecção para a vista, à prova de choque.



CUIDADO!

É obrigatório usar protecção individual para os ouvidos durante todo o tempo que trabalhar com esta ferramenta ou perto dela.



CUIDADO!

Há pessoas que são propensas a sofrer certos sintomas nas mãos ou nos braços quando expostos a tarefas que envolvam movimentos altamente repetitivos, acompanhados ou não de vibrações. Sintomas como, por exemplo, o síndrome do túnel carpeo e a tendinite poderão ser causados ou agravados pelo uso esforçado e repetitivo das mãos e dos braços.

TURVALLISUUSOHJEET

FIN

EH Wachs on tunnettu korkeasta laadusta ja tyytyväisistä asiakkaitaan jo vuodesta 1883. Wachs huolehtii myös siitä, että laitteiden käyttö on mahdollisimman turvallista.

Olemme koonneet tähän turvallisuutta koskevan muistilistan, jota noudattamalla työympäristöstä saadaan mahdollisimman turvallinen. Kehotamme noudattamaan tässä esitettyjä varoitusmenetelmiä huolellisesti.



Lue seuraavat kohdat huolellisesti, ennen kuin jatkat.

1. LUE KÄYTTÖOHJEKIRJAJ!

Asennus- ja käyttöohjeisiin perehtyminen ennen asennuksen aloittamista säästää aikaa ja auttaa vähentämään tapaturmavaaraa ja koneiden vaurioitumisriskiä.

2. TARKASTA KONE JA LISÄLAITTEET!

Ennen kuin aloitat asennuksen, tarkasta kone ja lisälaitteet. Varmista, että teräkelkat eivät ole kuluneet, pultteja ja muttereita ei ole löysällä, voiteluainetta ei vuoda, koneessa ei ole liikaa ruostetta jne. Hyvässä kunnossa pidetty kone voi vähentää tapaturmavaaraa huomattavasti.

3. LUE KAIKKI KILVET JA MERKINNÄT!

Kaikkien kilpien, merkintöjen ja tarrojen on oltava selkeästi luettavissa ja hyvässä kunnossa. Vaihottarvoja voit ostaa valmistajalta.

4. PYSYTTÄLE ETÄÄLLÄ PYÖRIVISTÄ OSISTA!

Pitä kädet, käsivartet ja somet loitolla kaikista pyörivistä tai liikkuvista osista. Kytke kone aina pois päältä ennen kuin suoritat säätöjä, joissa joudut koskemaan koneeseen tai sen lisälaitteisiin.

5. SIDO LÖYSÄT VAATTEET JA HIUKSET KIINNI!

Löysät vaatteet, korut ja pitkät hiukset voivat tarttua koneen pyöriviin osiin. Vähennät tapaturmavaaraa huomattavasti, kun poistat tai sidot kiinni löysät vaatteet ja korut ja sidot hiukset kiinni.

6. PIDÄ TYÖSKENTELYALUE SIISTINÄ!

Varmista, että työskentelyalueella ei ole roskaa eikä tarpeetonta materiaalia. Päästä työskentelyalueelle vain käsillä olevaan työhön osallistuvia henkilöitä, mikäli mahdollista.

KÄYTÄ AINA SUOJAVÄLINEITÄ:

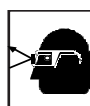

VAROITUS

Käytä iskunkestäviä suojalaseja, kun käytät tätä työkalua tai työskentelet sen lähellä.



HUOMAA

Kuulosuojainten käyttöä vaaditaan aina, kun käytät tätä työkalua tai työskentelet sen lähellä.



HUOMAA

Pitkään jatkuva allistuminen toistuvalle liikkeelle ja/tai äänille voi aiheuttaa käsien ja käsivarsien sairauksia jollekin henkilöille. Käsien ja käsivarsien kohdistuva toistuva ja voimakas liike voi aiheuttaa tai pahentaa sairauksia kuten ranneknavaireyhtymä ja jännitelehdus.

ANVISNING I SIKKERHED

DK

Siden 1883 har EH Wachs haft ry for deres kvalitet og varetagelse af kundtilfredshed og vil også gøre vort bedste for at sikre, at vore maskiner benyttes på en sikker og forsvarlig måde.

Vi har lavet en liste over påmindelser, der skal bidrage til at skabe det sikrest mulige arbejdsmiljø. Vi anbefaler, at sikkerhedsforanstaltningerne på listen omhyggeligt overholdes.



Læs følgende grundigt, inden der foretages andet

1. LÆS BRUGSANVISNINGEN!!

Hvis man læser anvisningerne i klargøring og drift, inden man begynder at gøre maskinen klar, kan man spare tid og forhindre person- og maskinskade.

2. INSPICÉR MASKINE OG Udstyr!

Inden maskinen gøres klar, skal man inspicere maskinen og udstyret. Se efter slide fittings, løse bolte og møtrikker, olie-lækager, rust osv. Når maskinen holdes i god stand, er der langt mindre risiko for personskade.

3. LÆS ALTID SKILTE OG ETIKETTER!

Alle skilte og etiketter skal være letlæselige og i god stand. Nye skilte og etiketter fås hos forhandleren.

4. HOLD AFSTAND TIL BEVÆGELIGE DELE!

Hold hænder, arme og fingre væk fra alle roterende og bevægelige dele. Man skal altid slukke for maskinen, inden man påbegynder justering, hvor man kommer i kontakt med maskinen eller udstyret.

5. BRUG IKKE LØSTHÆNGENDE TØJ OG SMYKKER!

Løst-hængende tøj, smykker og langt, løst-hængende hår kan blive fanget i maskinens bevægelige dele. Man kan i høj grad nedsætte risikoen for personskade ved ikke at bruge løst-hængende tøj og smykker og ved at samle langt hår oppe på hovedet.

6. HOLD ARBEJDSSTEDET RYDDET!

Arbejdsstedet skal holdes ryddeligt og fri for materialer, der ikke hører til. Uvedkommende personer bør ikke have adgang til arbejdsstedet, hvis det er muligt.

BRUG ALTID BESKYTTELSESDUSTYR:

	ADVARSEL Man skal bruge slag-resistente sikkerhedsbriller, når man arbejder med eller i nærheden af denne maskine.
--	--

	FORSIGTIG Man skal altid bruge hørevern, når man arbejder med eller i nærheden af denne maskine.
--	--

	FORSIGTIG Nogle mennesker er disponeret for lidelser i hænder og arme, når de udsættes for opgaver, der involverer stærkt repetitiv bevægelse og/eller vibration. Sygdomme, såsom karpal-tunnelsyndrom og ten-dinitis, kan forårsages eller forværres af repetitiv, kraftig brug af hænder og arme.
--	---

	FORSIGTIG Hold dig på afstand af roterende dele under drift. Hold hænder og arme mindst 60 cm væk fra bevægelige dele, undtagen ved start og stands fling.
--	--

	FORSIGTIG Handsker er ikke en form for beskyttelse. Gå ikke med handsker, mens maskinen betjenes. Spåner og findelt materiale, som udvikles under drift, skal bortskaffes på forsvarlig måde. Dette skal gøres ved brug af en fejebakke og en kost, for at undgå påvirkning af hænderne.
--	--

ΟΔΗΓΙΕΣ ΑΣΦΑΛΕΙΑΣ

GR

Από το 1883, η EH Wachs έχει δημιουργήσει μια φήμη ποιότητας και δέσμευσης στην ικανοποίηση του πελάτη. Συνεπώς, η Wachs πρέπει να αναλάβει την πρόσθετη υποχρέωση να κάνουμε το καλύτερο για να εξασφαλίσουμε την ασφαλέστερη χρήση του εξοπλισμού μας.

Έχουμε καταρτίσει έναν κατάλογο υπομνήσεων ασφαλείας που βοηθούν στη δημιουργία του ασφαλέστερου δυνατού χώρου εργασίας. Συνιστούμε την πιστή εφαρμογή των προληπτικών μέτρων που αναγράφονται παρακάτω.



Πριν προχωρήσετε διαβάστε όλες τις παρακάτω υποδείξεις

1. ΔΙΑΒΑΣΤΕ ΤΟ ΒΙΒΛΙΟ ΟΔΗΓΙΩΝ !

Η ανάγνωση των οδηγιών εγκατάστασης και χειρισμού πριν αρχίσετε τις διαδικασίες εγκατάστασης μπορούν να σας εξοικονομήσουν πολύτιμο χρόνο και να βοηθήσουν στην αποτροπή τραυματισμού των χειριστών ή βλάβης των μηχανών.

2. ΕΠΙΘΕΩΡΗΣΤΕ ΤΗ ΜΗΧΑΝΗ ΑΙ ΤΑ ΕΞΑΡΤΗΜΑΤΑ!

Πριν από την εγκατάσταση της μηχανής επιθεωρήστε τη φυσική κατάσταση της μηχανής και των εξαρτημάτων. ιατάξτε για τυχόν φθορά στις γλίστρες των εργαλείων, λασκαρισμένα μπουλόνια ή παξιμάδια, διαρροή λιπαντικού, υπερβολική σκουριά κτλ. Η μηχανή που συντηρείται κανονικά μπορεί να μειώσει σημαντικά τις πιθανότητες τραυματισμού.

3. ΠΑΝΤΑ ΔΙΑΒΑΣΤΕ ΤΙΣ ΠΙΝΑ ΙΔΕΣ & ΤΙΣ ΕΤΙ ΕΤΕΣ!

Όλες οι πινακίδες, ετικέτες και αυτοκόλλητα πρέπει να διαβάζονται καθαρά και να βρίσκονται σε καλή κατάσταση. Εφεδρικές ετικέτες μπορείτε να αγοράσετε από τον κατασκευαστή.

4. ΑΠΟΜΑ ΡΥΝΘΕΙΤΕ ΑΠΟ ΤΑ ΠΕΡΙΣΤΡΕΦΟΜΕΝΑ ΕΞΑΡΤΗΜΑΤΑ!

ραφήστε χέρια, βραχιόνες και δάχτυλα μακριά από όλα τα περιστρεφόμενα ή κινούμενα εξαρτήματα. Πάντοτε σβήνετε τη μηχανή πριν επιχειρήσετε οποιαδήποτε ρύθμιση που απαιτεί επαφή με τη μηχανή ή τα εξαρτήματά της.

5. ΜΑΖΕΨΤΕ ΤΑ ΛΥΤΑ ΡΟΥΧΑ & ΟΣΜΗΜΑΤΑ!

Τα ρούχα που δεν έχουν καλή εφαρμογή, τα κοσμήματα, τα μακριά, αυτά μαλλιά μπορεί να πιαστούν στα περιστρεφόμενα εξαρτήματα της μηχανής. Στερεώνοντας ή βγάζοντας τα μπορείτε να μειώσετε σημαντικά την πιθανότητα τραυματισμού.

6. ΔΙΑΤΗΡΕΙΤΕ ΕΛΕΥΘΕΡΟ ΤΟ ΧΩΡΟ ΕΡΓΑΣΙΑΣ!

Φροντίστε να διατηρείτε το χώρο εργασίας ελεύθερο από ακαταστασία και επισυώδη υλικά. Επιτρέπετε την είσοδο μόνο στους έχοντας άμεση σχέση με την εκτελούμενη εργασία αν είναι δυνατό.

ΝΑ ΦΟΡΑΤΕ ΠΑΝΤΟΤΕ ΠΡΟΣΤΑΤΕΥΤΙ Α Ή ΙΔΙΑ:

	ΠΡΟΕΙΔΟΠΟΙΗΣΗ Να φοράτε ειδή προστασίας των ματιών κατά της πρόσκρουσης όταν χειρίζεστε ή εργάζεστε κοντά στο εργαλείο αυτό.
--	--

	ΠΡΟΣΟΧΗ Χρειάζεται πάντοτε ατομική προστασία των αυτιών όταν χειρίζεστε ή εργάζεστε κοντά στο εργαλείο αυτό.
--	--

	ΠΡΟΣΟΧΗ Μερικά άτομα είναι ευαίσθητα στις διαταραχές των χεριών και των βραχιόνων όταν εκθέτονται σε εργασίες που συνεπάγονται εξαιρετικά επαναληπτικές κινήσεις και/ή κραδασμούς. Οι διαταραχές όπως το σύνδρομο καρπικής σήραγγας και η τενοντιτίδα μπορεί να προκληθούν ή να επιδεινωθούν από τις επαναληπτικές, ισχυρές εκτάσεις των χεριών και των βραχιόνων.
--	--

Q-PON CUTTER

SECTION III

CE DECLARATION OF CONFORMITY

Name and address of manufacturer (if different) E.H. Wachs Company
100 Shepard St.
Wheeling, Il. 60090 USA

Distributed in the EC by: _____
Business address: _____

We declare that the machine described below conforms with the EHSR of the machinery directive 89/392/EEC and amendments 91/368/EEC, 93/44/EEC and 93/68/EEC

Machine Title Tube and Pipe Cutting Machines

Model Number TQ 1.0 12-000-01

Machine Description Portable machinery to cut high purity pipe
coupon samples

Serial Number _____

Harmonized Standards Used EN 50144, EN 55014, HD 400, EN 292, EN
292-2, EN 294, EN 394

Other Safety Standards Used PR: EN 982, PR: EN 983, 10/95
PR: EN 792-1, PR: EN 1050

Name of person authorized to sign on behalf of the E.H. Wachs Companies: Scott Weldon

Position Vice President / CFO

Signature *Scott Weldon*

Date April 1, 1999

Q-PON CUTTER

SECTION IV

SPECIFICATIONS

Lightweight, Easy to Set Up.

Unique Vertical Vise Screw.

Convenient Cut Line Indicator.

Standard vise jaw covers the entire tube clamping range 1/2" to 4-1/2" O.D. (12.7-114mm) No extension required.

Corrosion resistant finish applied to metal components.

Ideal for construction and maintenance of sanitary tubing systems.

From storage case to complete cut in 5 minutes.

Integrated "quick clamp system" mounts directly to any work bench.



Functions:	Cut coupon samples to check weld quality. Cut tubing at various lengths.
Machine Dimensions (lwxhx):	14" x 9.5" x 7" (355.6 mm x 241.3 mm x 177.8 mm)
Cutting Range:	.125" to 1.0" (3.175-25.4mm) O.D.
Material:	Thin wall stainless steel tubing
Weight:	Machine: 10 lbs. (4.5 kg) Shipping: 15 lbs.(6.8 kg)
Feed Method:	Manual
Speed:	100 rpm
Drive Type:	110 volt, 220 volt
Cutting Blade:	Width .030" (.762mm) Stag-R-Tooth blade
Features:	2 axis cutting - Adjustable depth control - Adjustable speed control
Packaging:	High impact plastic storage case - TQ 1.0 machine - Hand tools Saw blade - Operating manual

Machine Model	Average Sound Level (Decibels)	Maximum Sound Level (Decibels)
TQ 1.0	90db	96db

Q-PON CUTTER

SECTION V

SET UP & OPERATING INSTRUCTIONS

Q-PON CUTTER

SECTION V

SETUP & OPERATING PROCEDURES

TQ 1.0 Components



WARNING

Disconnect power when changing blade. Failure to do so could result in serious injury.

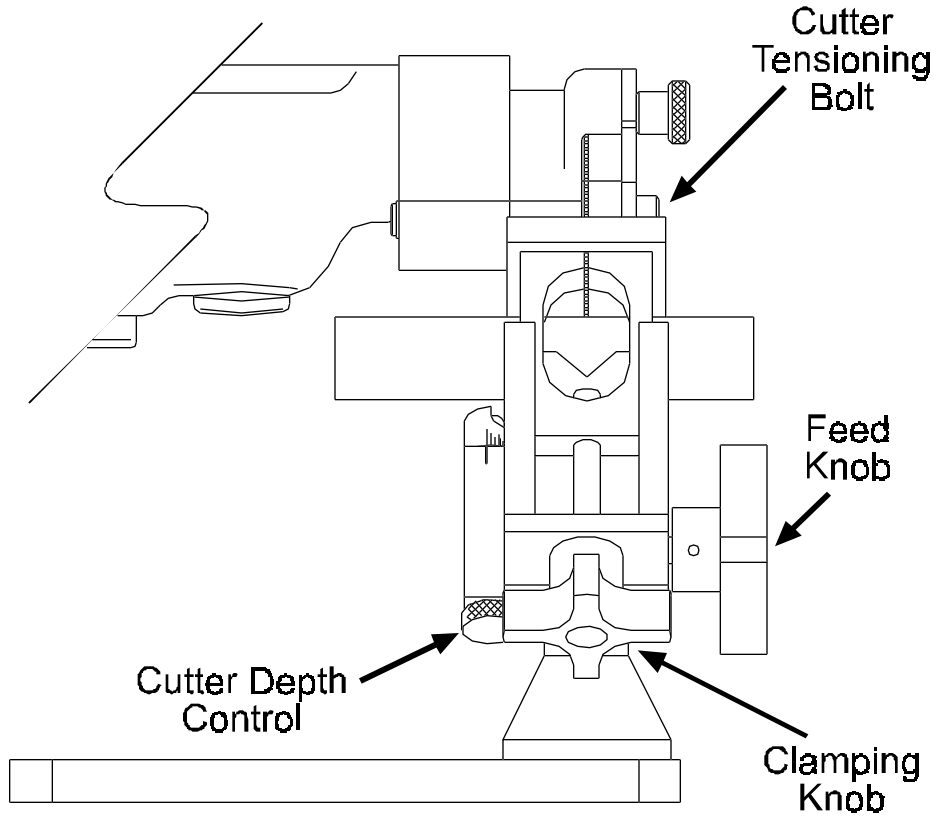

Q-PON CUTTER

SECTION V

SETUP & OPERATING PROCEDURES (CONT.)

1. Install FHCS through base plate and stand support into bottom of TQ 1.0 (Figure 1)



Figure 1

2. Attach vacuum source to port on back of TQ 1.0 if desired.

Saw Blade Installation

1. Slide back the cutting saw blade guard.
2. Remove cutter tensioning bolt and retaining washer from spindle.
3. Position saw blade for contact rotation over spindle.
4. Replace retaining washer and tensioning bolt using supplied hand tools (Figure 2).

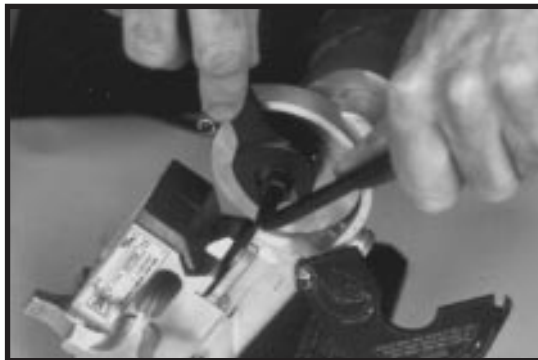

Figure 2

5. Always change the cutter brush when changing blades.

Setting Cutter Speed

1. The low speed side of the gearbox engaged (3a), the dial speed control should always be set on "A" (3b). This will keep the blade at its optimum speed of 100 rpm (Figure 3).

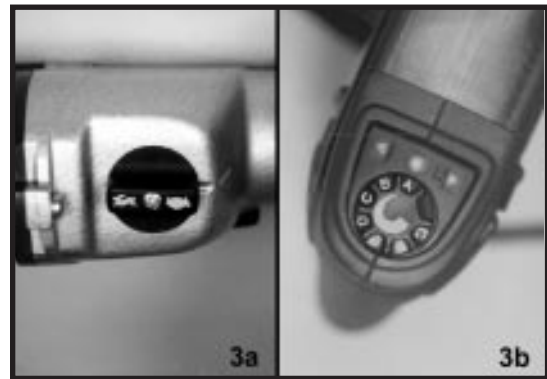

Figure 3

Weld Sample Cutting

1. Cut off desired length from weld centerline.
2. Set cutter depth control to desired diameter (Figure 4).

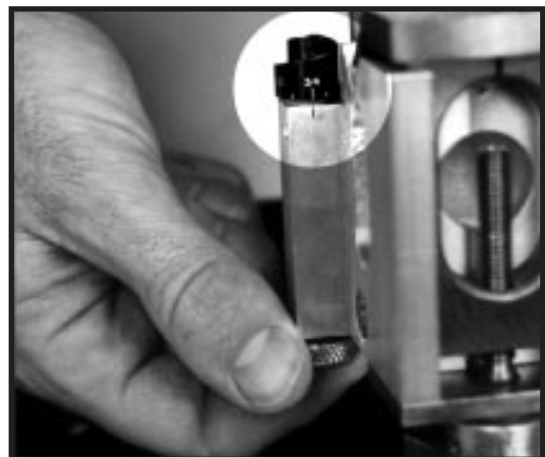

Figure 4

Q-PON CUTTER

SECTION V

SETUP & OPERATING PROCEDURES (CONT.)

3. Place tube in axial cutting position in vise with tube extending just beyond the front edge of the vise clamp. Proceed with axial cut (Figure 5).

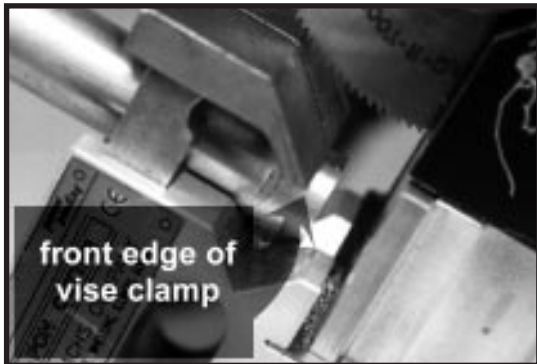

Figure 5

5. Use the provided weld sample spreading pliers to open up the weld sample for viewing (Figure 7).



Figure 7

4. Place the tube back into the radial cutting position in vise with the tube positioned to intersect the radial cut with the previous axial cut (Figure 6).



Figure 6

SECTION VI

MAINTENANCE

1. The TQ 1.0 has been designed to minimize maintenance. Clean and inspect moving parts regularly for wear. Check power cord periodically for damage or wear. Replace if cracked or damaged.
2. Replace blades at first sign of wear.



CAUTION: Worn cutting blades are susceptible to slippage and could cause serious injury.

Q-PON CUTTER

SECTION VII

TROUBLE SHOOTING

Q-PON CUTTER

SECTION VII

TQ 1.0 TROUBLE SHOOTING

Trouble	Possible Cause	Remedy
Motor Will Not Run	Power Unit Not Connected	Check Power Cord & Connection
Premature blade life	Improper Speed or Gear Box Setting	Refer to Speed Control & Gear Box Info.
Difficult Rotation Resulting In Poor Workpiece End Quality	Dull or Chipped Saw Blade	Replace Saw Blade
Workpiece Rotates During Cut	Loose Vise Clamp	Tighten Vise Clamp
Saw Blade Will Not Cut	Improper Saw Blade Direction	Change Saw Blade Rotation Direction

Q-PON CUTTER

SECTION VIII

PARTS LISTS & EXPLODED VIEW DRAWINGS

Q-PON CUTTER

TQ 1.0 Bill of Material

Part # 12-000-01

Ref. #	Part #	Qty.	Description
001	12-001-00	1	HOUSING, CUTTER
002	12-002-00	1	HOUSING, DRIVE
003	12-003-00	1	GEAR, DRIVE
004	12-004-00	1	GEAR, IDLER
005	12-005-00	1	SPINDLE, DRIVE
006	12-006-00	1	WASHER, SPINDLE
007	12-007-00	1	WASHER, HAT
008	12-008-00	1	SHAFT, IDLER
009	12-009-00	1	SLIDE
010	12-010-00	1	PLATE, SLIDE
011	12-011-00	1	RACK, GEAR
012	12-012-00	1	GEAR, FEED
013	12-013-00	1	SHAFT, FEED
014	12-014-00	1	SCREW, VISE
015	12-015-00	1	PLATE, VISE
016	12-016-00	1	SLIDE, VISE
017	12-017-00	1	COVER, CUTTER
018	12-018-00	2	KNOB
019	12-019-00	1	RETAINER, FELT
020	12-020-00	1	SEAL, FELT
021	12-021-00	1	CAM, ADJ. STOP
022	12-031-00	1	BRUSH, CUTTER BLADE
023	18-036-00	1	SUPPORT, STAND
N/S	18-031-00	1	CASE, STORAGE
N/S	12-030-00	1	WRENCH, SPREADER
031	20-031-00	1	MOTOR, METABO 110v
035	18-035-00	1	BASE, STAND
N/S	12-036-00	1	FOAM, CASE
N/S	12-037-00	1	LABEL, CASE
040	12-040-00	1	O-RING, POLYURETHANE
041	12-041-00	1	WASHER, NYLON
042	12-042-00	2	WASHER, 10-24 SPRING
043	12-043-00	2	NUT,10-24 SS NYLOCK
044	12-044-00	1	KNOB,1/4-20x2-1/2"LG
045	12-045-00	1	RING,5/16EXT.RET'G

Ref. #	Part #	Qty.	Description
046	12-046-00	1	WASHER,.06THK. PVC
047	12-047-00	2	BR'G,1/16THK.THRUST
048	12-048-00	1	BR'G,.313x.439x5/16
049	12-049-00	1	BR'G,.313x.439x5/8
050	12-050-00	2	BR'G,.25x.44x.31ND'L
051	12-051-00	1	BR'G,.63x.81x.63ND'L
052	12-052-00	2	BR'G,.38x.88x.25BALL
053	12-053-00	1	RING, 3/8 EXT.RETAINING
054	12-039-00	1	WASHER, 5/16 SPRING
N/S	12-032-00	1	PLATE, ID.
700	12-700-00	1	BLADE, 120T CUTTER
N/S	12-MAN-01	1	OP MANUAL
1	90-040-60	2	SHCS 10-32 x 1
2	90-093-13	1	FHCS, 1/2-13 x 2-1/2
N/S	90-800-21	1	WRENCH,HEX5/16LG ARM
N/S	90-800-30	1	WRENCH,COMBO 3/4
N/S	90-049-01	4	SCREW,3/16 U DRIVE
6	90-026-04	3	PIN,DOWEL 1/8 x 7/16
7	90-026-05	1	PIN, DOWEL 1/8x1/2
8	90-026-08	2	PIN, DOWEL 1/8 x 7/8
9	90-102-01	2	BHCS-SS,4-40x3/16LG
10	90-103-05	6	FHCS-SS, 10-24 x 1/2
11	90-100-05	2	SHCS-SS, 10-24 x 1/2
12	90-100-02	2	SHCS-SS, 6-32 x 1/4
13	90-150-00	1	SHCS-SS, 1/4-20 x 1
14	90-170-50	1	SHCS-SS, 3/8-24 x 1
15	90-100-01	1	SHCS-SS, 2-56 x 3/16
16	90-104-08	2	SSS-SS, 10-24 x 7/8
17	90-154-13	1	SSS-SS,1/4-20 x 5/16

Q-PON CUTTER

SECTION IX

ORDERING INFORMATION

To place an order or to get more detailed information on any E.H. Wachs products, call us at:
1-800-323-8185.

ORDERING REPLACEMENT PARTS

Please use parts list provided in manual. Have part description and part number of required replacement part or parts to help expedite order and insure proper parts are being ordered.

REPAIR INFORMATION

Please call E.H. Wachs Company prior to returning any equipment for repair. We will advise you of shipping and handling. Please enclose with equipment to be repaired your name, address, phone number and a brief description of problem or work to be done or estimated.

All repair work done at our plant will be estimated and the customer advised of cost and time required to complete repair.

WARRANTY INFORMATION

Enclosed with the manual is a warranty card. Please fill out the registration card and return to E.H. Wachs. Retain the owners registration record and warranty card for your information.

RETURN GOODS ADDRESS

E.H. Wachs Company
100 Shepard Street
Wheeling, Illinois 60090

Call or Write:

E.H. Wachs Company
P.O. Box A
100 Shepard Street
Wheeling, Illinois 60090

847-537-8800

FAX: 847-520-1147 • 847-520-1168

Toll-Free: 1-800-323-8185



TUBE & PIPE

CUT-OFF MACHINES



Mod. **TQ 1.0** Ser.No.

Enter Your Machines Serial Number Here For
Proper Record Keeping and Ordering Reference.

Free Manuals Download Website

<http://myh66.com>

<http://usermanuals.us>

<http://www.somanuals.com>

<http://www.4manuals.cc>

<http://www.manual-lib.com>

<http://www.404manual.com>

<http://www.luxmanual.com>

<http://aubethermostatmanual.com>

Golf course search by state

<http://golfingnear.com>

Email search by domain

<http://emailbydomain.com>

Auto manuals search

<http://auto.somanuals.com>

TV manuals search

<http://tv.somanuals.com>