

# WAGNER®

## Cordless Power Roller

Owner's Manual

Gude d'utilisation • Manual del propietario

### Quick-start

Easy does it from setup to cleanup:

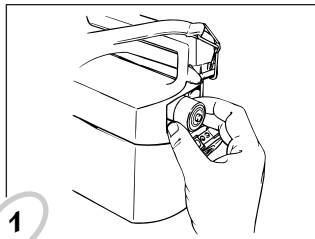
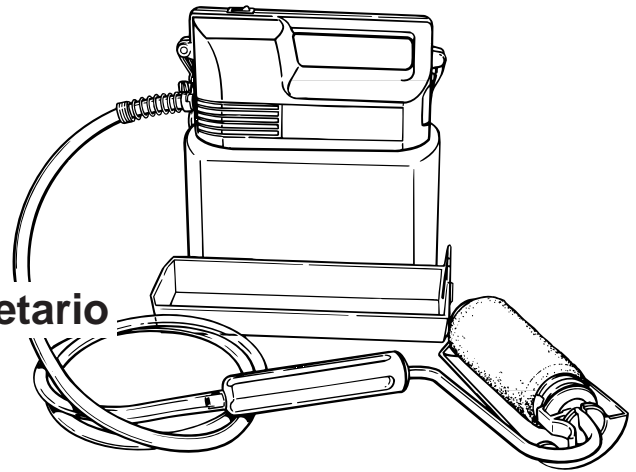

**1**  
Install the batteries  
Insérer les piles  
Instalar las pilas

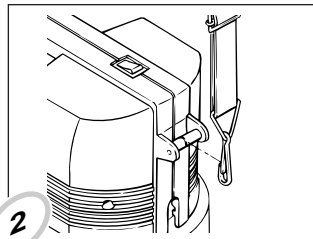

**2**  
Attach the strap  
Fixer la bandoulière  
Conectar la correa

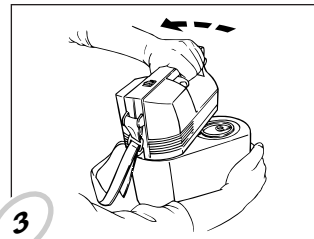

**3**  
Remove the drive housing  
Enlever du logement du mécanisme  
Extraer el mecanismo impulsor

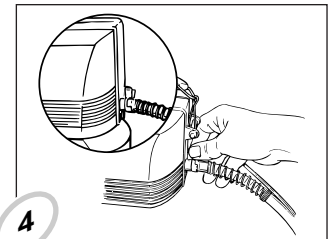

**4**  
Attach the hoses  
Fixation des tuyaux flexibles  
Conectar las mangueras

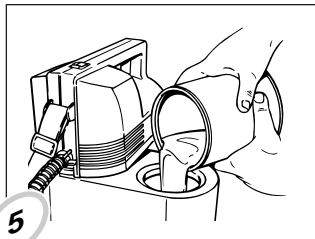

**5**  
Fill the fluid tank  
Remplir le réservoir à liquides  
Llenar el depósito de fluidos

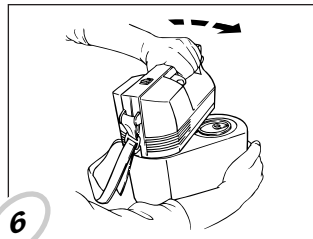

**6**  
Attach the drive housing  
Fixation du logement du mécanisme  
Conectar el mecanismo impulsor

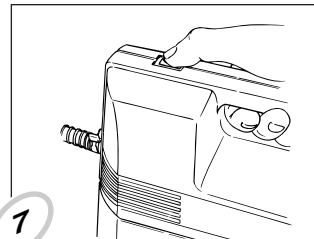

**7**  
Press the on/off switch  
Appuyer sur le bouton marche/arrêt  
Oprimir el botón de encendido / apagado

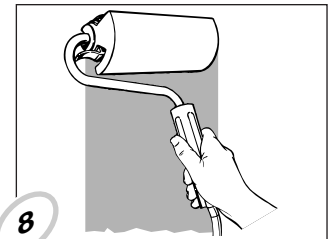

**8**  
Apply paint  
Appliquer la peinture  
Aplicar pintura

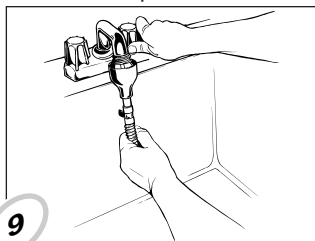

**9**  
Cleanup  
Nettoyage  
Limpieza

Read this manual for complete instructions.

Ce manuel contient les instructions complètes.

Lea este manual para obtener instrucciones completas.

**Need help? Call us first for answers fast.**

Call Wagner toll-free if you have any comments or problems with this Wagner product.



**1-800-328-8251**

**Wagner Technical Service**

Weekdays: 8:00 - 4:30 Central time

Weekends: 9:00 - 4:00 Central time

1770 Fernbrook Lane, Minneapolis, MN 55447

## Table of Contents

<b>PRODUCT REGISTRATION</b> .....	<b>2</b>
<b>PARTS LISTING</b> .....	<b>2</b>
<b>ASSEMBLING THE ROLLER</b> .....	<b>3</b>
Installing the batteries and attaching the strap	
Removing and Attaching the Drive Housing to the Fluid Tank	
Attaching the Fluid Hose	
Filling the Fluid Tank	
<b>USING THE ROLLER</b> .....	<b>3</b>
Pump On/Off Switch	
Applying Paint	
<b>CLEANUP</b> .....	<b>4-5</b>
Quick Cleanup	
Detailed Cleanup	
<b>STORING THE ROLLER</b> .....	<b>5</b>

## Product Registration Card

Send in your Wagner product registration card. Proper registration will serve as proof of purchase in the event your original receipt becomes misplaced or lost. Returning this card will not affect warranty coverage, but may expedite the processing of your warranty and enable you to contact us in the event of loss or theft. The additional information will also help us to develop new products that best meet your needs and desires. THANK YOU!

## Accessories

9" x 3/8" roller cover .....	0155206
9" x 3/4" roller cover .....	0155209
9" x 1-1/4" roller cover.....	0155209
Ball check assembly .....	0156270
Check valve assembly.....	0156276

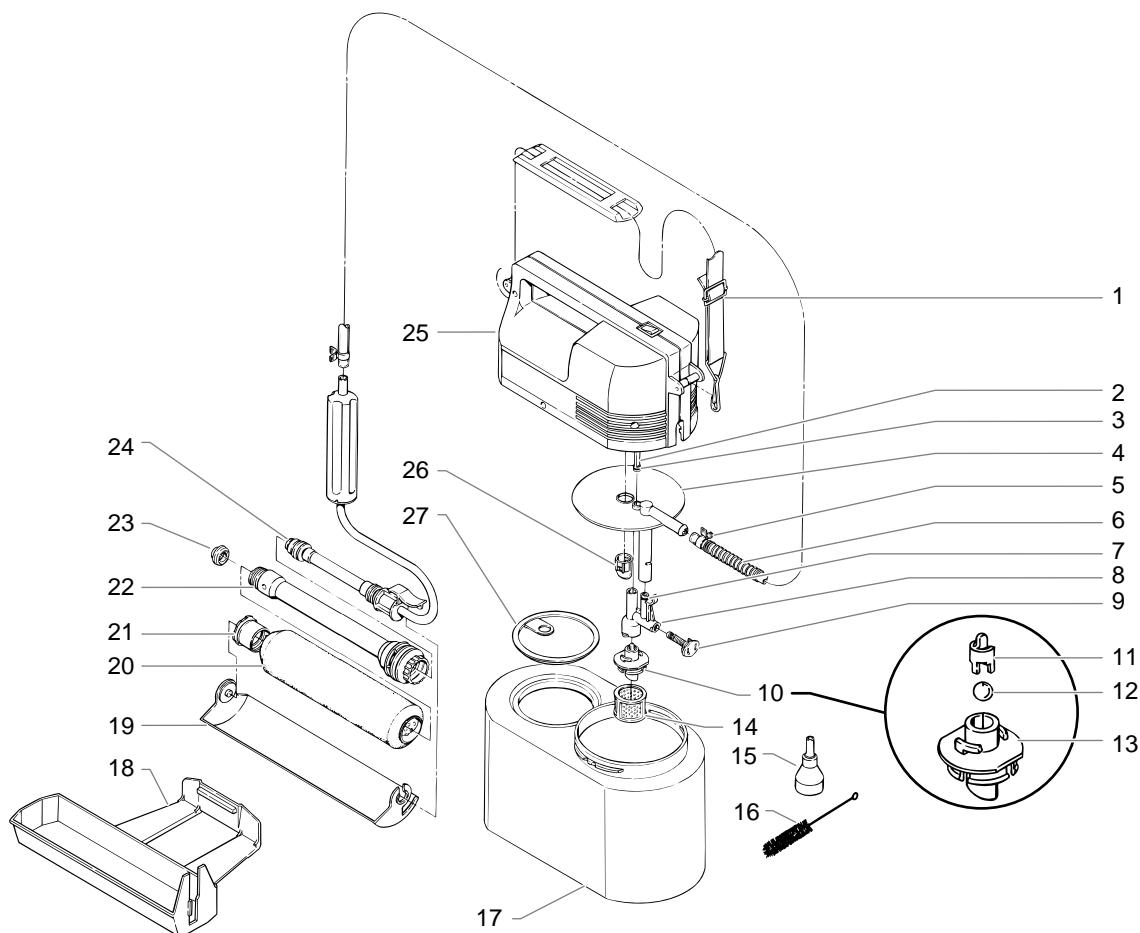

## Parts Listing

1	0156400	Strap Assembly	15	0156421	Adapter, Faucet
2	0156595	Piston	16	0280346	Brush
3	0327312	O-Ring	17	0156607	Container, Fluid
4	0156596	Pump, Upper	18	0156606	Tray, Roller
5	0327226	Clip, Spring	19	0156566	Shield, Splatter
6	0156471	Spring, Anti-kinking	20	0155206	Roller Cover, 3/8"
7	0327327	O-Ring		0155208	Roller Cover, 3/4" Opt.
8	0156579	Pump, Lower	21	0156556	Cap, End
9	0156276	Valve Cap Assembly	22	0156559	Core, Roller
10	0156270	Inlet Valve Assembly	23	0245401	Seal
11	0156582	Retainer, Inlet Ball	24	0156290	Arm, Roller
12	0156464	Ball, Inlet	25	-----	Drive Housing
13	0156580	Body, Valve	26	0156585	Cap, Pump Retaining
14	0016551	Filter	27	0156409	Cover

## Assembling the Roller

### Installing the Batteries and Attaching the Strap

1. Open the battery door. The battery door is located on the drive housing.
2. Insert the batteries in the proper direction.

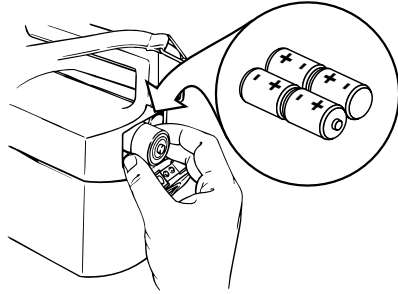

Improper installation of batteries may cause batteries to overheat and leak acid. Acid may cause severe injury and/or property damage.

**NOTE:** Use high quality alkaline batteries only.

3. Attach the strap to the loops on the drive housing.

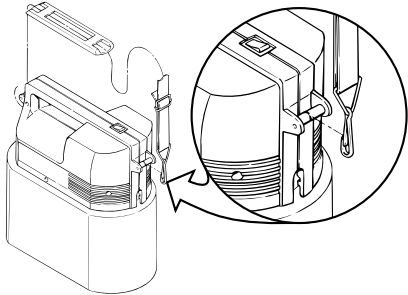

### Removing and Attaching the Drive Housing to the Fluid Tank

1. Remove the drive housing by turning the drive housing counterclockwise.
2. Attach the drive housing by setting it onto the fluid tank at a 90° angle and turning clockwise.

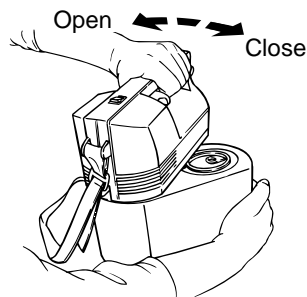

### Attaching the Fluid Hose

1. Slide the fluid hose through the anti-kinking spring and the spring clip.
2. Push the fluid hose to the port on the side of the drive housing.
3. Slide the spring clip over the fitting to keep the hose securely in place.
4. Slide the anti-kinking spring up against spring clip.

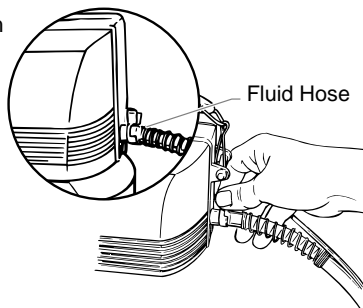

### Checking the Inlet Valve

If the unit is new or has been stored for an extended period of time the inlet ball can become stuck and the pump may be difficult to prime. To check:

1. Turn the valve body counterclockwise and pull down to remove.
2. Shake the inlet valve assembly gently. If it does not rattle, remove the inlet ball retainer and clean the ball.
3. Reassemble the inlet valve.

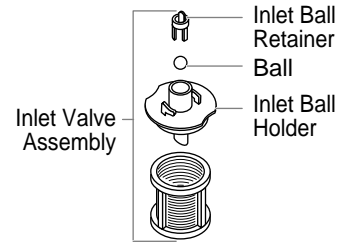

### Filling the Fluid tank

1. Place the drive housing on the fluid tank at a 90° angle.
2. Remove the fluid tank cap and fill the tank with paint.
3. Wipe the lip, threads, and body of the fluid tank to remove any spilled or splattered material.
4. Replace the cap and lock the drive housing securely onto the fluid tank.

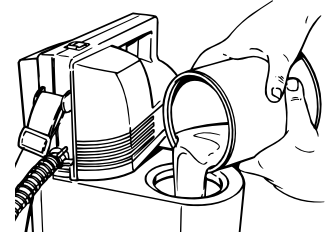

### Using the Roller

The On/Off switch has two speeds for controlling the paint flow – High and Low. Choose the setting which is appropriate for your application. If too much paint is being delivered to the roller on High speed, use the Low speed setting. If paint flow is still too great, shut the roller off, then turn back on when more paint is needed.

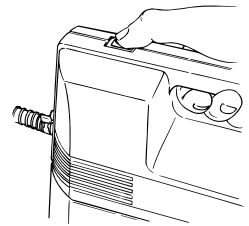

### Applying Paint

Begin rolling as paint appears to saturate the roller cover. If paint is flowing faster than you can roll, turn the pump off until more paint is needed.

**NOTE:** Do not place the roller below the level of the paint when not in use. Paint will siphon to roller even if motor and pump are turned off.

## Cleanup

A thorough cleaning after each use of the roller is important to keep it in good working order.

**NOTE:** When using latex paint, use warm soapy water for cleaning parts. When using oil paint, the appropriate solvent is often mineral spirits. Always follow the paint manufacturer's recommendations for appropriate solvent. Not recommended for lacquer and other hard solvents.



Do not turn the roller upside down or on its side. If liquid gets inside the drive housing it could damage the unit.

### Quick Cleanup

The following steps outline the basic cleanup procedures. For more detailed instructions on how to perform each step, refer to the Detailed Cleanup section in this manual.



1. Clean the roller cover.



2. Remove paint in hose.



3. Empty fluid tank.

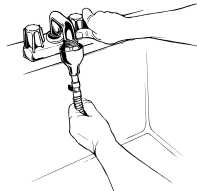

4. Clean hose.

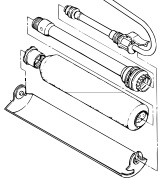

5. Clean roller handle.

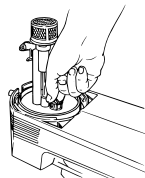

6. Remove the pump assembly.

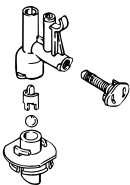

7. Remove and clean the valves.

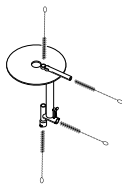

8. Clean the pump assembly.

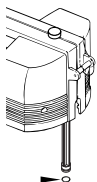

9. Clean and lubricate the piston and O-ring.



10. Reassemble the pump and attach it to the drive housing.

## Detailed Cleanup

### Cleaning the Roller Cover

1. Pull one end of the splatter shield out of the end cap and slip opposite end off of the roller handle.
2. Press the locking tab and remove the roller cover and roller core.
3. Unscrew the end cap and slide the roller cover off of the roller core.
4. Clean the roller cover with the appropriate solvent.

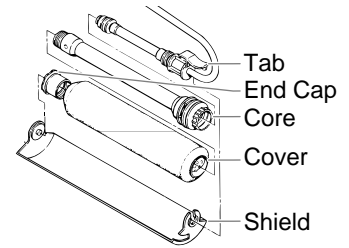

**NOTE:** For latex, clean roller cover, core and end cap thoroughly in warm soapy water.

For oil-based paints, clean roller cover, core and end cap in the appropriate solvent recommended by the paint manufacturer.

### Removing Paint from the Hose and Container

1. Remove the drive housing from fluid container.
2. Hold the roller handle over the paint pail and run the pump to remove excess paint from hose and pump.
3. Pour remaining paint from container back into paint pail.

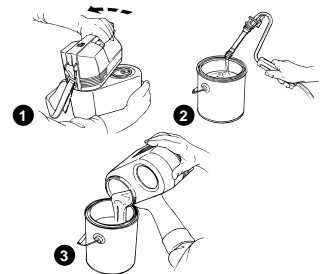

### Cleaning the Hose Thoroughly

#### For Latex:

1. Remove the hose from the motor compartment.
2. Insert the hard plastic tube of the faucet adapter into the paint hose.
3. Push the adaptor over a faucet.
4. Slowly increase the water pressure and run water through the hose and handle until the water come out clean.

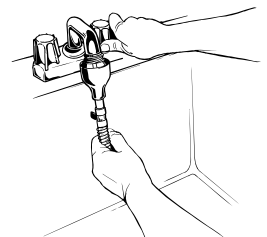

#### For Oil:

1. Fill the paint container with the appropriate solvent recommended by the paint manufacturer.
2. Circulate the solvent through hose and roller arm for several minutes.

### Cleaning the Roller Handle Assembly

1. Remove the seal from the end of the roller handle. Note the direction of the lip for correct replacement.
2. Clean the handle and seal thoroughly.
3. Apply a thin layer of petroleum jelly to the seal.
4. Replace the seal in the proper direction.

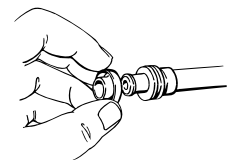

### Removing the Pump from the Drive Housing

1. Turn the retaining nut on the pump counterclockwise.
2. Pull out the pump assembly.

**NOTE:** The piston will remain attached.

3. Wipe excess paint off of the piston.
4. Apply a thin layer of petroleum jelly to the pump O-Ring.

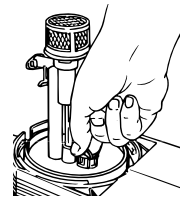

**NOTE:** Remove the pump carefully or the piston may come off. If the piston comes off, reassemble by sliding piston onto the brass piston connecting rod.

**NOTE:** Wipe excess paint off the drive housing with an appropriate solvent. **DO NOT IMMERSE UNIT IN SOLVENT OR OTHER LIQUID.**

## Cleaning the Valves

### Cleaning the Inlet Valve

1. Press down on the locking tab and pull the valve assembly out.
2. Turn valve body counterclockwise and remove.
3. Remove the ball retainer and inlet ball.
4. Remove the filter basket and thoroughly clean all parts in warm, soapy water or the appropriate solvent.

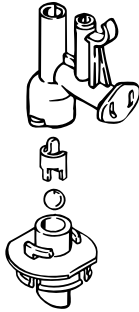

### Cleaning the Outlet Valve

1. Turn valve cap assembly counter clockwise remove.
2. Clean all parts in warm, soapy water or the appropriate solvent.

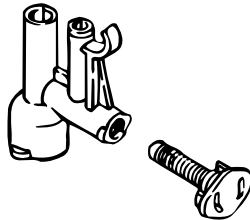

## Cleaning the Pump Housing

1. Clean pump housing with warm, soapy water or the appropriate solvent using the brush supplied.
2. Apply a thin layer of petroleum jelly to the pump O-Ring.

**NOTE:** Be sure to clean all small parts thoroughly. Paint will act as an adhesive when dry.

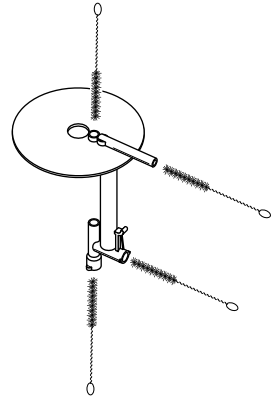

## Storing the Roller



**Clean, dry, and lubricate the system thoroughly before storing. Do not store with liquids inside unit. Storing the unit in cold temperatures can cause the liquids to freeze and expand, causing pressure to build and break parts. Let the equipment come up to room temperature before operating.**

When storing the roller for more than a day, take the following precautions:

1. Remove the batteries.
2. Remove the hose from the pump fitting.
3. Store the hose in a large loop. If it is bent, it could be damaged.

## Troubleshooting

### Problem

The pump will not run.

### Cause

There is little or no power.  
The batteries are not in properly.  
The pump on/off button was not pressed.  
The pump has seized up.

### Solution

Put in new high quality alkaline batteries.  
Put the batteries in properly.  
Press and release the pump on/off button.  
Clean the piston and pump housing.

The motor and piston run but there is little or no fluid flow.

The batteries are low.  
The fluid hose is leaking.  
The inlet, outlet, or relief valves are dirty.  
The fluid in the fluid tank is low.  
The piston O-ring is worn.  
The piston has slipped off the brass axle.  
The seal is not in place.  
Too much paint pumped to roller.

Put in new high quality alkaline batteries.  
Tighten the fluid hose securely.  
Clean the inlet and outlet valves.  
Fill the fluid tank.  
Replace the piston O-ring.  
Snap the piston back on the axle.  
Check and place the seal properly.  
Press and release the pump on/off button to turn the the pump off until more paint is needed.  
Remove the seal, lubricate and replace.

Paint leaks from the roller core.  
Roller cover slides on the wall.

The seal is not lubricated.



**Have you tried the recommendations above and are still having problems? In the United States, call our toll-free consumer service at 1-800-328-8251 Monday through Friday between 8:00 AM and 4:30 PM Central time or between 9:00 AM and 4:00 PM Saturday or Sunday, or contact an authorized service center.**

## Wagner One Year Limited Warranty - Keep on file - English

This product manufactured by Wagner Spray Tech Corporation (Wagner), is warranted to the original retail purchaser against defects in material and workmanship for one year from date of purchase if operated in accordance with Wagner's printed recommendations and instructions. This product is designed for home use only. If this product is used for professional/rental purposes, this warranty applies only for 30 days from date of purchase.

This warranty does not cover damage resulting from improper use, accidents, user's negligence or normal wear. This warranty does not cover defects or damages caused by service or repair performed by anyone other than a Wagner Authorized Service Center. This warranty does not apply to accessories.

ANY IMPLIED WARRANTY OF MERCHANTABILITY OR FITNESS FOR A PARTICULAR PURPOSE IS LIMITED TO ONE YEAR FOR HOME USE AND 30 DAYS FOR PROFESSIONAL/RENTAL USE FROM DATE OF PURCHASE.

WAGNER SHALL NOT IN ANY EVENT BE LIABLE FOR ANY INCIDENTAL OR CONSEQUENTIAL DAMAGES OF ANY KIND, WHETHER FOR BREACH OF THIS WARRANTY OR ANY OTHER REASON.

If any product is defective in material and/or workmanship during the applicable warranty period, return it with proof of purchase, transportation prepaid to any Wagner Authorized Service Center. Contact Wagner Technical Service at 1770 Fernbrook Lane, Minneapolis, MN 55447 or telephone 1-800-760-3844 for authorized service center locations. Wagner's Authorized Service Center will either repair or replace the product (at Wagner's option) and return it to you, postage prepaid.

Some states do not allow limitations on how long an implied warranty lasts or the exclusion of incidental or consequential damages, so the above limitation and exclusion may not apply to you.

This warranty gives you specific legal rights and you may also have other rights which vary from state to state.

## Garantie limitée d'une année de la société Wagner – GARDEZ DANS VOS DOSSIERS – Français

Ce produit, fabriqué par la société Wagner Spray Tech (« Wagner »), est garanti au premier acheteur au détail contre toute défectuosité de matériau ou d'exécution, pour une période d'une année à compter de la date d'achat, pourvu que l'on se serve du produit en suivant les recommandations et consignes écrites de Wagner. Ce produit est destiné à l'usage domestique seulement. Si on l'utilise pour des fins professionnelles ou pour la location, la présente garantie ne s'applique que pendant une période de 30 jours à compter de la date d'achat. La présente garantie ne s'applique pas aux dégâts entraînés par une utilisation incorrecte, par un accident, par la négligence de l'utilisateur ou par l'usure normale. La présente garantie ne s'applique non plus aux défectuosités ou dommages résultant de l'entretien ou de la réparation que fait une personne quelconque qui ne soit pas membre d'un centre d'entretien agréé de Wagner. La présente garantie ne s'applique pas aux accessoires.

TOUTE GARANTIE IMPLICITE DE QUALITÉ MARCHANDE OU D'ADAPTATION À UN USAGE PARTICULIER EST LIMITÉE À UNE PÉRIODE D'UNE ANNÉE POUR L'UTILISATION DOMESTIQUE ET DE 30 JOURS POUR UNE UTILISATION PROFESSIONNELLE OU DE LOCATION, À COMPTER DE LA DATE D'ACHAT.

WAGNER NE SERA EN AUCUN CAS RESPONSABLE DE DOMMAGES ACCESSOIRES OU INDIRECTS DE QUELQUE NATURE QUE CE SOIT, À LA SUITE D'UNE INOBSERVATION DE LA PRÉSENTE GARANTIE OU POUR UNE AUTRE RAISON QUELCONQUE.

Si un produit est défectueux en ce qui concerne les matériaux ou l'exécution pendant la période de garantie applicable, vous devez le retourner, avec une preuve d'achat et frais de port payés, à n'importe quel centre d'entretien agréé de Wagner. Pour connaître l'emplacement des centres d'entretien agréés de la société, communiquez avec le service technique de Wagner au 1770 Fernbrook Lane, Minneapolis, MN 55447 USA, ou téléphonez au 1-800-760-3844. Le centre d'entretien agréé de Wagner réparera ou remplacera le produit (à la discrétion de Wagner) et vous le retournera par la poste, avec frais de port payés.

Certaines provinces interdisent les restrictions sur la durée d'une garantie implicite ou l'exclusion des dommages accessoires ou indirects. Il se peut donc que la restriction et l'exclusion énoncées ci-dessus ne s'appliquent pas à vous.

Le présente garantie vous accorde des droits juridiques spécifiques, et vous avez peut-être d'autres droits, qui peuvent varier d'une province à l'autre.

## Garantía limitada de un año de Wagner – MANTENGALA ARCHIVADA – Español

Este producto fabricado por Wagner Spray Tech Corporation (Wagner) es garantizado al comprador original al por menor contra defectos en el material y la mano de obra por un año a partir de la fecha de compra si se opera siguiendo las recomendaciones e instrucciones impresas de Wagner. Este producto ha sido diseñado solamente para uso doméstico. Si se usa para propósitos profesionales o de alquiler, esta garantía se aplica solamente por 30 días a partir de la fecha de compra.

Esta garantía no cubre daños que resulten del uso inadecuado, accidentes, negligencia del usuario o desgaste normal. Esta garantía no cubre defectos ni daños causados en mantenimiento o reparaciones realizados por alguien que no sea un Centro de Servicio Autorizado por Wagner. Esta garantía no se aplica a los accesorios.

TODA GARANTIA IMPLICITA DE COMERCIABILIDAD O APTITUD PARA UN PROPOSITO PARTICULAR ESTA LIMITADA A UN AÑO PARA USO DOMESTICO Y A TREINTA DIAS PARA USO PROFESIONAL O DE ALQUILER A PARTIR DE LA FECHA DE COMPRA.

WAGNER NO SERA RESPONSABLE BAJO NINGUNA CIRCUNSTANCIA POR NINGUN DAÑO INCIDENTAL O INDIRECTO DE NINGUNA CLASE, YA SEA POR VIOLACION DE ESTA GARANTIA O CUALQUIER OTRA RAZON.

Si cualquier producto resulta defectuoso en sus materiales y/o mano de obra durante el periodo de garantía aplicado, devuélvalo con el comprobante de compra, flete pagado anticipadamente, a cualquier Centro de Servicio Autorizado por Wagner. Póngase en contacto con el Departamento de Servicio Técnico de Wagner en 1770 Fernbrook Lane, Minneapolis, MN 55447 o llame por teléfono al 1-800-760-3844 para averiguar las ubicaciones de los Centros de Servicio Autorizados. El Centro de Servicio Autorizado de Wagner reparará o cambiará el producto (a criterio de Wagner) y se lo devolverá a usted con el porte pagado anticipadamente.

Algunos estados no permiten limitaciones a la duración de una garantía implícita ni la exclusión de daños incidentales o indirectos, de modo que la limitación y exclusión anteriores puede que no se apliquen a usted.

Esta garantía le da a usted derechos legales específicos y usted podría tener también otros derechos que varían de un estado a otro.

## Free Manuals Download Website

<http://myh66.com>

<http://usermanuals.us>

<http://www.somanuals.com>

<http://www.4manuals.cc>

<http://www.manual-lib.com>

<http://www.404manual.com>

<http://www.luxmanual.com>

<http://aubethermostatmanual.com>

Golf course search by state

<http://golfingnear.com>

Email search by domain

<http://emailbydomain.com>

Auto manuals search

<http://auto.somanuals.com>

TV manuals search

<http://tv.somanuals.com>