

EZ-ZONE[®] PM

User's Manual



Integrated Controller Models



1241 Bundy Boulevard., Winona, Minnesota USA 55987
Phone: +1 (507) 454-5300, Fax: +1 (507) 452-4507 <http://www.watlow.com>

**TOTAL
CUSTOMER
SATISFACTION**
3 Year Warranty

ISO 9001

Registered Company
Winona, Minnesota USA

0600-0059-0000 Rev. C

Made in the U.S.A.



March 2008

\$15.00

Safety Information

We use note, caution and warning symbols throughout this book to draw your attention to important operational and safety information.

A “NOTE” marks a short message to alert you to an important detail.

A “CAUTION” safety alert appears with information that is important for protecting your equipment and performance. Be especially careful to read and follow all cautions that apply to your application.

A “WARNING” safety alert appears with information that is important for protecting you, others and equipment from damage. Pay very close attention to all warnings that apply to your application.

The safety alert symbol,  (an exclamation point in a triangle) precedes a general CAUTION or WARNING statement.

The electrical hazard symbol,  (a lightning bolt in a triangle) precedes an electric shock hazard CAUTION or WARNING safety statement.



CAUTION or WARNING



**Electrical Shock Hazard
CAUTION or WARNING**

Warranty

The EZ-ZONE[®] PM is manufactured by ISO 9001-registered processes and is backed by a three-year warranty to the first purchaser for use, providing that the units have not been misapplied. Since Watlow has no control over their use, and sometimes misuse, we cannot guarantee against failure. Watlow’s obligations hereunder, at Watlow’s option, are limited to replacement, repair or refund of purchase price, and parts which upon examination prove to be defective within the warranty period specified. This warranty does not apply to damage resulting from transportation, alteration, misuse or abuse. The purchaser must use Watlow parts to maintain all listed ratings.

Technical Assistance

If you encounter a problem with your Watlow controller, review your configuration information to verify that your selections are consistent with your application: inputs, outputs, alarms, limits, etc. If the problem persists, you can get technical assistance from your local Watlow representative (see back cover), by e-mailing your questions to wintechsupport@watlow.com or by dialing +1 (507) 494-5656 between 7 a.m. and 5 p.m., Central Standard Time (CST). Ask for an Applications Engineer. Please have the following information available when calling:

- Complete model number
- All configuration information
- User’s Manual
- Factory Page

Return Material Authorization (RMA)

1. Call Watlow Customer Service, (507) 454-5300, for a Return Material Authorization (RMA) number before returning any item for repair. If you do not know why the product failed, contact an Application Engineer or Product Manager. All RMA’s require:
 - Ship-to address
 - Bill-to address
 - Contact name
 - Phone number
 - Method of return shipment
 - Your P.O. number
 - Detailed description of the problem
 - Any special instructions
 - Name and phone number of person returning the product.
2. Prior approval and an RMA number from the Customer Service Department is required when returning any product for credit, repair or evaluation. Make sure the RMA number is on the outside of the carton and on all paperwork returned. Ship on a Freight Prepaid basis.
3. After we receive your return, we will examine it and try to verify the reason for returning it.
4. In cases of manufacturing defect, we will enter a repair order, replacement order or issue credit for material returned. In cases of customer mis-use, we will provide repair costs and request a purchase order to proceed with the repair work.
5. To return products that are not defective, goods must be in new condition, in the original boxes and they must be returned within 120 days of receipt. A 20 percent restocking charge is applied for all returned stock controls and accessories.
6. If the unit is unrepairable, you will receive a letter of explanation. and be given the option to have the unit returned to you at your expense or to have us scrap the unit.
7. Watlow reserves the right to charge for no trouble found (NTF) returns.

The EZ-ZONE[®] PM User’s Manual is copyrighted by Watlow Winona, Inc., © July 2007 with all rights reserved.

EZ-ZONE[®] PM is covered by U.S. Patent No. 6,005,577 and Patents Pending



Table of Contents

Chapter 1: Overview	2
Standard Features and Benefits	2
Chapter 2: Install and Wire	8
Chapter 3: Keys and Displays	24
Attention Codes	24
Chapter 4: Home Page	26
Chapter 5: Operations Page	28
Chapter 6: Setup Page	33
Chapter 7: Profiling Page	45
Chapter 8: Factory Page	49
Chapter 9: Features	53
Chapter 10: Appendix	66
Troubleshooting Alarms, Errors and Control Issues	66
Specifications	69
Ordering Information for Integrated Controller Models	71
Index	72
Declaration of Conformity	76

1

Chapter 1: Overview

The EZ-ZONE® PM takes the pain out of solving your thermal loop requirements.

Watlow's EZ-ZONE® PM controllers offer options to reduce system complexity and the cost of control-loop ownership. You can order the EZ-ZONE® PM as a PID controller or an over-under limit controller, or you can combine both functions in the PM Integrated Limit Controller. You now have the option to integrate a high-amperage power controller output, an over-under limit controller and a high-performance PID controller all in space-saving, panel-mount packages. You can also select from a number of serial communications options to help you manage system performance.

It just got a whole lot easier to solve the thermal requirements of your system. Because the EZ-ZONE® PM controllers are highly scalable, you only pay for what you need. So if you are looking for a PID controller, an over-under limit controller or an integrated controller, the EZ-ZONE® PM is the answer.

Standard Features and Benefits

Advanced PID Control Algorithm

- TRU-TUNE+® Adaptive tune provides tighter control for demanding applications.
- Auto Tune for fast, efficient start ups

High-amperage Power Control Output

- Drives 15 amp resistive loads directly
- Reduces component count
- Saves panel space and simplifies wiring
- Reduces the cost of ownership

EZ-ZONE® configuration communications and software

- Saves time and improves the reliability of controller set up

FM Approved Over-under Limit with Auxiliary Outputs

- Increases user and equipment safety for over-under temperature conditions

Parameter Save & Restore Memory

- Reduces service calls and down time

Agency approvals: UL Listed, CSA, CE, RoHS, W.E.E.E. FM

- Assures prompt product acceptance
- Reduces end product documentation costs
- FM approval on Limit Models
- Semi F47-0200

P3T Armor Sealing System

- NEMA 4X and IP66 offers water and dust resistance, can be cleaned and washed down
- Backed up by UL 50 independent certification to NEMA 4X specification

Three-year warranty

- Demonstrates Watlow's reliability and product support

Touch-safe Package

- IP2X increased safety for installers and operators

Removable cage clamp wiring connectors

- Reliable wiring, reduced service calls
- Simplified installation

EZ-Key

- Programmable EZ-Key enables simple one-touch operation of repetitive user activities

Programmable Menu System

- Reduces set up time and increases operator efficiency

Full-featured Alarms

- Improves operator recognition of system faults
- Control of auxiliary devices

Heat-Cool Operation

- Provides application flexibility with accurate temperature and process control

Profile Capability

- Preprogrammed process control
- Ramp and soak programming with four files and 40 total steps

A Conceptual View of the PM

The flexibility of the PM's software and hardware allows a large range of configurations. Acquiring a better understanding of the controller's overall functionality and capabilities while at the same time planning out how the controller can be used will deliver maximum effectiveness in your application.

It is useful to think of the controller in three parts: inputs; procedures; and outputs. Information flows from an input to a procedure to an output when the controller is properly configured. A single PM controller can carry out several procedures at the same time, for instance closed-loop control, monitoring for several different alarm situations and operating switched devices, such as lights and motors. Each process needs to be thought out carefully and the controller's inputs, procedures and outputs set up properly.

Inputs

The inputs provide the information that any given programmed procedure can act upon. In a simple form, this information may come from an operator pushing a button or as part of a more complex procedure it may represent a remote set point being received from another controller.

Each analog input typically uses a thermocouple or RTD to read the temperature of something. It can also read volts, current or resistance, allowing it to use various devices to read humidity, air pressure, operator inputs and others values. The settings in the Analog Input Menu (Setup Page) for each analog input must be configured to match the device connected to that input.

Each digital input reads whether a device is active or inactive. A PM with digital input-output hardware includes two sets of terminals each of which can be used as either an input or an output. Each pair of terminals must be configured to function as either an input or output with the Direction parameter in the Digital Input/Output Menu (Setup Page).

The Function or EZ Key on the front panel of the PM also operates as a digital input by toggling the function assigned to it in the Digital Input Function parameter in the Function Key Menu (Setup Page).

Functions

Functions use input signals to calculate a value. A function may be as simple as reading a digital input to set a state to true or false, or reading a temperature to set an alarm state to on or off. Or, it could compare the temperature of a process to the set point and calculate the optimal power for a heater.

To set up a function, it's important to tell it what source, or instance, to use. For example, an alarm may be set to respond to either analog input 1 or 2 (instance 1 or 2, respectively).

Keep in mind that a function is a user-programmed internal process that does not execute any action outside of the controller. To have any effect outside of the controller, an output must be configured to respond to a function.

Outputs

Outputs can perform various functions or actions in response to information provided by a function, such as operating a heater; turning a light on or off; unlocking a door; or turning on a buzzer.

Assign an output to a Function in the Output Menu or Digital Input/Output Menu. Then select which instance of that function will drive the selected output. For example, you might assign an output to respond to alarm 4 (instance 4) or to retransmit the value of analog input 2 (instance 2).

You can assign more than one output to respond to a single instance of a function. For example, alarm 2 could be used to trigger a light connected to output 1 and a siren connected to digital output 5.

Input Events and Output Events

Input events are internal states that are set by the digital inputs. Digital input 5 provides the state of input event 1, and digital input 6 provides the state of input event 2. Wait for Event steps in profiles are triggered by these events. The setting of Digital Input Function (Setup Page, Digital Input/Output Menu) does not change the relationship between the input and the event, so take care not to configure the function in a way that would conflict with a profile that uses an input event. An input will still control the input event state, even if Digital Input Function is set to None.

Output events are internal states that can only be set by profile steps. Outputs 1 through 4 can be configured to respond to output events.

EZ-ZONE® PM Integrated Model 1/16 DIN with a Current Transformer — Input/Output (no communications options 2 to 3)

Universal Sensor Input, Configuration Communications,
Red/Green 7-Segment Display

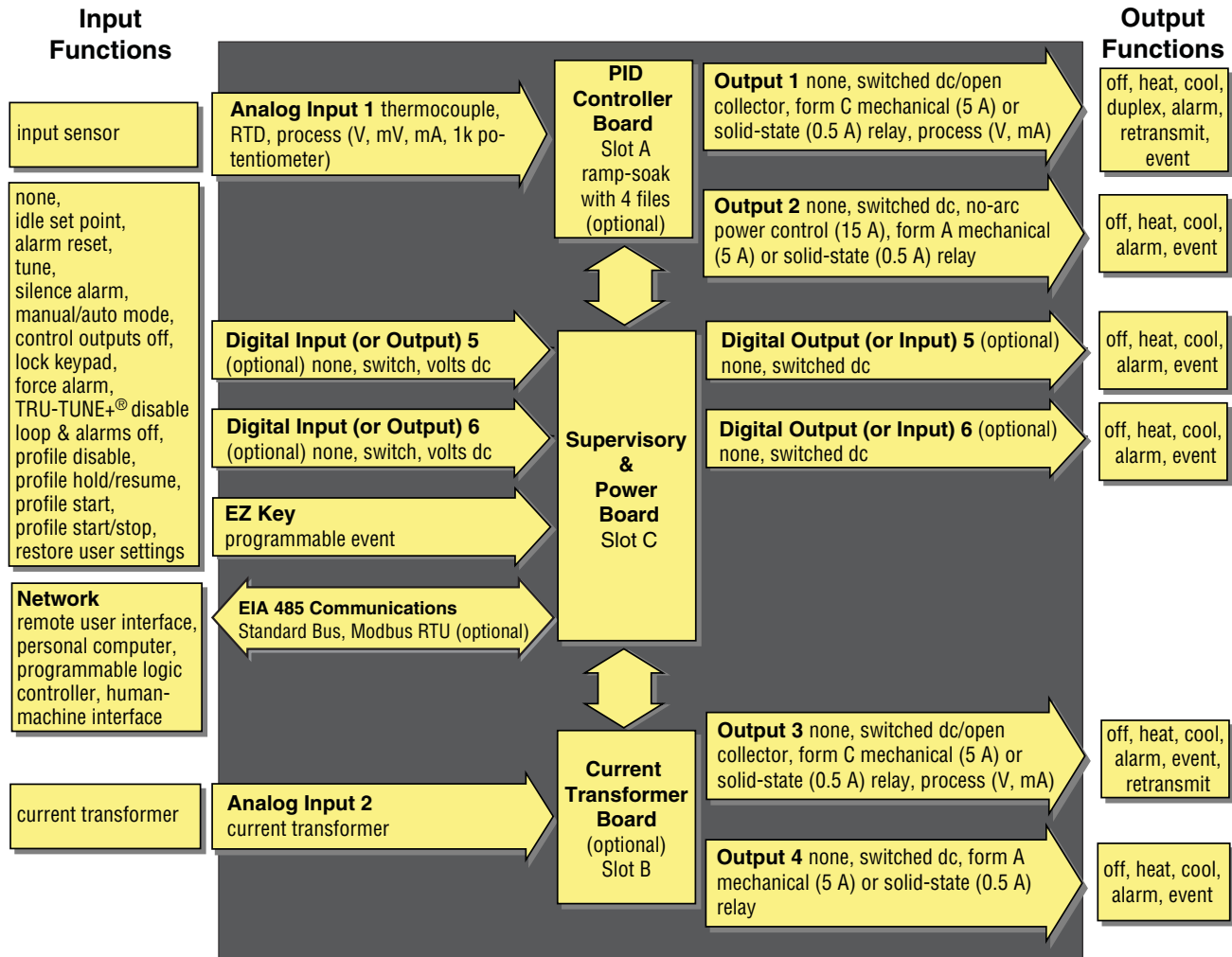

Current Monitoring

- detects heater current flow
- provides an alarm indication of a failed-load issue.

EZ-ZONE® PM Integrated Model 1/16 DIN with Remote Set Point — Input/Output (no communications options 2 to 3)

Universal Sensor Input, Configuration Communications,
Red/Green 7-Segment Display

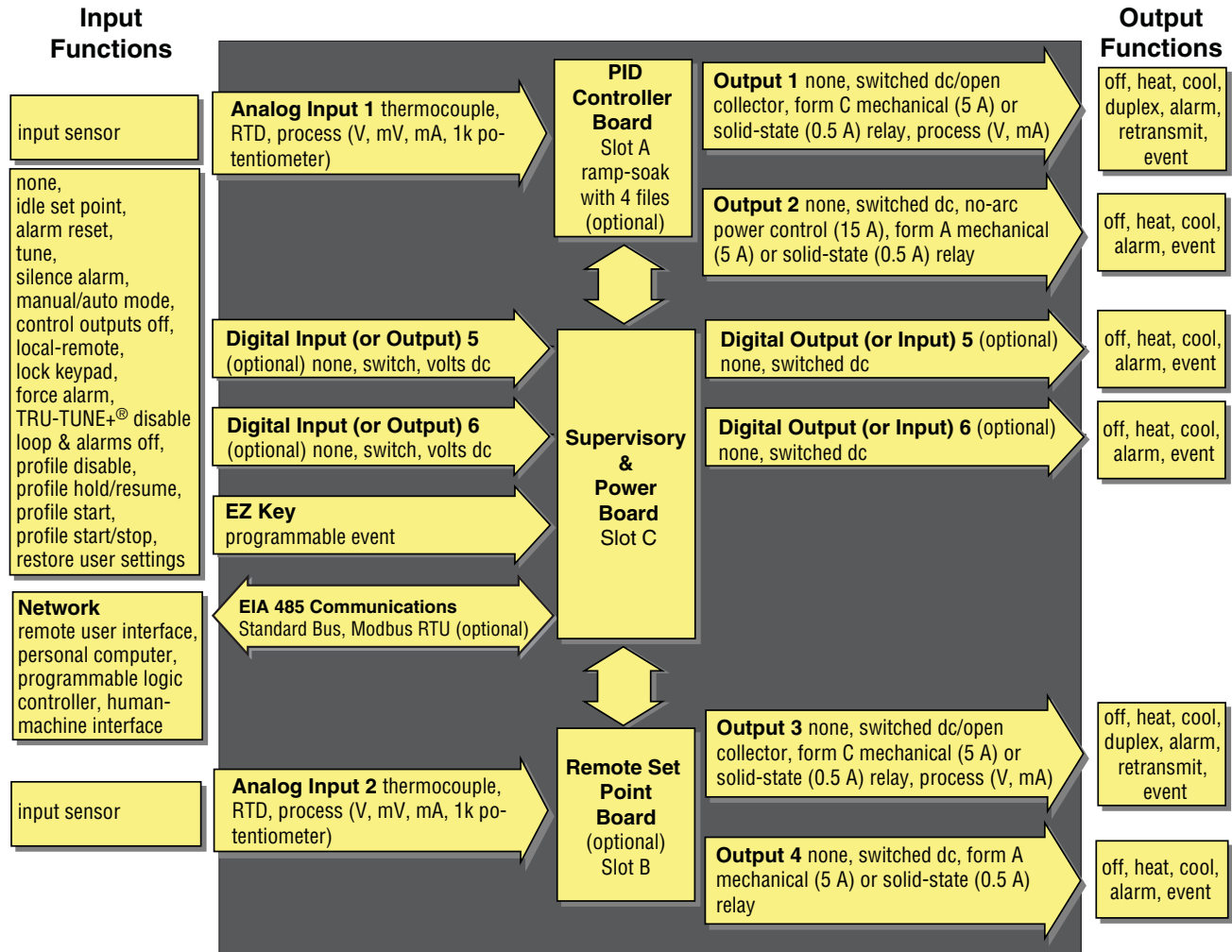

Remote Set Point Operation

- Supports efficient set point manipulation from a remote device, such as a master control or PLC.

EZ-ZONE[®] PM Integrated Model 1/16 DIN with a Limit — Input/Output (no communications options 2 to 3)

Universal Sensor Input, Configuration Communications,
Red/Green 7-Segment Display

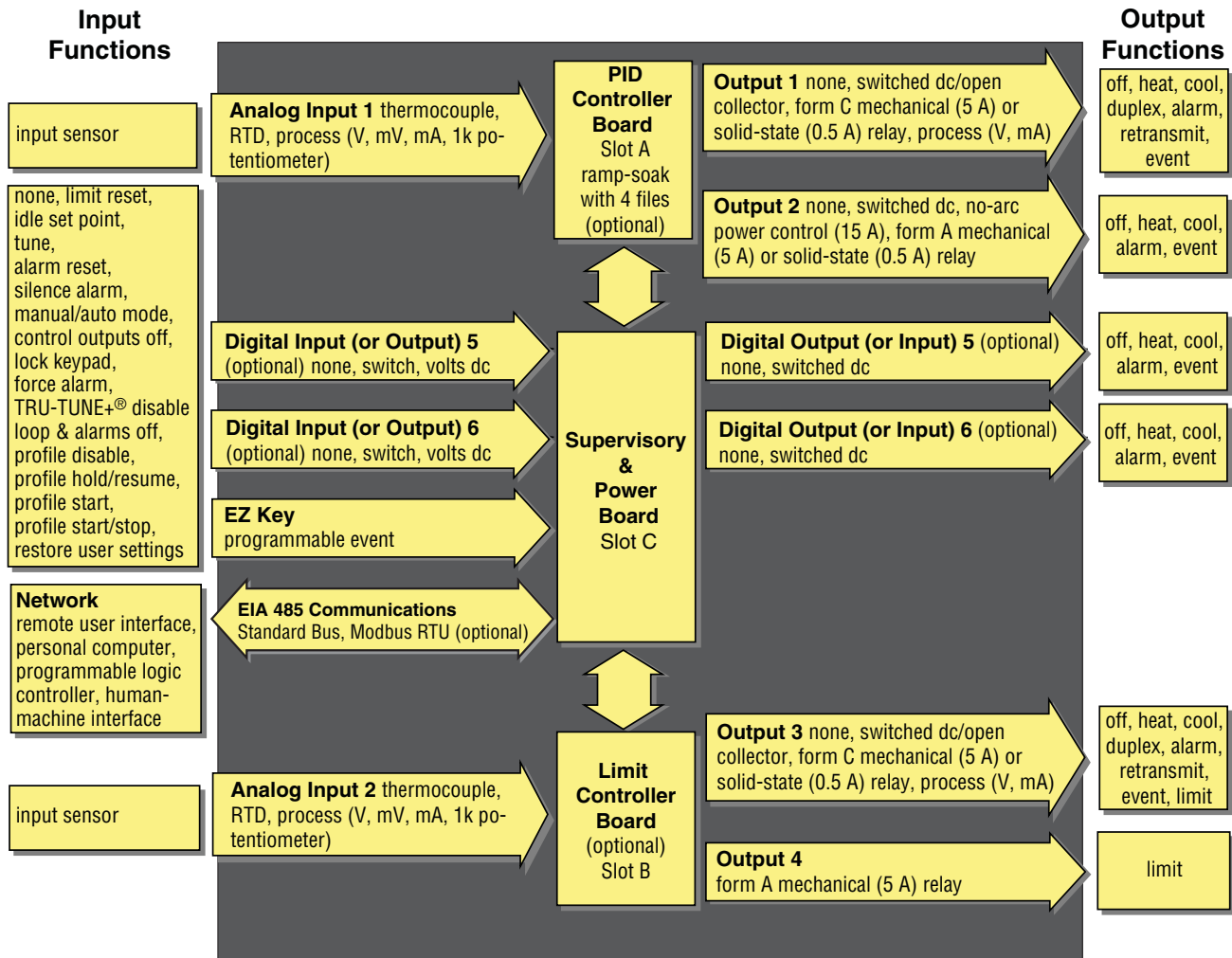

Integrated PID and Limit Controller

- Reduces wiring time and termination complexity compared to connecting separate products
- Reduces panel space
- Reduces installation costs
- Increases dependability with backup control sensor operation
- Increases user and equipment safety for over-under temperature conditions

EZ-ZONE® PM Integrated Model 1/16 DIN with Expanded Communications — Input/Output

Universal Sensor Input, Configuration Communications,
Red/Green 7-Segment Display

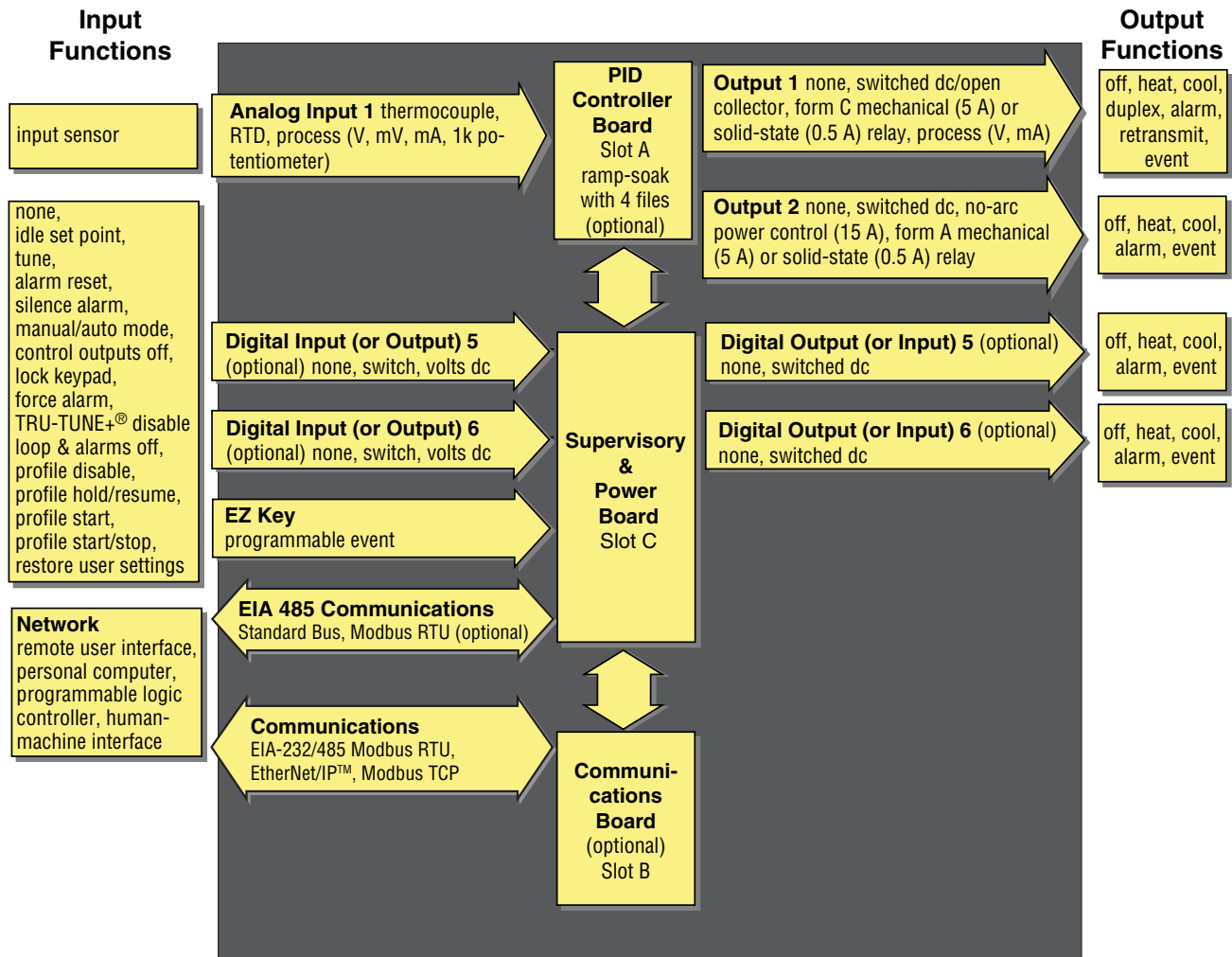

Serial Communication Capabilities

- Supports network connectivity to a PC or PLC
- Available in a wide range of protocol choices, including Modbus RTU, EtherNet/IP™, Modbus TCP

2

Chapter 2: Install and Wire

Dimensions

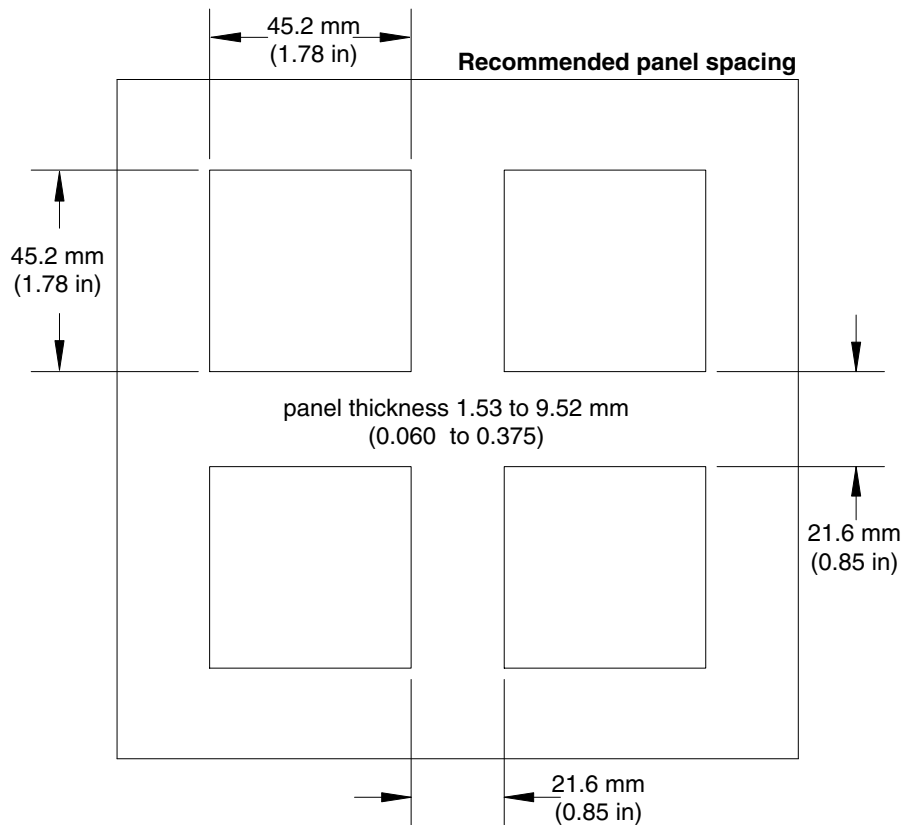
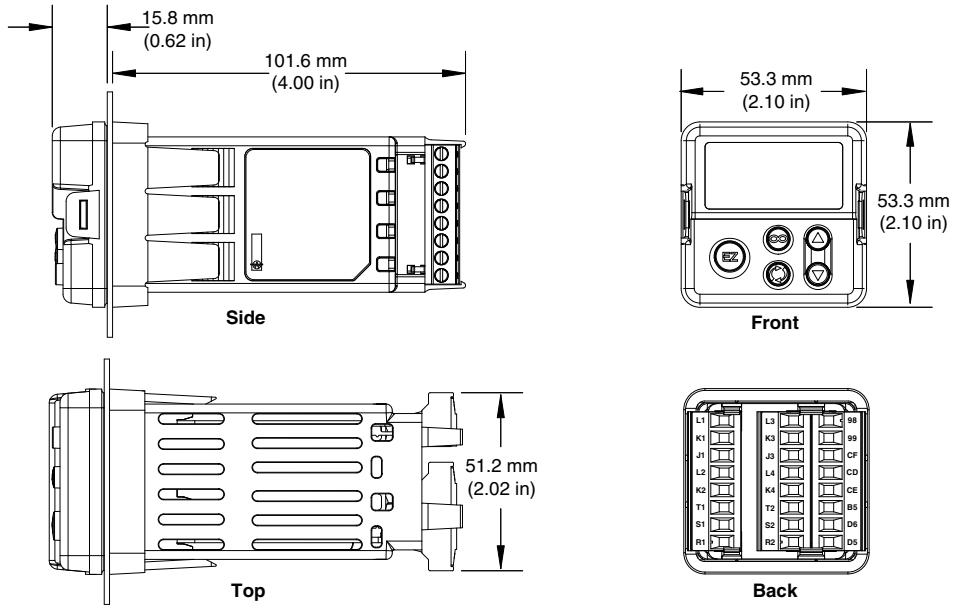

Installation

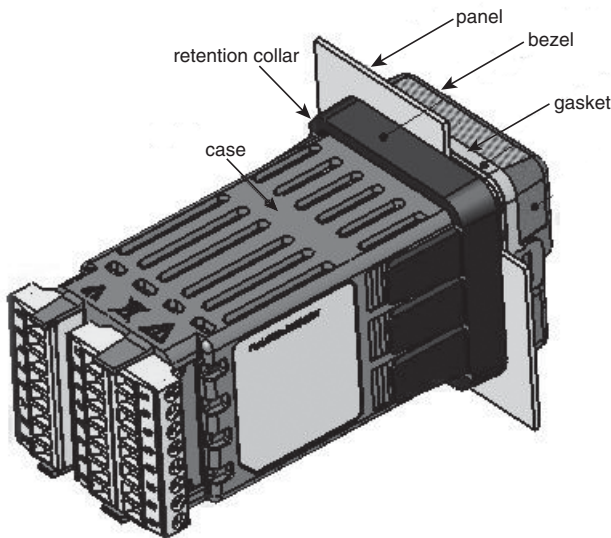

1. Make the panel cutout using the mounting template dimensions in this chapter.
Insert the case assembly into the panel cutout.
2. While pressing the case assembly firmly against the panel, slide the mounting collar over the back of the controller.

If the installation does not require a NEMA 4X seal, slide the mounting collar up to the back of the panel tight enough to eliminate the spacing between the gasket and the panel.

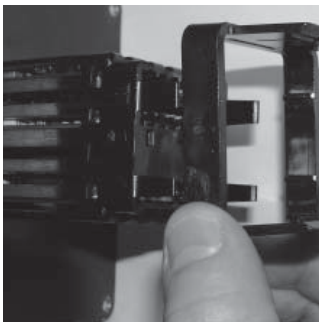

Slide the mounting collar over the back of the controller.

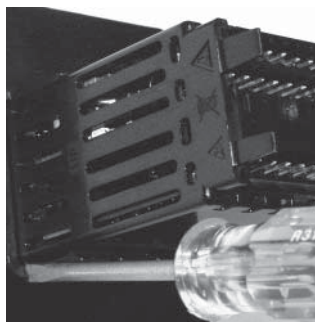

Place the blade of a screwdriver in the notch of the mounting collar assembly.

3. For a NEMA 4X (UL50, IP66) seal, place the blade of a screwdriver in the notch of the mounting collar assembly and push toward the panel while applying pressure to the face of the controller. Don't be afraid to apply enough pressure to properly install the controller. The seal system is compressed more by mating the mounting collar tighter to the front panel (see pictures above). If you can move the case assembly back and forth in the cutout, you do not have a proper seal.

The tabs on each side of the mounting collar have teeth that latch into the ridges on the sides of the controller. Each tooth is staggered at a different depth from the front so that only one of the tabs, on each side, is locked onto the ridges at a time.

Note: There is a graduated measurement difference between the upper and lower half of the display to the panel. In order to meet the seal requirements mentioned above, ensure that the distance from the front of the top half of the display to the panel is 16 mm (0.630 in.) or less, and the distance from the front of the bottom half and the panel is 13.3 mm (0.525 in.) or less.

Removing the Mounted Controller from Its Case

1. From the controller's face, pull out the tab on each side until you hear it click.



Pull out the tab on each side until you hear it click.



Grab the unit above and below the face and pull forward.

2. Once the sides are released, grab the unit above and below the face with two hands and pull the unit out.

If it is difficult to pull the unit out, remove the connectors from the back of the controller. This should make it easier to remove.



Warning:

- This equipment is suitable for use in class 1, div. 2, Groups A, B, C and D or Non-Hazardous locations only. Temperature Code T4A.
- **WARNING – EXPLOSION HAZARD.** Substitution of component may impair suitability for class 1, div. 2.
- **WARNING – EXPLOSION HAZARD.** Do not disconnect equipment unless power has been switched off or the area is known to be nonhazardous.

Returning the Controller to its Case

1. Ensure that the orientation of the controller is correct and slide it back into the housing.

Note: The controller is keyed so if it feels that it will not slide back in do not force it. Check the orientation again and reinsert after correcting.

2. Using your thumbs push on either side of the controller until both latches click.

Chemical Compatibility

This product is compatible with acids, weak alkalis, alcohols, gamma radiation and ultraviolet radiation.

This product is not compatible with strong alkalis, organic solvents, fuels, aromatic hydrocarbons, chlorinated hydrocarbons, esters and ketones.



Warning:

All electrical power to the controller and controlled circuits must be disconnected before removing the controller from the front panel or disconnecting other wiring.

Failure to follow these instructions may cause an electrical shock and/or sparks that could cause an explosion in class 1, div. 2 hazardous locations.

Slot A		Slot B			
Output				Terminal Function	Configuration
1	2	3	4		
X1 W1 Y1		X3 W3 Y3		common (Any switched dc output can use this common.) dc- (open collector) dc+	Switched dc/open collector output 1: PM6 __ C _ _ _ _ A _ _ output 3: PM6 _ _ _ _ C _ A _ _
	W2 Y2		W4 Y4	dc- dc+	Switched dc output 2: PM6 __ _ _ C - _ _ _ A _ _ output 4: PM6 _ _ _ _ _ _ _ _ C A _ _
F1 G1 H1		F3 G3 H3		voltage or current - voltage + current +	Universal Process output 1: PM6 __ F _ - _ _ _ A _ _ output 3: PM6 _ _ _ _ - _ _ F _ A _ _
L1 K1 J1		L3 K3 J3		normally open common normally closed	Mechanical Relay 5 A, Form C output 1: PM6 __ E _ - _ _ _ A _ _ output 3: PM6 _ _ _ _ - _ _ E _ A _ _
	L2 K2			normally open common	No-arc 15 A, Form A output 2: PM6 __ _ _ H - _ _ _ A _ _
	L2 K2		L4 K4	normally open common	Mechanical Relay 5 A, Form A output 2: PM6 __ _ _ J - _ _ _ A _ _ output 4: PM6 _ _ _ _ - _ _ J A _ _
L1 K1	L2 K2	L3 K3	L4 K4	normally open common	Solid-state Relay 0.5 A, Form A output 1: PM6 __ K _ - _ _ _ A _ _ output 2: PM6 __ _ _ K - _ _ _ A _ _ output 3: PM6 _ _ _ _ - _ K _ A _ _ output 4: PM6 _ _ _ _ - _ _ K A _ _
Communications					
		CB CA CC CB CA C5 C3 C2		Modbus RTU EIA-485 T+/R+ Modbus RTU EIA-485 T-/R- Modbus RTU EIA-485 common Modbus RTU EIA-485 T+/R+ Modbus RTU EIA-485 T-/R- Modbus RTU EIA-232 common Modbus RTU EIA-232 to DB9 pin 2 Modbus RTU EIA-232 to DB9 pin 3	Modbus RTU 232/485 Communications PM6 _ _ _ _ - 2 A A A A _ _
		V+ CH SH CL V-		DeviceNet™ power Positive side of DeviceNet™ bus Shield interconnect Negative side of DeviceNet™ bus DeviceNet™ power return	DeviceNet™ Communications PM6 _ _ _ _ - 5 A A A A _ _
		E8 E7 E6 E5 E4 E3 E2 E1		EtherNet/IP™ and Modbus TCP unused EtherNet/IP™ and Modbus TCP unused EtherNet/IP™ and Modbus TCP receive - EtherNet/IP™ and Modbus TCP unused EtherNet/IP™ and Modbus TCP unused EtherNet/IP™ and Modbus TCP receive + EtherNet/IP™ and Modbus TCP transmit - EtherNet/IP™ and Modbus TCP transmit +	Ethernet 10/100 supporting EtherNet/IP™ and Modbus TCP PM6 _ _ _ _ - 3 A A A A _ _
Inputs					
T1 S1 R1		T2 S2 R2		S2 (RTD) or current +, potentiometer wiper S3 (RTD), thermocouple -, current - or volts - S1 (RTD), thermocouple + or volts +	Universal Sensor input 1: all configurations input 2: PM6 _ _ _ _ - (R or L) _ _ A _ _
		T2 S2		mA ac mA ac	Current Transformer PM6 _ _ _ _ - T _ _ A _ _

Terminal Definitions for Slots A and B.

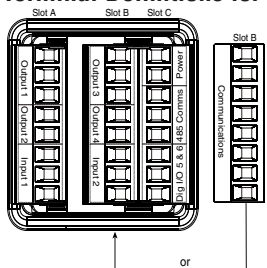

Slot C	Terminal Function	Configuration
98 99	power input: ac or dc+ power input: ac or dc-	all
CC CA CB	Standard Bus or Modbus RTU EIA-485 common Standard Bus or Modbus RTU EIA-485 T-/R- Standard Bus or Modbus RTU EIA-485 T+/R+	Standard Bus or Modbus PM6 ___-1___A__
CF CD CE	Standard Bus EIA-485 common Standard Bus EIA-485 T-/R- Standard Bus EIA-485 T+/R+	PM6 ___-(A, 2 or 3)___A__
B5 D6 D5	digital input-output common digital input or output 6 digital input or output 5	PM6 _2___-___A__ PM6 _4___-___A__

Terminal Definitions for Slot C.

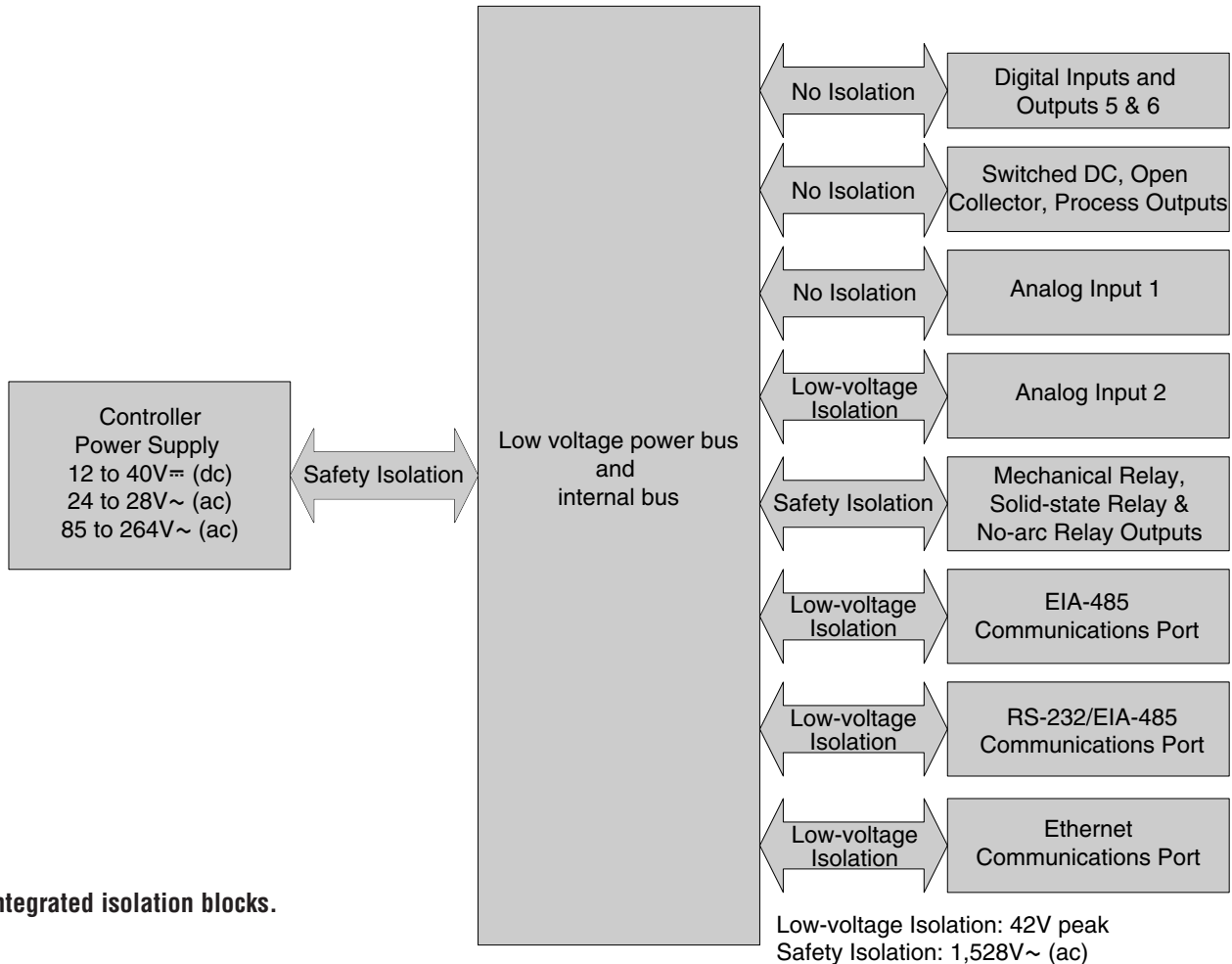
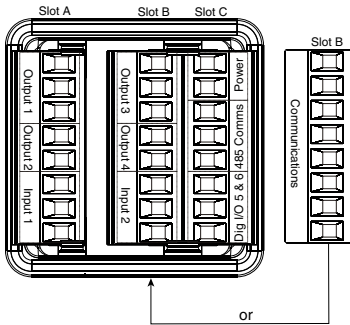



Warning:
Use National Electric (NEC) or other country-specific standard wiring and safety practices when wiring and connecting this controller to a power source and to electrical sensors or peripheral devices. Failure to do so may result in damage to equipment and property, and/or injury or loss of life.

Note:
Maximum wire size termination and torque rating:
• 0.0507 to 3.30 mm² (30 to 12 AWG) single-wire termination or two 1.31 mm² (16 AWG)
• 0.8 Nm (7.0 lb.-in.) torque

Note:
Adjacent terminals may be labeled differently, depending on the model number.

Note:
To prevent damage to the controller, do not connect wires to unused terminals.

Note:
Maintain electrical isolation between analog input 1, digital input-outputs, switched dc/open collector outputs and process outputs to prevent ground loops.

Note:
The control output common terminal and the digital common terminal are referenced to different voltages and must remain isolated.

Low Power

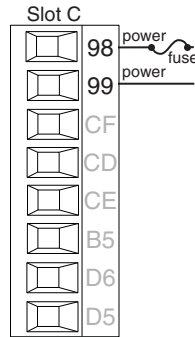

- 12 to 40V[≐] (dc)
 - 20 to 28V~ (ac)
 - 20 to 28V~ (ac) Semi Sig F47
 - 47 to 63 Hz
 - 10VA maximum power consumption
- PM6 _ (3 or 4) _ _ _ _ _ A _ _

High Power

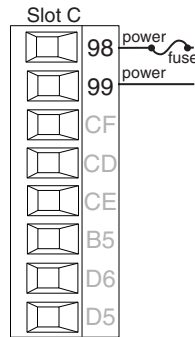

- 85 to 264V~ (ac)
 - 100 to 240V~ (ac) Semi Sig F47
 - 47 to 63 Hz
 - 10VA maximum power consumption
- PM6 _ (1 or 2) _ _ _ _ _ A _ _

Digital Input or Output 5

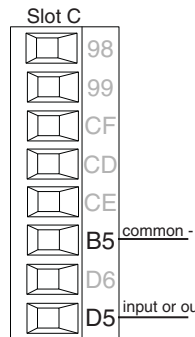

Digital Input

- update rate 10 Hz
- dry contact or dc voltage

DC voltage

- maximum input 36V at 3 mA
- minimum high state 3V @ 0.25 mA
- maximum low state 2V

Dry contact

- minimum open resistance 500 Ω
- maximum closed resistance 100 Ω
- maximum short circuit 13 mA

Digital Output

- update rate 10 Hz
- output voltage 24V
- current limit, Output 5, 24 mA maximum
- capable of driving a 3-pole DIN-A-MITE
- open-circuit voltage 22 to 32V[≐] (dc)

PM6 _ (2 or 4) _ _ _ _ _ A _ _

Digital Input or Output 6

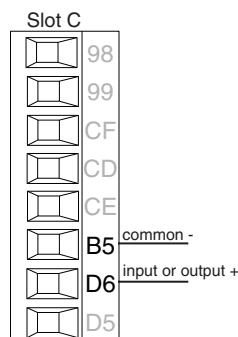

Digital Input

- update rate 10 Hz
- dry contact or dc voltage

DC voltage

- maximum input 36V at 3 mA
- minimum high state 3V @ 0.25 mA
- maximum low state 2V

Dry contact

- minimum open resistance 500 Ω
- maximum closed resistance 100 Ω
- maximum short circuit 13 mA

Digital Output

- update rate 10 Hz
- output voltage 24V
- current limit, Output 6, 10 mA maximum
- capable of driving a single-pole DIN-A-MITE
- open-circuit voltage 22 to 32V[≐] (dc)

PM6 _ (2 or 4) _ _ _ _ _ A _ _



Warning:
Use National Electric (NEC) or other country-specific standard wiring and safety practices when wiring and connecting this controller to a power source and to electrical sensors or peripheral devices. Failure to do so may result in damage to equipment and property, and/or injury or loss of life.

Note:
Maximum wire size termination and torque rating:
• 0.0507 to 3.30 mm² (30 to 12 AWG) single-wire termination or two 1.31 mm² (16 AWG)
• 0.8 Nm (7.0 lb.-in.) torque

Note:
Adjacent terminals may be labeled differently, depending on the model number.

Note:
To prevent damage to the controller, do not connect wires to unused terminals.

Note:
Maintain electrical isolation between analog input 1, digital input-outputs, switched dc/open collector outputs and process outputs to prevent ground loops.

Note:
The control output common terminal and the digital common terminal are referenced to different voltages and must remain isolated.

Input 1 Thermocouple

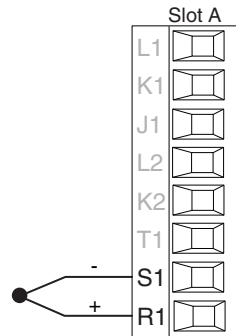

- 20 Ω maximum source resistance
- >20 M Ω input impedance
- 3 microampere open-sensor detection
- Thermocouples are polarity sensitive. The negative lead (usually red) must be connected to S1.
- To reduce errors, the extension wire for thermocouples must be of the same alloy as the thermocouple.

PM6 _ _ _ _ _ A _ _ (all)

Input 1 RTD

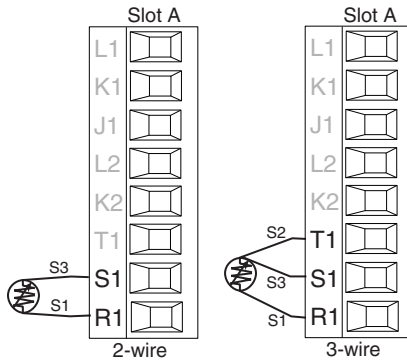

- platinum, 100 and 1,000 Ω @ 0°C
- calibration to DIN curve (0.00385 $\Omega/\Omega^\circ\text{C}$)
- 20 Ω total lead resistance
- RTD excitation current of 0.09 mA typical. Each ohm of lead resistance may affect the reading by 0.03°C.
- For 3-wire RTDs, the S1 lead (usually white) must be connected to R1.
- For best accuracy use a 3-wire RTD to compensate for lead-length resistance. All three lead wires must have the same resistance.

PM6 _ _ _ _ _ A _ _ (all)

Input 1 Process

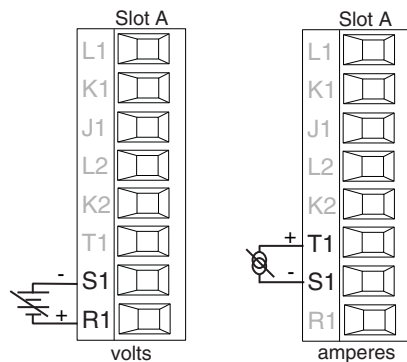

- 0 to 20 mA @ 100 Ω input impedance
- 0 to 10V \approx (dc) @ 20 k Ω input impedance
- 0 to 50 mV \approx (dc) @ 20 k Ω input impedance
- scalable

PM6 _ _ _ _ _ A _ _ (all)

Input 1 Potentiometer

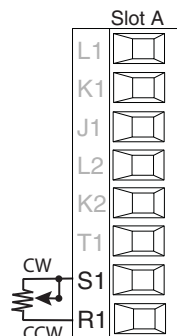

- Use a 1 k Ω potentiometer.

PM6 _ _ _ _ _ A _ _ (all)



Warning:
Use National Electric (NEC) or other country-specific standard wiring and safety practices when wiring and connecting this controller to a power source and to electrical sensors or peripheral devices. Failure to do so may result in damage to equipment and property, and/or injury or loss of life.

Note:
Maximum wire size termination and torque rating:
• 0.0507 to 3.30 mm² (30 to 12 AWG) single-wire termination or two 1.31 mm² (16 AWG)
• 0.8 Nm (7.0 lb.-in.) torque

Note:
Adjacent terminals may be labeled differently, depending on the model number.

Note:
To prevent damage to the controller, do not connect wires to unused terminals.

Note:
Maintain electrical isolation between analog input 1, digital input-outputs, switched dc/open collector outputs and process outputs to prevent ground loops.

Note:
The control output common terminal and the digital common terminal are referenced to different voltages and must remain isolated.

Input 2 Thermocouple

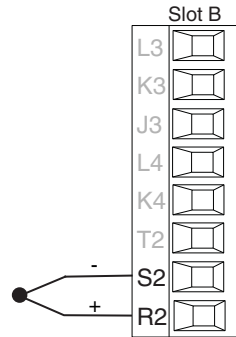

- 20 Ω maximum source resistance
- >20 MΩ input impedance
- 3 microampere open-sensor detection
- Thermocouples are polarity sensitive. The negative lead (usually red) must be connected to S2.
- To reduce errors, the extension wire for thermocouples must be of the same alloy as the thermocouple.

PM6 _ _ _ _ (R or L) _ _ A _ _

Input 2 RTD

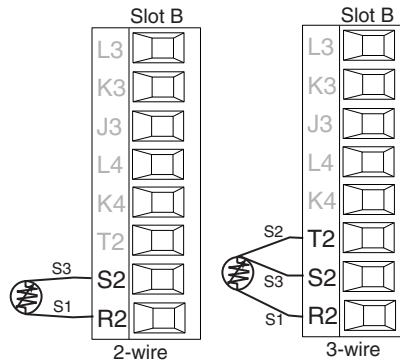

- platinum, 100 and 1,000 Ω @ 0°C
- calibration to DIN curve (0.00385 Ω/Ω/°C)
- 20 Ω total lead resistance
- RTD excitation current of 0.09 mA typical. Each ohm of lead resistance may affect the reading by 0.03°C.
- For 3-wire RTDs, the S1 lead (usually white) must be connected to R2.
- For best accuracy use a 3-wire RTD to compensate for lead-length resistance. All three lead wires must have the same resistance.

PM6 _ _ _ _ (R or L) _ _ A _ _

Input 2 Process

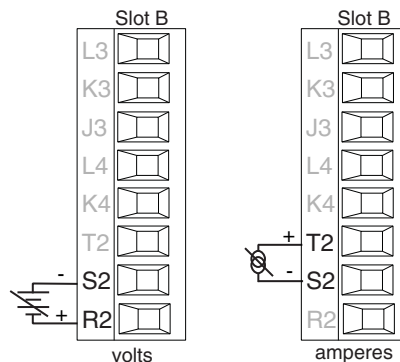

- 0 to 20 mA @ 100 Ω input impedance
- 0 to 10V_{DC} @ 20 kΩ input impedance
- 0 to 50 mV_{DC} @ 20 kΩ input impedance
- scalable

PM6 _ _ _ _ (R, T or L) _ _ A _ _

Input 2 Potentiometer

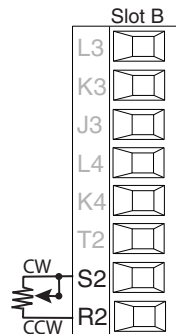

- Use a 1 kΩ potentiometer.

PM6 _ _ _ _ (R or L) _ _ A _ _



Warning:
Use National Electric (NEC) or other country-specific standard wiring and safety practices when wiring and connecting this controller to a power source and to electrical sensors or peripheral devices. Failure to do so may result in damage to equipment and property, and/or injury or loss of life.

Note:
Maximum wire size termination and torque rating:
• 0.0507 to 3.30 mm² (30 to 12 AWG) single-wire termination or two 1.31 mm² (16 AWG)
• 0.8 Nm (7.0 lb.-in.) torque

Note:
Adjacent terminals may be labeled differently, depending on the model number.

Note:
To prevent damage to the controller, do not connect wires to unused terminals.

Note:
Maintain electrical isolation between analog input 1, digital input-outputs, switched dc/open collector outputs and process outputs to prevent ground loops.

Note:
The control output common terminal and the digital common terminal are referenced to different voltages and must remain isolated.

Input 2 Current Transformer

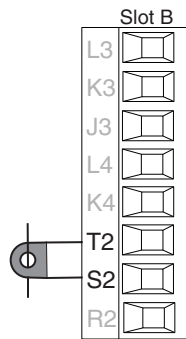

- Input range is 0 to 50 mA.
 - current transformer part number: 16-0246
 - 100 Ω input impedance
 - response time: 1 second maximum
 - accuracy +/-1 mA typical
- PM6 _ _ _ _ _ T _ _ A _ _



Warning:

Use National Electric (NEC) or other country-specific standard wiring and safety practices when wiring and connecting this controller to a power source and to electrical sensors or peripheral devices. Failure to do so may result in damage to equipment and property, and/or injury or loss of life.

Note:

Maximum wire size termination and torque rating:

- 0.0507 to 3.30 mm² (30 to 12 AWG) single-wire termination or two 1.31 mm² (16 AWG)
- 0.8 Nm (7.0 lb.-in.) torque

Note:

Adjacent terminals may be labeled differently, depending on the model number.

Note:

To prevent damage to the controller, do not connect wires to unused terminals.

Note:

Maintain electrical isolation between analog input 1, digital input-outputs, switched dc/open collector outputs and process outputs to prevent ground loops.

Note:

The control output common terminal and the digital common terminal are referenced to different voltages and must remain isolated.

Quencharc Note:

Switching pilot duty inductive loads (relay coils, solenoids, etc.) with the mechanical relay, solid state relay or open collector output options requires use of an R.C. suppressor.

Output 1 Switched DC/Open Collector

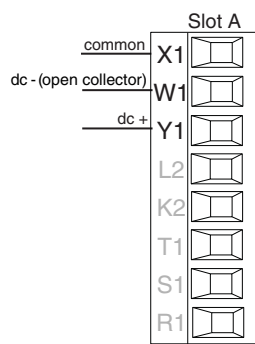

Switched DC

- 30 mA dc maximum supply current
- short circuit limited to <50 mA
- 22 to 32V \approx (dc) open circuit voltage
- Use dc- and dc+ to drive external solid-state relay.
- DIN-A-MITE compatible
- single-pole: up to 4 in parallel or 4 in series
- 2-pole: up to 2 in parallel or 2 in series
- 3-pole: up to 2 in series

Open Collector

- 100 mA maximum output current sink
- 30V \approx (dc) maximum supply voltage
- Any switched dc output can use the common terminal.
- Use an external power supply to control a dc load, with the load positive to the positive of the power supply, the load negative to the open collector and common to the power supply negative.

See Quencharc note.

PM6 __ C _ - - - - A _ _

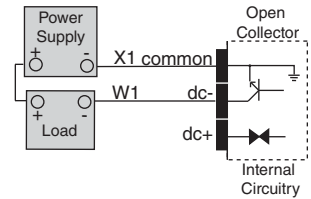
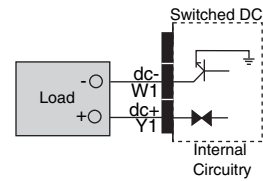

Output 1 Mechanical Relay, Form C

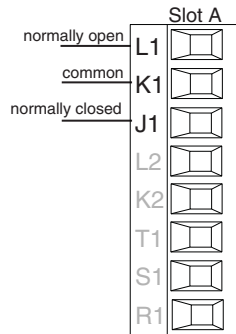

- 5 A at 240V \sim (ac) or 30V \approx (dc) maximum resistive load
- 20 mA at 24V minimum load
- 125 VA pilot duty at 120/240V \sim (ac), 25 VA at 24V \sim (ac)
- 100,000 cycles at rated load
- Output does not supply power.
- for use with ac or dc

See Quencharc note.

PM6 __ E _ - - - - A _ _

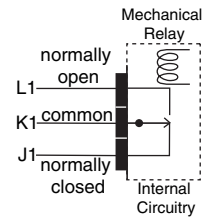

Output 1 Universal Process

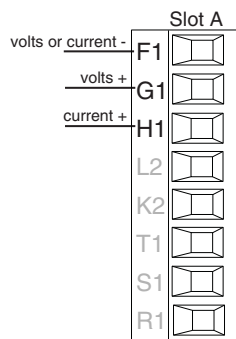

- 0 to 20 mA into 800 Ω maximum load
- 0 to 10V \approx (dc) into voltage 1 k Ω minimum load
- scalable
- output supplies power
- cannot use voltage and current outputs at same time
- Output may be used as re-transmit or control.

PM6 __ F _ - - - - A _ _

Note: If output 1 is a universal process output, output 2 cannot function as a variable-time-base output.



Warning:

Use National Electric (NEC) or other country-specific standard wiring and safety practices when wiring and connecting this controller to a power source and to electrical sensors or peripheral devices. Failure to do so may result in damage to equipment and property, and/or injury or loss of life.

Note:

Maximum wire size termination and torque rating:
• 0.0507 to 3.30 mm² (30 to 12 AWG) single-wire termination or two 1.31 mm² (16 AWG)
• 0.8 Nm (7.0 lb.-in.) torque

Note:

Adjacent terminals may be labeled differently, depending on the model number.

Note:

To prevent damage to the controller, do not connect wires to unused terminals.

Note:

Maintain electrical isolation between analog input 1, digital input-outputs, switched dc/open collector outputs and process outputs to prevent ground loops.

Note:

The control output common terminal and the digital common terminal are referenced to different voltages and must remain isolated.

Quencharc Note:

Switching pilot duty inductive loads (relay coils, solenoids, etc.) with the mechanical relay, solid state relay or open collector output options requires use of an R.C. suppressor.

Output 1 Solid-state Relay, Form A

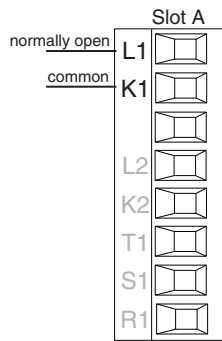

- 0.5 A at 20 to 264V~ (ac) maximum resistive load
- 20 VA 120/240V~ (ac) pilot duty
- opto-isolated, without contact suppression
- maximum off state leakage of 105 microamperes
- output does not supply power
- Do not use on dc loads.
- See Quencharc note.

PM6 _ _ K _ _ _ A _ _

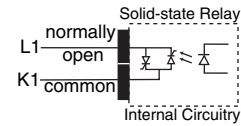

Output 2 Switched DC

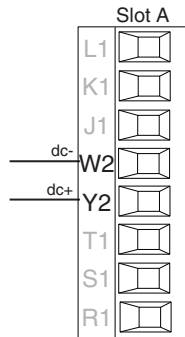

- 10 mA DC maximum supply current
- short circuit limited to <50 mA
- 22 to 32V= (dc) open circuit voltage
- use dc- and dc+ to drive external solid-state relay
- DIN-A-MITE compatible
- single-pole: up to 2 in series, none in parallel

PM6 _ _ C _ _ _ A _ _

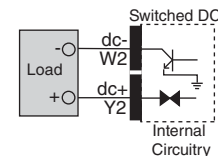

Output 2 No-arc Relay, Form A

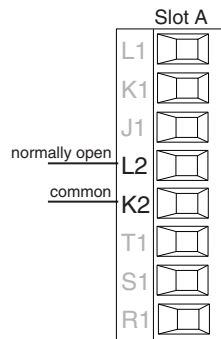

- 15 A at 85 to 264V~ (ac) resistive load only
- 2,000,000 cycle rating for no-arc circuit (preliminary)
- 100 mA minimum load
- 2 mA maximum off state leakage
- Do not use on dc loads.
- Output does not supply power.

PM6 _ _ H _ _ _ A _ _

Output 2 Mechanical Relay, Form A

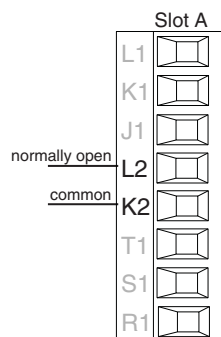

- 5 A at 240V~ (ac) or 30V= (dc) maximum resistive load
 - 20 mV at 24V minimum load
 - 125 VA pilot duty @ 120/240V~ (ac), 25 VA at 24V~ (ac)
 - 100,000 cycles at rated load
 - Output does not supply power.
 - for use with ac or dc
- See Quencharc note.

PM6 _ _ J _ _ _ A _ _

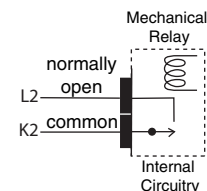



Warning:
Use National Electric (NEC) or other country-specific standard wiring and safety practices when wiring and connecting this controller to a power source and to electrical sensors or peripheral devices. Failure to do so may result in damage to equipment and property, and/or injury or loss of life.

Note:
Maximum wire size termination and torque rating:
• 0.0507 to 3.30 mm² (30 to 12 AWG) single-wire termination or two 1.31 mm² (16 AWG)
• 0.8 Nm (7.0 lb.-in.) torque

Note:
Adjacent terminals may be labeled differently, depending on the model number.

Note:
To prevent damage to the controller, do not connect wires to unused terminals.

Note:
Maintain electrical isolation between analog input 1, digital input-outputs, switched dc/open collector outputs and process outputs to prevent ground loops.

Note:
The control output common terminal and the digital common terminal are referenced to different voltages and must remain isolated.

Quencharc Note:
Switching pilot duty inductive loads (relay coils, solenoids, etc.) with the mechanical relay, solid state relay or open collector output options requires use of an R.C. suppressor.

Output 2 Solid-state Relay, Form A

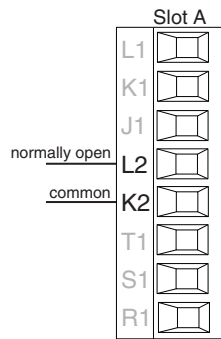

- 0.5 A at 20 to 264V~ (ac) maximum resistive load
 - 20 VA 120/240V~ (ac) pilot duty
 - opto-isolated, without contact suppression
 - maximum off state leakage of 105 microamperes
 - Output does not supply power.
 - Do not use on dc loads.
- See Quencharc note.
PM6 _ _ _ K _ _ _ A _ _

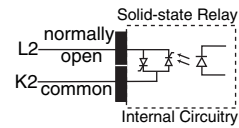

Output 3 Switched DC/Open Collector

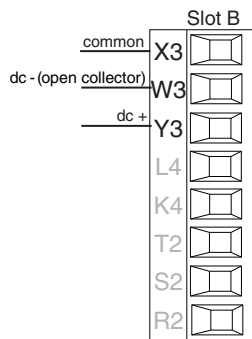

- Switched DC**
- 30 mA dc maximum supply current
 - short circuit limited to <50 mA
 - 22 to 32V= (dc) open circuit voltage
 - Use dc- and dc+ to drive external solid-state relay.
 - DIN-A-MITE compatible
 - single-pole: up to 4 in parallel or 4 in series
 - 2-pole: up to 2 in parallel or 2 in series
 - 3-pole: up to 2 in series

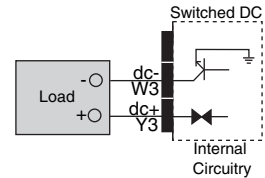

- Open Collector**
- 100 mA maximum output current sink
 - 30V= (dc) maximum supply voltage
 - Any switched dc output can use the common terminal.
 - Use an external power supply to control a dc load, with the load positive to the positive of the power supply, the load negative to the open collector and common to the power supply negative.

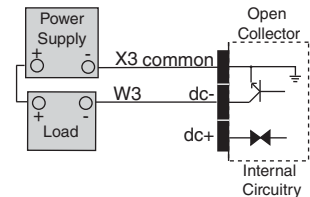

See Quencharc note.
PM6 _ _ _ _ _ C _ A _ _

Output 3 Mechanical Relay, Form C

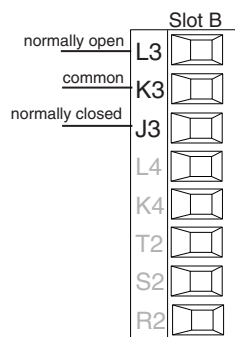

- 5 A at 240V~ (ac) or 30V= (dc) maximum resistive load
 - 20 mA at 24V minimum load
 - 125 VA pilot duty at 120/240V~ (ac), 25 VA at 24V~ (ac)
 - 100,000 cycles at rated load
 - Output does not supply power.
 - for use with ac or dc
- See Quencharc note.
PM6 _ _ _ _ _ E _ A _ _

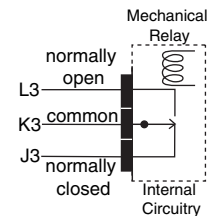



Warning:
Use National Electric (NEC) or other country-specific standard wiring and safety practices when wiring and connecting this controller to a power source and to electrical sensors or peripheral devices. Failure to do so may result in damage to equipment and property, and/or injury or loss of life.

Note:
Maximum wire size termination and torque rating:
• 0.0507 to 3.30 mm² (30 to 12 AWG) single-wire termination or two 1.31 mm² (16 AWG)
• 0.8 Nm (7.0 lb.-in.) torque

Note:
Adjacent terminals may be labeled differently, depending on the model number.

Note:
To prevent damage to the controller, do not connect wires to unused terminals.

Note:
Maintain electrical isolation between analog input 1, digital input-outputs, switched dc/open collector outputs and process outputs to prevent ground loops.

Note:
The control output common terminal and the digital common terminal are referenced to different voltages and must remain isolated.

Quencharc Note:
Switching pilot duty inductive loads (relay coils, solenoids, etc.) with the mechanical relay, solid state relay or open collector output options requires use of an R.C. suppressor.

Output 3 Universal Process

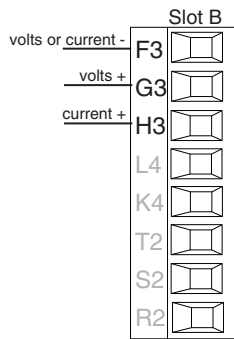

- 0 to 20 mA into 800 Ω maximum load
- 0 to 10V_{DC} (dc) into voltage 1 kΩ minimum load
- scalable
- Output supplies power.
- cannot use voltage and current outputs at same time
- Output may be used as retransmit or control.

PM6 _ _ _ _ _ F _ A _ _

Note: If output 3 is a universal process output, output 4 cannot function as a variable-time-base output.

Output 3 Solid-state Relay, Form A

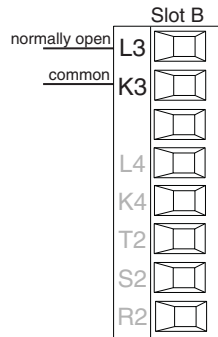

- 0.5 A at 20 to 264V_{AC} (ac) maximum resistive load
- 20 VA 120/240V_{AC} (ac) pilot duty
- opto-isolated, without contact suppression
- maximum off state leakage of 105 microamperes
- Output does not supply power.
- Do not use on dc loads.

See Quencharc note.
PM6 _ _ _ _ _ K _ A _ _

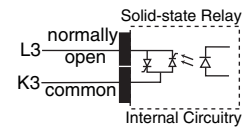

Output 4 Switched DC

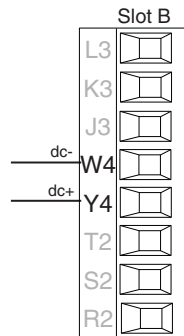

- 10 mA DC maximum supply current
- short circuit limited to <50 mA
- 22 to 32V_{DC} (dc) open circuit voltage
- Use dc- and dc+ to drive external solid-state relay.
- DIN-A-MITE compatible
- single-pole: up to 2 in series, none in parallel

PM6 _ _ _ _ _ C A _ _

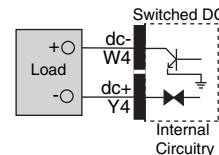

Output 4 Mechanical Relay, Form A

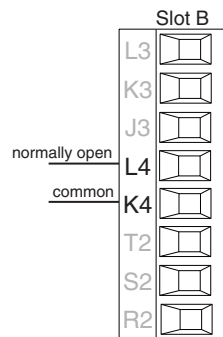

- 5 A at 240V_{AC} (ac) or 30V_{DC} (dc) maximum resistive load
- 20 mV at 24V minimum load
- 125 VA pilot duty at 120/240V_{AC} (ac), 25 VA at 24V_{AC} (ac)
- 100,000 cycles at rated load
- Output does not supply power.
- for use with ac or dc

See Quencharc note.
PM6 _ _ _ _ _ J A _ _

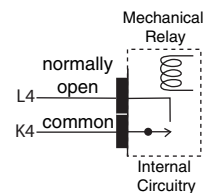



Warning:

Use National Electric (NEC) or other country-specific standard wiring and safety practices when wiring and connecting this controller to a power source and to electrical sensors or peripheral devices. Failure to do so may result in damage to equipment and property, and/or injury or loss of life.

Note:

Maximum wire size termination and torque rating:

- 0.0507 to 3.30 mm² (30 to 12 AWG) single-wire termination or two 1.31 mm² (16 AWG)
- 0.8 Nm (7.0 lb.-in.) torque

Note:

Adjacent terminals may be labeled differently, depending on the model number.

Note:

To prevent damage to the controller, do not connect wires to unused terminals.

Note:

Maintain electrical isolation between analog input 1, digital input-outputs, switched dc/open collector outputs and process outputs to prevent ground loops.

Note:

The control output common terminal and the digital common terminal are referenced to different voltages and must remain isolated.

Quencharc Note:

Switching pilot duty inductive loads (relay coils, solenoids, etc.) with the mechanical relay, solid state relay or open collector output options requires use of an R.C. suppressor.

Output 4 Solid-state Relay, Form A

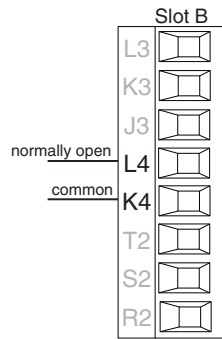

- 0.5 A at 20 to 264V~ (ac) maximum resistive load
- 20 VA 120/240V~ (ac) pilot duty
- opto-isolated, without contact suppression
- maximum off state leakage of 105 microamperes
- Output does not supply power.
- Do not use on dc loads.

See Quencharc note.

PM6 - - - - - K A - - -

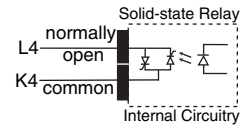



Warning:
Use National Electric (NEC) or other country-specific standard wiring and safety practices when wiring and connecting this controller to a power source and to electrical sensors or peripheral devices. Failure to do so may result in damage to equipment and property, and/or injury or loss of life.

Note:
Maximum wire size termination and torque rating:
• 0.0507 to 3.30 mm² (30 to 12 AWG) single-wire termination or two 1.31 mm² (16 AWG)
• 0.8 Nm (7.0 lb.-in.) torque

Note:
Adjacent terminals may be labeled differently, depending on the model number.

Note:
To prevent damage to the controller, do not connect wires to unused terminals.

Note:
Maintain electrical isolation between analog input 1, digital input-outputs, switched dc/open collector outputs and process outputs to prevent ground loops.

Note:
The control output common terminal and the digital common terminal are referenced to different voltages and must remain isolated.

Note:
Avoid continuous writes within loops. Excessive writes to EEPROM will cause premature EEPROM failure. The EEPROM is rated for 1,000,000 writes.

Standard Bus EIA-485 Communications

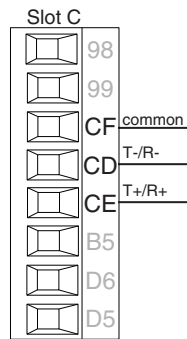

- Wire T-/R- to the A terminal of the EIA-485 port.
- Wire T+/R+ to the B terminal of the EIA-485 port.
- Wire common to the common terminal of the EIA-485 port.
- Do not route network wires with power wires. Connect network wires in daisy-chain fashion when connecting multiple devices in a network.
- Do not connect more than 16 EZ-ZONE[®] PM controllers on a network.
- maximum network length: 1,200 meters (4,000 feet)
- 1/8th unit load on EIA-485 bus
PM6 _ _ _ _-(A, 2 or 3) _ _ _ A _ _

Modbus RTU or Standard Bus EIA-485 Communications

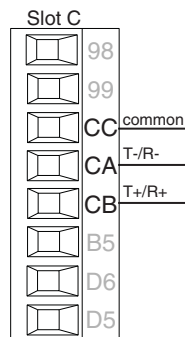

- Wire T-/R- to the A terminal of the EIA-485 port.
- Wire T+/R+ to the B terminal of the EIA-485 port.
- Wire common to the common terminal of the EIA-485 port.
- Do not route network wires with power wires. Connect network wires in daisy-chain fashion when connecting multiple devices in a network.
- A termination resistor may be required. Place a 120 Ω resistor across T+/R+ and T-/R- of last controller on network.
- Only one protocol per port is available at a time: either Modbus RTU or Standard Bus.
- Do not connect more than 16 EZ-ZONE[®] controllers on a Standard Bus network.
- Maximum number of EZ-ZONE[®] controllers on a Modbus network is 247.
- maximum network length: 1,200 meters (4,000 feet)
- 1/8th unit load on EIA-485 bus.
PM6 _ _ _ _-1 _ _ _ A _ _

EIA-232/485 Modbus RTU Communications

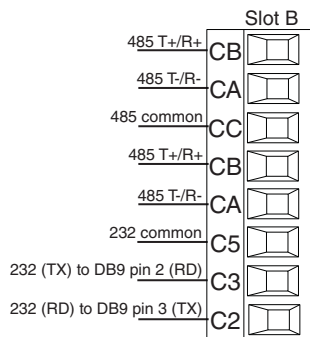

- Wire T-/R- to the A terminal of the EIA-485 port.
- Wire T+/R+ to the B terminal of the EIA-485 port.
- Wire common to the common terminal of the EIA-485 port.
- Do not route network wires with power wires. Connect network wires in daisy-chain fashion when connecting multiple devices in a network.
- A termination resistor may be required. Place a 120 Ω resistor across T+/R+ and T-/R- of last controller on network.
- Do not wire to both the EIA-485 and the EIA-232 pins at the same time.
- Two EIA-485 terminals of T/R are provided to assist in daisy-chain wiring.
- Do not connect more than one EZ-ZONE[®] PM controller on an EIA-232 network.
- Do not connect more than 16 EZ-ZONE[®] controllers on a Standard Bus EIA-485 network.
- Maximum number of EZ-ZONE[®] controllers on a Modbus network is 247.
- maximum EIA-232 network length: 15 meters (50 feet)
- maximum EIA-485 network length: 1,200 meters (4,000 feet)
- 1/8th unit load on EIA-485 bus.
PM6 _ _ _ _-2 AAA A _ _

Modbus-IDA Terminal	EIA/TIA-485 Name	Watlow Terminal Label	Function
DO	A	CA or CD	T-/R-
D1	B	CB or CE	T+/R+
common	common	CC or CF	common



Warning:
Use National Electric (NEC) or other country-specific standard wiring and safety practices when wiring and connecting this controller to a power source and to electrical sensors or peripheral devices. Failure to do so may result in damage to equipment and property, and/or injury or loss of life.

Note:
Maximum wire size termination and torque rating:
• 0.0507 to 3.30 mm² (30 to 12 AWG) single-wire termination or two 1.31 mm² (16 AWG)
• 0.8 Nm (7.0 lb.-in.) torque

Note:
Adjacent terminals may be labeled differently, depending on the model number.

Note:
To prevent damage to the controller, do not connect wires to unused terminals.

Note:
Maintain electrical isolation between analog input 1, digital input-outputs, switched dc/open collector outputs and process outputs to prevent ground loops.

Note:
The control output common terminal and the digital common terminal are referenced to different voltages and must remain isolated.

Note:
Avoid continuous writes within loops. Excessive writes to EEPROM will cause premature EEPROM failure. The EEPROM is rated for 1,000,000 writes.

EtherNet/IP™ and Modbus TCP Communications

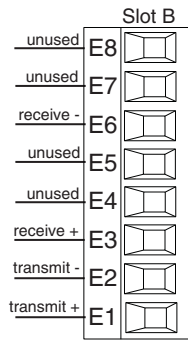

RJ-45 pin	T568B wire color	Signal	Slot B
8	brown	unused	E8
7	brown & white	unused	E7
6	green	receive -	E6
5	white & blue	unused	E5
4	blue	unused	E4
3	white & green	receive +	E3
2	orange	transmit -	E2
1	white & orange	transmit +	E1

EtherNet/IP™ and Modbus TCP communications to connect with a 10/100 switch.

- Do not route network wires with power wires.
- Connect one Ethernet cable per controller to a 10/100 mbps ethernet switch. Both Modbus TCP and EtherNet/IP™ are available on the network.
- A RUI may be connected at the same time using Slot C.

DeviceNet™ Communications

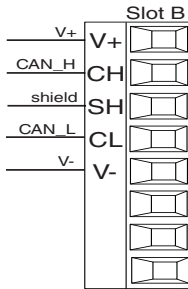

Terminal	Signal	Function
V+	V+	DeviceNet™ power
CH	CAN_H	positive side of DeviceNet™ bus
SH	shield	shield interconnect
CL	CAN_L	negative side of DeviceNet™ bus
V-	V-	DeviceNet™ power return

Wiring a Serial EIA-485 Network

Do not route network wires with power wires. Connect network wires in daisy-chain fashion when connecting multiple devices in a network.

A termination resistor may be re-

quired. Place a 120 Ω resistor across T+/R+ and T-/R- of the last controller on a network.

Only one protocol per port is available at a time: either Modbus RTU or Standard Bus.

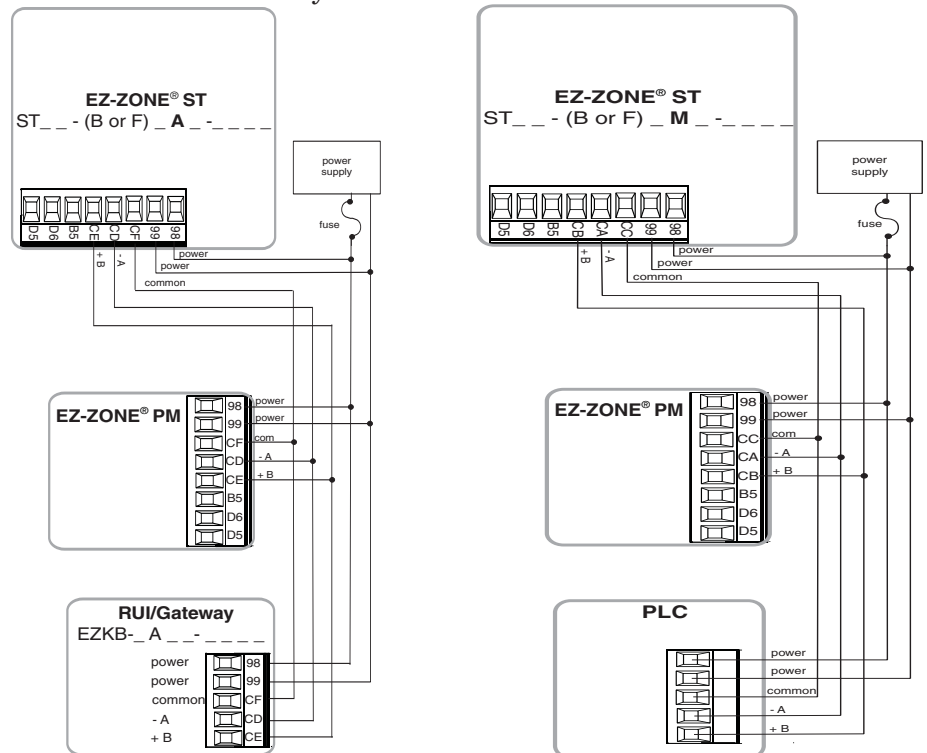

A network using Watlow's Standard Bus and an RUI/Gateway.

A network using Modbus RTU.

3

Chapter 3: Keys and Displays

Upper Display:

In the Home Page, displays the process value, otherwise displays the value of the parameter in the lower display.

Zone Display:

Indicates the controller zone that the remote user interface (RUI) is currently communicating with.

1 to 9 = zones 1 to 9

A = zone 10

E = zone 14

b = zone 11

F = zone 15

c = zone 12

H = zone 16

d = zone 13

Lower Display:

Indicates the set point or output power value during operation, or the parameter whose value appears in the upper display.

EZ Key:

This key can be programmed to do various tasks, such as starting a profile.



Temperature Units Indicator Lights:

Indicates whether the temperature is displayed in Fahrenheit or Celsius.

Output Activity:

Number lights indicate activity of outputs 1 through 5. A flashing light indicates retransmit activity.

Percent Units Indicator

Lights when the controller is displaying values as a percentage or when the open-loop set point is displayed.

Profile Activity;

Lights when a profile is running. Flashes when a profile is paused.

Communications Activity

Flashes when another device is communicating with this controller.

Up and Down Keys ▲ ▼

In the Home Page, adjusts the set point in the lower display. In other pages, changes the upper display to a higher or lower value, or changes a parameter selection.

Infinity Key ∞

Press to back up one level, or press and hold for two seconds to return to the Home Page.

Advance Key ⌂

Advances through parameter prompts.

Responding to a Displayed Message

Attention Codes

An active message will cause the display to toggle between the normal settings and the active message in the upper display and **ALERR** in the lower display.

Your response will depend on the message and the controller settings. Some messages, such as Ramping and Tuning, indicate that a process is underway. If the message was generated by a latched alarm or limit condition, the message can be cleared when the condition no longer exists. If an alarm has silencing enabled, it can be silenced.

Push the Advance Key to display **ALERR** in the upper display and the message source (such as **LAL1**) in the lower display.

Use the Up ▲ and Down ▼ keys to scroll through possible responses, such as Clear **CLR** or Silence

SIL. Then push the Advance ⌂ or Infinity ∞ key to execute the action.

ALL1 ALL2 ALL3 ALL4 Alarm Low 1 to 4

ALH1 ALH2 ALH3 ALH4 Alarm High 1 to 4

ALE1 ALE2 ALE3 ALE4 Alarm Error 1 to 4

ERI1 ERI2 Error Input 1 or 2

LIL1 LIL2 Limit Low 1 or 2

LHL1 LHL2 Limit High 1 or 2

LEI1 LEI2 Limit Error 1 or 2

TUN1 Tuning

RPI Ramping

LPO1 Loop Open Error

LPR1 Loop Reversed Error

CEr Current Error

HEr Heater Error

Navigating the EZ-ZONE[®] PM Integrated Controller

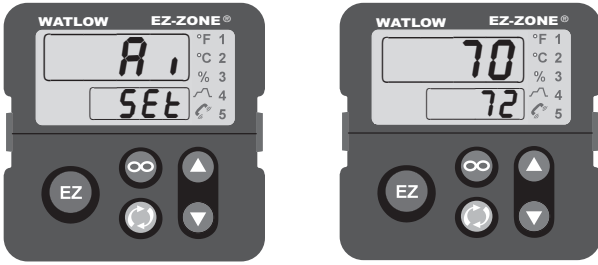



Home Page from anywhere: Press the Infinity Key  for two seconds to return to the Home Page.



Operations Page from Home Page: Press both the Up  and Down  keys for three seconds.



Setup Page from Home Page: Press both the Up  and Down  keys for six seconds.



Profiling Page from Home Page: Press the Advance Key  for three seconds.



Factory Page from Home Page: Press both the Advance  and Infinity  keys for six seconds.

4

Chapter 4: Home Page

Default Home Page Parameters

The Home Page is a customized list of as many as 20 parameters that can be configured and changed in the Custom Menu **[CUSE]** (Factory Page). The default list of nine parameters below includes the Active Process Value (value in upper display) and Active Set Point (value in lower display). The Attention **[ATTN]** parameter appears only if there is an active message. An active message could be a reported error, for example, **[CER I]** (Current Error), or it could be for information only, for example, **[EUN I]** (Autotuning).

Use the Advance Key **[⊕]** to step through the other parameters. The parameter prompt will appear in the lower display, and the parameter value will appear in the upper display. You can use the Up **[▲]** and Down **[▼]** keys to change the value of read-write parameters, just as you would in any other menu.

If Control Mode is set to Auto, the process value is in the upper display and the Closed Loop Set Point (read-write) is in the lower display.

If a profile is running, the process value is in the upper display and the Target Set Point (read only) is in the lower display.

If Control Mode is set to Manual, the process value is in the upper display and the output power level (read-write) is in the lower display.

If Control Mode is set to Off, the process value is in the upper display and **[OFF]** (read only) is in the lower display.

If a sensor failure has occurred, **[----]** is in the upper display and the output power level (read-write) is in the lower display.

Changing the Set Point





You can change the set point by using the Up **[▲]** and Down **[▼]** keys, when a profile is not running.

If the set point is displayed and the % indicator is lit, the controller is in open-loop (manual) mode.

Note: Avoid continuous writes within loops. Excessive writes to EEPROM will cause premature EEPROM failure. The EEPROM is rated for 1,000,000 writes.

Custom Menu Number	Home Page Display (defaults)	Parameter Name	Settings	Custom Menu Display (defaults)	Parameter Page and Menu
1 Upper Display	(value only)	Active Process Value		[RcPu]	Operations Page, Analog Input Menu
2 Lower Display	(value only)	Active Set Point		[RcSP]	Operations Page, Profile Status Menu
3	[CPI]	Control Mode		[CPI]	Operations Page, Loop Menu
4	[hPr I]	Heat Power		[hPr]	Operations Page, Monitor Menu
5	[CP r I]	Cool Power		[CP r]	Operations Page, Monitor Menu
6	[AUT I]	Autotune		[AUT]	Operations Page, Loop Menu
7	[idS I]	Idle Set Point		[idLE]	Operations Page, Loop Menu
8	[PSt I]	Profile Start		[PSt r]	Home Page only (See Profile Page Chapter.)
9	[PRC I]	Profile Action Request		[PRC r]	Home Page only (See Profile Page Chapter.)
10 to 20	(skipped)	None		[nonE]	(Add parameters to the Home Page in the Custom Menu, Factory Page.)

Default Home Page

Display	Parameter Name Description	Setting	Range	Default	Appears If
ALLEN	<p>Attention</p> <p>An active message will cause the display to toggle between the normal settings and the active message in the upper display and ALLEN in the lower display.</p> <p>Your response will depend on the message and the controller settings. Some messages, such as Ramping and Tuning, indicate that a process is underway. If the message was generated by a latched alarm or limit condition, the message can be cleared when the condition no longer exists. If an alarm has silencing enabled, it can be silenced.</p> <p>Push the Advance Key to display ALLEN in the upper display and the message source (such as ALH1) in the lower display.</p> <p>Use the Up  and Down  keys to scroll through possible responses, such as Clear CLR or Silence SIL. Then push the Advance  or Infinity  key to execute the action.</p>		ALL1 ALL2 ALL3 ALL4 Alarm Low 1 to 4 ALH1 ALH2 ALH3 ALH4 Alarm High 1 to 4 ALE1 ALE2 ALE3 ALE4 Alarm Error 1 to 4 Er.1 Er.2 Error Input 1 or 2 L.L1 L.L2 Limit Low 1 or 2 L.H1 L.H2 Limit High 1 or 2 L.E1 L.E2 Limit Error 1 or 2 TUN1 Tuning rPI Ramping LPo1 Loop Open Error LP.r1 Loop Reversed Error CEr Current Error hEr Heater Error		an alarm or error message is active.
PSE1	<p>Profile Start</p> <p>Select a profile or step number that will be affected by Profile Action.</p>		0 to 40	0	the controller includes profiling (PM6 R __ _-_____).
PAC1	<p>Profile Action Request</p> <p>Select the action to apply to the profile (1 to 4) or step selected in Profile Start.</p>		nonE No Action ProF Start a Profile STEP Start a Step PAUS Pause rESU Resume End End	None	the controller includes profiling (PM6 R __ _-_____).

Parameters that appear only in the Home Page

Display	Parameter name Description	Set- tings	Range	Default	Appears If
<div style="display: flex; justify-content: space-between;"> <input type="checkbox"/> A, <input type="checkbox"/> oPEr <input type="checkbox"/> 1, <input type="checkbox"/> A, <input type="checkbox"/> 2, <input type="checkbox"/> A, </div> Analog Input Menu Analog Input 1 or Analog Input 2 (input 2 appears if PM6 _ _ _ _ _ [R, T or L] _ _ A _ _)					
<input type="checkbox"/> A , <input type="checkbox"/> i.Ain	<i>Analog Input (1 or 2)</i> Process Value View the process value.		-1,999.000 to 9,999.000°F or units -1,128.000 to 5,537.000°C		always
<input type="checkbox"/> i.Er <input type="checkbox"/> i.Er	<i>Analog Input (1 or 2)</i> Error Status View the cause of the most recent error. If the AErr message is Er.i.1 or Er.i.2 , this parameter will display the cause of the input error.		<input type="checkbox"/> nonE None <input type="checkbox"/> oPEr Open <input type="checkbox"/> Shrt Shorted <input type="checkbox"/> Err Measurement Error <input type="checkbox"/> ErrAL Bad Calibration Data <input type="checkbox"/> ErrAb Ambient Error <input type="checkbox"/> Errtd RTD Lead Resistance Error	None	always
<input type="checkbox"/> i.CA <input type="checkbox"/> i.CA	<i>Analog Input (1 or 2)</i> Calibration Offset Offset the input reading to compensate for lead wire resistance or other factors that cause the input reading to vary from the actual process value.		-1,999.000 to 9,999.000°F or units -1,110.555 to 5,555.000°C	0.0	always
<div style="display: flex; justify-content: space-between;"> <input type="checkbox"/> d.o, <input type="checkbox"/> oPEr <input type="checkbox"/> 5, <input type="checkbox"/> d.o <input type="checkbox"/> 6, <input type="checkbox"/> d.o </div> Digital Input/ Output Menu Digital Input or Digital Input or Output 5 Output 6 (menu appears if PM6 _ [2 or 4] _ _ _ _ _ A _ _)					
<input type="checkbox"/> d.o.5 <input type="checkbox"/> d.o.S	<i>Digital Output (5 or 6)</i> Output State View the state of this output.		<input type="checkbox"/> on On <input type="checkbox"/> oFF Off		always
<input type="checkbox"/> E.i.5 <input type="checkbox"/> Ei.S	<i>Digital Input (5 or 6)</i> Event Input Status View this event input state.		<input type="checkbox"/> ACT Inactive <input type="checkbox"/> ACT Active		always
<div style="display: flex; justify-content: space-between;"> <input type="checkbox"/> L, <input type="checkbox"/> Err </div> Limit Menu (menu appears if PM6 _ _ _ _ _ L _ _ AAA)					
<input type="checkbox"/> LLS <input type="checkbox"/> LL.S	<i>Limit</i> Low Set Point Set the low process value that will trigger the limit.		-1,999.000 to 9,999.000°F or units -1,128.000 to 5,537.000°C	0.0°F or units -18.0°C	Limit Sides (Set- up Page) is not set to High.
<input type="checkbox"/> Lh.S <input type="checkbox"/> Lh.S	<i>Limit</i> High Set Point Set the high process value that will trigger the limit.		-1,999.000 to 9,999.000°F or units -1,128.000 to 5,537.000°C	0.0°F or units -18.0°C	Limit Sides (Set- up Page) is not set to Low.
<div style="display: flex; justify-content: space-between;"> <input type="checkbox"/> Mon, <input type="checkbox"/> oPEr </div> Monitor Menu					
<input type="checkbox"/> C.MA <input type="checkbox"/> C.MA	<i>Monitor</i> Control Mode Active View the current control mode.		<input type="checkbox"/> oFF Off <input type="checkbox"/> Auto Auto <input type="checkbox"/> Man Manual		always
<input type="checkbox"/> h.Pr <input type="checkbox"/> h.Pr	<i>Monitor</i> Heat Power View the current heat output level.		0.0 to 100.0%	0.0	always
<input type="checkbox"/> C.Pr <input type="checkbox"/> C.Pr	<i>Monitor</i> Cool Power View the current cool output level.		-100.0 to 0.0%	0.0	always
<input type="checkbox"/> C.SP <input type="checkbox"/> C.SP	<i>Monitor</i> Closed Loop Working Set Point View the set point currently in effect.		-1,999.000 to 9,999.000°F or units -1,128.000 to 5,537.000°C	75°F or units 24°C	always
<input type="checkbox"/> Pv.A <input type="checkbox"/> Pv.A	<i>Monitor</i> Process Value Active View the current filtered process value using the control input.		-1,999.000 to 9,999.000°F or units -1,128.000 to 5,537.000°C		always
Note: Some values will be rounded off to fit in the four-character display. Full values can be read with other interfaces. If there is only one instance of a menu, no submenus will appear.					

Display	Parameter name Description	Set- tings	Range	Default	Appears If
Loop Menu Loop Menu					
REn [r;En]	Loop Remote Enable Switch control to the remote set point.		<input type="checkbox"/> No <input checked="" type="checkbox"/> Yes	No	PM6 _ _ _ _ (R) _ _ A A A
REy [r.ty]	Loop Remote Set Point Type Select how the remote set point will be determined.		<input checked="" type="checkbox"/> Auto (closed loop) <input type="checkbox"/> Manual (open loop)	Auto	Remote Enable is set to Yes.
CPn [C.M]	Loop Control Mode Select the method that the controller will use to control.		<input type="checkbox"/> Off <input checked="" type="checkbox"/> Auto (closed loop) <input type="checkbox"/> Manual (open loop)	Auto	always
RESp [A.tSP]	Loop Autotune Set Point Set the set point that the autotune will use, as a percentage of the current set point.		50.0 to 200.0%	90.0	Heat Algorithm or Cool Algorithm (Setup Page) is set to PID.
REt [AUt]	Loop Autotune Request Start an autotune. While autotune is active, the Home Page will display REt n tUn t . When the autotune is complete, the message will clear automatically.		<input type="checkbox"/> No <input checked="" type="checkbox"/> Yes	No	Heat Algorithm or Cool Algorithm (Setup Page) is set to PID.
CSp [C.SP]	Loop Closed Loop Set Point Set the set point that the controller will automatically control to.		Low Set Point to High Set Point (Setup Page)	75.0°F or units 24.0°C	always
idS [id.S]	Loop Idle Set Point Set a closed loop set point that can be triggered by an event state.		Low Set Point to High Set Point (Setup Page)	75.0°F or units 24.0°C	always
hPb [h.Pb]	Loop Heat Proportional Band Set the PID proportional band for the heat outputs.		0.001 to 9,999.000°F or units -1,110.555 to 5,555.000°C	25.0°F or units 14.0°C	Heat Algorithm (Setup Page) is set to PID.
hHy [h.hy]	Loop Heat Hysteresis Set the control switching hysteresis for on-off control. This determines how far into the "on" region the process value needs to move before the output turns on.		0.001 to 9,999.000°F or units -1,110.555 to 5,555.000°C	3.0°F or units 2.0°C	Heat Algorithm (Setup Page) is set to On-Off.
CPb [C.Pb]	Loop Cool Proportional Band Set the PID proportional band for the cool outputs.		0.001 to 9,999.000°F or units -1,110.555 to 5,555.000°C	25.0°F or units 14.0°C	Cool Algorithm (Setup Page) is set to PID.
CHy [C.hy]	Loop Cool Hysteresis Set the control switching hysteresis for on-off control. This determines how far into the "on" region the process value needs to move before the output turns on.		0.001 to 9,999.000°F or units -1,110.555 to 5,555.000°C	3.0°F or units 2.0°C	Cool Algorithm (Setup Page) is set to On-Off.
tI [ti]	Loop Time Integral Set the PID integral for the outputs.		0 to 9,999 seconds per repeat	180.0 seconds per repeat	Heat Algorithm or Cool Algorithm (Setup Page) is set to PID.
tD [td]	Loop Time Derivative Set the PID derivative time for the outputs.		0 to 9,999 seconds	0.0 seconds	Heat Algorithm or Cool Algorithm (Setup Page) is set to PID.

Note: Some values will be rounded off to fit in the four-character display. Full values can be read with other interfaces.

If there is only one instance of a menu, no submenus will appear.

Display	Parameter name Description	Set- tings	Range	Default	Appears If
<input type="checkbox"/> db [db]	<i>Loop</i> Dead Band Set the offset to the proportional band. With a negative value, both heating and cooling outputs are active when the process value is near the set point. A positive value keeps heating and cooling outputs from fighting each other.		-1,000.0 to 1,000.0°F or units -556 to 556°C	0.0	Heat Algorithm and Cool Algorithm (Setup Page) are set to PID or On-Off.
<input type="checkbox"/> oSP [o.SP]	<i>Loop</i> Open Loop Set Point Set a fixed level of output power when in manual (open-loop) mode.		-100 to 100% (heat and cool) 0 to 100% (heat only) -100 to 0% (cool only)	0.0	always
<input type="checkbox"/> ALP1 <input type="checkbox"/> oPEr Alarm Menu	<input type="checkbox"/> 1 Alarm 1	<input type="checkbox"/> 2 Alarm 2	<input type="checkbox"/> 3 Alarm 3	<input type="checkbox"/> 4 Alarm 4	
<input type="checkbox"/> ALo [A.Lo]	<i>Alarm (1 to 4)</i> Low Set Point If Alarm Type (Setup Page, Alarm Menu) is set to: process - set the process value that will trigger a low alarm. deviation - set the span of units from the closed loop set point that will trigger a low alarm.		-1,999.000 to 9,999.000°F or units -1,128.000 to 5,537.000°C	32.0°F or units 0.0°C	Alarm Sides (Setup Page) is not set to High.
<input type="checkbox"/> Ah [A.hi]	<i>Alarm (1 to 4)</i> High Set Point If Alarm Type (Setup Page, Alarm Menu) is set to: process - set the process value that will trigger a high alarm. deviation - set the span of units from the closed loop set point that will trigger a high alarm.		-1,999.000 to 9,999.000°F or units -1,128.000 to 5,537.000°C	300.0°F or units 150.0°C	Alarm Sides (Setup Page) is not set to Low.
<input type="checkbox"/> CUrr <input type="checkbox"/> oPEr Current Menu	(menu appears if PM6 _ _ _ _ T _ _ A _ _)	Note: To use the current sensing feature, Time Base (Setup Page, Output Menu) must be set to 0.7 seconds or more.			
<input type="checkbox"/> Ch [C.hi]	<i>Current</i> High Set Point Set the current value that will trigger a high heater error state.		-1,999.000 to 9,999.000	50.0	Current Sides (Setup Page) is set to High or Both.
<input type="checkbox"/> CLo [C.Lo]	<i>Current</i> Low Set Point Set the current value that will trigger a low heater error state.		-1,999.000 to 9,999.000	0.0	Current Sides (Setup Page) is set to Low or Both.
<input type="checkbox"/> CUr [CU.r]	<i>Current</i> Read View the most recent current value monitored by the current transformer.		-1,999.000 to 9,999.000	0	always
<input type="checkbox"/> CEr [C.Er]	<i>Current</i> Error View the cause of the most recent load fault.		<input type="checkbox"/> nonE None <input type="checkbox"/> Shrt Shorted <input type="checkbox"/> oPEn Open	None	always
<input type="checkbox"/> hEr [h.Er]	<i>Current</i> Heater Error View the cause of the most recent load fault monitored by the current transformer.		<input type="checkbox"/> nonE None <input type="checkbox"/> h,9h High <input type="checkbox"/> LoLw Low	None	always
<input type="checkbox"/> PStA <input type="checkbox"/> oPEr Profile Status Menu	(menu appears if PM6 R _ _ _ _ A _ _)	* Some parameters in the Profile Status Menu can be changed for the currently running profile, but should only be changed by knowledgeable personnel and with caution. Changing parameters via the Profile Status Menu will not change the stored profile but will have an immediate impact on the profile that is running. Changes made to profile parameters in the Profiling Pages will be saved and will also have an immediate impact on the running profile.			
Note: Some values will be rounded off to fit in the four-character display. Full values can be read with other interfaces.					
If there is only one instance of a menu, no submenus will appear.					

Display	Parameter name Description	Set- tings	Range	Default	Appears If
<input type="checkbox"/> PS_{Tr} [P.Str]	<i>Profile Status</i> Profile Start Select a step or profile to load.		1 to 40	0 (none)	always
<input type="checkbox"/> PA_{Cr} [P.AC]	<i>Profile Status</i> Profile Action Request Select what action to apply to the currently loaded profile.		<input type="checkbox"/> nonE None <input type="checkbox"/> ProF Profile Start <input type="checkbox"/> PRUS Pause <input type="checkbox"/> rESU Resume <input type="checkbox"/> End End <input type="checkbox"/> SEEP Step Start	None	always
<input type="checkbox"/> SE_P [StP]	<i>Profile Status</i> Active Step View the currently running step.		0 to 40	0 (none)	always
<input type="checkbox"/> SE_{YP} [S.typ]	<i>Profile Status</i> Active Step Type View the currently running step type.		<input type="checkbox"/> USEP Unused Step <input type="checkbox"/> ti Time <input type="checkbox"/> RAE Rate <input type="checkbox"/> SoRH Soak <input type="checkbox"/> WdE Wait For Event <input type="checkbox"/> WdPr Wait For Process <input type="checkbox"/> WdBo Wait For Both <input type="checkbox"/> JL Jump Loop <input type="checkbox"/> End End	Unused Step	a profile is active.
<input type="checkbox"/> ET_{SP} [tg.SP]	<i>Profile Status</i> *Active Target Set Point View or change the target set point of the current step.		-1,999.000 to 9,999.000°F or units -1,128.000 to 5,537.000°C	0.0°F or units -18.0°C	a profile is active.
<input type="checkbox"/> AC_{SP} [AC.SP]	<i>Profile Status</i> Active Set Point Display the current set point, even if the profile is ramping.		-1,999.000 to 9,999.000°F or units -1,128.000 to 5,537.000°C	0.0°F or units -18.0°C	always
<input type="checkbox"/> SE_t [S.ti]	<i>Profile Status</i> *Step Time Remaining View or change the time remaining for the current step. Step is displayed in seconds. If the time exceeds 9,999 seconds, the display will show 9,999 and remain there while the control continues to decrement internally. Once the remaining time is equal to or less than 9,999 the display will represent the actual seconds remaining. As an example, if a three-hour soak time is currently being monitored, the first value displayed will be 9,999, and the display will remain at 9,999 until the remaining time is approximately equal to 2 hours and 46 minutes. At this point the display will track the actual seconds remaining.		0 to 9,999.000 seconds	0.0	always
<input type="checkbox"/> Ent₁ [Ent1] <input type="checkbox"/> Ent₂ [Ent2]	<i>Profile Status</i> *Active Event Output (1 or 2) View or change the event output states.		<input type="checkbox"/> oFF Off <input type="checkbox"/> on On	Off	always
<input type="checkbox"/> JC [JC]	<i>Profile Status</i> Jump Count Remaining View the jump counts remaining for the current loop. In a profile with nested loops, this may not indicate the actual jump counts remaining.		0 to 9,999	0	always
Note: Some values will be rounded off to fit in the four-character display. Full values can be read with other interfaces.					
If there is only one instance of a menu, no submenus will appear.					

6

Chapter 6: Setup Page

Home Page Setup Page

Hold both keys for 6 seconds.

Analog Input Menu

Input 1 Submenu

Sensor Type	Linearization	RTD Leads	Scale Low	Scale High	Range Low	Range High	Process Error Enable	Process Error Low	Filter Time	Input Error Latching	Decimal	Sensor Backup Enable
-------------	---------------	-----------	-----------	------------	-----------	------------	----------------------	-------------------	-------------	----------------------	---------	----------------------

Input 2 Submenu Same as above without sensor backup enable.

Digital Input/Output Menu

In/Out 5 Submenu

Direction	Output Function	Output Control	Output Time Base	Output Low Power Scale	Output High Power Scale	Output Function Instance	Digital Input Level	Digital Input Function	Digital Input Function Instance
-----------	-----------------	----------------	------------------	------------------------	-------------------------	--------------------------	---------------------	------------------------	---------------------------------

In/Out 6 Submenu Same as above.

Limit Menu

Limit Sides	Limit Hysteresis	Limit Integrate	Set Point Limit High	Set Point Limit Low
-------------	------------------	-----------------	----------------------	---------------------

Loop Menu

Heat Algorithm	Cool Algorithm	Cool Output Curve	TRU-TUNE+™ Enable	TRU-TUNE+™ Band	TRU-TUNE+™ Gain	Autotune Aggressiveness	User Failure Action	Input Failure Failure	Manual Power	Open Loop Detect Enable	Open Loop Detect Time	Open Loop Detect Deviation	Ramp Action
----------------	----------------	-------------------	-------------------	-----------------	-----------------	-------------------------	---------------------	-----------------------	--------------	-------------------------	-----------------------	----------------------------	-------------

Output Menu

Output 1 Submenu

Output Type	Output Function	Retransmit Source	Output Function Instance	Scale Low	Scale High	Range Low	Range High	Output Low Power Scale	Output High Power Scale	Calibration Offset	Output Function
-------------	-----------------	-------------------	--------------------------	-----------	------------	-----------	------------	------------------------	-------------------------	--------------------	-----------------

Output 2 Submenu

Output Function	Output Function Instance	Output Control	Output Time Base	Output Low Power Scale	Output High Power Scale
-----------------	--------------------------	----------------	------------------	------------------------	-------------------------

Output 3 Submenu Same as Output 1.

Output 4 Submenu Same as Output 2.

Alarm Menu

Alarm 1 Submenu

Alarm Type	Alarm Source	Alarm Instance	Alarm Hysteresis	Alarm Logic	Alarm Sides	Alarm Latching	Alarm Blocking	Alarm Silencing	Alarm Display	Alarm Delay
------------	--------------	----------------	------------------	-------------	-------------	----------------	----------------	-----------------	---------------	-------------

Alarm 2 to 4 Submenus Same as above.

Current Menu

Current Sides	Current Reading Enable	Current Detect Threshold	Current Scaling	Current Offset	Current Source Output Instance
---------------	------------------------	--------------------------	-----------------	----------------	--------------------------------

Function Key Menu

Digital Input Level	Digital Input Function	Function Instance
---------------------	------------------------	-------------------

Global Menu

Display Units	AC Line Frequency	Profile Type	Guaranteed Soak Enable	Guaranteed Soak Deviation
---------------	-------------------	--------------	------------------------	---------------------------

Communications Menu

Protocol	Address Standard Bus	Address Modbus	Baud Rate Modbus	Parity Modbus	Modbus Word Order	IP Address Mode	IP Fixed Address Part 1	IP Fixed Address Part 4	IP Fixed Subnet Part 1	IP Fixed Subnet Part 4	IP Fixed Gateway Part 1	IP Fixed Gateway Part 4	Modbus TCP Enable	Ethernet IP Enable
----------	----------------------	----------------	------------------	---------------	-------------------	-----------------	-------------------------	-------------------------	------------------------	------------------------	-------------------------	-------------------------	-------------------	--------------------

Navigating the Setup Page

Note:

Some of these menus and parameters may not appear, depending on the controller's options. See model number information in the Appendix for more information.

If there is only one instance of a menu, no submenus will appear.

To go to the Setup Page from the Home Page, press both the Up and Down keys for six seconds.

will appear in the upper display and will appear in the lower display.

- Press the Up or Down key to move through the menus.
- Press the Advance Key to move to a submenu.
- Press the Up or Down key to move through the submenus.
- Press the Advance Key to move through the parameters of the menu or submenu.

- Press the Infinity Key to move backwards through the levels: parameter to submenu; submenu to menu; menu to Home Page.
- Press and hold the Infinity Key for two seconds to return to the Home Page.

Note: Avoid continuous writes within loops. Excessive writes to EEPROM will cause premature EEPROM failure. The EEPROM is rated for 1,000,000 writes.

Display	Parameter Name Description	Settings	Range	Default	Appears If
 	 	 	Analog Input Menu Analog Input 1 or Analog Input 2 (input 2 appears if PM6 _ _ _ _ [R, T or L] _ _ A _ _)		
 [SEn]	<i>Input (1 or 2)</i> Sensor Type Set the analog sensor type to match the device wired to this input. Note: There is no open-sensor detection for process inputs.		Off Thermocouple Millivolts Volts dc Milliamps dc RTD 100 Ω RTD 1,000 Ω Potentiometer 1 kΩ	Thermocouple	always
 [Lin]	<i>Input (1 or 2)</i> Linearization Set the linearization to match the thermocouple wired to this input.		B K C N D R E S F T J	J	Sensor Type is set to Thermocouple.
 [rt.L]	<i>Input (1 or 2)</i> RTD Leads Set to match the number of leads on the RTD wired to this input.		2 3	2	Sensor Type is set to RTD 100 Ω or RTD 1,000 Ω.
 [S.Lo]	<i>Input (1 or 2)</i> Scale Low Set the low scale for process inputs. This value, in millivolts, volts or milliamps, will correspond to the Range Low displayed by the controller.		-100.0 to 1,000.0	0.0	Sensor Type is set to Millivolts, Volts, Milliamps or Potentiometer 1 kΩ.
 [S.hi]	<i>Input (1 or 2)</i> Scale High Set the high scale for process inputs. This value, in millivolts, volts or milliamps, will correspond to the Range High displayed by the controller.		-100.0 to 1,000.0	20.0	Sensor Type is set to Millivolts, Volts, Milliamps or Potentiometer 1 kΩ.
 [r.Lo]	<i>Input (1 or 2)</i> Range Low Set the low range for the displayed process input units.		-1,999.000 to 9,999.000	0.0	Sensor Type is set to Millivolts, Volts, Milliamps or Potentiometer 1 kΩ.
 [r.hi]	<i>Input (1 or 2)</i> Range High Set the high range for the displayed process input units.		-1,999.000 to 9,999.000	9,999	Sensor Type is set to Millivolts, Volts, Milliamps or Potentiometer 1 kΩ.
 [P.EE]	<i>Input (1 or 2)</i> Process Error Enable Turn the Process Error Low feature on or off.		Off Low	Off	Sensor Type is set to Millivolts, Volts, Milliamps or Potentiometer 1 kΩ.

Note: Some values will be rounded off to fit in the four-character display. Full values can be read with other interfaces.

If there is only one instance of a menu, no submenus will appear.

Display	Parameter Name Description	Settings	Range	Default	Appears If
<input type="checkbox"/> P.E.L. [P.EL]	<i>Input (1 or 2)</i> Process Error Low If the process value drops below this value, it will trigger an input error.		-100.0 to 1,000.0	0.0	Sensor Type is set to Millivolts, Volts, Milliamps or Potentiometer 1 kΩ, and Error Enable is set to Low.
<input type="checkbox"/> F.i.L. [FiL]	<i>Input (1 or 2)</i> Filter Time Filtering smooths out the process signal to both the display and the input. Increase the time to increase filtering.		0.0 to 60.0 seconds	0.5	always
<input type="checkbox"/> i.Er [i.Er]	<i>Input (1 or 2)</i> Error Latching Turn input error latching on or off. If latching is on errors must be manually cleared.		<input type="checkbox"/> OFF Off <input type="checkbox"/> ON On	Off	always
<input type="checkbox"/> d.EC [dEC]	<i>Input (1 or 2)</i> Decimal Set the precision of the displayed value.		<input type="checkbox"/> 0 Whole <input type="checkbox"/> 00 Tenths <input type="checkbox"/> 000 Hundredths <input type="checkbox"/> 0000 Thousandths	Whole	always
<input type="checkbox"/> S.b.A [S.bA]	<i>Input 1</i> Sensor Backup Enable If the input 1 sensor fails, the controller will use the input 2 sensor.		<input type="checkbox"/> OFF Off <input type="checkbox"/> ON On	Off	PM6 _ _ _ _ L _ A A A.
<input type="checkbox"/> d.i.o [S.EE]	<input type="checkbox"/> 5 [d.i.o]	<input type="checkbox"/> 6 [d.i.o]	Digital Input/ Output Menu Digital Input or Output 5 Digital Input or Output 6 (menu appears if PM6 _ [2 or 4] _ _ _ _ A _ _)		
<input type="checkbox"/> d.ir [dir]	<i>Digital Input / Output (5 or 6)</i> Direction Set the function to an input or output.		<input type="checkbox"/> O.P.P. Output <input type="checkbox"/> i.n Input Voltage <input type="checkbox"/> i.L.O.n Input Dry Contact	Output	always
<input type="checkbox"/> F.n [Fn]	<i>Digital Output (5 or 6)</i> Function Select what function will drive this output.		<input type="checkbox"/> OFF Off <input type="checkbox"/> COOL Cool <input type="checkbox"/> HEAT Heat <input type="checkbox"/> ALARM Alarm <input type="checkbox"/> EVENT Event	Off	Direction is set to Output.
<input type="checkbox"/> o.Ct [o.Ct]	<i>Digital Output (5 or 6)</i> Control Set the output control type. This parameter is only used with PID control, but can be set anytime.		<input type="checkbox"/> F.T.B. Fixed Time Base <input type="checkbox"/> V.T.B. Variable Time Base	Fixed Time Base	Direction is set to Output.
<input type="checkbox"/> o.tb [o.tb]	<i>Digital Output (5 or 6)</i> Time Base Set the time base for fixed-time-base control.		0.1 to 60.0 seconds (solid-state relay or switched dc) 5.0 to 60.0 seconds (mechanical relay or no-arc power control)	0.1 sec. [SSR & sw dc] 20.0 sec. [mech, relay, no-arc]	Control is set to Fixed Time Base.
<input type="checkbox"/> o.Lo [o.Lo]	<i>Digital Output (5 or 6)</i> Low Power Scale The power output will never be less than the value specified and will represent the value at which output scaling begins.		0.0 to 100.0%	0.0%	Direction is set to Output and Source is set to Heat or Cool.
<input type="checkbox"/> o.h.i [o.hi]	<i>Digital Output (5 or 6)</i> High Power Scale The power output will never be greater than the value specified and will represent the value at which output scaling stops.		0.0 to 100.0%	100.0%	Direction is set to Output and Source is set to Heat or Cool.
<input type="checkbox"/> F.i [Fi]	<i>Digital Output (5 or 6)</i> Function Instance Select which source instance will drive the output.		1 to 4	None	Direction is set to Output, and there is more than one instance of the Function selection.
Note: Some values will be rounded off to fit in the four-character display. Full values can be read with other interfaces.					
If there is only one instance of a menu, no submenus will appear.					

Display	Parameter Name Description	Settings	Range	Default	Appears If
LEu [LEu]	<i>Digital Input (5 or 6)</i> Level Select what action will be interpreted as a true state.		h,9h High LoLdJ Low	High	Direction is set to Input Voltage or Input Dry Contact.
Fn [Fn]	<i>Digital Input (5 or 6)</i> Function Select the function that will be triggered by a true state. Functions respond to a level state change or an edge level change.		nonE None ldLE Idle Set Point Enable (level) tUnE Tune (edge) ALrE Alarm Reset (edge) Sil Silence Alarms (edge) MAN Manual/Auto Mode (level) oFF Control Outputs Off (level) rEn Remote Set Point Enable (level) PLoL Lock Keypad (level) FAL Force Alarm (level) tDR TRU-TUNE+ [®] Disable (level) RoF Alarm Outputs & Control Loop Off (level) USrr Restore User Settings (edge) PdIS Profile Disable (level) PhoL Profile Hold/Resume (level) PrqF Profile Start Number (edge) PSEs Profile Start/Stop (level) LrEr Limit Reset (edge)	None	Direction is set to Input Voltage or Input Dry Contact, and the feature is available.
Fi [Fi]	<i>Digital Input (5 or 6)</i> Function Instance Select which instance of the Event Function will be triggered by a true state.		0 All Instances (except profiles) (For example, if Digital Function is set to Silence Alarms and Function Instance is set to 0, then this digital input will silence all alarms.) 1 to 4	1	Direction is set to Input Voltage or Input Dry Contact, and there is more than one instance of the Function selection.
LIPr SEE Limit Menu (menu appears if PM6 _ _ _ _ L _ _ AAA)					
Lsd [L.Sd]	<i>Limit</i> Sides Select which side or sides of the process value will be monitored.		both Both h,9h High LoLdJ Low	Both	always
Lhy [L.hy]	<i>Limit</i> Hysteresis Set the hysteresis for the limit function. This determines how far into the safe range the process value must move before the limit turns the output back on.		0.001 to 9,999.000°F or units 0.001 to 5,555.000°C	3.0°F or units 2.0°C	always
SPLh [SP.Lh]	<i>Limit</i> Set Point Limit High Clamp the operational limit high maximum setting to this value.		-1999.000 - 9999.000	9999.000	always
Note: Some values will be rounded off to fit in the four-character display. Full values can be read with other interfaces.					
If there is only one instance of a menu, no submenus will appear.					

Display	Parameter Name Description	Settings	Range	Default	Appears If
SP.LL [SP.LL]	<i>Limit</i> Set Point Limit Low Clamp the operational limit low maximum setting to this value.		-1999.000 - 9999.000	-1999.000	always
L.it [L.it]	<i>Limit</i> Integrate In a limit state the controller will turn off the outputs, terminate an active profile and freeze PID and TRU-TUNE+ [®] calculations.		no No YES Yes	No	always
Loop Menu					
h.AG [h.Ag]	<i>Loop</i> Heat Algorithm Set the heat control method.		oFF Off P.iD PID oN.oF On-Off	PID	always
C.AG [C.Ag]	<i>Loop</i> Cool Algorithm Set the cool control method.		oFF Off P.iD PID oN.oF On-Off	Off	always
C.Cr [C.Cr]	<i>Loop</i> Cool Output Curve Select a special cool output curve to change the responsiveness of the system.		oFF Off C.r.A Curve A C.r.B Curve B	Off	Cool Algorithm is set to Off.
t.tUn [t.tUn]	<i>Loop</i> TRU-TUNE+[®] Enable Enable or disable the TRU-TUNE+ [®] adaptive tuning feature.		no No YES Yes	No	Cool Algorithm or Heat Algorithm is set to PID.
t.bnd [t.bnd]	<i>Loop</i> TRU-TUNE+[®] Band Set the range, centered on the set point, within which TRU-TUNE+ [®] will be in effect. Use this function only if the controller is unable to adaptive tune automatically.		0 Auto 1 to 100	0	Cool Algorithm or Heat Algorithm is set to PID and TRU-TUNE+ [®] Enable is set to Yes.
t.gn [t.gn]	<i>Loop</i> TRU-TUNE+[®] Gain Select the responsiveness of the TRU-TUNE+ [®] adaptive tuning calculations. More responsiveness may increase overshoot.		1 to 6 Most to least responsive	3	Cool Algorithm or Heat Algorithm is set to PID and TRU-TUNE+ [®] Enable is set to Yes.
t.Agr [t.Agr]	<i>Loop</i> Autotune Aggressiveness Select the aggressiveness of the autotuning calculations.		Undr Under damped C.r.iE Critical damped oUeR Over damped	Critical	Cool Algorithm or Heat Algorithm is set to PID.
UFA [UFA]	<i>Loop</i> User Failure Action Select what the controller outputs will do when the user switches control to manual mode.		oFF Off, sets output power to 0% bPLS Bumpless, maintains same output power, if it was less than 75% and stable, otherwise 0% MAN Manual Fixed, sets output power to Manual Power setting USER User, sets output power to last open-loop set point the user entered	Off	always
Note: Some values will be rounded off to fit in the four-character display. Full values can be read with other interfaces.					
If there is only one instance of a menu, no submenus will appear.					

Display	Parameter Name Description	Settings	Range	Default	Appears If
FRiL [FAiL]	<i>Loop</i> Input Error Failure Select what the controller outputs will do when an input error switches control to manual mode.		OFF Off, sets output power to 0% bPLS Bumpless, maintains same output power, if it was less than 75% and stable, otherwise 0% MAN Manual Fixed, sets output power to Manual Power setting USER User, sets output power to last open-loop set point the user entered	Off	always
MAN [MAN]	<i>Loop</i> Manual Power Set the manual output power level that will take effect if an input error failure occurs.		Set Point Open Loop Limit Low to Set Point Open Loop Limit High (Setup Page)	0.0	Input Error Failure is set to Manual Fixed.
LdE [L.dE]	<i>Loop</i> Open Loop Detect Enable Turn on the open-loop detect feature to monitor a closed-loop operation for the appropriate response.		no No YES Yes	No	controller is equipped with a current transformer input (PM6 _ _ _ _ _ T _ _ _ _ _).
Ldt [L.dt]	<i>Loop</i> Open Loop Detect Time The Open Loop Detect Deviation value must occur for this time period to trigger an open-loop error.		0 to 3,600 seconds	240	Open Loop Detect Enable is set to Yes.
Ldd [L.dd]	<i>Loop</i> Open Loop Detect Deviation Set the value that the process must deviate from the set point to trigger an open-loop error.		-1,999.000 to 9,999.000°F or units -1,110.555 to 5,555.000°C	10.0°F or units 6.0°C	Open Loop Detect Enable is set to Yes.
rP [rP]	<i>Loop</i> Ramp Action Select when the controller's set point will ramp to the defined end set point.		OFF Off StR Startup SEPt Set Point Change both Both	Off	always
rSC [r.SC]	<i>Loop</i> Ramp Scale Select the scale of the ramp rate.		hour Hours min Minutes	Minutes	Ramp Action is set to Startup, Set Point or Both.
rRt [r.rt]	<i>Loop</i> Ramp Rate Set the rate for the set point ramp. Set the time units for the rate with the Ramp Scale parameter.		0.0 to 9,999.000°F or units 0.0 to 5,555.000°C	1.0°F or units 1.0°C	Ramp Action is set to Startup, Set Point or Both.
LSP [L.SP]	<i>Loop</i> Low Set Point Set the low end of the set point range.		-1,999.000 to 9,999.000°F or units -1,128.000 to 5,537.000°C	-1,999°F or units -1,128°C	always
hSP [h.SP]	<i>Loop</i> High Set Point Set the high end of the set point range.		-1,999.000 to 9,999.000°F or units -1,128.000 to 5,537.000°C	9,999°F or units 5,537°C	always
SPLo [SP.Lo]	<i>Loop</i> Set Point Low Limit Open Loop Set the minimum value of the open-loop set point range.		-100 to 100%	-100	always
SPhi [SP.hi]	<i>Loop</i> Set Point High Limit Open Loop Set the maximum value of the open-loop set point range.		-100 to 100%	100	always

Note: Some values will be rounded off to fit in the four-character display. Full values can be read with other interfaces.

If there is only one instance of a menu, no submenus will appear.

Display	Parameter Name Description	Settings	Range	Default	Appears If
oLPE SEt	Output Menu	1 2 3 4 oLPE oLPE oLPE oLPE			
oL4 [o.ty]	<i>Output (1 or 3)</i> Type Select whether the process output will operate in volts or milliamps.		VoLts Volts mA Milliamps	Volts	a process output (PM6 _ _F _ _ _ _ A _ _ or PM6 _ _ _ _ _ F _ A _ _)
Fn [Fn]	<i>Output (1 or 3)</i> Function Select what function will drive this output.		OFF Off HEAt Heat COOL Cool DUPL Duplex ALArM Alarm EnE Event reTrAn Retransmit	Heat (output 1) Off (output 2)	a process output (PM6 _ _F _ _ _ _ A _ _ or PM6 _ _ _ _ _ F _ A _ _)
rSr [r.Sr]	<i>Output (1 or 3)</i> Retransmit Source Select the value that will be retransmitted.		A Analog Input SEtPE Set Point CUrrent Current	Analog Input	a process output (PM6 _ _ F _ _ _ _ A _ _ or PM6 _ _ _ _ _ F _ A _ _) and Function is set to Retransmit.
Fi [Fi]	<i>Output (1 or 3)</i> Function Instance Select which source instance will drive the output.		1 to 4	1	a process output (PM6 _ _F _ _ _ _ A _ _ or PM6 _ _ _ _ _ F _ A _ _) and there is more than one instance of the Function selection.
SLo [S.Lo]	<i>Output (1 or 3)</i> Scale Low Set the minimum value of the process output range in electrical units.		0.00 to 20.00	0.00	a process output (PM6 _ _F _ _ _ _ A _ _ or PM6 _ _ _ _ _ F _ A _ _)
Sh [S.hi]	<i>Output (1 or 3)</i> Scale High Set the maximum value of the process output range in electrical units.		0.00 to 20.00	10.00	a process output (PM6 _ _F _ _ _ _ A _ _ or PM6 _ _ _ _ _ F _ A _ _)
rLo [r.Lo]	<i>Output (1 or 3)</i> Range Low Set the minimum value of the retransmit value range in process units. When the retransmit source is at this value, the retransmit output will be at its Scale Low value.		-1,999.000 to 9,999.000°F or units -1,128.000 to 5,537.000°C	0.0°F or units -18°C	a process output (PM6 _ _ F _ _ _ _ A _ _ or PM6 _ _ _ _ _ F _ A _ _) and Function is set to Retransmit.
rhi [r.hi]	<i>Output (1 or 3)</i> Range High Set the maximum value of the retransmit value range in process units. When the retransmit source is at this value, the retransmit output will be at its Scale High value.		-1,999.000 to 9,999.000°F or units -1,128.000 to 5,537.000°C	9,999.0°F or units 5,537.0°C	a process output (PM6 _ _ F _ _ _ _ A _ _ or PM6 _ _ _ _ _ F _ A _ _) and Function is set to Retransmit.
oLo [o.Lo]	<i>Output (1 or 3)</i> Low Power Scale Set the minimum value of the output range.		0.0 to 100.0%	0.0	a process output (PM6 _ _F _ _ _ _ A _ _ or PM6 _ _ _ _ _ F _ A _ _) and Function is set to Heat or Cool.
oHi [o.hi]	<i>Output (1 or 3)</i> High Power Scale Set the maximum value of the output range.		0.0 to 100.0%	100.0	a process output (PM6 _ _F _ _ _ _ A _ _ or PM6 _ _ _ _ _ F _ A _ _) and Function is set to Heat or Cool.
oCA [o.CA]	<i>Output (1 or 3)</i> Calibration Offset Set an offset value for a process output.		-1,999.000 to 9,999.000°F or units -1,110.555 to 5,555.000°C	0.0°F or units 0.0°C	a process output (PM6 _ _F _ _ _ _ A _ _ or PM6 _ _ _ _ _ F _ A _ _)
Note: Some values will be rounded off to fit in the four-character display. Full values can be read with other interfaces.					
If there is only one instance of a menu, no submenus will appear.					

Display	Parameter Name Description	Settings	Range	Default	Appears If															
<input type="checkbox"/> Fn [Fn]	<i>Output (1 to 4)</i> Function Select what function will drive this output.		<input type="checkbox"/> OFF Off <input type="checkbox"/> HEAT Heat <input type="checkbox"/> COOL Cool <input type="checkbox"/> ALARM Alarm <input type="checkbox"/> ENT Event <input type="checkbox"/> LIMIT Limit (outputs 3 & 4)	Heat Alarm Off (outputs 3 & 4)	a time-proportioned output (solid-state relay, switched dc or mechanical relay)															
<input type="checkbox"/> Fi [Fi]	<i>Output (1 to 4)</i> Function Instance Select which source instance will drive the output.		1 to 4	1	a time-proportioned output (solid-state relay, switched dc or mechanical relay), and there is more than one instance of the Function selection.															
<input type="checkbox"/> oCb [o.Ct]	<i>Output (1 to 4)</i> Control Set the output control type. This parameter is only used with PID control, but can be set anytime.		<input type="checkbox"/> FTB Fixed Time Base <input type="checkbox"/> VTB Variable Time Base	Fixed Time Base	a time-proportioned output (solid-state relay, switched dc or mechanical relay). If output 1 is a universal process output, output 2 cannot function as a variable-time-base output. If output 3 is a universal process output, output 4 cannot function as a variable-time-base output.															
<input type="checkbox"/> oEb [o.tb]	<i>Output (1 to 4)</i> Time Base Set the time base for fixed-time-base control.		0.1 to 60.0 seconds (solid-state relay or switched dc) 5.0 to 60.0 seconds (mechanical relay or no-arc power control)	0.1 sec. [SSR & sw dc] 20.0 sec. [mech, relay, no-arc]	a time-proportioned output (solid-state relay, switched dc or mechanical relay) and Control is set to Fixed Time Base.															
<input type="checkbox"/> oLo [o.Lo]	<i>Output (1 to 4)</i> Low Power Scale The power output will never be less than the value specified and will represent the value at which output scaling begins.		0.0 to 100.0%	0.0%	a time-proportioned output (solid-state relay, switched dc or mechanical relay) and Source is set to Heat or Cool.															
<input type="checkbox"/> oHi [o.hi]	<i>Output (1 to 4)</i> High Power Scale The power output will never be greater than the value specified and will represent the value at which output scaling stops.		0.0 to 100.0%	100.0%	a time-proportioned output (solid-state relay, switched dc or mechanical relay) and Source is set to Heat or Cool.															
<table border="0" style="width:100%; text-align:center;"> <tr> <td><input type="checkbox"/> ALARM</td> <td><input type="checkbox"/> 1</td> <td><input type="checkbox"/> 2</td> <td><input type="checkbox"/> 3</td> <td><input type="checkbox"/> 4</td> </tr> <tr> <td><input type="checkbox"/> SEt</td> <td><input type="checkbox"/> ALARM</td> <td><input type="checkbox"/> ALARM</td> <td><input type="checkbox"/> ALARM</td> <td><input type="checkbox"/> ALARM</td> </tr> <tr> <td>Alarm Menu</td> <td>Alarm 1</td> <td>Alarm 2</td> <td>Alarm 3</td> <td>Alarm 4</td> </tr> </table>						<input type="checkbox"/> ALARM	<input type="checkbox"/> 1	<input type="checkbox"/> 2	<input type="checkbox"/> 3	<input type="checkbox"/> 4	<input type="checkbox"/> SEt	<input type="checkbox"/> ALARM	<input type="checkbox"/> ALARM	<input type="checkbox"/> ALARM	<input type="checkbox"/> ALARM	Alarm Menu	Alarm 1	Alarm 2	Alarm 3	Alarm 4
<input type="checkbox"/> ALARM	<input type="checkbox"/> 1	<input type="checkbox"/> 2	<input type="checkbox"/> 3	<input type="checkbox"/> 4																
<input type="checkbox"/> SEt	<input type="checkbox"/> ALARM	<input type="checkbox"/> ALARM	<input type="checkbox"/> ALARM	<input type="checkbox"/> ALARM																
Alarm Menu	Alarm 1	Alarm 2	Alarm 3	Alarm 4																
<input type="checkbox"/> ALY [A.ty]	<i>Alarm (1 to 4)</i> Type Select how the alarm will or will not track the set point.		<input type="checkbox"/> OFF Off <input type="checkbox"/> PrAL Process Alarm <input type="checkbox"/> DEAL Deviation Alarm	Off	always															
<input type="checkbox"/> SrA [Sr.A]	<i>Alarm (1 to 4)</i> Source Select what will trigger this alarm.		<input type="checkbox"/> AI Analog Input <input type="checkbox"/> PWR Power (process only) <input type="checkbox"/> CUR Current (process only)	Analog Input	always															
<input type="checkbox"/> iSA [iS.A]	<i>Alarm (1 to 4)</i> Source Instance If Alarm Source is set to input, select which input to use.		1 or 2	1	there is more than one instance of the Source selection.															
<p>Note: Some values will be rounded off to fit in the four-character display. Full values can be read with other interfaces.</p> <p>If there is only one instance of a menu, no submenus will appear.</p>																				

Display	Parameter Name Description	Settings	Range	Default	Appears If
<input type="checkbox"/> RhY [A.hy]	<i>Alarm (1 to 4)</i> Hysteresis Set the hysteresis for an alarm. This determines how far into the safe region the process value needs to move before the alarm can be cleared.		0.001 to 9,999.000°F or units 0.001 to 5,555.000°C	1.0°F or units 1.0°C	always
<input type="checkbox"/> RL9 [A.Lg]	<i>Alarm (1 to 4)</i> Logic Select what the output condition will be during the alarm state.		<input type="checkbox"/> RLC Close On Alarm <input type="checkbox"/> RLo Open On Alarm	Close On Alarm	always
<input type="checkbox"/> RSd [A.Sd]	<i>Alarm (1 to 4)</i> Sides Select which side or sides will trigger this alarm.		<input type="checkbox"/> both Both <input type="checkbox"/> h,9h High <input type="checkbox"/> low Low	Both	always
<input type="checkbox"/> RLA [A.LA]	<i>Alarm (1 to 4)</i> Latching Turn alarm latching on or off. A latched alarm has to be turned off by the user.		<input type="checkbox"/> nRL Non-Latching <input type="checkbox"/> RL Latching	Non-Latching	always
<input type="checkbox"/> RbL [A.bL]	<i>Alarm (1 to 4)</i> Blocking Select when an alarm will be blocked. After startup and/or after the set point changes, the alarm will be blocked until the process value enters the normal range.		<input type="checkbox"/> off Off <input type="checkbox"/> St Startup <input type="checkbox"/> SP Set Point <input type="checkbox"/> both Both	Off	always
<input type="checkbox"/> RSi [A.Si]	<i>Alarm (1 to 4)</i> Silencing Turn alarm silencing on to allow the user to disable this alarm.		<input type="checkbox"/> off Off <input type="checkbox"/> on On	Off	always
<input type="checkbox"/> RdSP [A.dSP]	<i>Alarm (1 to 4)</i> Display Display an alarm message when an alarm is active.		<input type="checkbox"/> off Off <input type="checkbox"/> on On	On	always
<input type="checkbox"/> RdL [A.dL]	<i>Alarm (1 to 4)</i> Delay Set the time the alarm will be delayed after the process value exceeds the alarm set point.		0 to 9,999 seconds	0	always
<input type="checkbox"/> UCC <input type="checkbox"/> SEE Current Menu (menu appears if PM6 _ _ _ _ _ T _ _ A _ _)					
<input type="checkbox"/> CSd [C.Sd]	<i>Current</i> Sides Select which side of the current to monitor.		<input type="checkbox"/> off Off <input type="checkbox"/> h,9h High <input type="checkbox"/> low Low <input type="checkbox"/> both Both	Off	always
<input type="checkbox"/> CUr [CU.r]	<i>Current</i> Reading Enable Display under- or over-range current.		<input type="checkbox"/> no No <input type="checkbox"/> YES Yes	No	always
<input type="checkbox"/> Cdt [C.dt]	<i>Current</i> Detect Threshold For factory adjustment only.		3 to 59	9	always
<input type="checkbox"/> CSL [C.SC]	<i>Current</i> Scaling Adjust scaling to match the transformer's high range.		0 to 9,999.000 amperes	50.0	always
<input type="checkbox"/> CoFS [C.oFS]	<i>Current</i> Offset Calibrate the current reading with an offset value.		-1,999.000 to 9,999.000	0.0	always
Note: Some values will be rounded off to fit in the four-character display. Full values can be read with other interfaces.					
If there is only one instance of a menu, no submenus will appear.					

Display	Parameter Name Description	Settings	Range	Default	Appears If
<u>C.S.</u> [C.Si]	<i>Current</i> Source Output Instance Select which output instance the current transformer will monitor.		1 to 6	1 (if not process) 2 (otherwise)	always
<u>FUn</u> <u>SEt</u> Function Key Menu					
<u>LEu</u> [LEv]	<i>Function Key</i> Level Select what state the Function Key will be in at startup. Pressing the Function Key will toggle the selected action.		<u>h.9h</u> High <u>LoLJ</u> Low	High	always
<u>F.n</u> [Fn]	<i>Function Key</i> Digital Input Function Program the EZ Key to trigger an action. Functions respond to a level state change or an edge level change.		<u>nonE</u> None <u>idLE</u> Idle Set Point Enable (level) <u>EUnE</u> Tune (edge) <u>ALrT</u> Alarm Reset (edge) <u>SIL</u> Silence Alarms (edge) <u>MAN</u> Manual/Auto Mode (level) <u>oFF</u> Control Outputs Off (level) <u>rEn</u> Remote Set Point Enable (level) <u>PLoC</u> Lock Keypad (level) <u>FAL</u> Force Alarm (level) <u>EdR</u> TRU-TUNE+® Disable (level) <u>RoF</u> Alarm Outputs & Control Loop Off (level) <u>USr.r</u> Restore User Settings (edge) <u>Pd.S</u> Profile Disable (level) <u>PhoL</u> Profile Hold/Resume (level) <u>ProF</u> Profile Start Number (edge) <u>PSEs</u> Profile Start/Stop (level) <u>LPr.r</u> Limit Reset (edge)	None	always, but only the available features can be selected.
<u>F.i</u> [Fi]	<i>Function Key</i> Instance Select which instance the EZ Key will affect. If only one instance is available, any selection will affect it.		0 All Instances (except Profile) (For example, if Digital Function is set to Silence Alarms and Function Instance is set to 0, then the digital input would silence all alarms.) 1 to 4	0	there is more than one instance of the Digital Input Function selection.
<u>GLbL</u> <u>SEt</u> Global Menu					
<u>C.F</u> [C.F]	<i>Global</i> Display Units Select which units will be displayed.		<u>F</u> °F <u>C</u> °C	°F	always
<u>ACLF</u> [AC.LF]	<i>Global</i> AC Line Frequency Set the frequency to the applied ac line power source.		<u>50</u> 50 Hz <u>60</u> 60 Hz	60 Hz	always
Note: Some values will be rounded off to fit in the four-character display. Full values can be read with other interfaces. If there is only one instance of a menu, no submenus will appear.					

Display	Parameter Name Description	Settings	Range	Default	Appears If
<input type="checkbox"/> P.F3 [ip.F3]	<i>Communications 2</i> IP Fixed Address Part 3 Set the IP address of this controller. Each device on the network must have a unique address.		0 to 255	1	IP Address Mode is set to Fixed
<input type="checkbox"/> P.F4 [ip.F4]	<i>Communications 2</i> IP Fixed Address Part 4 Set the IP address of this controller. Each device on the network must have a unique address.		0 to 255	1	IP Address Mode is set to Fixed
<input type="checkbox"/> P.51 [ip.S1]	<i>Communications 2</i> IP Fixed Subnet Part 1 Set the IP subnet mask for this controller.		0 to 255	255	IP Address Mode is set to Fixed
<input type="checkbox"/> P.52 [ip.S2]	<i>Communications 2</i> IP Fixed Subnet Part 2 Set the IP subnet mask for this controller.		0 to 255	255	IP Address Mode is set to Fixed
<input type="checkbox"/> P.53 [ip.S1]	<i>Communications 2</i> IP Fixed Subnet Part 3 Set the IP subnet mask for this controller.		0 to 255	0	IP Address Mode is set to Fixed
<input type="checkbox"/> P.54 [ip.S4]	<i>Communications 2</i> IP Fixed Subnet Part 4 Set the IP subnet mask for this controller.		0 to 255	0	IP Address Mode is set to Fixed
<input type="checkbox"/> P.91 [ip.g1]	<i>Communications 2</i> IP Fixed Gateway Part 1 Set the IP gateway address for this controller.		0 to 255	0	IP Address Mode is set to Fixed
<input type="checkbox"/> P.92 [ip.g2]	<i>Communications 2</i> IP Fixed Gateway Part 2 Set the IP gateway address for this controller.		0 to 255	0	IP Address Mode is set to Fixed
<input type="checkbox"/> P.93 [ip.g3]	<i>Communications 2</i> IP Fixed Gateway Part 3 Set the IP gateway address for this controller.		0 to 255	0	IP Address Mode is set to Fixed
<input type="checkbox"/> P.94 [ip.g4]	<i>Communications 2</i> IP Fixed Gateway Part 4 Set the IP gateway address for this controller.		0 to 255	0	IP Address Mode is set to Fixed
<input type="checkbox"/> P.7b.E [Mb.E]	<i>Communications 2</i> Modbus TCP Enable Activate Modbus TCP.		<input type="checkbox"/> no No <input checked="" type="checkbox"/> YES Yes	Yes	the controller includes Modbus TCP (PM6 _ _ _ _ _ 3AA _ A _ _).
<input type="checkbox"/> E.i.P.E [EiP.E]	<i>Communications 2</i> EtherNet/IP™ Enable Activate EtherNet/IP™.		<input type="checkbox"/> no No <input checked="" type="checkbox"/> YES Yes	Yes	the controller includes EtherNet/IP (PM6 _ _ _ _ _ 3AA _ A _ _).

Note: Some values will be rounded off to fit in the four-character display. Full values can be read with other interfaces.

If there is only one instance of a menu, no submenus will appear.

7

Chapter 7: Profiling Page

Navigating the Profiling Page



Note:









Some of these menus and parameters may not appear, depending on the controller's options. See model number information in the Appendix for more information.

If there is only one instance of a menu, no submenus will appear.

Home Page	Profiling Page	Steps	Step Types						
P ← ⊙ SP ⊙ →	P1 ← ⊙ FILE ⊙ →	I ← ⊙ P1 ⊙ →	t1 ← ⊙ STEP ⊙ → <table border="1"> <tr> <td>Target Set Point</td> <td>Hours</td> <td>Minutes</td> <td>Seconds</td> <td>Event Output 1</td> <td>Event Output 2</td> </tr> </table>	Target Set Point	Hours	Minutes	Seconds	Event Output 1	Event Output 2
Target Set Point	Hours	Minutes	Seconds	Event Output 1	Event Output 2				
Hold key for 3 seconds.	Profile 1 ⊙ ↑ ⊙ ↓ Steps 1 to 10 Profile 1	⊙ ↑ ⊙ ↓ Steps 1 to 10 Profile 1	⊙ ↑ ⊙ ↓						
	P2 ← ⊙ FILE ⊙ →	I1 P2 ⊙ →	RATE ← ⊙ STEP ⊙ → <table border="1"> <tr> <td>Target Set Point</td> <td>Rate</td> <td>Event Output 1</td> <td>Event Output 2</td> </tr> </table>	Target Set Point	Rate	Event Output 1	Event Output 2		
Target Set Point	Rate	Event Output 1	Event Output 2						
	Profile 2 ⊙ ↑ ⊙ ↓ Steps 11 to 20 Profile 2	⊙ ↑ ⊙ ↓ Steps 11 to 20 Profile 2	⊙ ↑ ⊙ ↓						
	P3 ← ⊙ FILE ⊙ →	I2 P3 ⊙ →	SOAK ← ⊙ STEP ⊙ → <table border="1"> <tr> <td>Hours</td> <td>Minutes</td> <td>Seconds</td> <td>Event Output 1</td> <td>Event Output 2</td> </tr> </table>	Hours	Minutes	Seconds	Event Output 1	Event Output 2	
Hours	Minutes	Seconds	Event Output 1	Event Output 2					
	Profile 3 ⊙ ↑ ⊙ ↓ Steps 21 to 30 Profile 3	⊙ ↑ ⊙ ↓ Steps 21 to 30 Profile 3	⊙ ↑ ⊙ ↓						
	P4 ← ⊙ FILE ⊙ →	I3 P4 ⊙ →	WJE ← ⊙ STEP ⊙ → <table border="1"> <tr> <td>Wait Event 1</td> <td>Wait Event 2</td> <td>Event Output 1</td> <td>Event Output 2</td> </tr> </table>	Wait Event 1	Wait Event 2	Event Output 1	Event Output 2		
Wait Event 1	Wait Event 2	Event Output 1	Event Output 2						
	Profile 4 ⊙ ↑ ⊙ ↓ Steps 31 to 40 Profile 4	⊙ ↑ ⊙ ↓ Steps 31 to 40 Profile 4	⊙ ↑ ⊙ ↓						
			WJPr ← ⊙ STEP ⊙ → <table border="1"> <tr> <td>Wait for Process Instance</td> <td>Wait for Process Value</td> <td>Event Output 1</td> <td>Event Output 2</td> </tr> </table>	Wait for Process Instance	Wait for Process Value	Event Output 1	Event Output 2		
Wait for Process Instance	Wait for Process Value	Event Output 1	Event Output 2						
			WJb ← ⊙ STEP ⊙ → <table border="1"> <tr> <td>Target Set Point</td> <td>Wait Event 1</td> <td>Wait Event 2</td> <td>Event Output 1</td> <td>Event Output 2</td> </tr> </table>	Target Set Point	Wait Event 1	Wait Event 2	Event Output 1	Event Output 2	
Target Set Point	Wait Event 1	Wait Event 2	Event Output 1	Event Output 2					
			JL ← ⊙ STEP ⊙ → <table border="1"> <tr> <td>Jump Step</td> <td>Jump Count</td> <td>Event Output 1</td> <td>Event Output 2</td> </tr> </table>	Jump Step	Jump Count	Event Output 1	Event Output 2		
Jump Step	Jump Count	Event Output 1	Event Output 2						
			End ← ⊙ STEP ⊙ → <table border="1"> <tr> <td>End Step</td> <td>End Type</td> </tr> </table>	End Step	End Type				
End Step	End Type								
			USEP STEP Unused Step ⊙ ↑ ⊙ ↓						

The Profiling Page allows you to enter your ramp and soak profile information.

To go to the Profiling Page from the Home Page, press the Advance Key  for three seconds, until **PrOF** appears in the lower display and the profile number appears in the upper display. Press the Up  or Down  key to change to another profile.





- Press the Advance Key  to move to the selected profile's first step.
- Press the Up  or Down  keys to move through the steps.
- Press the Advance Key  to move through the selected step's settings.
- Press the Up  or Down  keys to change the step's settings.
- Press the Infinity Key  at any time to return to the step number prompt.
- Press the Infinity Key  again to return to the profile number prompt.
- From any point press and hold the Infinity Key  for two seconds to return to the Home Page.

Note: Changes made to profile parameters in the Profiling Pages will be saved and will also have an immediate impact on the running profile.

Some parameters in the Profile Status Menu can be changed for the currently running profile, but should only be changed by knowledgeable personnel and with caution. Changing parameters via the Profile Status Menu will not change the stored profile but will have an immediate impact on the profile that is running.

How to Start a Profile

After defining the profile follow the steps below to run the profile:

1. From the Home Page push the Advance Key  repeatedly until Profile Start **PSt 1** appears in the lower display.
2. Use the Up  or Down  key to choose the file or step number within a profile where you want the profile to begin running.
3. Press the Advance Key . This takes you to Profile Action **PAC 1**, where you can select the appropriate action.
 - **nonE** No action
 - **PrOF** Begin execution from first step of the specified profile number, whether it exists or not.
 - **PAUS** Pause the currently running profile.
 - **RESU** Resume running the profile from the previously paused step.
 - **End** End the profile.
 - **StEP** Begin running the profile from the specified step number.

Note: Avoid continuous writes within loops. Excessive writes to EEPROM will cause premature EEPROM failure. The EEPROM is rated for 1,000,000 writes.

Display	Parameter name Description	Set- tings	Range (Integer values for Mod- bus in parentheses.)	Default	Appears If
Profiling parameters appear if the controller includes profiling (PM6 R _ _ _ _ _ A _ _).					
PrOF [PrOF]	Profile Select the profile to be edited or viewed.		P1 to P4	1	always
P 1 [P1] to P 4 [P4]	Step Select a step to edit or view.		1 to 10 [profile 1] 11 to 20 [profile 2] 21 to 30 [profile 3] 31 to 40 [profile 4]		always
StEP [S.typ]	Step Type Select a step type.		USEP Unused Step Time RATE Rate SoAK Soak WFE Wait For Event WPr Wait For Process WBo Wait For Both JL Jump Loop End End	Unused	always
tgSP [tg.SP]	<i>Step Type Parameters</i> Target Set Point Select the set point for this step.		-1,999.000 to 9,999.000°F or units -1,128 to 5,537.000°C	0.0°F or units -18°C	Step Type is set to Time, Rate, Wait for Process or Wait for Both.
Note: Some values will be rounded off to fit in the four-character display. Full values can be read with another interface.					

Display	Parameter name Description	Set- tings	Range (Integer values for Mod- bus in parentheses.)	Default	Appears If
hoUr [hoUr]	<i>Step Type Parameters</i> Hours Select the hours (plus Minutes and Seconds) for a timed step.		0 to 99	0	Step Type is set to Time or Soak.
Min [Min]	<i>Step Type Parameters</i> Minutes Select the minutes (plus Hours and Seconds) for a timed step.		0 to 59	0	Step Type is set to Time or Soak.
SEC [SEC]	<i>Step Type Parameters</i> Seconds Select the seconds (plus Hours and Minutes) for a timed step.		0 to 59	0	Step Type is set to Time or Soak.
rAtE [rAtE]	<i>Step Type Parameters</i> Rate Select the rate for ramping in degrees or units per minute.		0 to 9,999.000°F or units per minute 0 to 5,555.000°C per minute	0.0	Step Type is set to Rate.
W.P. [W.P.]	<i>Step Type Parameters</i> Wait For Process Instance Select which analog input Wait For Process will use.		1 or 2	1	Step Type is set to Wait For Process and the controller has two process inputs.
WPr [WPr]	<i>Step Type Parameters</i> Wait For Process Value The step will wait until the process value is equal to the Wait-for Process Value. Once the Wait For Process is satisfied, this step ends.		-1,999.000 to 9,999.000°F or units -1,128.000 to 5,537.000°C	0.0°F or units -18.0°C	Step Type is set to Wait For Process.
WE.1 [WE.1] or WE.2 [WE.2]	<i>Step Type Parameters</i> Wait Event (1 and 2) Select the event state that must be satisfied during this step. Digital input 5 provides the state of Event 1, and digital input 6 provides the state of Event 2.		<input type="checkbox"/> oFF Off <input type="checkbox"/> oN On <input type="checkbox"/> nonE None	Off	Step Type is set to Wait Event or Wait for Both.
JS [JS]	<i>Step Type Parameters</i> Jump Step Select a step to jump to.		1 to 40	0	Step Type is set to Jump Loop.
JC [JC]	<i>Step Type Parameters</i> Jump Count Set the number of jumps. A value of 0 creates an infinite loop. Loops can be nested four deep.		0 to 9,999	0	Step Type is set to Jump Loop.
End [End]	<i>Step Type Parameters</i> End Type Select what the controller will do when this profile ends.		<input type="checkbox"/> oFF Control Mode set to Off <input type="checkbox"/> HoLd Hold last closed-loop set point in the profile <input type="checkbox"/> USEr User, reverts to previous set point	User	Step Type is set to End.
Ent1 [Ent1] or Ent2 [Ent2]	<i>Step Type Parameters</i> Event Output (1 and 2) Select whether Event Output 1 or 2 is on or off during this step.		<input type="checkbox"/> oFF Off <input type="checkbox"/> oN On	Off	Step Type is set to Time, Rate, Soak, Wait Event, Wait for Process, Wait for Both or Jump Loop.

Note: Some values will be rounded off to fit in the four-character display. Full values can be read with another interface.

Display	Step Type Description	Parameters in Step Type
Profiling parameters appear if the controller includes profiling (PM6 R _ _ _ _ _ A _ _).		
<input type="checkbox"/> ti [ti]	<i>Step Types</i> Time A Time Step controls at the Target Set Point and maintains two event output states for the designated time.	<input type="checkbox"/> TSPT Target Set Point <input type="checkbox"/> hOUR Hours <input type="checkbox"/> MIN Minutes <input type="checkbox"/> SEC Seconds <input type="checkbox"/> Ent1 Event Output 1 <input type="checkbox"/> Ent2 Event Output 2
<input type="checkbox"/> rAtE [rAtE]	<i>Step Types</i> Rate A Rate Step ramps the process value to the Target Set Point in degrees per minute while maintaining two event output states.	<input type="checkbox"/> TSPT Target Set Point <input type="checkbox"/> rAtE Rate <input type="checkbox"/> Ent1 Event Output 1 <input type="checkbox"/> Ent2 Event Output 2
<input type="checkbox"/> SoAK [SoAk]	<i>Step Types</i> Soak A Soak Step maintains the last Target Set Point and two event output states for the designated time.	<input type="checkbox"/> hOUR Hours <input type="checkbox"/> MIN Minutes <input type="checkbox"/> SEC Seconds <input type="checkbox"/> Ent1 Event Output 1 <input type="checkbox"/> Ent2 Event Output 2
<input type="checkbox"/> WJE [W.E]	<i>Step Types</i> Wait For Event A Wait Event Step will wait for the event input states to match the two Wait Event settings.	<input type="checkbox"/> WJE.1 Wait Event 1 (digital input 5) <input type="checkbox"/> WJE.2 Wait Event 2 (digital input 6) <input type="checkbox"/> Ent1 Event Output 1 <input type="checkbox"/> Ent2 Event Output 2
<input type="checkbox"/> WJPr [W.Pr]	<i>Step Types</i> Wait For Process A Wait For Process Step will wait for the process value to match the Wait For Process value.	<input type="checkbox"/> WJPr Wait For Process Instance <input type="checkbox"/> WJPr Wait For Process Value <input type="checkbox"/> Ent1 Event Output 1 <input type="checkbox"/> Ent2 Event Output 2
<input type="checkbox"/> WJbo [W.bo]	<i>Step Types</i> Wait For Both A Wait For Both Step will wait for the process value to match the Target Set Point and for the event states to match the two event output settings	<input type="checkbox"/> TSPT Target Set Point <input type="checkbox"/> WJE.1 Wait Event 1 (digital input 5) <input type="checkbox"/> WJE.2 Wait Event 2 (digital input 6) <input type="checkbox"/> Ent1 Event Output 1 <input type="checkbox"/> Ent2 Event Output 2
<input type="checkbox"/> JL [JL]	<i>Step Types</i> Jump Loop A Jump Loop step will jump to the Jump Step the number of times designated in Jump Count. Loops can be nested up to four deep.	<input type="checkbox"/> JS Jump Step <input type="checkbox"/> JC Jump Count <input type="checkbox"/> Ent1 Event Output 1 <input type="checkbox"/> Ent2 Event Output 2
<input type="checkbox"/> End [End]	<i>Step Types</i> End An End Step will end the profile. If a profile doesn't include an End Step, control will move to the next step. If no End Step is confronted, after step 40 control will default to the set point in effect before the profile started.	<input type="checkbox"/> End End Type
<input type="checkbox"/> USEP [UStP]	<i>Step Types</i> Unused Step This is an empty step that can be used to, in effect, erase a step in a profile.	

8

Chapter 8: Factory Page

To go to the Factory Page from the Home Page, press and hold both the Advance \odot and Infinity ∞ keys for six seconds.

- Press the Advance Key \odot to move through the parameter prompts.
- Press the Up \blacktriangle or Down \blacktriangledown keys to change the parameter value.

- Press the Infinity Key ∞ to return to the Home Page.

Note: Avoid continuous writes within loops. Excessive writes to EEPROM will cause premature EEPROM failure. The EEPROM is rated for 1,000,000 writes.

Navigating the Factory Page

Note:

Some of these menus and parameters may not appear, depending on the controller's options. See model number information in the Appendix for more information.

If there is only one instance of a menu, no submenus will appear.

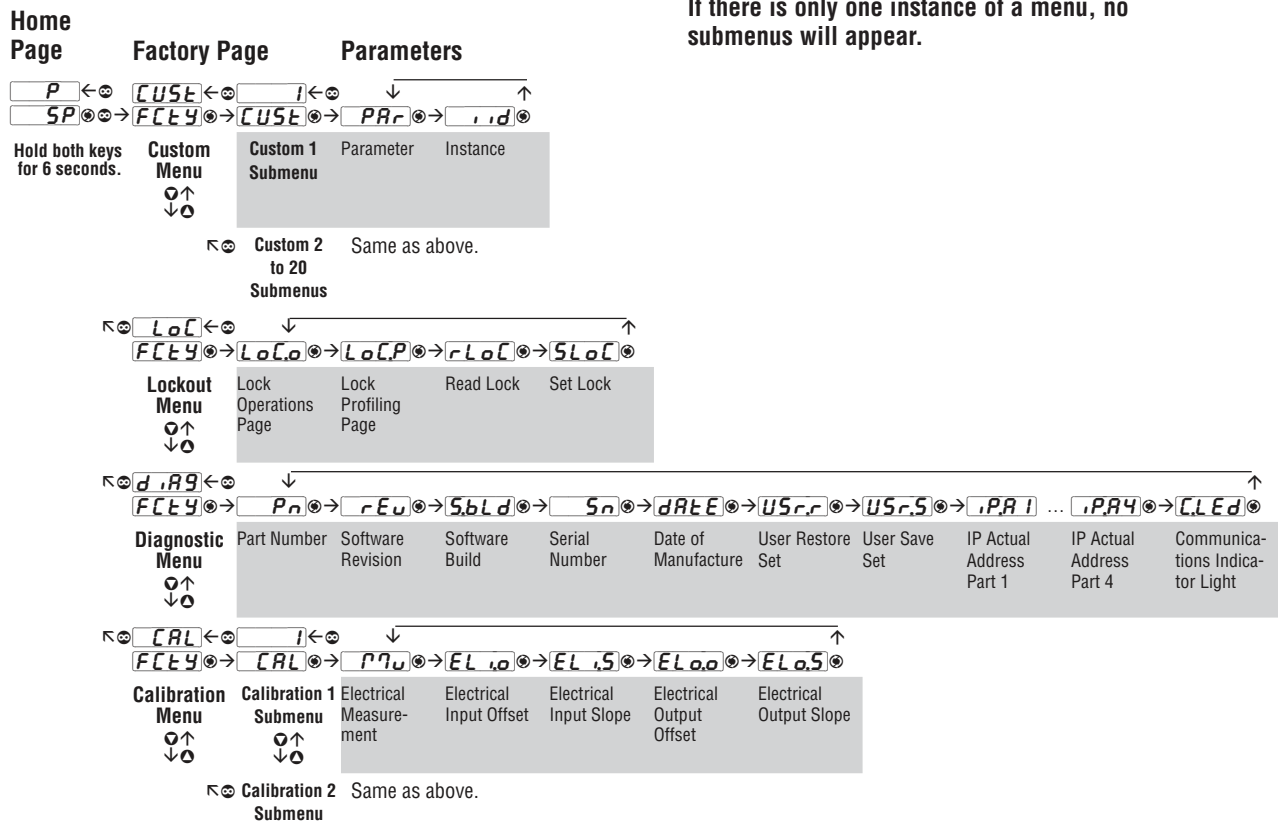

Display	Parameter Name Description	Settings	Range	Default	Appears If
CUSE FCEY Custom Menu	1 Custom 1	20 Custom 20			
PAR [PAr]	<p><i>Custom Menu</i> Parameter 1 to 20 Select the parameters that will appear in the Home Page.</p> <p>The Parameter 1 value will appear in the upper display of the Home Page. It cannot be changed with the Up and Down Keys in the Home Page.</p> <p>The Parameter 2 value will appear in the lower display in the Home Page. It can be changed with the Up and Down Keys, if the parameter is a writable one.</p> <p>Scroll through the other Home Page parameters with the Advance Key .</p>		none None Pro Process SPt Set Point ACPu Active Process Value ACSP Active Set Point oP Open Loop Set Point iCR Input Calibration Offset C_F Display Units USrr User Restore Set ALo Alarm Low Set Point Ah Alarm High Set Point Ahy Alarm Hysteresis AUE Autotune CPM User Control Mode hPr Heat Power CPr Cool Power t Time Integral td Time Derivative db Dead Band hPb Heat Proportional Band hhy Heat Hysteresis CPb Cool Proportional Band chy Cool Hysteresis rrt Ramp Rate Cur Current Read ttUn TRU-TUNE+® Enable idLE Idle Set Point CUSE Custom Menu PSEr Profile Start PACr Profile Action Request 95d Guaranteed Soak Deviation Value LLS Limit Low Set Point LhS Limit High Set Point Lhy Limit Hysteresis	Active Process Value (1, Top Display) Active Set Point (2, Bottom Display) User Control Mode (4) Heat Power (5) Cool Power (6) Autotune (7) Idle Set Point (8) Profile Start (9) Profile Action (10) None (11 to 20)	always
iid [iid]	<p><i>Custom Menu</i> Instance Select which instance of the parameter will be selected.</p>		1 to 4		the parameter may apply to more than one instance.
LoC FCEY Lockout Menu					
LoCo [LoC.o]	<p><i>Lockout Menu</i> Lock Operations Page Change the security level of the Operations Page.</p>		1 to 3	2	always
LoCP [LoC.P]	<p><i>Lockout Menu</i> Lock Profiling Page Change the security level of the Profiling Page.</p>		1 to 3	3	always
<p>Note: Some values will be rounded off to fit in the four-character display. Full values can be read with another interface.</p> <p>If there is only one instance of a menu, no submenus will appear.</p>					

Display	Parameter Name Description	Settings	Range	Default	Appears If
rLoC [rLoC]	<i>Lockout Menu</i> Read Lockout Security Set the read security clearance level. The user can access the selected level and all lower levels. If the Set Lockout Security level is higher than the Read Lockout Security, the Read Lockout Security level takes priority.		1 to 5 1 Home Page 2 Operations Page* 3 Profiling Page* 4 Setup Page and Diagnostics Menu 5 Lock, Calibration and Custom menus *You can change the security level of the Operations and Profiling pages with Lock Operations Page and Lock Profiling Page.	5	always
SLoC [SLoC]	<i>Lockout Menu</i> Set Lockout Security Set the write security clearance level. The user can access the selected level and all lower levels. If the Set Lockout Security level is higher than the Read Lockout Security, the Read Lockout Security level takes priority.		0 to 5 0 No changes allowed, except to SLoC 1 Home Page 2 Operations Page* 3 Profiling Page* 4 Setup Page and Diagnostics Menu 5 Lock, Calibration and Custom menus *You can change the security level of the Operations and Profiling pages with Lock Operations Page and Lock Profiling Page.	5	always
d.A9 FCEY Diagnostics Menu					
Pn [Pn]	<i>Diagnostics Menu</i> Part Number Display this controller's part number.				always
rEu [rEu]	<i>Diagnostics Menu</i> Software Revision Display this controller's firmware revision number.				always
SbLd [S.bLd]	<i>Diagnostics Menu</i> Software Build Display the firmware build number.		0 to 2,147,483,647		always
Sn [Sn]	<i>Diagnostics Menu</i> Serial Number Display the serial number.		0 to 2,147,483,647		always
dAtE [dAtE]	<i>Diagnostics Menu</i> Date of Manufacture Display the date code.		0 to 2,147,483,647		always
USr.r [USr.r]	<i>Diagnostics Menu</i> User Restore Set Replace all of this controller's settings with another set.		none None SEE1 User Set 1 SEE2 User Set 2 FCEY Factory Default	None	always
USr.S [USr.S]	<i>Diagnostics Menu</i> User Save Set Save all of this controller's settings to the selected set.		none None SEE1 User Set 1 SEE2 User Set 2	None	always
.PA1 [iPA.1]	<i>Diagnostics Menu</i> IP Actual Address Part 1 Display the first part of this controller's IP address.		0 to 255	None	the controller includes EtherNet/IP (PM6 _ _ _ _ - 3AA _ A _ _).
.PA2 [iPA.2]	<i>Diagnostics Menu</i> IP Actual Address Part 2 Display the second part of this controller's IP address.		0 to 255	None	the controller includes EtherNet/IP (PM6 _ _ _ _ - 3AA _ A _ _).
Note: Some values will be rounded off to fit in the four-character display. Full values can be read with another interface.					
If there is only one instance of a menu, no submenus will appear.					

Display	Parameter Name Description	Settings	Range	Default	Appears If
[PP3] [iP.A3]	<i>Diagnostics Menu</i> IP Actual Address Part 3 Display the third part of this controller's IP address.		0 to 255	None	the controller includes EtherNet/IP (PM6 _ _ _ _ - 3AA _ A _ _).
[PP4] [iP.A4]	<i>Diagnostics Menu</i> IP Actual Address Part 4 Display the fourth part of this controller's IP address.		0 to 255	None	the controller includes EtherNet/IP (PM6 _ _ _ _ - 3AA _ A _ _).
[LEd] [C.LEd]	<i>Diagnostics Menu</i> Communications Indicator Light Select which channel the Communications Activity indicator light will monitor.	<input type="checkbox"/> <i>off</i> Off <input type="checkbox"/> <i>Chan 1</i> Channel 1 <input type="checkbox"/> <i>Chan 2</i> Channel 2 <input type="checkbox"/> <i>both</i> Both			
[CAL] [FLY]	<input type="checkbox"/> <i>1</i> Calibration Menu	<input type="checkbox"/> <i>1</i> Calibration 1	<input type="checkbox"/> <i>2</i> Calibration 2	(input 2 appears if PM6 _ _ _ _ - [R, T or L] _ _ A _ _)	
[PV] [Mv]	<i>Calibration Menu (1 or 2)</i> Electrical Measurement Read the raw electrical value for this input in the units corresponding to the Sensor Type (Setup Page, Analog Input Menu) setting.		-1,999.000 to 9,999.000		always
[ELo] [ELi.o]	<i>Calibration Menu (1 or 2)</i> Electrical Input Offset Change this value to calibrate the low end of the input range.		-1,999.000 to 9,999.000	0.0	always
[EL.S] [ELi.S]	<i>Calibration Menu (1 or 2)</i> Electrical Input Slope Adjust this value to calibrate the slope of the input value.		-1,999.000 to 9,999.000	1.0	always
[ELo.o] [ELo.o]	<i>Calibration Menu (1 or 2)</i> Electrical Output Offset Change this value to calibrate the low end of the output range. Menu 2 calibrates output 3.		-1,999.000 to 9,999.000	0.0	the controller has process outputs: (PM6 _ F _ _ _ - _ A _) or (PM6 _ _ _ _ - F A _)
[ELo.S] [ELo.S]	<i>Calibration Menu (1 or 2)</i> Electrical Output Slope Adjust this value to calibrate the slope of the output value. Menu 2 calibrates output 3.		-1,999.000 to 9,999.000	1.0	the controller has process outputs: (PM6 _ F _ _ _ - _ A _) or (PM6 _ _ _ _ - F A _)
Note: Some values will be rounded off to fit in the four-character display. Full values can be read with another interface.					
If there is only one instance of a menu, no submenus will appear.					

9

Chapter 9: Features

Saving and Restoring User Settings	54
Programming the Home Page	54
Tuning the PID Parameters	54
Manual Tuning	55
Autotuning with TRU-TUNE+™	55
Inputs	56
Calibration Offset	56
Calibration	56
Filter Time Constant	57
Sensor Selection	57
Sensor Backup	57
Set Point Low Limit and High Limit	57
Scale High and Scale Low	57
Range High and Range Low	57
Receiving a Remote Set Point	57
Outputs	58
Duplex	58
No-arc Relay	58
Retransmitting a Process Value or Set Point	58
Cool Output Curve	59
Control Methods	59
Output Configuration	59
Auto (closed loop) and Manual (open loop) Control	59
On-Off Control	60
Proportional Control	60
Proportional plus Integral (PI) Control	61
Proportional plus Integral plus Derivative (PID) Control	61
Dead Band	61
Variable Time Base	62
Single Set Point Ramping	62
Alarms	63
Process and Deviation Alarms	63
Alarm Set Points	63
Alarm Hysteresis	63
Alarm Latching	63
Alarm Silencing	64
Alarm Blocking	64
Current Sensing	64
Programming the EZ Key	64
Using Lockout to Secure Settings	65

Saving and Restoring User Settings

Recording setup and operations parameter settings for future reference is very important. If you unintentionally change these, you will need to program the correct settings back into the controller to return the equipment to operational condition.

After you program the controller and verify proper operation, use User Save Set **[USrS]** (Factory Page, Diagnostics Menu) to save the settings into either of two files in a special section of memory. If the settings in the controller are altered and you want to return the controller to the saved values, use User Restore Set **[USrR]** (Factory Page, Diagnostics Menu) to recall one of the saved settings.

A digital input or the Function Key can also be configured to restore parameters.

Note: Only perform the above procedure when you are sure that all the correct settings are programmed into the controller. Saving the settings overwrites any previously saved collection of settings. Be sure to document all the controller settings.

Programming the Home Page

Watlow's patented user-defined menu system improves operational efficiency. The user-defined Home Page provides you with a shortcut to monitor or change the parameter values that you use most often.

You can create your own Home Page with as many as 20 of the active parameters. When a parameter normally located in the Setup Page or Operations Page is placed in the Home Page, it is accessible through both. If you change a parameter in the Home Page, it is automatically changed in its original page. If you change a parameter in its original page it is automatically changed in the Home Page.

The default parameters will automatically appear in the Home Page.

Change the list of parameters in the Home Page from the Custom Menu **[CUSE]** (Factory Page).

Tuning the PID Parameters

Autotuning

When an autotune is performed on the EZ-ZONE® PM, the set point is used to calculate the tuning set point.

For example, if the active set point is 200° and Autotune Set Point **[AESP]** (Operations Page, Loop Menu) is set to 90 percent, the autotune function utilizes 180° for tuning. This is also how autotuning works in previous Watlow Winona controllers. In addition, changing the active set point in previous controllers causes the autotune function to restart; where with the EZ-ZONE® PM changing the set point after an autotune has been started has no affect.

A new feature in EZ-ZONE® PM products will allow set point changes while the control is autotuning, this includes while running a profile or ramping. When the auto tune is initially started it will use the current set point and will disregard all set point changes until the tuning process is complete. Once complete, the controller will then use the new set point.

This is why it is a good idea to enter the active set point before initiating an autotune.

Autotuning calculates the optimum heating and/or cooling PID parameter settings based on the system's response. Autotuning can be enabled whether or not TUNE-TUNE+™ is enabled. The PID settings generated by the autotune will be used until the autotune feature is rerun, the PID values are manually adjusted or TRU-TUNE+® is enabled.

To initiate an autotune, set Autotune Request **[AUT]** (Operations Page, Loop Menu) to **[YES]**. You should not autotune while a profile is running. If the autotune cannot be completed in 60 minutes, the autotune will time-out and the original settings will take effect.

The lower display will flash between **[TUNE]** and the set point while the autotuning is underway. The temperature must cross the Autotune Set Point five times to complete the autotuning process. Once complete, the controller controls at the normal set point, using the new parameters.

Select a set point for the tune with Autotune Set Point. The Autotune Set Point is expressed as a percent of the Closed Loop Set Point.

If you need to adjust the tuning procedure's aggressiveness, use Autotune Aggressiveness **[AAGR]** (Setup Page, Loop Menu). Select under damped **[Under]** to bring the process value to the set point quickly. Select over damped **[over]** to bring the process value to the set point with minimal overshoot. Select critical damped **[crit]** to balance a rapid response with minimal overshoot.

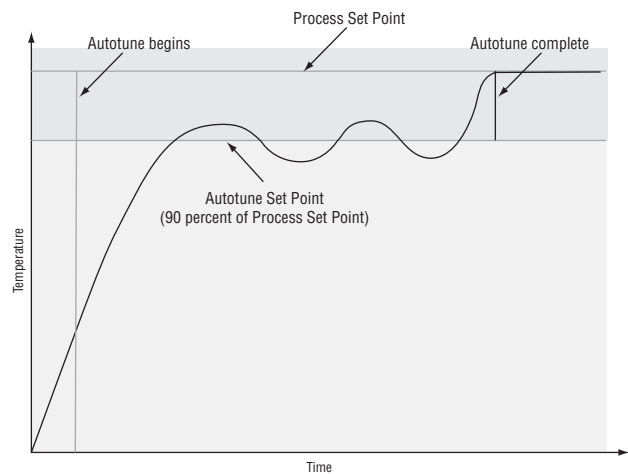

Manual Tuning

In some applications, the autotune process may not provide PID parameters for the process characteristics you desire. If that is the case, you may want to tune the controller manually.

1. Apply power to the controller and establish a set point typically used in your process.
2. Go to the Operations Page, Loop Menu, and set Heat Proportional Band \boxed{hPb} and/or Cool Proportional Band \boxed{CPb} to 5. Set Time Integral $\boxed{t_i}$ to 0. Set Time Derivative \boxed{td} to 0.
3. When the system stabilizes, watch the process value. If it fluctuates, increase the Heat Proportional Band or Cool Proportional Band value in 3 to 5° increments until it stabilizes, allowing time for the system to settle between adjustments.
4. When the process has stabilized, watch Heat Power \boxed{hPr} or Cool Power \boxed{CPr} (Operations Page, Monitor Menu). It should be stable $\pm 2\%$. At this point, the process temperature should also be stable, but it will have stabilized before reaching the set point. The difference between the set point and actual process value can be eliminated with Integral.
5. Start with an Integral value of 6,000 and allow 10 minutes for the process temperature to reach the set point. If it has not, reduce the setting by half and wait another 10 minutes. Continue reducing the setting by half every 10 minutes until the process value equals the set point. If the process becomes unstable, the Integral value is too small. Increase the value until the process stabilizes.
6. Increase Derivative to 0.1. Then increase the set point by 11° to 17°C. Monitor the system's approach to the set point. If the process value overshoots the set point, increase Derivative to 0.2. Increase the set point by 11° to 17°C and watch the approach to the new set point. If you increase Derivative too much, the approach to the set point will be very sluggish. Repeat as necessary until the system rises to the new set point without overshoot or sluggishness.

For additional information about autotune and PID control, see related features in this chapter.

Autotuning with TRU-TUNE+®

The TRU-TUNE+® adaptive algorithm will optimize the controller's PID values to improve control of dynamic processes. TRU-TUNE+® monitors the process variable and adjusts the control parameters automatically to keep your process at set point during set point and load changes. When the controller is in the adaptive control mode, it determines the appropriate output signal and, over time, adjusts control parameters to optimize responsiveness and stability. The TRU-TUNE+® feature does not function for on-off control.

The preferred and quickest method for tuning a loop is to establish initial control settings and continue with the adaptive mode to fine tune the settings.

Setting a controller's control mode to tune starts this two-step tuning process. (See Autotuning in this chapter.) This predictive tune determines initial, rough settings for the PID parameters. Then the loop automatically switches to the adaptive mode which fine tunes the PID parameters.

Once the process variable has been at set point for a suitable period (about 30 minutes for a fast process to roughly two hours for a slower process) and if no further tuning of the PID parameters is desired or needed, TRU-TUNE+™ may be turned off. However, keeping the controller in the adaptive mode allows it to automatically adjust to load changes and compensate for differing control characteristics at various set points for processes that are not entirely linear.

Once the PID parameters have been set by the TRU-TUNE+™ adaptive algorithm, the process, if shut down for any reason, can be restarted in the adaptive control mode.

Turn TRU-TUNE+™ on or off with TRU-TUNE+™ Enable \boxed{tEtUn} (Setup Page, Loop Menu).

Use TRU-TUNE+™ Band \boxed{tband} (Setup Page, Loop Menu) to set the range above and below the set point in which adaptive tuning will be active. Adjust this parameter only in the unlikely event that the controller is unable to stabilize at the set point with TRU-TUNE+™ Band set to auto (0). This may occur with very fast processes. In that case, set TRU-TUNE+™ Band to a large value, such as 100.

Use TRU-TUNE+™ Gain \boxed{tgn} (Setup Page, Loop Menu) to adjust the responsiveness of the adaptive tuning calculations. Six settings range from 1, with the most aggressive response and most potential overshoot (highest gain), to 6, with the least aggressive response and least potential for overshoot (lowest gain). The default setting, 3, is recommended for loops with thermocouple feedback and moderate response and overshoot potential.

Before Tuning

Before autotuning, the controller hardware must be installed correctly, and these basic configuration parameters must be set:

- Sensor Type \boxed{SEn} (Setup Page, Analog Input Menu), and scaling, if required;
- Function \boxed{Fn} (Setup Page, Output Menu) and scaling, if required.

How to Autotune a Loop

1. Enter the desired set point or one that is in the middle of the expected range of set points that you want to tune for.
2. Enable TRU-TUNE+®.

- Initiate an autotune. (See Autotuning in this chapter.)

When autotuning is complete, the PID parameters should provide good control. As long as the loop is in the adaptive control mode, TRU-TUNE+® continuously tunes to provide the best possible PID control for the process.



WARNING! During autotuning, the controller sets the output to 100 percent and attempts to drive the process variable toward the set point. Enter a set point and heat and cool power limits that are within the safe operating limits of your system.

Inputs

Calibration Offset

Calibration offset allows a device to compensate for an inaccurate sensor, lead resistance or other factors that affect the input value. A positive offset increases the input value, and a negative offset decreases the input value.

The input offset value can be viewed or changed with Calibration Offset (Operations Page, Analog Input Menu).

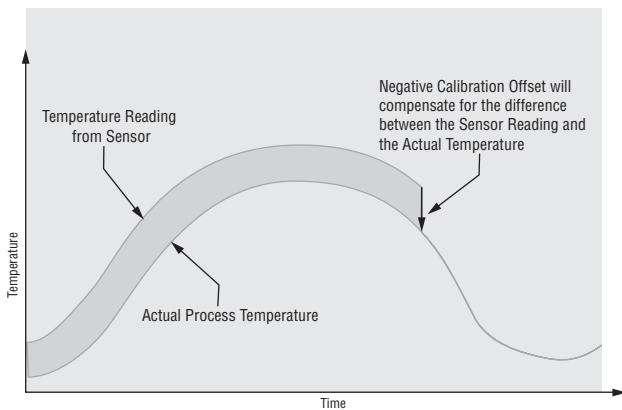

Calibration

To calibrate an analog input, you will need to provide two electrical signals or resistance loads near the extremes of the range that the application is likely to utilize. See recommended values below:

Sensor Type	Low Source	High Source
thermocouple	0.000 mV	50.000 mV
millivolts	0.000 mV	50.000 mV
volts	0.000V	10.000V
milliamps	0.000 mA	20.000 mA
100 Ω RTD	50.00 Ω	350.00 Ω
1,000 Ω RTD	500.00 Ω	3,500.00 Ω

Follow these steps for a thermocouple or process input:

- Apply the low source signal to the input you are calibrating. Measure the signal to ensure it is accurate.
- Read the value of Electrical Measurement (Factory Page, Calibration Menu) for that input.
- Calculate the offset value by subtracting this value from the low source signal.
- Set Electrical Input Offset (Factory Page, Calibration Menu) for this input to the offset value.
- Check the Electrical Measurement to see whether it now matches the signal. If it doesn't match, adjust Electrical Offset again.
- Apply the high source signal to the input. Measure the signal to ensure it is accurate.
- Read the value of Electrical Measurement for that input.
- Calculate the gain value by dividing the low source signal by this value.
- Set Electrical Slope (Factory Page, Calibration Menu) for this input to the calculated gain value.
- Check the Electrical Measurement to see whether it now matches the signal. If it doesn't match, adjust Electrical Slope again.

Set Electrical Offset to 0 and Electrical Slope to 1 to restore factory calibration.

Follow these steps for an RTD input:

- Measure the low source resistance to ensure it is accurate. Connect the low source resistance to the input you are calibrating.
- Read the value of Electrical Measurement (Factory Page, Calibration Menu) for that input.
- Calculate the offset value by subtracting this value from the low source resistance.
- Set Electrical Input Offset (Factory Page, Calibration Menu) for this input to the offset value.
- Check the Electrical Measurement to see whether it now matches the resistance. If it doesn't match, adjust Electrical Offset again.
- Measure the high source resistance to ensure it is accurate. Connect the high source resistance to the input.
- Read the value of Electrical Measurement for that input.
- Calculate the gain value by dividing the low source signal by this value.
- Set Electrical Slope (Factory Page, Calibration Menu) for this input to the calculated gain value.
- Check the Electrical Measurement to see whether it now matches the signal. If it doesn't match, adjust Electrical Slope again.

Set Electrical Offset to 0 and Electrical Slope to 1 to restore factory calibration.

Filter Time Constant

Filtering smooths an input signal by applying a first-order filter time constant to the signal. Filtering the displayed value makes it easier to monitor. Filtering the signal may improve the performance of PID control in a noisy or very dynamic system.

Adjust the filter time interval with Filter Time

(Setup Page, Analog Input Menu).

Example: With a filter value of 0.5 seconds, if the process input value instantly changes from 0 to 100 and remained at 100, the display will indicate 100 after five time constants of the filter value or 2.5 seconds.

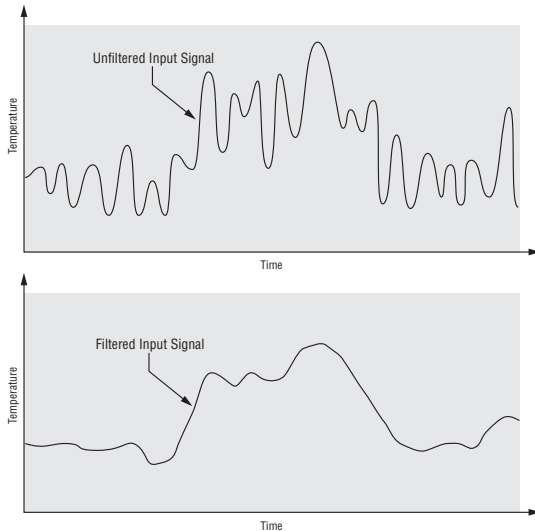

Sensor Selection

You need to configure the controller to match the input device, which is normally a thermocouple, RTD or process transmitter.

Select the sensor type with Sensor Type

(Setup Page, Analog Input Menu).

Sensor Backup

Sensor backup maintains closed-loop control after an input failure by switching control to input 2.

The sensor backup feature is only available in an EZ-ZONE[®] PM Integrated limit or remote set point controller.

Turn sensor backup on or off with Sensor Backup Enable (Setup Page, Analog Input 1).

Set Point Low Limit and High Limit

The controller constrains the set point to a value between a set point low limit and a set point high limit.

Set the set point limits with Low Set Point and High Set Point (Setup Page, Loop Menu).

There are two sets of set point low and high limits: one for a closed-loop set point, another for an

open-loop set point.

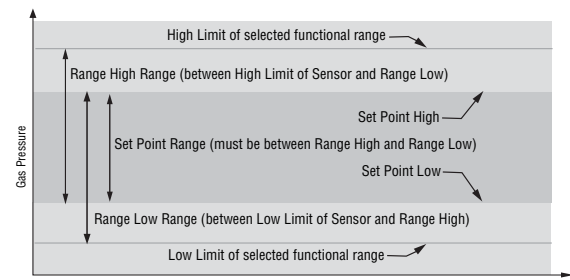

Scale High and Scale Low

When an analog input is selected as process voltage or process current input, you must choose the value of voltage or current to be the low and high ends. For example, when using a 4 to 20 mA input, the scale low value would be 4.00 mA and the scale high value would be 20.00 mA. Commonly used scale ranges are: 0 to 20 mA, 4 to 20 mA, 0 to 5V, 1 to 5V and 0 to 10V.

You can create a scale range representing other units for special applications. You can reverse scales from high values to low values for analog input signals that have a reversed action. For example, if 50 psi causes a 4 mA signal and 10 psi causes a 20 mA signal.

Scale low and high low values do not have to match the bounds of the measurement range. These along with range low and high provide for process scaling and can include values not measurable by the controller. Regardless of scaling values, the measured value will be constrained by the electrical measurements of the hardware.

Select the low and high values with Scale Low and Scale High . Select the displayed range with Range Low and Range High (Setup Page, Analog Input Menu).

Range High and Range Low

With a process input, you must choose a value to represent the low and high ends of the current or voltage range. Choosing these values allows the controller's display to be scaled into the actual working units of measurement. For example, the analog input from a humidity transmitter could represent 0 to 100 percent relative humidity as a process signal of 4 to 20 mA. Low scale would be set to 0 to represent 4 mA and high scale set to 100 to represent 20 mA. The indication on the display would then represent percent humidity and range from 0 to 100 percent with an input of 4 to 20 mA.

Select the low and high values with Range Low and Range High (Setup Page, Analog Input Menu).

Receiving a Remote Set Point

The remote set point feature allows the controller to use a thermocouple, RTD, 1 k potentiometer or process signal at input 2 to establish the set point,

which allows its set point to be manipulated by an external source. A common application would use one ramping controller with a set-point retransmit output to ramp multiple controllers using the remote set point. Or you could use an analog output from a PLC to send set point values to an EZ-ZONE® PM.

The controller must have two process inputs to use the remote set point feature.

You may select between local and remote set points at the front panel, with an event input, from a remote computer using the communications feature or from an external switch using an event input.

Make sure all input and output impedances are compatible.

Switch to the remote set point with Remote Enable **r.En** (Operations Page, Loop Menu). Select whether the remote set point controls an open- or closed-loop set point with Remote Set Point Type **r.ty**.

Assign the function of switching to a remote set point to a digital input with Digital Input Function **Fn** (Setup Page, Digital Input Menu).

Assign the function of switching to a remote set point to the EZ Key with Digital Input Function **Fn** (Setup Page, Function Key Menu).

Outputs

Duplex

Certain systems require that a single process output control both heating and cooling outputs. An EZ-ZONE® PM controller with a process output can function as two separate outputs.

With a 4 to 20mA output the heating output will operate from 12 to 20mA (0 to +100 percent) and the cooling output will operate from 12 to 4mA (0 to -100 percent).

In some cases this type of output is required by the device that the EZ-ZONE® PM controls, such as a three-way valve that opens one way with a 12 to 20mA signal and opens the other way with a 4 to 12mA signal. This feature reduces the overall system cost by using a single output to act as two outputs.

Outputs 1 and 3 can be ordered as process outputs. Select duplex **DUPL** as the Output Function **Fn** (Setup Page, Output Menu). Set the output to volts **volt** or milliamps **mA** with Output Type **o.ty**. Set the range of the process output with Scale Low **SLo** and Scale High **SHi**.

No-arc Relay

A no-arc relay provides a significant improvement in the life of the output relay over conventional relays.

Conventional mechanical relays have an expected life of 100,000 cycles at the rated full-load current. The shorter life for conventional relays is due to the

fact that when contacts open while current is flowing metal degradation occurs. This action produces unavoidable electrical arcing causing metal to transfer from one contact to the other. The arcing conditions continue on each subsequent contact opening until over time the resistance through the contacts increases causing the contacts to increase in temperature. Eventually, the contacts will weld together and the relay remains in the on state.

The Watlow no-arc relay is a hybrid relay. It uses a mechanical relay for the current load and a triac (solid-state switch) to carry the turn-on and turn-off currents. No-arc relays extend the life of the relay more than two million cycles at the rated full-load current.

Although a no-arc relay has significant life advantages, a few precautions must be followed for acceptable usage:

Do not use:

- hybrid relays for limit contactors. A limit or safety device must provide a positive mechanical break on all hot legs simultaneously;
- dc loads with hybrid relays. The triacs used for arc suppression will turn off only with ac line voltage;
- hybrid switches to drive any inductive loads, such as relay coils, transformers or solenoids;
- cycle times less than five seconds on hybrid switches;
- on loads that exceed 264V ac through relay;
- on loads that exceed 15 amperes load;
- on loads less than 100 mA;
- no-arc relays in series with other no-arc relays.

Retransmitting a Process Value or Set Point

The retransmit feature allows a process output to provide an analog signal that represents the set point or process value. The signal may serve as a remote set point for another controller or as an input for a chart recorder documenting system performance over time.

In choosing the type of retransmit signal the operator must take into account the input impedance of the device to be retransmitted to and the required signal type, either voltage or milliamps.

Typically applications might use the retransmit option to record one of the variables with a chart recorder or to generate a set point for other controls in a multi-zone application.

Outputs 1 and 3 can be ordered as process outputs. Select retransmit **r.rte** as the Output Function **Fn** (Setup Page, Output Menu). Set the output to volts **volt** or milliamps **mA** with Output Type **o.ty**. Select the signal to retransmit with Retransmit Source **r.sr**.



Set the range of the process output with Scale Low and Scale High . Scale the retransmit source to the process output with Range Low and Range High .

When the retransmit source is at the Range Low value, the retransmit output will be at its Scale Low value. When the retransmit source is at the Range High value, the retransmit output will be at its Scale High value.

Cool Output Curve

A nonlinear output curve may improve performance when the response of the output device is nonlinear. If a cool output uses one of the nonlinear curves a PID calculation yields a lower actual output level than a linear output would provide.

These output curves are used in plastics extruder applications: curve 1 for oil-cooled extruders and curve 2 for water-cooled extruders.

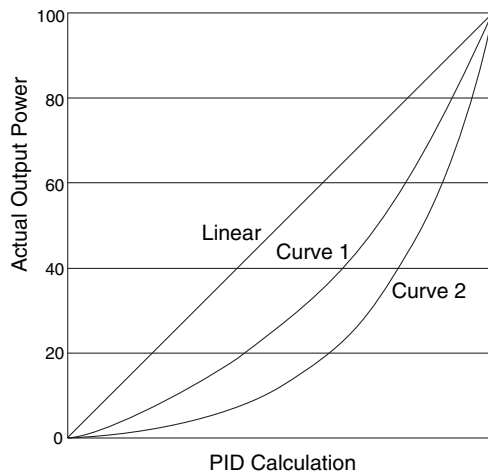

Select a nonlinear cool output curve with Cool Output Curve (Setup Menu, Loop Menu).

Control Methods

Output Configuration

Each controller output can be configured as a heat output, a cool output, an alarm output or deactivated. No dependency limitations have been placed on the available combinations. The outputs can be con-

figured in any combination. For instance, all three could be set to cool.

Heat and cool outputs use the set point and Operations parameters to determine the output value. All heat and cool outputs use the same set point value. Heat and cool each have their own set of control parameters. All heat outputs use the same set of heat control parameters and all cool outputs use the same set of cool output parameters.

Each alarm output has its own set of configuration parameters and set points, allowing independent operation.

Auto (closed loop) and Manual (open loop) Control

The controller has two basic modes of operation, auto mode and manual mode. Auto mode allows the controller to decide whether to perform closed-loop control or to follow the settings of Input Error Failure (Setup Page, Loop Menu). The manual mode only allows open-loop control. The EZ-ZONE[®] PM controller is normally used in the auto mode. The manual mode is usually only used for specialty applications or for troubleshooting.

Manual mode is open-loop control that allows the user to directly set the power level to the controller's output load. No adjustments of the output power level occur based on temperature or set point in this mode.

In auto mode, the controller monitors the input to determine if closed-loop control is possible. The controller checks to make certain a functioning sensor is providing a valid input signal. If a valid input signal is present, the controller will perform closed-loop control. Closed-loop control uses a process sensor to determine the difference between the process value and the set point. Then the controller applies power to a control output load to reduce that difference.

If a valid input signal is not present, the controller will indicate an input error message in the upper display and in the lower display and respond to the failure according to the setting of Input Error Failure . You can configure the controller to perform a "bumpless" transfer , switch power to output a preset fixed level , or turn the output power off.

Bumpless transfer will allow the controller to transfer to the manual mode using the last power value calculated in the auto mode if the process had stabilized at a ± 5 percent output power level for the time interval of Time Integral (Operations Page, Loop) prior to sensor failure, and that power level is less than 75 percent.

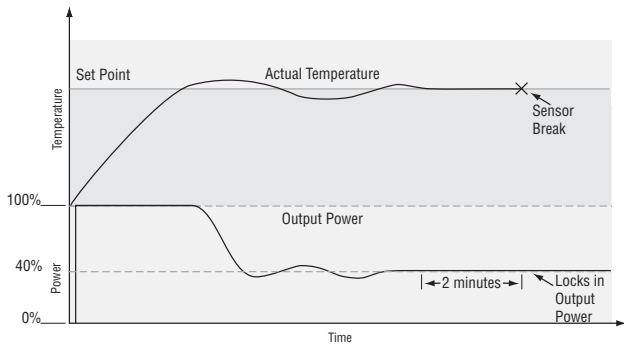

Input Error Latching \boxed{IER} (Setup Page, Analog Input Menu) determines the controller's response once a valid input signal returns to the controller. If latching is on, then the controller will continue to indicate an input error until the error is cleared. To clear a latched alarm, press the Advance Key \odot then the Up Key \blacktriangle .

If latching is off, the controller will automatically clear the input error and return to reading the temperature. If the controller was in the auto mode when the input error occurred, it will resume closed-loop control. If the controller was in manual mode when the error occurred, the controller will remain in open-loop control.

The Manual Control Indicator Light % is on when the controller is operating in manual mode.

You can easily switch between modes if the Control Mode $\boxed{CP7}$ parameter is selected to appear in the Home Page.

To transfer to manual mode from auto mode, press the Advance Key \odot until $\boxed{CP7}$ appears in the lower display. The upper display will display \boxed{AUTO} for auto mode. Use the Up \blacktriangle or Down \blacktriangledown keys to select \boxed{MAN} . The manual set point value will be recalled from the last manual operation.

To transfer to auto mode from manual mode, press the Advance Key \odot until $\boxed{CP7}$ appears in the lower display. The upper display will display \boxed{MAN} for manual mode. Use the Up \blacktriangle or Down \blacktriangledown keys to select \boxed{AUTO} . The automatic set point value will be recalled from the last automatic operation.

Changes take effect after three seconds or immediately upon pressing either the Advance Key \odot or the Infinity Key ∞ .

On-Off Control

On-off control switches the output either full on or full off, depending on the input, set point and hysteresis values. The hysteresis value indicates the amount the process value must deviate from the set point to turn on the output. Increasing the value decreases the number of times the output will cycle. Decreasing hysteresis improves controllability. With hysteresis set to 0, the process value would stay closer to the set point, but the output would switch on

and off more frequently, and may result in the output "chattering."

On-off control can be selected with Heat Algorithm \boxed{HAG} or Cool Algorithm \boxed{CAG} (Setup Page, Loop Menu).

On-off hysteresis can be set with Heat Hysteresis \boxed{HHY} or Cool Hysteresis \boxed{CHY} (Operations Page, Loop Menu).

Note: Input Error Failure Mode \boxed{FAIL} does not function in on-off control mode. The output goes off.

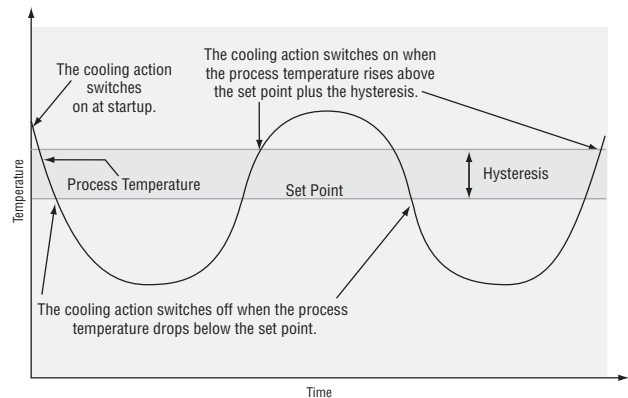
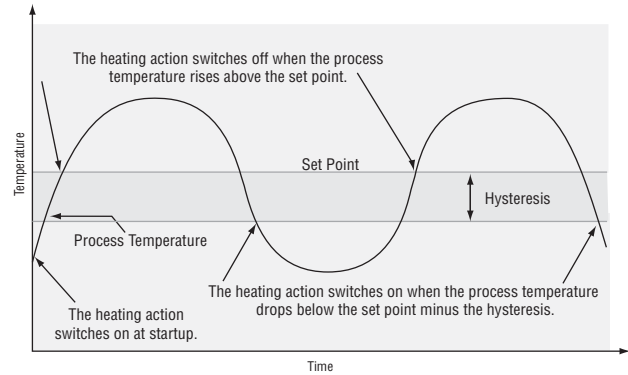

Proportional Control

Some processes need to maintain a temperature or process value closer to the set point than on-off control can provide. Proportional control provides closer control by adjusting the output when the temperature or process value is within a proportional band. When the value is in the band, the controller adjusts the output based on how close the process value is to the set point.

The closer the process value is to the set point, the lower the output power. This is similar to backing off on the gas pedal of a car as you approach a stop sign. It keeps the temperature or process value from swinging as widely as it would with simple on-off control. However, when the system settles down, the temperature or process value tends to "droop" short of the set point.

With proportional control the output power level equals (set point minus process value) divided by the proportional band value.

In an application with one output assigned to heating and another assigned to cooling, each will have a separate proportional parameter. The heating parameter takes effect when the process temperature is lower than the set point, and the cooling parameter takes effect when the process temperature is higher than the set point.

Adjust the proportional band with Heat Proportional Band $\boxed{h.Pb}$ or Cool Proportional Band $\boxed{c.Pb}$ (Operations Page, Loop Menu).

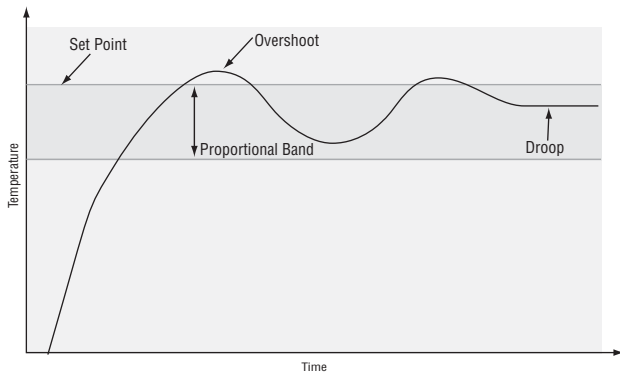

Proportional plus Integral (PI) Control

The droop caused by proportional control can be corrected by adding integral (reset) control. When the system settles down, the integral value is tuned to bring the temperature or process value closer to the set point. Integral determines the speed of the correction, but this may increase the overshoot at start-up or when the set point is changed. Too much integral action will make the system unstable. Integral is cleared when the process value is outside of the proportional band.

Adjust the integral with Time Integral $\boxed{t_i}$ (Operations Page, Loop Menu).

Proportional plus Integral plus Derivative (PID) Control

Use derivative (rate) control to minimize the overshoot in a PI-controlled system. Derivative (rate) adjusts the output based on the rate of change in the temperature or process value. Too much derivative (rate) will make the system sluggish.

Derivative action is active only when the process value is within twice the proportional value from the set point.

Adjust the derivative with Time Derivative $\boxed{t_d}$ (Operations Page, Loop Menu).

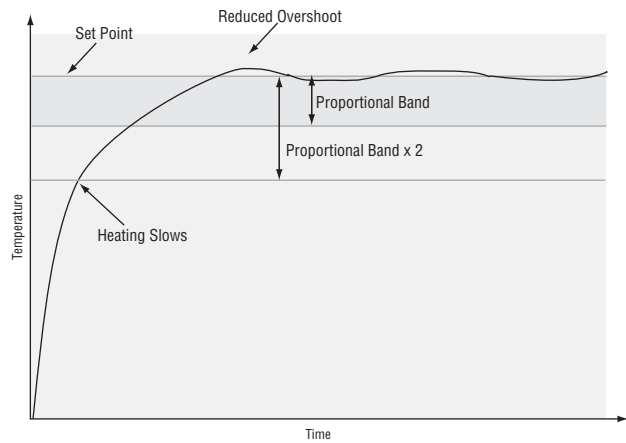

Dead Band

In a PID application the dead bands above and below the set point can save an application's energy and wear by maintaining process temperature within acceptable ranges.

Proportional action ceases when the process value is within the dead band. Integral action continues to bring the process temperature to the set point.

Using a **positive dead band value** keeps the two systems from fighting each other.

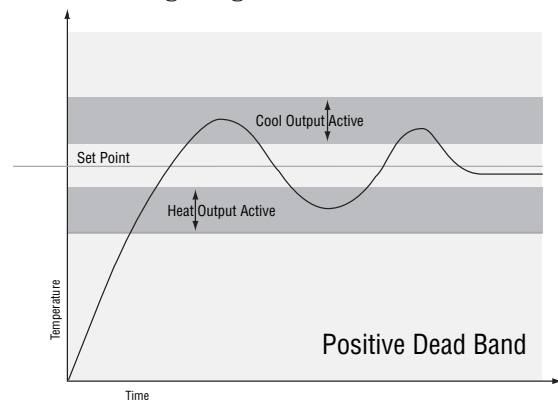

When the **dead band value is zero**, the heating output activates when the temperature drops below the set point, and the cooling output switches on when the temperature exceeds the set point.

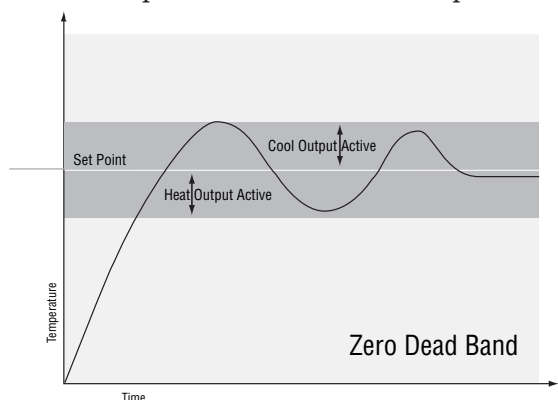

When the **dead band value is a negative value**, both heating and cooling outputs are active when the temperature is near the set point.

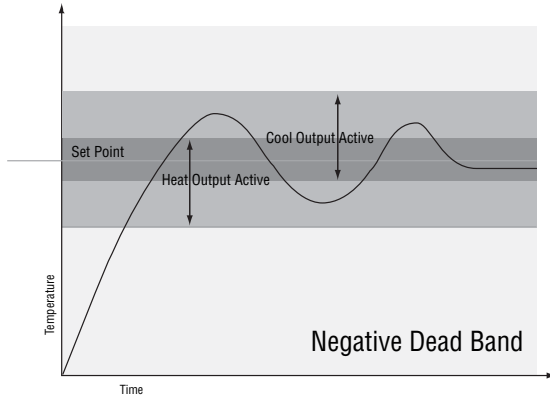

Adjust the dead band with Dead Band (Operations Page, Loop Menu).

Variable Time Base

Variable time base is the preferred method for controlling a resistive load, providing a very short time base for longer heater life. Unlike phase-angle firing, variable-time-base switching does not limit the current and voltage applied to the heater.

With variable time base outputs, the PID algorithm calculates an output between 0 and 100%, but the output is distributed in groupings of three ac line cycles. For each group of three ac line cycles, the controller decides whether the power should be on or off. There is no fixed cycle time since the decision is made for each group of cycles. When used in conjunction with a zero cross (burst fire) device, such as a solid-state power controller, switching is done only at the zero cross of the ac line, which helps reduce electrical noise (RFI).

Variable time base should be used with solid-state power controllers, such as a solid-state relay (SSR) or silicon controlled rectifier (SCR) power controller. Do not use a variable time base output for controlling electromechanical relays, mercury displacement relays, inductive loads or heaters with unusual resistance characteristics.

The combination of variable time base output and a solid-state relay can inexpensively approach the effect of analog, phase-angle fired control.

Select the AC Line Frequency (Setup Page, Global Menu), 50 or 60 Hz.

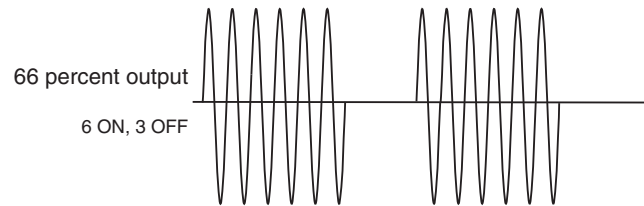
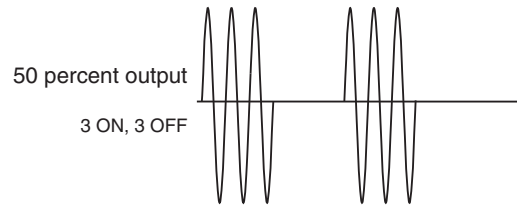
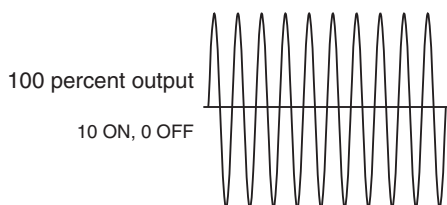

Note:

When output 1 is a universal process output, output 2 cannot use variable time base, fixed time base only.

When output 3 is configured as a universal process, output 4 cannot use variable time base, fixed time base only.

Single Set Point Ramping

Ramping protects materials and systems that cannot tolerate rapid temperature changes. The value of the ramp rate is the maximum degrees per minute or hour that the system temperature can change.

Select Ramp Action (Setup Page, Loop Menu):

ramping not active.

ramp at startup.

ramp at a set point change.

ramp at startup or when the set point changes.

Select whether the rate is in degrees per minute or degrees per hour with Ramp Scale . Set the ramping rate with Ramp Rate (Setup Page, Loop Menu).

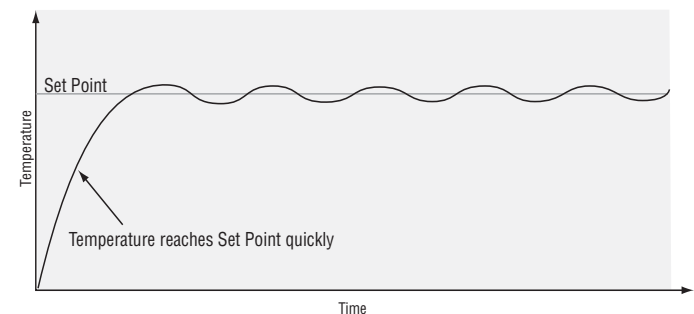

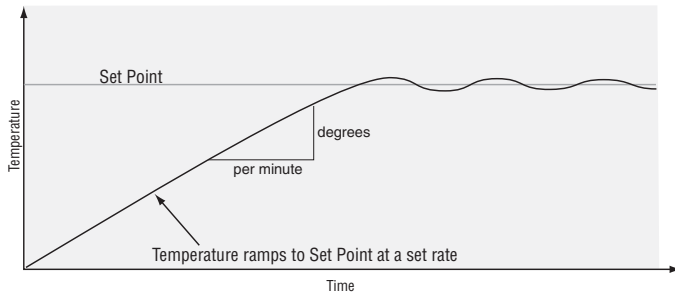

Alarms

Alarms are activated when the output level, process value or temperature leaves a defined range. A user can configure how and when an alarm is triggered, what action it takes and whether it turns off automatically when the alarm condition is over.

Configure alarm outputs in the Setup Page before setting alarm set points.

Alarms do not have to be assigned to an output. Alarms can be monitored and controlled through the front panel or by using software.

Process and Deviation Alarms

A process alarm uses one or two absolute set points to define an alarm condition.

A deviation alarm uses one or two set points that are defined relative to the control set point. High and low alarm set points are calculated by adding or subtracting offset values from the control set point. If the set point changes, the window defined by the alarm set points automatically moves with it.

Select the alarm type with Type **[ALY]** (Setup Page, Alarm Menu).

Alarm Set Points

The alarm high set point defines the process value or temperature that will trigger a high side alarm. It must be higher than the alarm low set point and lower than the high limit of the sensor range.

The alarm low set point defines the temperature that will trigger a low side alarm. It must be lower than the alarm high set point and higher than the low limit of the sensor range.

View or change alarm set points with Low Set Point **[ALO]** and High Set Point **[AHI]** (Operations Page, Alarm Menu).

Alarm Hysteresis

An alarm state is triggered when the process value reaches the alarm high or alarm low set point. Alarm hysteresis defines how far the process must return into the normal operating range before the alarm can be cleared.

Alarm hysteresis is a zone inside each alarm set point. This zone is defined by adding the hysteresis

value to the alarm low set point or subtracting the hysteresis value from the alarm high set point.

View or change alarm hysteresis with Hysteresis **[AHY]** (Setup Page, Alarm Menu).

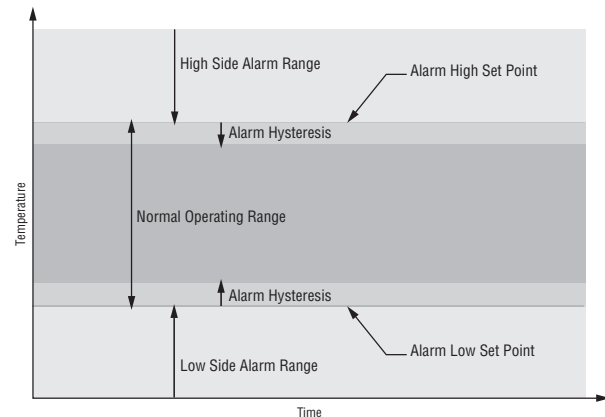

Alarm Latching

A latched alarm will remain active after the alarm condition has passed. It can only be deactivated by the user.

An active message, such as an alarm message, will cause the display to toggle between the normal settings and the active message in the upper display and **[ALEn]** in the lower display.

Push the Advance Key to display **[,9nr]** in the upper display and the message source in the lower display.

Use the Up **[▲]** and Down **[▼]** keys to scroll through possible responses, such as Clear **[CLR]** or Silence **[SIL]**. Then push the Advance **[⊙]** or Infinity **[∞]** key to execute the action.

See the Keys and Displays chapter and the Home Page chapter for more details.

An alarm that is not latched (self-clearing) will deactivate automatically when the alarm condition has passed.

Turn alarm latching on or off with Latching **[ALA]** (Setup Page, Alarm Menu).

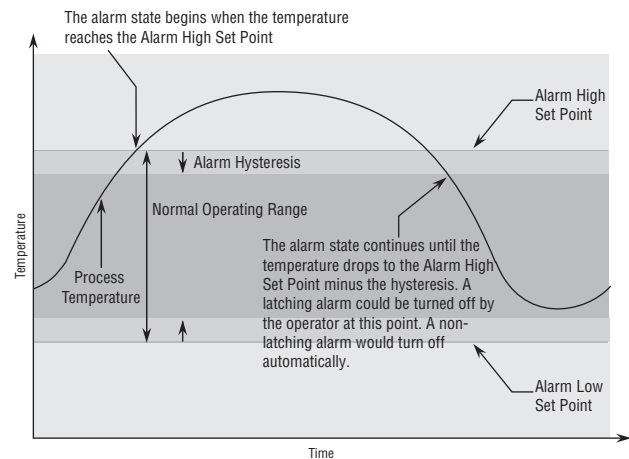

Alarm Silencing

If alarm silencing is on the operator can disable the alarm output while the controller is in an alarm state. The process value or temperature has to enter the normal operating range beyond the hysteresis zone to activate the alarm output function again.

An active message, such as an alarm message, will cause the display to toggle between the normal settings and the active message in the upper display and **ALERT** in the lower display.

Push the Advance Key to display **IGNR** in the upper display and the message source in the lower display.

Use the Up **▲** and Down **▼** keys to scroll through possible responses, such as Clear **CLR** or Silence **SIL**. Then push the Advance **⊙** or Infinity **⊕** key to execute the action.

See the Keys and Displays chapter and the Home Page chapter for more details.

Turn alarm silencing on or off with Silencing **AS** (Setup Page, Alarm Menu).

Alarm Blocking

Alarm blocking allows a system to warm up after it has been started up. With alarm blocking on, an alarm is not triggered when the process temperature is initially lower than the alarm low set point or higher than the alarm high set point. The process temperature has to enter the normal operating range beyond the hysteresis zone to activate the alarm function.

If the EZ-ZONE[®] PM has an output that is functioning as a deviation alarm, the alarm is blocked when the set point is changed, until the process value re-enters the normal operating range.

Turn alarm blocking on or off with Blocking **ABL** (Setup Page, Alarm Menu).

Current Sensing

Open heater circuit detection

Current Error **CEr** (Operations Page, Current Menu) detects an open load circuit if no current is flowing through the current transformer when the output is active and the load is supposed to be on.

Shorted heater circuit detection

Current Error detects a shorted load circuit if current is flowing through the current transformer when the output is inactive and the load is supposed to be off.

Set the current detect set points with High Set Point **Ch**, and Low Set Point **CLo** (Operations Page, Current Menu).

View the current level and most recent faults with Read, Current Error **CEr** (Operations Page, Current Menu) and Heater Error **hEr** (Operations Page, Current Menu).

Programming the EZ Key

You can program the EZ Key either in the Setup Menu or with configuration software, such as EZ-ZONE[®] Configurator, using a personal computer.

The following examples show how to program the EZ Key to start and stop a profile.

Using keys and display:

1. To go to the Setup Page from the Home Page, press both the Up **▲** and Down **▼** keys for six seconds. **A** will appear in the upper display and **SET** will appear in the lower display.
2. Press the Up Key **▲** until **Fun** appears in the upper display and **SET** will appear in the lower display.
3. Press the Advance Key **⊙** until Digital Input Level **LEu** appears in the lower display. Use an arrow key to specify the state of the key (high or low) when the controller is powered up. Functions will toggle with each press of the EZ Key, such as Profile Start/Stop.
4. Press the Advance Key **⊙**. The lower display will show Digital Function **Fn**. Press the Up **▲** or Down **▼** key to scroll through the functions that can be assigned to the EZ Key
When Profile Start/Stop **PSET** appears in the upper display and **Fn** appears in the lower display, press the Advance Key **⊙** once to select that function and move to the Function Instance **F** parameter.
5. Press the Up **▲** or Down **▼** key to scroll to the profile that you want the EZ Key to control.
6. The instance tells the controller which of the numbered functions should be acted upon. For profiles, there are 4 instances. Press the Infinity Key **⊕** once to return to the submenu, twice to return to the main menu or three times to return to the Home Page.

Using the software with Standard Bus:

1. Make the necessary physical connections between the personal computer and the EZ-ZONE[®] PM. Set Protocol (Setup Page, Communications Menu) to Standard Bus. Run the software and allow it to connect to the controller by directing it or allowing it to find the appropriate communications port.
2. After the software connects to the controller, look on the left side of your screen under the Parameters Menus for Function Key under Setup. Click on the plus sign to reveal the Function Key 1 submenu.
3. Click on Function Key 1, then select a Digital Input Function and a Function Instance.

If you want to start and stop a profile with the EZ Key, select Profile Start/Stop and the number of the profile that you want the EZ Key to control.

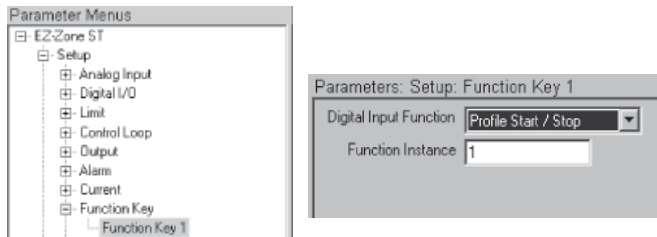

Using Lockout to Secure Settings

If unintentional changes to parameter settings might raise safety concerns or lead to downtime, you can use the lockout feature to make them more secure.

Each of the menus in the Factory Page and each of the pages, except the Factory Page, has a security level assigned to it. You can change the read and write access to these menus and pages by using the parameters in the Lockout Menu (Factory Page).

Lockout Menu

There are four parameters in the Lockout Menu (Factory Page):

Lock Operations Page **[LoLo]** sets the security level for the Operations Page. (default: 2)

Lock Profiling Page **[LoLP]** sets the security level for the Profiling Page. (default: 3)

Read Lockout Security **[rLoL]** determines which pages can be accessed. The user can access the selected level and all lower levels. (default: 5)

Set Lockout Security **[SLoL]** determines which parameters within accessible pages can be written to. The user can write to the selected level and all lower levels. (default: 5)

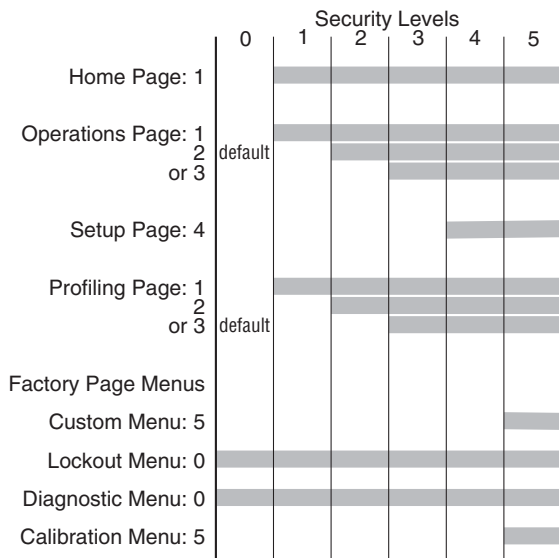

Bars indicate page and menu access by security level.

The following examples show how the Lockout Menu parameters may be used in applications:

1. You can lock out access to the Operations Page but allow an operator access to the Profile Menu, by changing the default Profile Page and Operations Page security levels. Change Lock Operations Page **[LoLo]** to 3 and Lock Profiling Page **[LoLP]** to 2. If Set Lockout Security **[SLoL]** is set to 2 or higher and the Read Lockout Security **[rLoL]** is set to 2, the Profiling Page and Home Pages can be accessed, and all writable parameters can be written to. Pages with security levels greater than 2 will be locked out (unaccessible).
2. If Set Lockout Security **[SLoL]** is set to 0 and Read Lockout Security **[rLoL]** is set to 5, all pages will be accessible, however, changes will not be allowed on any pages or menus, with one exception: Set Lockout Security **[SLoL]** can be changed to a higher level.
3. The operator wants to read all the menus and not allow any parameters to be changed.

In the Factory Page, Lockout Menu, set Read Lockout Security **[rLoL]** to 5 and Set Lockout Security **[SLoL]** to 0.

4. The operator wants to read and write to the Home Page and Profiling Page, and lock all other pages and menus.

In the Factory Page, Lockout Menu, set Read Lockout Security **[rLoL]** to 2 and Set Lockout Security **[SLoL]** to 2.

In the Factory Page, Lockout Menu, set Lock Operations Page **[LoLo]** to 3 and Lock Profiling Page **[LoLP]** to 2.

5. The operator wants to read the Operations Page, Setup Page, Profiling Page, Diagnostics Menu, Lock Menu, Calibration Menu and Custom Menu. The operator also wants to read and write to the Home Page.

In the Factory Page, Lockout Menu, set Read Lockout Security **[rLoL]** to 1 and Set Lockout Security **[SLoL]** to 5.

In the Factory Page, Lockout Menu, set Lock Operations Page **[LoLo]** to 2 and Lock Profiling Page **[LoLP]** to 3.

Note: Avoid continuous writes within loops. Excessive writes to EEPROM will cause premature EEPROM failure. The EEPROM is rated for 1,000,000 writes.

Chapter 10: Appendix

Troubleshooting Alarms, Errors and Control Issues

Indication	Description	Possible Cause(s)	Corrective Action
Alarm won't clear or reset	Alarm will not clear or reset with keypad or digital input	<ul style="list-style-type: none"> Alarm latching is active Alarm set to incorrect output Alarm is set to incorrect source Sensor input is out of alarm set point range Alarm set point is incorrect Alarm is set to incorrect type Digital input function is incorrect 	<ul style="list-style-type: none"> Reset alarm when process is within range or disable latching Set output to correct alarm source instance Set alarm source to correct input instance Correct cause of sensor input out of alarm range Set alarm set point to correct trip point Set alarm to correct type: process, deviation or power Set digital input function and source instance
Alarm won't occur	Alarm will not activate output	<ul style="list-style-type: none"> Alarm silencing is active Alarm blocking is active Alarm is set to incorrect output Alarm is set to incorrect source Alarm set point is incorrect Alarm is set to incorrect type 	<ul style="list-style-type: none"> Disable alarm silencing, if required Disable alarm blocking, if required Set output to correct alarm source instance Set alarm source to correct input instance Set alarm set point to correct trip point Set alarm to correct type: process, deviation or power
AL.E1 Alarm Error AL.E2 AL.E3 AL.E4	Alarm state cannot be determined due to lack of sensor input	<ul style="list-style-type: none"> Sensor improperly wired or open Incorrect setting of sensor type Calibration corrupt 	<ul style="list-style-type: none"> Correct wiring or replace sensor Match setting to sensor used Check calibration of controller
ALL1 Alarm Low ALL2 ALL3 ALL4	Sensor input below low alarm set point	<ul style="list-style-type: none"> Temperature is less than alarm set point Alarm is set to latching and an alarm occurred in the past Incorrect alarm set point Incorrect alarm source 	<ul style="list-style-type: none"> Check cause of under temperature Clear latched alarm Establish correct alarm set point Set alarm source to proper setting
AL.H1 Alarm High AL.H2 AL.H3 AL.H4	Sensor input above high alarm set point	<ul style="list-style-type: none"> Temperature is greater than alarm set point Alarm is set to latching and an alarm occurred in the past Incorrect alarm set point Incorrect alarm source 	<ul style="list-style-type: none"> Check cause of over temperature Clear latched alarm Establish correct alarm set point Set alarm source to proper setting
Er.1 Error Input Er.2	Sensor does not provide a valid signal to controller	<ul style="list-style-type: none"> Sensor improperly wired or open Incorrect setting of sensor type Calibration corrupt 	<ul style="list-style-type: none"> Correct wiring or replace sensor Match setting to sensor used Check calibration of controller
Limit won't clear or reset	Limit will not clear or reset with keypad or digital input	<ul style="list-style-type: none"> Sensor input is out of limit set point range Limit set point is incorrect Digital input function is incorrect 	<ul style="list-style-type: none"> Correct cause of sensor input out of limit range Set limit set point to correct trip point Set digital input function and source instance
L.E1 Limit Error L.E2	Limit state cannot be determined due to lack of sensor input, limit will trip	<ul style="list-style-type: none"> Sensor improperly wired or open Incorrect setting of sensor type Calibration corrupt 	<ul style="list-style-type: none"> Correct wiring or replace sensor Match setting to sensor used Check calibration of controller
L.L1 Limit Low L.L2	Sensor input below low limit set point	<ul style="list-style-type: none"> Temperature is less than limit set point Limit outputs latch and require reset Incorrect alarm set point 	<ul style="list-style-type: none"> Check cause of under temperature Clear limit Establish correct limit set point

Indication	Description	Possible Cause(s)	Corrective Action
[L h I] Limit High [L h 2]	Sensor input above high limit set point	<ul style="list-style-type: none"> • Temperature is greater than limit set point • Limit outputs latch and require reset • Incorrect alarm set point 	<ul style="list-style-type: none"> • Check cause of over temperature • Clear limit • Establish correct limit set point
[L P.o I] Loop Open Error	Open Loop Detect is active and the process value did not deviate by a user-selected value in a user specified period.	<ul style="list-style-type: none"> • Setting of Open Loop Detect Time incorrect • Setting of Open Loop Detect Deviation incorrect • Thermal loop is open • Open Loop Detect function not required but activated 	<ul style="list-style-type: none"> • Set correct Open Loop Detect Time for application • Set correct Open Loop Deviation value for application • Determine cause of open thermal loop: misplaced sensors, load failure, loss of power to load, etc. • Deactivate Open Loop Detect feature
[L P.r I] Loop Reversed Error	Open Loop Detect is active and the process value is headed in the wrong direction when the output is activated based on deviation value and user-selected value.	<ul style="list-style-type: none"> • Setting of Open Loop Detect Time incorrect • Setting of Open Loop Detect Deviation incorrect • Output programmed for incorrect function • Thermocouple sensor wired in reverse polarity 	<ul style="list-style-type: none"> • Set correct Open Loop Detect Time for application • Set correct Open Loop Deviation value for application • Set output function correctly • Wire thermocouple correctly, (red wire is negative)
[r P I] Ramping 1	Controller is ramping to new set point	<ul style="list-style-type: none"> • Ramping feature is activated 	<ul style="list-style-type: none"> • Disable ramping feature if not required
[E UN I] Autotuning 1	Controller is autotuning the control loop	<ul style="list-style-type: none"> • User started the autotune function • Digital input is set to start autotune 	<ul style="list-style-type: none"> • Wait until autotune completes or disable autotune feature • Set digital input to function other than autotune, if desired
No heat/cool action	Output does not activate load	<ul style="list-style-type: none"> • Output function is incorrectly set • Control mode is incorrectly set • Output is incorrectly wired • Load, power or fuse is open • Control set point is incorrect • Incorrect controller model for application 	<ul style="list-style-type: none"> • Set output function correctly • Set control mode appropriately (Open vs Closed Loop) • Correct output wiring • Correct fault in system • Set control set point in appropriate control mode and check source of set point: remote, idle, profile, closed loop, open loop • Obtain correct controller model for application
No Display	No display indication or LED illumination	<ul style="list-style-type: none"> • Power to controller is off • Fuse open • Breaker tripped • Safety interlock switch open • Separate system limit control activated • Wiring error • Incorrect voltage to controller 	<ul style="list-style-type: none"> • Turn on power • Replace fuse • Reset breaker • Close interlock switch • Reset limit • Correct wiring issue • Apply correct voltage, check part number
No Serial Communication	Cannot establish serial communications with the controller	<ul style="list-style-type: none"> • Address parameter incorrect • Incorrect protocol selected • Baud rate incorrect • Parity incorrect • Wiring error • EIA-485 converter issue • Incorrect computer or PLC communications port • Incorrect software setup • Termination resistor may be required 	<ul style="list-style-type: none"> • Set unique addresses on network • Match protocol between devices • Match baud rate between devices • Match parity between devices • Correct wiring issue • Check settings or replace converter • Set correct communication port • Correct software setup to match controller • Place 120 Ω resistor across EIA-485 on last controller

Indication	Description	Possible Cause(s)	Corrective Action
Process doesn't control to set point	Process is unstable or never reaches set point	<ul style="list-style-type: none"> Controller not tuned correctly Control mode is incorrectly set Control set point is incorrect 	<ul style="list-style-type: none"> Perform autotune or manually tune system Set control mode appropriately (Open vs Closed Loop) Set control set point in appropriate control mode and check source of set point: remote, idle, profile, closed loop, open loop
Temperature runaway	Process value continues to increase or decrease past set point.	<ul style="list-style-type: none"> Controller output incorrectly programmed Thermocouple reverse wired Controller output wired incorrectly Short in heater Power controller connection to controller defective Controller output defective 	<ul style="list-style-type: none"> Verify output function is correct (heat or cool) Correct sensor wiring (red wire negative) Verify and correct wiring Replace heater Replace or repair power controller Replace or repair controller
100 Device Error rErr	Controller displays internal malfunction message at power up.	<ul style="list-style-type: none"> Controller defective 	<ul style="list-style-type: none"> Replace or repair controller
hEr Heater Error	Heater Error	<ul style="list-style-type: none"> Current through load is above current trip set point Current through load is below current trip set point 	<ul style="list-style-type: none"> Check that the load current is proper. Correct cause of overcurrent and/or ensure current trip set point is correct. Check that the load current is proper. Correct cause of undercurrent and/or ensure current trip set point is correct.
CEr Current Error	Load current incorrect.	<ul style="list-style-type: none"> Shorted solid-state or mechanical relay Open solid-state or mechanical relay Current transformer load wire associated to wrong output Defective current transformer or controller Noisy electrical lines 	<ul style="list-style-type: none"> Replace relay Replace relay Route load wire through current transformer from correct output, and go to the CS Source Output Instance parameter (Setup Page, Current Menu) to select the output that is driving the load. Replace or repair sensor or controller Route wires appropriately, check for loose connections, add line filters
Menus inaccessible	Unable to access SEt , OPer , FLtY or PrOF menus or particular prompts in Home Page	<ul style="list-style-type: none"> Security set to incorrect level Digital input set to lockout keypad Custom parameters incorrect 	<ul style="list-style-type: none"> Check lockout setting in Factory Page Change state of digital input Change custom parameters in Factory Page
EZ-Key doesn't work	EZ-Key does not activate required function	<ul style="list-style-type: none"> EZ-Key function incorrect EZ-Key function instance not incorrect Keypad malfunction 	<ul style="list-style-type: none"> Verify EZ-Key function in Setup Menu Check that the function instance is correct Replace or repair controller

Specifications

Line Voltage/Power

- 85 to 264V~ (ac), 47 to 63 Hz
- 12 to 40V= (dc); 20 to 28V~ (ac), 47 to 63 Hz
- 10VA maximum power consumption
- Data retention upon power failure via nonvolatile memory
- Compliant with Semi F47-0200, Figure R1-1 voltage sag requirements @ 24~ (ac) or higher



Environment

- -18 to 65°C (0 to 149°F) operating temperature
- -40 to 85°C (-40 to 185°F) storage temperature
- 0 to 90 percent RH, non-condensing

Accuracy

- Calibration accuracy and sensor conformity: ± 0.1 percent of accuracy span, $\pm 1^\circ\text{C}$ at the calibrated ambient temperature and rated line voltage
- Types R, S, B; 0.2 percent
- Type T below -50°C (58°F); 0.2 percent
- Calibration ambient temperature @ 25°C , $\pm 3^\circ\text{C}$ (77°F , $\pm 5^\circ\text{F}$)
- Accuracy span: 540°C ($1,000^\circ\text{F}$) minimum
- Temperature stability: $\pm 0.1^\circ\text{C}/^\circ\text{C}$ ($\pm 0.1^\circ\text{F}/^\circ\text{F}$) rise in ambient maximum
- Process Output: ± 15 mV using 0 to 10 V= (dc), resolution @ 3 mV and ± 30 μA using 0 to 20 mA, resolution @ 6 μA

Agency Approvals

-  UL[®] Listed to UL 61010-1 File E185611.
- UL Reviewed to CSA C22.2 No. 61010-1-04.
- UL 50 Type 4X, NEMA 4X indoor locations, IP66 front panel seal.
- FM Class 3545 File 3029084 temperature limit switches.
- CE – See Declaration of Conformity. RoHS and W.E.E.E. compliant.
- ODVA – EtherNet/IP™ Compliance.
-  UL[®] Listed to ANSI/ISA 12.12.01-2001 File E184390.
- UL reviewed to CSA C22.2 No. 213-1987.
- This equipment is suitable for use in Class I, Division 2, Groups A, B, C and D or Non-Hazardous locations only. Temperature Code T4A.
- WARNING – EXPLOSION HAZARD. Substitution of component may impair suitability for Class I, Division 2.
- WARNING – EXPLOSION HAZARD. Do not disconnect equipment unless power has been switched off or the area is known to be non-hazardous.

Controller

- Microprocessor-based, user-selectable control modes
- PID module: Single universal input, 2 outputs
- Limit module: Single universal input, 2 outputs
- 2 total additional digital input/outputs shared between PID and limit functions
- Control sampling rates: input 10 Hz, outputs 10 Hz

Serial Communications

- Isolated communications EIA-485, Standard Bus: all models; EIA-232/485, Modbus™ RTU and Ethernet IP/Modbus™ TCP serial communications. Future options include DeviceNet™ and Profibus™ DP

Wiring Termination, Touch-Safe Terminals

- Input, power and controller output terminals touch-safe removable 3.30 to 0.0507mm² (12 to 30 AWG)
- Wire strip length 7.6 mm (0.30 in)
- Torque 0.8 Nm (7.0 lb.-in.)

Universal Input

- Thermocouple, grounded or ungrounded sensors
 >20 M Ω input impedance
 Maximum of 2K Ω source resistance
- RTD 2- or 3-wire, platinum, 100 and 1,000 Ω @ 0°C calibration to DIN curve (0.00385 $\Omega/^\circ\text{C}$); lead resistance effect: $0.3^\circ\text{C}/\Omega$ maximum

- Process, 0 to 20 mA @ 100 Ω , or 0 to 10V= (dc) and 0 to 50 mV @ 20 k Ω input impedance; scalable
- Inverse scaling

Accuracy Range

Type J: 0 to 750°C or 32 to $1,383^\circ\text{F}$ ($\pm 1.75^\circ\text{C}$)
Type K: -200 to $1,250^\circ\text{C}$ or -328 to $2,282^\circ\text{F}$ ($\pm 2.45^\circ\text{C}$)
Type T: -200 to 350°C or -328 to 662°F ($\pm 1.55^\circ\text{C}$)
Type E: -328 to $1,652^\circ\text{C}$ or -200 to 900°F ($\pm 2.10^\circ\text{C}$)
Type N: 0 to $1,250^\circ\text{C}$ or 32 to $2,282^\circ\text{F}$ ($\pm 2.25^\circ\text{C}$)
Type C: 0 to $2,315^\circ\text{C}$ or 32 to $4,199^\circ\text{F}$ ($\pm 3.32^\circ\text{C}$)
Type D: 0 to $2,315^\circ\text{C}$ or 32 to $4,199^\circ\text{F}$ ($\pm 3.32^\circ\text{C}$)
Type F: 0 to $1,343^\circ\text{C}$ or 32 to $2,450^\circ\text{F}$ ($\pm 2.39^\circ\text{C}$)
Type R: 0 to $1,450^\circ\text{C}$ or 32 to $2,642^\circ\text{F}$ ($\pm 3.90^\circ\text{C}$)
Type S: 0 to $1,450^\circ\text{C}$ or 32 to $2,642^\circ\text{F}$ ($\pm 3.90^\circ\text{C}$)
Type B: 870 to $1,700^\circ\text{C}$ or 1,598 to $3,092^\circ\text{F}$ ($\pm 2.66^\circ\text{C}$)
RTD (DIN): -200 to 800°C or -328 to $1,472^\circ\text{F}$ ($\pm 2.00^\circ\text{C}$)
Volts: 0 to 10 ($\pm 0.01\text{V}$)
mA DC: 0 to 20 (± 0.02 mA)
mV: 0 to 50 (± 0.05 mV)
Potentiometer: 0 to 1,200 Ω (± 1.0 Ω)

Functional Operating Range

Type J: -210 to $1,200^\circ\text{C}$ or -346 to $2,192^\circ\text{F}$
Type K: -200 to $1,370^\circ\text{C}$ or -328 to $2,500^\circ\text{F}$
Type T: -200 to 400°C or -328 to 750°F
Type E: -200 to $1,000^\circ\text{C}$ or -328 to $1,832^\circ\text{F}$
Type N: -200 to $1,300^\circ\text{C}$ or -328 to $2,372^\circ\text{F}$
Type C: 0 to $2,315^\circ\text{C}$ or 32 to $4,200^\circ\text{F}$
Type D: 0 to $2,315^\circ\text{C}$ or 32 to $4,200^\circ\text{F}$
Type F: 0 to $1,395^\circ\text{C}$ or 32 to $2,543^\circ\text{F}$
Type R: -50 to $1,767^\circ\text{C}$ or -58 to $3,214^\circ\text{F}$
Type S: -50 to $1,767^\circ\text{C}$ or -58 to $3,214^\circ\text{F}$
Type B: 0 to $1,816^\circ\text{C}$ or 32 to $3,300^\circ\text{F}$
RTD (DIN): -200 to 800°C or -328 to $1,472^\circ\text{F}$
Process: -1,999 to 9,999 units

Digital Input

- Update rate 10 Hz
- Dry contact or dc voltage

DC voltage

- Maximum input 36V at 3 mA
- Minimum high state 3V @ 0.25 mA
- Maximum low state 2V

Dry contact

- Minimum open resistance 10 k Ω
- Maximum closed resistance 50 Ω
- Maximum short circuit 13 mA

Digital Output

- Update rate 10 Hz
- Output voltage 24V
- Current limit, Output 5, 24 mA maximum; Output 6, 10 mA maximum

Current Measurement

- Requires optional current transformer 16-0246
- Accepts 0 to 50 mA signal (user programmable range) 2 to 50A usable
- Displayed operating range and resolution can be scaled and are user programmable.

Output Hardware

- User selectable for heat-cool as on-off, P, PI, PD, PID, alarm action or limit.

Switched DC

- Unregulated 22 to 32V= (dc) low side @ 30 mA outputs 1 and 3, 10 mA outputs 2 and 4

Open Collector

- Output sink 100 mA @ 30V= (dc) maximum

Solid-State Relay

- 0.5 A @ 24 to 264V~ (ac) maximum, opto-isolated, without contact suppression; maximum off-state leakage current: 105 micro-amperes

Electromechanical Relay, Form A

- 5 A, 24 to 240V~ (ac) or 30V= (dc) maximum, resistive load, 100,000 cycles at rated load, 125 VA pilot duty
- Requires a minimum load of 20 mA @ 24V

Electromechanical Relay, Form C

- 5 A, 24 to 240V~ (ac) or 30V= (dc) maximum, resistive load, 100,000 cycles at rated load, 125 VA pilot duty
- Requires a minimum load of 20 mA @ 24V

No-arc Relay Form A

- 15 A, 85 to 264V~ (ac), no V= (dc), resistive load, 2 million cycles at rated load (preliminary), maximum off-state leakage current: 2 mA

Process

- Universal process/Retransmit, outputs range selectable, 0 to 10 V= (dc) into minimum 1,000 Ω load, 0 to 20 mA into maximum 800 Ω load

Operator Interface

- Dual 4-digit, 7-segment LED displays
- Advance, infinity, up and down keys plus an EZ Key programmable function key
- Typical display update rate 1Hz
- Agency approved to IP66/NEMA 4X

Dimensions

Size	Behind Panel (max.)	Width	Height	Display Height
1/16	101.6 mm (4.00 in)	53.3 mm (2.10 in)	53.3 mm (2.10 in)	up: 10.80 mm (0.425 in) low: 6.98 mm (0.275 in)

Weight

- Controller: 200 g (7.1 oz.)
- User manual: 167.26 g (5.9 oz)

Modbus® is a trademark of AEG Schneider Automation Inc.

EtherNet/IP™ is a trademark of ControlNet International Ltd. used under license by Open DeviceNet Vendor Association, Inc. (ODVA).

UL® is a registered trademark of Underwriters Laboratories Inc.

DeviceNet™ is a trademark of Open DeviceNet Vendors Association.

Note: These specifications are subject to change without prior notice.

Ordering Information for Integrated Controller Models

Controller

EZ-ZONE® Integrated Controller Models
 Universal Sensor Input, configuration communications
 TRU-TUNE+® Adaptive Tune, red-green 7-segment displays

P M 6

A

Package Size

6 1/16 DIN

Primary Function

C PID Controller
 R Ramp and Soak
 S Custom Firmware

Power Supply, Digital Input/Output

1 100 to 240V~ (ac)
 2 100 to 240V~ (ac) plus 2 digital i/o points
 3 12 to 40V= (dc) and 20 to 28V~ (ac)
 4 12 to 40V= (dc) and 20 to 28V~ (ac), plus 2 digital i/o points

Output 1 and 2 Hardware Options

	Output 1	Output 2
CA	Switched dc/open collector	None
CH	Switched dc/open collector	No-arc 15 A power control
CC	Switched dc/open collector	Switched dc
CJ	Switched dc/open collector	Mechanical relay 5 A, form A
CK	Switched dc/open collector	Solid-state relay 0.5 A, form A
EA	Mechanical relay 5 A, form C	None
EH	Mechanical relay 5 A, form C	No-arc 15 A power control
EC	Mechanical relay 5 A, form C	Switched dc
EJ	Mechanical relay 5 A, form C	Mechanical relay 5 A, form A
EK	Mechanical relay 5 A, form C	Solid-state relay 0.5 A, form A
FA	Universal process	None
FC	Universal process	Switched dc (cannot use variable time base)
FJ	Universal process	Mechanical relay 5 A, form A (cannot use variable time base)
FK	Universal process	Solid-state relay 0.5 A, form A (cannot use variable time base)
AK	None	Solid-state relay 0.5 A, form A
KK	Solid-state relay 0.5 A, form A	Solid-state relay 0.5 A, form A
KH	Solid-state relay 0.5 A, form A	No-arc 15 A power control

Communications Options

All options below include EIA-485 Standard Bus.

A None
 1 EIA 485 Modbus RTU®
 With options 2 or 3, order option AA for outputs 3 & 4.
 2 Modbus RTU 232/485
 3 EtherNet/IP™, Modbus TCP

Auxiliary Control Functions

With Communications Options 2 to 6, option A must be ordered below.

A None
 R Remote Set point input
 T Current Transformer Input (no Output 3 & 4 Option FA, FC, FJ or FK)
 L Integrated Limit Controller with universal input (outputs 3 & 4 Option CJ, EJ or AJ only)

Output 3 and 4 Hardware Options

With Communications Options 2 or 3, option AA must be ordered below.

	Output 3	Output 4
AA	None	None
AJ	None	Mechanical relay 5 A, form A
CA	Switched dc/open collector	None
CC	Switched dc/open collector	Switched dc
CJ	Switched dc/open collector	Mechanical relay 5 A, form A
CK	Switched dc/open collector	Solid-state relay 0.5 A, form A
EA	Mechanical relay 5 A, form C	None
EC	Mechanical relay 5 A, form C	Switched dc
EJ	Mechanical relay 5 A, form C	Mechanical relay 5 A, form A
EK	Mechanical relay 5 A, form C	Solid-state relay 0.5 A, form A
FA	Universal Process	None
FC	Universal Process	Switched dc (cannot use variable time base)
FJ	Universal Process	Mechanical relay 5 A, form A (cannot use variable time base)
FK	Universal Process	Solid-state relay 0.5 A, form A (cannot use variable time base)
AK	None	Solid-state relay 0.5 A, form A
KK	Solid-state relay 0.5 A, form A	Solid-state relay 0.5 A, form A

Future Options

Additional Options

AA Standard EZ-ZONE® face plate
 12 Class 1, div. 2 (not available with Integrated Limit Controller or mechanical relay outputs)

Note: The model of controller that you have is one of many possible models in the EZ-ZONE® PM family of controllers. To view the others, visit our website (http://www.watlow.com/literature/pti_search.cfm) and type EZ-ZONE® into the Keyword field.

Index

- AbL** Alarm Blocking 41, 64
- ACLF** AC Line Frequency 42, 62
- ACSP** Active Set Point 32
- AdM** Address Modbus 43
- AdS** Address Standard Bus 43
- AdSP** Alarm Display 41
- Ah** Alarm High Set Point 31, 63
- AHy** Alarm Hysteresis 41, 63
- A** Analog Input Menu 29, 34
- AIN** Process Value 29
- ALA** Alarm Latching 41, 63
- ALE1** **ALE2** **ALE3** **ALE4**
Alarm Error 1 to 4 24, 27
- AL9** Alarm Logic 41
- ALh1** **ALh2** **ALh3** **ALh4**
Alarm High 1 to 4 24, 27
- ALL1** **ALL2** **ALL3** **ALL4**
Alarm Low 1 to 4 24, 27
- ALM** Alarm Menu 31, 40
- ALo** Alarm Low Set Point 31, 63
- ASd** Alarm Sides 41
- AS** Alarm Silencing 41, 64
- AtSP** Autotune Set Point 30, 54
- Attn** Attention 24, 26, 27, 63, 64
- AtY** Alarm Type 40, 63
- AUT** Autotune 30, 54
- AUT1** Autotune, Home Page 26
- BAUD** Baud Rate 43
- CA9** Cool Algorithm 37, 60
- CAL** Calibration Menu 52
- CCr** Cool Output Curve 37, 59
- CdE** Current Detect Threshold 41
- CEr** Current Error 24, 27, 31, 64
- C_F** Display Units 42
- Ch** Current High Set Point 31, 64
- Chy** Cool Hysteresis 30, 60
- CLED** Communications Indicator Light 52
- CLo** Current Low Set Point 31, 64
- CM** Control Mode 30, 60
- CM1** Control Mode, Home Page 26
- CMAR** Control Mode Active 29
- COFS** Current Offset 41
- COM** Communications Menu 43
- CPb** Cool Proportional Band 30, 55, 61
- CPr** Cool Power 29, 55
- CPr1** Cool Power, Home Page 26
- CS** Scaling 41
- CSd** Current Sides 41
- CS** Current Source Output Instance 42
- CSP** Closed Loop Set Point 30
- CSP** Closed Loop Working Set Point 29
- CUr** Current Read 31
- CUr** Current Reading Enable 41
- CUrr** Current Menu 31, 41
- CUSE** Custom Menu 26, 50, 54
- DATE** Date of Manufacture 51
- db** Dead Band 31, 62
- DEC** Decimal 35
- dM9** Diagnostics Menu 51
- dio** Digital Input/Output Menu 29
- dir** Direction 35
- doS** Digital Output State 29
- E,PE** Ethernet/IP™ Enable 44
- E,S** Event Input Status 29
- ELo** Electrical Input Offset 52, 56
- EL,S** Electrical Input Slope 52, 56
- ELoO** Electrical Output Offset 52
- ELoS** Electrical Output Slope 52
- End** End 48
- End** End Type 47
- Ent1** Active Event Output 1 32
- Ent1** Event Output 1 47
- Ent2** Active Event Output 2 32
- Ent2** Event Output 2 47
- Er.1** **Er.2** Error Input 1 or 2 24, 27
- FRIL** Input Error Failure 38, 59
- FIL** Filter 35
- F** Digital Input Function Instance 36
- F** Function Key Instance 42
- F** Digital Output Function Instance 35
- F** Output Function Instance 39, 40
- Fn** Digital Input Function 36, 42
- Fn** Digital Output Function 35
- Fn** Output Function 39, 40, 55
- FUn** Function Key Menu 42
- GLbL** Global Menu 42
- 95d** Guaranteed Soak Deviation 43
- 95E** Guaranteed Soak Enable 43
- hA9** Heat Algorithm 37, 60
- HEr** Heater Error 24, 27, 31, 64
- hhY** Heat Hysteresis 30, 60
- hoUr** Hours 47
- hPb** Heat Proportional Band 30, 55, 61
- hPr** Heat Power 29, 55
- hPr1** Heat Power, Home Page 26
- hSP** Control Loop High Set Point 38
- LA** Calibration Offset 29, 56–57
- IdS** Idle Set Point 30
- IdS1** Idle Set Point, Home Page 26
- IEr** Input Error Latching 35
- IEr** Input Error Status 29
- Id** Instance 50
- IPR1** IP Actual Address Part 1 51
- IPR2** IP Actual Address Part 2 51
- IPR3** IP Actual Address Part 3 52
- IPR4** IP Actual Address Part 4 52
- IFF1** IP Fixed Address Part 1 43
- IFF2** IP Fixed Address Part 2 43
- IFF3** IP Fixed Address Part 3 44
- IFF4** IP Fixed Address Part 4 44
- IPG1** IP Fixed Gateway Part 1 44
- IPG2** IP Fixed Gateway Part 2 44
- IPG3** IP Fixed Gateway Part 3 44
- IPG4** IP Fixed Gateway Part 4 44
- IPM** IP Address Mode 43
- IPS1** IP Fixed Subnet Part 1 44
- IPS2** IP Fixed Subnet Part 2 44
- IPS3** IP Fixed Subnet Part 3 44
- IPS4** IP Fixed Subnet Part 4 44
- ISA** Alarm Source Instance 40
- JC** Jump Count 47
- JC** Jump Count Remaining 32
- JL** Jump Loop 48
- JS** Jump Step 47
- LEu** Digital Input Level 36, 42
- Ldd** Open Loop Detect Deviation 38
- LdE** Open Loop Detect Enable 38
- LdE** Open Loop Detect Time 38
- LhS** Limit High Set Point 29
- LhY** Limit Hysteresis 36
- LE1** **LE2** Limit Error 1 or 2 24, 27
- Lh1** **Lh2** Limit High 1 or 2 24, 27
- Ll1** **Ll2** Limit Low 1 or 2 24, 27
- LM** Limit Menu 29, 36
- Lin** Linearization 34
- LIt** Limit Integrate 37
- LLS** Limit Low Set Point 29
- LoC** Lockout Menu 50
- LoCo** Lock Operations Page 50, 65
- LoCP** Lock Profiling Page 50, 65
- Loop** Loop Menu 30, 37
- LPo1** Loop Open Error 24, 27
- LPr1** Loop Reversed Error 24, 27
- LSd** Limit Sides 36
- LSP** Loop Low Set Point 38
- MAN** Manual Power 38
- MBE** Modbus TCP Enable 44
- MhL** Modbus Word Order 43
- MIn** Minutes 47
- MOn** Monitor Menu 29
- MU** Electrical Measurement 52, 56
- oCA** Calibration Offset 39
- oCE** Output Control 35, 40
- oh** Output High Power Scale 35, 39, 40
- oLo** Output Low Power Scale

- 35, 39, 40
 - oP** Open Loop Set Point 31
 - o.t.b** Output Time Base 35, 40
 - o.t.P.t** Output Menu 39
 - o.t.Y** Output Type 39
 - P.A.C.I** Profile Action Request 27
 - P.A.C.I** Profile Action Request, Home Page 26
 - P.A.C.r** Profile Action Request 32
 - P.A.r** Parameter 1 to 20 50
 - P.A.r** Parity 43
 - P.C.o.L** Protocol 43
 - P.E.E** Process Error Enable 34
 - P.E.L** Process Error Low 35
 - P.n** Part Number 51
 - P.r.o.F** Profile 46
 - P.S.E.I** Profile Start 27
 - P.S.E.I** Profile Start, Home Page 26
 - P.S.E.A** Profile Status Menu 31
 - P.S.E.r** Profile Start 32
 - P.E.Y.P** Profile Type 43
 - P.u.A** Process Value Active 29
 - r.A.E.E** Rate 47, 48
 - r.E.n** Remote Enable 30, 58
 - r.E.u** Software Revision 51
 - r.h.i** Range High 34, 39, 57
 - r.L.o** Range Low 34, 39, 57
 - r.L.o.C** Read Lockout Security 51, 65
 - r.P** Ramp Action 38, 62
 - r.P.I** Ramping 24, 27
 - r.r.t** Ramp Rate 38, 62
 - r.S.C** Ramp Scale 38, 62
 - r.S.r** Retransmit Source 39
 - r.t.L** RTD Leads 34
 - r.t.Y** Remote Set Point Type 30
 - S.b.A** Sensor Backup Enable 35, 57
 - S.b.L.d** Software Build 51
 - S.E.C** Seconds 47
 - S.E.n** Sensor Type 34, 55, 57
 - S.h.i** Scale High 34, 39, 57
 - S.L.o** Scale Low 34, 39, 57
 - S.L.o.C** Set Lockout Security 51, 65
 - S.n** Serial Number 51
 - S.o.A.h** Soak 48
 - S.P.h.i** Set Point High Limit Open Loop 38
 - S.P.L.o** Set Point Low Limit Open Loop 38
 - S.r.A** Alarm Source 34
 - S.E.E.P** Step 46
 - S.t.i** Step Time Remaining 32
 - S.E.P** Active Step 32
 - S.E.Y.P** Active Step Type 32
 - S.E.Y.P** Step Type 46
 - t.A.g.r** User Tune Aggressiveness 37, 54
 - t.b.n.d** TRU-TUNE+® Band 37, 55
 - t.d** Time Derivative 30, 55, 61
 - t.g.n** TRU-TUNE+® Gain 37, 55
 - t.g.s.p** Active Target Set Point 32
 - t.g.s.p** Target Set Point 46
 - t.i** Time 48
 - t.i** Time Integral 30, 55, 61
 - t.t.U.n** TRU-TUNE+® Enable 37, 55
 - t.U.n.i** Tuning 24, 27
 - U.F.A** User Failure Action 37
 - U.S.r.r** User Restore Set 51, 54
 - U.S.r.S** User Save Set 51, 54
 - U.S.E.P** Unused Step 48
 - W.J.b.o** Wait For Both 48
 - W.J.E** Wait For Event 48
 - W.J.E.1** Wait Event 1 47
 - W.J.E.2** Wait Event 2 47
 - W.J.P.i** Wait For Process Instance 47
 - W.J.P.r** Wait For Process 48
 - W.J.P.r** Wait For Process 47
- ## A
- accuracy 69
 - Active Event Output (1 or 2) 32
 - Active Process Value Home Page 26
 - Active Set Point 32 Home Page 26
 - Active Step 32
 - Active Step Type 32
 - Active Target Set Point 32
 - AC Line Frequency 42, 62
 - adaptive tuning 55
 - Address Modbus 43
 - Address Standard Bus 43
 - Advance Key 24
 - agency approvals 2, 69
 - alarms 63
 - Blocking 41, 64
 - deviation 63
 - Display 41
 - Hysteresis 41, 63
 - Latching 41, 63
 - Logic 41
 - process 63
 - set points 63
 - Sides 41
 - Silencing 41, 64
 - Source 40
 - Source Instance 40
 - Type 40
 - alarm blocking 64
 - Alarm Error 1 to 4 24
 - Alarm High 1 to 4 24
 - Alarm Low 1 to 4 24
 - Alarm Menu 31, 40
 - Operations Page 28
 - Setup Page 33
 - Analog Input Menu 29, 34
 - Operations Page 28
 - Setup Page 33
- ## B
- Baud Rate 43
 - Blocking 41, 64
 - bumpless transfer 59
- ## C
- calibrating an analog input 56
 - Calibration Menu 52
 - Factory Page 49
 - Calibration Offset 29, 39, 56–57
 - changing the set point 26
 - chattering output 60
 - chemical compatibility 10
 - Closed Loop Set Point 30
 - Closed Loop Working Set Point 29
 - communications activity light 24
 - Communications Indicator Light 52
 - Communications Menu 43
 - Setup Page 33
 - Control 35, 40
 - controller specifications 69
 - control methods 59
 - Control Mode 30, 60
 - Home Page 26
 - Control Mode Active 29
 - Cool Algorithm 37, 60
 - Cool Hysteresis 30, 60
 - Cool Output Curve 37, 59
 - cool output curve 59
 - Cool Power 29, 55
 - Home Page 26
 - Cool Proportional Band 30, 55, 61
 - Current Error 24, 31, 64
 - current measurement 69
 - Current Menu 31, 41
 - Operations Page 28
 - Setup Page 33
 - Current Sensing 64
 - current sensing 64
 - Custom Menu 26, 50, 54
 - Factory Page 49
 - Home Page 26
- ## D
- Date of Manufacture 51
 - Dead Band 31, 61, 62
 - Decimal 35
 - Declaration of Conformity 76
 - default Home Page parameters 26
 - Detect Threshold 41

deviation alarms 63
Diagnostics Menu 51
 Factory Page 49
Digital Input/Output Menu 29, 35
 Operations Page 28
 Setup Page 33
digital inputs 3
Digital Input Function 3, 42
digital input specifications 69
digital output specifications 69
dimensions 8, 70
Direction 35
Display 41
displays 24
Display Units 42
Down Key 24
duplex 58

E

Electrical Gain 56
Electrical Input Offset 52
Electrical Input Slope 52
Electrical Measurement 52, 56
Electrical Output Offset 52
Electrical Output Slope 52
End 48
End Set Point Value 47
environment 69
Error Input 1 or 2 24
EtherNet/IP™ 23
Ethernet/IP™ Enable 44
Event Input Status 29
Event Output (1 and 2) 47
EZ Key 24, 64

F

Factory Page 49
Filter Time 35, 57
filter time constant 57
Function 36, 55
Function Instance 35, 39, 40
Function Key Menu 42, 64
 Setup Page 33

G

Global Menu 42
 Setup Page 33
Guaranteed Soak Deviation 43
Guaranteed Soak Enable 43

H

Heater Error 24, 31, 64
Heat Algorithm 37, 60
Heat Hysteresis 30, 60
Heat Power 29, 55
 Home Page 26
Heat Proportional Band 30, 55, 61
High Power Scale 35, 39, 40
high range 57
high scale 57
High Set Point

Alarm 31, 63
 Current 31, 64
 Limit 29
 Loop 38, 57
Home Page 26, 54
 default display 26
Hours 47
Hysteresis 36, 41, 63

I

Integrate 37
Idle Set Point 30
 Home Page 26
Infinity Key 24
inputs 3
Input Error Failure 38, 59
Input Error Latching 35, 60
Input Error Status 29
input events 3
Input Function Instance 36
Input Sensor Type 55
installation 9
Instance 42, 50
IP Actual Address Part 1 51
IP Actual Address Part 2 51
IP Actual Address Part 3 52
IP Actual Address Part 4 52
IP Address Mode 43
IP Fixed Address Part 1 43
IP Fixed Address Part 2 43
IP Fixed Address Part 3 44
IP Fixed Address Part 4 44
IP Fixed Gateway Part 1 44
IP Fixed Gateway Part 2 44
IP Fixed Gateway Part 3 44
IP Fixed Gateway Part 4 44
IP Fixed Subnet Part 1 44
IP Fixed Subnet Part 2 44
IP Fixed Subnet Part 3 44
IP Fixed Subnet Part 4 44

J

Jump Count 47
Jump Count Remaining 32
Jump Loop 48
Jump Step 47

K

keys 24

L

Latching 41, 63
Level 36, 42
Limit Error 1 or 2 24
Limit High 1 or 2 24
Limit Low 1 or 2 24
Limit Menu 29, 36
 Operations Page 28
 Setup Page 33
Linearization 34
line voltage/power 69

Lockout Menu 50, 65
 Factory Page 49
Lock Operations Page 50, 65
Lock Profiling Page 50, 65
Logic 41
Loop Menu 30, 37
 Operations Page 28
 Setup Page 33
Loop Open Error 24
Loop Reversed Error 24
lower display 24
Low Power Scale 35, 39, 40
low range 57
low scale 57
Low Set Point
 Alarm 31, 63
 Current 31, 64
 Limit 29
 Loop 38, 57

M

manual (open loop) control 59
Manual Control Indicator Light 60
Manual Power 38
manual tuning 54
message, display 24
Message Action 27
Minutes 47
Modbus TCP 23
Modbus TCP Enable 44
Modbus Word Order 43
Monitor Menu 29
 Operations Page 28

N

navigating
 Factory Page 49
 Operations Page 28
 pages and menus 25
 Profiling Page 45
 Setup Page 33
network wiring 23
No-arc Relay 58

O

Offset 41
on-off control 60
Open Loop Detect Deviation 38
Open Loop Detect Enable 38
Open Loop Detect Time 38
Open Loop Set Point 31
Operations Page 28, 50
operator interface 70
ordering information
 integrated controller models 71
outputs 3
output activity lights 24
output configuration 59
output events 3
Output Function 35, 39, 40
output hardware specifications 69

Output Menu 39
 Setup Page 33
output power scaling 59
Output State 29
Output Type 39

P, Q

P3T armor sealing system 2
Parameter 1 to 20 50
Parity 43
Part Number 51
percent units indicator light 24
process alarms 63
Process Error Enable 34
Process Error Low 35
Process Value 29
Process Value Active 29
Profile 46
 Profile Action 26
 Profile Action Request 32
 Home Page 27
 profile activity light 24
 Profile Start 27, 32
 Home Page 26
 Profile Status Menu 31
 Operations Page 28
 Profile Type 43
 Profiling Page 45, 50
 programming the Home Page 54
 proportional control 60
 plus integral (PI) control 61
 plus integral plus derivative (PID)
 control 61
Protocol 43

R

Ramp Action 38
Ramp Rate 38, 62
Ramp Scale 38, 62
Range High 34, 39, 57
Range Low 34, 39, 57
Rate 47, 48
Read 31, 64
Reading Enable 41
Read Lockout Security 51, 65
receiving a remote set point 57
Remote Enable 30, 58
Remote Set Point Type 30
restoring user settings 54
retransmit 58
Retransmit Source 39
RTD Leads 34

S

saving user settings 54
Scale High 34, 39, 57
Scale Low 34, 39, 57
Scaling 41
Seconds 47
secure settings 65
sensor backup 57

Sensor Backup Enable 35, 57
sensor selection 57
Sensor Type 34, 55, 57
serial communications 69
Serial Number 51
Setup Page 33
Set Lockout Security 51, 65
set point high limit 57
Set Point High Limit Open Loop 38
set point low limit 57
Set Point Low Limit Open Loop 38
Sides
 Alarm 41
 Current 41
 Limit 36, 37
Silencing 41, 64
single set point ramping 62
Soak 48
Software Build 51
Software Revision 51
Source 40
Source Output Instance 42
specifications 69
Step 46
Step Time Remaining 32
Step Type 46

T

Target Set Point 46
temperature units indicator lights 24
Time 48
Time Base 35, 40
Time Derivative 30, 55, 61
Time Integral 30, 55, 61
troubleshooting 66
TRU-TUNE+® Band 37, 55
TRU-TUNE+® Enable 37, 55
TRU-TUNE+® Gain 37, 55
tuning the PID parameters 54
Type 40, 63

U

universal input 69
Unused Step 48
upper display 24
Up Key 24
User Failure Action 37
User Restore Set 51, 54
User Save Set 51, 54
User Tune Aggressiveness 54
using the software 64

V

variable time base 62

W, X, Y

Wait Event (1 and 2) 47
Wait For Both 48
Wait For Event 48
Wait For Process 47, 48
Wait For Process Instance 47

weight 70
wiring
 digital input or output 5 13
 digital input or output 6 13
 EIA-232/485 Modbus RTU commu-
 nications 22
 high power 13
 input 1 potentiometer 14
 input 1 process 14
 input 1 RTD 14
 input 1 thermocouple 14
 input 2 current transformer 16
 input 2 potentiometer 15
 input 2 process 15
 input 2 RTD 15
 input 2 thermocouple 15
 low power 13
 Modbus RTU or standard bus
 EIA-485 communications 22
 output 1 mechanical relay, form C
 17
 output 1 solid-state relay, form A
 18
 output 1 switched dc/open collec-
 tor 17
 output 1 universal process 17
 output 2 mechanical relay, form
 A 18
 output 2 no-arc relay, form A 18
 output 2 solid-state relay, form A
 19
 output 2 switched DC/open collec-
 tor 18
 output 3 mechanical relay, form C
 19
 output 3 solid-state relay, form A
 20
 output 3 switched dc/open collec-
 tor 19
 output 3 universal process 20
 output 4 mechanical relay, form
 A 20
 output 4 solid-state relay, form A
 21
 output 4 switched DC/solid-state
 relay 20
 standard bus EIA-485 communica-
 tions 22
 wiring a network 23
 wiring termination, touch-safe termi-
 nals 69

Z

zone display 24

Declaration of Conformity

Series EZ Zone PM



Watlow Winona, Inc.
1241 Bundy Blvd.
Winona, MN 55987 USA

Declares that the following product:

Designation: **Series EZ Zone PM (Panel Mount)**
Model Numbers: PM (3 or 6)(Any letter or number) – (1, 2, 3 or 4)(A, C, E, F or K)
(A, C, H, J or K)(Any letter or number) – (Any letter or number)
(A, C, E, F or K)(A, D, J or K)(Any two letters or numbers)
Classification: Temperature control, Installation Category II, Pollution degree 2
Rated Voltage and Frequency: 100 to 240 V~ ac 50/60 Hz or 15 to 36 V= dc/24 V~ ac 50/60 Hz
Rated Power Consumption: 10 VA maximum.
Environmental Rating: Front Panel IP66

Meets the essential requirements of the following European Union Directives by using the relevant standards show below to indicate compliance.

2004/108/EC Electromagnetic Compatibility Directive

EN 61326	1997	A1:1998 A2:2002	Electrical equipment for measurement, control and laboratory use – EMC requirements (Industrial Immunity, Class B Emissions)
EN 61000-4-2	1996	A1, A2, 2001	Electrostatic Discharge Immunity
EN 61000-4-3	2002	A1, A2, 2005	Radiated Field Immunity
EN 61000-4-4	2004		Electrical Fast-Transient / Burst Immunity
EN 61000-4-5	1995	A1, A2, 2001	Surge Immunity
EN 61000-4-6	1996	A1,A2,A3, 2005	Conducted Immunity
EN 61000-4-11	2004		Voltage Dips, Short Interruptions and Voltage Variations Immunity
EN 61000-3-2	2000	ED.2.	Harmonic Current Emissions
EN 61000-3-3 ¹	1995	A1, A2, 2002	Voltage Fluctuations and Flicker

¹For mechanical relay loads, cycle time may need to be extended up to 30 seconds to meet flicker requirements depending on load switched and source impedance.

73/23/EEC Low-Voltage Directive

EN 61010-1	2001	Safety Requirements of electrical equipment for measurement, control and laboratory use. Part 1: General requirements
-------------------	-------------	--

Compliant with 2002/95/EC RoHS Directive

2002/96/EC WEEE Directive



Equipment Requires Recycling

Raymond D. Feller III
Name of Authorized Representative

Winona, Minnesota, USA
Place of Issue

General Manager
Title of Authorized Representative

August, 2007
Date of Issue

Signature of Authorized Representative

How to Reach Us

Corporate Headquarters

Watlow Electric Manufacturing Company
12001 Lackland Road
St. Louis, MO 63146
Sales: 1-800-WATLOW2
Manufacturing Support: 1-800-4WATLOW
Email: info@watlow.com
Website: www.watlow.com
From outside the USA and Canada:
Tel: +1 (314) 878-4600
Fax: +1 (314) 878-6814

Latin America

Watlow de México S.A. de C.V.
Av. Fundición No. 5
Col. Parques Industriales
Querétaro, Qro. CP-76130
Mexico
Tel: +52 442 217-6235
Fax: +52 442 217-6403

Europe

Watlow France SARL
Immeuble Somag
16, Rue Ampère
95307 Cergy-Pontoise CEDEX
France
Tel: + 33 (0)1 30 73 24 25
Fax: + 33 (0)1 30 73 28 75
Email: info@watlow.fr
Website: www.watlow.fr

Watlow GmbH
Postfach 11 65, Lauchwasenstr. 1
D-76709 Kronau
Germany
Tel: +49 (0) 7253 9400-0
Fax: +49 (0) 7253 9400-900
Email: info@watlow.de
Website: www.watlow.de

Watlow Italy S.r.l.
Viale Italia 52/54
20094 Corsico MI
Italy
Tel: +39 024588841
Fax: +39 0245869954
Email: italyinfo@watlow.com
Website: www.watlow.it

Watlow Ibérica, S.L.U.
CME - Avda. de la Vía Láctea, s/n. Oficina 24
28830 - San Fernando de Henares Madrid
Spain
Tel: +34.91.675.1292
Fax: +34.91.648.7380
Email: info@watlow.es
Website: www.watlow.es

Watlow
Storgatan 24
302 43 Halmstad
Sweden
Tel: + 46 (0)35 27 11 66
Fax: +46 (0)35 27 11 67
Email: info@watlow.se
Website: www.watlow.se

Watlow UK Ltd.
Linby Industrial Estate
Linby, Nottingham, NG15 8AA
United Kingdom
Telephone: (0) 115 964 0777
Fax: (0) 115 964 0071
Email: info@watlow.co.uk
Website: www.watlow.co.uk
From outside The United Kingdom:
Tel: +44 115 964 0777
Fax: +44 115 964 0071

Asia and Pacific

Watlow Singapore Pte Ltd.
16 Ayer Rajah Crescent,
#06-03/04,
Singapore 139965
Tel: +65 6773 9488 Fax: +65 6778 0323
Email: info@watlow.com.sg Website: www.watlow.com.sg

Watlow Australia Pty., Ltd.
4/57 Sharps Road
Tullamarine, VIC 3043
Australia
Tel: +61 3 9335 6449
Fax: +61 3 9330 3566
Website: www.watlow.com

瓦特隆电子科技(上海)有限公司
(销售办事处)
上海市浦东新区张江工业园区碧波路115号572弄22棟 *
邮编: 201203
电话: 86 21 5080-0902 传真: 86 21 5080-0906
电子邮箱: info@watlow.cn Website: www.watlow.cn

Watlow Electric Manufacturing (Shanghai) Company
115-22#, 572nd Lane, Bibo Road, Zhangjiang High-Tech Park,
Shanghai, PRC 201203
People's Republic of China
Tel: +86 21 5080-0902 Fax: +86 21 5080-0906
Email: info@watlow.cn Website: www.watlow.cn

ワトロー・ジャパン株式会社
〒101-0047 東京都千代田区内神田1-14-4
四国ビル別館9階
Tel: 03-3518-6630 Fax: 03-3518-6632
Email: infoj@watlow.com Website: www.watlow.co.jp

Watlow Japan Ltd.
1-14-4 Uchikanda, Chiyoda-Ku
Tokyo 101-0047
Japan
Tel: +81-3-3518-6630 Fax: +81-3-3518-6632
Email: infoj@watlow.com Website: www.watlow.co.jp

Watlow Korea Co., Ltd.
#1406, E&C Dream Tower, 46, Yangpyeongdong-3ga
Yeongdeungpo-gu, Seoul 150-103
Republic of Korea
Tel: +82 (2) 2628-5770 Fax: +82 (2) 2628-5771
Website: www.watlow.co.kr

Watlow Malaysia Sdn Bhd
No. 14-3 Jalan 2/114
Kuchai Business Centre
Jalan Kuchai Lama
58200 Kuala Lumpur
Malaysia
Tel: +60 3 7980 7741 Fax: +60 3 7980 7739

瓦特龍電機股份有限公司
80143 高雄市前金區七賢二路189號 10樓之一
電話: 07-2885168 傳真: 07-2885568

Watlow Electric Taiwan Corporation
10F-1 No.189 Chi-Shen 2nd Road Kaohsiung 80143
Taiwan
Tel: +886-7-2885168 Fax: +886-7-2885568

Your Authorized Watlow Distributor

**TOTAL
CUSTOMER
SATISFACTION**
3 Year Warranty

Free Manuals Download Website

<http://myh66.com>

<http://usermanuals.us>

<http://www.somanuals.com>

<http://www.4manuals.cc>

<http://www.manual-lib.com>

<http://www.404manual.com>

<http://www.luxmanual.com>

<http://aubethermostatmanual.com>

Golf course search by state

<http://golfingnear.com>

Email search by domain

<http://emailbydomain.com>

Auto manuals search

<http://auto.somanuals.com>

TV manuals search

<http://tv.somanuals.com>