



Gas Barbecue Rotisserie

Fits Genesis Silver, Gold, & Platinum Gas Grills

Instructions

⚠ WARNINGS

- Read all instructions before using your rotisserie.
- This rotisserie is for outdoor use only.
- Remove motor and store in a dry place when not in use.
- Do not touch hot surfaces. Use barbecue mitts.
- This rotisserie is not for use by children.
- To protect against electrical hazards do not immerse cord, plugs, or motor in water or other liquids.
- Unplug the motor from outlet when not in use, or before cleaning
- Do not use rotisserie for other than intended use.
- Make sure motor is off before placing it on the motor bracket.
- Do not operate the rotisserie motor with a damaged cord or plug.
- Do not operate the rotisserie motor if it should malfunction.
- The rotisserie motor is equipped with a three prong (grounding) power cord for your protection against shock hazard.
- The power cord should be plugged directly into a properly grounded three prong receptacle. If use of an extension cord is required, be sure that it is a minimum 16 AWG, 3 wire well insulated cord, marked for OUTDOOR USE ONLY and properly grounded.
- When using an extension cord, make sure it is not in contact with hot or sharp surface.
- Outdoor extension cords should be marked with the letters "W-A" and a tag stating "Suitable for use with outdoor appliances".
- Do not cut or remove the grounding prong from the rotisserie motor power cord.
- Do not let cord hang over any sharp edge or hot surface.
- Use only outdoors, do not expose to rain.
- To reduce the risk of electric shock, keep extension cord connection dry and off the ground.
- A short power cord is supplied to reduce the risk of tripping over the cord. Extension cords may be used, but caution must be taken to prevent tripping over the cord.

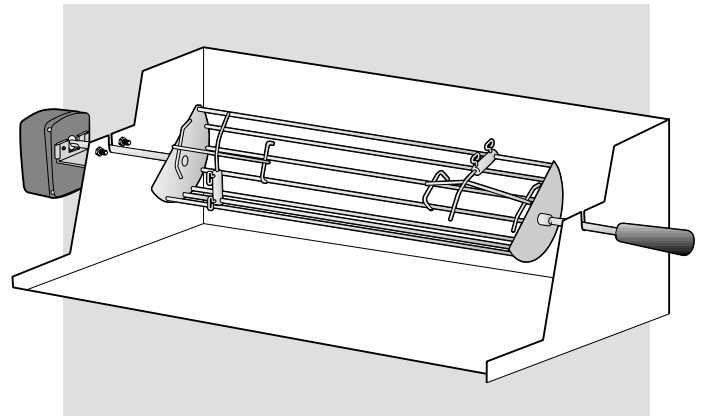

**YOU MUST READ THIS OWNERS GUIDE
BEFORE OPERATING YOUR ROTISSERIE**

WARRANTY

Weber-Stephen Products Co. (Weber) hereby warrants to the ORIGINAL PURCHASER of this Weber Gas Barbecue Rotisserie that it will be free of defects in material and workmanship from the date of purchase for a period of five (5) years.

Weber-Stephen Products Co. (Weber) hereby warrants to the ORIGINAL PURCHASER of this Weber Gas Barbecue Rotisserie Motor that it will be free of defects in material and workmanship from the date of purchase for a period of five (5) years.

When assembled and operated in accordance with the printed instructions accompanying it.

Weber may require reasonable proof of your date of purchase. THEREFORE, YOU SHOULD RETAIN YOUR SALES SLIP OR INVOICE.

This Limited Warranty shall be limited to the repair or replacement of parts that prove defective under normal use and service and which on examination shall indicate, to Weber's satisfaction, they are defective.

Before returning any parts, contact the Customer Service representative in your region.

If Weber confirms the defect and approves the claim, Weber will elect to replace such parts without charge. If you are required to return defective parts, transportation charges must be prepaid. Weber will return parts to the purchaser, freight or postage prepaid.

This Limited Warranty does not cover any failures or operating difficulties due to accident, abuse, misuse, alteration, misapplication, vandalism, improper installation or improper maintenance or service, or failure to perform normal and routine maintenance as set in this owner's manual.

Deterioration or damage due to severe weather conditions such as hail, hurricanes, earthquakes or tornadoes, discoloration due

to exposure to chemicals either directly or in the atmosphere, is not covered by this Limited Warranty.

There are no other express warrants except as set forth herein and any applicable implied warranties of merchantability and fitness are limited in duration to the period of coverage of this express written Limited Warranty. Some states do not allow limitation on how long an implied warranty lasts, so this limitation may not apply to you.

Weber is not liable for any special, indirect or consequential damages. Some regions do not allow the exclusion or limitation of incidental or consequential damages, so this limitation or exclusion may not apply to you.

Weber does not authorize any person or company to assume for it any other obligation or liability in connection with the sale, installation, use, removal, return, or replacement of its equipment; and no such representations are binding on Weber.

This Warranty applies only to products sold at retail.

WEBER-STEPHEN PRODUCTS CO.
Customer Service Center
250 South Hicks Road
Palatine, IL 60067-6241
USA

You will need:

Adjustable wrench

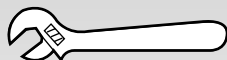

Handle - 1



Handle Shaft - 1



Lock On Clamp - 2



Meat Clamp - 2

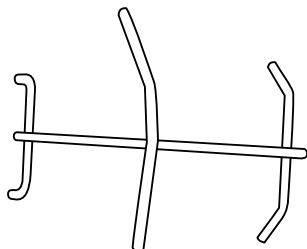

Motor - 1

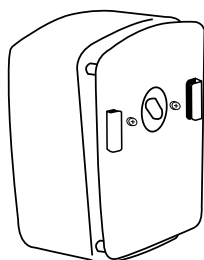

Rotisserie Basket- 1

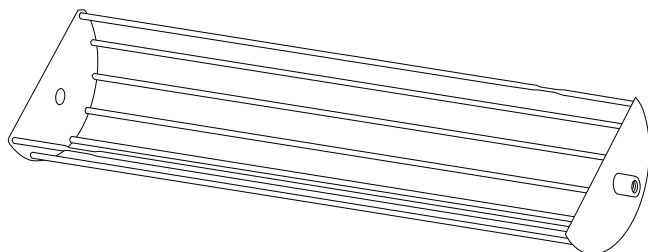

Rotisserie Shaft - 1



Thumb Screw - 4

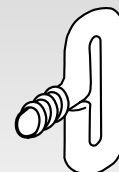

1/4 x 20 Keps nut - 2



1/4 x 20 x 5/8" Fastener - 2



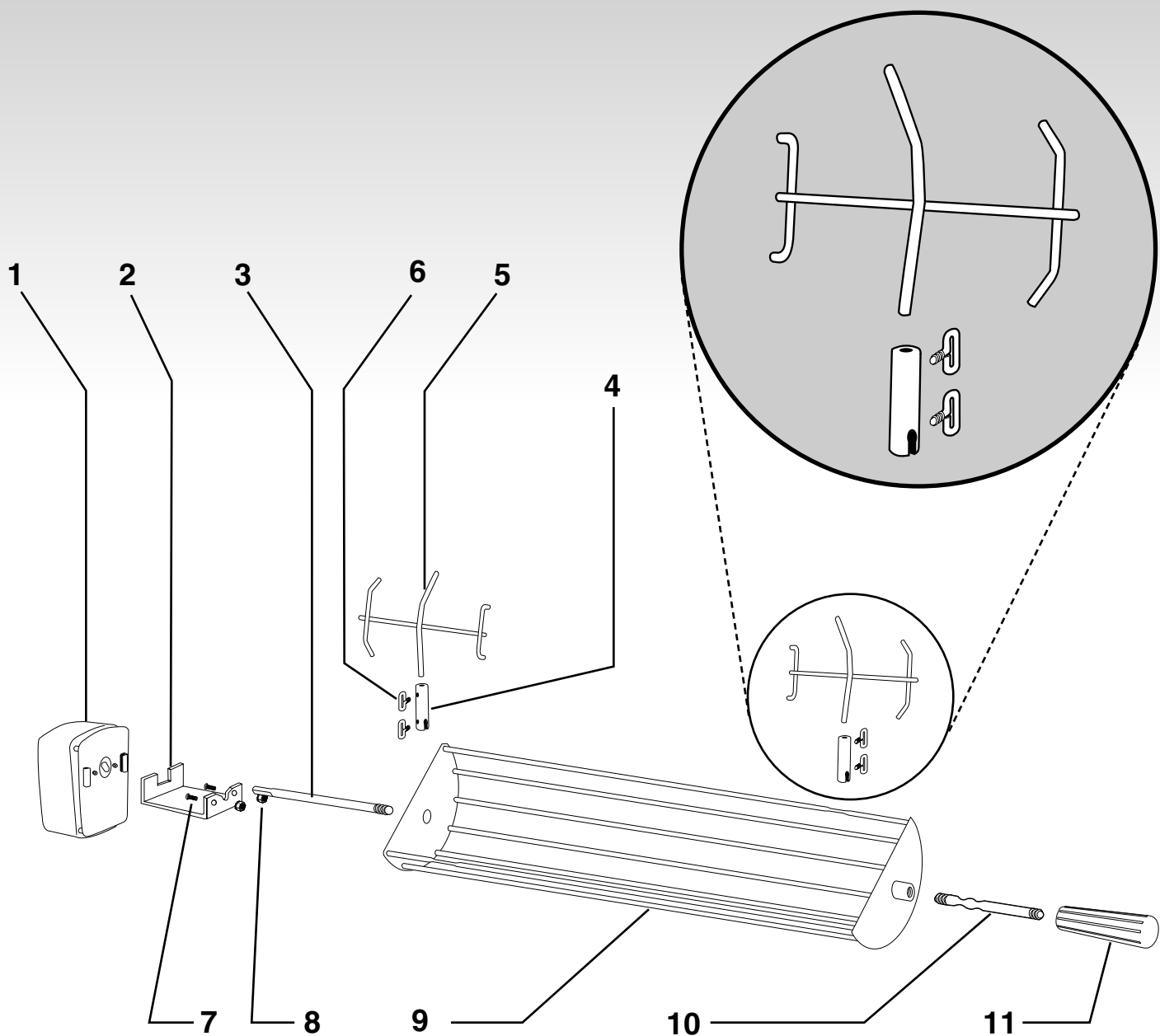

- | | | | |
|----|----------------------|-----|-----------------------------------|
| 1. | Motor (1) | 7. | 1/4 x 20 x 5/8" inch Fastener (2) |
| 2. | Motor Bracket (1) | 8. | 1/4 x 20 Keps Nut (2) |
| 3. | Rotisserie Shaft (1) | 9. | Rotisserie Basket (1) |
| 4. | Lock Arm (2) | 10. | Handle Shaft (1) |
| 5. | Meat Clamp (2) | 11. | Handle (1) |
| 6. | Thumb Screw (4) | | |

© 2000 Weber-Stephen Product Co., Weber, the  silhouette, and the kettle configuration are registered trademarks of Weber-Stephen Products Co., 200 East Daniels Road, Palatine, IL, 60067-6266, U.S.A. This product is covered by one or more United States patents and patents in other nations globally. Printed in Taiwan.

Assembly Instructions

1. Wash All Components Before Assembly

2. Install the Motor Bracket

Attach the stainless steel Motor Bracket to the left side of the Cooking Box, using the 1/4 x 20 x 5/8" fasteners and the 1/4-20 Keps nuts.

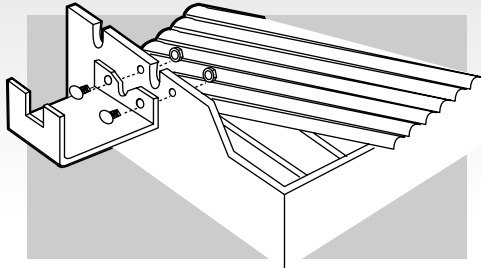

3. Attach the Motor

Slide the Motor onto the stainless steel Motor Bracket.

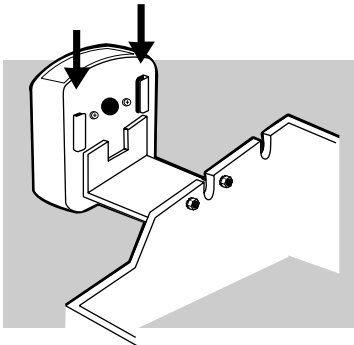

4. Attach Rotisserie Shaft to the Rotisserie Basket

Screw Handle Shaft and Handle together.

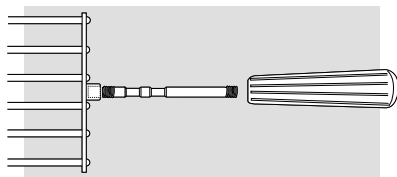

Screw Rotisserie Shaft to Rotisserie Basket and tighten shaft with adjustable wrench. Screw Handle Shaft/Handle to Rotisserie Basket. **NOTE: All threads are counter-clockwise, or tighten to the left.**

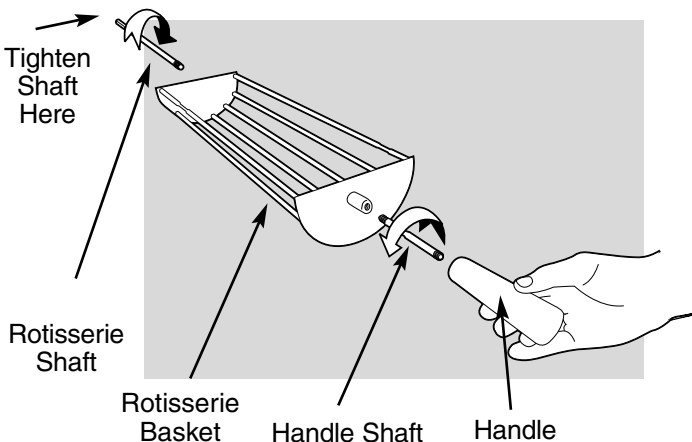

5. Assembly of Meat Clamp

Insert both Thumb Screws into the holes on the Lock Arm. **NOTE: Do not tighten Thumb Screws fully.**

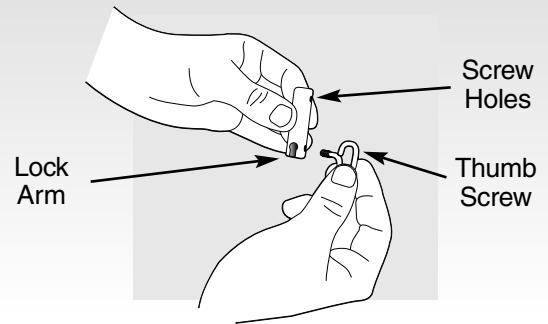

Insert middle Meat Clamp Arm into top into top of the Lock Arm as shown. Tighten top Thumb Screw to lock Meat Clamp into shaft.

Repeat all of step 4 for second Meat Clamp.

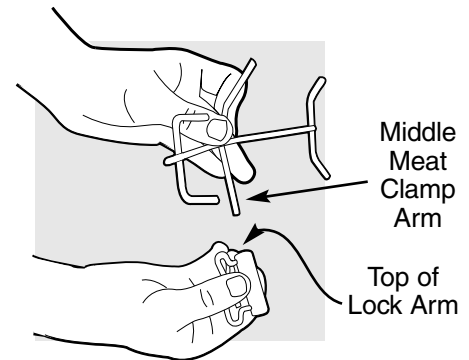

6. Attach Meat Clamps to Rotisserie Basket

Face prongs of Meat Clamp toward the inside of the Rotisserie Basket. Slide bottom of Lock Arm onto tapered portion of the rail of Rotisserie Basket. Slide Lock Arm along rail to desired position. Tighten Thumb Screw at bottom of Lock Arm to fix its position on Rotisserie Basket.

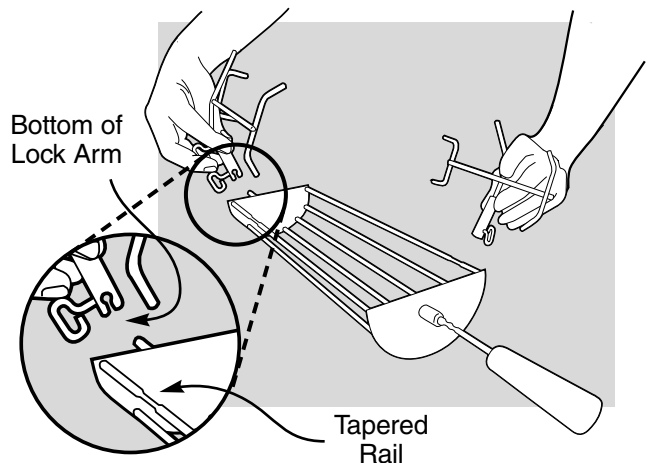

Operating Instructions

1. Remove Warm-Up basket and cooking grates from grill.
Large cuts of food may require removal of warming basket to allow full rotation of the rotisserie.

NOTE: For Genesis Silver A gas grill, remove center Flavorizer bar..

Securing Flat Food and 1/2 Chicken/Fowl

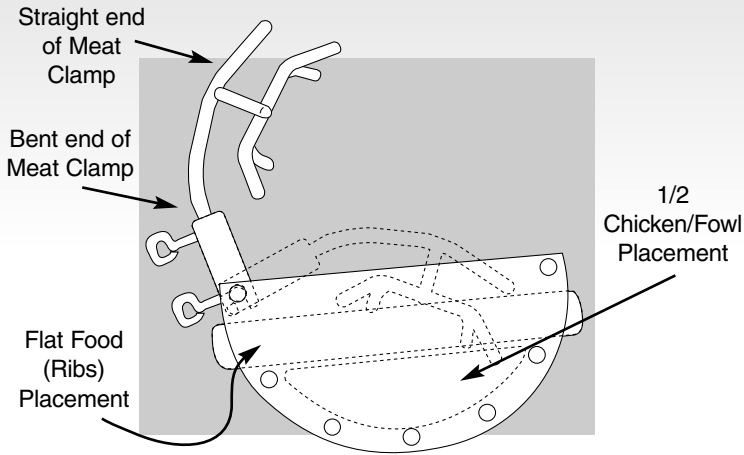

2. Insert the BENT end of Meat Clamp into the lock arm and finger tighten the thumb screws.
3. Place flat food such as a slab of ribs across the set of cradle bars as shown. (Split chicken is placed with the rounded side towards the rotisserie bars and split/flat side of food towards the Meat Clamp.
4. Press Meat Clamp, applying good pressure, down on food, adjusting for best grip on food. Finger tighten Thumb Screw closest to Meat Clamp first then Thumb Screw closest to Rotisserie Basket.

⚠WARNING: When not using both Meat Clamps, remove extra clamp from Rotisserie Basket when not in use.

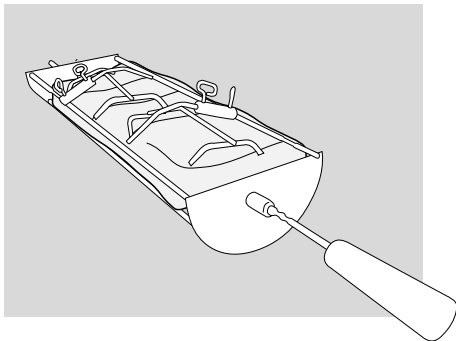

5. Once meat is secure, test stability by rotating rotisserie by hand.

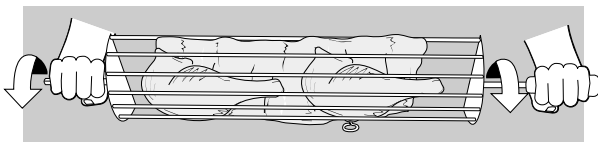
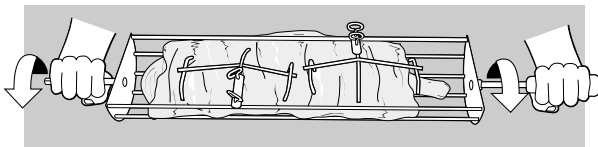

If the food becomes loose or unsecure, repeat Steps 4 through 5 until food is secure in Rotisserie Basket.

Securing Rounded Meat

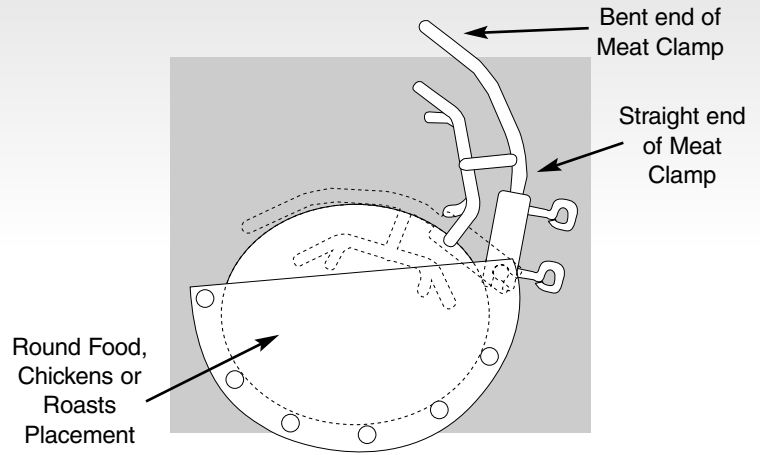

2. Insert STRAIGHT end of Meat Clamp into the Lock Arm and finger tighten the Thumb Screws.
3. Due to the unique design of the basket; roasts, whole chickens, leg of lamb, etc., DO NOT need to be centered or balanced in the Rotisserie Basket and can be placed in the Rotisserie Basket at the same time.
4. Press Meat Clamp, applying good pressure, down on food, adjusting for best grip on food. Finger tighten Thumb Screw closest to Meat Clamp first then Thumb Screw closest to Rotisserie Basket.

⚠WARNING: When not using both Meat Clamps, remove extra clamp from Rotisserie Basket when not in use.

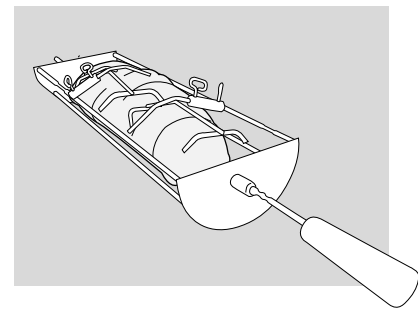

5. Once meat is secure, test stability by rotating rotisserie by hand.

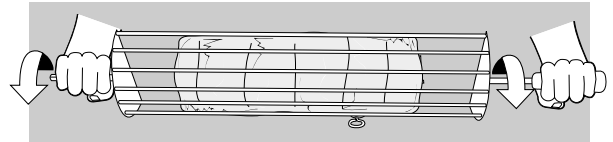
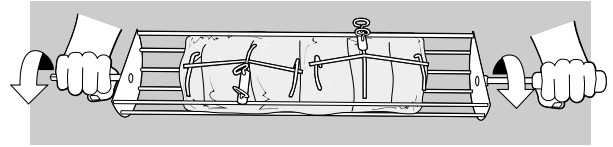

If the food becomes loose or unsecure, repeat Steps 4 through 5 until food is secure in Rotisserie Basket.

Securing Whole Chicken/Fowl Meat

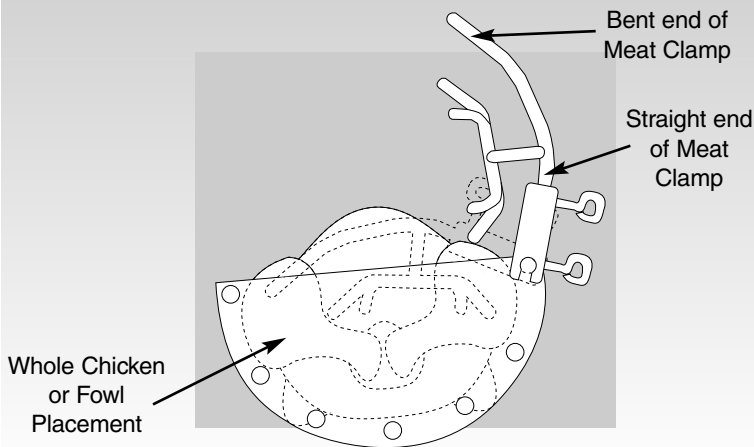

2. Insert STRAIGHT end of Meat Clamp into the Lock Arm and finger tighten the Thumb Screws.
3. Due to the unique design of the basket; roasts, whole chickens, leg of lamb, etc., DO NOT need to be centered or balanced in the Rotisserie Basket and can be placed in the Rotisserie Basket at the same time.
4. When cooking chicken/fowl, the wings should be folded under its body and positioned in the Rotisserie Basket with breast side up. Then press Meat Clamp, applying good pressure, down on food, adjusting for best grip on food. Finger tighten Thumb Screw closest to Meat Clamp first then Thumb Screw closest to Rotisserie Basket.

⚠WARNING: When not using both Meat Clamps, remove extra clamp from Rotisserie Basket when not in use.

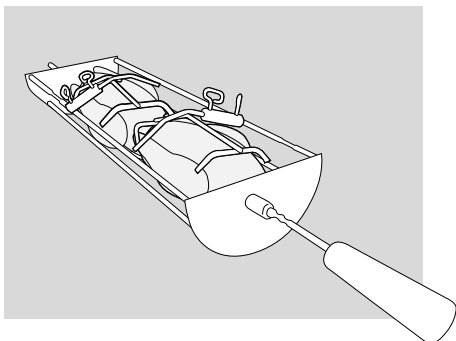

5. Once meat is secure, test stability by rotating rotisserie by hand.

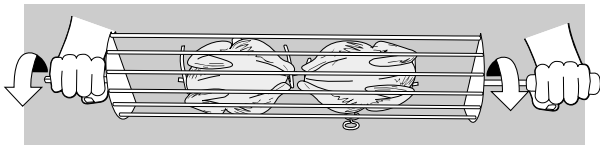
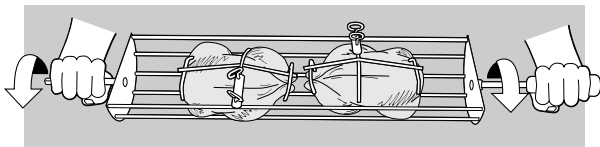

If the food becomes loose or unsecure, repeat Steps 4 through 5 until food is secure in Rotisserie Basket.

6. Set the Rotisserie Shaft on the cooking box. Slide the squared end of the Rotisserie Shaft into the Motor.

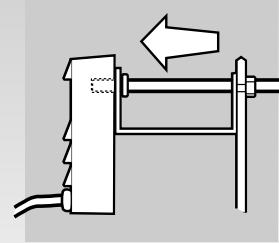

7. Set the Handle Shaft on the cooking box. The groove closest to the basket fits the Genesis Silver A gas grill. This groove should rest in the cut-out in the cooking box for the Genesis Silver A gas grill.

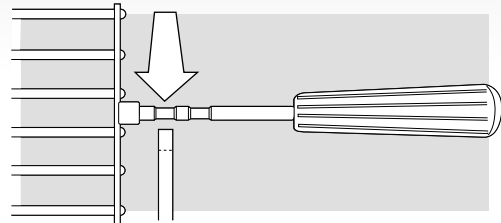

OR

Set the Handle Shaft on the cooking box. The groove closest to the handle fits the Genesis Silver B, C, all Golds, and all Platinum gas grills. This groove should rest in the cut-out in the cooking box for the Genesis Silver B, C, all Golds, and all Platinum gas grill.

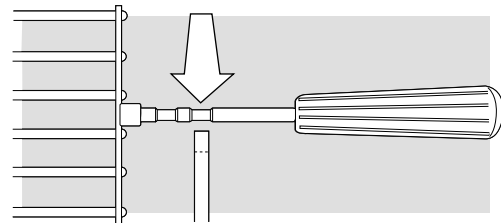

8. Place Rotisserie in grill and allow to rotate a few turns. If food shrinks and/or becomes unsecure, re-adjust Meat Clamp as required to secure food in Rotisserie basket.
9. Remove Rotisserie with food from cooking box before preheating. Preheat barbecue for 10 minutes with lid down. Follow cooking instructions in your Weber Gas Barbecue cookbook and adjust the burners as needed.
10. Return rotisserie to the cooking box.
11. Turn the motor on and begin cooking.
12. Check on Meat Clamps periodically making sure clamps are securely holding food in place.

⚠CAUTION: Re-adjustment of Meat Clamp may be required more than once during cooking due to food shrinkage.

⚠WARNING: Rotisserie is metal and will be hot. Wear oven mits to protect hands during Meat Clamp adjustment and movement of

Cooking Instructions

- When cooking more than one variety of meat (chicken and roast), there is no need to balance the difference in weights, as the basket is designed to carry the weights evenly.
- Can hold up to 2 ten pound whole chickens, whole pork loin, boneless rump roast, prime rib, split chicken breasts, ribs, 2 cornish hens, Italian or Polish sausage, leg of lamb, turkey breasts, or turkey legs. You can also cook a whole fish depending on its size.
- Meats or poultry should be brought to room temperature before cooking. (30 to 60 minutes should be adequate for most foods. If frozen, defrost completely before cooking.)
- Tie meat or poultry with a string to make the shape as uniform as possible before placing in basket.
- Remove cooking grates and warming rack to allow food to turn freely.
- If you wish to save drippings for gravy, place a drip pan in the center on top of the Flavorizer Bars before positioning the rotisserie and food in the barbecue.
- Food preparation steps are the same for rotisserie cooking as for regular cooking. Indicated timing in cookbook will be the same.
- Preheat barbecue for 10 minutes with the lid down.
- All cooking is done with the lid down.
- Cook by Indirect Method as indicated in recipe.
- If foods are too heavy or are irregular shapes, they may not rotate well and should be cooked by the Indirect Cooking Method without using the rotisserie.
- When meat is done, we recommend that you shut your grill off and let food rest for a few minutes before removing from the Rotisserie Basket.

⚠WARNING: Rotisserie is metal and will be hot. Wear oven mits to protect hands during Meat Clamp adjustment and movement of the rotisserie.

- Carefully open Meat Clamps and remove food with a fork and/or tongs from Rotisserie Basket and place food onto plate or plater.
- Remove Rotisserie Basket from cooking box once you are completed with cooking and clean thoroughly.

Tips for Safe Cooking

- **ALWAYS** wear protective gloves when handling your rotisserie or handle.
- **SECURELY** tighten thumb screws before starting your rotisserie.
- It is normal for meat to shrink during cooking. This can cause the meat to move around in the Rotisserie Basket or fall from the basket. It may be necessary to STOP the rotisserie and secure the Meat Clamp(s), making sure to once again tighten the Thumb Screws.

Cleaning Notes

- Always wash all components before assembly.
- The rotisserie basket disassembles for easy cleaning in a dish washer. Steel wool pads and/or grill brush may be used for cleaning stubborn areas.

Free Manuals Download Website

<http://myh66.com>

<http://usermanuals.us>

<http://www.somanuals.com>

<http://www.4manuals.cc>

<http://www.manual-lib.com>

<http://www.404manual.com>

<http://www.luxmanual.com>

<http://aubethermostatmanual.com>

Golf course search by state

<http://golfingnear.com>

Email search by domain

<http://emailbydomain.com>

Auto manuals search

<http://auto.somanuals.com>

TV manuals search

<http://tv.somanuals.com>