

Performance Verification



TDS 520A, 524A, 540A, & 544A Digitizing Oscilloscopes

070-8712-01

**Please check for change information at the rear
of this manual.**

First Printing: July 1993.

Instrument Serial Numbers

Each instrument manufactured by Tektronix has a serial number on a panel insert or tag, or stamped on the chassis. The first letter in the serial number designates the country of manufacture. The last five digits of the serial number are assigned sequentially and are unique to each instrument. Those manufactured in the United States have six unique digits. The country of manufacture is identified as follows:

| | |
|---------|--|
| B010000 | Tektronix, Inc., Beaverton, Oregon, USA |
| E200000 | Tektronix United Kingdom, Ltd., London |
| J300000 | Sony/Tektronix, Japan |
| H700000 | Tektronix Holland, NV, Heerenveen, The Netherlands |

Instruments manufactured for Tektronix by external vendors outside the United States are assigned a two digit alpha code to identify the country of manufacture (e.g., JP for Japan, HK for Hong Kong, IL for Israel, etc.).

Tektronix, Inc., P.O. Box 500, Beaverton, OR 97077

Printed in U.S.A.

Copyright © Tektronix, Inc., 1993. All rights reserved. Tektronix products are covered by U.S. and foreign patents, issued and pending. The following are registered trademarks: TEKTRONIX, TEK, TEKPROBE, and SCOPE-MOBILE.

WARRANTY

Tektronix warrants that this product will be free from defects in materials and workmanship for a period of three (3) years from the date of shipment. If any such product proves defective during this warranty period, Tektronix, at its option, either will repair the defective product without charge for parts and labor, or will provide a replacement in exchange for the defective product.

In order to obtain service under this warranty, Customer must notify Tektronix of the defect before the expiration of the warranty period and make suitable arrangements for the performance of service. Customer shall be responsible for packaging and shipping the defective product to the service center designated by Tektronix, with shipping charges prepaid. Tektronix shall pay for the return of the product to Customer if the shipment is to a location within the country in which the Tektronix service center is located. Customer shall be responsible for paying all shipping charges, duties, taxes, and any other charges for products returned to any other locations.

This warranty shall not apply to any defect, failure or damage caused by improper use or improper or inadequate maintenance and care. Tektronix shall not be obligated to furnish service under this warranty a) to repair damage resulting from attempts by personnel other than Tektronix representatives to install, repair or service the product; b) to repair damage resulting from improper use or connection to incompatible equipment; or c) to service a product that has been modified or integrated with other products when the effect of such modification or integration increases the time or difficulty of servicing the product.

THIS WARRANTY IS GIVEN BY TEKTRONIX WITH RESPECT TO THIS PRODUCT IN LIEU OF ANY OTHER WARRANTIES, EXPRESS OR IMPLIED. TEKTRONIX AND ITS VENDORS DISCLAIM ANY IMPLIED WARRANTIES OF MERCHANTABILITY OR FITNESS FOR A PARTICULAR PURPOSE. TEKTRONIX' RESPONSIBILITY TO REPAIR OR REPLACE DEFECTIVE PRODUCTS IS THE SOLE AND EXCLUSIVE REMEDY PROVIDED TO THE CUSTOMER FOR BREACH OF THIS WARRANTY. TEKTRONIX AND ITS VENDORS WILL NOT BE LIABLE FOR ANY INDIRECT, SPECIAL, INCIDENTAL, OR CONSEQUENTIAL DAMAGES IRRESPECTIVE OF WHETHER TEKTRONIX OR THE VENDOR HAS ADVANCE NOTICE OF THE POSSIBILITY OF SUCH DAMAGES.

Welcome

This is the Performance Verification for the TDS 520A, 524A, 540A, and 544A Oscilloscope. It contains procedures suitable for determining if the instrument functions, was adjusted properly, and meets the performance characteristics as warranted.

Also contained in this document are technical specifications for these oscilloscopes.

Related Manuals

The following documents are related to the use or service of the digitizing oscilloscope.

- The TDS 520A, 524A, 540A, & 544A User Manual (Tektronix part number 070-8710-01).
- The TDS Family Programmer Manual (Tektronix part number 070-8709-01) describes using a computer to control the digitizing oscilloscope through the GPIB interface.
- The TDS 520A, 524A, 540A, 544A, & 644A Reference (Tektronix part number 070-8711-01) gives you a quick overview of how to operate your digitizing oscilloscope.
- The TDS 520A, 524A, 540A, & 544A Service Manual (Tektronix part number 070-8713-01) provides information for maintaining and servicing your digitizing oscilloscope to the module level.

Welcome

Table of Contents

| | |
|----------------------|---|
| Safety Summary | v |
|----------------------|---|

Performance Verification Procedures

| | |
|--|-------------|
| Brief Procedures | 1-1 |
| General Instructions | 1-1 |
| Conventions | 1-2 |
| Self Tests | 1-4 |
| Verify Internal Adjustment, Self Compensation, and Diagnostics | 1-4 |
| Functional Tests | 1-6 |
| Verify All Input Channels | 1-6 |
| Verify the Time Base | 1-9 |
| Verify the Main and Delayed Trigger Systems | 1-10 |
| Verify the File System (Optional on TDS 520A and 540A) ... | 1-12 |
| Performance Tests | 1-15 |
| Prerequisites | 1-15 |
| Equipment Required | 1-16 |
| Test Record | 1-19 |
| Signal Acquisition System Checks | 1-23 |
| Check Accuracy of Offset (Zero Setting) | 1-23 |
| Check DC Gain and Voltage Measurement Accuracy | 1-25 |
| Check Analog Bandwidth | 1-32 |
| Check Delay Between Channels | 1-36 |
| Time Base System Checks | 1-39 |
| Check Accuracy for Long-Term Sample Rate, Delay Time, and Delta Time Measurements | 1-39 |
| Trigger System Checks | 1-42 |
| Check Accuracy (Time) for Pulse-Glitch or Pulse-Width Triggering | 1-42 |
| Check Accuracy, Trigger-level or Threshold, DC Coupled ... | 1-45 |
| Sensitivity, Edge Trigger, DC Coupled | 1-48 |
| Output Signal Checks | 1-54 |
| Check Outputs — CH 3 and Main and Delayed Trigger (TDS 540A and 544A only) | 1-54 |
| Check Probe Compensator Outputs | 1-57 |
| Option 05 Video Trigger Checks | 1-61 |
| Check Video Trigger | 1-61 |

Specifications



| | |
|--|-------------|
| Specifications | 2-1 |
| General Product Description | 2-1 |
| User Interface | 2-2 |
| Menus | 2-2 |
| Indicators | 2-2 |
| General Purpose Knob | 2-3 |
| GUI | 2-3 |
| Signal Acquisition System | 2-3 |
| Horizontal System | 2-4 |
| Trigger System | 2-5 |
| Acquisition Control | 2-6 |
| On-Board User Assistance | 2-6 |
| Help | 2-6 |
| Autoset | 2-6 |
| Measurement Assistance | 2-6 |
| Cursor | 2-6 |
| Measure | 2-7 |
| Digital Signal Processing (DSP) | 2-7 |
| Storage and I/O | 2-7 |
| Display | 2-8 |
| Zoom | 2-8 |
| Nominal Traits | 2-9 |
| Warranted Characteristics | 2-15 |
| Typical Characteristics | 2-21 |

Safety Summary

Please take a moment to review these safety precautions. They are provided for your protection and to prevent damage to the digitizing oscilloscope. This safety information applies to all operators and service personnel.

Symbols and Terms

These two terms appear in manuals:

-  statements identify conditions or practices that could result in damage to the equipment or other property.
-  statements identify conditions or practices that could result in personal injury or loss of life.

These two terms appear on equipment:

- *CAUTION* indicates a personal injury hazard not immediately accessible as one reads the marking, or a hazard to property including the equipment itself.
- *DANGER* indicates a personal injury hazard immediately accessible as one reads the marking.

This symbol appears in manuals:



Static-Sensitive Devices

These symbols appear on equipment:



DANGER
High Voltage



Protective
ground (earth)
terminal



ATTENTION
Refer to
manual

Specific Precautions

Observe all of these precautions to ensure your personal safety and to prevent damage to either the digitizing oscilloscope or equipment connected to it.

Power Source

The digitizing oscilloscope is intended to operate from a power source that will not apply more than 250 V_{RMS} between the supply conductors or between either supply conductor and ground. A protective ground connection, through the grounding conductor in the power cord, is essential for safe system operation.

Grounding the Digitizing Oscilloscope

The digitizing oscilloscope is grounded through the power cord. To avoid electric shock, plug the power cord into a properly wired receptacle where earth ground has been verified by a qualified service person. Do this before making connections to the input or output terminals of the digitizing oscilloscope.

Without the protective ground connection, all parts of the digitizing oscilloscope are potential shock hazards. This includes knobs and controls that may appear to be insulators.

Use the Proper Power Cord

Use only the power cord and connector specified for your product. Use only a power cord that is in good condition.

Use the Proper Fuse

To avoid fire hazard, use only the fuse specified in the parts list for your product, matched by type, voltage rating, and current rating.

Do Not Remove Covers or Panels

To avoid personal injury, do not operate the digitizing oscilloscope without the panels or covers.

Electric Overload

Never apply to a connector on the digitizing oscilloscope a voltage that is outside the range specified for that connector.

Do Not Operate in Explosive Atmospheres

The digitizing oscilloscope provides no explosion protection from static discharges or arcing components. Do not operate the digitizing oscilloscope in an atmosphere of explosive gases.

Performance Verification Procedures

Brief Procedures

The *Self Tests* use internal routines to confirm basic functionality and proper adjustment. No test equipment is required to do these test procedures.

The *Functional Tests* utilize the probe-compensation output at the front panel as a test-signal source for further verifying that the oscilloscope functions properly. A standard-accessory probe, included with this oscilloscope, is the only equipment required.

General Instructions

Besides the *Brief Procedures*, the set of procedures that can be used to verify oscilloscope performance includes the *Performance Tests*, found later in this section. You may not need to perform all of these procedures, depending on what you want to accomplish:

- To rapidly confirm that this oscilloscope functions and was adjusted properly, just do the procedures under *Self Tests*, which begin on page 1-4.

Advantages: These procedures are quick to do, require no external equipment or signal sources, and perform extensive functional and accuracy testing to provide high confidence that the oscilloscope will perform properly. They can be used as a quick check before making a series of important measurements.

- To further check functionality, first do the *Self Tests* just mentioned; then do the procedures under *Functional Tests* that begin on page 1-6.

Advantages: These procedures require minimal additional time to perform, require no additional equipment other than a standard-accessory probe, and more completely test the internal hardware of this oscilloscope. They can be used to quickly determine if the oscilloscope is suitable for putting into service, such as when it is first received.

- If more extensive confirmation of performance is desired, do the *Performance Tests*, beginning on page 1-15, after doing the *Functional* and *Self Tests* just referenced.

Advantages: These procedures add direct checking of warranted specifications. They require more time to perform and suitable test equipment is required. (See *Equipment Required* on page 1-15.)

If you are not familiar with operating this oscilloscope, read the TDS 520A, 524A, 540A, 544A, & 644A Reference or the TDS 520A, 524A, 540A, & 544A User manual. These contain instructions that acquaint you with the use of the front-panel controls and the menu system.

Conventions

Throughout these procedures the following conventions apply:

- Each test procedure uses the following general format:

Title of Test

Equipment Required

Prerequisites

Procedure

- Each procedure consists of as many steps, substeps, and subparts as required to do the test. Steps, substeps, and subparts are sequenced as follows:

1. First Step

- a. First Substep

- First Subpart
- Second Subpart

- b. Second Substep

2. Second Step

- In steps and substeps, the lead-in statement in italics instructs you what to do, while the instructions that follow tell you how to do it: in the example step below, “*Initialize the oscilloscope*” by doing “Press save/recall **SETUP**. Now, press the main-menu button...”.

Initialize the oscilloscope: Press save/recall **SETUP**. Now, press the main-menu button **Recall Factory Setup**; then the side-menu button **OK Confirm Factory Init**.

- Where instructed to use a front-panel button or knob, or select from a main or side menu, or verify a readout or status message, the name of the button or knob appears in boldface type: “press **SHIFT**; then **ACQUIRE MENU**”, “press the main-menu button **Coupling**”, or “verify that the status message is *Pass*.”



The symbol at the left is accompanied by information you must read to do the procedure properly.

- Refer to Figure 1-1: “Main menu” refers to the menu that labels the seven menu buttons under the display; “side menu” refers to the menu that labels the five buttons to the right of the display. “Pop-up menu” refers to a menu that pops up when a main-menu button is pressed.

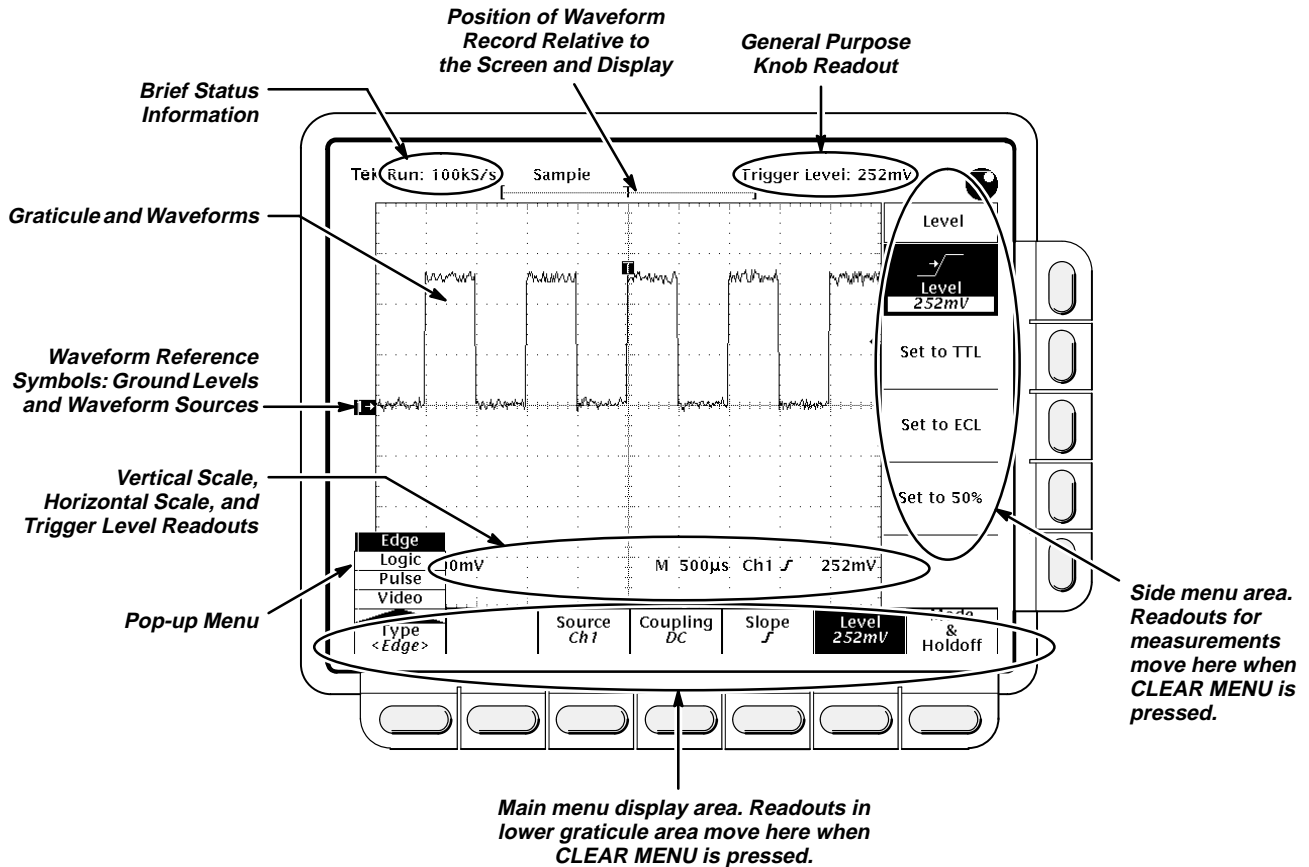

Figure 1-1: Map of Display Functions

Self Tests

This procedure uses internal routines to verify that this oscilloscope functions and was adjusted properly. No test equipment or hookups are required.

Verify Internal Adjustment, Self Compensation, and Diagnostics

Equipment Required: None.

Prerequisites: Power on the Digitizing Oscilloscope and allow a 20 minute warm-up before doing this procedure.

Procedure:

1. *Verify that internal diagnostics pass:* Do the following substeps to verify passing of internal diagnostics.
 - a. *Display the System diagnostics menu:*
 - Press **SHIFT**; then press **UTILITY**.
 - Repeatedly press the main-menu button **System** until **Diag/Err** is highlighted in the pop-up menu.
 - b. *Run the System Diagnostics:* Press the main-menu button **Execute**; then press the side-menu button **OK Confirm Run Test**.
 - c. *Wait:* The internal diagnostics do an exhaustive verification of proper oscilloscope function. This verification will take up to two minutes. At some time during the wait, a "clock" icon (shown at left) will appear on-screen. When the verification is finished, the resulting status will appear on the screen.
 - d. *Confirm no failures are found:* Verify that no failures are found and reported on-screen.
 - e. *Confirm the three adjustment sections have passed status:*
 - Press **SHIFT**; then press **UTILITY**.
 - Press the main menu button **System** until **Cal** is highlighted in the pop-up menu.
 - Verify that the word **Pass** appears in the main menu under the following menu labels: **Voltage Reference**, **Frequency Response**, and **Pulse Trigger**. (See Figure 1-2.)



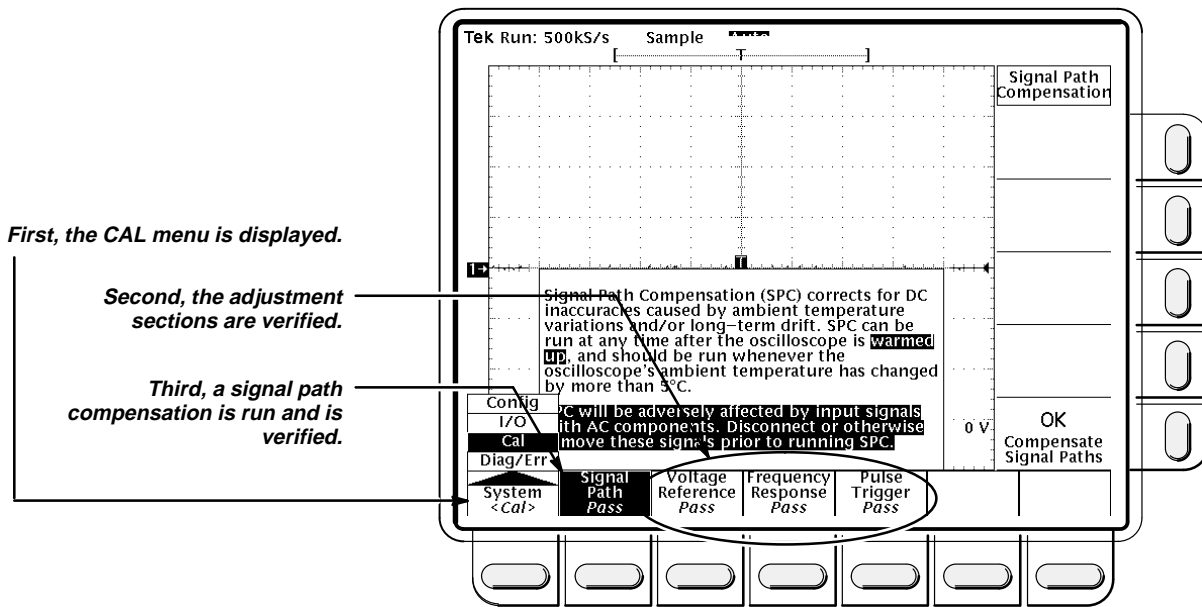

Figure 1-2: Verifying Adjustments and Signal-Path Compensation



When doing steps f and g, do not turn off the oscilloscope until signal-path compensation completes. If you interrupt (or lose) power to the instrument while signal-path compensation is running, a message is logged in the oscilloscope error log. If such a case occurs, rerun signal-path compensation.

- f. *Run the signal-path compensation:* Press the main-menu button **Signal Path**; then press the side-menu button **OK Compensate Signal Paths**.
- g. *Wait:* Signal-path compensation runs in about one to two minutes. While it progresses, a “clock” icon (shown at left) is displayed on-screen. When compensation completes, the status message will be updated to **Pass** or **Fail** in the main menu (see step h).
- h. *Confirm signal-path compensation returns passed status:* Verify the word **Pass** appears under **Signal Path** in the main menu. (See Figure 1-2.)

2. *Return to regular service:* Press **CLEAR MENU** to exit the system menu.

Functional Tests

The purpose of these procedures is to confirm that this oscilloscope functions properly. The only equipment required is one of the standard-accessory probes and, to check the file system, a 3.5 inch. 720 K or 1.44 Mbyte floppy disk.



These procedures verify functions; that is, they verify that oscilloscope features *operate*. They do *not* verify that they operate within limits.

Therefore, when the instructions in the functional tests that follow call for you to verify that a signal appears on-screen “that is about five divisions in amplitude” or “has a period of about six horizontal divisions”, etc., do *NOT* interpret the quantities given as limits. Operation within limits is checked in *Performance Tests*, which begin on page 1-15.



DO NOT make changes to the front-panel settings that are not called out in the procedures. Each verification procedure will require you to set the oscilloscope to certain default settings before verifying functions. If you make changes to these settings, other than those called out in the procedure, you may obtain invalid results. In this case, just redo the procedure from step 1.

When you are instructed to press a menu button, the button may already be selected (its label will be highlighted). If this is the case, it is not necessary to press the button.

Verify All Input Channels

Equipment Required: One P6139A probe.

Prerequisites: None.

Procedure:

1. *Install the test hookup and preset the oscilloscope controls:*

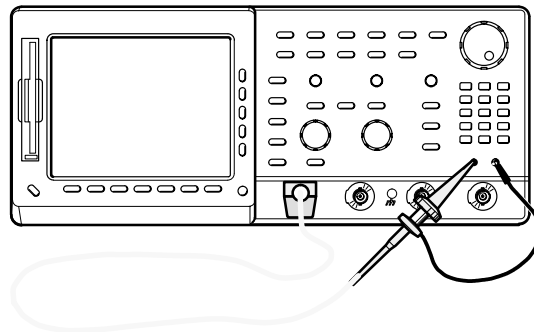

Figure 1-3: Universal Test Hookup for Functional Tests

- a. *Hook up the signal source:* Install the probe on **CH 1**. Connect the probe tip to **PROBE COMPENSATION SIGNAL** on the front panel; connect the probe ground to **PROBE COMPENSATION GND**.

- b. *Initialize the oscilloscope:*
 - Press save/recall **SETUP**.
 - Press the main-menu button **Recall Factory Setup**.
 - Press the side-menu button **OK Confirm Factory Init**.
2. *Verify that all input channels operate:* Do the following substeps — test CH 1 first, *skipping substep a since CH 1 is already set up for verification from step 1.*
- a. *Select an unverified channel:*
 - Press **WAVEFORM OFF** to remove from display the channel just verified.
 - Press the front-panel button that corresponds to the channel you are to verify.
 - Move the probe to the channel you selected.
 - b. *Set up the selected channel:*
 - Press **AUTOSET** to obtain a viewable, triggered display in the selected channel.
 - Set the horizontal **SCALE** to 200 μs . Press **CLEAR MENU** to remove any menu that may be on the screen.
 - c. *Verify that the channel is operational:* Confirm that the following statements are true.
 - The vertical scale readout for the channel under test shows a setting of 200 mV, and a square-wave probe-compensation signal about 2.5 divisions in amplitude is on-screen. (See Figure 1-1 on page 1-3 to locate the readout.)
 - The vertical **POSITION** knob moves the signal up and down the screen when rotated.
 - Turning the vertical **SCALE** knob counterclockwise decreases the amplitude of the waveform on-screen, turning the knob clockwise increases the amplitude, and returning the knob to 200 mV returns the amplitude to about 2.5 divisions.
 - d. *Verify that the channel acquires in all acquisition modes:* Press **SHIFT**; then press **ACQUIRE MENU**. Use the side menu to select, in turn, each of the five hardware acquire modes and confirm that the following statements are true. Refer to the icons at the left of each statement as you confirm those statements.
 - **Sample** mode displays an actively acquiring waveform on-screen. (Note that there is noise present on the peaks of the square wave.)
 - **Peak Detect** mode displays an actively acquiring waveform on-screen with the noise present in Sample mode “peak detected.”





- **Hi Res** mode displays an actively acquiring waveform on-screen with the noise that was present in Sample mode reduced.
- **Envelope** mode displays an actively acquiring waveform on-screen with the noise displayed.
- **Average** mode displays an actively acquiring waveform on-screen with the noise reduced like in Hi Res mode.



TDS 520A and 524A only: Substep e will have you repeat the previous substeps to check all input channels. Be sure to check only CH 1 and CH 2 when testing the TDS 520A or 524A. (Step 3 will test the AUX 1 and AUX 2 inputs.) When testing the TDS 540A or 544A, test all four channels, CH 1 through CH 4.)

- e. *Test all channels:* Repeat substeps a through d until all four input channels are verified.
3. *TDS 520A and 524A Only: Verify auxiliary inputs operate:* Perform the following substeps when checking the AUX 1 and AUX 2 inputs only.
 - a. *Select an auxiliary channel:*
 - Press **WAVEFORM OFF** to remove from display the channel just verified.
 - Press the front-panel button that corresponds to the channel you are to verify.
 - Move probe to the channel you selected.
 - b. *Set up the selected channel:* Press **AUTOSET** to obtain a viewable display in the selected channel.

The display obtained might not trigger stably because autoset cannot provide more than about $\frac{1}{2}$ signal amplitude in an auxiliary channel equipped with a 10X probe. This amount is less than the minimum trigger sensitivity for auxiliary channel trigger sources; therefore, triggering is not required.
 - c. *Verify that the channel is operational:* Confirm that the following statements are true.
 - The vertical scale readout for the channel under test shows a setting of 1 V, and a square-wave probe-compensation signal about $\frac{1}{2}$ on page 1-3 to locate the readout.)
 - The vertical **POSITION** knob moves the signal up and down the screen when rotated.
 - Turning the vertical **SCALE** knob counterclockwise to 10 V decreases the amplitude of the waveform on-screen. (The amplitude will drop to near zero when doing this substep.)
 - Returning the knob to 1 V returns the amplitude to about $\frac{1}{2}$ division.
 - d. *Verify that the channel acquires in all acquisition modes:* Disconnect the probe ground lead from the probe-compensation terminal. Do step 2, substep d to verify the five acquire modes.

- e. *Test all channels:* Repeat substeps a through d to verify AUX 2.
4. *Remove the test hookup:* Disconnect the probe from the channel input and the probe-compensation terminals.

Verify the Time Base

Equipment Required: One P6139A probe.

Prerequisites: None.

Procedure:

1. *Install the test hookup and preset the oscilloscope controls:*
 - a. *Hook up the signal source:* Install the probe on **CH 1**. Connect the probe tip to **PROBE COMPENSATION SIGNAL** on the front panel; connect the probe ground to **PROBE COMPENSATION GND**. (See Figure 1-3 on page 1-6.)
 - b. *Initialize the oscilloscope:*
 - Press save/recall **SETUP**.
 - Press the main-menu button **Recall Factory Setup**; then press the side-menu button **OK Confirm Factory Init**.
 - c. *Modify default settings:*
 - Press **AUTOSET** to obtain a viewable, triggered display.
 - Set the horizontal **SCALE** to 200 μ s.
 - Press **CLEAR MENU** to remove the menus from the screen.
2. *Verify that the time base operates:* Confirm the following statements.
 - a. One period of the square-wave probe-compensation signal is about five horizontal divisions on-screen for the 200 μ s horizontal scale setting (set in step 1c).
 - b. Rotating the horizontal **SCALE** knob clockwise expands the waveform on-screen (more horizontal divisions per waveform period), and that counterclockwise rotation contracts it, and that returning the horizontal scale to 200 μ s returns the period to about five divisions.
 - c. The horizontal **POSITION** knob positions the signal left and right on-screen when rotated.
3. *Remove the test hookup:* Disconnect the probe from the channel input and the probe-compensation terminals.

Verify the Main and Delayed Trigger Systems

Equipment Required: One P6139A probe.

Prerequisites: None.

Procedure:

1. *Install the test hookup and preset the oscilloscope controls:*
 - a. *Hook up the signal source:* Install the probe on **CH 1**. Connect the probe tip to **PROBE COMPENSATION SIGNAL** on the front panel; connect the probe ground to **PROBE COMPENSATION GND**. (See Figure 1-3 on page 1-6.)
 - b. *Initialize the oscilloscope:*
 - Press save/recall **SETUP**.
 - Press the main-menu button **Recall Factory Setup**.
 - Press the side-menu button **OK Confirm Factory Init**.
 - c. *Modify default settings:*
 - Press **AUTOSET** to obtain a viewable, triggered display.
 - Set the horizontal **SCALE** for the **M** (main) time base to 200 μ s.
 - Press **TRIGGER MENU**.
 - Press the main-menu button **Mode & Holdoff**.
 - Press the side-menu button **Normal**.
 - Press **CLEAR MENU** to remove the menus from the screen.
2. *Verify that the main trigger system operates:* Confirm that the following statements are true.
 - The trigger level readout for the main trigger system changes with the trigger **LEVEL** knob.
 - The trigger-level knob can trigger and untrigger the square-wave signal as you rotate it. (Leave the signal *untriggered*.)
 - Pressing **SET LEVEL TO 50%** triggers the signal that you just left untriggered. (Leave the signal triggered.)
3. *Verify that the delayed trigger system operates:*
 - a. *Select the delayed time base:*
 - Press **HORIZONTAL MENU**.
 - Press the main-menu button **Time Base**.
 - Press the side-menu button **Delayed Triggerable**; then press the side-menu button **Delayed Only**.
 - Set the horizontal **SCALE** for the **D** (delayed) time base to 200 μ s.

- b. *Select the delayed trigger level menu:*
 - Press **SHIFT**; then press **DELAYED TRIG**.
 - Press the main-menu button **Level**; then press the side-menu button **Level**.
 - c. *Confirm that the following statements are true:*
 - The trigger-level readout for the delayed trigger system changes as you turn the general purpose knob.
 - The general purpose knob can trigger and untrigger the square-wave probe-compensation signal as you rotate it. (Leave the signal *untriggered*.)
 - Pressing the side-menu button **Set to 50%** triggers the probe-compensation signal that you just left untriggered. (Leave the signal triggered.)
 - d. *Verify the delayed trigger counter:*
 - Press the main-menu button **Delay by Time**.
 - Use the keypad to enter a delay time of 1 second (press **1** then press **ENTER**).
 - Verify that the trigger **READY** indicator on the front panel flashes about once every second as the waveform is updated on-screen.
4. *Remove the test hookup:* Disconnect the standard-accessory probe from the channel input and the probe-compensation terminals.

Verify the File System (Optional on TDS 520A and 540A)

Equipment Required: One P6139A probe and one 720 K or 1.44 Mbyte, 3.5 inch DOS compatible disk. You can use a disk of your own or you can use the Programming Examples Software 3.5 inch disk (Tektronix part number 063–1134–00) contained in the TDS Family Programmer Manual (Tektronix part number 070–8709–01).

Prerequisites: None.

Procedure:

1. *Install the test hookup and preset the oscilloscope controls:*
 - a. *Hook up the signal source:* Install the probe on **CH 1**. Connect the probe tip to **PROBE COMPENSATION SIGNAL** on the front panel; connect the probe ground to **PROBE COMPENSATION GND**. (See Figure 1-3 on page 1-6.)
 - b. *Insert the test disk:* Insert the disk in the disk drive to the left of the monitor.
 - Position the disk so the metal shutter faces the drive.
 - Position the disk so the stamped arrow is on the top right side. In other words, place the angled corner in the front bottom location.
 - Push the disk into the drive until it goes all the way in and clicks into place.
 - c. *Initialize the oscilloscope:*
 - Press save/recall **SETUP**.
 - Press the main-menu button **Recall Factory Setup**.
 - Press the side-menu button **OK Confirm Factory Init**.
 - d. *Modify default settings:*
 - Press **AUTOSET** to obtain a viewable, triggered display.
 - Set the horizontal **SCALE** for the **M** (main) time base to 200 μ s (one click clockwise). Notice the waveform on the display now shows two cycles instead of five.
 - Press **CLEAR MENU** to remove the menus from the screen.
 - e. *Save the settings:*
 - Press **SETUP**.
 - Press the main-menu button **Save Current Setup**; then press the side-menu button **To File**.
 - Turn the general purpose knob to select the file to save. Choose **TEK?????.SET** (or **fdo:**). With this choice, you'll save a file starting with **TEK**, then containing 5-numbers, and a **.SET** extension. For example, the first time you run this on a blank, formatted disk or on the Example Programs Disk, the TDS will assign the name **TEK00000.SET** to your file. If you ran the procedure again, the TDS would increment the name and call the file **TEK00001.SET**.

- Press the side-menu button **Save To Selected File**.
2. *Verify the file system works:*
- Press **AUTOSET** to restore the 500 μ s time base and the five cycle waveform.
 - Press the main-menu button **Recall Saved Setup**; then press the side-menu button **From File**.
 - Turn the general purpose knob to select the file to recall. For example, if you followed the instructions above and used a blank disk, you had the TDS assign the name TEK00000.SET to your file.
 - Press the side-menu button **Recall From Selected File**.
 - Verify that Digitizing Oscilloscope retrieved the saved setup from the disk. Do this by noticing the horizontal **SCALE** for the **M** (main) time base is again 200 μ s and the waveform shows only two cycles just as it was when you saved the setup.
3. *Remove the test hookup:*
- Disconnect the standard-accessory probe from the channel input and the probe-compensation terminals.
 - Remove the disk from the disk drive. Do this by pushing in the tab at the bottom of the disk drive.

Performance Tests

This subsection contains a collection of procedures for checking that TDS 520A, 524A, 540A, and 544A Digitizing Oscilloscopes perform as warranted. Since the procedures cover models with both two full-featured channels (TDS 520A and 524A) and four full-featured models (TDS 540A and 544A), instructions that apply only to one of the model types are clearly identified. Otherwise, all test instructions apply to both the two and four channel models.

The procedures are arranged in four logical groupings: *Signal Acquisition System Checks*, *Time Base System Checks*, *Triggering System Checks*, and *Output Ports Checks*. They check all the characteristics that are designated as checked in Section 2, *Specifications*. (The characteristics that are checked appear in **boldface** type under *Warranted Characteristics* in Section 2.)



These procedures *extend* the confidence level provided by the basic procedures described on page 1-1. The basic procedures should be done first, then these procedures performed if desired.

Prerequisites

The tests in this subsection comprise an extensive, valid confirmation of performance and functionality when the following requirements are met:

- The cabinet must be installed on the Digitizing Oscilloscope.
- You must have performed and passed the procedures under *Self Tests*, found on page 1-4, and those under *Functional Tests*, found on page 1-6.
- A signal-path compensation must have been done within the recommended calibration interval and at a temperature within $\pm 2^\circ \text{C}$ of the present operating temperature. (If at the time you did the prerequisite *Self Tests*, the temperature was within the limits just stated, consider this prerequisite met.)
- The Digitizing Oscilloscope must have been last adjusted at an ambient temperature between $+20^\circ \text{C}$ and $+30^\circ \text{C}$, must have been operating for a warm-up period of at least 20 minutes, and must be operating at an ambient temperature between $+4^\circ \text{C}$ and $+50^\circ \text{C}$. (The warm-up requirement is usually met in the course of meeting the first prerequisite listed above.)

Related Information — Read *General Instructions* and *Conventions* that start on page 1-1.

Equipment Required

These procedures use external, traceable signal sources to directly check warranted characteristics. The required equipment list is shown in Table 1-1.

Performance Tests

Table 1-1: Test Equipment

| Item Number and Description | Minimum Requirements | Example | Purpose |
|---|---|--|---|
| 1 Attenuator, 10X (three required) | Ratio: 10X; impedance 50 Ω; connectors: female BNC input, male BNC output | Tektronix part number 011-0059-02 | Signal Attenuation |
| 2 Attenuator, 5X | Ratio: 5X; impedance 50 Ω; connectors: female BNC input, male BNC output | Tektronix part number 011-0060-02 | Signal Attenuation |
| 3 Terminator, 50 Ω | Impedance 50 Ω; connectors: female BNC input, male BNC output | Tektronix part number 011-0049-01 | Signal Termination for Channel Delay Test |
| 4 Cable, Precision 50 Ω Coaxial (two required) | 50 Ω, 36 inch, male to male BNC connectors | Tektronix part number 012-0482-00 | Signal Interconnection |
| 5 Connector, Dual-Banana (two required) | Female BNC to dual banana | Tektronix part number 103-0090-00 | Various Accuracy Tests |
| 6 Connector, BNC "T" | Male BNC to dual female BNC | Tektronix part number 103-0030-00 | Checking Trigger Sensitivity |
| 7 Coupler, Dual-Input | Female BNC to dual male BNC | Tektronix part number 067-0525-02 | Checking Delay Between Channels |
| 8 Generator, DC Calibration | Variable amplitude to 10 V; accuracy to 0.1% | Data Precision 8200, with 1 kV option installed | Checking DC Offset, Gain, and Measurement Accuracy |
| 9 Generator, Calibration | 500 mV square wave calibrator amplitude; accuracy to 0.25% | PG 506A ¹ | To check accuracy of the CH 3 Signal Out (TDS 540A and 544A only) |
| 10 Generator, Leveled Sine Wave, Medium-Frequency | 200 kHz to 250 MHz; Variable amplitude from 5 mV to 5.5 V _{p-p} into 50 Ω | Tektronix SG 503 Leveled Sine Wave Generator ¹ | Checking Trigger Sensitivity at low frequencies |
| 11 Generator, Leveled Sine Wave, High-Frequency | 250 MHz to 500 MHz; Variable amplitude from 500 mV to 4 V _{p-p} into 50 Ω; 6 MHz reference | Tektronix SG 504 Leveled Sine Wave Generator ¹ with its Leveling Head | Checking Analog Bandwidth and Trigger Sensitivity at high frequencies |
| 12 Generator, Time Mark | Variable marker frequency from 10 ms to 10 ns; accuracy within 2 ppm | Tektronix TG 501 Time Mark Generator ¹ | Checking Sample-Rate and Delay-time Accuracy |
| 13 Generator, Calibration | 500 mV square wave calibrator amplitude; accuracy to 0.25% | PG 506A ¹ | Use to check accuracy of the CH 3 Output |

¹ Requires a TM 500 or TM 5000 Series Power Module Mainframe.

Table 1-1: Test Equipment (Cont.)

| Item Number and Description | Minimum Requirements | Example | Purpose |
|--|---|---|--|
| 14 Probe, 10X, included with this instrument | A P6139A probe | Tektronix number P6139A | Signal Interconnection |
| 15 Adapter, BNC female to Clip Leads | BNC female to Clip Leads | Tektronix part number 013-0076-00 | Signal Coupling for Probe Compensator Output Check |
| 16 Power Supply, Dual Output | 0-35 V and 60 V 2 A; current limit without foldback | Tektronix PS 280 Power Supply | Power Supply Troubleshooting |
| 17 3.5 inch, 720 K or 1.44 Mbyte, DOS-compatible floppy disk | | Programming Examples Software Disk (Tektronix part number 063-1134-00) that comes with the TDS Family Programmer Manual (Tektronix part number 070-8709-01) | Checking File System Basic Functionality |
| 18 Generator, Video Signal | Provides NTSC compatible outputs. | Tektronix TSG 121 | Used to Test Video Option 05 Equipped Instruments Only |
| 19 Oscillator, Leveled Sinewave Generator | 60 Hz. Sine Wave | Tektronix part number SG 502 | Used to Test Video Option 05 Equipped Instruments Only |
| 20 Pulse Generator | | Tektronix part number PG 502 | Used to Test Video Option 05 Equipped Instruments Only |
| 21 Cable, 75 Ω Coaxial | 75 Ω , 36 inch, male to male BNC connectors | Tektronix part number 012-1338-00 | Used to Test Video Option 05 Equipped Instruments Only |
| 22 Termination, 75 Ω | Impedance 75 Ω ; connectors: female BNC input, male BNC output | Tektronix part number 011-0102-01 | Used to Test Video Option 05 Equipped Instruments Only |

Test Record

Photocopy the next four pages and use them to record the performance test results for your instrument.

TDS 500A Test Record

Instrument Serial Number: _____ Certificate Number: _____
 Temperature: _____ RH %: _____
 Date of Calibration: _____ Technician: _____

| Performance Test | Minimum | Incoming | Outgoing | Maximum |
|---|---|-------------|----------|-------------|
| Offset Accuracy | | | | |
| CH1 Offset | +1 mV | - 1.6 mV | _____ | + 1.6 mV |
| | +100 mV | - 25 mV | - _____ | + 25 mV |
| | +1 V | 250 mV | _____ | + 250 mV |
| CH2 Offset | +1 mV | - 1.6 mV | _____ | + 1.6 mV |
| | +100 mV | - 25 mV | - _____ | + 25 mV |
| | +1 V | 250 mV | _____ | + 250 mV |
| CH3 Offset | +1 mV | - 1.6 mV | _____ | + 1.6 mV |
| | +100 mV | - 25 mV | - _____ | + 25mV |
| | +1 V | 250 mV | _____ | + 250 mV |
| CH4 Offset | +1 mV | - 1.6 mV | _____ | + 1.6 mV |
| | +100 mV | - 25 mV | - _____ | + 25 mV |
| | +1 V | 250 mV | _____ | + 250 mV |
| DC Voltage Measurement Accuracy (Averaged) | | | | |
| CH1 | 5 mV Vert scale setting, -5 Div position setting | + 1.0355 V | _____ | + 1.0445 V |
| CH1 | 5 mV Vert scale setting, +5 Div position setting | - 1.0445 V | _____ | - 1.0355 V |
| CH1 | 200 mV Vert scale setting, -5 Div position setting | + 11.525 V | _____ | + 11.675 V |
| CH1 | 200 mV Vert scale setting, +5 Div position setting | - 11.675 V | _____ | - 11.525 V |
| CH1 | 1 V Vert scale setting, -5 Div position setting | + 107.450 V | _____ | + 108.550 V |
| CH1 | 1 V Vert scale setting, +5 Div position setting | - 108.550 V | _____ | - 107.450 V |
| CH2 | 5 mV Vert scale setting, -5 Div position setting | + 1.0355 V | _____ | + 1.0445 V |
| CH2 | 5 mV Vert scale setting, +5 Div position setting | - 1.0445 V | _____ | - 1.0355 V |

Performance Tests

TDS 500A Test Record (Cont.)

Instrument Serial Number: _____ Certificate Number: _____
 Temperature: _____ RH %: _____
 Date of Calibration: _____ Technician: _____

| Performance Test | | Minimum | Incoming | Outgoing | Maximum |
|------------------|---|-------------|----------|----------|-------------|
| CH2 | 200 mV Vert scale setting, -5 Div position setting | + 11.525 V | _____ | _____ | + 11.675 V |
| CH2 | 200 mV Vert scale setting, +5 Div position setting | - 11.675 V | _____ | _____ | - 11.525 V |
| CH2 | 1 V Vert scale setting, -5 Div position setting | + 107.450 V | _____ | _____ | + 108.550 V |
| CH2 | 1 V Vert scale setting, +5 Div position setting | - 108.550 V | _____ | _____ | - 107.450 V |
| CH3 | 5 mV Vert scale setting, -5 Div position setting | + 1.0355 V | _____ | _____ | + 1.0445 V |
| CH3 | 5 mV Vert scale setting, +5 Div position setting | - 1.0445 V | _____ | _____ | - 1.0355 V |
| CH3 | 200 mV Vert scale setting, -5 Div position setting | + 11.525 V | _____ | _____ | + 11.675 V |
| CH3 | 200 mV Vert scale setting, +5 Div position setting | - 11.675 V | _____ | _____ | - 11.525 V |
| CH3 | 1 V Vert scale setting, -5 Div position setting | + 107.450 V | _____ | _____ | + 108.550 V |
| CH3 | 1 V Vert scale setting, +5 Div position setting | - 108.550 V | _____ | _____ | - 107.450 V |
| CH4 | 5 mV Vert scale setting, -5 Div position setting | + 1.0355 V | _____ | _____ | + 1.0445 V |
| CH4 | 5 mV Vert scale setting, +5 Div position setting | - 1.0445 V | _____ | _____ | - 1.0355 V |
| CH4 | 200 mV Vert scale setting, -5 Div position setting | + 11.525 V | _____ | _____ | + 11.675 V |
| CH4 | 200 mV Vert scale setting, +5 Div position setting | - 11.675 V | _____ | _____ | - 11.525 V |
| CH4 | 1 V Vert scale setting, -5 Div position setting | + 107.450 V | _____ | _____ | + 108.550 V |
| CH4 | 1 V Vert scale setting, +5 Div position setting | - 108.550 V | _____ | _____ | - 107.450 V |

TDS 500A Test Record (Cont.)

Instrument Serial Number: _____ Certificate Number: _____
 Temperature: _____ RH %: _____
 Date of Calibration: _____ Technician: _____

| Performance Test | Minimum | Incoming | Outgoing | Maximum |
|---|----------------------------|----------|----------|-----------------------------|
| Analog Bandwidth | | | | |
| CH1 100 mV | 424 mV | _____ | _____ | N/A |
| CH2 100 mV | 424 mV | _____ | _____ | N/A |
| CH3 100 mV | 424 mV | _____ | _____ | N/A |
| CH4 100 mV | 424 mV | _____ | _____ | N/A |
| Delay Between Channels | | | | |
| Delay Between Channels | N/A | _____ | _____ | 250 ps |
| Time Base System | | | | |
| Long Term Sample Rate/ Delay Time @ 500 ns/10 ms | -2.5 Div | _____ | _____ | +2.5 Div |
| Delta Time @ 5 ns (100 MHz) | 19.760 ns | _____ | _____ | 20.240 ns |
| Trigger System Accuracy | | | | |
| Pulse-Glitch or Pulse-Width, Hor. scale $\leq 1 \mu\text{s}$ | | | | |
| Lower Limit | 2.5 ns | _____ | _____ | 7.5 ns |
| Upper Limit | 2.5 ns | _____ | _____ | 7.5 ns |
| Pulse-Glitch or Pulse-Width, Hor. scale $> 1 \mu\text{s}$ | | | | |
| Lower Limit | 1 μs | _____ | _____ | 3 μs |
| Upper Limit | 1 μs | _____ | _____ | 3 μs |
| Main Trigger, DC Coupled) | 9.940 V | _____ | _____ | 10.060 V |
| Delayed Trigger, DC Coupled) | 9.940 V | _____ | _____ | 10.060 V |
| Output Signal Checks | | | | |
| MAIN TRIGGER OUTPUT, 1 M Ω | High $\geq 2.5 \text{ V}$ | _____ | _____ | Low $\leq 0.7 \text{ V}$ |
| MAIN TRIGGER OUTPUT, 50 Ω | High $\geq 1.0 \text{ V}$ | _____ | _____ | Low $\leq 0.25 \text{ V}$ |
| DELAYED TRIGGER OUTPUT, 50 Ω | High $\geq 1.0 \text{ V}$ | _____ | _____ | Low $\leq 0.25 \text{ V}$ |
| DELAYED TRIGGER OUTPUT, 1 M Ω | High $\geq 2.5 \text{ V}$ | _____ | _____ | Low $\leq 0.7 \text{ V}$ |
| CH 3 SIGNAL OUTPUT, 1 M Ω | Pk-Pk $\geq 90 \text{ mV}$ | _____ | _____ | Pk-Pk $\leq 110 \text{ mV}$ |
| CH 3 SIGNAL OUTPUT, 50 Ω | Pk-Pk $\geq 45 \text{ mV}$ | _____ | _____ | Pk-Pk $\leq 55 \text{ mV}$ |

Performance Tests

TDS 500A Test Record (Cont.)

Instrument Serial Number: _____ Certificate Number: _____
Temperature: _____ RH %: _____
Date of Calibration: _____ Technician: _____

| Performance Test | Minimum | Incoming | Outgoing | Maximum |
|--|----------------|-----------------|-----------------|----------------|
| Probe Compensator Output Signal | | | | |
| Frequency (CH1 Freq.) | 950 Hz | _____ | _____ | 1050 Hz |
| Voltage (difference) | 495 mV | _____ | _____ | 505 mV |

Signal Acquisition System Checks

These procedures check those characteristics that relate to the signal-acquisition system and are listed as checked under *Warranted Characteristics* in Section 2, *Specifications*.

Check Accuracy of Offset (Zero Setting)

Equipment Required: None.

Prerequisites: The oscilloscope must meet the prerequisites listed on page 1-15.

1. *Preset the instrument controls:*
 - a. *Initialize the oscilloscope:*
 - Press save/recall **SETUP**.
 - Press the main-menu button **Recall Factory Setup**.
 - Press the side-menu button **OK Confirm Factory Init**.
 - Press **CLEAR MENU** to remove the menus from the screen.
 - b. *Modify the default settings:*
 - Set the horizontal **SCALE** to 1 ms.
 - Press **SHIFT**; then **ACQUIRE MENU**.
 - Press the main-menu button **Mode**; then press the side-menu button **Hi Res**.
 - Press **DISPLAY**.
 - Press the main-menu button **Graticule**; then press the side-menu button **Frame**.
 - Press **CURSOR**.
 - Press the main-menu button **Function**; then press the side-menu button **H Bars**.
 - Press **CLEAR MENU**.
2. *Confirm input channels are within limits for offset accuracy at zero offset:* Do the following substeps — test CH 1 first, *skipping substep a since CH 1 is already set up to be checked from step 1*.
 - a. *Select an unchecked channel:* Press **WAVEFORM OFF** to remove the channel just confirmed from the display. Then, press the front-panel button that corresponds to the channel you are to confirm.



Follow these rules to match this procedure to the model of the oscilloscope under test:

Models TDS 540A, 544A Only—When using Table 1-2 to test CH 1—CH 4; ignore the columns for AUX 1 & AUX 2 settings and limits.

Model TDS 520A, 524A Only—Use Table 1-2 to test input channels; use the columns for CH 1—CH 4 when testing CH 1 and CH 2; use the columns for AUX 1 and AUX 2 when testing those channels.

Table 1-2: DC Offset Accuracy (Zero Setting)

| Vertical Scale Setting | | Vertical Position and Offset Setting ¹ | Offset Accuracy Limits | |
|------------------------|---------------|---|------------------------|---------------|
| CH 1 – CH 4 | AUX 1 & AUX 2 | | CH 1 – CH 4 | AUX 1 & AUX 2 |
| 1 mV | 100 mV | 0 | ± mV | ± mV |
| 100 mV | 1 V | 0 | ± mV | ± mV |
| 1 V | 10 V | 0 | ± mV | ± V |

¹Vertical position is set to 0 divisions and vertical offset to 0 V when the oscilloscope is initialized in step 1.

- b. *Set the vertical scale:* Set the vertical **SCALE** to one of the settings listed in Table 1-2 that is not yet checked. (Start with the first setting listed.)
 - c. *Display the test signal:* The baseline DC test level was initialized for all channels in step 1 and is displayed as you select each channel and its vertical scale. Be sure *not* to use the vertical **POSITION** knob while checking any channel for accuracy of offset, since varying the position invalidates the check.
 - d. *Measure the test signal:* Rotate the general purpose knob to superimpose the active cursor over the baseline DC test level. (Ignore the other cursor.)
 - e. Read the measurement results at the absolute (@:) cursor readout, not the delta (Δ:) readout on screen (see Figure 1-4).
 - f. *Check against limits:* Do the following subparts in the order listed.
 - CHECK that the measurement results are within the limits listed for the current vertical scale setting.
 - Repeat substeps b through f until all vertical scale settings settings listed in Table 1-2 are checked for the channel under test.
 - g. *Test all channels:* Repeat substeps a through f for all input channels.
3. *Disconnect the hookup:* No hookup was required.

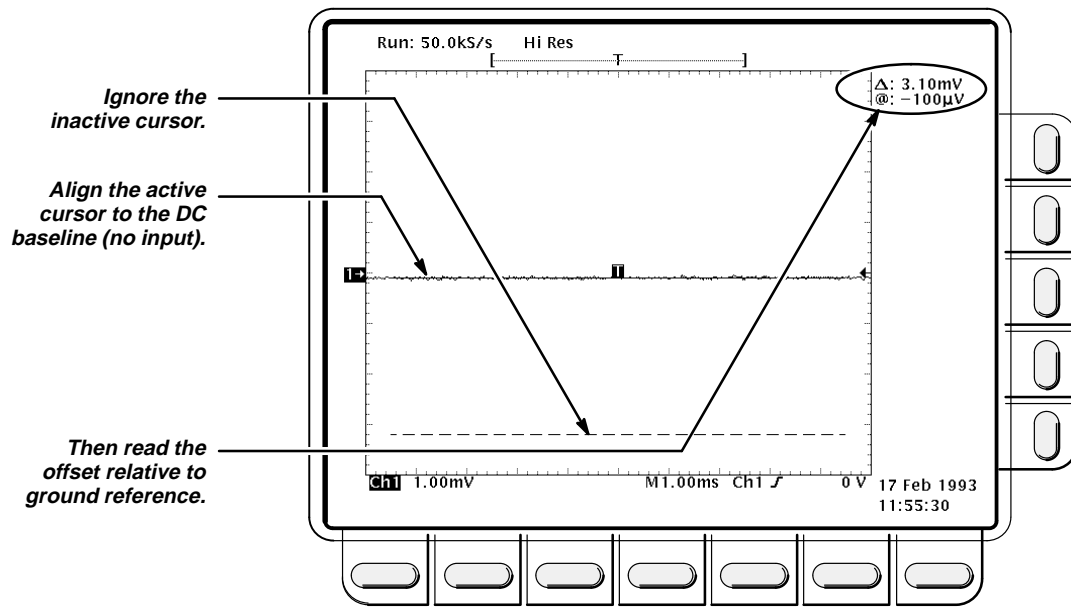

Figure 1-4: Measurement of DC Offset Accuracy at Zero Setting

Check DC Gain and Voltage Measurement Accuracy

WARNING

Performance of this procedure requires input voltages up to 130 VDC. Be sure to set the DC calibration generator to 0 volts before connecting, disconnecting, and/or moving the test hookup during the performance of this procedure.

Equipment Required: Two dual-banana connectors (Item 5), one BNC T connector (Item 6), one DC calibration generator (Item 8), and two precision coaxial cables (Item 4).

Prerequisites: The oscilloscope must meet the prerequisites listed on page 1-15.

Procedure:

1. *Install the test hookup and preset the instrument controls (see Figure 1-5):*

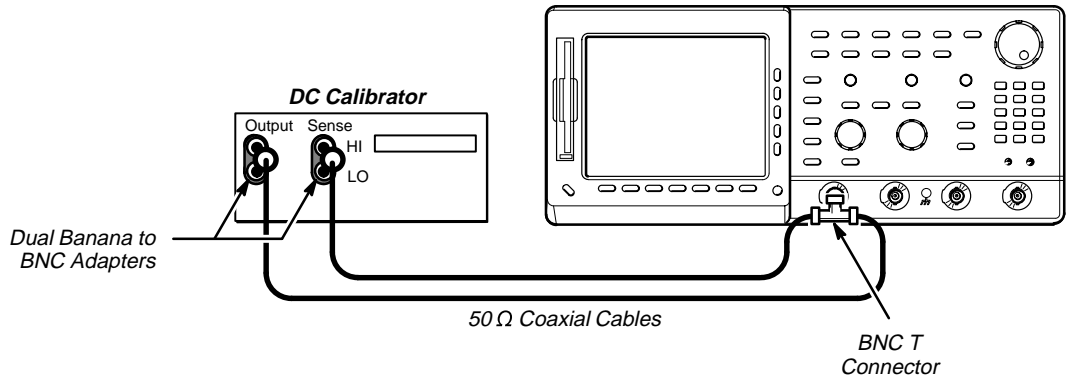

Figure 1-5: Initial Test Hookup

- a. *Hook up the test-signal source:*
 - Set the output of a DC calibration generator to 0 volts.
 - Connect the output of a DC calibration generator through a dual-banana connector followed by a 50 Ω precision coaxial cable to one side of a BNC T connector.
 - Connect the Sense output of the generator through a second dual-banana connector followed by a 50 Ω precision coaxial cable to the other side of the BNC T connector. Now connect the BNC T connector to **CH 1**.
- b. *Initialize the oscilloscope:*
 - Press save/recall **SETUP**.
 - Press the main-menu button **Recall Factory Setup**.
 - Press the side-menu button **OK Confirm Factory Init**.
- c. *Modify the default settings:*
 - Press **SHIFT**; then **ACQUIRE MENU**.
 - Press the main-menu button **Mode**; then press the side-menu button **Average 16**.
 - Press **CURSOR**.
 - Press the main-menu button **Function**; then press the side-menu button **H Bars**.
 - Press **DISPLAY**.

- Press the main-menu button **Graticule**; then press the side-menu button **Frame**.
2. *Confirm input channels are within limits for DC delta voltage accuracy: Do the following substeps — test CH 1 first, skipping substep a since CH 1 is already selected from step 1.*
- a. *Select an unchecked channel:*
 - Set the generator output to 0 V.
 - Press **WAVEFORM OFF** to remove the channel just confirmed from the display.
 - Press the front-panel button that corresponds to the next channel you are to confirm.
 - Move the test hook up to the channel you select.
 - b. *Display the test signal:*
 - Press **VERTICAL MENU**. Press the main-menu button **Position**.
 - Use the keypad to set vertical position to -2.5 divisions (press **-2.5**, then **ENTER**, on the keypad).
 - c. *Measure the test signal:*
 - Press **CURSOR**. Use the general purpose knob to precisely align the active cursor to the DC baseline level on screen.
 - Set the generator output to 500 mV.
 - Press **SELECT**. Use the general purpose knob to precisely align the alternate cursor to the 500 mV DC test level on screen.
 - Press **CLEAR MENU**. Read the measurement results from the delta (Δ) readout, not the absolute (@:) readout. See Figure 1-6 on page 1-28.
 - d. *Check against limits:* CHECK that the Δ : readout on screen is within 485 mV to 515 mV (see Figure 1-6).

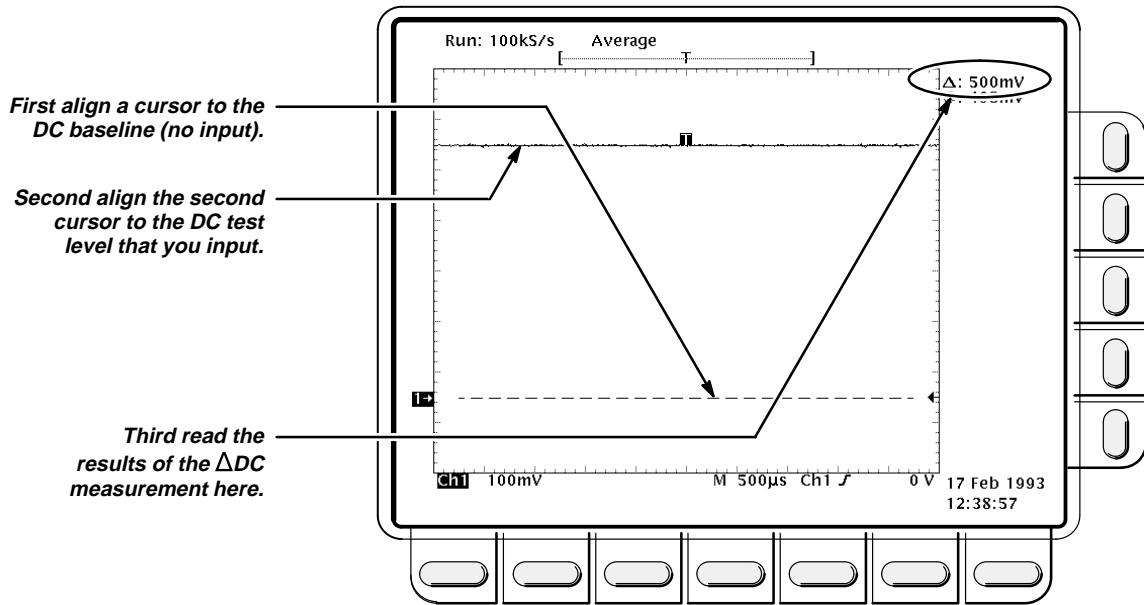

Figure 1-6: Measurement of the DC Accuracy for Delta Measurements

- e. *Test all channels:* Repeat substeps a through d for all four channels.
3. *Reestablish the initial test hookup setup:*
 - a. *Hook up the test-signal source:*
 - Set the output of a DC calibration generator to 0 volts.
 - Move the BNC T connector back to **CH 1**.
 - b. *Initialize the oscilloscope:*
 - Press save/recall **SETUP**.
 - Press the main-menu button **Recall Factory Setup**.
 - Press the side-menu button **OK Confirm Factory Init**.
 - c. *Modify the default settings:*
 - Press **SHIFT**; then **ACQUIRE MENU**.
 - Press the main-menu button **Mode**; then press the side-menu button **Average 16**.
 - Press **DISPLAY**.
 - Press the main-menu button **Graticule**; then press the side-menu button **Frame**.

4. *Confirm input channels are within limits for DC accuracy at maximum offset and position:* Do the following substeps — test CH 1 first, *skipping substep a since CH 1 is already selected from step 3.*
- a. *Select an unchecked channel:*
 - Press **WAVEFORM OFF** to remove the channel just confirmed from the display.
 - Press the front-panel button that corresponds to the channel you are to confirm.
 - *Set the generator output to 0 V.*
 - Move the test hookup to the channel you select.
 - b. *Turn on the measurement Mean for the channel:*
 - Press **MEASURE**, then press the main-menu button **Select Measrmnt for CHx**.
 - Press the side menu button **more** until the menu label **Mean** appears in the side menu (its icon is shown at the left). Press the side-menu button **Mean**.
 - Press **CLEAR MENU**.



Follow these rules to match this procedure to the model of the oscilloscope under test:

Models TDS 540A, 544A Only—Use Table 1-3 to test CH 1—CH 4; ignore Table 1-4 AUX 1 & AUX 2 settings and limits.

Model TDS 520A, 524A Only—Use Table 1-3 to test CH 1 and CH 2 only; use Table 1-4 to test AUX 1 and AUX 2 only.

- c. *Set its vertical scale:* Set the vertical **SCALE** to one of the settings listed in Table 1-3 (and Table 1-4 for the TDS 520A and 524A) that is not yet checked. (Start with the first setting listed.)

Table 1-3: DC Accuracy: CH 1—CH 4

| Scale Setting | Position Setting (Divs) | Offset Setting | Generator Setting | Accuracy Limits |
|---------------|-------------------------|----------------|-------------------|--------------------------|
| 5 mV | –5 | +1 V | +1.040 V | +1.0355 V to +1.0445 V |
| | +5 | –1 V | –1.040 V | –1.0355 V to –1.0445 V |
| 200 mV | –5 | +10 V | +11.6 V | +11.525 V to +11.675 V |
| | +5 | –10 V | –11.6 V | –11.525 V to –11.675 V |
| 1 V | –5 | +100 V | +108 V | +107.450 V to +108.550 V |
| | +5 | –100 V | –108 V | –107.450 V to –108.550 V |

Table 1-4: DC Accuracy: AUX 1–AUX 2

| Scale Setting | Position Setting (Divs) | Offset Setting | Generator Setting | Accuracy Limits |
|---------------|-------------------------|----------------|-------------------|------------------------|
| 100 mV | –5 | +0.5 V | +1.3 V | +1.271 V to +1.329 V |
| | +5 | –0.5 V | –1.3 V | –1.271 V to –1.329 V |
| 1 V | –5 | +5 V | +13 V | +12.710 V to +13.290 V |
| | +5 | –5 V | –13 V | –12.710 V to –13.290 V |
| 10 V | –5 | +50 V | +130 V | +127.10 V to +132.90 V |
| | +5 | –50 V | –130 V | –127.10 V to –132.90 V |

d. *Display the test signal:*

- Press **VERTICAL MENU**. Press the main-menu button **Position**.
- Use the keypad to set vertical position to –5 divisions (press **–5**, then **ENTER**, on the keypad). The baseline level will move off screen.
- Press the main-menu button **Offset**.
- Use the keypad to set vertical offset to the positive-polarity setting listed in the table for the current vertical scale setting. The baseline level will remain off screen.
- Set the generator to the level and polarity indicated in the table for the vertical scale, position, and offset settings you have made. The DC test level should appear on screen. (If it doesn't return, the DC accuracy check is failed for the current vertical scale setting of the current channel.)

e. *Measure the test signal:* Press **CLEAR MENU**. Read the measurement results at the **Mean** measurement readout. See Figure 1-7.

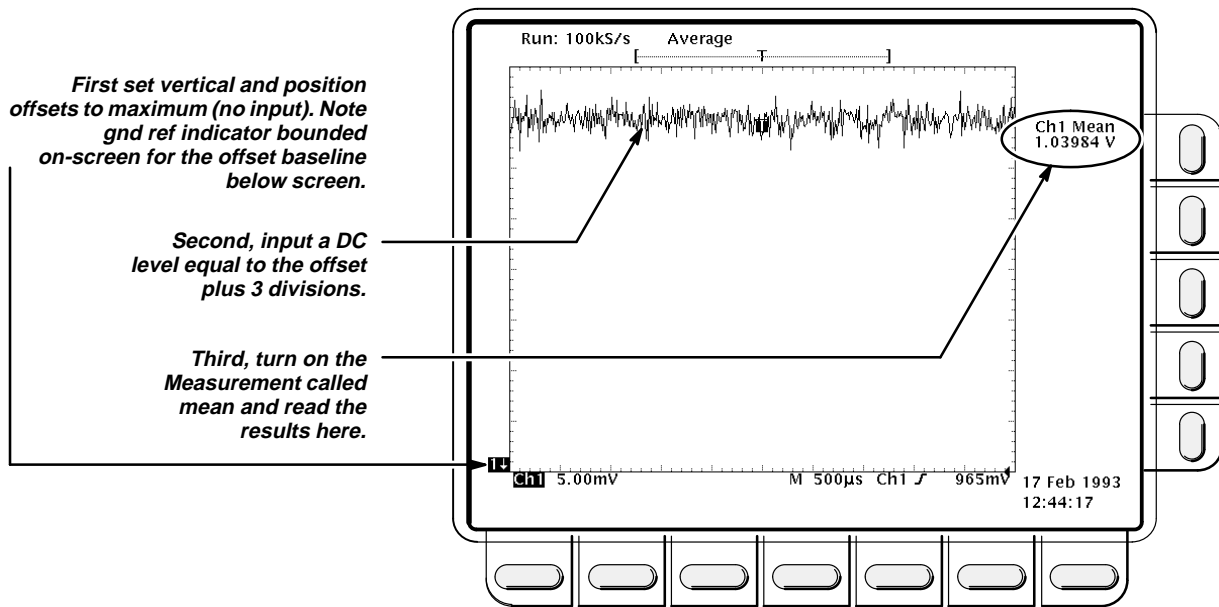

Figure 1-7: Measurement of DC Accuracy at Maximum Offset and Position

- f. *Check against limits:*
 - CHECK that the readout for the measurement **Mean** readout on screen is within the limits listed for the current vertical scale and position/offset/generator settings.
 - Repeat step d, reversing the polarity of the position, offset, and generator settings as is listed in the table.
 - CHECK that the **Mean** measurement readout on screen is within the limits listed for the current vertical scale setting and position/offset/generator settings.
 - Repeat substeps c through f until all vertical scale settings listed in Table 1-3 (and Table 1-4 for the TDS 520A and 524A) are checked for the channel under test.
- g. *Test all channels:* Repeat substeps a through f for all four channels.
5. *Disconnect the hookup:*
 - a. *Set the generator output to 0 V.*
 - b. Then disconnect the cable from the generator output at the input connector of the channel last tested.

Check Analog Bandwidth

Equipment Required: One high-frequency leveled sine wave generator and its leveling head (Item 11), plus two 10X attenuators (Item 1).

Prerequisites: See page 1-15.

Procedure:

1. *Install the test hookup and preset the instrument controls:*
 - a. *Initialize the oscilloscope:*
 - Press save/recall **SETUP**.
 - Press the main-menu button **Recall Factory Setup**.
 - Press the side-menu button **OK Confirm Factory Init**.
 - b. *Modify the default settings:*
 - Set the horizontal **SCALE** to 50 ns.
 - Now press **SHIFT**, then **ACQUIRE MENU**.
 - Press the main-menu button **Mode**; then press the side-menu button **Average 16**.
 - Press **TRIGGER MENU**.
 - Press the main-menu button **Coupling**; then press the side-menu button **Noise Rej**.
 - Press **Measure**. Now press the main-menu button **High–Low Setup**; then press the side-menu button **Min–Max**.
 - c. *Hook up the test-signal source:* Connect, through its leveling head, the sine wave output of a high-frequency leveled sine wave generator to **CH 1**. Set the output of the generator to a reference frequency of 6 MHz. See Figure 1-8.

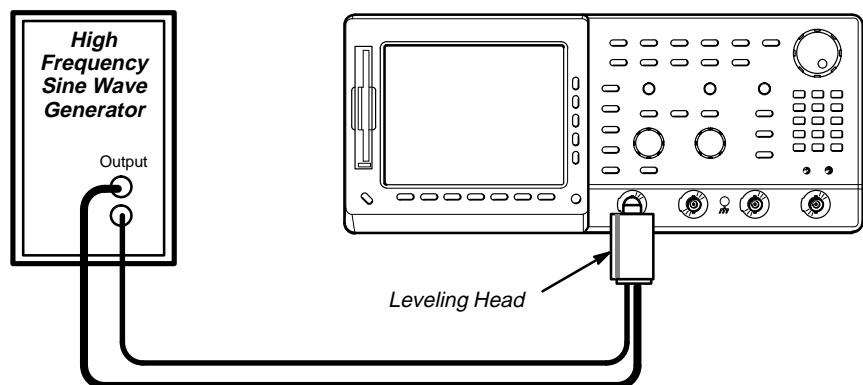

Figure 1-8: Initial Test Hookup

2. *Confirm the input channels are within limits for analog bandwidth: Do the following substeps — test CH 1 first, skipping substeps a and b since CH 1 is already set up for testing from step 1.*
 - a. *Select an unchecked channel:*
 - Press **WAVEFORM OFF** to remove the channel just confirmed from display.
 - Press the front-panel button that corresponds to the channel you are to confirm.
 - Move the leveling head to the channel you select.
 - b. *Match the trigger source to the channel selected:*
 - Press **TRIGGER MENU**.
 - Press the main-menu button **Source**.
 - Press the side-menu button that corresponds to the channel selected.
 - c. *Set its input impedance:*
 - Press **VERTICAL MENU**; then press the main-menu button **Coupling**.
 - Press the side-menu **Ω** button to toggle it to the **50 Ω** setting.
 - d. *Set the vertical scale: Set the vertical **SCALE** to one of the settings listed in Table 1-5 not yet checked. (Start with the 100 mV setting.)*

Table 1-5: Analog Bandwidth

| Vertical Scale | Attenuators (10X) | Reference Amplitude (at 6 MHz) | Horizontal Scale | Test Frequency | Limits |
|----------------|-------------------|--------------------------------|------------------|----------------|-----------|
| 100 mV | none | 600 mV (6 divisions) | 1 ns | 500 MHz | ≥ 424 mV |
| 1 V | none | 5 V (5 divisions) | 1 ns | 500 MHz | ≥ 3.535 V |
| 500 mV | none | 3 V (6 divisions) | 1 ns | 500 MHz | ≥ 2.121 V |
| 200 mV | none | 1.2 V (6 divisions) | 1 ns | 500 MHz | ≥ 848 mV |
| 50 mV | 1 | 300 mV (6 divisions) | 1 ns | 500 MHz | ≥ 212 mV |
| 20 mV | 1 | 120 mV (6 divisions) | 1 ns | 500 MHz | ≥ 84 mV |
| 10 mV | 1 | 60 mV (6 divisions) | 1 ns | 500 MHz | ≥ 42 mV |
| 5 mV | 2 | 30 mV (6 divisions) | 1 ns | 500 MHz | ≥ 21 mV |
| 2 mV | 2 | 12 mV (6 divisions) | 2 ns | 350 MHz | ≥ 8.48 mV |



- e. *Display the test signal:* Do the following subparts to first display the reference signal and then the test signal.
 - Press **MEASURE**; then press the main-menu button **Select Measrmt for CHx**.
 - Now press the side menu button **more** until the menu label **Pk-Pk** appears in the side menu (its icon is shown at the left). Press the side-menu button **Pk-Pk**.
 - Press **CLEAR MENU**.
 - Set the generator output so the CHx Pk-Pk readout equals the reference amplitude in Table 1-5 that corresponds to the vertical scale set in substep d.
 - Press the front-panel button **SET LEVEL TO 50%** as necessary to trigger a stable display.

- f. *Measure the test signal:*
 - Increase the frequency of the generator output to the test frequency in Table 1-5 that corresponds to the vertical scale set in substep d.
 - Set the horizontal **SCALE** to 1 ns. Press **SET LEVEL TO 50%** as necessary.
 - Read the results at the CHx Pk-Pk readout, which will automatically measure the amplitude of the test signal. See Figure 1-9.

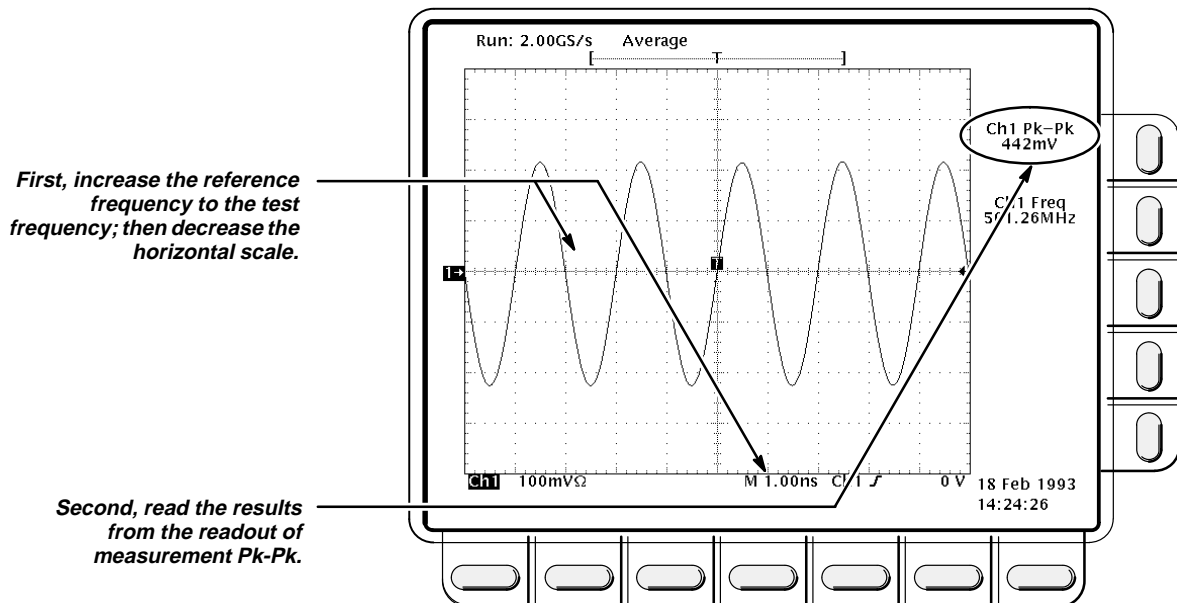

Figure 1-9: Measurement of Analog Bandwidth

g. *Check against limits:*

- CHECK that the **Pk-Pk** readout on screen is within the limits listed in Table 1-5 for the current vertical scale setting.
- When finished checking, set the horizontal **SCALE** back to the 50 ns setting.



Checking each channel's bandwidth at all vertical scale settings is time consuming and unnecessary. You may skip checking the remaining vertical scale settings in Table 1-5 (that is, skip the following substep, h) if this digitizing oscilloscope has performed as follows:

- Passed the 100 mV vertical scale setting just checked in this procedure.
- Passed the *Verify Internal Adjustment, Self Compensation, and Diagnostics* procedure found under *Self Tests*, on page 1-4.

NOTE

Passing the signal path compensation confirms the signal path for all vertical scale settings for all channels. Passing the internal diagnostics ensures that the factory-set adjustment constants that control the bandwidth for each vertical scale setting have not changed.

h. *Check remaining vertical scale settings against limits (optional):*

- If desired, finish checking the remaining vertical scale settings for the channel under test by repeating substeps d through g for each of the remaining scale settings listed in Table 1-5 for the channel under test.
- When doing substep e, skip the subparts that turn on the CHx Pk-Pk measurement until you check a new channel.
- Install/remove 10X attenuators between the generator leveling head and the channel input as is needed to obtain the six division reference signals listed in the table.

i. *Test all channels:* Repeat substeps a through g for all four channels.

3. *Disconnect the hookup:* Disconnect the test hook up from the input connector of the channel last tested.

Check Delay Between Channels

Equipment Required: One medium-frequency leveled sine-wave generator (Item 10), one precision, 50 Ω coaxial cable (Item 4), one 50 Ω terminator (Item 3), and a dual-input-coupler (Item 7).

Prerequisites: See page 1-15.

Procedure:



DO NOT use the vertical position knob to reposition any channel while doing this check. To do so invalidates the test.

1. *Install the test hookup and preset the instrument controls:*
 - a. *Initialize the front panel;*
 - Press save/recall **SETUP**.
 - Press the main-menu button **Recall Factory Setup**.
 - Press the side-menu button **OK Confirm Factory Init**.
 - b. *Modify the initialized front-panel control settings:*
 - Do *not* adjust the vertical position of any channel during this procedure.
 - Set the horizontal **SCALE** to 500 ps.
 - Press **SHIFT**; then **ACQUIRE MENU**.
 - Press the main-menu button **Mode**, and then press the side-menu button **Average 16**.
 - c. *Hook up the test-signal source:*
 - Connect, through a 50 Ω precision coaxial cable, followed by a 50 Ω termination, the sine wave output of a medium-frequency sine wave generator to a dual-input coupler. See Figure 1-10.

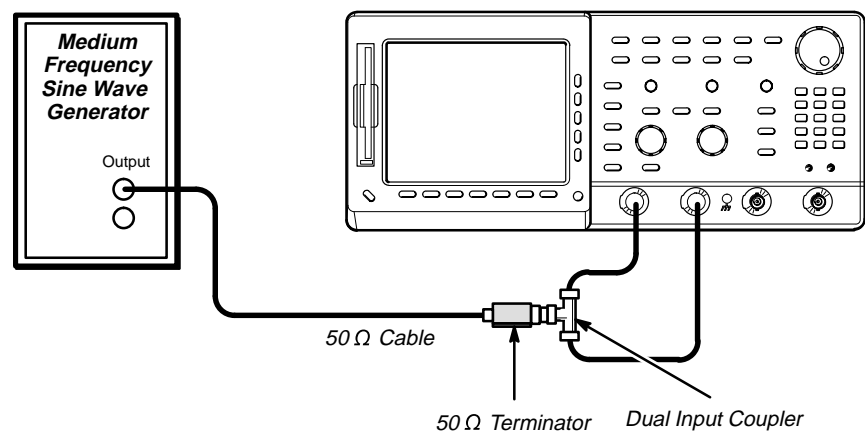

Figure 1-10: Initial Test Hookup

- Connect the coupler to both **CH 1** and **CH 2**.
2. *Confirm CH 1 through CH 4 (CH 2 for 520A and 524A) are within limits for channel delay:*

- a. *Set up the generator:* Set the generator frequency to 250 MHz and the amplitude for about five divisions in CH 1.

Hint: as you are adjusting the generator amplitude, push **SET LEVEL TO 50%** frequently to speed up the updating of the waveform amplitude on screen.



TDS 520A and 524A only: Press CH 2; then skip to substep e and continue this check. If testing a TDS 540A or 544A model, continue with the next substep, b.

- b. *Save a CH 2 waveform:* Press **CH 2**; then press save/recall **WAVEFORM**. Now, press the main-menu button **Save Wfm Ch2**; then press the side-menu button **To Ref 2**.
- c. *Save CH 3 waveform:* Move the coupler from **CH 2** to **CH 3**, so that **CH 1** and **CH 3** are driven. Press **CH 3**; then press the side-menu button **To Ref 3**.
- d. *Display all test signals:*
- Press **WAVEFORM OFF** twice to remove CH 2 and CH 3 from the display.
 - Move the coupler from **CH 3** to **CH 4**, so that CH 1 and CH 4 are driven. Press **CH 4**.
 - Now, press the front-panel button **MORE**. Press the main-menu buttons **Ref 2** and **Ref 3**.
- e. *Measure the test signal:*
- Locate the point on the rising edge of the left-most waveform where it crosses the center horizontal graticule line. This is the *time reference point* for this waveform. Note the corresponding *time reference point* for right-most waveform. See Figure 1-11.
 - Press **CURSOR**; then press the side-menu button **V Bars**.
 - Press **CLEAR MENU**.
 - Rotate the General Purpose knob to align one cursor to the *time reference point* of the left-most waveform edge and the other cursor to the *time reference point* of the right-most waveform edge. (Press **SELECT** to switch between the two cursors.) See Figure 1-11.

- Read the measurement results at the Δ : cursor readout, not the @: readout on screen.

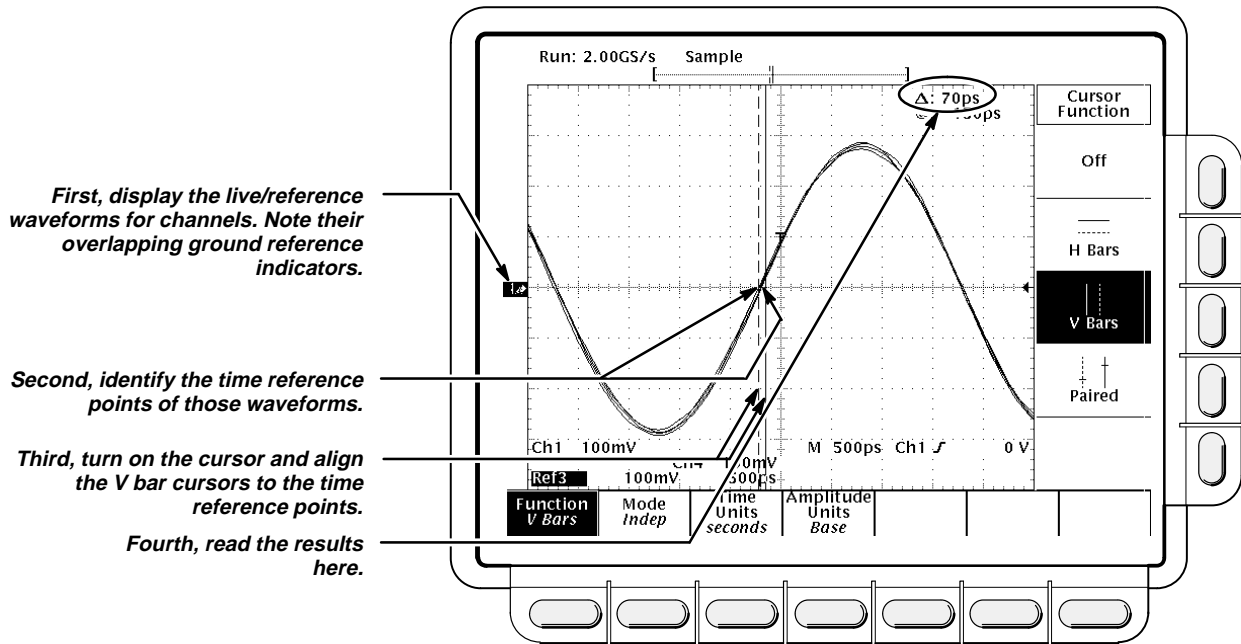

Figure 1-11: Measurement of Channel Delay

- f. *Check against limits:* CHECK that the cursor readout on screen is ≤ 250 ps.
3. *Disconnect the hookup:* Disconnect the cable from the generator output at the input connectors of the channels.

Time Base System Checks

These procedures check those characteristics that relate to the Main and Delayed time base system and are listed as checked under *Warranted Characteristics* in Section 2, *Specifications*.

Check Accuracy for Long-Term Sample Rate, Delay Time, and Delta Time Measurements

Equipment Required: One time-mark generator (Item 12) and one precision coaxial cable (Item 4).

Prerequisites: See page 1-15.

Procedure:

1. *Install the test hookup and preset the instrument controls:*
 - a. *Hook up the test-signal source:* Connect, through a 50 Ω precision coaxial cable, the time-mark output of a time-mark generator to **CH 1**. Set the output of the generator for 10 ms markers. See Figure 1-12.

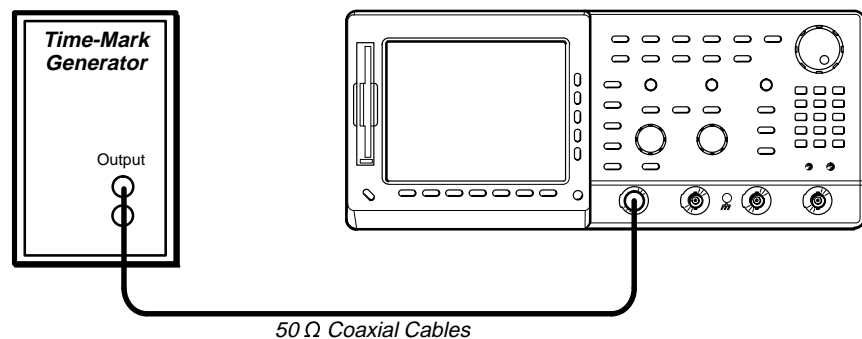

Figure 1-12: Initial Test Hookup

- b. *Initialize the oscilloscope:*
 - Press save/recall **SETUP**.
 - Press the main-menu button **Recall Factory Setup**.
 - Press the side-menu button **OK Confirm Factory Init**.
- c. *Modify the initialized front-panel control settings:*
 - Set the vertical **SCALE** to 500 mV.
 - Press **VERTICAL MENU**; then press the main-menu button **Coupling**. Press the side-menu **Ω** button to **50 Ω** .
 - Press **SET LEVEL TO 50%**.
 - Use the vertical **POSITION** knob to center the test signal on screen.
 - Set the horizontal **SCALE** of the Main time base to 1 ms.

- Press **TRIGGER MENU**; then press the main-menu button **Mode & Holdoff**. Now press the side-menu button **Normal**.
 - Press **SET LEVEL TO 50%**.
 - Press horizontal **MENU**. Press the main-menu button **Record Length**; then press the side-menu button **1000 points in 20 divs**.
 - Press the main-menu button **Trigger Position**. Press the side-menu button **Pretrigger**; then set pretrigger to 20%: press **20**, then **ENTER**, on the keypad.
2. *Confirm Main and Delayed time bases are within limits for accuracies:*
- a. *Display the test signal:*
 - Adjust the horizontal **POSITION** so the trigger **T** is aligned to the center vertical graticule line.
 - Press the main-menu button **Time Base**.
 - Press the side-menu buttons **Delayed Only** and **Delayed Runs After Main**.
 - b. *Measure the test signal:*
 - Set the horizontal **SCALE** of the **D** (delayed) time base to 100 ns.
 - Use the keypad to set delayed time to 10 ms. (Press **10**, then **SHIFT**, then **m** followed by **ENTER**.)

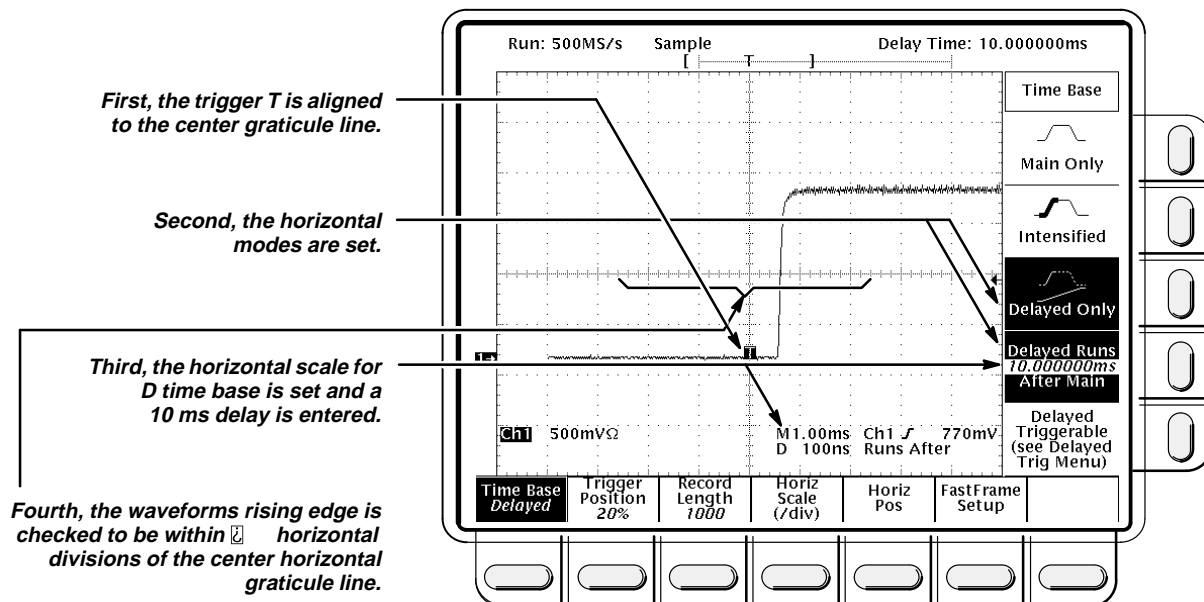

Figure 1-13: Measurement of Accuracy — Long-Term and Delay-Time

- c. *Check long-term sample rate and delay time accuracies against limits:* CHECK that the rising edge of the marker crosses the center horizontal graticule line at a point within $\frac{1}{2}$ center graticule. See Figure 1-13.
- d. *Check delta-time accuracy against limits:*
- Press the side-menu button **Main Only**. Set horizontal **SCALE** to 2 ns.
 - Set the output of the generator for 20 ns markers.
 - Press **SET LEVEL TO 50%**.
 - Press **SHIFT**; then **ACQUIRE MENU**. Next, press the main-menu button **Mode**. Finally, press the side-menu button **Average**.
 - Enter **8**, for eight averages, on the keypad.
 - Press **MEASURE**.
 - Press the main-menu button **High-Low Setup**; then press the side-menu button **Min-Max**.
 - Press the main-menu button **Select Measrmt for Ch1**.
 - Press the side-menu button **—more—**, until **PERIOD** appears in the side menu. Press **PERIOD**.
 - Press **CLEAR MENU**.
 - CHECK that the readout for **CH 1 Per** is within 19.760 ns to 20.240 ns.
3. *Disconnect the hookup:* Disconnect the cable from the generator output at the input connector of **CH 1**.

Trigger System Checks

These procedures check those characteristics that relate to the Main and Delayed trigger systems and are listed as checked under *Warranted Characteristics* in Section 2, *Specifications*.

Check Accuracy (Time) for Pulse-Glitch or Pulse-Width Triggering

Equipment Required: One medium-frequency leveled sine wave generator (Item 10), one 10X attenuator (Item 1), and one precision, 50 Ω , coaxial cable (Item 4).

Prerequisites: See page 1-15.

Procedure:

1. *Install the test hookup and preset the instrument controls:*
 - a. *Initialize the instrument:*
 - Press save/recall **SETUP**.
 - Press the main-menu button **Recall Factory Setup**.
 - Press the side-menu button **OK Confirm Factory Init**.
 - b. *Modify the default setup:*
 - Press vertical **MENU**.
 - Press the main-menu button **Coupling**; then press the side-menu **Ω** button to select **50 Ω** coupling.
 - Set the horizontal **SCALE** to 10 ns.
 - c. *Hook up the test-signal source:* Connect, through a 50 Ω precision coaxial cable, followed by a 10X attenuator, the output of a medium-frequency leveled sine wave generator (Item 10) to CH 1. See Figure 1-14.

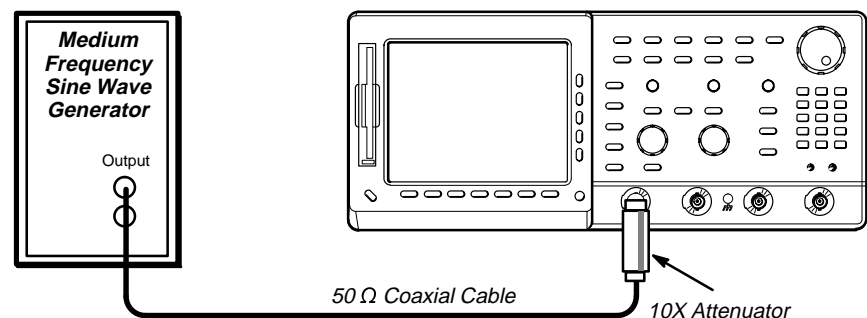

Figure 1-14: Initial Test Hookup

2. *Confirm the trigger system is within time-accuracy limits for pulse-glitch or pulse-width triggering (Horizontal Scale $\leq 1 \mu\text{s}$):*
 - a. *Display the test signal:* Set the output of the sine wave generator for a 100 MHz, five-division sine wave on screen. Press **SET LEVEL TO 50%**.
 - b. *Set the trigger mode:* Press **TRIGGER MENU**. Now press the main-menu button **Mode & Holdoff**; then the side-menu button **Normal**.
 - c. *Set upper and lower limits that ensures triggering:*
 - Press the main-menu button **Type**; then repeatedly press the same button until **Pulse** is highlighted in the menu that pops up.
 - Press the main-menu button **Class**; then repeatedly press the same button until **Width** is highlighted in the menu that pops up.
 - Press the main-menu button **Trig When**; then press the side-menu button **Within Limits**.
 - Press the side-menu button **Upper Limit**. Use the keyboard to set the upper limit to 10 ns: press **10**; then **SHIFT**; then **n**; then **ENTER**.
 - Press the side-menu button **Lower Limit**. Use the keypad to set the lower limit to 2 ns.
 - d. *Check against limits:*
 - Press **SET LEVEL TO 50%**.
 - While doing the following subparts, monitor the display (it will stop acquiring) and the front-panel light **TRIG** (it will extinguish) to determine when triggering is lost.
 - Use the general purpose knob to *increase* the **Lower Limit** readout until triggering is lost.
 - CHECK that the **Lower Limit** readout is within 2.5 ns to 7.5 ns, inclusive.
 - Use the keypad to return the **Lower Limit** to 2 ns and reestablish triggering.
 - Press the side-menu button **Upper Limit**; then use the general purpose knob to slowly *decrease* the the **Upper Limit** readout until triggering is lost.
 - CHECK that the **Upper Limit** readout is within 2.5 ns to 7.5 ns, inclusive.

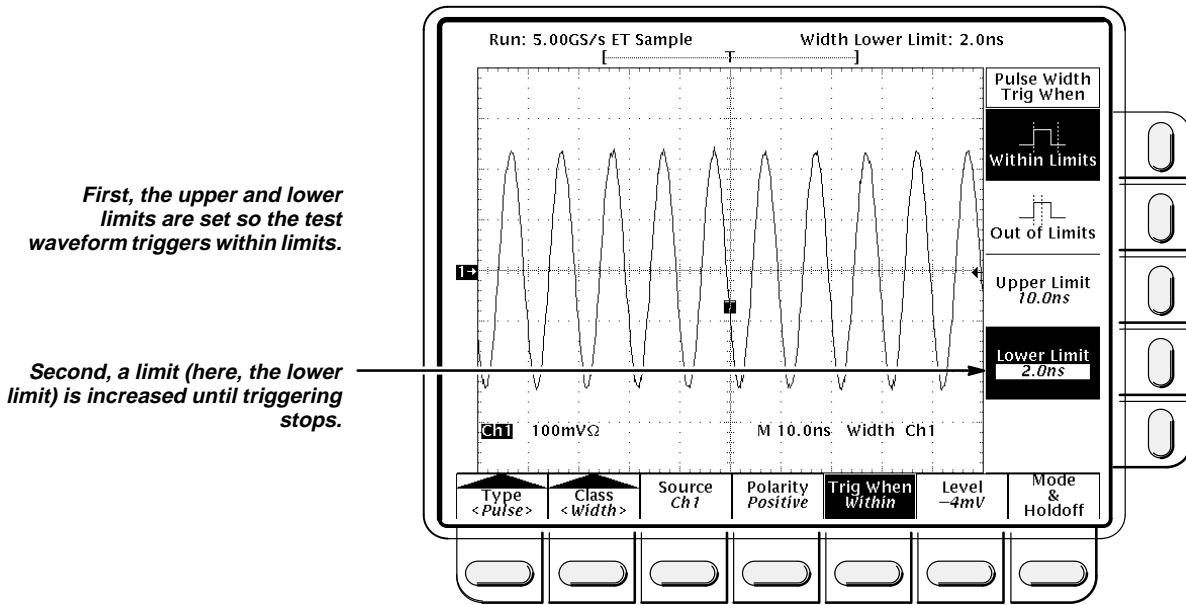

Figure 1-15: Measurement of Time Accuracy for Pulse and Glitch Triggering

3. Confirm the trigger system is within time-accuracy limits for pulse-glitch or pulse-width triggering (horizontal scale $>1 \mu\text{s}$):
 - a. Set upper and lower limits that ensure triggering at 250 kHz:
 - Press the side-menu button **Upper Limit**. Use the keyboard to set the upper limit to 4 μs .
 - Press the side-menu button **Lower Limit**. Use the keypad to set the lower limit to 500 ns.
 - b. Display the test signal:
 - Set the horizontal **SCALE** to 5 μs .
 - Set the output of the sine-wave generator for a 250 kHz, five-division sine wave on screen. Set the vertical **SCALE** to 20 mV (the waveform will overdrive the display).
 - Press **SET LEVEL TO 50%**.
 - c. Check against limits: Do the following subparts in the order listed.
 - Use the general purpose knob to *increase* **Lower Limit** readout until triggering is lost.
 - CHECK that the **Lower Limit** readout is within 1 μs to 3 μs , inclusive.
 - Use the keypad to return the **Lower Limit** to 500 ns and reestablish triggering.

- Press the side-menu button **Upper Limit**; then use the general purpose knob to slowly *decrease* the the **Upper Limit** readout until triggering is lost.
 - CHECK that the **Upper Limit** readout is within 1 μ s to 3 μ s, inclusive.
4. *Disconnect the hookup*: Disconnect the cable from the generator output at the input connector of **CH 1**.

Check Accuracy, Trigger-level or Threshold, DC Coupled

Equipment Required: One DC calibration generator (Item 8), one BNC T connector (Item 6), and two precision, 50 Ω , coaxial cables (Item 4).

Prerequisites: The oscilloscope must meet the prerequisites listed on page 1-15.

Procedure:

1. *Install the test hookup and preset the instrument controls:*
 - a. *Hook up the test-signal source:*
 - Set the output of a DC calibration generator to 0 volts.
 - Connect the output of a DC calibration generator through a dual-banana connector followed by a 50 Ω precision coaxial cable to one side of a BNC T connector. See Figure 1-16.
 - Connect the Sense output of the generator, through a second dual-banana connector followed by a 50 Ω precision coaxial cable, to other side of the BNC T connector. Now connect the BNC T connector to **CH 1**. See Figure 1-16.

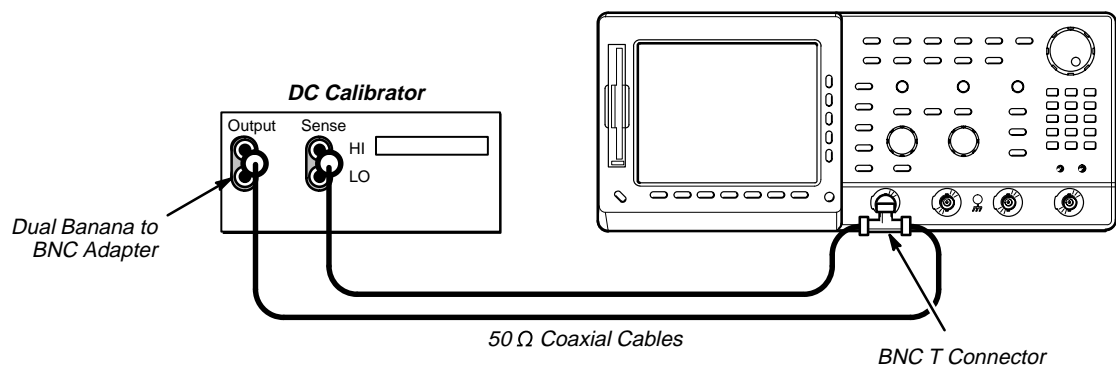

Figure 1-16: Initial Test Hookup

- b. *Initialize the oscilloscope:*
 - Press save/recall **Setup**.
 - Press the main-menu button **Recall Factory Setup**.
 - Press the side-menu button **OK Confirm Factory Init**.
 - c. *Select Delayed Triggerable:*
 - Press **HORIZONTAL MENU**.
 - Press the main-menu button **Time Base**.
 - Press the side-menu button **Delayed Triggerable**.
2. *Confirm Main trigger system is within limits for Trigger-level/Threshold accuracy:*
- a. *Display the test signal:*
 - Press **VERTICAL MENU**. Press the main-menu button **Position**.
 - Use the keypad to set vertical position to –3 divisions (press **–3**, then **ENTER**, on the keypad.) The baseline level will move down three divisions.
 - Press the main-menu button **Offset**.
 - Use the keypad to set vertical offset to +10 volts. Press **10**, then **ENTER**. The baseline level will move off-screen.
 - Set the standard output of a DC calibration generator to +10 volts. The DC test level will appear on screen.
 - b. *Measure the test signal:*
 - Press **SET LEVEL TO 50%**.
 - Press **TRIGGER MENU**.
 - Read the measurement results from the readout below the label **Level** in the menu; not the trigger readout in the graticule area.
 - c. *Check against limits:*
 - CHECK that the **Level** readout in the main menu is within 9.940 V to 10.060 V, inclusive.
 - Press **TRIGGER MENU**. Press the main-menu button **Slope**; then press the side-menu button for negative slope. (See icon at left.) Repeat substep b.
 - CHECK that the **Level** readout in the main menu is within 9.940 V to 10.060 V, inclusive. See Figure 1-17.



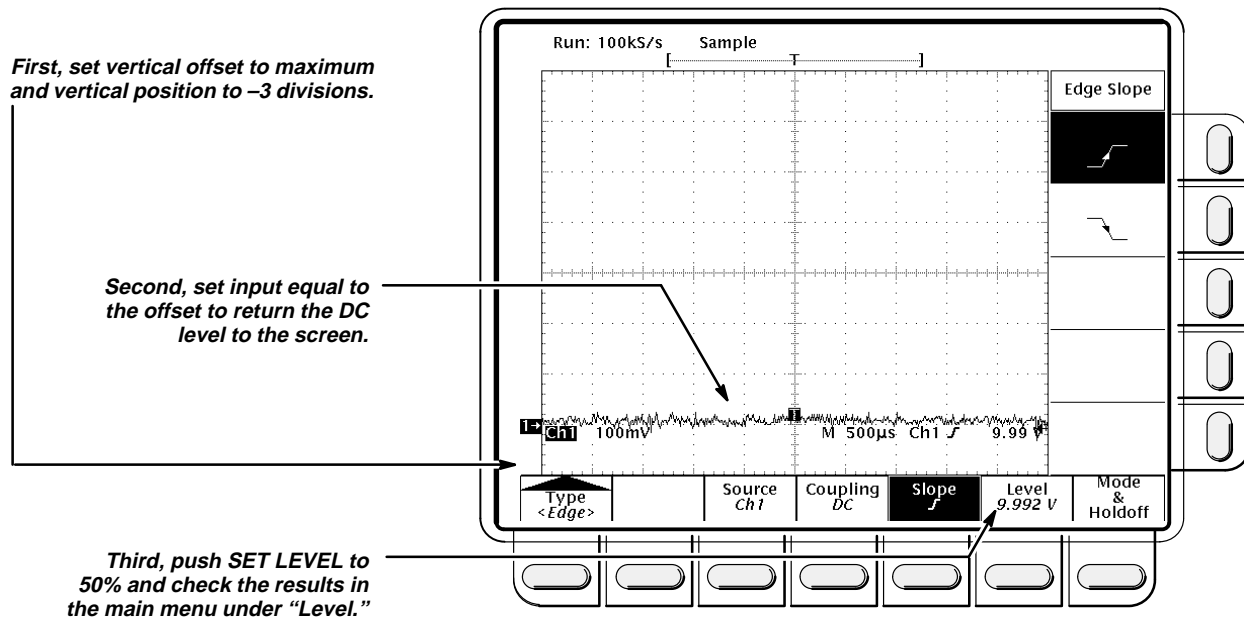

Figure 1-17: Measurement of Trigger-level Accuracy

3. Confirm Delayed trigger system is within limits for Trigger-level/Threshold accuracy:
 - a. Select the Delayed time base:
 - Press **HORIZONTAL MENU**.
 - Press the main-menu button **Time Base**.
 - Press the side-menu buttons **Delayed Only** and **Delayed Triggerable**.
 - Set **D** (delayed) horizontal **SCALE** to $500 \mu\text{s}$.
 - b. Select the Delayed trigger system:
 - Press **SHIFT**; then press the front-panel button **DELAYED TRIG**.
 - Press the main-menu button **Level**.
 - c. Measure the test signal: Press the side-menu button **SET TO 50%**. The **TRIG'D** indicator should be lit. Read the measurement results in the side menu below the label **Level**.
 - d. Check against limits: Do the following subparts in the order listed.
 - CHECK that the **Level** readout in the side menu is within 9.940 V to 10.060 V , inclusive.
 - Press the main-menu button **Slope**; then press the side-menu button for negative slope. (See icon at left.) Press the main-menu button **Level**. Repeat substep c.



- CHECK that the **Level** readout in the side menu is within 9.940 V to 10.060 V, inclusive.
4. *Disconnect the hookup:*
 - a. *First set the output of the DC calibration generator to 0 volts.*
 - b. Then disconnect the cable from the generator output at the input connector of **CH 1**.

Sensitivity, Edge Trigger, DC Coupled

Equipment Required: One medium-frequency leveled sine wave generator (Item 10), one high-frequency leveled sine wave generator (Item 11), one precision 50 Ω coaxial cable (Item 4), and one 10X attenuator (Item 1). When checking the TDS 540A and 544A, a BNC T connector (Item 6), a 5X attenuator (Item 2), and a second precision 50 Ω coaxial cable (Item 4) are also required.

Prerequisites: See page 1-15.

Procedure:

1. *Install the test hookup and preset the instrument controls:*
 - a. *Initialize the oscilloscope:*
 - Press save/recall **SETUP**.
 - Press the main-menu button **Recall Factory Setup**.
 - Press the side-menu button **OK Confirm Factory Init**.
 - b. *Modify the initialized front-panel control settings:*
 - Set the horizontal **SCALE** for the **M** (main) time base to 20 ns.
 - Press **HORIZONTAL MENU**; then press the main-menu button **Time Base**.
 - Press the side-menu button **Delayed Only**; then the side-menu button **Delayed Triggerable**.
 - Set the horizontal **SCALE** for the **D** (delayed) time base to 20 ns; then press the side-menu button **Main Only**.
 - Press **TRIGGER MENU**; then press the main-menu button **Mode & Holdoff**. Now press the side-menu button **Normal**.
 - Press **VERTICAL MENU**; then press the main-menu button **Coupling**. Now press the side-menu Ω button and select the **50 Ω** setting.
 - Press **SHIFT**; then press **ACQUIRE MENU**. Now press the main-menu button **Mode**; then the side-menu **Average 16** button.

c. Hook up the test-signal source:

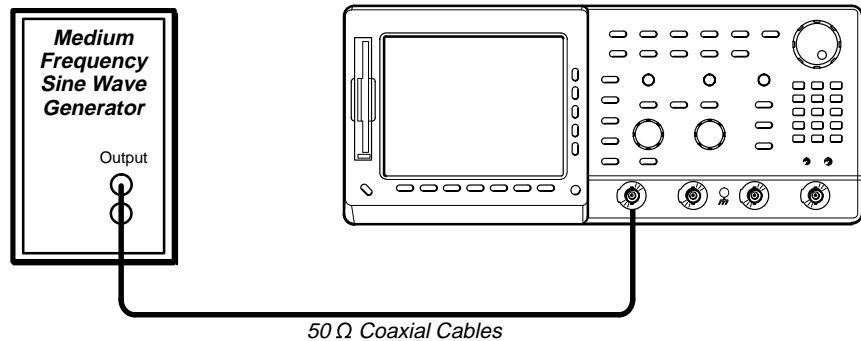

Figure 1-18: Initial Test Hookup—TDS 520A or 524A Only

- TDS 520A, 524A only: Connect, through a 50 Ω precision coaxial cable, the signal output of a medium-frequency sine wave generator to **CH 1**. See Figure 1-18.

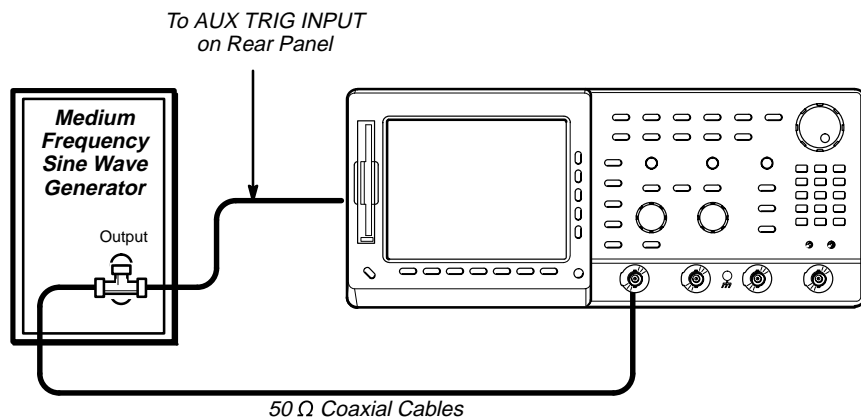

Figure 1-19: Initial Test Hookup—TDS 540A or 544A Only

- TDS 540A or 544A only: Connect the signal output of a medium-frequency sine wave generator to a BNC T connector. Connect one output of the T connector to **CH 1** through a 50 Ω precision coaxial cable; connect the other output of the T connector to the **AUX TRIG INPUT** at the rear panel. See Figure 1-19.
2. *Confirm Main and Delayed trigger systems are within sensitivity limits (50 MHz):*
 - a. *Display the test signal:*
 - Set the generator frequency to 50 MHz.
 - Press **MEASURE**.



- Press the main-menu button **High-Low Setup**; then press the side-menu button **Min-Max**.
 - Press the main-menu button **Select Measrmt for Ch1**.
 - Press the side-menu button **–more–** until **Amplitude** appears in the side menu (its icon is shown at the left). Press the side-menu button **Amplitude**.
 - Press **SET LEVEL TO 50%**.
 - Press **CLEAR MENU**.
 - Set the test signal amplitude for about three divisions on screen. Now fine adjust the generator output until the **CH 1 Amplitude** readout indicates the amplitude is 350 mV. (Readout may fluctuate around 350 mV.)
 - Disconnect the 50 Ω precision coaxial cable at **CH 1** and reconnect it to **CH 1** through a 10X attenuator.
- b. *Check for Main trigger system for stable triggering at limits:*
- Read the following definition: A stable trigger is one that is consistent; that is, one that results in a uniform, regular display triggered on the selected slope (positive or negative). This display should *not* have its trigger point switching between opposite slopes, nor should it “roll” across the screen. At horizontal scale settings of 2 ms/division and faster, **TRIG'D** will remain constantly lit. It will flash for slower settings.
 - Press **TRIGGER MENU**; then press the main-menu button **Slope**.
 - Press **SET LEVEL TO 50%**. CHECK that a stable trigger is obtained for the test waveform on both the positive and negative slopes. (Use the side menu to switch between trigger slopes; use the **TRIGGER LEVEL** knob to stabilize the trigger if required.) See Figure 1-20.

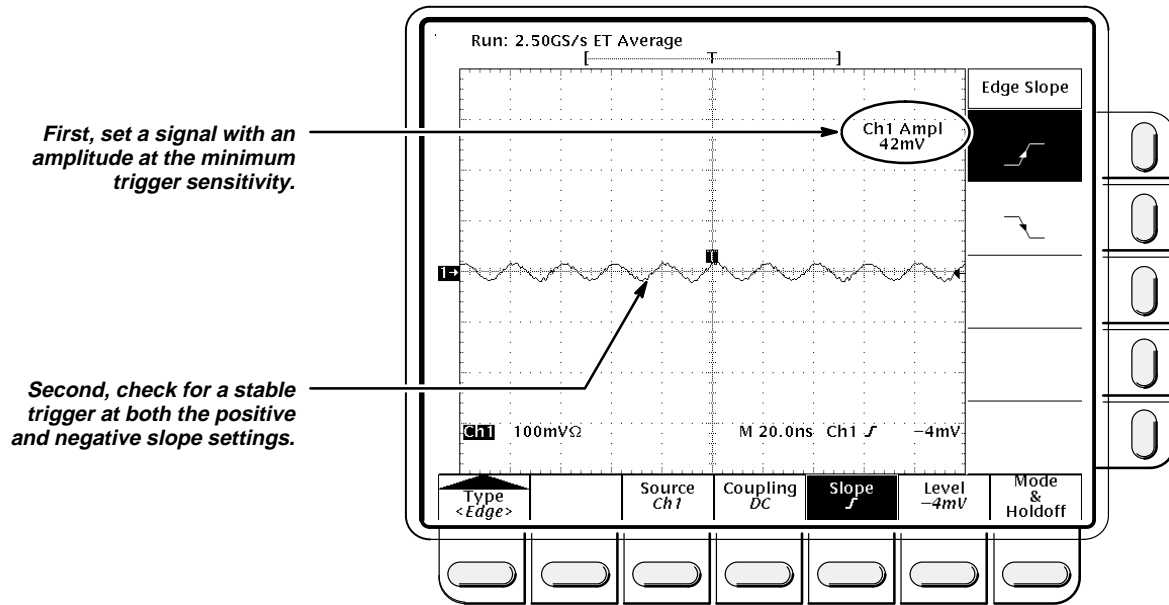

Figure 1-20: Measurement of Trigger Sensitivity

- Leave the Main trigger system triggered on the positive slope of the waveform before continuing to the next step. (The Main trigger system must be triggered to check the delayed trigger system in the next step.)
- c. Check delayed trigger system for stable triggering at limits: Do the following subparts in the order listed.
- Press **HORIZONTAL MENU**; then press the main-menu button **Time Base**. Now press the side-menu button **Delayed Only**.
 - Press **SHIFT**; then press **DELAYED TRIG**. Press the main-menu button **Level**.
 - Press the *side-menu* button **SET TO 50%**. CHECK that a stable trigger is obtained for the test waveform for both the positive and negative slopes of the waveform. (Use the General Purpose knob to stabilize the trigger if required.) Press the main-menu button **Slope**; then use the side menu to switch between trigger slopes.
 - Leave the delayed trigger system triggered on the positive slope of the waveform before continuing to the next step. Also, return to the main time base: Press **HORIZONTAL MENU**; then press the main-menu button **Time Base**. Now press the side-menu button **Main Only**.



TDS 520A or 524A only: Skip to step 4 since the TDS 520A and 524A are not equipped with an AUX Trigger input. If testing the TDS 540A or 544A, continue with step 3.

3. *Confirm the AUX Trigger input:*
 - a. *Display the test signal:*
 - Remove the 10X attenuator and reconnect the cable to **CH 1**.
 - Set the test signal amplitude for about 2.5 divisions on screen.
 - Now fine adjust the generator output until the **CH 1 Amplitude** readout indicates the amplitude is 250 mV. (Readout may fluctuate around 250 mV.)
 - b. *Check the AUX trigger source for stable triggering at limits:* Do the following in the order listed.
 - Use the definition for stable trigger from step 2.
 - Press **TRIGGER MENU**; then press the main-menu button **Source**.
 - Press the side-menu button **–more–** until the side-menu label **Auxiliary** appears; then press **Auxiliary**.
 - Press **SET LEVEL TO 50%**. CHECK that a stable trigger is obtained for the test waveform on both the positive and negative slopes. Press the main-menu button **Slope**; then use the side menu to switch between trigger slopes. Use the **TRIGGER LEVEL** knob to stabilize the trigger if required.
 - Leave the Main trigger system triggered on the positive slope of the waveform before proceeding to the next check.
 - Press the main-menu button **Source**; then press the side-menu button **–more–** until **CH 1** appears. Press **CH 1**.
4. *Confirm that the Main and Delayed trigger systems are within sensitivity limits (500 MHz):*
 - a. *Hook up the test-signal source:* Disconnect the hookup installed in step 1. Connect, through its leveling head, the signal output of a high-frequency leveled sine-wave generator to **CH 1**.
 - b. *Set the Main and Delayed Horizontal Scales:*
 - Set the horizontal **SCALE** to 500 ps for the **M** (Main) time base.
 - Press **HORIZONTAL MENU**. Now press the main-menu button **Time base**; then press the side-menu button **Delayed Triggerable**.
 - Press the side-menu button **Delayed Only**.
 - Set the horizontal **SCALE** to 500 ps for the **D** (Delayed) time base. Press the side-menu button **Main Only**.
 - c. *Display the test signal:*
 - Set the generator frequency to 500 MHz.

- Set the test signal amplitude for about five divisions on screen. Now fine adjust the generator output until the **CH 1 Amplitude** readout indicates the amplitude is 500 mV. (Readout may fluctuate around 500 mV.)
 - Disconnect the leveling head at **CH 1** and reconnect it to **CH 1** through a 5X attenuator.
- d. Repeat step 2, substeps b and c only, since only the 500 MHz frequency is to be checked here.
5. *Confirm that the Main and Delayed trigger systems couple trigger signals from all channels:* Doing the procedure *Check Analog Bandwidth*, which begins on page 1-32, checks coupling. If you have not done that procedure, do so after finishing this procedure. See the following note.

NOTE

Steps 1 through 4 confirmed trigger sensitivity for the Main and Delayed triggering systems using the CH 1 input. Doing the procedure Check Analog Bandwidth ensures that trigger signals are coupled from all four channels.

When checking delayed triggering sensitivity at 500 MHz, the waveform record may have some missing interpolated record points. The waveform is still stably triggered. (See definition of a stable trigger earlier in this procedure.)

6. *Disconnect the hookup:* Disconnect the cable from the generator output at the input connector of the channel last tested.

Output Signal Checks

The procedure that follows checks those characteristics of the output signals that are listed as checked under *Warranted Characteristics* in Section 2, *Specifications*. The oscilloscope outputs these signals at its front and rear panels.

Check Outputs — CH 3 and Main and Delayed Trigger (TDS 540A and 544A only)

Equipment Required: Two 50 Ω precision cables (Item 4), and one calibration generator (Item 9).

Prerequisites: See page 1-15. Also, this Digitizing Oscilloscope must have passed *Check Accuracy — Long-Term Sample Rate, Delay time, Time Measurement* on page 1-39 and *Check Accuracy for DC Gain and Voltage Measurements* on page 1-25.

Procedure:

1. *Install the test hookup and preset the instrument controls:*
 - a. *Hook up test-signal source 1:*
 - Connect the standard amplitude output of a calibration generator through a 50 Ω precision coaxial cable to **CH 3**. See Figure 1-21.
 - Set the output of the calibration generator to 0.500 V.
 - b. *Hook up test-signal source 2:* Connect the **Main Trigger Out** at the rear panel to **CH 2** through a 50 Ω precision cable. See Figure 1-21.

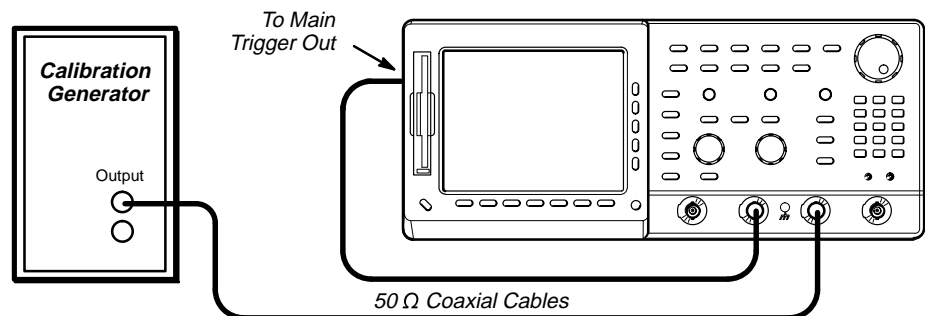

Figure 1-21: Initial Test Hookup

- c. *Initialize the oscilloscope:*
 - Press save/recall **SETUP**.
 - Press the main-menu button **Recall Factory Setup**.
 - Press the side-menu button **OK Confirm Factory Init**.

- d. *Modify the initialized front-panel control settings:*
- Set the horizontal **SCALE** to 200 μs .
 - Press **SHIFT**; then **ACQUIRE MENU**.
 - Press the main-menu button **Mode**. Then press the side-menu button **Hi Res**.
2. *Confirm Main and Delayed Trigger outputs are within limits for logic levels:*
- a. *Display the test signal:*
- Press **WAVEFORM OFF** to turn off CH 1; then press **CH 2** to display that channel. Set the vertical **SCALE** to 1 V.
 - Press **TRIGGER MENU**.
 - Press the main-menu button **Source**; then press the side-menu button **CH 3**. Press **SET LEVEL TO 50%**.
 - Use the vertical **POSITION** knob to center the display on screen.
- b. *Measure logic levels:*
- Press **MEASURE**; then press the main-menu button **Select Measrmt for Ch2**.
 - Repeatedly press the side-menu button **–more–** until **High** and **Low** appear in the side menu (their icons are shown at the left). Press both side-menu buttons **High** and **Low**. See Figure 1-22.

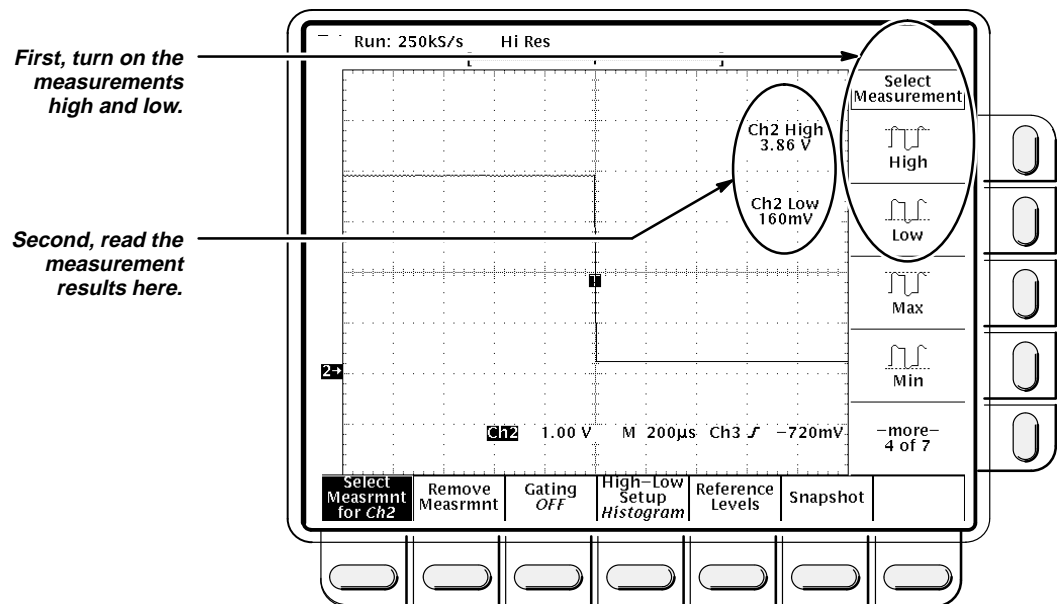
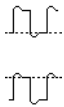

Figure 1-22: Measurement of Main Trigger Out Limits

- c. *Check Main Trigger output against limits:*
 - CHECK that the **Ch2 High** readout is ≥ 2.5 volts and that the **Ch2 Low** readout is ≤ 700 mV.
 - Press **VERTICAL MENU**; then press the main-menu button **Coupling**. Now press the side-menu button Ω to toggle it to the 50 Ω setting.
 - CHECK that the **Ch2 High** readout is ≥ 1.0 volt and that the **Ch2 Low** readout ≤ 250 mV.
 - d. *Check Delayed Trigger output against limits:*
 - Move the precision 50 Ω cable from the **Main Trigger Output** BNC to the **Delayed Trigger Output** BNC.
 - CHECK that the **Ch2 High** readout is ≥ 1.0 volt and that the **Ch2 Low** readout ≤ 250 mV.
 - Press the side-menu button Ω select the 1 M Ω setting.
 - Press **CLEAR MENU**.
 - CHECK that the **Ch2 High** readout is ≥ 2.5 volts and that the **Ch2 Low** readout is ≤ 700 mV.
3. *Confirm CH 3 output is within limits for gain:*
- a. *Measure gain:*
 - Move the precision 50 Ω cable from the rear-panel **DELAYED TRIGGER OUTPUT** BNC to the rear-panel **SIGNAL OUTPUT** BNC.
 - Push **SHIFT**. Then push **DELAYED TRIG**.
 - Press the main-menu button **Source**. Then press the side-menu button **Ch3**.
 - Push **HORIZONTAL MENU**.
 - Push the main-menu button **Time Base**. Then press the side-menu button **Delayed Triggerable**.
 - Set vertical **SCALE** to 100 mV.
 - Press **MEASURE**; then press the main-menu button **Select Measmnt for Ch2**.
 - Repeatedly press the side-menu button **–more–** until **Pk-Pk** appears in the side menu (its icon is shown at the left). Press the side-menu button **Pk-Pk**.
 - Press **CLEAR MENU**.



- b. *Check against limits:*
 - CHECK that the readout **Ch2 Pk-Pk** is between 90 mV and 110 mV, inclusive.
 - Press **VERTICAL MENU**; then press the side-menu button **Ω** to toggle to the 50 Ω setting.
 - Set vertical **SCALE** to 10 mV; then press **CLEAR MENU**.
 - CHECK that the readout **Ch2 Pk-Pk** is between 45 mV and 55 mV, inclusive.
4. *Disconnect the hookup:* Disconnect the cable from the generator output at the input connector of the channel last tested.

Check Probe Compensator Outputs

One female BNC to clip adapter (Item 15), two dual-banana connectors (Item 5), one BNC T connector (Item 6), two 50 Ω precision cables (Item 4), and one DC calibration generator (Item 8).

Prerequisites: See page 1-15. Also, this Digitizing Oscilloscope must have passed *Check Accuracy — Long-Term Sample Rate, Delay time, Time Measurement* on page 1-39 and *Check Accuracy for DC Gain and Voltage Measurements* on page 1-25.

Procedure:

1. *Install the test hookup and preset the instrument controls:*
 - a. *Hook up test-signal:*
 - Connect **CH 1** to **PROBE COMPENSATION SIGNAL** and to **PROBE COMPENSATION GND** through a precision coaxial cable and a BNC to clip adapter. See Figure 1-23.

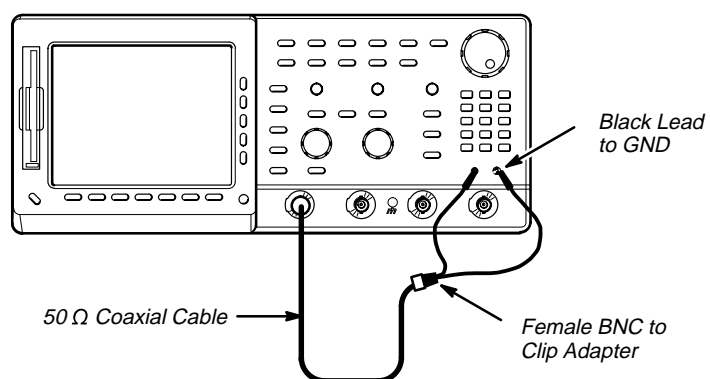

Figure 1-23: Initial Test Hookup

- b. *Initialize the oscilloscope:*
 - Press save/recall **SETUP**.
 - Press the main-menu button **Recall Factory Setup**.

- Press the side-menu button **OK Confirm Factory Init.**
- c. *Modify the initialized front-panel control settings:*
- Set the vertical **SCALE** to 100 mV as required.
 - Set the horizontal **SCALE** to 200 μ s.
 - Press **Set Level to 50%** and use the **VERTICAL POSITION** knob to center the display on screen.
 - Press **SHIFT**; then **ACQUIRE MENU**.
 - Press the main-menu button **Mode**; then press the side-menu **Average** button.
 - Select **128** averages. On the keypad, type **128**; then press **ENTER**.
2. *Confirm that the Probe Compensator signal is within limits for frequency:*
- a. *Measure the frequency of the probe compensation signal:*
- Press **MEASURE**; then press the main-menu button **Select Measrmt for Ch1**.
 - Repeatedly press the side-menu button **–more–** until **Frequency** appears in the side menu (its icon is shown at the left). Press the side-menu button **Frequency**.
 - Press **CLEAR MENU** to remove the menus from the display. See Figure 1-24.

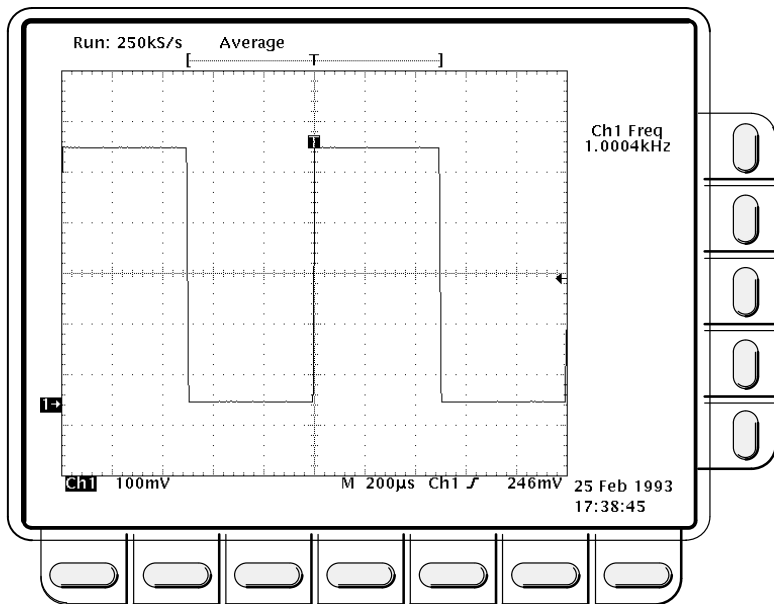

Figure 1-24: Measurement of Probe Compensator Frequency

- b. *Check against limits:* CHECK that the **CH 1 Freq** readout is within 950 Hz to 1.050 kHz, inclusive.
3. *Confirm that the Probe Compensator signal is within limits for amplitude:*
 - a. *Save the probe compensation signal in reference memory:*
 - Press **SAVE/RECALL WAVEFORM**; then press the main-menu button **Save Wfm Ch 1**.
 - Press the side-menu button to **Ref 1** to save the probe compensation signal in reference 1.
 - Disconnect the cable from **CH 1** and the clips from the probe compensation terminals.
 - Press **MORE**; then press the main-menu button **Ref 1** to display the stored signal.
 - Press **CH 1**.
 - b. *Hook up the DC standard source:*
 - Set the output of a DC calibration generator to 0 volts.
 - Connect the output of a DC calibration generator through a dual-banana connector followed by a 50 Ω precision coaxial cable to one side of a BNC T connector. See Figure 1-25.
 - Connect the Sense output of the generator through a second dual-banana connector followed by a 50 Ω precision coaxial cable to the other side of the BNC T connector. Now connect the BNC T connector to **CH 1**. See Figure 1-25.

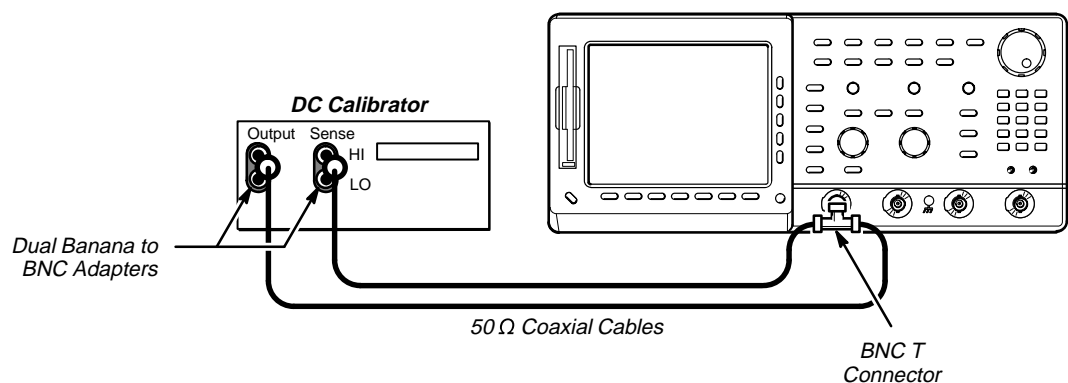

Figure 1-25: Subsequent Test Hookup

- c. *Measure amplitude of the probe compensation signal:*
 - Press **SHIFT**; then **ACQUIRE MENU**. Then use the keypad to set **AVERAGE** to **16** in the side menu.

Performance Tests

- Adjust the output of DC calibration generator until it precisely overlaps the top (upper) level of the stored probe compensation signal. (This value will be near 500 mV.)
 - Record the setting of the DC generator.
 - Adjust the output of DC calibration generator until it precisely overlaps the base (lower) level of the stored probe compensation signal. (This value will be near zero volts.)
 - Record the setting of the DC generator.
- d. Press **CLEAR MENU** to remove the menus from the display. See Figure 1-26.

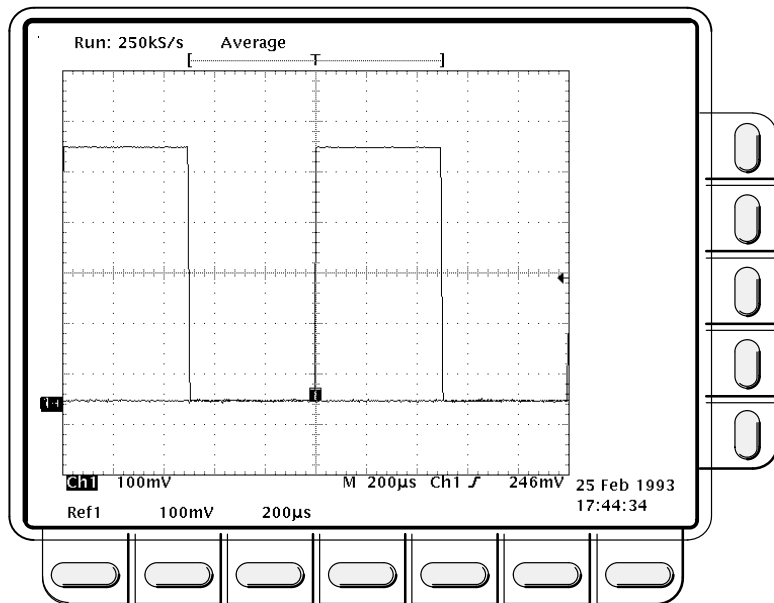

Figure 1-26: Measurement of Probe Compensator Amplitude

- e. *Check against limits:*
- Subtract the value just obtained (base level) from that obtained previously (top level).
 - CHECK that the difference obtained is within 495 mV to 505 mV, inclusive.
4. *Disconnect the hookup:* Disconnect the cable from **CH 1**.

Option 05 Video Trigger Checks

Equipment Required: PAL signal source (Item 18), 60 Hz. sine wave generator (Item 19), pulse generator (Item 20), 75 Ω Cable (Item 21), 75 Ω terminator (Item 22), 50 Ω cable (Item 4), 50 Ω terminator (Item 3).

Check Video Trigger

Prerequisites: See page 1-15. These prerequisites include running the signal path compensation routine.

Procedure:

1. Setup digitizing oscilloscope to factory defaults by completing the following steps:
 - a. Press save/recall **SETUP**.
 - b. Press the main-menu **Recall Factory Setup**.
 - c. Press the side-menu **OK Confirm Factory Init**.
 - d. Wait for the Clock Icon to leave the screen.
 - e. CONFIRM the digitizing oscilloscope is setup as shown below.
Channel: CH1
Volt/div: 100 mV
Horizontal scale: 500 μ s/div
2. Setup digitizing oscilloscope for TV triggers by completing the following steps:
 - a. Press **TRIGGER MENU**.
 - b. Press the main-menu **Type** pop-up until you select **Video**.
 - c. Press the main-menu **Standard** pop-up until you select **625/PAL**.
 - d. Press the main-menu **Line**.
 - e. Use the keypad to set the line number to 7 (press **7**, then **ENTER**).
 - f. Press **VERTICAL MENU**.
 - g. Press the main-menu **Bandwidth**.
 - h. Select **100 MHz** from the side menu.
 - i. Press the main-menu **Fine Scale**.
 - j. Use the keypad to set the fine scale to **282mV** (press **282**, **SHIFT**, **m**, then **ENTER**).
 - k. Press **HORIZONTAL MENU**.
 - l. Press the main-menu **Horiz Scale**.
 - m. Use the keypad to set the horizontal scale to 200 ns (press **200**, **SHIFT**, **n**, then **ENTER**).

3. Check Jitter vs. Signal Amplitude

a. Setup equipment for Jitter Test (See Figure 1-27).

- Connect one of the rear panel composite outputs marked **COMPST** on the TSG121 through a 75 Ω cable and a 75 Ω terminator to the oscilloscope CH1 input.
- Press the PAL signal source **100% FIELD** control (the fourth TSG121 front-panel button from the left).

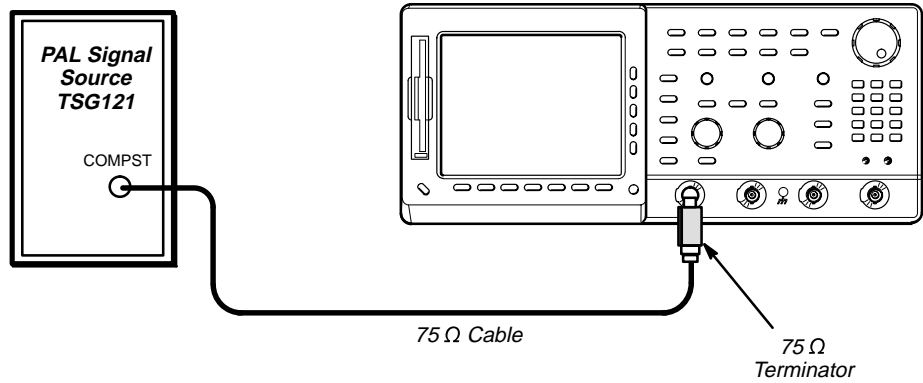

Figure 1-27: Jitter Test Hookup

b. CHECK that the oscilloscope lights up its front panel **TRIG'D** LED and it displays the waveform on screen (See Figure 1-28).

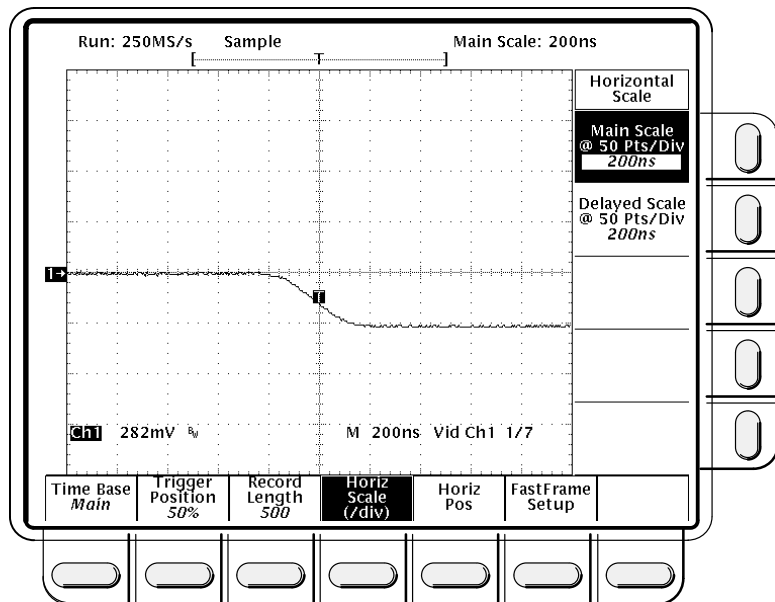

Figure 1-28: Jitter Test Displayed Waveform

- CONFIRM that the **TRIG'D** LED is lit and the waveform is displayed on screen.
- c. Press **SHIFT**; then **ACQUIRE MENU**.
- d. Press the main-menu **Mode**.
- e. Select the side-menu **Average**. It should be already set to 16.
- f. Press the main-menu **Create Limit Test Template**.
- g. Press the side-menu **V Limit**.
- h. Use the keypad to set V Limit to 100 mdiv (press **100**, **SHIFT**, **m**, then **ENTER**)
- i. Press the side-menu **OK Store Template**.
- j. Press **MORE**.
- k. Press the main-menu **Ref1**.
- l. Press **CH1**.
- m. Press **SHIFT**; then **ACQUIRE MENU**.
- n. Press the main-menu **Limit Test Setup**.
- o. Toggle the side-menu **Limit Test** to **ON**.
- p. Toggle the side-menu **Ring Bell if Condition Met** to **ON**.
- q. Press the main-menu **Mode**.
- r. Press the side-menu **Envelope**.
- s. Use the keypad to set envelope to use 100 acquisitions (press **100**, then **ENTER**).
- t. Press the main-menu **Stop After** button.
- u. Press the side-menu **Single Acquisition Sequence**.
- v. CONFIRM that the oscilloscope successfully makes 100 acquisitions. If not successful, the oscilloscope bell will ring. When the word **Run** in the top left corner of the display changes to **STOP**, the test is complete (See Figure 1-29).

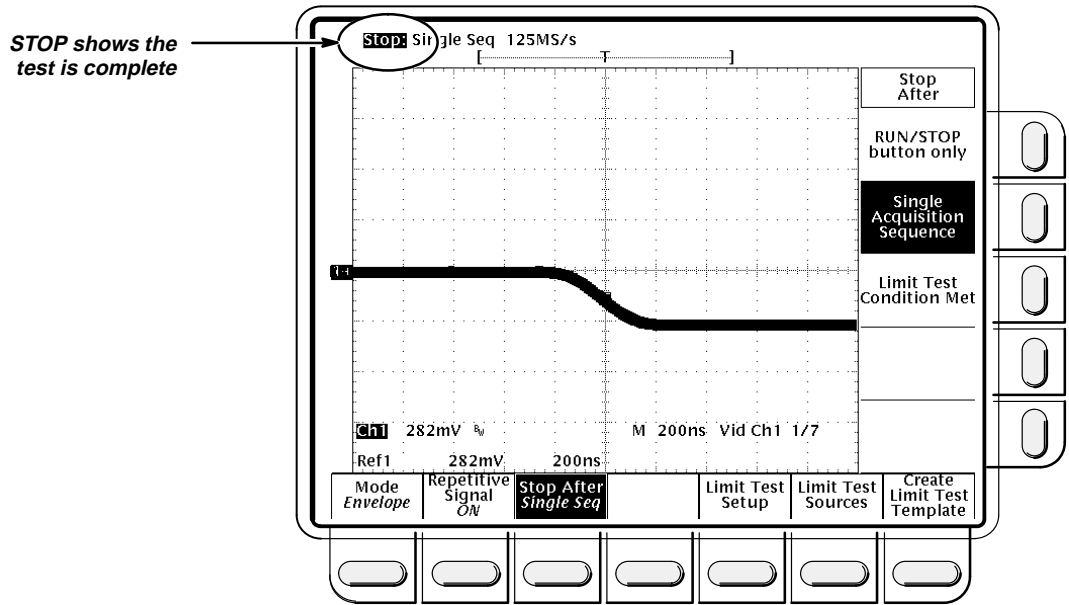

Figure 1-29: Jitter Test When Completed

- w. Press the main-menu **Limit Test Setup**.
- x. Toggle the side-menu **Ring Bell if Condition Met** to **OFF**.
- y. Toggle the side-menu **Limit Test** to **OFF**.
- 4. Check Triggered Signal Range.
 - Setup oscilloscope for Triggered Signal Test.
 - a. Press **MORE**.
 - b. Press **WAVEFORM OFF**.
 - c. Press **HORIZONTAL MENU**.
 - d. Use the keypad to set the horizontal scale time-per-division (**Horiz Scale (/div)**) to 50 μ s (press **50**, **SHIFT**, **μ** , then **ENTER**).
 - e. Press **SHIFT**; then **ACQUIRE MENU**.
 - f. Press the main-menu **Stop After**.
 - g. Press the side-menu **RUN/STOP button only**.
 - h. Press the main-menu **Mode**.
 - i. Press the side-menu **Sample**.
 - j. Press **RUN/STOP**.
 - k. Press **VERTICAL MENU**.
 - l. Use the keypad to set fine scale to 300 mV (press **300**, **SHIFT**, **m**, then **ENTER**).

- m. CONFIRM that the **TRIG'D** LED stays on and that the waveform on screen is stable. ie; does not move horizontally or vertically. Also, CONFIRM that the waveform on the screen has one positive pulse and a number of negative pulses (See Figure 1-30).

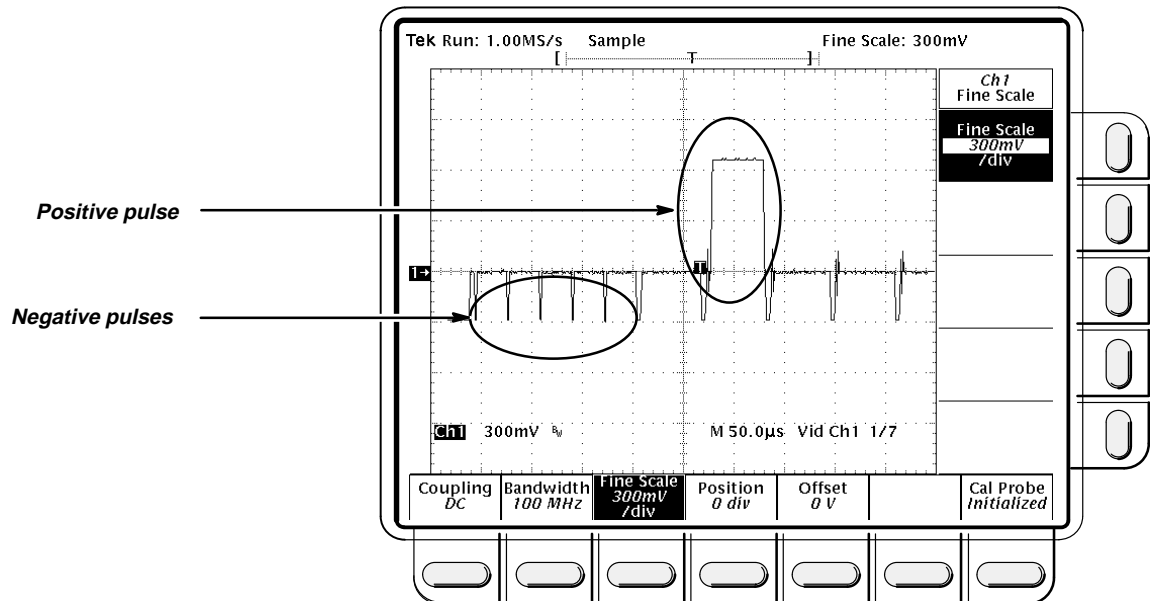

Figure 1-30: Triggered Signal Range Test – 300 mV

- n. Use the keypad to set the fine scale to 75 mV (press **75**, **SHIFT**, **m**, then **ENTER**).
- o. CONFIRM that the **TRIG'D** LED stays lit and that the waveform on screen is stable. ie; does not move horizontally or vertically. Also, CONFIRM that the waveform on the screen has one positive pulse and a number of negative pulses (See Figure 1-31).

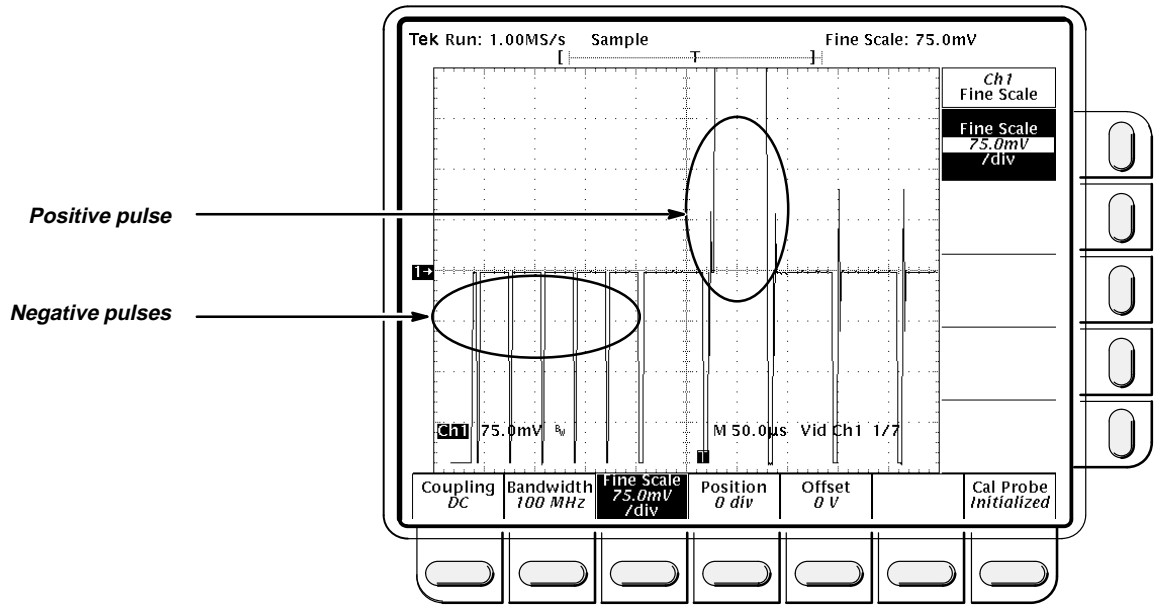

Figure 1-31: Triggered Signal Range Test – 75 mV

- p. Disconnect all test equipment (TSG121) from the digitizing oscilloscope.
5. Check 60 Hz Rejection.
 - a. Setup oscilloscope for 60 Hz Rejection Test.
 - Use the keypad to set the Ch1 Fine Scale to 282 mV (press **282**, **SHIFT m**, then **ENTER**).
 - Press **WAVEFORM OFF**.
 - Press **CH2**.
 - Press **VERTICAL MENU**.
 - Use the keypad set the fine scale to 2 V (press **2**, then **ENTER**).
 - Press **HORIZONTAL MENU**.
 - Use the keypad to set the horizontal scale time-per-division (**Horiz Scale (/div)**) to 5 ms (press **5**, **SHIFT m**, then **ENTER**).
 - b. Setup 60 Hz signal generator (SG 502).
 - Connect the output of the SG 502 to the CH2 input through a 50 Ω cable (See Figure 1-32).

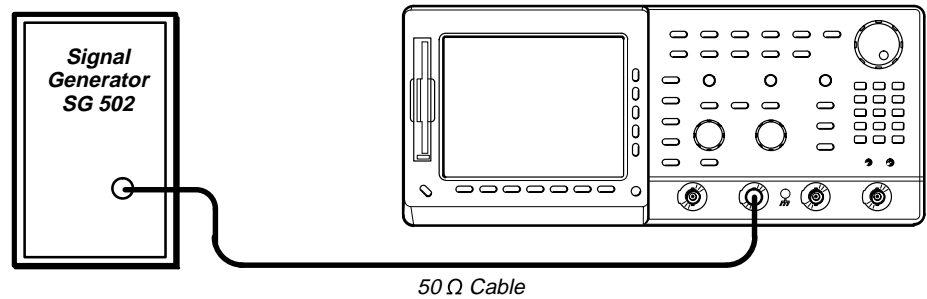

Figure 1-32: 60 Hz Rejection Test Hookup

- Adjust the SG 502 for three vertical divisions of 60 Hz signal (See Figure 1-33). The signal will not be triggered. That is, it will run free.

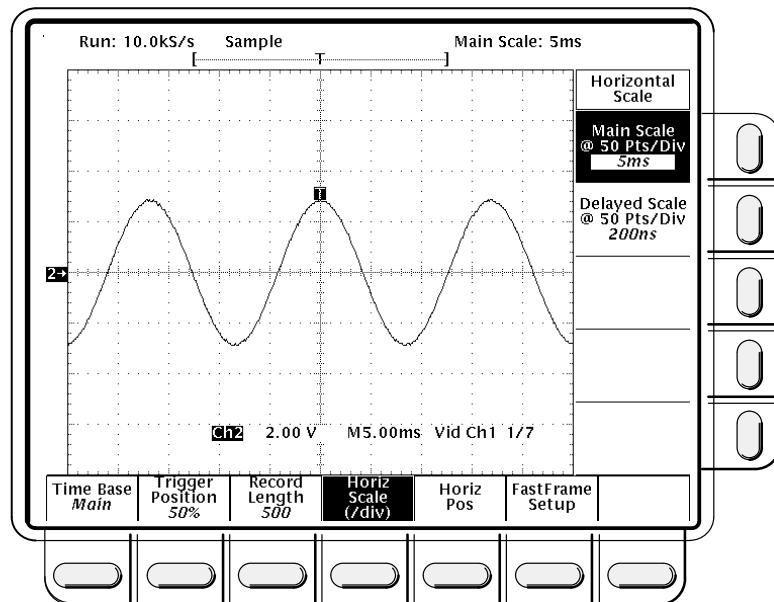

Figure 1-33: 60 Hz Rejection Test Setup Signal

- Check 60 Hz rejection.
 - Use the keypad to set the the horizontal scale time-per-division (**Horiz Scale (/div)**) to 50 μ s (press **50**, **SHIFT**, **μ** , then **ENTER**).
 - Reconnect the output of the signal generator (SG 502). Connect the PAL signal source's composite signal connector (labelled **COMPST**) on the TSG 121) to a 75 Ω cable and a 75 Ω terminator. Connect both signals to the CH1 input through a BNC T (See Figure 1-34).

- Press **VERTICAL MENU**.
- If needed, press the main-menu **Fine Scale**.
- Use the keypad to set fine scale to 500 mV (press **500**, **SHIFT**, **m**, then **ENTER**).
- Connect another the PAL signal source's composite signal connector (labelled **COMPST** on the TSG 121) through a 75 Ω cable and a 75 Ω terminator to the CH2 input (See Figure 1-34).

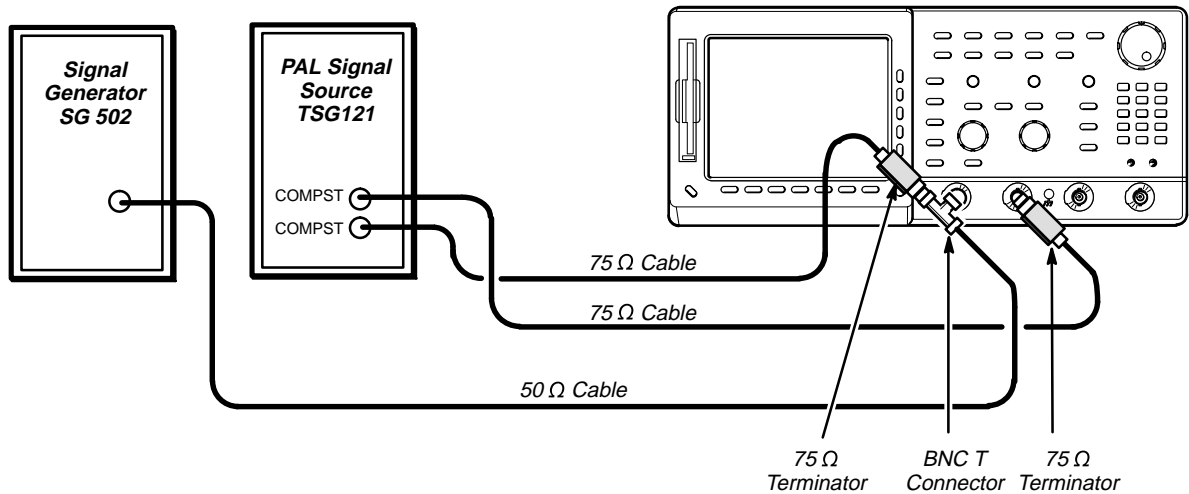

Figure 1-34: Subsequent 60 Hz Rejection Test Hookup

- CONFIRM that the **TRIG'D** LED stays on and that the waveform on screen is stable. Stable means the waveform does not move horizontally or vertically. Also, confirm that the waveform on the screen has one positive pulse and a number of negative pulses (See Figure 1-35).

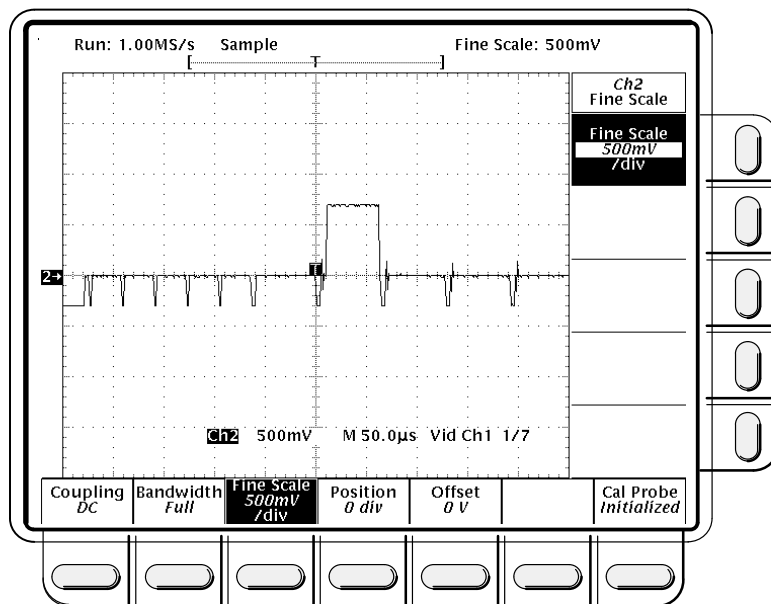

Figure 1-35: 60 Hz Rejection Test Result

- Disconnect all test equipment from the digitizing oscilloscope.
- 6. Check Line Count Accuracy.
 - a. Setup oscilloscope for Line Count Accuracy Test.
 - Press **WAVEFORM OFF**.
 - Press **CH1**.
 - Press **HORIZONTAL MENU**.
 - Press the main-menu **Record Length**.
 - Press, if needed, the side-menu **–more– 1 of 2**.
 - Press the side-menu **5000 points in 100divs**.
 - Press the main-menu **Horiz Scale (/div)**.
 - Use the keypad to set the horizontal scale to 200 ns (press **200**, **SHIFT**, **n**, then **ENTER**).
 - b. Check Line Count Accuracy.
 - Connect a composite output signal from the PAL signal source (on the TSG 121 this refers to the signal at the rear labelled **COMPST**) to the CH1 input through a 75 Ω cable and a 75 Ω terminator (See Figure 1-36).

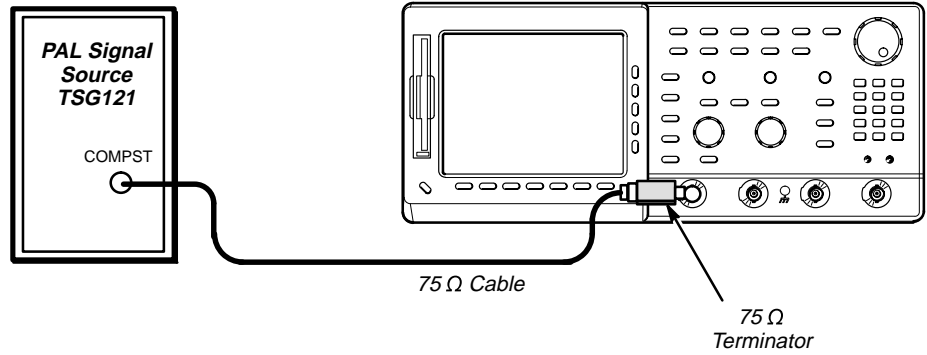

Figure 1-36: Line Count Accuracy Test Hookup

- Press the main-menu **Trigger Position**.
- Press the side-menu to **Set to 50%**.
- Press the main-menu **Horiz Pos**.
- Press the side-menu to **Set to 50%**.
- Use the **HORIZONTAL POSITION** knob to move the falling edge of the sync pulse to two divisions to the left of center screen (See Figure 1-37).

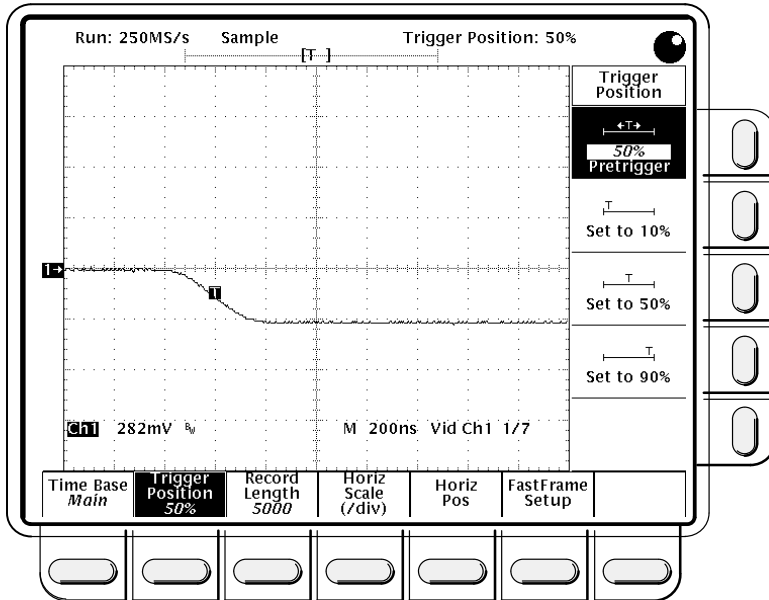

Figure 1-37: Line Count Accuracy Test Setup Waveform

- Press **CURSOR**.
- Press the main-menu **Function**.

- Press the side-menu **V Bars**.
- Using the General Purpose knob, place the left cursor directly over the trigger “T” icon.
- Press **SELECT**.
- Turn the General Purpose knob to adjust the right cursor for a cursor delta reading of **6.780us**.
- Use the **HORIZONTAL POSITION** knob to position the right cursor to center screen.
- Verify that the cursor is positioned on a positive slope of the burst signal (See Figure 1-38).

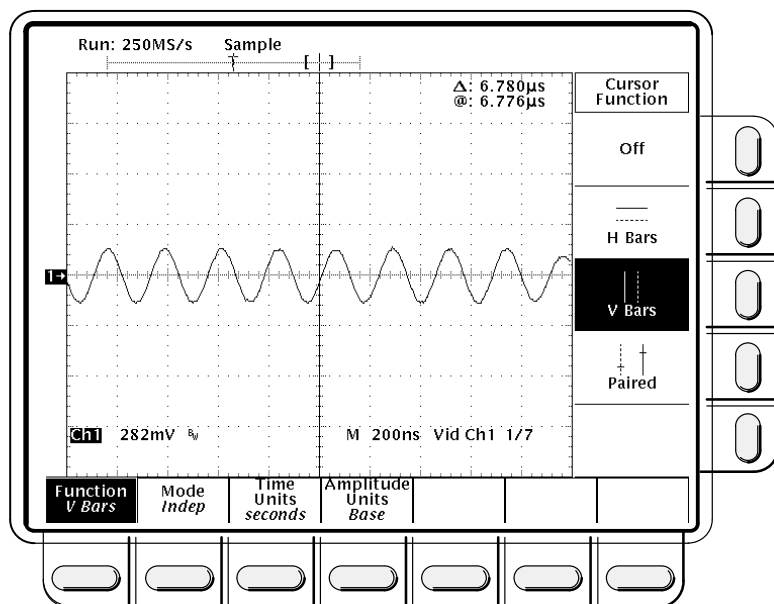

Figure 1-38: Line Count Accuracy Correct Result Waveform

- Disconnect all test equipment (TSG 121) from the digitizing oscilloscope.
 - Turn off cursors by pressing **CURSOR**, then the main-menu **Function** button, and, finally, **Off** from the side menu.
7. Check the Sync Duty Cycle.
- a. Setup digitizing oscilloscope for Sync Duty Cycle Test.
 - Press **TRIGGER MENU**.
 - Press the **Standard** pop-up to select **FlexFmt**. (Trigger **Type** should already be set to **Video**)
 - Press the main-menu **Setup**.

- Press the side-menu **Field Rate**.
 - Use the keypad to set the field rate to 60.05 Hz (press **60.05**, then **ENTER**).
 - Press the side-menu **Lines**.
 - Use the keypad to set the field rate to 793 lines (press **793**, then **ENTER**).
 - Press the side-menu **Fields**.
 - Use the keypad to set the number of fields to 1 (press **1**, then **ENTER**).
 - Press the side-menu **Sync Width**.
 - Use the keypad to set the width to 400 ns (press **400**, **SHIFT**, **n**, then **ENTER**).
 - Press the side-menu **–more– 1 of 2**. Then press **V1 Start Time**.
 - Use the keypad to set V1 start time to 10.10 μ s (press **10.10**, **SHIFT**, **μ** , then **ENTER**).
 - Press the side-menu **V1 Stop Time**.
 - Use the keypad to set V1 stop time to 10.50 μ s (press **10.50**, **SHIFT**, **μ** , then **ENTER**).
 - Press the main-menu **Type** pop-up to select **Edge**.
 - Press **HORIZONTAL MENU**.
 - Press the main-menu **Record Length**.
 - Select the side-menu **1000 points in 20div**. (if needed, first press the side-menu **–more– 2 of 2**).
 - Turn the **HORIZONTAL POSITION** knob to position the trigger 'T' two divisions to the left of the center screen.
 - Press **MEASURE**.
 - If needed, press the main-menu **Select Measrmt**.
 - Press the side-menu **Negative Width**.
 - Press the side-menu **Period**.
- b. Setup the pulse generator (PG502) for Sync Duty Cycle Test
- Set **PULSE DURATION** to 50 ns.
 - Set **PERIOD** to 10 μ s.
 - Set **OUTPUT (VOLTS)** to **-1** for **LOW LEVEL** and **+1** for **HIGH LEVEL**.
 - Depress the **COMPLEMENT** button.
 - Be sure **BACK TERM** is depressed (in).

- c. Check Sync Duty Cycle
- Connect the pulse generator (PG502) through a 50 Ω cable and a 50 Ω terminator to the oscilloscope CH1 input (See Figure 1-39).

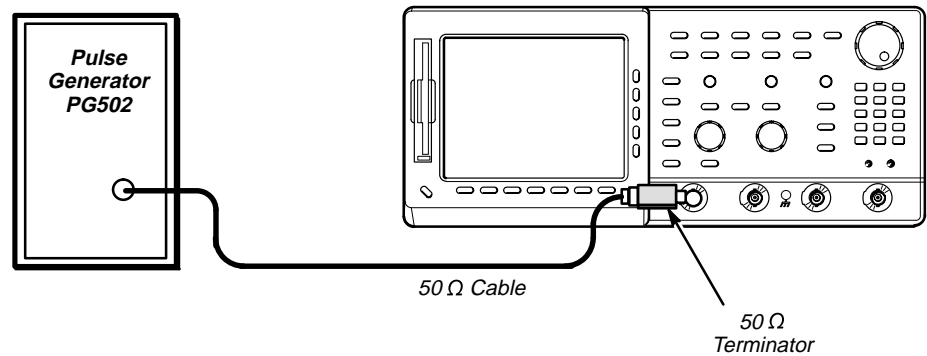

Figure 1-39: PG502 Setup for Sync Duty Cycle Test

- Turn the pulse generator **OUTPUT (VOLTS)** control until the signal on the oscilloscope shows a one division negative going pulse (See Figure 1-40).

NOTE

You may need to adjust the trigger level control to obtain a stable trigger.

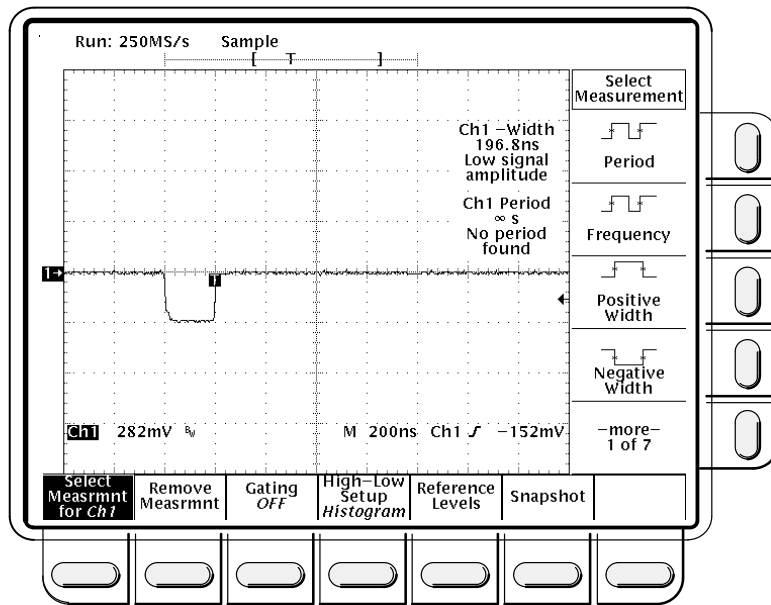

Figure 1-40: Sync Duty Cycle Test: One-Div Neg Pulse Waveform

- Turn the pulse generator **PULSE DURATION** variable control to adjust the negative pulse so the oscilloscope **CH1 – Width** measurement displays **400ns +/-10 ns**.
- Turn the **HORIZONTAL SCALE** knob to set the oscilloscope time base to **5 μs/div**.
- Turn the pulse generator **PERIOD** variable control to adjust the period until the oscilloscope **CH1 Period** measurement reads **21.000μs -25/+50 ns** (See Figure 1-41). Read note shown below.

NOTE

The pulse duration and period adjustments are critical in making this measurement. If the pulse duration and/or the duty cycle are not stable, the FLEXFMT function may not function. You must take care when making these adjustments.

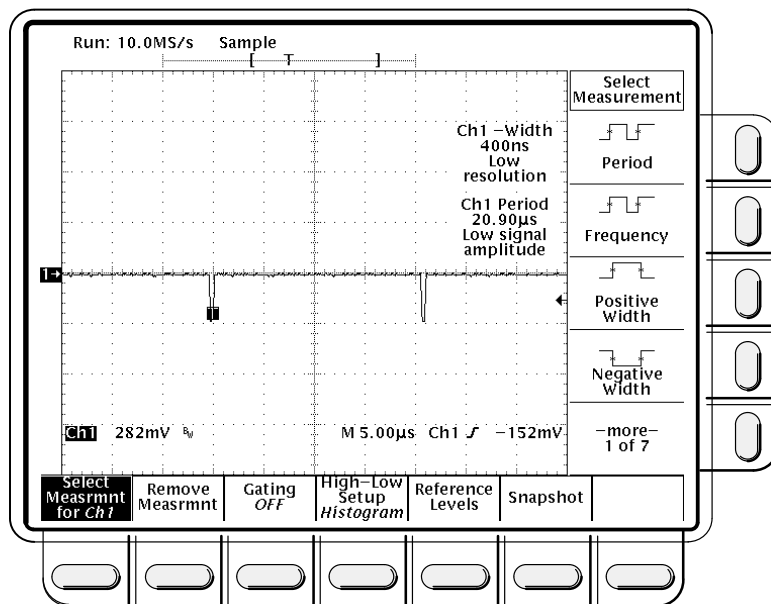

Figure 1-41: Sync Duty Cycle Test: Critically Adjusted Pulse

- Press **TRIGGER MENU**.
- Press the main-menu **Type** pop-up until you select **Video**.

If the **TRIG'D** LED is not on, check that the **CH1 – Width** and **CH1 Period** measurements are adjusted correctly (see note above). CONFIRM that the setup is correct and the oscilloscope will trigger.

- CONFIRM that the **TRIG'D** LED is on and the waveform is stable.
- Disconnect the signal source from CH1, wait a few seconds, then reconnect the signal.
- CONFIRM that the **TRIG'D** LED is on and the waveform is stable.
- Press **Sync Polarity**.
- Press **Pos Sync**.
- Push the pulse generator **COMPLEMENT** button out.
- CONFIRM that the **TRIG'D** LED is on and the waveform is stable.
- Disconnect the signal source from CH1, wait a few seconds, then reconnect the signal.
- CONFIRM that the **TRIG'D** LED is on and the waveform is stable.

Performance Tests

- Disconnect all test equipment (TSG 121) from the oscilloscope.
- Press save/recall **SETUP**, press the main-menu button **Recall Factory Setup**, and the side-menu **OK Confirm Factory Init**.

Specifications

Specifications

This subsection begins with a general description of the traits of the TDS 520A, 524A, 540A and 544A Digitizing Oscilloscopes. Three subsections follow, one for each of three classes of traits: *nominal traits*, *warranted characteristics*, and *typical characteristics*.

General Product Description

The Tektronix TDS 520A, 524A, 540A and 544A Digitizing Oscilloscopes are portable, four-channel instruments suitable for use in a variety of test and measurement applications and systems. Key features include:

- 500 MHz maximum analog bandwidth.
- 1 Gigasample/second maximum digitizing rate (TDS 540A and 544A); 500 Megasamples/second maximum digitizing rate (TDS 520A and 524A).
- Four-channel acquisition — the TDS 540A and 544A offer four full-featured channels; the TDS 520A and 524A offer two full-featured channels and two channels with limited vertical scale selections: 100 mV, 1 V, and 10 V.
- Extensive triggering capabilities: such as edge, logic, and glitch. Video trigger (Option 05) is also available. The video trigger modes are NTSC, PAL, SECAM, HDTV, and FlexFormat™ (user definable format).
- Waveform Math — Invert a single waveform and add, subtract, and multiply two waveforms. On the TDS 524A, 544A, and other TDS 500A equipped with option 2F, integrate or differentiate a single waveform or perform an FFT (fast fourier transform) on a waveform to display its magnitude or phase versus its frequency.
- Eight-bit digitizers.
- Up to 15,000-point record length per channel (50,000-point with option 1M).
- Full GPIB software programmability. Hardcopy output using GPIB, RS-232, or Centronics ports (RS-232 and Centronics is standard on the TDS 524A and 544A and optional, as option 13, on the TDS 520A and 540A).
- Complete measurement and documentation capability.
- Intuitive graphic icon operation blended with the familiarity of traditional horizontal and vertical knobs.
- On-line help at the touch of a button.
- A full complement of advanced functions, like continuously-updated measurements, results and local pass/fail decision making.

- Specialized display modes, such as variable persistence (with color coding on the TDS 524A and 544A), dot or vector mode, $\sin(x)/x$ or linear display filters, and, on the TDS 524A and 544A, user selectable color palettes. The “Fit to Screen” feature compresses the entire waveform record to fit on the screen.
- A complement of advanced acquisition modes such as peak-detect, high-resolution, sample, envelope, and average. The FastFrame™ feature acquires waveforms in rapid succession with a minimum of dead time between acquisitions. FastFrame™ allows acquisition rates of up to 50,000 frames per second.
- A unique graphical user interface (GUI), an on-board help mode, and a logical front-panel layout which combine to deliver a new standard in usability.
- VGA output for driving remote monitors.
- A 1.44 Mbyte, DOS 3.3 or later, floppy disk drive for saving waveforms, color images, and oscilloscope setups (standard on the TDS 524A and 544A and optional, as option 1F, on the TDS 520A and 540A). Also, all TDS 500A have built-in NVRAM storage for saving waveforms and setups.
- On the 524A and 544A, a color display for distinguishing among waveforms, their measurements, and associated text.

User Interface

Use a combination of front-panel buttons, knobs, and on-screen menus to control the many functions of these oscilloscopes. The front-panel controls are grouped according to function: vertical, horizontal, trigger, and special. Set a function you adjust often, such as vertical positioning or the time base setting, directly by its own front-panel knob. Set functions which you change less often, such as vertical coupling and horizontal mode, indirectly using selected menus.

Menus

Pressing one (sometimes two) front-panel button(s), such as vertical menu, displays a *main* menu of related functions, such as coupling, bandwidth, etc., at the bottom of the screen. Pressing a main-menu button, such as coupling, displays a *side* menu of settings for that function, such as AC, DC, or GND (ground) coupling, at the right side of the screen. Pressing a side-menu button selects a setting such as DC.

Indicators

On-screen readouts help you keep track of the settings for various functions, such as vertical and horizontal scale and trigger level. Some readouts use the cursors or the automatic parameter extraction feature (called measure) to display the results of measurements made or the status of the instrument.

General Purpose Knob

Assign the general purpose knob to adjust a selected parameter function. More quickly change parameters by toggling the **SHIFT** button. Use the same method as for *selecting* a function, except the final side-menu selection assigns the general purpose knob to *adjust* some function, such as the position of measurement cursors on screen, or the setting for a channels fine gain.

GUI

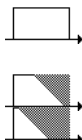

The user interface also makes use of a GUI, or Graphical User Interface, to make setting functions and interpreting the display more intuitive. Some menus and status are displayed using iconic representations of function settings such as those shown here for full, 100 MHz, and 20 MHz bandwidth. Such icons allow you to more readily determine status or the available settings.

Signal Acquisition System

TDS 540A and 544A: The signal acquisition system provides four vertical channels with calibrated vertical scale factors from 1 mV to 10 V per division. All four channels can be acquired simultaneously.

Each of the four TDS 540A and 544A channels can be displayed, vertically positioned, and offset, can have their bandwidth limited (100 MHz or 20 MHz) and their vertical coupling specified. Fine gain can also be adjusted.

TDS 520A and 524A: The signal acquisition system provides four vertical channels. Two are full-featured vertical channels (CH1 and CH2) with calibrated vertical scale factors from 1 mV to 10 V per division. The other two are auxiliary channels (AUX1 and AUX2) with three calibrated deflection factors of 100 mV, 1 V, and 10 V per division. Any two of the four channels can be acquired simultaneously.

Each of the four TDS 520A and 524A channels can be displayed, vertically positioned, and offset. CH1 and CH2 can also have their bandwidth limited (100 MHz or 20 MHz) and their vertical coupling specified. Fine gain can also be adjusted for CH1 and CH2.

On all TDS 520A, 524A, 540A and 544A: Besides the four channels, up to three math waveforms and four reference waveforms are available for display. (A math waveform results when dual waveform operations, such as add, are specified on any two channels. A reference waveform results when you save a live waveform in a reference memory.)

Horizontal System

There are three horizontal display modes: main only, main intensified, and delayed only. You can select among various horizontal record length settings.

A feature called "Fit to Screen" allows the user to view entire waveform records within the 10 division screen area. In other words, waveforms are compressed to fit on the screen. The exception is that, with Option 1M, 50,000 point records are displayed over a 15 division time span. (see Table 2-1)

Table 2-1: Record Length vs. Divisions per Record, Samples Per Division, and Sec/Div Sequence

| Record Length | Divisions per Records | |
|--------------------|-------------------------------------|--------------------------------|
| | Samples/Division (Sec/Div Sequence) | |
| | Fit to Screen OFF 50 (1-2-5) | Fit to Screen ON 50 (1-2-5) |
| 50000 ¹ | 1000 divisions | 10 divisions |
| 15000 ² | 300 divisions | 15 divisions |
| 5000 | 100 divisions | 10 divisions |
| 2500 | 50 divisions | 10 divisions |
| 1000 | 20 divisions | 10 divisions |
| 500 | 10 divisions | 10 divisions |

1 The 50,000 samples in 1,000 division record is only available with Option 1M.

2 The maximum record length of 15,000 samples (50,000 samples with Option 1M) is selectable with all acquisition modes except Hi Res. In Hi Res, the maximum record length is 5,000 samples (15,000 samples with Option 1M).

FastFrame™ allows multiple triggered acquisitions to occur with a minimum of "dead time" between acquisitions. A maximum of 910 acquisition sequences (frames) are possible with 50 points per record (frame length) when a 50,000 point waveform record length is available (with option 1M).

You can delay by time with respect to the main trigger both the delayed display and the intensified zone on the main intensified display. You can set them to display immediately after the delay (delayed runs after main mode). The delayed display can also be set to display at the first valid trigger after the delay (delayed triggerable mode).

You can also delay by a selected number of events the delayed display (or the intensified zone). In this case, the events source is the delayed trigger source. For any events signal, the delayed-trigger system conditions the signal by determining the source, coupling, etc., of that signal.

Trigger System

The triggering system supports a varied set of features for triggering the signal-acquisition system. Trigger signals recognized include:

- **Edge** (main- and delayed-trigger systems): This familiar type of triggering is fully configurable for source, slope, coupling, mode (auto or normal), and holdoff.
- **Logic** (main-trigger system): This type of triggering can be based on pattern (asynchronous) or state (synchronous). In either case, logic triggering is configurable for sources, for boolean operators to apply to those sources, for logic pattern or state on which to trigger, for mode (auto or normal), and for holdoff. Time-qualified logic triggering can also be specified.
- **Pulse** (main-trigger system): Pulse triggering is configurable for triggering on runt or glitch pulses, or on pulse widths or periods inside or outside limits that you specify. It is also configurable for source, polarity, mode, and holdoff.
- **Video** (with option 05: Video Trigger): Video triggering is compatible with standard NTSC, PAL, SECAM, and HDTV formats. An additional feature called FlexFormat™ (flexible format) allows the user to define the video format on which to trigger.

You can choose where the trigger point is located within the acquired waveform record by selecting the amount of pretrigger data displayed. Select presets of 10%, 50%, and 90% of pretrigger data in the horizontal menu, or assign the general purpose knob to set pretrigger data to any value within the limits of trigger position resolution.

Acquisition Control

You can specify a mode and manner to acquire and process signals.

- Select equivalent-time sampling on repetitive signals or interpolation of points sampled on non-repetitive signals. Both can increase apparent sample rate on the waveform when maximum real-time rates are reached. The apparent sample rate can be increased, even further, by using the FastFrame™ feature. Acquisition rates of 50,000 Frames/Second are possible using FastFrame™.
- Use peak-detect, high-resolution, sample, envelope, and average modes can be used to acquire signals.
- Set the acquisition to stop after a single acquisition (or sequence of acquisitions if acquiring in average or envelope modes).
- Select channel sources for compliance with limit tests. You can direct the TDS to signal you or generate hard copy output based on the results. Also, you can create templates for use in limit tests.

On-Board User Assistance

Help and autoset can assist you in setting up the Digitizing Oscilloscope to make your measurements.

Help

Help displays operational information about any front-panel control. When help mode is in effect, manipulating any front-panel control causes the oscilloscope to display information about that control. When help is first invoked, an introduction to help is displayed on screen.

Autoset

Autoset automatically sets up the oscilloscope for a viewable display based on the input signal.

Measurement Assistance

Once you have set up to make your measurements, the cursor and measure features can help you quickly make those measurements.

Cursor

Three types of cursors are provided for making parametric measurements on the displayed waveforms. Horizontal bar cursors (H Bar) measure vertical parameters (typically volts). Vertical bar cursors (V Bar) measure horizontal parameters (typically time or frequency) and now extend to the top and bottom of the screen. Paired cursors measure both amplitude and time simultaneously. These are delta measurements; that is, measurements based on the difference between two cursors.

Both H Bar and V Bar cursors can also be used to make absolute measurements; that is measurements relative to a defined level or event. For the H Bars, either cursor can be selected to read out its voltage with respect to any channels ground reference level. For the V Bars, it's time with respect to the trigger point (event) of the acquisition, and the cursors can control the portion of the waveform on which automatic measurements are made.

For time measurements, units can be either seconds or Hertz (for 1/time).

When the video trigger option installed (Option 05), the video line number can be selected using the vertical cursors. IRE amplitude (NTSC) can be measured using the horizontal cursors with or without the video trigger option installed.

Measure

Measure can automatically extract parameters from the signal input to the Digitizing Oscilloscope. Any four out of the more than 20 parameters available can be displayed to the screen. The waveform parameters are measured continuously with the results updated on-screen as the Digitizing Oscilloscope continues to acquire waveforms.

Digital Signal Processing (DSP)

An important component of the multiprocessor architecture of this Digitizing Oscilloscope is Tektronix's proprietary digital signal processor, the DSP. This dedicated processor supports advanced analysis of your waveforms when doing such compute-intensive tasks as interpolation, waveform math, and signal averaging. It also teams with a custom display system to deliver specialized display modes (See *Display*, later in this description.)

Storage and I/O

Acquired waveforms may be saved in any of four nonvolatile REF (reference) memories or, if available, on a 3.5 inch, DOS 3.3-or-later compatible disk. The disk is standard on the TDS 524A and 544A. It is available as option 1F on the 520A and 540A. Any or all of the saved waveforms may be displayed for comparison with the waveforms being currently acquired.

The source and destination of waveforms to be saved may be chosen. Assignment can be made to save any of the four channels to any REF memory or to move a stored reference from one REF memory to another. Reference waveforms may also be written into a REF memory location via the GPIB interface.

The Digitizing Oscilloscope is fully controllable and capable of sending and receiving waveforms over the GPIB interface (IEEE Std 488.1–1987/IEEE Std 488.2–1987 standard). This feature makes the instrument ideal for making automated measurements in a production or research and development environment that calls for repetitive data taking. Self-compensation and

self-diagnostic features built into the Digitizing Oscilloscope to aid in fault detection and servicing are also accessible using commands sent from a GPIB controller.

Another standard feature is hardcopy. This feature allows you to output waveforms and other on-screen information to a variety of graphic printers and plotters from the Digitizing Oscilloscope front panel, providing hard copies without requiring you to put the Digitizing Oscilloscope into a system-controller environment. You can make hardcopies in a variety of popular output formats, such as PCX, TIFF, BMP, RLE, EPS, Interleaf, and EPS mono or color. You can also save hardcopies in a disk file in any of the formats above. The hardcopies obtained are based on what is displayed on-screen at the time hardcopy is invoked. The hardcopies can be stamped with date and time and spooled to a queue for printing at a later time. You can output screen information via GPIB, RS-232C, or Centronics interfaces.

Display

The TDS 520A, 524A, 540A and 544A Digitizing Oscilloscopes offer flexible display options. You can customize the following attributes of your display:

- Color: Waveforms, readouts, graticule, etc. on the TDS 524A and 544A;
- Intensity: waveforms, readouts, and graticule;
- Style of waveform display(s): vectors or dots, intensified or non-intensified samples, infinite persistence, and variable persistence with color coding;
- Interpolation method: Sin(x)/x or Linear;
- Display format: xy or yt with various graticule selections including NTSC and PAL to be used with video trigger.

Zoom

This Digitizing Oscilloscope also provides an easy way to focus in on those waveform features you wish to examine up close. By invoking zoom, you can magnify the waveform parameter using the vertical and horizontal controls to expand (or contract) and position it for viewing.

Nominal Traits

This subsection contains tables that list the electrical and mechanical *nominal traits* that describe the TDS 520A, 524A, 540A and 544A Digitizing Oscilloscopes.

Nominal traits are described using simple statements of fact such as “Four, all identical” for the trait “Input Channels, Number of”, rather than in terms of limits that are performance requirements.

Table 2-2: Nominal Traits — Signal Acquisition System

| Name | Description | |
|--|--|---------------------|
| Bandwidth Selections | 20 MHz, 100 MHz, and FULL (500 MHz) | |
| Digitizers, Number of | TDS 540A and 544A: Four, all identical TDS 520A and 524A: Two, both identical | |
| Digitized Bits, Number of | 8 bits ¹ | |
| Input Channels, Number of | TDS 540A and 544A: Four, all identical, called CH1 – CH4 TDS 520A and 524A: Two full-featured (CH1 and CH2), plus two limited, auxiliary inputs (AUX1 and AUX2) | |
| Input Coupling ² | DC, AC, or GND | |
| Input Impedance Selections | 1 MΩ or 50 Ω | |
| Ranges, Offset, TDS 540A, 544A, and CH1 and CH2 on TDS 520A and 524A | Volts/Div Setting | Offset Range |
| | 1 mV/div – 99.5 mV/div | ⌊ V |
| | 100 mV/div – 995 mV/div | ⌊ V |
| | 1 V/div – 10 V/div | ⌊ V |
| Ranges, Offset, AUX1 and AUX2 on TDS 520A and 524A | Volts/Div Setting | Offset Range |
| | 100 mV/div | ⌊ V |
| | 1 V/div | ⌊ V |
| | 10 V/div | ⌊ V |
| Range, Position | ⌊ divisions | |
| Range, Sensitivity | TDS 540A and 544A: 1 mV/div to 10 V/div ³ TDS 520A and 524A: CH1 and CH2: 1 mV/div to 10 V/div ³ TDS 520A and 524A: AUX1 and AUX2: 100 mV/div, 1 V/div, 10 V/div | |

- 1 Displayed vertically with 25 digitization levels (DLs) per division and 10.24 divisions dynamic range with zoom off. A DL is the smallest voltage level change that can be resolved by the 8-bit A-D Converter, with the input scaled to the volts/division setting of the channel used. Expressed as a voltage, a DL is equal to 1/25 of a division times the volts/division setting.
- 2 The input characteristics (*Input Coupling, Input Impedance Selections, etc.*) apply to both full-featured and auxiliary inputs except where otherwise specified.
- 3 The sensitivity ranges from 1 mV/div to 10 V/div in a 1–2–5 sequence of coarse settings. Between a pair of adjacent coarse settings, the sensitivity can be finely adjusted. The resolution of such a fine adjustment is 1% of the more sensitive of the pair. For example, between 50 mV/div and 100 mV/div, the volts/division can be set with 0.5 mV resolution.

Table 2-3: Nominal Traits — Time Base System

| Name | Description | | | | | | | | |
|---|---|-----------------------|-------------------|---|------------------------------|---|------------------------------|--------|------------------------------|
| Range, Sample-Rate ^{1,3} TDS 540A, 544A | <table border="1"> <thead> <tr> <th>Number of Channels On</th> <th>Sample-Rate Range</th> </tr> </thead> <tbody> <tr> <td>1</td> <td>5 Samples/s – 1 GSamples/s</td> </tr> <tr> <td>2</td> <td>5 Samples/s – 500 MSamples/s</td> </tr> <tr> <td>3 or 4</td> <td>5 Samples/s – 250 MSamples/s</td> </tr> </tbody> </table> | Number of Channels On | Sample-Rate Range | 1 | 5 Samples/s – 1 GSamples/s | 2 | 5 Samples/s – 500 MSamples/s | 3 or 4 | 5 Samples/s – 250 MSamples/s |
| Number of Channels On | Sample-Rate Range | | | | | | | | |
| 1 | 5 Samples/s – 1 GSamples/s | | | | | | | | |
| 2 | 5 Samples/s – 500 MSamples/s | | | | | | | | |
| 3 or 4 | 5 Samples/s – 250 MSamples/s | | | | | | | | |
| Range, Sample-Rate ^{1,3} TDS 520A, 524A | <table border="1"> <thead> <tr> <th>Number of Channels On</th> <th>Sample-Rate Range</th> </tr> </thead> <tbody> <tr> <td>1</td> <td>5 Samples/s – 500 MSamples/s</td> </tr> <tr> <td>2</td> <td>5 Samples/s – 250 MSamples/s</td> </tr> </tbody> </table> | Number of Channels On | Sample-Rate Range | 1 | 5 Samples/s – 500 MSamples/s | 2 | 5 Samples/s – 250 MSamples/s | | |
| Number of Channels On | Sample-Rate Range | | | | | | | | |
| 1 | 5 Samples/s – 500 MSamples/s | | | | | | | | |
| 2 | 5 Samples/s – 250 MSamples/s | | | | | | | | |
| Range, Equivalent Time or Interpolated Waveform Rate ^{2,3} | 500 MSamples/s to 100 GSamples/s | | | | | | | | |
| Range, Seconds/Division | 500 ps/div to 10 s/div | | | | | | | | |
| Record Length ⁴ | 500 samples, 1000 samples, 2500 samples, 5000 samples, 15000 samples. A record length of 50000 samples is available with Option 1M. Up to four 50 K waveform records may be saved in NVRAM with Option 1M installed. | | | | | | | | |
| FastFrame™ | <p>Maximum Frame Rate: 50,000 Frames/Second</p> <p>Frame Length Range: 50 points/Frame to 5,000 Points/Frame</p> <p>Maximum Number of Frames:</p> <p>910 Frames at 50 Points/Frame (with Option 1M, 50,000 Record Length)</p> <p>227 Frames at 50 Points/Frame (standard configuration of 15,000 Record Length)</p> | | | | | | | | |

- 1 The range of real-time rates, expressed in samples/second, at which a digitizer samples signals at its inputs and stores the samples in memory to produce a record of time-sequential samples
- 2 The range of waveform rates for equivalent time or interpolated waveform records.
- 3 The Waveform Rate (WR) is the equivalent sample rate of a waveform record. For a waveform record acquired by real-time sampling of a single acquisition, the waveform rate is the same as the real-time sample rate; for a waveform created by interpolation of real-time samples from a single acquisition or by equivalent-time sampling of multiple acquisitions, the waveform rate is faster than the real time sample rate. For all three cases, the waveform rate is 1/(Waveform Interval) for the waveform record, where the waveform interval (WI) is the time between the samples in the waveform record.
- 4 The maximum record length of 15,000 samples (50,000 samples with Option 1M) is selectable with all acquisition modes except Hi Res. In Hi Res, the maximum record length is 5,000 samples (15,000 samples with Option 1M).

Table 2-4: Nominal Traits — Triggering System

| Name | Description | | | | | | | | |
|--|--|--------|-------|-------------|----------------------|----------------------------------|-----------------|------|-----------------|
| Range, Delayed Trigger Time Delay | 16 ns to 250 s | | | | | | | | |
| Range, Events Delay | 2 to 10,000,000 | | | | | | | | |
| Range (Time) for Pulse-Glitch or Pulse-Width Triggering | 2 ns to 1 s | | | | | | | | |
| Ranges, Trigger Level or Threshold | <table border="1"> <thead> <tr> <th>Source</th> <th>Range</th> </tr> </thead> <tbody> <tr> <td>Any Channel</td> <td>$\frac{1}{2}$ screen</td> </tr> <tr> <td>Auxiliary (TDS 540A & 544A only)</td> <td>$\frac{1}{2}$ V</td> </tr> <tr> <td>Line</td> <td>$\frac{1}{2}$ V</td> </tr> </tbody> </table> | Source | Range | Any Channel | $\frac{1}{2}$ screen | Auxiliary (TDS 540A & 544A only) | $\frac{1}{2}$ V | Line | $\frac{1}{2}$ V |
| Source | Range | | | | | | | | |
| Any Channel | $\frac{1}{2}$ screen | | | | | | | | |
| Auxiliary (TDS 540A & 544A only) | $\frac{1}{2}$ V | | | | | | | | |
| Line | $\frac{1}{2}$ V | | | | | | | | |
| Video Trigger Modes of Operation (Option 05 Video Trigger) | <p>Supports the following video standards:</p> <ul style="list-style-type: none"> ■ NTSC (525/60) – 2 field mono or 8 field ■ PAL (625/50) – 2 field mono, 8 field ■ SECAM ■ HDTV – <ul style="list-style-type: none"> (787.5/60) (1050.60) (1125/60) (1250/60) ■ FlexFormat™ (user definable standards) <p>User can specify: field rate, number of lines, sync pulse width and polarity, line rate, and vertical interval timing.</p> | | | | | | | | |

Table 2-5: Nominal Traits — Display System

| Name | Description |
|------------------------------------|--|
| Video Display | 7 inch diagonal, with a color display area of 5.04 inches horizontally by 3.78 inches vertically |
| Video Display Resolution | 640 pixels horizontally by 480 pixels vertically |
| Waveform Display Graticule | Single Graticule: 401 × 501 pixels, 8 × 10 divisions, where divisions are 1 cm by 1 cm |
| Waveform Display Colors/Grey Scale | TDS 524A and 544A: Sixteen colors in infinite-persistence or variable persistence display with color coding. TDS 520A and 540A: Sixteen levels in infinite-persistence and variable persistence display styles. |

Nominal Traits

Table 2-6: Nominal Traits — Interfaces, Output Ports, and Power Fuse

| Name | Description |
|--|--|
| Interface, GPIB | GPIB interface complies with IEEE Std 488–1987 |
| Interface, RS-232 | RS-232 interface complies with EIA/TIA 574 (talk only) (optional, as option 13, on TDS 520A and 540A) |
| Interface, Centronics | Centronics interface complies with Centronics interface standard C332-44 Feb 1977, REV A (optional, as option 13, on TDS 520A and 540A) |
| Interface, Video | VGA video output with levels that comply with ANSI R5343A standard. DB-15 connector. |
| Logic Polarity for Main- and Delayed-Trigger Outputs | Negative TRUE. High to low transition indicates the trigger occurred. |
| Fuse Rating | Either of two fuses ¹ may be used: a .25" × 1.25" (UL 198.6, 3AG): 6 A FAST, 250 V, or a 5 mm × 20 mm, (IEC 127): 5 A (T), 250 V. |

1 Each fuse type requires its own fuse cap.

Table 2-7: Nominal Traits — Mechanical

| Name | Description |
|-----------------------|--|
| Cooling Method | Forced-air circulation with no air filter |
| Construction Material | Chassis parts constructed of aluminum alloy; front panel constructed of plastic laminate; circuit boards constructed of glass-laminate. Cabinet is aluminum and is clad in Tektronix Blue vinyl material. |
| Finish Type | Tektronix Blue vinyl-clad aluminum cabinet |
| Weight | <p>Standard TDS 524A and 544A Digitizing Oscilloscope 13.7 kg (30 lbs), with front cover. 25.1 kg (55 lbs), when packaged for domestic shipment.</p> <p>Standard TDS 520A and 540A Digitizing Oscilloscope 12.3 kg (27 lbs), with front cover. 20.0 kg (44 lbs), when packaged for domestic shipment.</p> <p>Rackmount TDS 524A and 544A Digitizing Oscilloscope 13.7 kg (30 lbs) plus weight of rackmount parts, for the rack-mounted Digitizing Oscilloscope (Option 1R).</p> <p>Rackmount TDS 520A and 540A Digitizing Oscilloscope 12.3 kg (27 lbs) plus weight of rackmount parts, for the rack-mounted Digitizing Oscilloscope (Option 1R).</p> <p>Rackmount conversion kit 2.3 kg (5 lbs), parts only; 3.6 kg (8 lbs), parts plus package for domestic shipping.</p> |
| Overall Dimensions | <p>Standard Digitizing Oscilloscope Height: 193 mm (7.6 in), with the feet installed. Width: 445 mm (17.5 in), with handle. Depth: 434 mm (17.1 in), with front cover installed.</p> <p>Rackmount Digitizing Oscilloscope Height: 178 mm (7.0 in). Width: 483 mm (19.0 in). Depth: 558.8 mm (22.0 in).</p> |

Warranted Characteristics

This subsection lists the electrical and environmental *warranted characteristics* that describe the TDS 520A, 524A, 540A and 544A Digitizing Oscilloscopes.

Warranted characteristics are described in terms of quantifiable performance limits which are warranted.

NOTE

*In these tables, those warranted characteristics that are checked in the procedure Performance Verification, found in Section 1, appear in **boldface type** under the column **Name**.*

As stated above, this subsection lists only warranted characteristics. A list of *typical characteristics* starts on page 2-21.

Performance Conditions

The electrical characteristics found in these tables of warranted characteristics apply when the scope has been adjusted at an ambient temperature between +20° C and +30° C, has had a warm-up period of at least 20 minutes, and is operating at an ambient temperature between +4° C and +50° C (unless otherwise noted).

Table 2-8: Warranted Characteristics — Signal Acquisition System

| Name | Description | |
|---|---|---|
| Accuracy, DC Gain | $\frac{1}{2}$ (For all sensitivities from 1 mV/div to 10 V/div with offsets from 0 V to $\frac{1}{2}$ V) | |
| Accuracy, Offset TDS 540A and 544A (all channels), TDS 520A and 524A (CH1 and CH2) | Volts/Div Setting | Offset Accuracy |
| | 1 mV/div – 99.5 mV/div | $\frac{1}{2}$ × Net Offset ¹ + 1.5 mV + 0.1 div × volts/div setting) |
| | 100 mV/div – 995 mV/div | $\frac{1}{2}$ × Net Offset ¹ + 15 mV + 0.1 div × volts/div setting) |
| | 1 V/div – 10 V/div | $\frac{1}{2}$ × Net Offset ¹ + 150 mV + 0.1 div × volts/div setting) |
| Accuracy, Offset TDS 520A and 524A (AUX1 and AUX2) | | Offset Accuracy |
| | | $\frac{1}{2}$ × Net Offset ¹ + 0.1 div × volts/div setting) |

Table 2-8: Warranted Characteristics — Signal Acquisition System (Cont.)



| Name | Description | |
|--|--|--------------------------------|
| Analog Bandwidth, DC-50 Ω Coupled or DC-1 M Ω Coupled | Volts/Div | Bandwidth⁴ |
| | 5 mV/div – 10 V/div | DC – 500 MHz |
| | 2 mV/div – 4.98 mV/div | DC – 350 MHz |
| | 1 mV/div – 1.99 mV/div | DC – 250 MHz |
| Cross Talk (Channel Isolation) | $\geq 100:1$ at 100 MHz and $\geq 30:1$ at the derated bandwidth for any two channels having equal volts/division settings | |
| Input Impedance, DC-1 M Ω Coupled | 1 M Ω \pm | \pm pF |
| Input Impedance, DC-50 Ω Coupled | 50 Ω \pm | $\leq 1.3:1$ from DC – 500 MHz |
| Input Voltage, Maximum, DC-1 M Ω , AC-1 M Ω , or GND Coupled | \pm | MHz |
| Input Voltage, Maximum, DC-50 Ω or AC-50 Ω Coupled | 5 V _{RMS} , with peaks $\leq \pm$ V | |
| Lower Frequency Limit, AC Coupled | ≤ 10 Hz when AC-1 M Ω Coupled; ≤ 200 kHz when AC – 50 Ω Coupled ⁵ | |

- 1 Net Offset = Offset – (Position \times Volts/Div). Net Offset is the nominal voltage level at the center of the A-D converter dynamic range. Offset Accuracy is the accuracy of this Voltage level.
- 2 The samples must be acquired under the same setup and ambient conditions.
- 3 To ensure the most accurate measurements possible, run an SPC calibration first. When using the oscilloscope at a Volts/Div setting ≤ 5 mV/div, an SPC calibration should be run once per week to ensure that instrument performance levels meet specifications.
- 4 The limits given are for the ambient temperature range of 0° C to +30° C. Reduce the upper bandwidth frequencies by 2.5 MHz for each ° C above +30° C.
- 5 The AC Coupled Lower Frequency Limits are reduced by a factor of 10 when 10X, passive probes are used.

Table 2-9: Warranted Characteristics — Time Base System

| Name | Description | |
|--|-------------|----------------------|
| Accuracy, Long Term Sample Rate and Delay Time | \pm | ≥ 1 ms interval |

Table 2-10: Warranted Characteristics — Triggering System

| Name | Description | | |
|--|---|---|---|
| Accuracy (Time) for Pulse-Glitch or Pulse-Width Triggering | Time Range | Accuracy | |
| | 2 ns to 1 μ s |  | ns) |
| | 1.02 μ s to 1 s |  | setting) |
| Sensitivity, Edge-Type Trigger, DC Coupled¹ | Trigger Source | Sensitivity | |
| | TDS 540A, 544A (CH1 – CH4) | 0.35 division from DC to 50 MHz, increasing to 1 division at 500 MHz | |
| | TDS 520A, 524A (CH1, CH2) | 0.55 division from DC to 50 MHz, increasing to 1.5 division at 500 MHz | |
| | TDS 520A, 524A (AUX1, AUX2) | 0.25 volts from DC to 50 MHz | |
| | Auxiliary (TDS 540A, 544A only) | | |
| Width, Minimum Pulse and Rearm, for Pulse Triggering | Pulse Class | Minimum Pulse Width | Minimum Rearm Width |
| | Glitch | 2 ns | 2 ns + 5% of Glitch Width Setting 2.5 ns |
| | Runt | 2.5 ns | 2 ns + 5% of Width Upper Limit Setting |
| | Width | 2 ns | |
| Jitter (Option 05 Video Trigger) | 17 ns _{p-p} on HDTV signal; 60 ns _{p-p} on NTSC or PAL signal | | |
| Input Signal Sync Amplitude for Stable Triggering (Option 05 Video Trigger) | 0.6 division to 4 division (1 division to 4 divisions in Numerical Field) | | |

¹ The minimum sensitivity for obtaining a stable trigger. A stable trigger results in a uniform, regular display triggered on the selected slope. The trigger point must not switch between opposite slopes on the waveform, and the display must not “roll” across the screen on successive acquisitions. The TRIG'D LED stays constantly lighted when the SEC/DIV setting is 2 ms or faster but may flash when the SEC/DIV setting is 10 ms or slower.

Warranted Characteristics

Table 2-11: Warranted Characteristics — Interfaces, Output Ports and Power Requirements





| Name | Description | |
|--|---|---|
| Logic Levels, Main- and Delayed-Trigger Outputs | Characteristic Vout (HI) | Limits ≥ 2.5 V open circuit; ≥ 1.0 V into a 50 Ω load to ground |
| | Vout (LO) | ≤ 0.7 V into a load of ≤ 4 mA; ≤ 0.25 V into a 50 Ω load to ground |
| Output Voltage and Frequency, Probe Compensator | Characteristic Output Voltage | Limits 0.5 V (base-top)  ≥ 50 Ω load |
| | Frequency | 1 kHz  |
| Output Voltage, Channel 3 Signal Out | 20 mV/division  50 Ω load | 1 MΩ load; 10 mV/division  a |
| Source Voltage | 90 to 250 VAC _{RMS} , continuous range | |
| Source Frequency | 47 Hz to 63 Hz | |
| Power Consumption | ≤ 300 W (450 VA) | |

Table 2-12: Warranted Characteristics — Environmental, Safety, and Reliability

| Name | Description |
|------------------------|--|
| Atmospherics | <p>Temperature with floppy disk (optional on TDS 520A and 540A): Operating: +4° C to +50° C; Non-operating: –22° C to +60° C</p> <p>Temperature without floppy disk: Operating: 0° C to +50° C; Non-operating: –40° C to +60° C</p> <p>Relative humidity with floppy disk (optional on TDS 520A and 540A): Operating: To 80%, at or below +29° C; Operating: To 20%, at or below +50° C Non-operating: To 90%, at or below +40° C; Non-operating: To 5%, at or below +50° C</p> <p>Relative humidity without floppy disk: To 95%, at or below +40° C; To 75%, from +41° C to +55° C</p> <p>Altitude: To 4570 m (15,000 ft.), operating; To 12190 m (40,000 ft.), non-operating</p> |
| Dynamics | <p>Random vibration without floppy disk installed: 0.31 g_{RMS}, from 5 to 500 Hz, 10 minutes each axis, operating; 3.07 g_{RMS}, from 5 to 500 Hz, 10 minutes each axis, non-operating</p> |
| Emissions | <p>Meets or exceeds the requirements of the following standards: Vfg. 243/1991 Amended per Vfg. 46/1992 FCC Code of Federal Regulations, 47 CFR, Part 15, Subpart B, Class A</p> |
| User-Misuse Simulation | <p>Electrostatic Discharge Susceptibility: Up to 8 kV with no change to control settings or impairment of normal operation; up to 15 kV with no damage that prevents recovery of normal operation by the user</p> |

Warranted Characteristics

Typical Characteristics

The tables in this subsection list the *typical characteristics* that describe the TDS 520A, 524A, 540A and 544A Digitizing Oscilloscopes.

Typical characteristics are described in terms of typical or average performance. Typical characteristics are not warranted.

Table 2-13: Typical Characteristics — Signal Acquisition System

| Name | Description | |
|--|---|------------------|
| Accuracy, Delta Time Measurement | For single-shot acquisitions using single-shot sample acquisition modes. ¹ | |
| | Time Measurement Error $\leq .15 * Si + (25 \text{ ppm} \times \text{Reading}) + (\text{Time Per Div} \div 1000)$ | |
| | Add 50 ps (typical) Channel Skew for 2 channel measurements. | |
| | Sample calculation: To measure the width of a 65.5 ns pulse at 1 GS/sec sampling, Time Measurement Error $\leq (0.15 \times 1 \text{ ns}) + (2.5 \times 10^{-5})(65.5 \text{ ns}) + (50 \text{ ns/div} \div 1000)$ $\leq 0.15 \text{ ns} + 0.002 \text{ ns} + 0.05 \text{ ns}$ $\leq 202 \text{ ps}$ | |
| Delay Between Channels, Full Bandwidth, Equivalent Time | $\leq 250 \text{ ps}$ for any two channels with equal volts/division and coupling settings | |
| Frequency Limit, Upper, 100 MHz Bandwidth Limited | 100 MHz | |
| Frequency Limit, Upper, 20 MHz Bandwidth Limited | 20 MHz | |
| Calculated Rise Time ² | Volts/Div Setting | Rise Time |
| | 5 mV/div–10 V/div | 800 ps |
| | 2 mV/div–4.98 mV/div | 1.2 ns |
| | 1 mV/div–1.99 mV/div | 1.6 ns |
| Nonlinearity | <1 DL, differential; $\leq 1 \text{ DL}$, integral, independently based | |

Typical Characteristics

Table 2-13: Typical Characteristics — Signal Acquisition System (Cont.)

| Name | Description | | Settling Error (%) ³ | | | | |
|---|-------------------|----------------|---------------------------------|---------------|--------------|-------|-------|
| Step Response Settling Errors TDS 540A and 544A, all channels, TDS 520A and 524A, CH1, CH2 only | Volts/Div Setting | Step Amplitude | 20 ns | 100 ns | 20 ms | | |
| | | | 1 mV/div–99.5 mV/div | ≤ 2 V | ≤ 0.5 | ≤ 0.2 | ≤ 0.1 |
| | | | 100 mV/div–995 mV/div | ≤ 20 V | ≤ 1.0 | ≤ 0.5 | ≤ 0.2 |
| | | | 1 V/div–10 V/div | ≤ 200 V | ≤ 1.0 | ≤ 0.5 | ≤ 0.2 |

- The limits are given for signals having pulse height ≥ 5 div, reference level = 50% mid-point, filter set to Sin (x) /x acquired at ≥ 5 mV/div, $1.4 \leq T_r/S_i \leq 5$, where S_i is the hardware sample interval and t_r is the signal rise time.
- The numbers given are valid 0°C to +30°C and will increase as the temperature increases due to the degradation in bandwidth. Rise time is calculated from the bandwidth. It is defined by the following formula:

$$Rise\ Time\ (ns) = \frac{400}{BW\ (MHz)}$$

Note that if you measure rise time, you must take into account the rise time of the test equipment (signal source, etc.) that you use to provide the test signal. That is, the measured rise time (RT_m) is determined by the instrument rise time (RT_i) and the rise time of the test signal source (RT_{gen}) according to the following formula:

$$RT_m^2 = RT_i^2 + RT_{gen}^2$$

- The values given are the maximum absolute difference between the value at the end of a specified time interval after the mid-level crossing of the step, and the value one second after the mid-level crossing of the step, expressed as a percentage of the step amplitude.

Table 2-14: Typical Characteristics — Time Base System

| Name | Description |
|----------------------|-------------|
| Aperture Uncertainty | ≤ 5 ps |

Table 2-15: Typical Characteristics — Triggering System

| Name | Description | | | | | | | | | | |
|---|---|---|---|-------------------------|---|----------------------------------|--|-----------------------|---|----------------------|--|
| Accuracy, Trigger Level or Threshold, DC Coupled | <table border="0"> <tr> <td>Trigger Source</td> <td>Accuracy²</td> </tr> <tr> <td>Any Channel</td> <td>\pm (Offset) + 0.3 div \times volts/div setting + Offset Accuracy)</td> </tr> <tr> <td>Auxiliary (TDS 540A & 544A only)</td> <td>\pm mV)</td> </tr> </table> | Trigger Source | Accuracy² | Any Channel | \pm (Offset) + 0.3 div \times volts/div setting + Offset Accuracy) | Auxiliary (TDS 540A & 544A only) | \pm mV) | | | | |
| | Trigger Source | Accuracy² | | | | | | | | | |
| Any Channel | \pm (Offset) + 0.3 div \times volts/div setting + Offset Accuracy) | | | | | | | | | | |
| Auxiliary (TDS 540A & 544A only) | \pm mV) | | | | | | | | | | |
| Input, Auxiliary Trigger | The input resistance is ≥ 1.5 k Ω ; the maximum safe input voltage is \pm AC). | | | | | | | | | | |
| Trigger Marker Position, Edge Triggering | <table border="0"> <tr> <td>Acquire Mode</td> <td>Trigger-Position Marker^{1,2}</td> </tr> <tr> <td>Sample, Hi-Res, Average</td> <td>\pm W1 + 1 ns)</td> </tr> <tr> <td>Peak Detect, Envelope</td> <td>\pm ns)</td> </tr> </table> | Acquire Mode | Trigger-Position Marker^{1,2} | Sample, Hi-Res, Average | \pm W1 + 1 ns) | Peak Detect, Envelope | \pm ns) | | | | |
| | Acquire Mode | Trigger-Position Marker^{1,2} | | | | | | | | | |
| Sample, Hi-Res, Average | \pm W1 + 1 ns) | | | | | | | | | | |
| Peak Detect, Envelope | \pm ns) | | | | | | | | | | |
| Holdoff, Variable, Main Trigger | Minimum: For any horizontal scale setting, the <i>minimum</i> holdoff is 10 times that setting, but is never less than 1 μ s or longer than 5 s. Maximum: For any horizontal scale setting, the <i>maximum</i> holdoff is at least 2 times the minimum holdoff for that setting, but is never more than 10 times the minimum holdoff for that setting. | | | | | | | | | | |
| Width, Minimum Pulse and Rearm, for Logic Triggering or Events Delay ³ | 5 ns | | | | | | | | | | |
| Lowest Frequency for Successful Operation of "Set Level to 50%" Function | 30 Hz | | | | | | | | | | |
| Sensitivity, Edge Trigger, Not DC Coupled ⁴ | <table border="0"> <tr> <td>Trigger Coupling</td> <td>Typical Signal Level for Stable Triggering</td> </tr> <tr> <td>AC</td> <td>Same as DC-coupled limits⁵ for frequencies above 60 Hz. Attenuates signals below 60 Hz.</td> </tr> <tr> <td>Noise Reject</td> <td>Three and one half times the DC-coupled limits.⁵</td> </tr> <tr> <td>High Frequency Reject</td> <td>One and one half times the DC-coupled limits⁵ from DC to 30 kHz. Attenuates signals above 30 kHz.</td> </tr> <tr> <td>Low Frequency Reject</td> <td>One and one half times the DC-coupled limits⁵ for frequencies above 80 kHz. Attenuates signals below 80 kHz.</td> </tr> </table> | Trigger Coupling | Typical Signal Level for Stable Triggering | AC | Same as DC-coupled limits ⁵ for frequencies above 60 Hz. Attenuates signals below 60 Hz. | Noise Reject | Three and one half times the DC-coupled limits. ⁵ | High Frequency Reject | One and one half times the DC-coupled limits ⁵ from DC to 30 kHz. Attenuates signals above 30 kHz. | Low Frequency Reject | One and one half times the DC-coupled limits ⁵ for frequencies above 80 kHz. Attenuates signals below 80 kHz. |
| | Trigger Coupling | Typical Signal Level for Stable Triggering | | | | | | | | | |
| | AC | Same as DC-coupled limits ⁵ for frequencies above 60 Hz. Attenuates signals below 60 Hz. | | | | | | | | | |
| | Noise Reject | Three and one half times the DC-coupled limits. ⁵ | | | | | | | | | |
| High Frequency Reject | One and one half times the DC-coupled limits ⁵ from DC to 30 kHz. Attenuates signals above 30 kHz. | | | | | | | | | | |
| Low Frequency Reject | One and one half times the DC-coupled limits ⁵ for frequencies above 80 kHz. Attenuates signals below 80 kHz. | | | | | | | | | | |
| Sensitivities, Logic-Type Trigger/Events Delay, DC Coupled ⁶ | 1.0 division, from DC to 100 MHz with a minimum slew rate of 25 divisions/ μ s at the trigger level or the threshold crossing. | | | | | | | | | | |
| Sensitivities, Pulse-Type Runt Trigger ⁶ | 1.0 division, from DC to 200 MHz with a minimum slew rate of 25 divisions/ μ s at the trigger level or the threshold crossing. | | | | | | | | | | |

Table 2-15: Typical Characteristics — Triggering System (Cont.)

| Name | Description |
|---|---|
| Sensitivities, Pulse-Type Trigger Width and Glitch ⁶ | 1.0 division with a minimum slew rate of 25 div/μs at the trigger level or the threshold crossing. For <5 nsec pulse width or rearm time, 2 divisions are required. |
| Sensitivities, Derating Aux Channel Trigger (TDS 520A & 524A) | All trigger sensitivity specifications are derated by 50% for AUX 1 and AUX2 inputs. |
| Sync Width (Option 05 Video Trigger) | min. 400 ns for HDTV signals |
| Sync Duty Cycle (Option 05 Video Trigger) | min. 50 to 1 |
| Hum Rejection (Option 05 Video Trigger) | NTSC and PAL: -20 dB without any trigger spec deterioration. Triggering will continue down to 0 dB with some performance deterioration. |

- 1 The trigger position errors are typically less than the values given here. These values are for triggering signals having a slew rate at the trigger point of 2 division/ns.
- 2 The waveform interval (WI) is the time between the samples in the waveform record. Also, see the footnote for the characteristics *Sample Rate Range and Equivalent Time or Interpolated Waveform Rates* in Table 2-3 on page 2-10.
- 3 The minimum pulse width and rearm width required for logic-type triggering or events delaying to occur.
- 4 The minimum sensitivity for obtaining a stable trigger. A stable trigger results in a uniform, regular display triggered on the selected slope. The trigger point must not switch between opposite slopes on the waveform, and the display must not “roll” across the screen on successive acquisitions. The TRIG'D LED stays constantly lighted when the SEC/DIV setting is 2 ms or faster but may flash when the SEC/DIV setting is 10 ms or slower.
- 5 See the characteristic *Sensitivity, Edge-Type Trigger, DC Coupled* in Table 2-10, which begins on page 2-17.
- 6 The minimum signal levels required for stable logic or pulse triggering of an acquisition or for stable counting of a DC-coupled events delay signal. Also, see the footnote for *Sensitivity, Edge-Type Trigger, DC Coupled* in this table. (Stable counting of events is counting that misses no events.)

Table 2-16: Typical Characteristics — Data Handling

| Name | Description |
|--|--|
| Time, Data-Retention, Nonvolatile Memory ^{1,2} | Battery life is ≥ 5 years |
| Floppy disk Standard on TDS 540A, 544A Option 1F on TDS 520A, 524A | 3.5 inch, 720 K or 1.44 Mbyte, DOS 3.3-or-later compatible |

- 1 The time that reference waveforms, stored setups, and calibration constants are retained when there is no power to the oscilloscope.
- 2 Data is maintained by small lithium-thionyl-chloride batteries internal to the memory ICs. The amount of lithium is so small in these ICs that they can typically be safely disposed of with ordinary garbage in a sanitary landfill.

Free Manuals Download Website

<http://myh66.com>

<http://usermanuals.us>

<http://www.somanuals.com>

<http://www.4manuals.cc>

<http://www.manual-lib.com>

<http://www.404manual.com>

<http://www.luxmanual.com>

<http://aubethermostatmanual.com>

Golf course search by state

<http://golfingnear.com>

Email search by domain

<http://emailbydomain.com>

Auto manuals search

<http://auto.somanuals.com>

TV manuals search

<http://tv.somanuals.com>