

# Telstra 7300 & 7300a

Digital DECT Cordless Telephone /Integrated Answering Machine

## User Guide



If you have any problems with your phone, refer to the Help section of this User Guide or call TechHelp on 1300 369 193.

**Telstra**

# Introduction to your Telstra 7300 & 7300a Digital DECT Cordless Telephone / Integrated Answering Machine

- Phonebook – lets you store up to 50 names and numbers for easy dialling.
- Calling Number Display - lets you see who's calling. Your phone stores details of the last 20 callers in a Calls list.
- Send & receive text messages
- Use the handsfree facility to talk to callers without holding the handset.
- Integrated Digital Answering Machine (7300a only)



As a Digitally Enhanced Cordless Telecommunications (DECT) product, your Telstra 7300/7300a series provides:

- Digital clarity
- Digital range
- Digital security

## IMPORTANT

**This equipment is not designed for making emergency telephone calls when the power fails. Alternative arrangements should be made to access emergency services.**

This User Guide provides you with all the information you need to get the most from your phone.

Before you make your first call you will need to set up your phone. Follow the simple instructions in “Getting Started”, on the next few pages.

Some Telstra services such as SMS, Messagebank® and Calling Number Display may attract feature and usage charges. Please visit [Telstra.com](http://Telstra.com) for details.

## Need help?

If you have any problems setting up or using your Telstra 7300/7300a, contact TechHelp on 1300 369 193 or email: [tcpsupport@ingrammicro.com.au](mailto:tcpsupport@ingrammicro.com.au)

Alternatively, you may find the answer in the ‘Help’ section at the back of this guide.

## Hearing aid?

Please note that the Telstra 7300 and 7300a works by sending radio signals between the base and handset. These signals may interfere with some hearing aids, causing a humming noise.

## Got everything?

- Telstra 7300 or 7300a handset
- Telstra 7300 or 7300a base
- 2 x NiMH AAA rechargeable batteries
- Mains power adaptor
- Telephone line cord
- Wall mounting bracket

**If you have purchased a Telstra 7300 or 7300a multi handset pack you will also have the following for each additional handset:**

- Telstra 7300 or 7300a handset
- Telstra 7300 or 7300a charger
- 2 x AAA NiMH rechargeable batteries
- Mains power adaptor (for the charger)

## In this guide

<b>Getting started</b>	<b>8</b>	<b>Using the phone</b>	<b>24</b>
Location	8	Make a call	24
Setting up	8	Preparatory dialling	24
Set the day and time	11	End a call	24
To change the time or date format	11	Receiving calls	24
Setting up the charger	12	Earpiece volume	24
Wall mounting your 7300/7300a	13	Handsfree	25
		Make a call in handsfree	25
<b>Getting to know your phone</b>	<b>16</b>	Answer a call in handsfree	26
Handset buttons	16	Switch to handsfree during a call	26
Handset display icons	18	Mute	26
Base and charger	19	Redial	27
Answering machine	20	To copy a redial number to the Phonebook	27
Navigating the menus	22	To delete a number from the redial list	28
Handset menu map	23	To delete the entire redial list	28
Menu navigation	23	Keypad lock	28
		Ringer volume on/off	29
		Page the handset(s)	29
		Making internal calls	29
		Transferring calls	30
		3-Way conference calls	30
		Switching a handset off	31
		Receiving internal calls	31

## In this guide

<b>Phonebook</b>	<b>32</b>	<b>Handset settings</b>	<b>42</b>
Store a number	32	Ringer melody	42
Entering names	32	Ringer volume	42
Dial/view a number	33	Handset tones on/off	43
Edit a Phonebook entry	34	Handset name	43
Delete a Phonebook entry	34	Registering handsets	44
Delete Phonebook	35	De-registering a handset	44
		Restore default settings	45
		Language	45
<b>Text messages (SMS)</b>	<b>36</b>		
Subscribe to the text messaging service	36	<b>Base settings</b>	<b>46</b>
Calling Number Display and text messaging	36	Ringer volume	46
Using text messaging	36	Ringer melody	46
Send/save text messages	37	Change PIN code	47
Receiving and reading text messages	38	Restore default settings	48
Reply to a text message	38	PABX access	48
Delete a text message	38		
Delete a list	39		
Call the sender's phone number	39		
Send/edit/delete text messages in the outbox	39		
Message alert beep on/off	40		
SMS Service Centre numbers	41		
Adding or changing SMS Service Centre numbers	41		
Select a Send Service Centre number	41		

## In this guide

---

<b>Calling Number Display</b>	<b>49</b>	<b>Using the answering machine (7300a only)</b>	<b>56</b>
Caller information not available	49	Date and time	56
Calls list	49	Operating the answering machine from the base	57
View/dial a number	50	Switch on/off	57
To copy a Calls list number to the Phonebook	50	Playing messages	57
Delete a number	51	Adjust volume	57
Delete the entire Calls list	51	Operating the answering machine from the handset	57
<b>Telstra Network Features</b>	<b>52</b>	Switch on/off	58
To access a Network Feature	52	Outgoing messages	58
TecHelp line	52	Answer & Record	58
MessageBank®	53	Answer only	58
To retrieve a message from your message service	53	Record your own outgoing message	59
Flashing Message Indicator	53	Play outgoing message	59
Call Waiting	54	Reinstate pre-recorded outgoing message	60
Answer a Call Waiting call	54	Set answer mode	60
Add/edit a service	54	Answer delay	61
Delete a service	55	Set answer delay	61
		Playing messages	61
		Delete all old messages	62
		Call screening	62
		Memory full	63
		Remote access	63
		Security PIN	63

## In this guide

---

Set/change remote access security PIN	63
Operating your answering machine from another phone	64
Switch answering machine on remotely	65
<b>Help</b>	<b>66</b>
<b>General information</b>	<b>70</b>
Safety	70
Cleaning	70
Environmental	71
PABX compatibility	71
Recall	71
Technical information	71
<b>Customer service &amp; Product warranty</b>	<b>72</b>
<b>Wall mounting template</b>	<b>75</b>

# Getting started

## Location

You need to place your Telstra 7300/7300a base within 2 metres of a mains power and telephone socket so that the cables will reach.

Make sure it is at least 1 metre away from other electrical appliances to avoid interference. Your Telstra 7300/7300a works by sending radio signals between the handset and base. The strength of the signal depends on where you site the base. Putting it as high as possible helps ensure the best signal.

## Setting up

1. Plug the mains power cable into the power socket on the back of the base. Plug the other end into the mains socket and switch on.

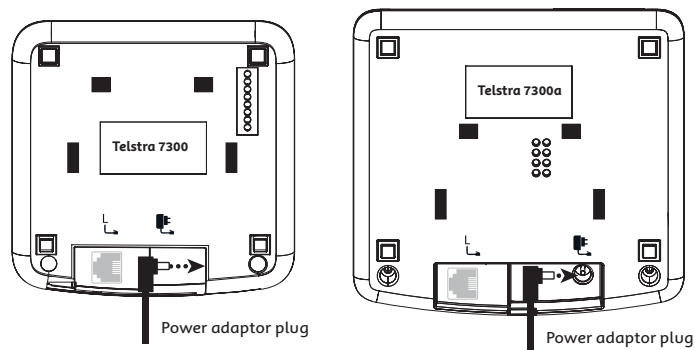

**WARNING:** Do not place your Telstra 7300/7300a in the bathroom or other humid areas.

## Getting started

2. Remove the battery compartment cover and insert the 2 x AAA NiMH batteries supplied into the handset, ensuring the + and - ends of the battery match up with the markings inside the battery compartment. Slide the battery cover compartment into place. The battery cover must be in place at all times when the handset is placed in the cradle.
3. Place the handset on the base to charge the batteries for at least **16 hours**.  
The main handset is pre-registered to the base as -1- (Telstra 1). This is shown on the display. When the handset is fully charged the display shows the  symbol.
4. After **16 hours**, connect the telephone line cord to the base and plug the other end into the wall socket.

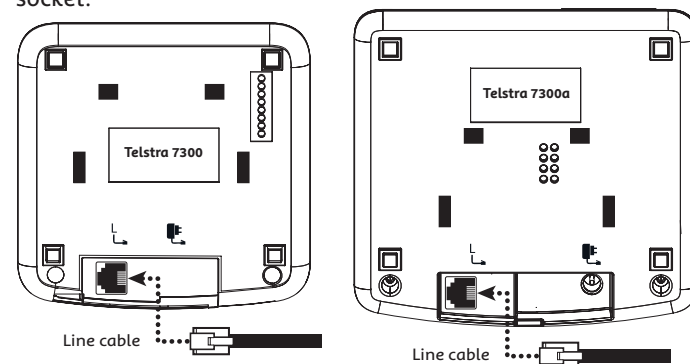



## Handset range

The Telstra 7300/7300a works by sending radio signals between the handset and the base. Any source of interference between the handset and base may impact on the range you obtain from your cordless telephone. In ideal conditions your Telstra 7300/7300a has a range of up to 300 metres outdoors when there is a clear line of sight between the base and the handset. With the base indoors and handset either indoors or outdoors, the range will normally be up to 50 metres. Any obstruction between the base and handset will reduce the range significantly. Thick stone walls can severely affect the range.

## Getting started

### Signal strength

The  SIGNAL symbol on your handset screen indicates when you are in range.

When you are out of range, the  symbol flashes, and the screen displays Searching. You should move closer to the base if this happens to ensure the full functionality of your phone.

### IMPORTANT

Do not connect the telephone line until at least one of the handsets is fully charged.  
The base station must be plugged into the mains power at all times.

### Talk/Standby time

Under ideal conditions, fully charged handset batteries should give approximately 10 hours talk time or 100 hours standby time on a single charge.

### Battery low warning

If the  symbol is flashing, you will need to recharge your handset before using it.

### Battery performance



To keep your batteries in the best condition, leave the handset off the base for a few hours at a time (after the initial 16 hour charge). New NiMH batteries do not reach full capacity until they have been in normal use for several days. Running the batteries right down at least once a week will help them last as long as possible. The charge capacity of rechargeable batteries will reduce with time as they wear out, so reducing the talk/standby time of the handset. Eventually they will need to be replaced. New batteries can be purchased from your local electrical retailer or from TechHelp on 1300 369 193. Batteries and handset may become warm during charging. This is normal.









### IMPORTANT

Only use the power supply and telephone line cord supplied with your Telstra 7300/7300a otherwise the telephone may not work.









## Getting started

### Set the day and time

If you have more than one handset registered to your base, you only need to set the date and time on one handset and the other handsets will be automatically updated once you make a call, or press the  or  keys.

1. Press  to open the main menu.
2. Press  or  until the display shows Date/Time and press .
3. Set date/time is displayed, press .
4. The current year setting is displayed; enter the last 2 digits of the year (e.g. press 0 then 6 for 2006) and press .
5. Enter 2 digits for the date and 2 for the month (e.g. for 5th August, press 0 5 0 8 press .
6. Enter 2 digits for the hour and 2 for the minute (e.g. for 10.54am, press 1 0 5 4 and press .
7. Press and hold  to return to standby.

### To change the time or date format

1. Press  to open the main menu.
2. Press  or  until the display shows Date/Time and press .
3. Press  or  until Time format or Date format is displayed, as required.
4. Press  and choose between 24hr/12hr or dd.mm/mm.dd as appropriate.
5. Press  to confirm and press and hold  to return to standby.

**Your Telstra 7300/7300a is now ready for use.**

**Under no circumstances use non rechargeable batteries. Only use NiMH rechargeable batteries with a capacity of 600mAh or higher. Using inappropriate batteries will invalidate your guarantee and may damage the telephone.**

### Telstra 7300/7300a multi handset pack only

#### Location

You need to place your Telstra 7300/7300a charger close enough to a mains power socket so that the cable will reach.

#### Setting up the charger

1. Plug the power adaptor cable into the underside of the charger, plug the other end into the mains wall socket and switch the power on.

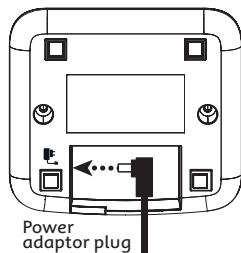

2. Remove the battery compartment cover and insert the 2 x AAA NiMH batteries supplied into the handset, ensuring the + and - ends of the battery match up with the markings inside the battery compartment. Slide the battery cover compartment into place. The battery cover must be in place at all times when the handset is placed in the cradle.
3. Place the handset on the base to charge the batteries for at least **16 hours**. The extension handset is pre-registered to the base as -2- (Telstra 2). This is shown on the display.

When the handset is fully charged the display shows the  symbol.

4. After 16 hours, connect the phone line cord to the main base and plug the other end into the wall socket.

**Your Telstra 7300/7300a multi handset pack is now ready for use.**

### Wall mounting your 7300/7300a

The Telstra 7300/7300a can be wall mounted to a standard Telstra wall mount plate. To wall mount the phone proceed as follows:

1. Place the wall mount bracket over the two retaining screws of your standard Telstra wall mount plate.
2. Slide the bracket downward into position.

*Alternatively to wall mount the phone:*

1. Using the template on page 75, drill two 3mm holes. Insert plastic plugs (optional) and partially screw two screws into place. Ensure there is sufficient space allowed for mounting the phone before drilling holes.

**Caution: Ensure there is no risk of damaging any pipes or wiring that may be behind the wall.**

2. Place the wall mount bracket over the two screws.
  3. Slide the bracket downwards into position.
- Tighten the two screws to prevent the wall bracket from moving.

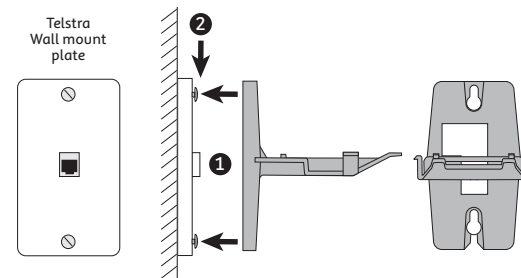

## Getting started

4. Thread the power cord from the power supply through the L-shaped opening of the wall bracket and out through the bottom of the bracket. Now thread the line cord from the phone socket through the square opening of the bracket. Plug the power cord into the power socket and the line cord into the line socket of the telephone.

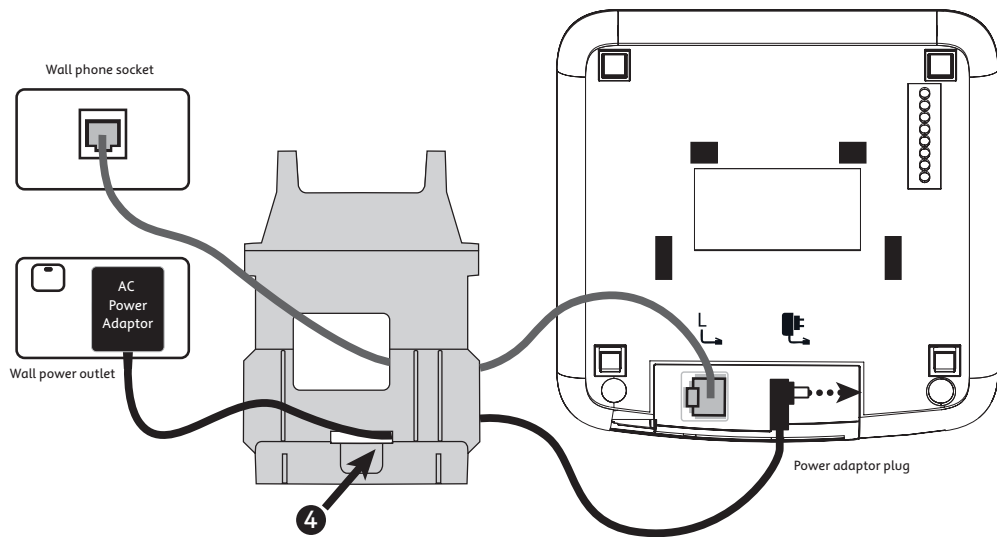

## Getting started

5. Align the holes on the bottom of the telephone base with the lugs on the front of the wall bracket. Slide the telephone base downward on the bracket until you hear it click into place.

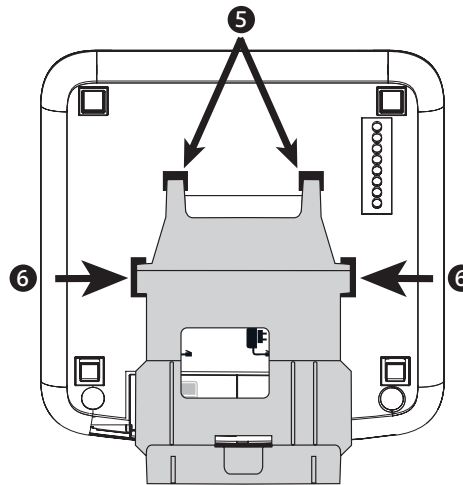

### To remove the 7300/7300a from the wall mounting bracket

6. Gently press the release tabs and lift the base up and forward to remove the base from the bracket.
7. Disconnect the power and line cords.

### Helpline

If you are having any difficulties setting up or using your Telstra 7300/7300a, please call the TechHelp on 1300 369 193 or email: [tcpsupport@ingrammicro.com.au](mailto:tcpsupport@ingrammicro.com.au)



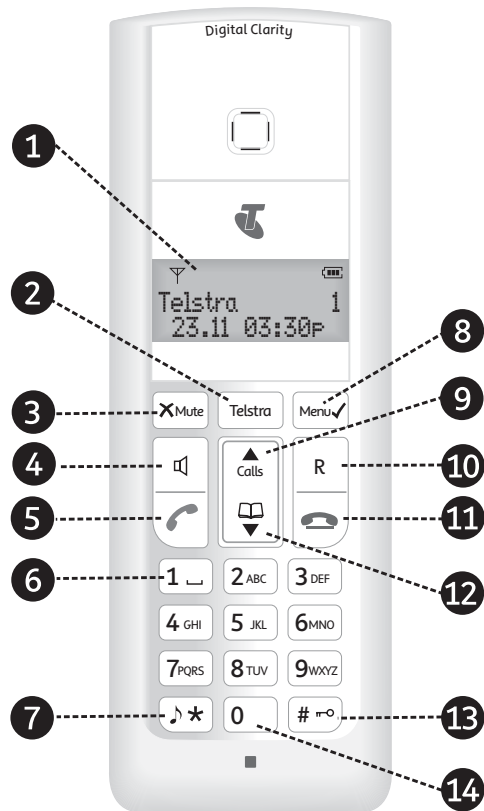

## Handset buttons

### 1. Display

With orange backlight.

### 2. Telstra button

Press to access the Telstra Calling features services list, page 52.

### 3. X/Mute

Press to go back to previous display.

Press and *hold* to return to standby.

Used to delete digits and to switch Mute on and off, page 26.

### 4. Handsfree

Press to activate handsfree (loudspeaker) mode, page 25.

### 5. Talk

Press to make and receive phone calls, page 24.

### 6. 1 button

Inserts a space when typing text in PhoneBook entries and Text Messaging.

## Getting to know your phone

### 7. \* button

Press and *hold* to switch the ringer on/off, page 43.

### 8. Menu/✓

Used to access the main menu, select sub-menus and confirm changes.

### 9. Up/Calls list

From standby, press to display the Calls list, page 49. Use to scroll up through a menu or list.

During a call, press to adjust the earpiece volume, page 24.

### 10. R (Recall)

Used when connected to a PABX, page 71 and with some Telstra Calling Features, page 52.

### 11. End call

Press to end the call in progress.

Use to return to standby.

### 12. Down/Phonebook

Press to access the Phonebook, page 32.

Use to scroll down through a menu or list.

During a call, press to adjust the earpiece volume, page 24.

### 13. #/Keypad lock

Press and *hold* to lock/unlock the keypad, page 28.

### 14. 0 button

Press and *hold* to insert a pause in a number. page 32.

### Handset display icons

These are the symbols you will see on your handset's display.



**UP/DOWN**  
When scrolling through the menu and Directory

**ANTENNA**  
Steady when in range.  
Flashing when out of range.

**HANDSET**  
Handset in use Incoming call

**HANDSFREE**  
Handsfree on

**CROSSED BELL**  
Ring volume off

**TEXT MESSAGE (SMS)**  
Accessing text messaging

**MessageBank® or Telstra Home Messages 101®**  
Indicates new message on MessageBank® or Telstra Home Messages 101®

**MUTE**  
Mute on

**KEY**  
Keypad lock on

**BATTERY**  
Battery empty  
Battery low  
Battery half full  
Battery full

### 7300 Base unit

#### 1. Page button

Press to page the handset(s) page 29.

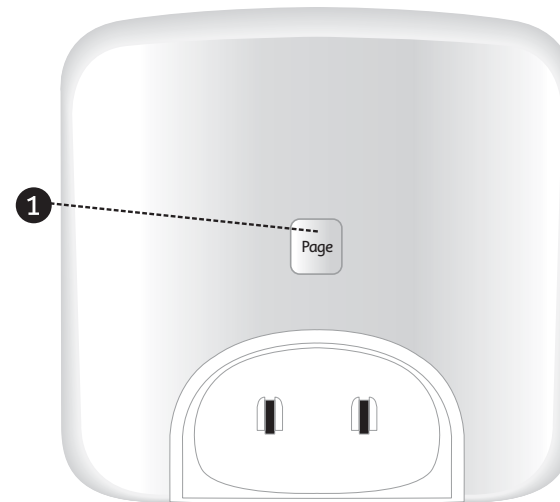

### Charger unit

(For multiple pack users only)



7300a  
Answering Machine -  
Front View

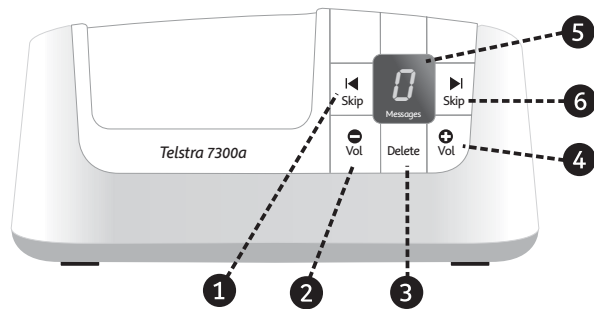

7300a  
Answering Machine -  
Top View

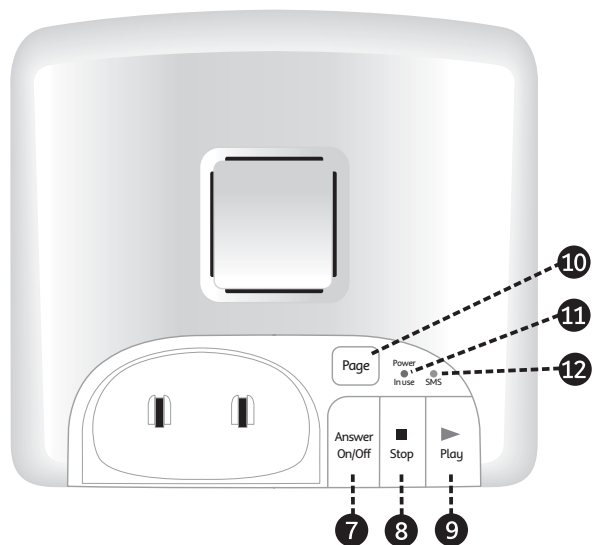

## 7300a Base unit

### 1 Skip < button

To skip back when listening to your messages, page 57.

### 2. Vol – button

To decrease the speaker volume, page 57.

### 3. Delete button

To delete messages received, page 62.

### 4. Vol + button

To increase the speaker volume, page 57.

### 5. Message indicator

Displays the number of message(s) in the answering machine.

### 6. Skip > button

To skip forward when listening to your messages, page 57.

### 7. Answer On/off button

To turn your answering machine on or off, page 57.

### 8. Stop button

Stops messages being played, page 57.

### 9. Play/Pause button

To playback or pause messages, page 57.

### 10. Page button

Press to page handset(s), page 29.

### 11. Power/In use indicator

On = Power on  
Flashes when making or receiving a call (approx once every second)



### 12. Text message (SMS) indicator

Flashes when a text (SMS) has been received (approx once every second).









## Navigating the menus

Your Telstra 7300/7300a handset features an easy to use menu system. Have a look at the menu map on the next page.

### When the handset is switched on and in standby:

1. Press  to open the main menu and select the function you want by pressing the  or  button.

For example, to change the ringer melody:

1. Press  to open the main menu.
2. Press  or  until the display shows Setup h/set and press .
3. Ring melody is displayed, press  to select. The current melody is played for 5 seconds.
4. Press  or  to select your preferred melody.
5. Press  to save. You hear a confirmation tone and Saved is displayed.
6. Press and hold  to return to standby.



## Handset menu map

### SMS messages

- Write message
- Inbox
- Outbox
- SMS settings

### Directory

- New
- Details
- Edit
- Delete entry
- Delete list

### Answering Machine

- Play message
- Del all old
- Security PIN
- Ans settings

### Redial

- Details
- Save number
- Delete entry
- Delete list

### Calls List

- Details
- Save number
- Delete entry
- Delete list

### Internal

### Switch off

### Setup h/set

- Ring melody
- Ring volume
- Warning tones
- Handset name
- Language
- Reset

### Setup base



- Ring melody
- Ring volume
- Change PIN
- Flash time
- Access code
- VMWI
- Reset

### Date/Time

- Set date/time
- Time format
- Date format

## Menu navigation

Press  to open the main menu.

Press  or  to scroll through the menu options.

Press  to select an option.

Press  to go back to the previous display screen.

Press and hold  to return to the standby display screen.

# Using the phone



## Make a call

1. Press .

Enter the telephone number and the number is dialled.

## Preparatory dialling

Use preparatory dialling to see and check the number on the display before you dial out.

1. Enter the number first then press  or  to dial.

## End a call

1. Press  or place the handset back on the base.

## Receiving calls

When you receive an incoming call, the telephone will ring and the  PHONE icon will flash.

1. If the handset is not in the base/charger, press  or  to answer the call.

Or

If the handset is on the base/charger, lift the handset to answer the call.

### Call timer

Your handset automatically displays the duration of every external call. The call time will remain on the display until 2 seconds after the call has ended.

## Using the phone

If you have subscribed to Telstra's Calling Number Display service, your caller's number will also be shown. If the number is private (eg blocked calls) the display will show **Withheld**. If an exact number match is found in the Phonebook, the name will be displayed instead of the number. See page 49 for more information.

### Internal calls

When you receive an internal call, the calling handset number will be shown on the handset display.

## Earpiece volume

During a call:

### To increase the volume

Press .

### To decrease the volume



Press .

The earpiece volume can only be changed when you are on a call.

## Handsfree

Handsfree lets you talk to your caller without holding the handset. It also enables other people in the room to listen to your conversation over the loudspeaker.

## Make a call in handsfree

1. Dial the number then press .
2. Press  to end the call.



### Answer a call in handsfree

When the phone rings:

1. Press  and the call is transferred to the loudspeaker.

### Switch to handsfree during a call

During a call:

1. Press . The call is transferred to the loudspeaker.
2. Press  to toggle between Handsfree and the handset.
3. Press  to end the call.

### Mute

During a call, you can talk to someone nearby without your caller hearing.

1. Press . The display shows the  symbol and your caller cannot hear you.
2. Press  again to return to your caller.









#### Range Indicator

The  icon on the display indicates when you are in range of the base. If **Searching** is displayed, you are out of range and will need to move closer to the base.













### Redial

Your Telstra 7300/7300a stores the details of the last 10 calls made into a redial list. Stored redial numbers can be up to 20 digits long.













If a redial number is stored in the Phonebook, the caller's name will be displayed instead of the number. If there are no redial numbers stored, **Empty** will be displayed. If you dial the same number on more than one occasion, only the most recent call details will be stored, any previous occurrence will be deleted.

1. Press , to open the main menu.
2. Press  or  until the display shows **Redial**, press  to display the redial list.
3. Press  or  to select any of the last 10 numbers called.
4. Press  or  to dial the number displayed.











### To copy a redial number to the Phonebook

1. Press , to open the main menu.
2. Press  or  until the display shows **Redial**, press  to display the redial list.
3. Press  or  to display the number you want and press  to select.
4. Press  or  to display **Save number** and press  to select.
5. **Name** is displayed. Enter a name using the keypad and press  to confirm.
6. **Saved** is displayed. Press and hold  to return to standby mode

### To delete a number from the redial list

1. Press  to open the main menu.
2. Press  or  until the display shows Redial, press  to display the redial list.
3. Press  or  to display the number you want and press  to select.
4. Press  or  to display Delete entry and press  to select.
5. Delete ? is displayed, press  again to confirm.
6. Deleted is displayed. Press and hold  to return to standby mode.

### To delete the entire redial list

1. Press  to open the main menu.
2. Press  or  until the display shows Redial, press  to display the redial list.
3. With any of the redial numbers displayed, press .
4. Press  or  to display Delete list and press  to select.
5. Delete list ? is displayed, press  again to confirm.
6. Deleted is displayed. Press  to return to standby mode.



### Keypad lock

You can lock the keypad to prevent accidentally dialling numbers while carrying the handset around.

When the keypad is locked incoming calls can still be answered. Once the call has ended, the keypad lock is reactivated.

#### IMPORTANT

Emergency calls to 000 can be made when the keypad lock is on.

1. Press and hold  for 1.5 seconds until the  icon is displayed.
2. To unlock the keypad, press and hold  again.



### Ringer volume on/off

1. Press and hold  for 1.5 seconds to switch the ringer on or off.
- If you switch the ringer off, the  icon will be displayed.

Stopping the ring at a handset stops the ring at that handset only.





### Page the handset(s)

You can alert handset users that they are wanted or locate a missing handset.

1. Press  on the base. The handset(s) ring.
2. Press  on the base again or press  on the handset to stop the handset ring.





### Making internal calls

If you purchased a Telstra 7300/7300a multi handset pack, you can make internal calls between handsets.

1. Press  then  or  until the display shows Internal.
2. Press  and enter the number of the handset you want to call. The other handset will ring and display your handset number to let the handset user know who is calling. When the other handset answers hold your conversation as normal.
3. Press  to end the call.

### Transferring calls









If using a Telstra 7300/7300a multi handset pack, you can transfer an external call to another handset.

1. During an external call, press .
2. Press  or  until the display shows Internal and press  to confirm.
3. Enter the number of the handset you want to call, the external caller will be put on hold. The other handset will ring and display your handset number to let the handset user know who is calling.
4. When the other handset answers, press  to transfer the call.

If the other handset does not answer, you can be connected with your external caller by pressing  once.

### 3-Way conference calls





If using a Telstra 7300/7300a multi handset pack, you can hold a 3-way conference call with an external caller and another internal handset.

1. During an external call, press  then  or  until the display shows Internal. Press  to confirm.
2. Enter the number of the other handset you wish to join the call. The other handset will ring.
3. The other handset answers the call by pressing .
4. Press , the display shows Conference. Press  to confirm. The external call and the two internal handsets are all connected to the conference.
5. Any caller can leave the conference by pressing .

To put an external call on hold during a conference, press  End conf will be displayed. Press  to confirm.

To take the external caller off hold, press  Conference will be displayed, press  to confirm.

### Switching a handset off

1. Press  then  or  until the display shows Switch off.
2. Press  and the display shows Switch off?, pressing  again will confirm and the handset will turn off.

To turn your handset back on just press the  button

### Receiving internal calls

When you receive an internal call, the calling handset number will be shown on the handset display.







1. Press  or  to answer the call.



# Phonebook

You can store up to 50 numbers in the Phonebook of each of your Telstra 7300/7300a handsets for quick and easy dialling. Numbers can be up to 20 digits long. Phonebook entries are stored alphabetically.

## Store a number

1. Press  to open the Phonebook. The first entry is displayed.
2. Press  **NEW** is displayed, press  again to select.
3. **NUMBER** is displayed; enter the number for the entry using the keypad and press  to store.
4. **NAME** is displayed; enter a name for the entry using the keypad and press  to save.
5. **SAVED** is displayed. Press and hold  to return to standby mode.



If there are no stored entries, **EMPTY** will be displayed.

If you try to store a new entry and the Phonebook is full, you will hear an error tone and **FULL** will be displayed.

Press  to delete an incorrect digit.

## Entering names

Use the keypad to enter the letters shown on the buttons, e.g. to store TOM:

1. Press  *once* to enter T.
2. Press  *three* times to enter O.
3. Press  *once* to enter M.

## Phonebook

### Writing tips

If you make a mistake, press  to delete the last character or digit.











Press  repeatedly to enter the following: SPACE 1 € £ \$ % & < > □

Press  repeatedly to enter the following symbols: . , ? ! 0 + - : ' "

Press  repeatedly to enter the following symbols: # \* @ \ / \_ ( ) = \$

Press  to toggle between lower and upper case. If the next letter is on the same button that you have just pressed, wait until the cursor moves to the right before trying to enter it.



### Dial/view a number

1. Press  to open the Phonebook. The first entry is displayed.
2. Press  or  to scroll through the Phonebook to the entry you want.  
Or, search alphabetically, using the keypad to enter the first letter of the name you want, then scroll to the exact entry using the  or  buttons.
3. To dial press  or to view press , then  to **Details** and  to confirm.
4. The selected entry will be displayed ready to be dialled out.  
Press  or  to dial.







### Insert a pause in a number



You may need to do this if you are connected to a PABX. When entering a number, usually after entering the PABX access code (e.g. 9) press and hold  until **F** appears in the display.



### Searching for a name

Example: To search for Oliver, press  three times to display the first entry beginning with O, then use  or  to scroll to Oliver.

### Edit a Phonebook entry









1. Press  to open the Phonebook. The first entry is displayed.
2. Press  or  to scroll through the Phonebook to the entry you want.
3. Press  then  or  to display Edit and press  again to select.
4. The stored number is displayed followed by a flashing cursor.

Edit the number using  to delete incorrect digits and enter new ones using the keypad, then press .

5. The name is displayed followed by a flashing cursor. Edit the name using  to delete incorrect characters and enter new ones using the keypad, then press  to save.
6. Saved is displayed. Press and hold  to return to standby mode.

See page 32 for help with entering names.

### Delete a Phonebook entry

1. Press  to open the Phonebook. The first entry is displayed.
2. Press  or  to scroll through the Phonebook to the entry you want.
3. Press  then  or  to display Delete entry and press  to select.
4. Delete? is displayed. Press  to confirm.
5. Deleted is displayed. Press and hold  to return to standby mode.

If you have purchased a Telstra 7300/7300a multiple pack, entries are only deleted on the handset you are using.

### Delete Phonebook

1. Press  to open the Phonebook. The first entry is displayed.
2. Press  then  or  to display Delete list and press  to select.
3. Delete list? is displayed. Press  to confirm.
4. Deleted is displayed. Press and hold  to return to standby mode.

## Text Messaging (SMS)

Your Telstra 7300/7300a can send and receive text messages (SMS – Short Messaging Service). With text messaging you can send & receive text messages up to 160 characters long.

### Subscribe to the text messaging service

When you send your first text message from your Telstra 7300/7300a you will automatically be registered for the service.

On receipt of your first text message through the service, the system will send you a welcome text message back to confirm your registration.

Note: For information on how to use the Telstra text messaging service, call 0198 339 999 and follow the voice prompts.

### Calling Number Display and text messaging

In accordance with worldwide standards for text messaging, all messages including reply messages will display the telephone number of the sender.

If you have a Silent Line or have blocked Calling Number Display and attempt to send text messages, your text message will not get through. Customers can call Telstra's text messaging service on 0198 339 999 and use the prompts to turn off Silent Line and Calling Number Display blocking for text messages only.





### Using text messaging

If you have more than one handset, all handsets use the same inbox and outbox.

Your Telstra 7300/7300a can hold approximately ten messages, in the Inbox, Outbox or a combination of both. When full the display will show SMS mem. full. No more messages can be received until you delete old messages, see Delete a text message or Delete a list (page 38).





## Text messaging (SMS)

### Send/save text messages

1. Press , SMS messages will be displayed.
2. Press , Write message is displayed.
3. Press , the display shows Enter message. Enter your message using the keypad.
4. When you have finished, press . The display shows Number :
5. Enter the phone number you want to send the message to.

#### Alternatively:

Press , to locate a number in the Phonebook, Calls list or redial list.

6. When you have entered the number, press  and then press  or  to scroll to Send Message to send or Save message to save the message.
7. Press , the display will show Send Message followed by Msg transfer or Saved as appropriate.

#### Entering text

Use the keypad to enter characters.



Press the button repeatedly to move through the characters shown.

For example, press  twice to enter b.

Press  once to enter t.

If the next character you want to enter is on the same button, wait for the cursor to move right.

#### Writing tips

If you make a mistake, use  or  to move left and right through the message and press  to delete characters.









Press  to enter a space.

Press  to switch between upper and lower case letters and numbers.

Use 0, 1 and # to enter other punctuation characters.

### Receiving and reading text messages

When you receive new text messages, you will hear the message alert beep and the display will show New SMS msg.











1. Press , SMS messages will be displayed.
2. Press , then scroll  to Inbox and press .
3. Scroll  or  to the message you want to read first and press .
4. Press  to return to the inbox.

### Reply to a text message









1. When reading a text message, press . Reply is highlighted. Press .
2. To use the sender's message in your reply, press . Or, press  to start with a blank message.
3. Enter your message and press  the sender's number will be displayed.
4. Press  to accept then scroll  or  to Send Message and press .

If you include the sender's message, the text will be inserted at the beginning of your message. You can then edit it as normal.









### Delete a text message

1. Press , SMS messages will be displayed, press .
2. Scroll  to Inbox or Outbox and press .
3. Scroll  or  to the message you want to delete and press .
4. Scroll  to Delete entry and press .
5. Press  to confirm or  to cancel.











### Delete a list

1. Press , SMS messages will be displayed, press .
2. Scroll  to Inbox or Outbox and press .
3. Press  and scroll  to Delete list, press .
4. Press  to confirm or  to cancel.

### Call the sender's phone number

1. Press , SMS messages will be displayed, press .
2. Scroll  to Inbox and press .
3. Scroll  or  to the message you want and press .
4. Scroll  to Call number and press .
5. The number is displayed and dialled.

### Send/edit/delete text messages in the outbox

1. Press , SMS messages will be displayed, press .
2. Scroll  to Outbox and press .
3. Scroll  or  to the message you want and press .
4. Press  to read the message or press  or  to choose from: Send message, Edit, Delete Entry or Delete List.

Messages in the outbox are labelled according to their status. For example, Saved indicates a saved message or Failed which indicates a message that failed to be sent.

### Send Message

Press to view the phone number, then either , or to send or to edit.

### Edit

Press to edit the message and phone number or to send the message.

### Delete entry

Press , then to confirm or to cancel.

### Delete list

Press , then to confirm or to cancel.

Press to exit the menu and return to standby at any time

### Message alert beep on/off

When you have new messages, your handset will beep. The default setting is on. You can switch the setting off.

1. Press , SMS messages will be displayed, press .
2. Scroll to SMS settings and press .
3. Scroll to New msg alert and press .
4. Scroll or to select On or Off. Press .
5. Press and hold to return to standby mode.

### SMS Service Centre numbers

To send and receive SMS text messages you need the phone number of the Telstra SMS Service Centre. If you accidentally delete the Send or Receive SMS Service Centre numbers you will need to re-enter them in order for your SMS Service to work.

**Telstra's Send SMS Service number is: 019833910**

**Telstra's Receive SMS Service number is: 019833910**

### Adding or changing SMS Service Centre numbers

Your Telstra 7300/7300a is pre-set to send using Service Centre 1 and receive using Service Centre 2.

1. Press , SMS messages will be displayed, press .
2. Scroll to SMS settings and press .
3. Svc centres is highlighted. Press .
4. Scroll or to select the centre you want and press .
5. Enter the service centre number you want and press .
6. Press and hold to return to standby mode.

### Select a Send Service Centre number









If you have entered additional Service Centre numbers, you can choose which send Service centre you want to use. Your 7300/7300a is pre-set to send using Service Centre 1 and receive using Service Centre 2.

1. Press , SMS messages will be displayed, press .
2. Scroll to SMS settings and press .
3. Scroll to Send service. Press .
4. Scroll or to the centre you want and press .
5. Press and hold to return to standby mode.

# Handset settings











## Ringer melody

There are 6 different ringer melodies to choose from.

1. Press  to open the main menu.
2. Press  or  until the display shows Setup h/set and press .
3. Ringer melody is displayed, press  to select. The current melody is played for 5 seconds.
4. Press  or  to select your preferred melody.
5. Press  to save. You hear a confirmation tone and Saved is displayed.
6. Press and hold  to return to standby.

## Ringer volume















There are 5 different ringer volume levels to choose from.

1. Press  to open the main menu.
2. Press  or  until the display shows Setup h/set and press .
3. Press  or  until Ringer volume is displayed, press  to select. The selected ringer melody is played at the current volume for 5 seconds.
4. Press  or  to select your preferred volume.
5. Press  to save. You hear a confirmation tone and Saved is displayed.
6. Press and hold  to return to standby.

## Handset settings









### Handset tones on/off

Your Telstra 7300/7300a has a series of tones designed to alert you to certain situations. A tone will sound: when the battery is low; when you move out of range of the base and there is no coverage; to confirm each button press (key beeps). You can switch the handset tones on or off.

1. Press  to open the main menu.
2. Press  or  until the display shows Setup h/set and press .
3. Press  or  until Warning Tones is displayed, press  to select.
4. Press  or  to select the tone you want and press  to select.
5. Press  or  to display either On or Off and press  to confirm.
6. You hear a confirmation tone and Saved is displayed.
7. Press and hold  to return to standby.

### Handset name

You can give each handset a name up to a maximum of 11 characters, for example "Kitchen". It will still display its number.

1. Press  to open the main menu.
2. Press  or  until the display shows Setup h/set and press .
3. Press  or  until Handset name is displayed, press  to select.
4. Press  to delete characters and use the keypad to enter the name you want, then press  to confirm.

### Registering handsets

If you have purchased a Telstra 7300/7300a multi handset pack, the handsets in these packs are already pre-registered to the main base.

If however you de-register a handset and need to re-register it back to a Telstra 7300/7300a base at any stage:

1. Press and enter using the keypad.
2. Registration is displayed, press .
3. Register is displayed, press and Enter PIN will be displayed.
4. Enter the base PIN (original setting 0000) and press .
5. The handset will display Searching, press and hold the button on the base until you receive a confirmation tone.
6. The handset will temporarily display Registered then will display Handset and will be automatically assigned the next handset number.

Your Telstra 7300/7300a is not GAP compatible and registration is therefore generally limited to other Telstra 7300/7300a handsets. The Registration and De-registration menu's are therefore "hidden" and can only be accessed after entering the code

### De-registering a handset

You can de-register any handset from a base using any of the handsets that are registered to it.

1. Press and enter using the keypad.
2. Registration is displayed, press .
3. Press or until Deregister is displayed, press and Enter PIN will be displayed.
4. Enter the base PIN (original setting 0000) and press .

5. Use or to display the handset number you wish to de-register, then press .
6. Deregister? will be displayed, press again to confirm.

### Restore default settings

You can reset your Telstra 7300/7300a handset to its default (original) settings.

1. Press to open the main menu.
2. Press or until the display shows Setup handset and press .
3. Press or until Reset is displayed and press .
4. Reset? is displayed. Press . Saved is displayed.











### Language

You can change the default language used by your Telstra 7300/7300a from English to German or Turkish.

1. Press to open the main menu.
2. Press or until the display shows Setup handset and press .
3. Press or until Language is displayed and press .
4. Scroll or to choose the default language and press to confirm.
5. Press and hold to return to standby.









## Base settings

### Ringer volume

1. Press , scroll  or  to Setup base and press .
2. Scroll  to Ringer volume and press .
3. Scroll  or  to the volume level then press .
4. Press and hold  to return to standby.

There are 5 volume levels.

### Ringer melody

1. Press , scroll  or  to Setup base and press .
2. Ringer melody is highlighted, press .
3. Scroll  or  to the melody you want and press .
4. Press  to return to standby.











There are 5 base ringer melodies.

You will hear a sample as each melody is highlighted.

## Base settings

### Change PIN code

Your System PIN can help prevent unauthorised users from changing the settings on your phone.

1. Press  to open the main menu.
2. Press  or  until the display shows Setup base and press .
3. Press  or  until Change PIN is displayed, press  to select. Enter PIN is displayed.
4. Enter the existing PIN code using the keypad and press . New PIN is displayed.
5. Enter a new 4 digit PIN code using the keypad and press . Repeat PIN is displayed.
6. Re-enter the new PIN code and press . Saved is displayed.
7. Press and hold  to return to standby.

The default PIN setting is 0000.











If you change your PIN, keep a note of the new number by writing it in the space provided on page 73.

If you enter the wrong PIN code Wrong PIN will be displayed.











### Restore default settings

You can reset your Telstra 7300/7300a base to its default (original) settings.

1. Press  to open the main menu.
2. Press  or  until the display shows **Setup base** and press .
3. Press  or  until **Reset** is displayed, press  to select.
4. Enter **PIN** is displayed. Enter the 4 digit PIN code using the keypad and press .
5. **Reset?** is displayed. Press  to confirm, **Saved** is displayed.
6. Press and hold  to return to standby.

### PABX access

If your Telstra 7300/7300a is connected to a PABX, you may need to enter an access code (e.g. 9) to get an outside line. You can store the access code in the base so that all handsets registered to your Telstra 7300/7300a will dial the access code automatically before each number.

1. Press , scroll  or  to **Setup base** and press .
2. Scroll  or  to **Access code** and press .
3. Enter the access number and press .
4. Press  to return to standby.

The access code only applies when you dial using the keypad. It will not be automatically dialled when using the Phonebook, therefore it is recommended that you enter the PABX access code at the start of all Phonebook entries.

## Calling Number Display

If you subscribe to Telstra's Calling Number Display service, you can see your caller's number on your handset display prior to answering the call.

If the caller's name and number are stored in the Phonebook and a name/number match is found, you will see the caller's name on the display instead.

It may take a couple of seconds for the display to show the telephone number (or name if stored in the Phonebook) for an incoming call. The display will initially display **External Call** followed by the number. To ensure that the caller's name is displayed, make sure you have stored the full number including the area code in the Phonebook.

### Caller information not available

For some incoming calls, the telephone number of the caller is not available and so cannot be displayed. In this case the Telstra 7300/7300a provides you with some explanatory information.

**Unavailable** – The number is unavailable. May indicate that the call is from overseas or from a caller whose carrier does not participate in Calling Number Display.

**Private** – The caller has withheld (blocked) their number or the call is from a Silent Line or unlisted number.









### Calls List

When a call is not answered, the display shows **New calls** and your caller's telephone number will be stored in the Calls list.













The Calls list holds up to 10 missed calls.

When the Calls list is full, the oldest call will be replaced by a new call, the most recent call will always be at the top of the list. If a caller rings again their number will move to the top of the list.

### View/dial a number

1. Press  to open the main menu.
2. Press  or  to display **Calls list** and press  to select.
3. The most recent missed call is displayed. Press  or  to scroll through the Calls list.
4. Press  or  to dial the number displayed.

### To copy a Calls list number to the Phonebook

1. Press  to open the main menu.
2. Press  or  to display **Calls list** and press  to select.  
The most recent missed call is displayed.
3. Press  or  to scroll through the Calls list to the entry you want and press  to select.
4. Press  or  to display **Save number** and press  to select.
5. Name is displayed. Enter a name using the keypad and press  to confirm.
6. Saved is displayed. Press and hold  to return to standby mode.

#### IMPORTANT













To use Calling Number Display you must first subscribe to Telstra's Calling Number Display service.

Instead of accessing the Calls list via the menu, you can press  from standby.

If a number is stored in the Phonebook, the caller's name will be displayed instead of the number.

If there are no Calls list numbers stored, **Empty** will be displayed.

### Delete a number

1. Press  to open the main menu.
2. Press  or  to display **Calls list** and press  to select.  
The most recent missed call is displayed.
3. Press  or  to scroll through the Calls list to the entry you want and press  to select.
4. Press  or  to display **Delete entry** and press  to select.
5. **Delete ?** is displayed, press  again to confirm.
6. **Deleted** is displayed. Press and hold  to return to standby mode.

### Delete the entire Calls list

1. Press  to open the main menu.
2. Press  to display **Calls list** and press , press  to select. The most recent missed call is displayed.
3. Press  or  to display **Delete list** and press  to select.
4. **Delete list ?** is displayed, press  again to confirm.
5. **Deleted** is displayed, then **Empty**. Press and hold  to return to standby mode.



# Telstra Network Features

By pressing the Telstra button on the handset your Telstra 7300/7300a gives you easy access to a range of pre-stored Telstra Calling Features.

These are:

- MessageBank®
- Call Waiting
- 3-Way Chat
- Call Back
- Feat. Assist
- Call Wait On
- Call Wait Off
- Call Back Off
- CF Immed. Off
- TechHelp Line





## To access a Network feature

1. Press , scroll  to desired network feature and press . The feature will be automatically dialled

For more information on these Telstra network services please contact Telstra on 13 22 00 or visit the web at [www.telstra.com](http://www.telstra.com)

## TechHelp line

A dedicated support service for your Telstra cordless telephone.



1. Press , then scroll  to TechHelp Line, then  or .
- The TechHelp line will be automatically dialled.

## Telstra Network Features

### MessageBank®

If you are a Telstra Home Messages 101® or MessageBank® user, its now even easier to retrieve your messages. Your Telstra 7300 or 7300a is programmed to access Telstra Home Messages 101® and MessageBank®

### To retrieve a message from your message service

1. Press the  key
2. MessageBank should now appear highlighted, now press 
3. Follow the message service prompts.

### Flashing Message Indicator

The Telstra 7300/7300a is designed to provide a visual indicator when a new message is left in your Telstra Home Messages 101® or MessageBank® service.

When a new message is left the  icon will appear.

After you have listened to your message(s), the  icon will disappear.







Please call Telstra on 13 22 00 to arrange activation of Flashing Message Indicator.

## Call Waiting

Call Waiting lets you know if another person is trying to contact you while you are on a call. If a second caller rings you will hear a beep in the handset.











### Answer a Call Waiting call

During a call, you hear the call waiting signal,







1. Press .
2. Scroll  to Call Waiting and press . Your first caller is put on hold and you are connected to your second caller.
3. To toggle between the two callers Press  then scroll  to Call Waiting and press .
4. Press  to hang up the current call.

Providing you have subscribed to Telstra's Calling Number Display service, the screen will show the caller's details.

### Add/edit a service

1. Press  then scroll  to the service you want to edit and press .
2. Scroll  to display Edit and press . If there is a previously stored number, this will be displayed.
3. If necessary edit the number, pressing  to delete any existing digits, then enter the new service number using the keypad and press . If there is a previously stored name, this will be displayed.
4. If necessary edit the name, pressing  to delete any existing characters, then enter the new service name using the keypad and press . For help with entering text, see page 37.
5. Saved is displayed. Press and hold  to return to standby mode.

## Delete a service

1. Press  then scroll  to the service you want and press .
2. Scroll  to display Delete and press . Delete? is displayed.
3. Press  to confirm. Deleted is displayed. After 2 seconds the display shows Empty.
4. Press and hold  to return to standby mode.

## Using the answering machine (7300a only)

You can operate your Telstra 7300a answering machine from:

- the base
- the handset
- remotely from any external tone dialling telephone.

The default setting for the answering machine is ON.

Until you change your outgoing message, your callers will be greeted with the pre-recorded message, *“Hello, your call cannot be taken at the moment, so please leave your message after the tone”*.

Your answering machine is designed to answer calls after 15 rings when it is switched off. This is to enable you to operate the remote access functions of your answering machine in the event your answering machine is switched off.

### Date and time

An announcement of date and time of recording will be added automatically to each message and memo.

When playing back messages at the handset, the date and time of the message is displayed on the screen.

If you subscribe to Telstra’s Calling Number Display service, the date and time are set automatically when your Telstra 7300a receives its first call, but you may also need to set the year using a handset, see page 11.

## Using the answering machine (7300a only)

### Operating the answering machine from the base

#### Switch on/off

1. Press 

#### Playing messages

1. Press 

*During playback:*

 **SKIP BACK** – press *once* to repeat current message, *twice* to play previous message

 **SKIP FORWARD** – press to play next message

 **DELETE** – press to delete current message

 **STOP** – press to stop playback

#### Adjust volume









1. Press  or  to increase or decrease the volume

### Operating the answering machine from the handset

You can use any registered Telstra 7300a handset to switch your answering machine on and off, hear your messages and adjust the answering machine settings

During operation via the handset, you will hear prompts that guide you through each step

### Switch on/off

1. Press  to scroll to **Ans. Machine** menu and press .
2. Scroll  or  to **Ans. Settings** and press .
3. **\*\*Listen\*\*** will be displayed and you will be prompted to enter  to hear the menu options
4. Press  to select On or Off. The voice prompt will announce “Answer on” or “Answer off” as appropriate.
5. Press and hold  to return to standby.

### Outgoing messages

This is the message your callers hear when the answering machine picks up their call. Your Telstra 7300a comes with two pre-recorded outgoing messages to choose from.

To set your answering machine to Answer & Record or Answer Only, see Set answer mode, Page 60.

### Answer & Record

This invites your caller to leave a message.

The pre-recorded message is, “Hello, your call cannot be taken at the moment, so please leave your message after the tone”.

### Answer Only









This does not allow your caller to leave a message.

The pre-recorded message is, “Hello, your call cannot be taken at the moment, and you cannot leave a message, so please call later”.

### Record your own outgoing message









To record a new Answer Only message you must first set up your answering machine to Answer Only, see page 58. Similarly, to record a new Answer & Record message the answering machine must be set to Answer & Record.

An Answer & Record message can be up to 2 minutes long. An Answer Only message can be any length depending on the amount of recording memory available.

1. Press  scroll to **Ans. Machine** menu and press .
2. Scroll  or  to **Ans. Settings** and press .
3. **\*\*Listen\*\*** will be displayed and you will be prompted to enter  to hear the menu options
4. Press  to start to record your new message. Press  to end recording and your new message will be played back to you.
5. Press and hold  to return to standby.

### Play outgoing message

If the answering machine is set to Answer Only you will hear the Answer Only message. Similarly if Answer & Record is on you will hear the Answer & Record message.

1. Press  scroll to **Ans. Machine** menu and press .
2. Scroll  or  to **Ans. Settings** and press .
3. **\*\*Listen\*\*** will be displayed and you will be prompted to enter  to hear the menu options
4. Press  to hear your message.
5. Press  to return to standby.

## Reinstate pre-recorded outgoing message

This will delete your own recorded outgoing message.

To reinstate the answer only message you must first set up your answering machine to Answer Only, see below. Similarly, to reinstate the Answer & Record message the answering machine must be set to Answer & Record

1. Press scroll to **Ans. Machine** menu and press
2. Scroll or to **Ans. Settings** and press
3. **\*\*Listen\*\*** will be displayed and you will be prompted to enter to hear the menu options
4. Press and then immediately after the tone. The original pre-recorded message will be played back to you.
5. Press to return to standby.

## Set answer mode

Set your machine to Answer & Record or Answer Only.

1. Press scroll to **Ans. Machine** menu and press
2. Scroll or to **Ans. Settings** and press
3. **\*\*Listen\*\*** will be displayed and you will be prompted to enter to hear the menu options
4. Each press of will alternate between Answer & Record on and Answer Only on.
5. Press to return to standby.

## Answer delay

Answer delay sets the number of rings before your Telstra 7300a answering machine picks up a call. The default setting is 6 rings. You can select an answer delay of 2, 4, 6, 8 rings or Time Saver. Time Saver can save you the cost of a call when you want to ring in to find out if you have new messages. Your answering machine answers after 2 rings if you have new messages. If you have no new messages, it will answer after 6 rings which gives you the opportunity to hang up and save the cost of a call.

## Set answer delay

1. Press scroll to **Ans. Machine** menu and press
2. Scroll or to **Ans. Settings** and press
3. **\*\*Listen\*\*** will be displayed and you will be prompted to enter to hear the menu options
4. Press to change the answer delay. The new setting will be announced after each press.
5. Press and hold to return to standby.

## Playing messages

During playback, you can repeat, delete and skip back to previous messages or forward to the next message.

1. Press scroll to **Ans. machine** menu and press
2. **Play message** is displayed, press . Your messages are played and details of each message are displayed.

During playback:

**Stop/Play** press 

**Repeat current message** press 

**Play previous message** press  twice



**Delete current message** press 



**Skip forward to next message** press 

3. Press and hold  to return to standby.

### Delete all old messages

You can only delete messages that have been played. Any new, unplayed, messages will not be deleted

1. Press  scroll to Ans. machine menu and press .

2. Scroll  or  to Del. all old and press .



3. Press  to confirm.

4. Press  to return to standby.

### Call screening

You can listen while your answering machine takes a call via the handset or the base speaker. This lets you identify the caller and decide whether to take the call yourself.

1. When the answering machine takes a call it can be heard through the base speaker. Screen? also appears on the handset and pressing  allows you to hear your caller leaving their message.

2. To speak to your caller, press  or . Recording stops automatically.

### Memory full

If a caller is leaving a message when the memory becomes full your machine will announce, “Memory full thank you for calling” and hang up. The machine will also automatically set to Answer Only, the base indicator will flash F and the handset display will show Ans. mach full. You must delete messages before you can receive any new ones.



### Remote access

#### Security PIN

You can operate your answering machine from any modern phone by calling your Telstra 7300a and entering a 4-digit security code.

The pre-set code is 0000. You must change the code from 0000 to another 4-digit number to enable remote access.

#### Set/change remote access security PIN

1. Press  scroll to Ans. machine menu and press .

2. Scroll  or  to Security PIN and press .

3. Enter the current 4 digit PIN (default setting = 0000) and press .

4. Enter the new PIN and press .

5. Enter the new PIN again and press .

6. Press  to return to standby.



### Operating your answering machine from another phone.

1. Dial your phone number. When you hear your outgoing message, press the **\*** button. You will hear, "Please enter your security code."
2. Enter your 4-digit PIN. If you have new messages, your machine announces, "You have (x) new messages", and they are played back. Or you will hear, "You have no new messages, to hear main menu press 1."
3. Use the buttons on the phone to operate the answering machine:

Press:

- 1** to hear main menu
- 2** ABC to play all messages
- 3** DEF to play new messages only
- 4** GHI *once* to repeat the message, *twice* to play previous message
- 5** JKL to delete the current message
- 6** MNO to skip forward to the next message
- 7** PQRS to set answer mode, follow voice prompts
- 8** TUV to play outgoing message
- 9** WXYZ to record a new outgoing message, follow voice prompts
- 0** to switch answering machine on/off

If you don't give any instructions for 8 seconds, your Telstra 7300a will hang up.

### Switch answering machine on remotely

If you forget to switch on your answering machine, you can do it from another phone.

1. Dial your phone number and let it ring. After 15 rings, your answering machine will switch on.
2. You will hear, "Please enter your security code."
3. Enter your 4-digit PIN. If you have new messages, your machine announces "You have (x) new messages", and they are played back. Or you will hear "You have no new messages, to hear main menu press 1."
4. Enter **0** to switch the answering machine on.

If you experience any problems, please call TecHelp on 1300 369 193 or email:

**tcpsupport@ingrammicro.com.au**

## Handset not registering?

- Is Searching displayed on the handset?
- Check that the base is plugged into the mains power and switched on.
- Check that there are charged batteries in the handset and that they are fitted correctly.



## Forgotten your PIN number

- Try entering the default PIN = 0000. If you have changed the number and cannot remember it, contact the TecHelp line on 1300 369 193 or email: **tcpsupport@ingrammicro.com.au**

## No display

- Check that the handset batteries are charged and correctly fitted. If necessary, replace the batteries.

## Nothing happens when you press any button

- Is the  LOCK symbol displayed? If so, the key lock is on, press and hold  for 1.5 seconds to unlock the keypad.

## No connection between handset and base

- You may be out of range, is the  ANTENNA symbol flashing? If so, move closer to the base.



## Handset is not charging properly

- Make sure the handset is placed properly on the base/charger. When charging, the battery symbol is shown filling up.
- Clean the charging contacts with a soft, slightly damp (not wet) cloth.

## Handset does not ring

- Check that the batteries are inserted correctly.
- Check that the handset ringer has not been switched off, see page 43.

## Your caller cannot hear you

- Is the  MUTE symbol displayed? If so, Mute is switched on. Press the  button to speak to your caller again.

## Incoming caller's number is not displayed even though you have Caller Display

- Caller has to allow their number to be sent.
- It has been withheld or is unavailable

## Buzzing noise on my phone or on other electrical equipment nearby

- Your Telstra 7300 may interfere with other electrical equipment if it placed too close. It is recommended that you place your Telstra 7300 at least one metre away from electrical appliances or metal obstructions to avoid interference.
- If you have an ADSL internet service ensure that the correct filter for a Digital DECT cordless telephone is installed to prevent interference from the telephone line.

## Possible problems with text messaging

### Text messages cannot be sent and screen displays Msg Failed

- The base station power supply or telephone line cord might not be properly connected.
- Check that the base station power supply is plugged into the mains socket and switched on and that the telephone is plugged into the telephone wall socket.
- There might be a fault on the line. Check your telephone line is working properly.
- You might have deleted the server number in error. See page 41 for instructions on how to enter the number.

### Cannot send text

- Check Outgoing service centre number is correct
- Check that the service you are sending to is a compatible Network to receive fixed line text messages
- Ensure that you are entering the full telephone number, including area code, of the person you are trying to text message

### Cannot receive text

- You will not be able to receive text messages until you have first sent a message. The first message sent registers you with the text service.
- More than one text messaging product is plugged into the line. Change the Common Inbox Sub Address of other text message enabled products to a number other than 0.
- Check Incoming service centre number is correct.
- Ensure the sender is entering your full telephone number, including area code.
- Check that the service that is sending is a compatible Network to send text messages to a fixed line.

Further help and advice for text queries on Telstra lines call 13 2200

## Possible problems with the answering machine

### Answering machine does not record any messages

- The memory may be full. Play and delete old messages, see page 62.

### Answering machine messages have the wrong date and time

- Have you set the date and time? See page 56.

# General information

## Safety

- The Telstra 7300/7300a digital cordless telephone is not designed for making emergency telephone calls when the power fails.
- Only use the power supply supplied with your Telstra 7300/7300a. Using an unauthorised power supply will invalidate your guarantee and may damage the telephone.
- Only use the telephone line cord supplied with your Telstra 7300/7300a, otherwise your telephone may not work correctly.
- For the handset, use only AAA Nickel Metal Hydride (NiMH) rechargeable batteries with a minimum capacity of 600mAh. Never use other batteries or conventional alkaline batteries as this could lead to a short circuit or destroy the battery casing.
- If the keylock is switched on, it is only possible to make calls to emergency numbers (000).
- Do not open the handset (except to replace the handset batteries). This could expose you to high voltages or other risks.

- Radio signals transmitted between the handset and base may cause interference to hearing aids.
- It is recommended that advice from a qualified expert be sought before using this product in the vicinity of emergency/intensive care medical equipment.
- It is recommended that if you have a pacemaker fitted you check with a medical expert before using this product.
- Never dispose of batteries in a fire. There is a serious risk of explosion and/or the release of highly toxic chemicals.

## Cleaning

Simply clean the handset and base with a damp (not wet) cloth, or an anti-static wipe. Never use household polish as this will damage the product. Never use a dry cloth as this may cause a static shock.

## General information

### Environmental

- Do not expose to direct sunlight.
- The Telstra 7300/7300a handset may become warm when the batteries are being recharged. This is normal. We recommend that you do not place the product on antique/veneered wood to avoid damage.
- Do not stand your product on carpets or other surfaces which generate fibres or place it in locations preventing the free flow of air over its surfaces.
- Do not submerge any part of your product in water and do not use it in damp or humid conditions, such as bathrooms.
- Do not expose your product to fire, explosive or other hazardous conditions.
- We recommend that you unplug the power and telephone line cord during an electrical storm as there is a slight chance your phone could be damaged by such storm.

### PABX compatibility

This telephone may be connected to most types of PABX, however in the event of any difficulties, consult your PABX Service Provider.

### Recall (R)

Recall is used when connected to certain PABX's and some Telstra Calling Features, or those services available via your network provider.

### Technical information

#### How many telephones can I have?

All items of equipment have a Ringer Equivalence Number (REN) which is used to calculate the number of items that may be connected to any one telephone line. The Telstra 7300/7300a has a total REN of 0.1, i.e. for a base and up to 4 handsets. A total REN of 3 is allowed per telephone line. If the total REN of 3 is exceeded, the telephone may not ring. With different telephone types there is no guarantee of ringing, even when the REN is less than 3.

# Customer service & Product warranty

## IMPORTANT

Please retain this booklet with your sales receipt as proof of the date of purchase

## Customer Service

If you require assistance in operating this product please call the TechHelp Information Line on 1300 369 193 or contact us by e-mail at: **tcpsupport@ingrammicro.com.au**

If you are trying to access a Telstra Network Service and require assistance specifically related to the network service or would like to subscribe to the service, contact Telstra on 132200 for residential or 132000 for business.

## Product Warranty

Subject to the conditions below, Telstra guarantees this product against any defect in materials or workmanship under conditions of normal use for a period of 24 months from date of purchase.

The benefits conferred by this warranty are in addition to other warranties and remedies that are implied under the Trade Practices Act

and similar State and Territory laws (Statutory Rights).

Subject to your Statutory Rights, the goods will not be eligible for service under this warranty if:

- a) Proof of purchase cannot be provided;
- b) The defect was caused by an accident, misuse, abuse, improper installation or operation, vermin infestation, lack of reasonable care, unauthorised modification, loss of parts, tampering or attempted repair by a person not authorised by Telstra; or
- c) The product has been damaged by lightning or a mains power surge.

To obtain service during the terms of this warranty call the TechHelp Information Line on 1300 369 193 or contact us by e-mail at: **tcpsupport@ingrammicro.com.au**

If it is necessary to have the product serviced, the Customer Service Representative will inform you of the product return process.

Please ensure that:

- a) You provide proof of purchase;

## Customer service & Product warranty

- b) Your product is suitably packaged; and
- c) You have included all components from the original purchase.

Subject to your Statutory Rights:

- a) Any claim under this warranty is limited to the cost of repair or replacement of the product; and
- b) If the goods are found to be in sound working order by the authorised service centre, you may be charged a fee for service and for any other direct costs associated with having the product delivered for service.

For your records

Date of purchase:

---

Place of purchase:

---

Serial number:

---

For guarantee purposes proof of purchase is required so please keep your receipt.

Enter your base PIN here:

---

(See page 47 for more information)

© COPYRIGHT 2007 Telstra Corporation Limited  
This work is copyright. All rights reserved. Other than for purposes and subject to conditions prescribed under the Copyright Act, no part of it may in any form or by any means (electronic, mechanical, photo copying, microcopying, scanning, recording or otherwise) be reproduced, stored in a retrieval system or transmitted without prior permission from Telstra Corporation Limited ABN 33 051 775 556.  
™ Trade Mark of Telstra Corporation Limited  
® Registered Trade Mark of Telstra Corporation Limited

## Wall mounting template

### Wall mounted spacing

Ensure there is sufficient space allowed for mounting the phone before drilling holes.

See page 13 and follow mounting instructions.

**Caution:** Ensure there is no risk of damaging any pipes or wiring that may be behind the wall.



**Drill two holes 3 mm  
in diameter.  
100 mm apart**

[www.telstra.com](http://www.telstra.com)



Download from [Www.Somanuals.com](http://Www.Somanuals.com). All Manuals Search And Download.

## Free Manuals Download Website

<http://myh66.com>

<http://usermanuals.us>

<http://www.somanuals.com>

<http://www.4manuals.cc>

<http://www.manual-lib.com>

<http://www.404manual.com>

<http://www.luxmanual.com>

<http://aubethermostatmanual.com>

Golf course search by state

<http://golfingnear.com>

Email search by domain

<http://emailbydomain.com>

Auto manuals search

<http://auto.somanuals.com>

TV manuals search

<http://tv.somanuals.com>