



PHONECELL[®] SX5P

CDMA2000 1X

• Fixed Wireless Phone

800/1900 MHz CDMA

USER MANUAL

QUICK CONNECTION GUIDE

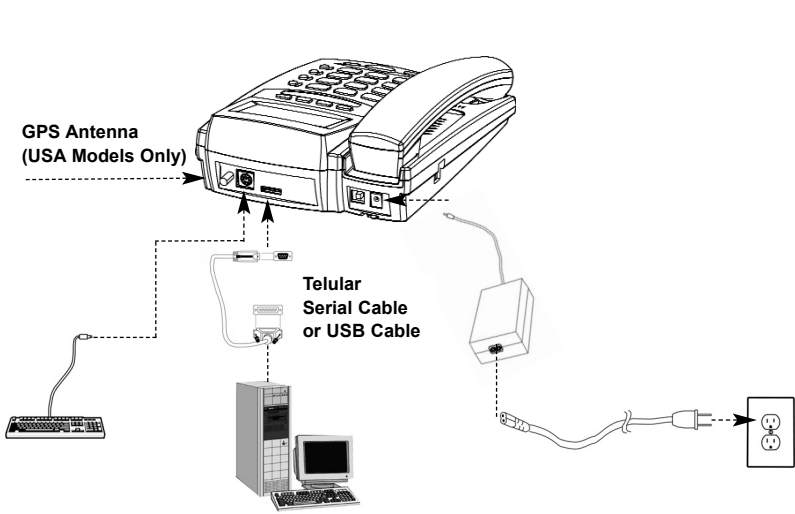

Fixed Wireless Phone

SX5 MENU STRUCTURE

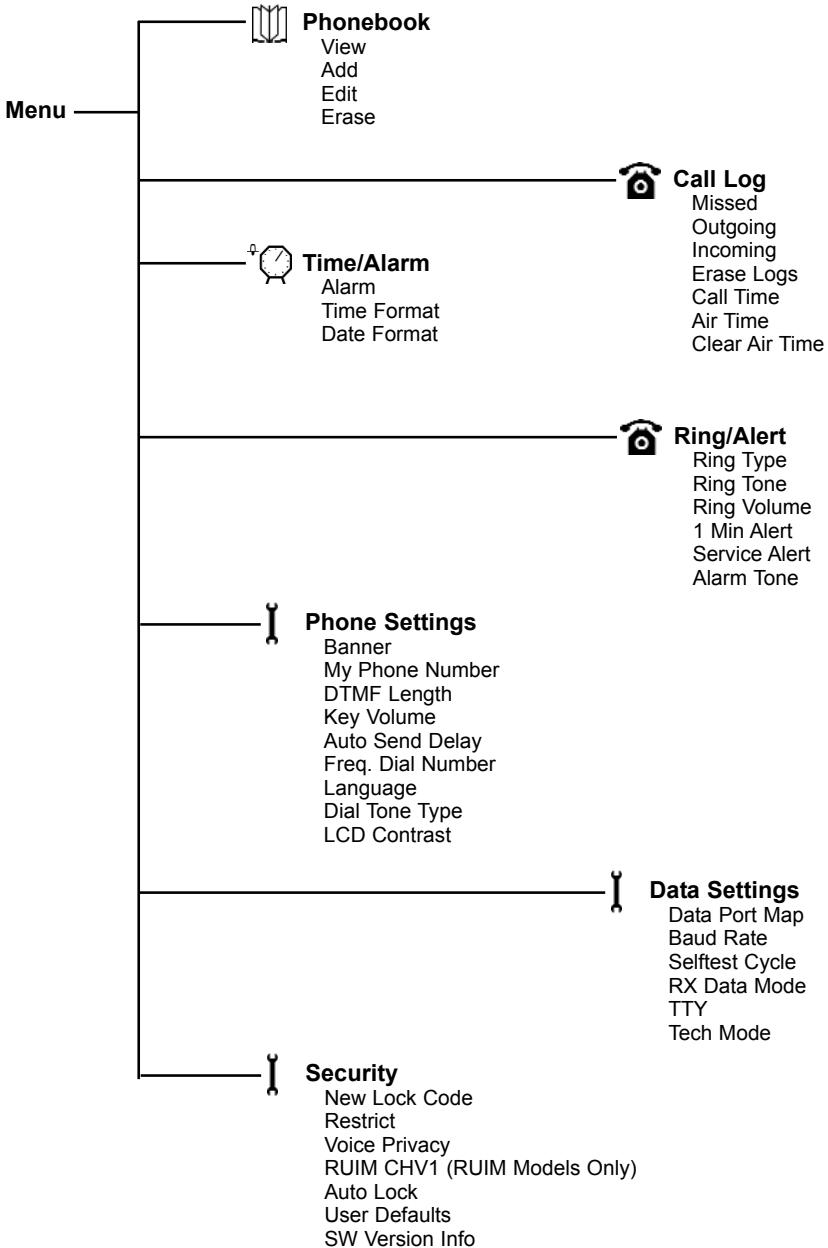

LIST OF COMPONENTS



Phonocell® SX5
Desktop Phone



Spike Antenna



Power Supply



AC Power Cord



USA Only: GPS Antenna
and Mounting Plate (Not Shown)

Before installing your **Phonocell® SX5**, carefully remove the contents from the shipping carton and check for evidence of shipping damage. **If damage is found, contact your Authorized Telular Distributor or shipping agent immediately.**

SAFE OPERATION INSTRUCTIONS

IMPORTANT! Before installing or operating this product, read the **SAFETY INFORMATION** section of this manual.

- Install unit indoors.
- Install unit on hard, flat surface for proper ventilation.
- Do not expose unit to rain or moisture.
- Do not place unit on or close to sources of heat

PLEASE SEE THE IMPORTANT NOTICES SECTION OF THIS MANUAL FOR IMPORTANT INFORMATION ON USE, WARRANTY AND INDEMNIFICATION

IMPORTANT NOTICES

TERMS AND CONDITIONS FOR USE OF PHONECELL® PRODUCTS ("Product")

These Terms and Conditions are a legal contract between you and Telular Corporation for the title to and use of the Product. BY RETAINING AND USING THE PRODUCT AFTER RECEIPT OF IT, YOU AGREE TO THE TERMS AND CONDITIONS INCLUDING WARRANTY DISCLAIMERS, LIMITATIONS OF LIABILITY AND INDEMNIFICATION PROVISIONS BELOW. IF YOU DO NOT AGREE TO THE TERMS AND CONDITIONS, DO NOT USE THE PRODUCT AND IMMEDIATELY RETURN THE UNUSED PRODUCT FOR A COMPLETE REFUND. You agree to accept sole responsibility for any misuse of the Product by you; and, in addition, any negligent or illegal act or omission of your or your agents, contractors, servants, employees, or other users of the Product so long as the Product was obtained from you, in the use and operation of the Product.

INDEMNIFICATION OF TELULAR CORPORATION ("TELULAR")

YOU SHALL INDEMNIFY, DEFEND AND HOLD HARMLESS TELULAR FOR ANY OF THE COST, INCLUDING REASONABLE ATTORNEYS' FEES, AND FROM CLAIMS ARISING OUT OF YOU, YOUR CLIENTS' OR OTHER THIRD PARTIES' USE OR OPERATION OF THE PRODUCT: (i) FOR MISUSE OR IN A MANNER NOT CONTEMPLATED BY YOU AND TELULAR OR INCONSISTENT WITH THE PROVISIONS OF THIS MANUAL; (ii) IN AN ILLEGAL MANNER OR AGAINST PUBLIC POLICY; (iii) IN A MANNER SPECIFICALLY UNAUTHORIZED IN THIS MANUAL; (iv) IN A MANNER HARMFUL OR DANGEROUS TO THIRD PARTIES; (v) FROM CLAIMS BY ANYONE RESPECTING PROBLEMS, ERRORS OR MISTAKES OF THE PRODUCT; OR (vi) COMBINATION OF THE PRODUCT WITH MATERIAL, MODIFICATION OF THE PRODUCT OR USE OF THE PRODUCT IN AN ENVIRONMENT NOT PROVIDED, OR PERMITTED, BY TELULAR IN WRITING. THE PARTIES SHALL GIVE EACH OTHER PROMPT NOTICE OF ANY SUCH COST OR CLAIMS AND COOPERATE, EACH WITH THE OTHER, TO EFFECTUATE THIS INDEMNIFICATION, DEFENSE AND HOLD HARMLESS.

TELULAR CORPORATION

Corporate Headquarters

647 North Lakeview Parkway
Vernon Hills, Illinois 60061, USA

Technical Support

Tel: 847-247-9400 • Fax: 847-247-0021

E-mail: support@telular.com • <http://www.telular.com>

TABLE OF CONTENTS

QUICK CONNECTION GUIDE	i
SX5 MENU STRUCTURE	ii
LIST OF COMPONENTS	iii
SAFE OPERATION INSTRUCTIONS	iii
IMPORTANT NOTICES	iii
TABLE OF CONTENTS	iv
SX5 SETUP	1
RUIM Card Installation	1
Emergency Batteries	1
Battery Operation	2
Location and Setup	2
GPS Antenna Mounting (USA Only)	2
Connect the Handset	3
Desk Mounting	3
Wall Mounting	4
Connect the SX5 to AC Power	5
RUIM Usage	6
GETTING TO KNOW YOUR SX5	7
Function Keys	7
LCD Screen Icons	8
Service Indication	8
CALL FUNCTIONS	9
Making Calls	9
Receiving Calls	9
Ending Calls	9
In-Call Functions	9
Voice Mail Access	10
Reading Text (SMS) Messages	10
Sending a Text Message	10
Delete All Text Messages	10
Message Lock	11
Message Alert	11
PHONE BOOK	12
Speed Dial by Location	12
Searching the Phone Book and Dialing a Phone Book Entry	12
Adding an Entry into the Phone Book	12
Edit a Phone Book Entry	13
Erase a Phone Book Entry	13
CALL LOGS	13
View Missed Calls	13
View Outgoing Calls	14
View Incoming Calls	14
Erase All Call Logs	14
View Last Call Time	14
View Total Air Time	14
Clear Air Time	15

TIME / ALARM	15
Alarm.....	15
Time Format.....	15
Date Format.....	15
RING / ALERT	16
Ring Type.....	16
Ring Tone.....	16
Ring Volume	16
One Minute Alert.....	16
Service Alert.....	16
Alarm Tone.....	17
PHONE SETTINGS	17
Banner	17
My Phone # (Display Only).....	17
DTMF Length.....	17
Key Volume.....	17
Auto Send Delay.....	17
Frequently Dialed Number.....	17
Change Language Displayed on LCD	18
Dial Tone Type	18
LCD Contrast.....	18
DATA SETTINGS	18
Data Port Type	18
Baud Rate.....	19
Self Test Cycle.....	19
RX Data Mode	19
TTY (Text Telephone for the Hearing Impaired)	19
SECURITY SETTINGS.....	19
New Lock Code	19
Restrict Calls.....	19
Voice Privacy	20
RUIM CHV1 (RUIM Models Only)	20
Auto Lock	20
User Defaults	20
SW Version Information	20
WINDOWS XP/WINDOWS 2000 SETUP	21
WINDOWS 98 SETUP	27
SENDING/RECEIVING A PC FAX.....	31
SENDING/RECEIVING 1X DATA.....	32
SENDING/RECEIVING CIRCUIT SWITCHED DATA	33
SX5 TROUBLESHOOTING	34
CONFORMANCE STATEMENTS	35
SAFETY INFORMATION	36
WARRANTY	37

SX5 SETUP

RUIM Card Installation (RUIM Model Only)

Consult your service provider to determine if your unit is a RUIM model. If so, your SX5 will only be able to make emergency calls until you install a RUIM card. It will not receive calls or allow non-emergency outgoing calls. For an explanation of how to configure your RUIM once your SX5 is set up, see **RUIM Usage** (page 6).

1. Remove the power supply if it has already been connected. The power supply must be removed whenever a RUIM Card is removed or installed.
2. Remove the RUIM compartment cover. - **see Figure 1.**
3. Open the RUIM compartment holder.
4. Line up the RUIM card with the arrow on the RUIM card holder - **see Figure 2.**
5. Gently insert the RUIM card in the slot of the RUIM card holder.
6. Close the RUIM card holder.

NOTE: Do not force the RUIM card holder shut. Make sure the RUIM card is aligned properly with the directional arrow on the holder.

7. Reattach the RUIM compartment cover, closing it with the separate cover screw provided.

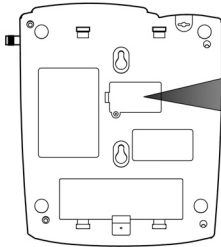

Figure 1 - RUIM compartment cover.

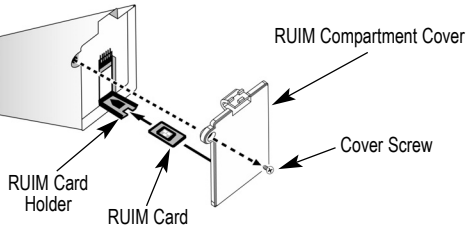



Figure 2 - RUIM card installation.

Emergency Batteries

Install Batteries

1. Remove the battery access door screw located on the bottom of the unit - **see Figure 3.**
2. Open the battery compartment by lifting the access tab in the battery compartment's center - **see Figure 3.** A new unit may require some extra force to open the compartment.
3. Install 4 "AA" alkaline batteries (not supplied), and re-secure the door with screw.



WARNING!

Only "AA" alkaline batteries are to be used with the Phonecell® SX5. Use of any other batteries may result in fire and/or other damage to the unit.

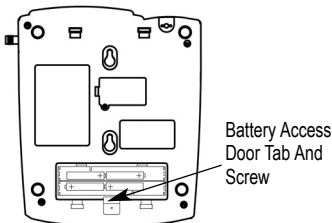

Figure 3 - Battery access door.

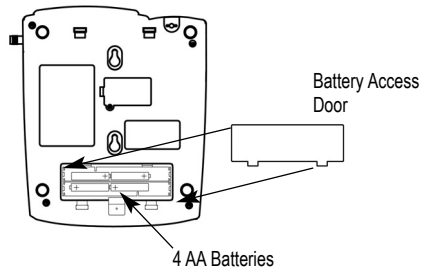

Figure 4 - Battery installation.

Battery Operation

The unit will not automatically switch from AC to battery upon loss of AC power. The AC/Battery switch must be changed manually to the battery position - **see Figure 5**. Battery power will provide up to 4 hours of talk time and 11 hours of standby.

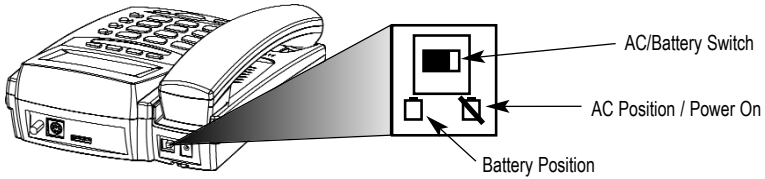

Figure 5 – AC battery Switch.

Location and Setup

The SX5 comes with a standard spike antenna (TNC).

1. Attach and finger-tighten the antenna - **see Figure 6**. Do not over-tighten the antenna.
2. Select a location that is above ground and as close to windows (or exterior walls) as possible to get the best signal - **see Figure 7**.

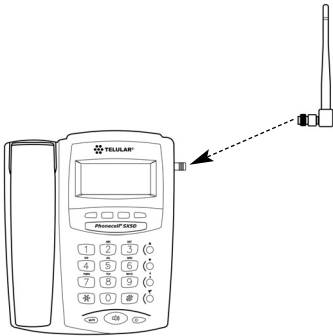

Figure 6 - Attach the antenna.

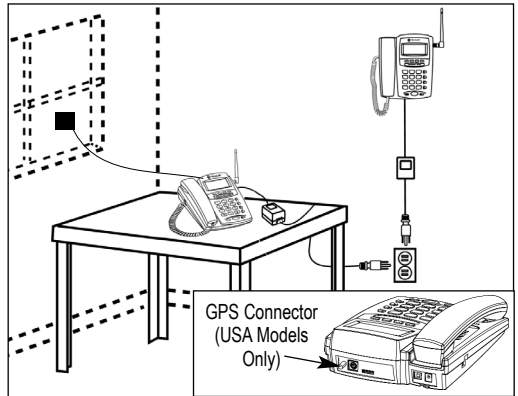

Figure 7 - SX5 location.

GPS Antenna Mounting (USA Only)

To satisfy the FCC's Enhanced 911 (E-911) Phase II mandate, SX5 phones distributed in the USA include a GPS antenna with a mounting bracket and suction cups. The GPS antenna uses satellite technology during emergency calls to automatically report your location to a 911 dispatcher within 50-100 meters in most cases. For this feature to function, you must properly mount the GPS antenna on a window as described below in addition to the standard antenna used for cellular system operation.

1. Mount the bracket on a window with good line of sight (no obstructions to the sky) using the suction cups. A small amount of water or petroleum jelly applied to the window surface of the suction cups will improve their long-term adhesion to the window. - **see Figure 7**.
2. Place the antenna on the topside center of the bracket. The bracket is tilted to aim the antenna out the window and toward the sky.
3. Connect the antenna to the GPS Connector on the rear panel of the SX5 - **see Figure 7**.

Connect the Handset

Before you can use the SX5, you must connect the handset cable.

1. Connect the handset cable to the phone jack - **see Figure 8.**
2. Connect the handset cable to the handset - **see Figure 8.**

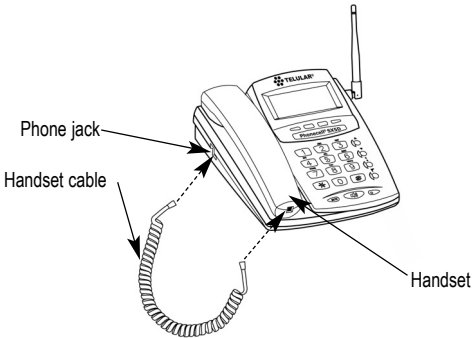

Figure 8 – SX5 handset connection.

Desk Mounting

A wedge is included with the SX5 to be used to position the SX5 for easier viewing of the LCD screen and keypad. Attaching the wedge is optional. To attach the wedge, use the following instructions.

1. Slide the wedge tabs on the thin end of the wedge into the bottom tab slots on the SX5 - **see Figure 9.**

NOTE: Holding the wedge at an angle makes it easier to slide the wedge tabs into the bottom tab slots.

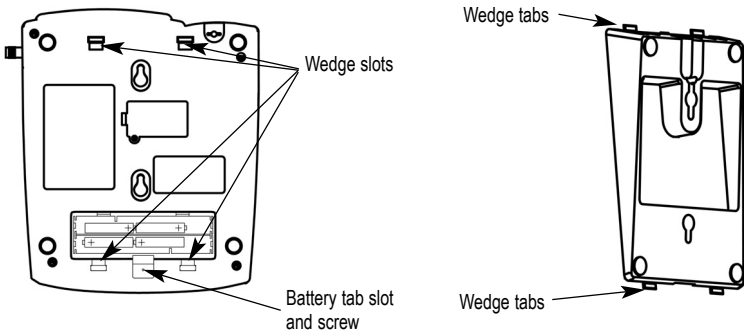

Figure 9 - Battery slot and wedge slots.

2. Snap the wedge tabs on the thick end of the wedge into the top tab slots - see **Figure 10**.

NOTE: The wedge will fit snugly, so it may be necessary to press the thick end of the wedge towards the bottom tab slots (if the wedge tabs at the thin end have been inserted) in order to snap it into the top tab slots.

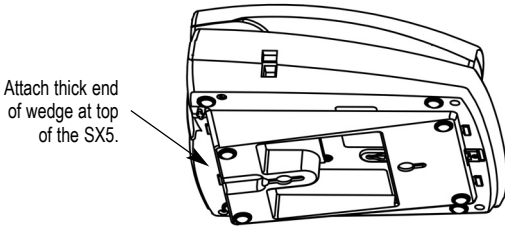

Figure 10 - Wedge attached for desk-mounting.

Wall Mounting

1. Remove the mounting clip from the cradle and re-insert it with the tab pointing up - see **Figures 11 and 12**.

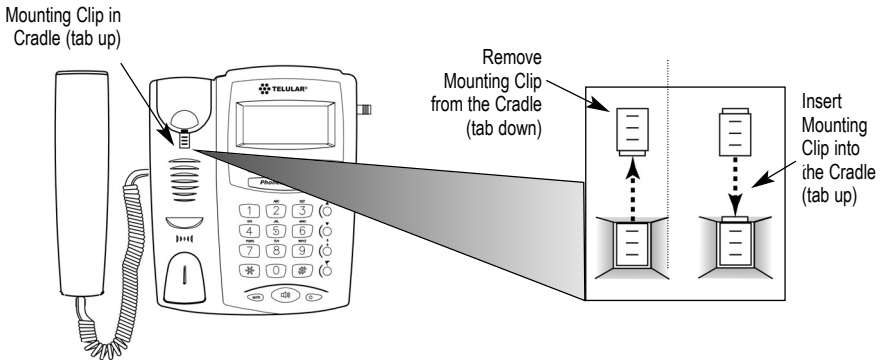

Figure 11 – Handset mounting clip assembly.

Figure 12 – Handset mounting clip for wall-mount.

2. Slide the wedge tabs on the thin end of the wedge into the bottom tab slots on the SX5 - see **Figure 13**.

NOTE: Holding the wedge at an angle makes it easier to slide the wedge tabs into the bottom tab slots.

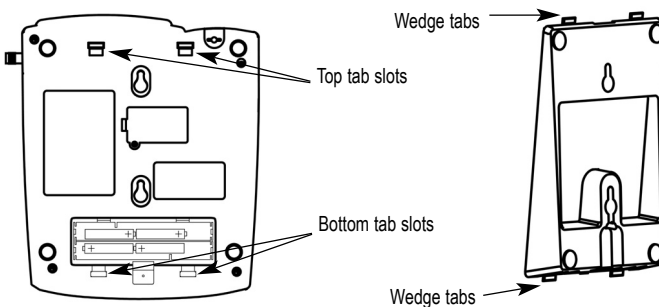

Figure 13 - Tab slots and wedge tabs.

3. Snap the wedge tabs on the thick end of the wedge into the top tab slots - **see Figure 14**. The wedge will fit snugly, so it may be necessary to press the thick end of the wedge towards the bottom tab slots (if the wedge tabs at the thin end have been inserted) in order to snap it into the top tab slots.
4. Mark two hole locations 83 mm (3-1/4 inches) vertically apart and drill two holes into the wall.
5. Install the screws (not supplied) into the wall, leaving a gap of approximately 3 mm (1/8 inches) between the screw head and the wall.
6. Align the mounting holes with the screws and mount the SX5 onto the screws - **see Figures 15 and 16**.

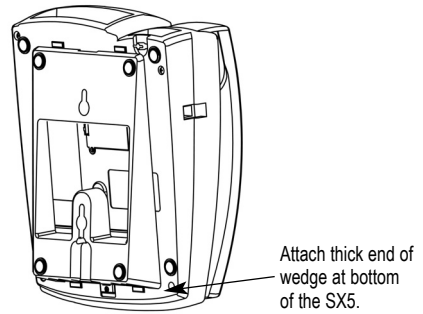

Figure 14 - Wedge attached for wall-mounting.

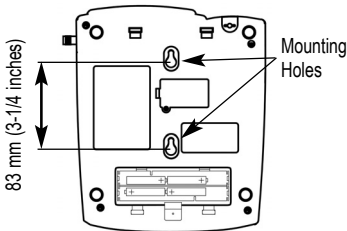

Figure 15 - SX5 mounting hooks.

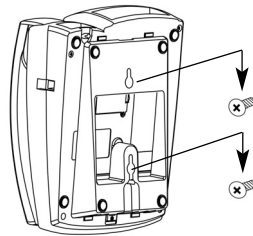

Figure 16 - Mount the SX5 onto the screws.

Connect the SX5 to AC Power

1. Connect the barrel connector of the power supply to the AC power input on the rear panel of the SX5 - **see Figure 17**.
2. Plug the AC power cord into the power supply.
3. Turn the AC/Battery switch to the AC position.
4. Plug the AC power cord into the wall socket. The SX5 will power up automatically.
5. Check the cellular signal strength and move the unit until the best signal possible is achieved - see the *Service Indication* section of this manual.

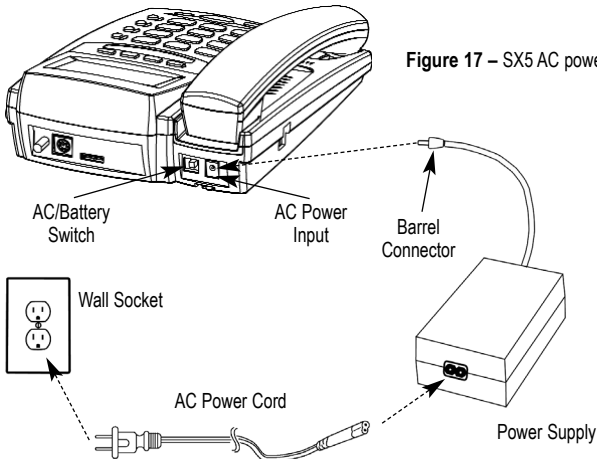

Figure 17 - SX5 AC power connection.

RUIM Usage (RUIM Models Only)

Your service provider may require you to install a RUIM in your SX5 for it to operate normally (see **RUIM Card Installation** (page 1) for details). Without a RUIM, these SX5 models will reject incoming calls and allow only emergency outgoing calls.

Once a RUIM-using SX5 is operating normally, you can use it to set its RUIM to require a PIN, not require a PIN, or change the existing PIN. See **Security** (page 20) for details.

Starting Your SX5 with a RUIM PIN

If your RUIM requires a PIN (Personal Identification Number, also called Cardholder Verification, or CHV), follow these steps:

1. Power on your SX5.
2. The SX5 will prompt you to enter your PIN. Enter the PIN for your RUIM, then press **STO**.
3. If you enter the wrong PIN, the SX5 will display an error message and ask you to reenter the PIN.
4. Entering an incorrect PIN three times will cause the SX5 to block the inserted RUIM. If your RUIM is blocked due to incorrect PIN use, it will prompt you to enter the unblocking code. You must contact your service provider to obtain this unblocking code. Do not guess at the block code or use your own PIN to attempt to unblock the SX5; entering wrong codes will eventually cause the RUIM to become permanently blocked.
5. If you are unable to enter the correct PIN for the inserted RUIM, the SX5 will not operate normally. It will reject incoming calls and permit only emergency outgoing calls.

Starting Your SX5 if Your RUIM Requires No PIN

Power on your SX5. No additional steps are necessary.

Starting Your SX5 if it is Bonded to a RUIM

A SX5 may be bonded to a specific RUIM. Once it has, the SX5 will not operate normally with any other RUIM installed in it. It will reject incoming calls and permit only emergency outgoing calls. The same holds true for any other SX5 the bonded RUIM is installed into: it will not operate normally.

To start a bonded SX5, power it on. No additional steps are necessary provided that the correct RUIM is inserted into the SX5.

If you want to bond a SX5 to an RUIM, contact your service provider.

GETTING TO KNOW YOUR SX5

Function Keys

Operation of the SX5 is accomplished through the function keys on the keypad of the unit - **see Figure 18.**

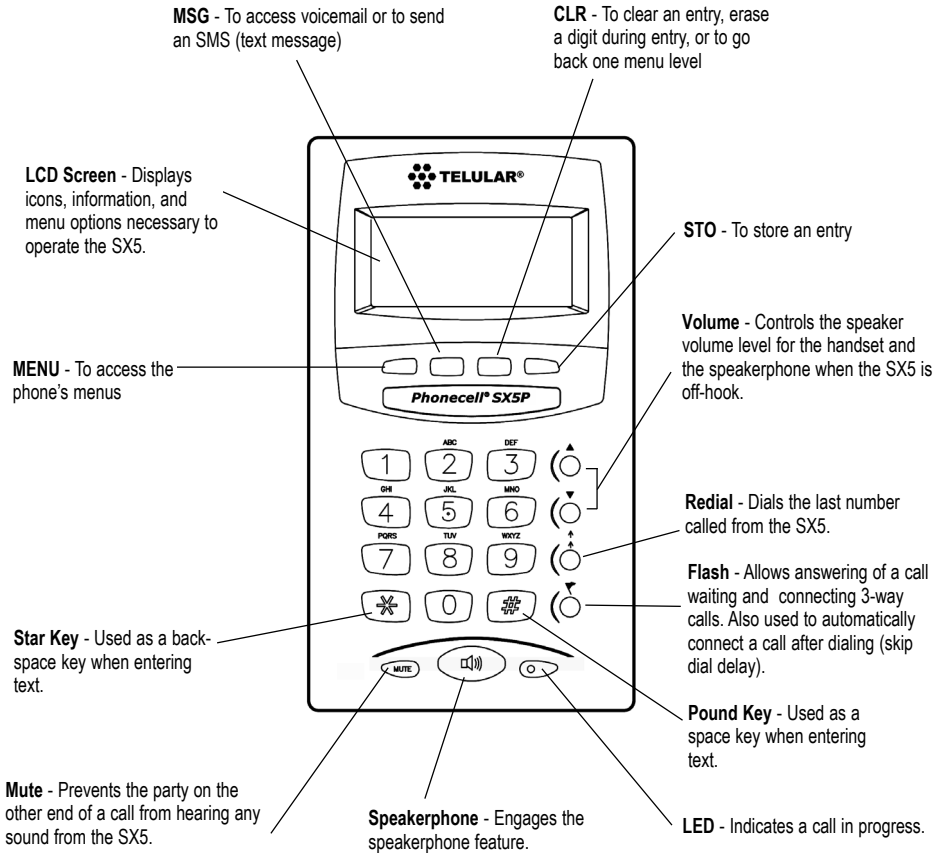

Figure 18 – SX5 keypad and function keys.

LCD Screen Icons

Icons displayed on the LCD screen indicate the features in use, the status of the phone, signal strength and battery status - **see Figure 19**.

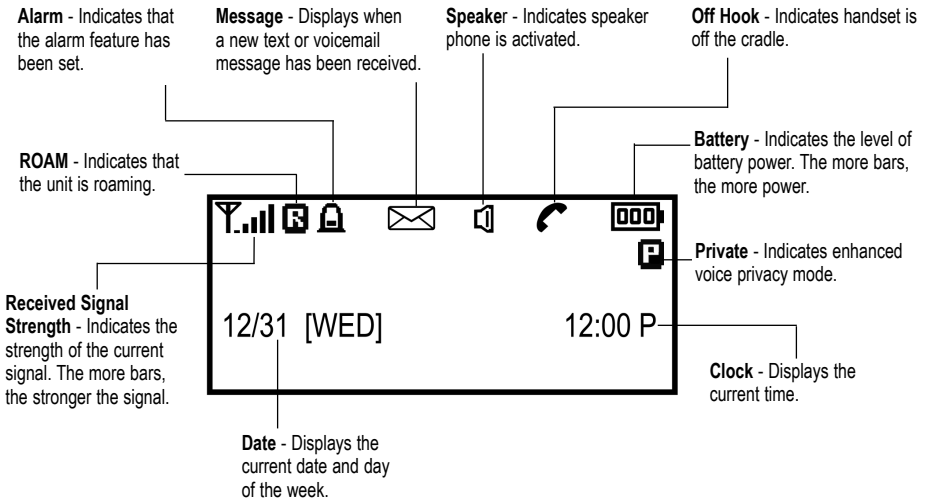

Figure 19 – SX5 LCD screen icons.

Service Indication

Full Service

When powered on, the banner and current date and time will display. If service is available, the antenna icon will display indicator bars. The number and height of the indicator bars increases as the signal grows stronger (the more bars, the better the signal).

No Service

When no service is available, the antenna icon will not display indicator lines. Contact your service provider to verify cellular service is activated. No calls can be made in this condition.

CALL FUNCTIONS

Making Calls

1. Pick up the handset or *Press* the **SPEAKERPHONE** key. The SX5 is now "off-hook."
2. Listen for dial tone.
3. Dial the phone number. The dialed number will be displayed. The name will also be displayed if it is stored in the phonebook.

Correct Dialing Errors

- To erase one digit, *Press* the **CLR** key once.
- To erase all digits, *Press* and hold down the **CLR** key until all digits are erased.

Redial the Last Telephone Number Dialed

1. Pick up the handset or *Press* the **SPEAKERPHONE** key. The SX5 is now "off-hook."
2. *Press* the **REDIAL** key.

Receiving Calls

When there is an incoming call, the SX5 rings, an incoming call notification displays the call type and Caller ID information (if available), and the LED blinks.

1. Pick up the handset or press the **SPEAKERPHONE** key. Press **CLR** to send the call directly to voicemail.
2. Begin talking.

Receive a Call When Caller ID is Activated

The Caller ID feature displays the caller's number when the SX5 rings. If the caller's name and number are stored together in the SX5 phonebook, the caller's name and number will be displayed. Contact your service provider to activate this feature.

NOTE: If there are missed calls (calls not answered), "**MISSED CALLS**" will be displayed with the number of calls missed. See the *Call Logs* section of this manual for more information.

Ending Calls

Hang up the phone by either placing the handset back onto the SX5 cradle or press the **SPEAKERPHONE** key if using the speakerphone.

In-Call Functions

Mute a Call

1. While in a call, press the **MUTE** key. A notification will display in the upper right corner of the LCD screen.
2. Press the **MUTE** key again to un-mute the microphone.

Adjust Volume

1. While in a call, press the **Volume** keys to raise or lower the handset/speakerphone volume.

Call Waiting

The **FLASH** key is used to answer call waiting and to switch between calls. Contact your service provider regarding the availability of the call waiting feature.

3-Way Calling

Contact your service provider regarding the availability of 3-way calling.

To perform a 3-way call:

1. Make the first call and wait until it connects.
2. After the first call is connected, dial the second number.
3. Press the **FLASH** key. This connects the second call and puts the first call on hold.
4. Wait for the second call to connect.
5. After you are connected to the second call, *Press* **FLASH**, which then connects the first call and completes the 3-way call.

Voicemail Access

Contact your service provider regarding the availability of voicemail.

1. *Press* **MSG**.
2. *Select* **1: Voice Mail**.
3. To listen to your voicemail, *Select* **1: Listen**.
4. If you have deleted all your messages and the message indicator does not go away after an hour, *Press* **2: Clr Msg Ind**.

Reading Text (SMS) Messages

When you receive a new text message, the envelope icon will appear on the display. To access messages:

1. *Press* **MSG**.
2. *Select* **2: Read Messages**.
3. Use the arrow keys to select the desired message. *Press* **STO** to read it.
4. Once you have read the message, you can do the following:

- 1: Delete**
- 2: Forward**
- 3: Reply**

[FLASH]: Call : dials the callback number in the message (if available)

Sending a Text Message

1. *Press* **MSG**.
2. *Select* **3: Create Message**.
3. *Select* **1: New Message**.
2: Sent Messages
4. Enter the destination phone number.
5. Type the message using the keypad or a keyboard connected to the phone. *Press* **STO** when done writing the message.

CLR: delete previous character

and down arrow key: forward one character

***** and up arrow key: backwards one character

MSG key: switch between uppercase, lowercase, and special characters

6. Enter the callback number that you want included with the message and *Press* **STO**. If you do not want a callback number, *Press* **STO**.
7. Select the message priority as Normal or Urgent.
8. Select "Send & Save" if you want to send the message immediately and save a copy to the Sent Messages folder.
Select "Send" if you want to send the message immediately without saving a copy.

Delete All Text Messages

1. *Press* **MSG**
2. *Select* **4: Delete Messages**.
3. Use the up and down arrows to select whether you would like to delete all messages, then *Press* **STO**.

NOTE: that individual messages can be deleted from the "Read Messages" option.

Message Lock

Message lock password protects the Voice Mail menu. If the message lock is active and you press the MSG key from the idle screen, the unit will prompt you for a password which is your lock code (default is 0000).

1. Press **MSG**
2. Select **5: Message Options**
3. Select **1: Message Lock**
4. Select the desired option using the up/down arrows and Press **STO** to save.

Message Alert

Message Alert turns on and off the message alert tone. When off, the envelope icon will still be displayed on the LCD but there is no alert tone.

1. Press **MSG**
 2. Select **5: Message Options**
 3. Select **2: Message Alert**
- Select the desired option using the up/down arrows and Press **STO** to save.

PHONE BOOK

The SX5 can be programmed to store frequently called numbers via an electronic phone book. The SX5 phone book can hold up to 99 entries.

Speed Dial by Location

A phone book entry can be speed dialed as follows: For entries 1-9, lift the handset and hold down the location number until it dials. For entries 10-99, lift the handset, press the first digit and then hold down the 2nd digit until it dials.

Searching the Phone Book and Dialing a Phone Book Entry

1. Start by pressing **MENU**
2. *Select 1:* **Phone Book**
3. *Select 1:* **View**

There are 3 options for conducting a search of the electronic phone book:

1. **All** - displays all entries from location **01 through 99**

Use Up and down arrows to select the location and *Press* **STO** to select it.

2. **Name** - enter in the characters to search for and *Press* **STO** to search.

3. **Location** - enter the 2-digit location **01 through 99**

To dial the selected entry, *Press* **FLASH**. Then pick up the handset if desired.

Adding an Entry into the Phone Book

1. Enter the phone number to be stored.
2. *Press* **STO**
3. Enter the name to be stored. *Press* a key multiple times to display the desired letter on that key.

*** key = backspace**

key = space

MSG key = shift between UPPERCASE and lowercase letters

4. When the unit displays, "*Location auto=XX*", *Press* **STO** or enter the desired location number.

NOTE: You can also add an entry to the phonebook through the phonebook add option

Edit a Phone Book Entry

1. Start by pressing **MENU**
2. *Select 1:* **Phone Book**
3. *Select 3:* **Edit**

There are 3 options for editing an entry:

1. **All** - displays all entries from location **01 through 99**

Use *Up and down* arrows to select the location and *Press STO* to select it.

2. **Name** - enter in the characters to search for and *Press STO* to search.

3. **Location** - enter the 2-digit location **01 through 99**

Erase a Phone Book Entry

1. Start by pressing **MENU**
2. *Select 1:* **Phone Book**
3. *Select 4:* **Erase**

There are 3 options for erasing an entry:

1. **All** - displays all entries from location **01 through 99**

Use *Up and down* arrows to select the location and *Press STO* to select it.

2. **Name** - enter in the characters to search for and *Press STO* to search.

3. **Location** - enter the 2-digit location **01 through 99**

CALL LOGS

The SX5 saves a log of the last 10 missed, outgoing, and incoming calls.

View Missed Calls

1. Start by pressing **MENU**
2. *Select 2:* **Call Logs**
3. *Select 1:* **Missed**
4. Use the up and down arrows to select the desired call and *Press STO* to view it.

To dial the selected entry, *Press FLASH*. Then pick up the handset if desired.

View Outgoing Calls

1. Start by pressing **MENU**
2. *Select 2: Call Logs*
3. *Select 2: Outgoing*
4. Use the up and down arrows to select the desired call and *Press STO* to view it.

To dial the selected entry, *Press FLASH*. Then pick up the handset if desired.

View Incoming Calls

1. Start by pressing **MENU**
2. *Select 2: Call Logs*
3. *Select 3: Incoming*
4. Use the up and down arrows to select the desired call and *Press STO* to view it.

To dial the selected entry, *Press FLASH*. Then pick up the handset if desired.

Erase All Call Logs

1. Start by pressing **MENU**
2. *Select 2: Call Logs*
3. *Select 4: Erase logs*
4. *Press STO* to erase the logs.

View Last Call Time

1. Start by pressing **MENU**
2. *Select 2: Call Logs*
3. *Select 5: Call Time*

This displays the duration of the previous call.

View Total Air Time

1. Start by pressing **MENU**
2. *Select 2: Call Logs*
3. *Select 6: Air Time*

This displays the total airtime that the phone has used since the last time it was cleared.

This is a calculation performed by the phone and may be different than the network's calculation.

Clear Air Time

1. Start by pressing **MENU**
2. **Select 2: Call Logs**
3. **Select 7: Clear Air Time**

This option will clear the phone's memory of how much airtime has been used.

TIME / ALARM

The SX5 allows you to set an alarm clock that can be used one time or for every day.

Alarm

1. Start by pressing **MENU**
2. **Select 3: Time / Alarm**
3. **Select 1: Alarm**

Time Format

1. Start by pressing **MENU**
2. **Select 3: Time / Alarm**
3. **Select 2: Time Format**

This allows you to set the time format to be 12-hour or 24-hour format.

Note: The current time is set by the network and therefore cannot be set on the phone.

Date Format (option 3)

1. Start by pressing **MENU**
2. **Select 3: Time / Alarm**
3. **Select 3: Date Format**

This allows you to set the date format to be **MM/DD** or **DD/MM**.

RING / ALERT

The SX5 is capable of supporting multiple ring tones and types of alerts. To adjust these settings, follow these instructions.

Ring Type

1. Start by pressing **MENU**
2. *Select 4: Ring / Alert*
3. *Select 1: Ring Type*
4. *Select the desired option and Press **STO** to save.*

There are 2 options for ring type:

1. **Sound + LED**
2. **LED (silent)**

Ring Tone

1. Start by pressing **MENU**
2. *Select 4: Ring/Alert*
3. *Select 2: Ring Tone*
4. Use the *up / down* arrows to select the desired ring tone and *Press **STO** to save.*

Ring Volume

1. Start by pressing **MENU**
2. *Select 4: Ring/Alert*
3. *Select 3: Ring Volume*
4. Adjust with *up / down* arrows and *Press **STO** to save.*

One Minute Alert

The 1-minute alert beep alerts the user after every minute during a call.

1. Start by pressing **MENU**.
2. *Select 4: Ring/Alert*
3. *Select 4: 1 Min Alert*
4. *Select **ON** or **OFF** and Press **STO**.*

Service Alert

The Service Alert is an alert that sounds when entering or leaving a service area.

1. Start by pressing **MENU**.
2. *Select 4: Ring / Alert*
3. *Select 5: Svc Alert*
4. *Select the desired option and Press **STO** to save.*

Alarm Tone

The alarm tone is the sound that the alarm clock makes when it rings.

1. Start by pressing **MENU**.
2. *Select 4: Ring / Alert*
3. *Select 6: Alarm Tone*
4. Use the *up / down* arrows to select the desired ring tone and *Press **STO** to save.*

PHONE SETTINGS

Banner

The banner is the text on the screen shown when the phone is not in use. This can be used to personalize your phone.

1. Start by pressing **MENU**.
2. *Select 5: Phone Settings.*
3. *Select 1: Banner.*

My Phone # (display only)

1. Start by pressing **MENU**.
2. *Select 5: Phone Settings.*
3. *Select 2: My Phone #.*

DTMF Length

Some applications may require changing the DTMF Length.

1. Start by pressing **MENU**.
2. *Select 5: Phone Settings.*
3. *Select 3: DTMF Length.*
4. *Select the desired option and Press STO to save.*

Key Volume

The key volume is the loudness of the tones generated when you press the phone's keys.

1. Start by pressing **MENU**.
2. *Select 5: Phone Settings.*
3. *Select 4: Key Volume.*
4. *Select the desired setting and Press STO to save.*

Auto Send Delay

The auto send delay is the amount of time the unit waits after you have stopped entering digits, before dialing the number.

1. Start by pressing **MENU**.
2. *Select 5: Phone Settings.*
3. *Select 5: Auto SND Delay.*
4. *Enter the desired setting and Press STO to save.*

Frequently Dialed Number

If you dial a phone number twice and stay connected for at least 15 seconds, the unit will remember that phone number and automatically send it without delay. This feature may be enabled or disabled.

1. Start by pressing **MENU**.
2. *Select 5: Phone Settings.*
3. *Select 6: Freq Dial Num.*
4. *Select the desired setting and Press STO to save.*

Change Language Displayed On LCD

The SX5 is capable of displaying multiple languages on the LCD screen.

1. Start by pressing **MENU**.
2. *Select 5: Phone Settings.*
3. *Select 7: Language.*
4. *Select the desired setting and Press STO to save.*

Dial Tone Type

1. Start by pressing **MENU**.
2. *Select 5: Phone Settings.*
3. *Select 8: Dial Tone Type.*
4. *Select the desired setting and press STO to save.*
 1. **North America (low 350 Hz, high 440 Hz)**
 2. **Latin America (low 425 Hz, high 425 Hz)**
 3. **East Europe (low 425 Hz, high 425 Hz)**
 4. **China (low 450 Hz, high 450 Hz)**
 5. **Nicaragua (low 450 Hz, high 450 Hz)**
 6. **India (low 375.5 Hz, high 412.5 Hz)**

LCD Contrast

1. Start by pressing **MENU**.
2. *Select 5: Phone Settings.*
3. *Select 9: LCD Contrast*
4. *Select the desired setting and Press STO to save.*

DATA SETTINGS

Data Port Type

1. Start by pressing **MENU**.
2. *Select 6: Data Settings.*
3. *Select 1: Data Port Type.*
4. *Select the data cable being used and Press STO to save.*

Baud Rate

Set the baud rate appropriate for the application. PC fax uses 19,200. For 1X or circuit switched data, use 115,200. This is the communication speed between the computer and SX5; data transfer rates will be much slower.

1. Start by pressing **MENU**.
2. *Select 6: Data Settings.*
3. *Select 2: Baud Rate.*
4. *Select the desired baud rate and Press STO to save.*

Self Test Cycle

The unit will perform a periodic self test to ensure the proper operation of the phone. The default setting is 180 minutes (3 hours).

1. Start by pressing **MENU**.
2. *Select 6: Data Settings.*
3. *Select 3: Self Test cycle*
4. *Select between 0 and 65535 minutes and Press STO to save.*

RX Data Mode

To receive data, you must set the RX data mode setting.

1. Start by pressing **MENU**.
2. *Select 6: Data Settings.*
3. *Select 4: RX Data Mode.*
4. *Select the desired setting and Press STO to save.*

TTY (Text Telephone for the Hearing Impaired)

To use a TTY device with the SX5, a Telular SX5 data cable is required.

1. Start by pressing **MENU**.
2. *Select 6: Data Settings.*
3. *Select 5: TTY*
4. *Select the desired setting and Press STO to save.*
 1. **TTY Off**
 2. **TTY Only**
 3. **TTY VCO (TTY + talk)**
 4. **TTY HCO (TTY + hear)**

SECURITY

New Lock Code

The lock code is a 4-digit password used to prevent unauthorized access to the phone. This setting will allow you to change it. The default lock code is **0000**.

1. Start by pressing **MENU**.
2. *Select 7: Security.*
3. *Select 1: New Lock Code*

Restrict Outgoing Calls

1. Start by pressing **MENU**.
2. *Select 7: Security.*
3. *Select 2: Restrict.*
4. *Select the desired option and Press STO to save.*

Voice Privacy

The cellular CDMA network offers inherent voice privacy. Check with your service provider for the availability of enhanced voice privacy mode. If Enhanced is selected, the phone will request Enhanced Voice Privacy and a "P" will be shown on the display if Enhanced Voice Privacy has been granted by the network.

1. Start by pressing **MENU**.
2. *Select 7: Security.*
3. *Select 3: Voice Privacy.*
4. *Select the desired option and Press STO to save.*

RUIM CHV1 (RUIM Models Only)

If your SX5 requires an RUIM, this setting allows you to enable, disable or change its PIN, also called the CHV1 (Card Holder Verification 1).

This menu option is not available if your SX5 is bonded to a RUIM.

1. Start by pressing **MENU**.
2. *Select 7: Security.*
3. *Select 4: RUIM CHV1.*
4. *Select the desired option and Press STO.*
5. Enter the SX5's PIN.
6. If you are changing the PIN, enter the new PIN.

Auto Lock

The Auto Lock setting determines whether the phone will automatically lock. This would require you to enter your lock code before being able to access the phone.

1. Start by pressing **MENU**.
2. *Select 7: Security.*
3. *Select 4: Auto Lock (5: Auto Lock on RUIM Models).*
4. *Select the desired option and Press STO to save.*

User Defaults

This setting is used to reset the SX5's settings to the user default values.

1. Start by pressing **MENU**.
2. *Select 7: Data Settings.*
3. *Select 5: User Defaults (6: User Defaults on RUIM Models).*
4. *Select RESET and Press STO to save.*

Software Version Information

1. Start by pressing **MENU**.
2. *Select 7: Security.*
3. *Select 6: SW Version Info (7: SW Version Info on RUIM Models).*

WINDOWS XP/WINDOWS 2000 SETUP

To configure a Windows XP/Windows 2000 computer and SX5 to work together, follow these steps.

1. Connect your computer and the SX5 with a Telular USB cable (part #1L01A043 or 81025901) or serial cable (part #1L01A042 or 81025801).
2. If you are using a USB cable, install the Telular USB drivers from the included CD.
3. Set the SX5's data port type (**MENU > 6: Data Settings > 1: Data Port Type**) and set its baud rate (**MENU > 6: Data Settings > 2: Baud Rate**) to 115200 (19200 when faxing)
4. Install the SX5 as a new modem by opening the Start -> Settings -> Control Panel -> Phone and Modem Options -> Modems Tab

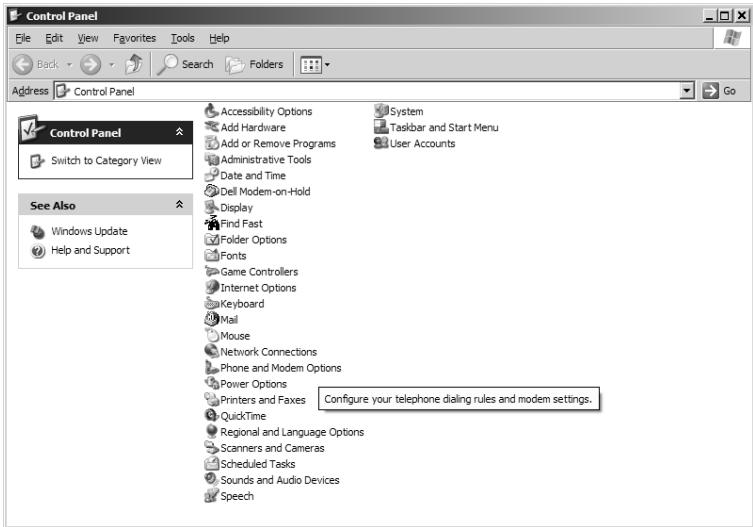

5. Click on "Add..."



6. Click on "Don't detect my modem, I will select it from a list".

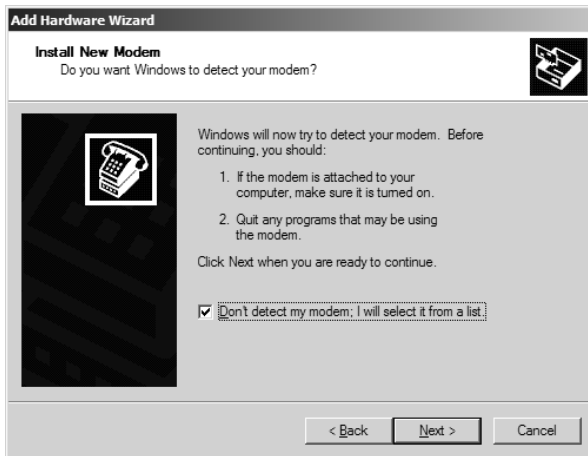

7. Select "Standard 19200 bps Modem".

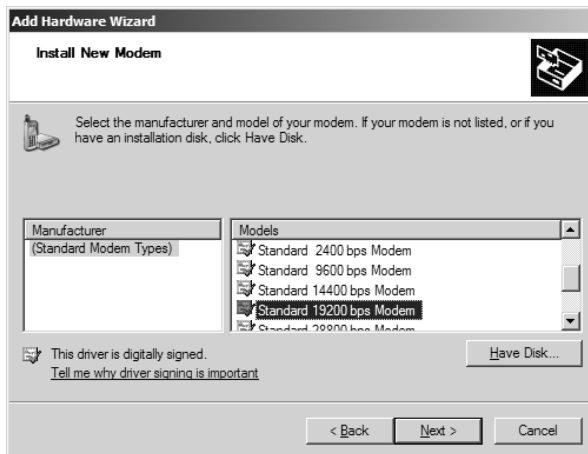

8. Select the COM port to use (if a COM port does not display, all COM ports are currently allocated).

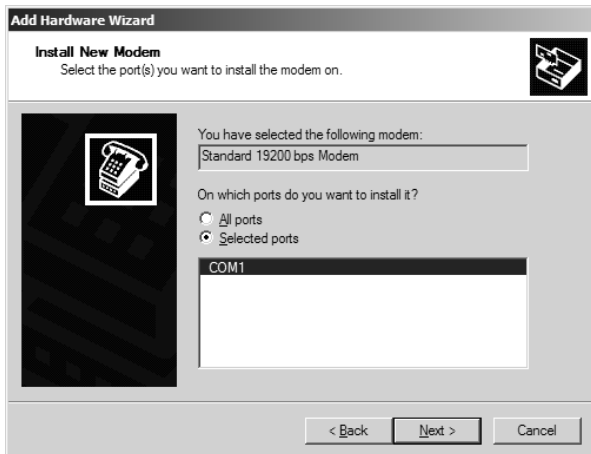

9. Click Finish.



10. Configure the SX5 modem interface using the Start -> Settings -> Control Panel -> Phone and Modem Options" -> Modems Tab
11. Select the 19200 bps Modem -> Click on Properties

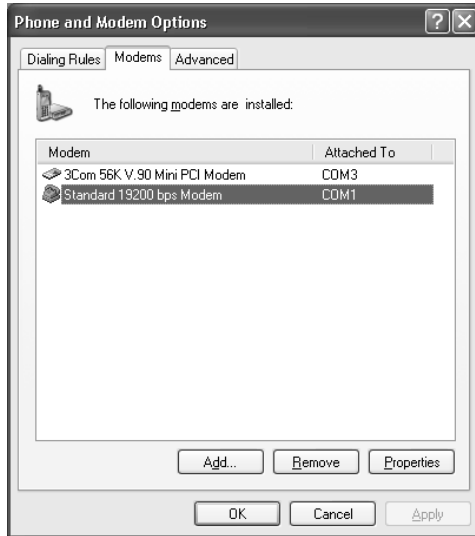

12. Select the Modem tab.
13. Change the Maximum port speed to 115200 (19200 when faxing) and click OK.

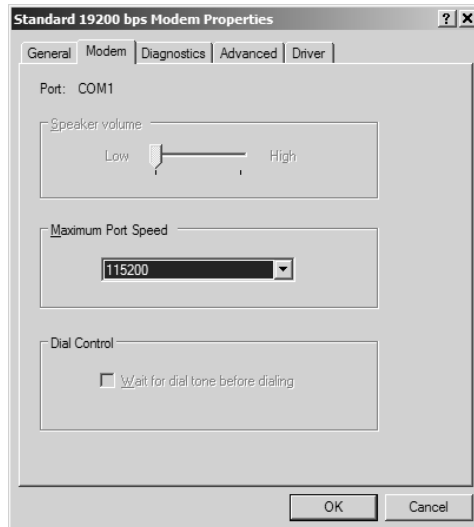

14. Configure the USB or Serial port using the Control Panel -> System ->Hardware -> Device Manager -> Ports Tab

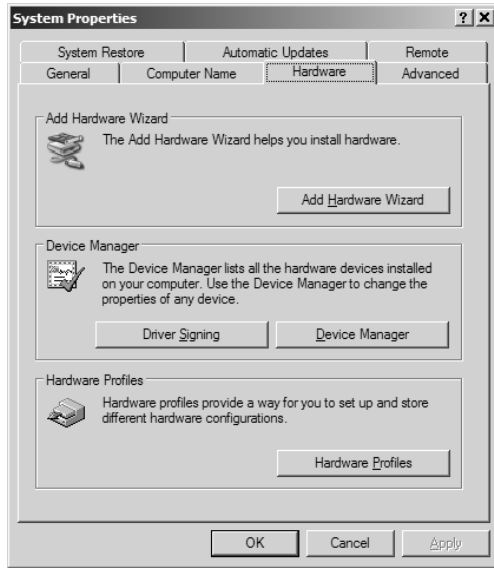

15. Select the port used for the SX5 and right click on it. Select "Properties" from the resulting pop-up menu.

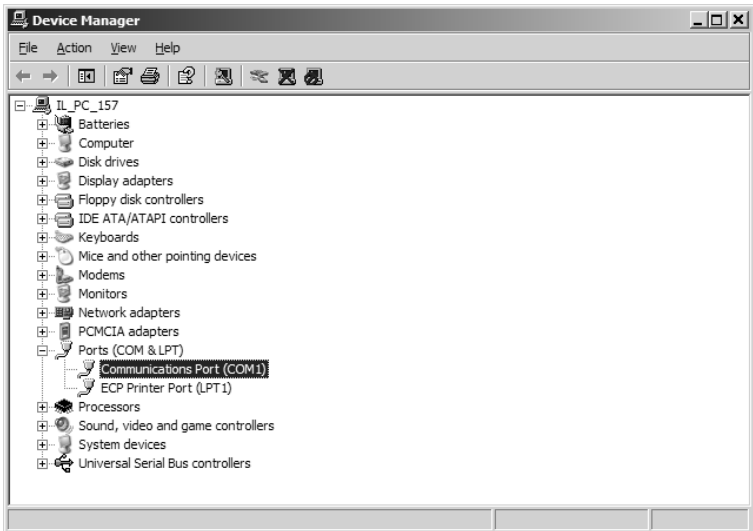

16. Click on the Port Settings tab.

17. Use these settings:

Bits per second: 115200 (19200 when faxing)

Data bits: 8

Parity: None

Stop bits: 1

Flow control: Hardware

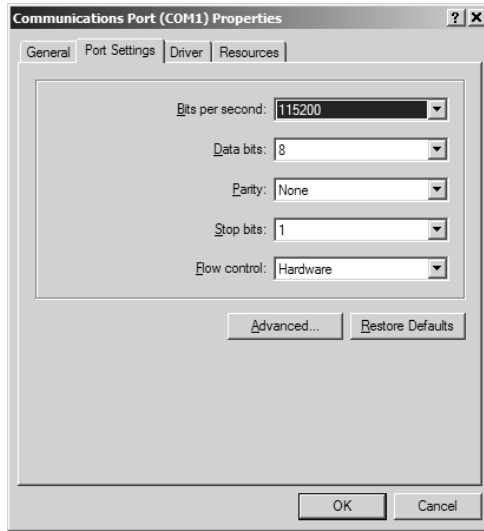

18. You may now proceed for transferring data and faxes by following the instructions in this manual. See **Sending/Receiving a PC Fax** (page 31), **Sending/Receiving 1X Data** (page 32) or **Sending/Receiving Circuit Switched Data** (page 33) for details.

WINDOWS 98 SETUP

To configure a Windows 98 computer and SX5 to work together, follow these steps.

1. Connect your computer and the SX5 with a Telular USB cable (part #1L01A043 or 81025901) or serial cable (part #1L01A042 or 81025801).
2. If you are using a USB cable, install the Telular USB drivers from the included CD.
3. Set the SX5's data port type (**MENU > 6: Data Settings > 1: Data Port Type**) and set its baud rate (**MENU > 6: Data Settings > 2: Baud Rate**) to 115200 (19200 when faxing)
4. Install the SX5 as a new modem by opening Start > Settings > Control Panel, then clicking on the "Modems" phone icon.



5. Select 'Standard 19200 bps Modem' and click on 'Properties'.



6. Select the appropriate COM port and Maximum speed of 115,200 bps for data and 19200 bps for PC Fax.

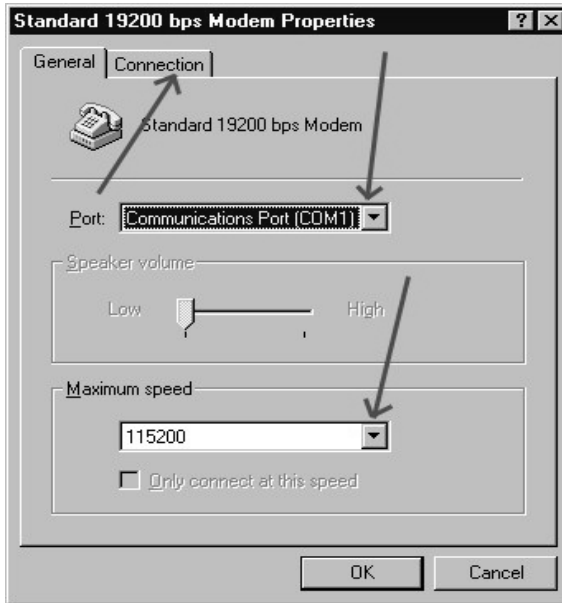

7. Select the Connection tab.

8. Set Connection Preferences to Data bits = 8, Parity = None and Stop bits = 1, then click "Advanced".

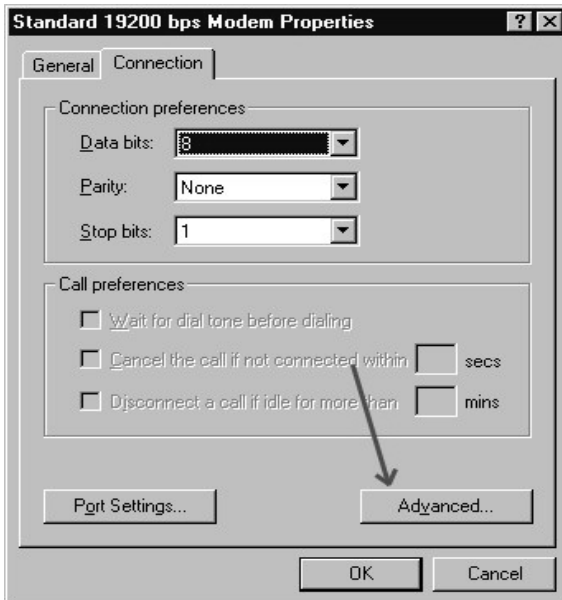

9. Check the box for 'Use Control Flow' and then click on 'Hardware (RTS/CTS)' and then select 'OK'.

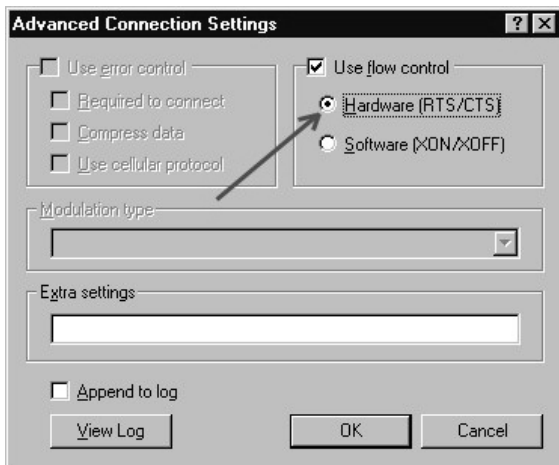

8. Click on 'OK'.

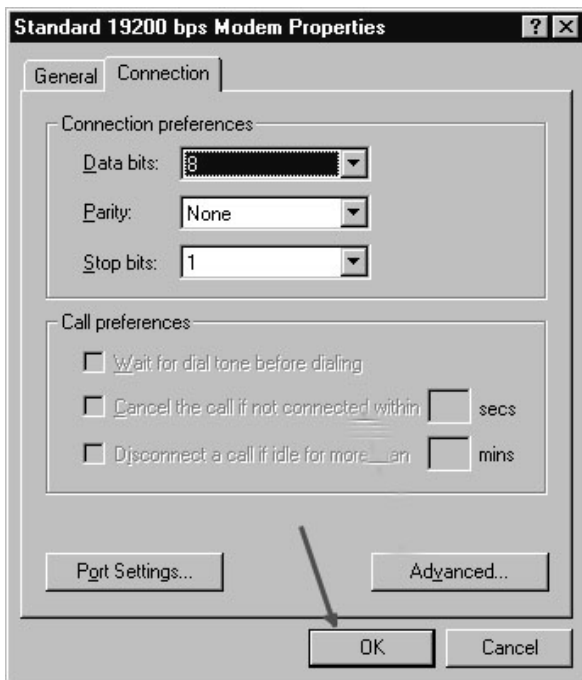

9. Click on 'Close'.



10. You may now proceed for transferring data and faxes by following the instructions in this manual. See **Sending/Receiving Faxes** (page 31), **Sending/Receiving 1X Data** (page 32) or **Sending/Receiving Circuit Switched Data** (page 33) for details.

SENDING/RECEIVING A PC FAX

A PC can send and receive faxes using the SX5. Your account with your service provider must support circuit switched data transfer for the SX5's PC fax function to work. Note that you must use a PC to send faxes with the SX5; a fax machine connected directly to the SX5 will not work.

Choose the SX5 Fax Port

1. Start by pressing **MENU**.
2. *Select 6: Data Settings.*
3. *Select 1: Data Port Map.*
4. *Select RS-232 or USB and Press STO to save.*

Set the SX5 Baud Rate for PC Fax

1. Start by pressing **MENU**.
2. *Select 6: Data Settings.*
3. *Select 2: Baud Rate.*
4. *Select 19200 and Press STO to save.*

Set Your Computer's Port and Modem Speeds for PC Fax

To send or receive faxes, you need to set the port and modem speeds your computer uses for the SX5 to 19200 bps. See **Windows XP/2000 Setup** (pages 24 & 26) or **Windows 98 Setup** (page 28) for details.

To Send a PC Fax

Use your computer's fax software to dial the receiving fax machine's number. Whenever your software asks you what modem to use, select the Standard 19200 Modem.

To Receive a PC Fax

First configure your SX5 to recognize incoming faxes.

1. Start by pressing **MENU**.
2. *Select 6: Data Settings.*
3. *Select 4: RX Data Mode.*
4. *Select Fax Next Call or Fax Only and Press STO to save.*

If **Fax Only** is selected, your SX5 will treat all incoming calls as if they were Class 2 faxes. To return your SX5 to normal operation, choose **Voice Always** from the **RX Data Mode** Menu.

If **Fax Next** is selected, your SX5 will treat the next incoming call as a Class 2 fax, then return to normal operation.

Once your SX5 is configured to recognize incoming faxes, use your computer's fax software. Whenever your software asks you what modem to use, select the Standard 19200 Modem.

Note: Taking the SX5 off hook while sending or receiving a fax will end the transfer.

SENDING/RECEIVING 1X DATA

Check with your service provider to see if your account supports 1X data transfer.

Choose the Port the SX5 Will Use for 1X Data

1. Start by pressing **MENU**.
2. *Select 6: Data Settings.*
3. *Select 1: Data Port Map.*
4. *Select RS-232 or USB and Press STO to save.*

Set the SX5's Baud Rate for 1X Data

1. Start by pressing **MENU**.
2. *Select 6: Data Settings.*
3. *Select 4: Baud Rate.*
4. *Select 115200 and Press STO to save. This is the communication speed between the computer and SX5; data transfer rates will be much slower.*

Set Your Computer's Port and Modem Speeds for 1X Data

To send or receive circuit switched data, you need to set the port and modem speeds your computer uses for the SX5 to 115200 bps. See **Windows XP/2000 Setup** (pages 24 & 26) or **Windows 98 Setup** (page 28) for details. This is the communication speed between the computer and SX5; data transfer rates will be much slower.

To Send or Receive 1X Data

Follow your service provider's directions for sending and receiving 1X data. Whenever your software asks you what modem to use, select the Standard 19200 Modem.

For Windows XP and Windows 2000, you can start by opening Control Panel > Network and Dial Up Connections, then double-clicking on "Make New Connection" to start the Network Connection Wizard.

For Windows 98, you can start by running "Dial-Up Networking" and double-clicking on "Make New Connection".

Note: Taking the SX5 off hook during a data session will end the session.

SENDING/RECEIVING CIRCUIT SWITCHED DATA

Check with your service provider to see if your account supports circuit switched data transfer.

Choose the Port the SX5 Will Use for Circuit Switched Data

1. Start by pressing **MENU**.
2. *Select 6: Data Settings.*
3. *Select 1: Data Port Map.*
4. *Select RS-232 or USB and Press STO to save.*

Some service providers do not support the use of the USB port for circuit switched data. If you have problems with circuit switched data when using the USB port, try using the serial port instead.

Set the SX5's Baud Rate for Circuit Switched Data

1. Start by pressing **MENU**.
2. *Select 6: Data Settings.*
3. *Select 4: Baud Rate.*
4. *Select 115200 and Press STO to save. This is the communication speed between the computer and SX5; data transfer rates will be much slower.*

Set Your Computer's Port and Modem Speeds for Circuit Switched Data

To send or receive circuit switched data, you need to set the port and modem speeds your computer uses for the SX5 to 115200 bps. See **Windows XP/2000 Setup** (pages 24 & 26) or **Windows 98 Setup** (page 28) for details. This is the communication speed between the computer and SX5; data transfer rates will be much slower.

To Send Circuit Switched Data

Follow your service provider's directions for sending circuit switched data. Whenever your software asks you what modem to use, select the Standard 19200 Modem.

For Windows XP and Windows 2000, you can start by opening Control Panel > Network and Dial Up Connections, then double-clicking on "Make New Connection" to start the Network Connection Wizard.

For Windows 98, you can start by running "Dial-Up Networking" and double-clicking on "Make New Connection".

To Receive Circuit Switched Data

First configure your SX5 to recognize incoming circuit switched data.

1. Start by pressing **MENU**.
2. *Select 6: Data Settings.*
3. *Select 4: RX Data Mode.*
4. *Select Fax Next Call or Fax Only and Press STO to save.*

If **Fax Only** is selected, your SX5 will treat all incoming calls as if they were Class 2 faxes. To return your SX5 to normal operation, choose **Voice Always** from the **RX Data Mode** Menu.

If **Fax Next** is selected, your SX5 will treat the next incoming call as a Class 2 fax, then return to normal operation.

Once your SX5 is configured to recognize incoming circuit switched data, follow your service provider's directions for receiving circuit switched data using your software. Whenever your software asks you what modem to use, select the Standard 19200 Modem.

For Windows XP and Windows 2000, you can start by opening Control Panel > Network and Dial Up Connections, then double-clicking on "Make New Connection" to start the Network Connection Wizard.

For Windows 98, you can start by running "Dial-Up Networking" and double-clicking on "Make New Connection".

Note: Taking the SX5 off hook during a data session will end the session.

SX5 TROUBLESHOOTING

Telephone Service is Not Working (Cannot make or receive calls)

- Make sure the SX5 powered on properly.
- Make sure any equipment that is externally connected to the SX5 is correctly connected.
- Test any externally connected equipment on a known system to verify operation.
- Do you have the antenna connected? If not, connect the antenna.
- Is service established with a service provider? If so, is there any service provider issue. Your service may be disconnected or not functioning properly. Contact your service provider if you think this is the problem.

Unable to Receive Calls

- Is the handset on the cradle? If not, place the handset on the cradle and try again.
- Is the SX5 making a loud repetitive tone (ROH)? Then either speakerphone or the handset is off hook. Hang-up and try again.

Unable to Make Calls

- If you do not hear standard dial tone when off hook, then your service has a problem. Contact your service provider if you think this is the problem.

Unable to Send or Receive Circuit Switched Data (CSD) Calls

- Is your computer connected to the data port of the SX5? If not, connect the computer with an appropriate data cable.
- Do you have CSD service on your wireless account? Contact your service provider for information.
- Is your computer configured properly to access data service with the SX5? Please reference the data sections of this manual for proper setup.

Moisture or Ventilation Problems

- Is moisture forming on or around the SX5? Remove any moisture with a clean dry towel and move the unit to a well ventilated area. Review the Temperature and Environment section of this manual for more information.

No Power

- Is the power supply connected to the unit? Make sure power is available and that the power supply is properly connected to the SX5.
- The power supply is connected but the unit still has no power. Make sure the circuit is functioning to the power supply. Check breakers & contact your power company. Power may be off at location.

CONFORMANCE STATEMENTS

FCC Part 15 Class B Compliance

This Phonecell® SX5 model has been tested and found to comply with the limits for a Class B digital device, pursuant to Part 15 of the FCC rules. Changes or modifications not expressly approved by Telular Corporation will void your authority to operate the equipment per FCC part 15 paragraph 15.21. These limits are designed to provide reasonable protection against harmful interference in a residential installation. This equipment generates, uses and can radiate radio frequency energy and, if not installed and used in accordance with the instructions, may cause harmful interference to radio communications. However, there is no guarantee that interference will not occur in a particular installation. If this equipment does cause harmful interference to radio or television reception, which can be determined by turning the equipment OFF and ON, the user is encouraged to try to correct the interference by one or more of the following measures:

- Reorient or relocate the antenna.
- Increase the separation between the equipment and the terminal.
- Connect the equipment into an outlet on a circuit different from that to which the terminal is connected.
- Consult your Authorized Telular Distributor or an experienced radio/TV technician for help.

SAFETY INFORMATION

The Phonecell® SX5 functions as both a radio transmitter and receiver. When it is ON, the SX5 receives and sends out radio frequency (RF) energy. The SX5 CDMA unit operates in the frequency ranges of 824 MHz to 894 MHz and / or 1850 MHz to 1910 MHz. When you use the SX5, the cellular system handling your call controls the power level at which the unit transmits.

Exposure to RF (Radio Frequency) Energy

In 1991, the Institute of Electrical and Electronics Engineers (IEEE), and in 1992, the American National Standards Institute (ANSI), updated the 1982 ANSI Standard for safety levels with respect to human exposure to RF energy. After reviewing the available body of research, more than 120 scientists, engineers and physicians from universities, government health agencies and industry developed this updated Standard. In March, 1993, the U.S. Federal Communications Commission (FCC) proposed the adoption of this updated Standard.

The design of your Telular Phonecell® SX5 complies with this updated Standard. Of course, if you want to limit RF exposure even further than the updated ANSI Standard, you may choose to control the duration of your calls and operate your phone in the most power-efficient manner.

Safe Operation Requirement

The Phonecell® SX5 must be either wall mounted or desk mounted and should not be operated when any person is within 203 mm (8 inches) of the antenna.

Temperature and Environment

Operating Temperature: From -10°C to +50°C ; Up to 95% relative humidity (non-condensing).

Storage Temperature: From -40°C to +60°C; Up to 95% relative humidity (non-condensing).

Antenna Care and Replacement

Do not use the Phonecell® SX5 with a damaged antenna. If a damaged antenna comes into contact with the skin, a minor burn may result. Have your antenna replaced by a qualified technician immediately. Use only a manufacturer-approved antenna. Unauthorized antennas, modifications, or attachments could damage the Phonecell® SX5.

Driving

Check the laws and regulations on the use of cellular products in the areas where you drive. Some jurisdictions prohibit your using a cellular device while driving a vehicle. Even if your jurisdiction does not have such a law, we strongly suggest that, for safety reasons, the driver use extreme caution when operating the cellular device while the vehicle is in motion. Always obey the law.

Electronic Devices

Most modern electronic equipment is shielded from RF energy. However, RF energy from cellular devices may affect inadequately shielded electronic equipment.

RF energy may affect improperly installed or inadequately shielded electronic operating and entertainment systems in motor vehicles. Check with the manufacturer or its representative to determine if these systems are adequately shielded from external RF energy. You should also check with the manufacturer of any equipment that has been added to your vehicle.

Consult the manufacturer of any personal medical devices (such as pacemakers, hearing aids, etc.) to determine if they are adequately shielded from external RF energy.

Turn your Phonecell® SX5 OFF in health care facilities when any regulations posted in the areas instruct you to do so. Hospitals or health care facilities may be using equipment that could be sensitive to external RF energy.

Aircraft

Turn OFF your Phonecell® SX5 before boarding any aircraft.

- Use it on the ground only with crew permission.
- Do not use it in the air.

To prevent possible interference with aircraft systems, U.S. Federal Aviation Administration (FAA) regulations require you to have permission from a crew member to use your cellular phone (or any other cellular product) while the plane is on the ground. To prevent interference with aircraft systems, FCC regulations prohibit using your cellular device while the plane is in the air.

Children

Do not allow children to play with your Phonecell® SX5 to prevent damage to the unit.

Blasting Areas

Construction crews often use remote control RF devices to set off explosives. Therefore, to avoid interfering with blasting operations, turn your Phonecell® SX5 OFF when in a "blasting area" or in areas posted: "Turn off two-way radio."

Potentially Explosive Atmospheres

Turn your Phonecell® SX5 OFF when in any area with a potentially explosive atmosphere. It is rare, but your Phonecell® SX5 or its accessories could generate sparks. Sparks in such areas could cause an explosion or fire resulting in bodily injury or even death.

Areas with a potentially explosive atmosphere are often, but not always, clearly marked. They include fueling areas such as gas stations; below deck on boats; fuel or chemical transfer or storage facilities; areas where the air contains chemicals or particles, such as grain, dust, or metal powders; and any other area where you would normally be advised to turn off your vehicle engine.

Do not transport or store flammable gas, liquid or explosives in the area of your Phonecell® SX5 or accessories.

Vehicles using liquefied petroleum gas (such as propane or butane) must comply with the National Fire Protection Standard (FPA-58). For a copy of this standard, contact the National Fire Protection Association, One Batterymarch Park, Quincy, MA 02269, Attn: Publications Sales Division.

WARRANTY

I. WHAT THIS WARRANTY COVERS AND FOR HOW LONG:

TELULAR CORPORATION ("Telular") warrants to a distributor Buyer, or to a customer only if the customer is a Buyer directly from Telular, that the Products (including accessories) shall comply with the applicable Specifications and shall be free from defects in material and workmanship under normal use and service for a period of fifteen (15) months from date of shipment from Telular. Telular, at its option, shall at no charge either repair, replace or refund the purchase price of the Product during the warranty period, provided it is returned by Buyer in accordance with the terms of this warranty to the Telular designated repair center. Repair or replacement, at Telular's option, may include the replacement of parts, boards or Products with functionally equivalent reconditioned items. Repaired and replacement items are warranted for the balance of the original warranty period. All replaced items shall become the property of Telular. **SUCH ACTION ON THE PART OF TELULAR SHALL BE THE FULL EXTENT OF TELULAR'S LIABILITY HERE-UNDER, AND BUYERS EXCLUSIVE REMEDY.** Buyer shall be responsible for all costs and expenses incurred by Buyer including without limitation any handling, labor or transportation charges. **OTHER THAN AFORESAID, THIS EXPRESS WARRANTY IS EXTENDED BY TELULAR TO BUYER ONLY AND NOT TO BUYER'S CUSTOMERS OR USERS OF BUYER'S PRODUCTS.**

II. HOW TO OBTAIN WARRANTY SERVICE

Product covered under this warranty shall only be accepted from and returned to Buyer's designated repair center. Buyer's dealers, distributors, agents, and end users cannot submit items to Telular under this warranty. To receive warranty service an RMA number must first be obtained from Telular Technical Support. The defective or non-compliant Product should be sent by Buyer freight pre-paid to: Telular Corporation, 647 North Lakeview Parkway, Vernon Hills, IL 60061, USA or other designated location. The product must be packaged in the original carton and packing material or an equivalent package and must have the assigned RMA number clearly marked on the carton. Returned Product received without an RMA number will be returned to the sender.

III. WARRANTY CONDITIONS:

This is the complete warranty for the Products manufactured by Telular and sold to Buyer. Telular assumes no obligation or liability for additions or modifications to this warranty unless made in writing and signed by an officer of Telular. Unless made in separate written agreement between Telular and Buyer, Telular does not warrant the installation, field maintenance or service of the Products or parts.

TELULAR CANNOT BE RESPONSIBLE IN ANY WAY FOR ANY ANCILLARY EQUIPMENT NOT FURNISHED BY TELULAR WHICH IS ATTACHED TO OR USED IN CONNECTION WITH THE PRODUCTS OR FOR OPERATION OF THE PRODUCTS WITH ANY ANCILLARY EQUIPMENT AND ALL SUCH EQUIPMENT IS EXPRESSLY EXCLUDED FROM THIS WARRANTY. FURTHERMORE, TELULAR CANNOT BE RESPONSIBLE FOR ANY DAMAGE TO THE PRODUCTS RESULTING FROM THE USE OF ANCILLARY EQUIPMENT NOT FURNISHED BY TELULAR FOR USE WITH THE PRODUCTS.

WHEN THE PRODUCT IS USED IN CONJUNCTION WITH ANCILLARY OR PERIPHERAL EQUIPMENT NOT MANUFACTURED BY TELULAR, TELULAR DOES NOT WARRANT THE OPERATION OF THE PRODUCT/PERIPHERAL COMBINATION, AND TELULAR SHALL HONOR NO WARRANTY CLAIM WHERE THE PRODUCT IS USED IN SUCH A COMBINATION AND IT IS DETERMINED BY TELULAR THAT THERE IS NO FAULT WITH THE PRODUCT. TELULAR DISCLAIMS LIABILITY FOR RANGE, COVERAGE, AVAILABILITY, OR OPERATION OF THE CELLULAR SYSTEM WHICH IS PROVIDED BY THE CARRIER.

IV. WHAT THIS WARRANTY DOES NOT COVER:

(a) Subsequent upgrades and enhancements to the Product. (b) Defects, non-compliance or damage resulting from use of the Product in other than its normal and customary manner or environment. (c) Defects, noncompliance or damage from misuse, lightening, accident or neglect. (d) Defects, noncompliance or damage from improper testing, operation, maintenance, installation, adjustment, or any alteration or modification of any kind. (e) Product disassembled or repaired in such a manner as to adversely affect performance or prevent adequate inspection and testing to verify any warranty claim. (f) Product which has had the serial number removed or made illegible. (g) Defects, non-compliance or damage due to spills of food or liquid. (h) All plastic surfaces and all other externally exposed parts that are scratched or damaged due to cus-

tomers normal use. (i) Costs and expenses, including without limitation handling, labor and transportation, incurred in returning Product for warranty service to Telular's Repair Center. (j) Repair, programming or servicing by someone other than Telular.

V. GENERAL PROVISIONS:

THIS WARRANTY IS GIVEN IN LIEU OF ALL OTHER EXPRESS OR STATUTORY WARRANTIES. IMPLIED WARRANTIES, INCLUDING WITHOUT LIMITATION IMPLIED WARRANTIES OF MERCHANTABILITY, FITNESS FOR A PARTICULAR PURPOSE, TITLE, INFRINGEMENT, DELIVERY, NEGLIGENCE AND PERSONAL INJURY, ARE DISCLAIMED. FURTHER, AS THE CELLULAR CARRIER IS NOT CONTROLLED BY TELULAR, NO WARRANTY IS MADE AS TO COVERAGE, AVAILABILITY OR GRADE OF SERVICE PROVIDED BY THE CELLULAR CARRIER. IN NO EVENT SHALL TELULAR BE LIABLE FOR DAMAGES IN EXCESS OF THE PURCHASE PRICE OF THE PRODUCT, FOR ANY LOSS OF USE, LOSS OF TIME, INCONVENIENCE, COMMERCIAL LOSS, LOST PROFITS OR SAVINGS OR OTHER INCIDENTAL, SPECIAL OR CONSEQUENTIAL DAMAGES ARISING OUT OF THE USE OR INABILITY TO USE SUCH PRODUCT TO THE FULL EXTENT SUCH MAY BE DISCLAIMED BY LAW. SOME JURISDICTIONS DO NOT ALLOW THE EXCLUSION OR LIMITATIONS OF INCIDENTAL OR CONSEQUENTIAL DAMAGES OR LIMITATION ON HOW LONG AN IMPLIED WARRANTY LASTS.

VI. SOFTWARE PROVISIONS:

Laws in the United States and other countries preserve for Telular certain exclusive rights for copyrighted Telular software such as the exclusive rights to reproduce in copies and distribute copies of such Telular software. Telular software may be copied into, used in and redistributed with only the Product associated with such Telular software. No other use, including without limitation, disassembly of such Telular software or exercise of exclusive rights in such Telular software is permitted and Telular reserves all rights not expressly granted in this Limited Commercial Warranty.

Patents:

Telular Corporation products are protected and manufactured under one or more of the following U.S. patents and related international patents and patents pending relating thereto: 4,658,096; 4,737,975; 4,775,997; 4,868,519; 4,922,517; 5,134,651; 5,361,297; 5,469,494; 5,046,085; 5,715,296.

Trademarks:

Telular Corporation owns the following registered trademarks: TELULAR and design, TELULAR, CELJACK, MAXJACK, TELCEL, HEXAGON LOGO, PHONECELL, CELSERV, TELGUARD, CPX, and AXCELL.

"Licensed by QUALCOMM Incorporated under one or more of the following Patents:

4,901,307	5,490,165	5,056,109	5,504,773	5,101,501	5,778,338
5,506,865	5,109,390	5,511,073	5,228,054	5,535,239	5,710,784
5,267,261	5,544,196	5,267,262	5,568,483	5,337,338	5,659,569
5,600,754	5,414,796	5,657,420	5,416,797"		

NOTES

NOTES

NOTES



647 North Lakeview Parkway
Vernon Hills, Illinois 60061, USA
Tel: 847-247-9400 • Fax: 847-247-0021
E-mail: support@telular.com
<http://www.telular.com>

Free Manuals Download Website

<http://myh66.com>

<http://usermanuals.us>

<http://www.somanuals.com>

<http://www.4manuals.cc>

<http://www.manual-lib.com>

<http://www.404manual.com>

<http://www.luxmanual.com>

<http://aubethermostatmanual.com>

Golf course search by state

<http://golfingnear.com>

Email search by domain

<http://emailbydomain.com>

Auto manuals search

<http://auto.somanuals.com>

TV manuals search

<http://tv.somanuals.com>