

## 1 INTRODUCTION

### 1.1 FEATURES

- **Battery Fuel Gauge for 1-Series Li-Ion Applications**
- **Resides on System Main Board**
  - Works with Embedded or Removable Battery Packs
- **Two Varieties**
  - **bq27500:** Uses *PACK+*, *PACK-*, and *T* Battery Terminals
  - **bq27501:** Includes Battery Pack ID Resistor (*RID*) Terminal
- **Micro-Controller Peripheral Provides:**
  - **Accurate Battery Fuel Gauging**
  - **Internal Temperature Sensor for System Temperature Reporting**
  - **Battery Low Interrupt Warning**
  - **Battery Insertion Indicator**
  - **Battery ID Detection**
  - **96 bytes of Non-Volatile Scratch Pad FLASH**
- **Battery Fuel Gauge Based on Patented Impedance Track™ Technology**
  - **Models the Battery Discharge Curve for Accurate Time-to-Empty Predictions**
  - **Automatically Adjusts for Battery Aging, Battery Self Discharge, and Temperature/Rate Inefficiencies**
  - **Low Value Sense Resistor (10mΩ or Less)**
- **I<sup>2</sup>C™ Interface for Connection to System Micro-Controller Port**
- **12-Pin 2,5 mm × 4,0 mm SON Package**

### 1.2 APPLICATIONS

- **Smartphones**
- **PDA's**
- **Digital Still and Video Cameras**
- **Handheld Terminals**
- **MP3 or Multimedia Players**

### 1.3 DESCRIPTION

The Texas Instruments bq27500/01 System-Side Li-Ion Battery Fuel Gauge is a micro-controller peripheral that provides fuel gauging for single cell Li-Ion battery packs. The device requires little system micro-controller firmware development. The bq27500/01 resides on the system's main board, and manages an embedded battery (non-removable) or a removable battery pack.

The bq27500/01 uses the patented Impedance Track™ algorithm for fuel gauging, and provides information such as remaining battery capacity (mAh), state-of-charge (%), run-time to empty (min.), battery voltage (mV), and temperature (°C).

Battery fuel gauging with the bq27500 requires only *PACK+* (*P+*), *PACK-* (*P-*), and Thermistor (*T*) connections to a removable battery pack or embedded battery circuit. The bq27501 works with identification resistors in battery packs, to gauge batteries of different fundamental chemistries and/or significantly different rated capacities.

### TYPICAL APPLICATION

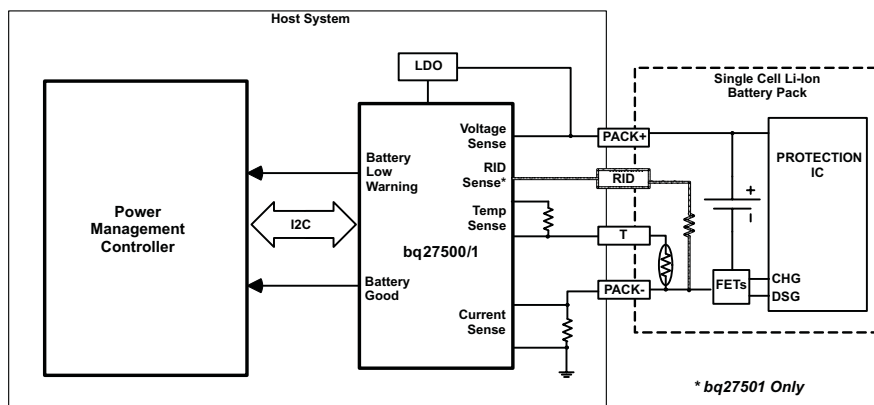

Please be aware that an important notice concerning availability, standard warranty, and use in critical applications of Texas Instruments semiconductor products and disclaimers thereto appears at the end of this document.

Impedance Track is a trademark of Texas Instruments.  
I<sup>2</sup>C is a trademark of Philips Electronics.

⚠ These devices have limited built-in ESD protection. The leads should be shorted together or the device placed in conductive foam during storage or handling to prevent electrostatic damage to the MOS gates.

## Contents

<b>1 INTRODUCTION</b> .....	<b>1</b>	4.2 DATA FLASH INTERFACE .....	<b>16</b>
1.1 FEATURES .....	<b>1</b>	4.3 MANUFACTURER INFORMATION BLOCKS .....	<b>17</b>
1.2 APPLICATIONS .....	<b>1</b>	4.4 ACCESS MODES .....	<b>17</b>
1.3 DESCRIPTION .....	<b>1</b>	4.5 SEALING/UNSEALING DATA FLASH .....	<b>17</b>
<b>2 DEVICE INFORMATION</b> .....	<b>3</b>	4.6 DATA FLASH SUMMARY.....	<b>18</b>
2.1 AVAILABLE OPTIONS .....	<b>3</b>	<b>5 FUNCTIONAL DESCRIPTION</b> .....	<b>20</b>
2.2 PIN DIAGRAMS .....	<b>3</b>	5.1 FUEL GAUGING .....	<b>20</b>
2.3 TERMINAL FUNCTIONS .....	<b>3</b>	5.2 IMPEDANCE TRACK™ VARIABLES.....	<b>21</b>
<b>3 ELECTRICAL SPECIFICATIONS</b> .....	<b>4</b>	5.3 DETAILED DESCRIPTION OF DEDICATED PINS.....	<b>23</b>
3.1 ABSOLUTE MAXIMUM RATINGS .....	<b>4</b>	5.4 TEMPERATURE MEASUREMENT .....	<b>26</b>
3.2 RECOMMENDED OPERATING CONDITIONS .....	<b>4</b>	5.5 OVERTEMPERATURE INDICATION.....	<b>26</b>
3.3 POWER-ON RESET.....	<b>4</b>	5.6 CHARGING AND CHARGE-TERMINATION INDICATION.....	<b>26</b>
3.4 INTERNAL TEMPERATURE SENSOR CHARACTERISTICS .....	<b>5</b>	5.7 POWER MODES.....	<b>27</b>
3.5 HIGH FREQUENCY OSCILLATOR .....	<b>5</b>	5.8 POWER CONTROL.....	<b>29</b>
3.6 LOW FREQUENCY OSCILLATOR.....	<b>5</b>	5.9 AUTOCALIBRATION.....	<b>30</b>
3.7 INTEGRATING ADC (COULOMB COUNTER) CHARACTERISTICS .....	<b>5</b>	<b>6 APPLICATION-SPECIFIC INFORMATION</b> .....	<b>31</b>
3.8 ADC (TEMPERATURE AND CELL MEASUREMENT) CHARACTERISTICS .....	<b>5</b>	6.1 BATTERY PROFILE STORAGE AND SELECTION	<b>31</b>
3.9 DATA FLASH MEMORY CHARACTERISTICS .....	<b>6</b>	6.2 APPLICATION-SPECIFIC FLOW AND CONTROL.	<b>31</b>
3.10 I <sup>2</sup> C-COMPATIBLE INTERFACE COMMUNICATION TIMING CHARACTERISTICS .....	<b>6</b>	<b>7 COMMUNICATIONS</b> .....	<b>33</b>
<b>4 GENERAL DESCRIPTION</b> .....	<b>8</b>	7.1 I <sup>2</sup> C INTERFACE.....	<b>33</b>
4.1 DATA COMMANDS .....	<b>9</b>	<b>8 REFERENCE SCHEMATICS</b> .....	<b>34</b>
		8.1 SCHEMATIC .....	<b>34</b>

## 2 DEVICE INFORMATION

### 2.1 AVAILABLE OPTIONS

PART NUMBER	PACKAGE <sup>(1)</sup>	T <sub>A</sub>	COMMUNICATION FORMAT	TAPE and REEL QUANTITY
bq27500DRZR	12-pin, 2,5 mm x 4,0 mm SON	–40°C to 85°C	I <sup>2</sup> C	3000
bq27500DRZT				300
bq27501DRZR <sup>(2)</sup>				3000
bq27501DRZT <sup>(2)</sup>				300

(1) For the most current package and ordering information, see the Package Option Addendum at the end of this document, or see the TI website at [www.ti.com](http://www.ti.com).

(2) Product Preview

### 2.2 PIN DIAGRAMS

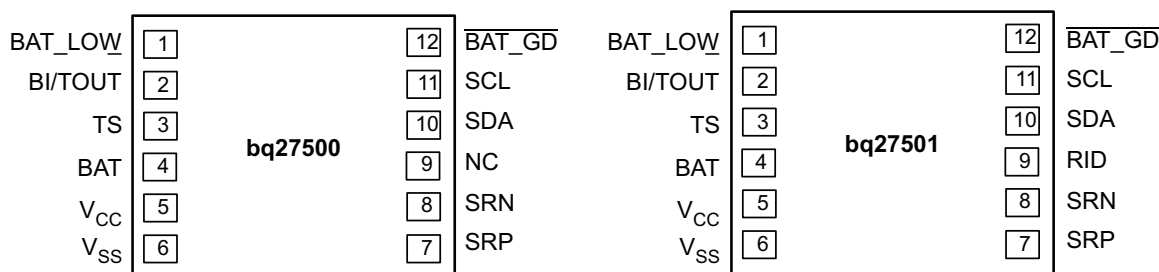

### 2.3 TERMINAL FUNCTIONS

PIN NO.	TERMINAL		I/O <sup>(1)</sup>	DESCRIPTION
	NAME bq27500	NAME bq27501		
1	BAT_LOW	BAT_LOW	O	Battery Low output indicator. Active <i>high</i> by default, though polarity can be configured through the [BATL_POL] in <b>Operation Configuration</b> Push-pull output.
2	BI/TOUT	BI/TOUT	I/O	Battery-insertion detection input. Power pin for pack thermistor network. Thermistor multiplexer control pin. Open-drain I/O. use with pull-up resistor > 1MΩ (1.8MΩ typical)
3	TS	TS	P	Pack thermistor voltage sense (use 103AT-type thermistor). ADC input.
4	BAT	BAT	I	Cell-voltage measurement input. ADC input.
5	V <sub>CC</sub>	V <sub>CC</sub>	P	Processor power input. Decouple with 0.1μF capacitor, minimum.
6	V <sub>SS</sub>	V <sub>SS</sub>	P	Device ground.
7	SRP	SRP	IA	Analog input pin connected to the internal coulomb-counter where SRP is nearest the CELL- connection. Connect to 5-20mΩ sense resistor.
8	SRN	SRN	IA	Analog input pin connected to the internal coulomb-counter where SRN is nearest the PACK- connection. Connect to 5-20mΩ sense resistor.
9	NC	RID	–, I	No connection (bq27500). Resistor ID input (bq27501). Analog input with current sourcing capabilities.
10	SDA	SDA	I/O	Slave I <sup>2</sup> C serial communications data line for communication with system ( <i>Master</i> ). Open-drain I/O. Use with 10kΩ pull-up resistor (typical).
11	SCL	SCL	I	Slave I <sup>2</sup> C serial communications clock input line for communication with system ( <i>Master</i> ). Open-drain I/O. Use with 10kΩ pull-up resistor (typical).
12	BAT_GD	BAT_GD	O	Battery Good indicator. Active <i>low</i> by default, though polarity can be configured through the [BATG_POL] of <b>Operation Configuration</b> . Open-drain output.

(1) I/O = Digital Input/Output, IA = Analog Input, P = Power Connection

### 3 ELECTRICAL SPECIFICATIONS

#### 3.1 ABSOLUTE MAXIMUM RATINGS

over operating free-air temperature range (unless otherwise noted)<sup>(1)</sup>

PARAMETER		VALUE	UNIT
V <sub>CC</sub>	Supply voltage range	−0.3 to 2.75	V
V <sub>IOD</sub>	Open-drain I/O pins (BI_TOUT, SDA, SDL, $\overline{\text{BAT\_GD}}$ )	−0.3 to 6	V
V <sub>BAT</sub>	BAT input pin	−0.3 to +6	
V <sub>I</sub>	Input voltage range to all other pins (TS, SRP, SRN, RID [bq27501 only], NC [bq27500 only])	−0.3 to V <sub>CC</sub> + 0.3	V
ESD	Human Body Model (HMB)	1	kV
		2	kV
T <sub>F</sub>	Functional temperature range	−40 to 100	°C
T <sub>STG</sub>	Storage temperature range	−65 to 150	°C

(1) Stresses beyond those listed under absolute maximum ratings may cause permanent damage to the device. These are stress ratings only, and functional operation of the device at these or any other conditions beyond those indicated under recommended operating conditions is not implied. Exposure to absolute-maximum-rated conditions for extended periods may affect device reliability.

#### 3.2 RECOMMENDED OPERATING CONDITIONS

T<sub>A</sub> = 25°C, V<sub>CC</sub> = 2.5 V (unless otherwise noted)

PARAMETER		TEST CONDITIONS	MIN	TYP	MAX	UNIT
V <sub>CC</sub>	Supply Voltage		2.4	2.5	2.6	V
I <sub>CC</sub>	Normal operating mode current <sup>(1)</sup>			95		μA
I <sub>SLP</sub>	Low-power storage mode current <sup>(2)</sup>			15		μA
I <sub>CC</sub>	Hibernate operating mode current <sup>(3)</sup>			2		μA
V <sub>OL</sub>	Output voltage low (SDA, BAT_LOW, BI/TOUT)	I <sub>OL</sub> = 0.5 mA			0.4	V
V <sub>OH(PP)</sub>	Output high voltage (BAT_LOW)	I <sub>OH</sub> = −1 mA	V <sub>CC</sub> −0.5			V
V <sub>OH(OD)</sub>	Output high voltage (SDA, SCL, BI/TOUT)	External pull-up resistor connected to V <sub>CC</sub>	V <sub>CC</sub> −0.5			V
V <sub>IL</sub>	Input voltage low (SDA, SCL)		−0.3		0.8	V
V <sub>IH(OD)</sub>	Input voltage high (SDA, SCL, BI/TOUT)		2		6	V
C <sub>IN</sub>	Input capacitance			5		pF
V <sub>A1</sub>	Input voltage range (TS, RID [bq27501 only])		V <sub>SS</sub> −0.125		2	V
V <sub>A2</sub>	Input voltage range (BAT)		V <sub>SS</sub> −0.125		5	V
V <sub>A3</sub>	Input voltage range (SRP, SRN)		V <sub>SS</sub> −0.125		0.125	V
t <sub>PUCD</sub>	Power up communication delay			250		ms
T <sub>A</sub>	Operating free-air temperature range		−40		85	°C

(1) High level of system activity.

(2) Low level of system activity.

(3) Fuel gauge algorithm power inactive. Only able to receive I<sup>2</sup>C communication.

#### 3.3 POWER-ON RESET

T<sub>A</sub> = −40°C to 85°C, Typical Values at T<sub>A</sub> = 25°C and V<sub>BAT</sub> = 3.6 V (unless otherwise noted)

PARAMETER		TEST CONDITIONS	MIN	TYP	MAX	UNIT
V <sub>IT+</sub>	Positive-going battery voltage input at V <sub>CC</sub>		2.09	2.20	2.31	V
V <sub>HYS</sub>			45	115	185	mV

### 3.4 INTERNAL TEMPERATURE SENSOR CHARACTERISTICS

$T_A = -40^\circ\text{C}$  to  $85^\circ\text{C}$ ,  $2.4\text{ V} < V_{CC} < 2.6\text{ V}$ ; Typical Values at  $T_A = 25^\circ\text{C}$  and  $V_{CC} = 2.5\text{ V}$  (unless otherwise noted)

PARAMETER	TEST CONDITIONS	MIN	TYP	MAX	UNIT
$G_{TEMP}$ Temperature sensor voltage gain			-2.0		mV/°C

### 3.5 HIGH FREQUENCY OSCILLATOR

$T_A = -40^\circ\text{C}$  to  $85^\circ\text{C}$ ,  $2.4\text{ V} < V_{CC} < 2.6\text{ V}$ ; Typical Values at  $T_A = 25^\circ\text{C}$  and  $V_{CC} = 2.5\text{ V}$  (unless otherwise noted)

PARAMETER	TEST CONDITIONS	MIN	TYP	MAX	UNIT
$f_{OSC}$ Operating frequency			2.097		MHz
$f_{EIO}$ Frequency error <sup>(1) (2)</sup>	$T_A = 0^\circ\text{C}$ to $60^\circ\text{C}$	-2.0%	0.38%	2.0%	
	$T_A = -20^\circ\text{C}$ to $70^\circ\text{C}$	-3.0%	0.38%	3.0%	
	$T_A = -40^\circ\text{C}$ to $85^\circ\text{C}$	-4.5%	0.38%	4.5%	
$t_{SXO}$ Start-up time <sup>(3)</sup>			2.5	5	ms

(1) The frequency error is measured from 2.097 MHz.

(2) The frequency drift is included and measured from the trimmed frequency at  $V_{CC} = 2.5\text{ V}$ ,  $T_A = 25^\circ\text{C}$ .

(3) The startup time is defined as the time it takes for the oscillator output frequency to be  $\pm 3\%$ .

### 3.6 LOW FREQUENCY OSCILLATOR

$T_A = -40^\circ\text{C}$  to  $85^\circ\text{C}$ ,  $2.4\text{ V} < V_{CC} < 2.6\text{ V}$ ; Typical Values at  $T_A = 25^\circ\text{C}$  and  $V_{CC} = 2.5\text{ V}$  (unless otherwise noted)

PARAMETER	TEST CONDITIONS	MIN	TYP	MAX	UNIT
$f_{LOSC}$ Operating frequency			32.768		kHz
$f_{LEIO}$ Frequency error <sup>(1) (2)</sup>	$T_A = 0^\circ\text{C}$ to $60^\circ\text{C}$	-1.5%	0.25%	1.5%	
	$T_A = -20^\circ\text{C}$ to $70^\circ\text{C}$	-2.5%	0.25%	2.5%	
	$T_A = -40^\circ\text{C}$ to $85^\circ\text{C}$	-4.0%	0.25%	4.0%	
$t_{LSXO}$ Start-up time <sup>(3)</sup>				500	$\mu\text{s}$

(1) The frequency drift is included and measured from the trimmed frequency at  $V_{CC} = 2.5\text{ V}$ ,  $T_A = 25^\circ\text{C}$ .

(2) The frequency error is measured from 32.768 kHz.

(3) The startup time is defined as the time it takes for the oscillator output frequency to be  $\pm 3\%$ .

### 3.7 INTEGRATING ADC (COULOMB COUNTER) CHARACTERISTICS

$T_A = -40^\circ\text{C}$  to  $85^\circ\text{C}$ ,  $2.4\text{ V} < V_{CC} < 2.6\text{ V}$ ; Typical Values at  $T_A = 25^\circ\text{C}$  and  $V_{CC} = 2.5\text{ V}$  (unless otherwise noted)

PARAMETER	TEST CONDITIONS	MIN	TYP	MAX	UNIT
$V_{SR\_IN}$ Input voltage range, $V_{(SRN)}$ and $V_{(SRP)}$	$V_{SR} = V_{(SRN)} - V_{(SRP)}$	-0.125		0.125	V
$t_{SR\_CONV}$ Conversion time	Single conversion		1		s
Resolution		14		15	bits
$V_{SR\_OS}$ Input offset	Before calibration		1		mV
	After calibration		10		$\mu\text{V}$
INL Integral nonlinearity error			$\pm 0.007$	$\pm 0.034$	% FSR
$Z_{SR\_IN}$ Effective input resistance <sup>(1)</sup>		2.5			$\text{M}\Omega$
$I_{SR\_LKG}$ Input leakage current <sup>(1)</sup>				0.3	$\mu\text{A}$

(1) Specified by design. Not tested in production.

### 3.8 ADC (TEMPERATURE AND CELL MEASUREMENT) CHARACTERISTICS

$T_A = -40^\circ\text{C}$  to  $85^\circ\text{C}$ ,  $2.4\text{ V} < V_{CC} < 2.6\text{ V}$ ; Typical Values at  $T_A = 25^\circ\text{C}$  and  $V_{CC} = 2.5\text{ V}$  (unless otherwise noted)

PARAMETER	TEST CONDITIONS	MIN	TYP	MAX	UNIT
$V_{ADC\_IN}$ Input voltage range		-0.2		1	V

**ADC (TEMPERATURE AND CELL MEASUREMENT) CHARACTERISTICS (continued)**

$T_A = -40^{\circ}\text{C}$  to  $85^{\circ}\text{C}$ ,  $2.4\text{ V} < V_{CC} < 2.6\text{ V}$ ; Typical Values at  $T_A = 25^{\circ}\text{C}$  and  $V_{CC} = 2.5\text{ V}$  (unless otherwise noted)

PARAMETER		TEST CONDITIONS	MIN	TYP	MAX	UNIT
$t_{\text{ADC\_CONV}}$	Conversion time				125	ms
	Resolution		14		15	bits
$V_{\text{ADC\_OS}}$	Input offset			1		mV
$Z_{\text{ADC1}}$	Effective input resistance (TS, RID [bq27501 only])		8			$\text{M}\Omega$
$Z_{\text{ADC2}}$	Effective input resistance (BAT) <sup>(1)</sup>	bq27500/1 not measuring cell voltage	8			$\text{M}\Omega$
		bq27500/1 measuring cell voltage		100		$\text{k}\Omega$
$I_{\text{ADC\_LKG}}$	Input Leakage Current <sup>(1)</sup>				0.3	$\mu\text{A}$

(1) Specified by design. Not tested in production.

**3.9 DATA FLASH MEMORY CHARACTERISTICS**

$T_A = -40^{\circ}\text{C}$  to  $85^{\circ}\text{C}$ ,  $2.4\text{ V} < V_{CC} < 2.6\text{ V}$ ; Typical Values at  $T_A = 25^{\circ}\text{C}$  and  $V_{CC} = 2.5\text{ V}$  (unless otherwise noted)

PARAMETER		TEST CONDITIONS	MIN	TYP	MAX	UNIT
$t_{\text{ON}}$	Data retention	See <sup>(1)</sup>	$10^{(1)}$			Years
	Flash programming write-cycles	See <sup>(1)</sup>	20,000			Cycles
$t_{\text{WORDPROG}}$	Word programming time	See <sup>(1)</sup>			2	ms
$I_{\text{CCPROG}}$	Flash-write supply current			5	10	mA

(1) Specified by design. Not production tested

**3.10 I<sup>2</sup>C-COMPATIBLE INTERFACE COMMUNICATION TIMING CHARACTERISTICS**

$T_A = -40^{\circ}\text{C}$  to  $85^{\circ}\text{C}$ ,  $2.4\text{ V} < V_{CC} < 2.6\text{ V}$ ; Typical Values at  $T_A = 25^{\circ}\text{C}$  and  $V_{CC} = 2.5\text{ V}$  (unless otherwise noted)

PARAMETER		TEST CONDITIONS	MIN	TYP	MAX	UNIT
$t_r$	SCL/SDA rise time				1	$\mu\text{s}$
$t_f$	SCL/SDA fall time				300	ns
$t_{w(H)}$	SCL pulse width (high)		4			$\mu\text{s}$
$t_{w(L)}$	SCL pulse width (low)		4.7			$\mu\text{s}$
$t_{su(STA)}$	Setup for repeated start		4.7			$\mu\text{s}$
$t_{d(STA)}$	Start to first falling edge of SCL		4			$\mu\text{s}$
$t_{su(DAT)}$	Data setup time		250			ns
$t_{h(DAT)}$	Data hold time	Receive mode	0			ns
		Transmit mode	300			
$t_{su(STOP)}$	Setup time for stop		4			$\mu\text{s}$
$t_{\text{BUF}}$	Bus free time between stop and start		4.7			$\mu\text{s}$
$f_{\text{SCL}}$	Clock frequency		10		100	kHz
$t_{\text{BUSERR}}$	Bus error timeout		17.3		21.2	s

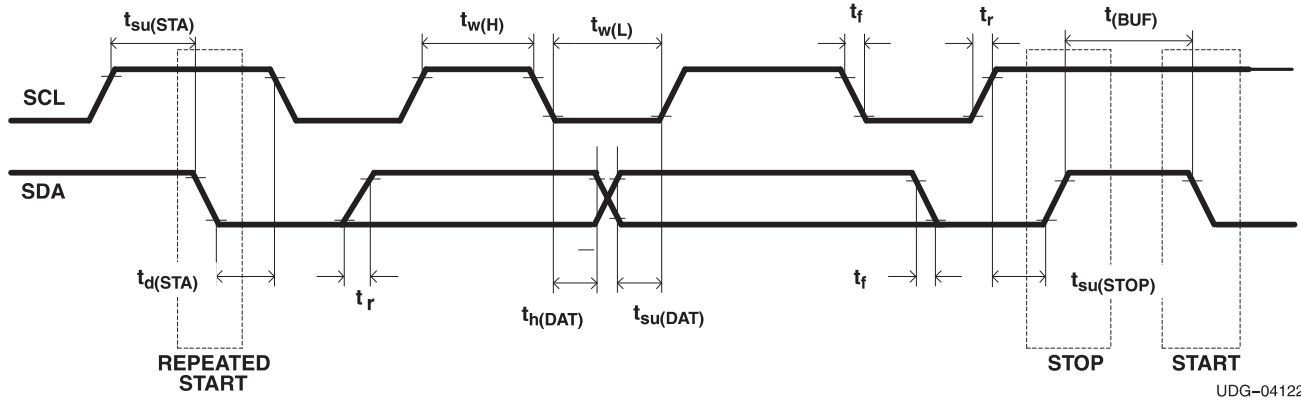

UDG-04122

Figure 3-1. I<sup>2</sup>C-Compatible Interface Timing Diagrams

## 4 GENERAL DESCRIPTION

The bq27500/1 accurately predicts the battery capacity and other operational characteristics of a single Li-based rechargeable cell. It can be interrogated by a system processor to provide cell information, such as State-of-Charge (SOC), Time-to-Empty (TTE) and Time-to-Full (TTF).

Information is accessed through a series of commands, called *Standard Commands*. Further capabilities are provided by the additional *Extended Commands* set. Both sets of commands, indicated by the general format *Command( )*, are used to read and write information contained within the bq27500/1 control and status registers, as well as its data flash locations. Commands are sent from system to gauge using the bq27500/1's I<sup>2</sup>C serial communications engine, and can be executed during application development, pack manufacture, or end-equipment operation.

Cell information is stored in the bq27500/1 in non-volatile flash memory. Many of these data flash locations are accessible during application development. They cannot be accessed directly during end-equipment operation. Access to these locations is achieved by either use of the bq27500/1's companion evaluation software, through individual commands, or through a sequence of data-flash-access commands. To access a desired data flash location, the correct data flash subclass and offset must be known.

The bq27500/1 provides 96 bytes of user-programmable data flash memory, partitioned into 3 32-byte blocks: **Manufacturer Info Block A**, **Manufacturer Info Block B**, and **Manufacturer Info Block C**. This data space is accessed through a data flash interface. For specifics on accessing the data flash, see [Section 4.3 Manufacturer Information Blocks](#).

The key to the bq27500/1's high-accuracy gas gauging prediction is Texas Instrument's proprietary Impedance Track™ algorithm. This algorithm uses cell measurements, characteristics, and properties to create state-of-charge predictions that can achieve less than 1% error across a wide variety of operating conditions and over the lifetime of the battery.

The bq27500/1 measures charge/discharge activity by monitoring the voltage across a small-value series sense resistor (5 mΩ to 20 mΩ typ.) located between the system's V<sub>SS</sub> and the battery's PACK– terminal. When a cell is attached to the bq27500/1, cell impedance is computed, based on cell current, cell Open Circuit Voltage (OCV), and cell voltage under loading conditions.

The bq27500/1 can use an NTC thermistor (default is Semitec 103AT) for temperature measurement, or can also be configured to use its internal temperature sensor. The bq27500/1 uses temperature to monitor the battery-pack environment, which is used for fuel gauging and cell protection functionality.

To minimize power consumption, the bq27500/1 has several power modes: NORMAL, SLEEP, HIBERNATE, and BAT INSERT CHECK. The bq27500/1 passes automatically between these modes, depending upon the occurrence of specific events, though a system processor can initiate some of these modes directly. More details can be found in the [Section 5.7 POWER MODES](#).

---

### NOTE

#### FORMATTING CONVENTIONS IN THIS DOCUMENT:

Commands: *italics with parentheses and no breaking spaces*, e.g. *RemainingCapacity( )*.

Data Flash: *italics*, **bold**, and *breaking spaces*, e.g. **Design Capacity**

Register Bits and Flags: brackets only, e.g. [TDA]

Data Flash Bits: *italics* and **bold**, e.g. [LED1]

Modes and states: ALL CAPITALS, e.g. UNSEALED mode.

---



## 4.1 DATA COMMANDS

### 4.1.1 STANDARD DATA COMMANDS

The bq27500/1 uses a series of 2-byte standard commands to enable system reading and writing of battery information. Each standard command has an associated command-code pair, as indicated in [Table 4-1](#). Because each command consists of two bytes of data, two consecutive I<sup>2</sup>C transmissions must be executed both to initiate the command function, and to read or write the corresponding two bytes of data. Additional options for transferring data, such as spooling, are described in [Section 7.1 I<sup>2</sup>C INTERFACE](#). Standard commands are accessible in NORMAL operation. Read/Write permissions depend on the active access mode, SEALED or UNSEALED (for details on the SEALED and UNSEALED states, see [Section 4.4 Access Modes](#)).

**Table 4-1. Standard Commands**

NAME		COMMAND CODE	UNITS	SEALED ACCESS	UNSEALED ACCESS
<i>Control()</i>	CNTL	0x00 / 0x01	N/A	R/W	R/W
<i>AtRate()</i>	AR	0x02 / 0x03	mA	R/W	R/W
<i>AtRateTimeToEmpty()</i>	ARTTE	0x04 / 0x05	Minutes	R	R
<i>Temperature()</i>	TEMP	0x06 / 0x07	0.1°K	R	R
<i>Voltage()</i>	VOLT	0x08 / 0x09	mV	R	R
<i>Flags()</i>	FLAGS	0x0a / 0x0b	N/A	R	R
<i>NominalAvailableCapacity()</i>	NAC	0x0c / 0x0d	mAh	R	R
<i>FullAvailableCapacity()</i>	FAC	0x0e / 0x0f	mAh	R	R
<i>RemainingCapacity()</i>	RM	0x10 / 0x11	mAh	R	R
<i>FullChargeCapacity()</i>	FCC	0x12 / 0x13	mAh	R	R
<i>AverageCurrent()</i>	AI	0x14 / 0x15	mA	R	R
<i>TimeToEmpty()</i>	TTE	0x16 / 0x17	Minutes	R	R
<i>TimeToFull()</i>	TTF	0x18 / 0x19	Minutes	R	R
<i>StandbyCurrent()</i>	SI	0x1a / 0x1b	mA	R	R
<i>StandbyTimeToEmpty()</i>	STTE	0x1c / 0x1d	Minutes	R	R
<i>MaxLoadCurrent()</i>	MLI	0x1e / 0x1f	mA	R	R
<i>MaxLoadTimeToEmpty()</i>	MLTTE	0x20 / 0x21	Minutes	R	R
<i>AvailableEnergy()</i>	AE	0x22 / 0x23	10mWhr	R	R
<i>AveragePower()</i>	AP	0x24 / 0x25	10mW	R	R
<i>TimeToEmptyAtConstantPower()</i>	TTECP	0x26 / 0x27	Minutes	R	R
Reserved	RSVD	0x28 / 0x29	N/A	R	R
<i>CycleCount()</i>	CC	0x2a / 0x2b	Counts	R	R
<i>StateOfCharge()</i>	SOC	0x2c / 0x2d	%	R	R

#### 4.1.1.1 Control( ): 0x00/0x01

Issuing a *Control( )* command requires a subsequent two-byte sub-command. These additional bytes specify the particular control function desired. The *Control( )* command allows the system to control specific features of the bq27500 during normal operation and additional features when the bq27500/1 is in different access modes, as described in [Table 4-2](#).

**Table 4-2. Control( ) Subcommands**

CNTL FUNCTION	CNTL DATA	SEALED ACCESS	DESCRIPTION
CONTROL STATUS	0x0000	Yes	Reports the status of DF Checksum, Hibernate, IT, etc.
DEVICE TYPE	0x0001	Yes	Reports the device type (eg: "bq27500")
FW VERSION	0x0002	Yes	Reports the firmware version on the device type
HW VERSION	0x0003	Yes	Reports the hardware version of the device type
Reserved	0x0004	No	Not to be used
RESET DATA	0x0005	No	Returns reset data
Reserved	0x0006	No	Not to be used
PREV_MACWRITE	0x0007	No	Returns previous MAC command code
CHEMID	0x0008	Yes	Reports the chemical identifier of the Impedance Track™ configuration
BOARD OFFSET	0x0009	No	Forces the device Board Offset to be measured and stored
CC INT OFFSET	0x000b	No	Forces the device to measure and store the internal CC offset
SET HIBERNATE	0x0011	Yes	Forces DF:Pack Configuration [HIBERNATE] to 1
CLEAR HIBERNATE	0x0012	Yes	Forces DF:Pack Configuration [HIBERNATE] to 0
SEALED	0x0020	No	Places the bq27500/1 in SEALED access mode
IT ENABLE	0x0021	No	Enables the Impedance Track™ algorithm
IFCHECKSUM	0x0022	No	Reports the instruction flash checksum
CALMODE	0x0040	No	Places the bq27500/1 in calibration mode
RESET	0x0041	No	Forces a full reset of the bq27500/1

##### 4.1.1.1.1 CONTROL STATUS: 0X0000

Instructs the gas gauge to return status information to Control addresses 0x00/0x01. The status word includes the following information.

**Table 4-3. CONTROL STATUS Bit Definitions**

Flags( )	bit7	bit6	bit5	bit4	bit3	bit2	bit1	bit0
High Byte	–	FAS	SS	-	CCA	BCA	–	–
Low Byte	–	HIBERNATE	–	SLEEP	LDMD	RUP_DIS	VOK	QEN

FAS = Status bit indicating the bq27500/1 is in FULL ACCESS SEALED state. Active when set.

SS = Status bit indicating the bq27500/1 is in SEALED State. Active when set.

CCA = Status bit indicating the bq27500/1 is Coulomb Counter Calibration routine is active. Active when set.

BCA = Status bit indicating the bq27500/1 Board Calibration routine is active. Active when set.

HIBERNATE = Status bit indicating a request for entry into HIBERNATE from SLEEP mode. True when set. Default is 0.

SLEEP = Status bit indicating the bq27500/1 is in SLEEP mode. True when set. Default is 0.

LDMD = Status bit indicating the bq27500/1 Impedance Track™ algorithm is using constant-power mode. True when set. Default is 0 (constant-current mode)

RUP\_DIS = Status bit indicating the bq27500/1 Ra table updates are disabled. Updates disabled when set.

VOK = Status bit indicating the bq27500/1 voltages are OK for QMAX. True when set.

QEN = Status bit indicating the bq27500/1 QMAX updates enabled. True when set.

##### 4.1.1.1.2 DEVICE TYPE: 0x0001

Instructs the fuel gauge to return the device type to addresses 0x00/0x01.

#### 4.1.1.1.3 **FW\_VERSION: 0x0002**

Instructs the fuel gauge to return the firmware version to addresses 0x00/0x01.

#### 4.1.1.1.4 **HW\_VERSION: 0x0003**

Instructs the fuel gauge to return the hardware version to addresses 0x00/0x01.

#### 4.1.1.1.5 **RESET\_DATA: 0x0005**

Instructs the fuel gauge to return the reset data to addresses 0x00/0x01, with the low-byte being the number of partial resets and the high-byte the number of full resets.

#### 4.1.1.1.6 **PREV\_MACWRITE: 0x0007**

Instructs the fuel gauge to return the previous command written to addresses 0x00/0x01.

#### 4.1.1.1.7 **CHEM ID: 0x0008**

Instructs the fuel gauge to return the chemical identifier for the Impedance Track™ configuration to addresses 0x00/0x01.

#### 4.1.1.1.8 **BOARD\_OFFSET: 0x0009**

Instructs the fuel gauge to compute the coulomb counter offset with internal short and then without internal short applied across the SR inputs. During this activity, CONTROL STATUS [BCA] is set. The difference between the two measurements is the Board Offset. The Board Offset is written to data flash and is also returned to addresses 0x00/0x01. The user must prevent any charge or discharge current from flowing during the process. This function is only available when the fuel gauge is UNSEALED. When SEALED, this command will only read back the Board Offset value stored in data flash.

#### 4.1.1.1.9 **CC\_INT\_OFFSET: 0x000A**

Instructs the fuel gauge to compute the coulomb counter offset with internal short applied across the SR inputs. The offset value is written to data flash and is also returned to addresses 0x00/0x01. This function is only available when the fuel gauge is UNSEALED. When SEALED, this command will only read back the CC\_INT\_OFFSET value stored in data flash.

#### 4.1.1.1.10 **SET\_HIBERNATE: 0x0011**

Instructs the fuel gauge to force the CONTROL STATUS' [HIBERNATE] bit to 1. This will allow the gauge to enter the HIBERNATE power mode after the transition to SLEEP power state is detected. The [HIBERNATE] bit is automatically cleared upon exiting from HIBERNATE mode.

#### 4.1.1.1.11 **CLEAR\_HIBERNATE: 0x0012**

Instructs the fuel gauge to force the CONTROL STATUS' [HIBERNATE] bit to 0. This will prevent the gauge from entering the HIBERNATE power mode after the transition to SLEEP power state is detected. It can also be used to force the gauge out of HIBERNATE mode.

#### 4.1.1.1.12 **SEALED: 0x0020**

Instructs the fuel gauge to transition from UNSEALED state to SEALED state. The fuel gauge should always be set to SEALED state for use in end equipment.

#### 4.1.1.1.13 **IT\_ENABLE: 0x0021**

This command forces the fuel gauge to begin the Impedance Track™ algorithm, sets the active **UpdateStatus n** location to 0x04 and causes the [VOK] and [QEN] flags to be set in the CONTROL STATUS register. [VOK] is cleared if the voltages are not suitable for a Qmax update. Once set, [QEN] cannot be cleared. This command is only available when the fuel gauge is UNSEALED.

#### 4.1.1.1.14 **IF\_CHECKSUM: 0x0022**

This command instructs the fuel gauge to compute the instruction flash checksum. When the checksum has been calculated and stored, then CONTROL STATUS [CVS] is set. In UNSEALED mode, the checksum value is returned to addresses 0x00/0x01. The checksum will not be calculated in SEALED mode; however, the checksum value can still be read.

#### 4.1.1.1.15 CAL MODE: 0x0040

This command instructs the fuel gauge to enter calibration mode. This command is only available when the fuel gauge is UNSEALED.

#### 4.1.1.1.16 RESET: 0x0041

This command instructs the fuel gauge to perform a full reset. This command is only available when the fuel gauge is UNSEALED.

#### 4.1.1.2 AtRate(): 0x02/0x03

The *AtRate()* read/write-word function is the first half of a two-function command-set used to set the *AtRate* value used in calculations made by the *AtRateTimeToEmpty()* function. The *AtRate()* units are in mA.

The *AtRate()* value is a signed integer, and both positive and negative values will be interpreted as a discharge current value. The *AtRateTimeToEmpty()* function returns the predicted operating time at the *AtRate* value of discharge. The default value for *AtRate()* is zero and will force *AtRate()* to return 65535. Both the *AtRate()* and *AtRateTimeToEmpty()* commands should only be used in NORMAL mode.

#### 4.1.1.3 AtRateTimeToEmpty(): 0x04/0x05

This read-word function returns an unsigned integer value of the predicted remaining operating time if the battery is discharged at the *AtRate()* value in minutes with a range of 0 to 65534. A value of 65535 indicates *AtRate()* = 0. The gas gauge updates *AtRateTimeToEmpty()* within 1s after the system sets the *AtRate()* value. The fuel gauge automatically updates *AtRateTimeToEmpty()* based on the *AtRate()* value every 1s. Both the *AtRate()* and *AtRateTimeToEmpty()* commands should only be used in NORMAL mode.

#### 4.1.1.4 Temperature(): 0x06/0x07

This read-word function returns an unsigned integer value of the temperature in units of 0.1°K measured by the gas gauge and has a range of 0 to 6553.5°K.

#### 4.1.1.5 Voltage(): 0x08/0x09

This read-word function returns an unsigned integer value of the measured cell-pack voltage in mV with a range of 0 to 6000 mV.

#### 4.1.1.6 Flags(): 0x0a/0x0b

This read-word function returns the contents of the gas-gauge status register, depicting the current operating status.

**Table 4-4. Flags Bit Definitions**

	bit7	bit6	bit5	bit4	bit3	bit2	bit1	bit0
High Byte	OTC	OTD	–	–	CHG_INH	XCHG	FC	CHG
Low Byte	CC_OFF	–	OCV_GD	WAIT_ID	BAT_DET	SOC1	SOCF	DSG

OTC = Overtemperature in Charge condition is detected. True when set.

OTD = Overtemperature in Discharge condition is detected. True when set.

CHG\_INH = Charge Inhibit: unable to begin charging (temp outside the range [*Charge Inhibit Temp Low, Charge Inhibit Temp High*]).

True when set.

XCHG = Charge Suspend Alert (temp outside the range [*Suspend Temp Low, Suspend Temp High*]). True when set.

FC = Fully Charged, set when Charge termination condition is met. True when set.

CHG = (Fast)charging allowed. True when set.

CC\_OFF = bq27500/1 performing Coulomb Counter Offset measurement. True when set.

OCV\_GD = Good OCV measurement taken. True when set.

WAIT\_ID = Waiting to identify inserted battery. True when set.

BAT\_DET = Battery detected. True when set.

SOC1 = State-of-Charge-Threshold 1 (**SOC1 Set**) reached. True when set.

SOCF = State-of-Charge-Threshold Final (**SOCF Set %**) reached. True when set.

DSG = Discharging detected. True when set.

#### 4.1.1.7 NominalAvailableCapacity( ): 0x0c/0x0d

This read-only command pair returns the uncompensated (no or light load) battery capacity remaining. Units are mAh per bit.

#### 4.1.1.8 FullAvailableCapacity( ): 0x0e/0x0f

This read-only command pair returns the uncompensated (no or light load) capacity of the battery when fully charged. Units are mAh per bit. *FullAvailableCapacity()* is updated at regular intervals, as specified by the IT algorithm.

#### 4.1.1.9 RemainingCapacity( ): 0x10/0x11

This read-only command pair returns the compensated battery capacity remaining. Units are mAh per bit.

#### 4.1.1.10 FullChargeCapacity( ): 0x12/13

This read-only command pair returns the compensated capacity of the battery when fully charged. Units are mAh per bit. *FullChargeCapacity()* is updated at regular intervals, as specified by the IT algorithm.

#### 4.1.1.11 AverageCurrent( ): 0x14/0x15

This read-only command pair returns a signed integer value that is the average current flow through the sense resistor. It is updated every 1 second. Units are mA per bit.

#### 4.1.1.12 TimeToEmpty( ): 0x16/0x17

This read-only function returns an unsigned integer value of the predicted remaining battery life at the present rate of discharge, in minutes. A value of 65535 indicates battery is not being discharged.

#### 4.1.1.13 TimeToFull( ): 0x18/0x19

This read-only function returns an unsigned integer value of predicted remaining time until the battery reaches full charge, in minutes, based upon *AverageCurrent()*. The computation accounts for the taper current time extension from the linear TTF computation based on a fixed *AverageCurrent()* rate of charge accumulation. A value of 65535 indicates the battery is not being charged.

#### 4.1.1.14 StandbyCurrent( ): 0x1a/0x1b

This read-only function returns a signed integer value of the measured standby current through the sense resistor. The *StandbyCurrent()* is an adaptive measurement. Initially it reports the standby current programmed in **Initial Standby**, and after spending some time in standby, reports the measured standby current.

The register value is updated every 1 second when the measured current is above the **Deadband** (3mA default) and is less than or equal to 2 x **Initial Standby**. The first and last values that meet this criteria are not averaged in, since they may not be stable values. To approximate a 1 minute time constant, each new *StandbyCurrent()* value is computed as follows:

$$\text{StandbyCurrent}()_{NEW} = (239/256) \times \text{StandbyCurrent}()_{OLD} + (17/256) \times \text{AverageCurrent}().$$

#### 4.1.1.15 StandbyTimeToEmpty( ): 0x1c/0x1d

This read-only function returns an unsigned integer value of the predicted remaining battery life at the standby rate of discharge, in minutes. The computation uses *Nominal Available Capacity* (NAC), the uncompensated remaining capacity, for this computation. A value of 65535 indicates battery is not being discharged.

#### 4.1.1.16 MaxLoadCurrent(): 0x1e/0x1f

This read-only function returns a signed integer value, in units of mA, of the maximum load conditions. The *MaxLoadCurrent()* is an adaptive measurement which is initially reported as the maximum load current programmed in **Initial Max Load Current**. If the measured current is ever greater than **Initial Max Load Current**, then *MaxLoadCurrent()* updates to the new current. *MaxLoadCurrent()* is reduced to the average of the previous value and **Initial Max Load Current** whenever the battery is charged to full after a previous discharge to an SOC less than 50%. This prevents the reported value from maintaining an unusually high value.

#### 4.1.1.17 MaxLoadTimeToEmpty(): 0x20/0x21

This read-only function returns an unsigned integer value of the predicted remaining battery life at the maximum load current discharge rate, in minutes. A value of 65535 indicates that the battery is not being discharged.

#### 4.1.1.18 AvailableEnergy(): 0x22/0x23

This read-only function returns an unsigned integer value of the predicted charge or energy remaining in the battery. The value is reported in units of mWh.

#### 4.1.1.19 AveragePower(): 0x24/0x25

This read-word function returns an unsigned integer value of the average power of the current discharge. A value of 0 indicates that the battery is not being discharged. The value is reported in units of mW.

#### 4.1.1.20 TimeToEmptyAtConstantPower(): 0x26/0x27

This read-only function returns an unsigned integer value of the predicted remaining operating time if the battery is discharged at the *AveragePower()* value in minutes. A value of 65535 indicates *AveragePower()* = 0. The fuel gauge automatically updates *TimeToEmptyatContantPower()* based on the *AveragePower()* value every 1s.

#### 4.1.1.21 CycleCount(): 0x2a/0x2b

This read-only function returns an unsigned integer value of the number of cycles the battery has experienced with a range of 0 to 65535. One cycle occurs when accumulated discharge  $\geq$  **CC Threshold**.

#### 4.1.1.22 StateOfCharge(): 0x2c/0x2d

This read-only function returns an unsigned integer value of the predicted remaining battery capacity expressed as a percentage of *FullChargeCapacity()*, with a range of 0 to 100%.

### 4.1.2 EXTENDED DATA COMMANDS

Extended commands offer additional functionality beyond the standard set of commands. They are used in the same manner; however unlike standard commands, extended commands are not limited to 2-byte words. The number of commands bytes for a given extended command ranges in size from single to multiple bytes, as specified in [Table 4-5](#). For details on the SEALED and UNSEALED states, see [Section 4.4 Access Modes](#).

**Table 4-5. Extended Data Commands**

NAME	COMMAND CODE	UNITS	SEALED ACCESS <sup>(1)(2)</sup>	UNSEALED ACCESS <sup>(1)(2)</sup>
Reserved	RSVD	N/A	R	R
<i>DesignCapacity()</i>	DCAP	mAh	R	R
<i>DataFlashClass()</i> <sup>(2)</sup>	DFCLS	N/A	N/A	R/W
<i>DataFlashBlock()</i> <sup>(2)</sup>	DFBLK	N/A	R/W	R/W
<i>Authenticate()/BlockData()</i>	A/DF	N/A	R/W	R/W
<i>AuthenticateChecksum()/BlockData()</i>	ACKS/DFD	N/A	R/W	R/W

(1) SEALED and UNSEALED states are entered via commands to CNTL 0x00/0x01.

(2) In sealed mode, data flash CANNOT be accessed through commands 0x3e and 0x3f.

Table 4-5. Extended Data Commands (continued)

NAME	COMMAND CODE	UNITS	SEALED ACCESS <sup>(1)(2)</sup>	UNSEALED ACCESS <sup>(1)(2)</sup>
<i>BlockData()</i>	DFD	0x55...0x5f	R	R/W
<i>BlockDataChecksum()</i>	DFDCKS	0x60	R/W	R/W
<i>BlockDataControl()</i>	DFDCNTL	0x61	N/A	R/W
<i>DeviceNameLength()</i>	DNAMELEN	0x62	R	R
<i>DeviceName()</i>	DNAME	0x63...0x69	R	R
<i>ApplicationStatus()</i>	APPSTAT	0x6a	R	R
Reserved	RSVD	0x6b...0x7f	R	R

#### 4.1.2.1 DesignCapacity(): 0x3c/0x3d

SEALED and UNSEALED Access: This command returns the theoretical or nominal capacity of a new pack. The value is stored in **Design Capacity** and is expressed in mAh. This is intended to be the theoretical or nominal capacity of a new pack, but has no bearing on the operation of the fuel gauge functionality.

#### 4.1.2.2 DataFlashClass(): 0x3e

UNSEALED Access: This command sets the data flash class to be accessed. The class to be accessed should be entered in hexadecimal.

SEALED Access: This command is not available in SEALED mode.

#### 4.1.2.3 DataFlashBlock(): 0x3f

UNSEALED Access: This command sets the data flash block to be accessed. When "0x00" is written to *BlockDataControl()*, *DataFlashBlock()* holds the block number of the data flash to be read or written. Example: writing a 0x00 to *DataFlashBlock()* specifies access to the first 32 byte block and a 0x01 specifies access to the second 32 byte block, and so on.

SEALED Access: This command directs which data flash block will be accessed by the *BlockData()* command. Writing a 0x00 to *DataFlashBlock()* specifies the *BlockData()* command will transfer authentication data. Issuing a 0x01, 0x02 or 0x03 instructs the *BlockData()* command to transfer **Manufacturer Info Block A, B, or C**, respectively.

#### 4.1.2.4 BlockData(): 0x40...0x5f

UNSEALED Access: This data block is the remainder of the 32 byte data block when accessing data flash.

SEALED Access: This data block is the remainder of the 32 byte data block when accessing **Manufacturer Block Info A, B, or C**.

#### 4.1.2.5 BlockDataChecksum(): 0x60

UNSEALED Access: This byte contains the checksum on the 32 bytes of block data read or written to data flash. The least significant byte of the sum of the data bytes written must be complemented ( [255 – x] , for x the least significant byte) before being written to 0x60.

SEALED Access: This byte contains the checksum for the 32 bytes of block data written to **Manufacturer Info Block A, B, or C**. The least significant byte of the sum of the data bytes written must be complemented ( [255 – x] , for x the least significant byte) before being written to 0x60.

#### 4.1.2.6 BlockDataControl(): 0x61

UNSEALED Access: This command is used to control data flash access mode. Writing 0x00 to this command enables *BlockData()* to access general data flash. Writing a 0x01 to this command enables SEALED mode operation of *DataFlashBlock()*.

SEALED Access: This command is not available in SEALED mode.

#### 4.1.2.7 DeviceNameLength( ): 0x62

UNSEALED and SEALED Access: This byte contains the length of the **Device Name**.

#### 4.1.2.8 DeviceName( ): 0x63...0x69

UNSEALED and SEALED Access: This block contains the device name that is programmed in **Device Name**.

#### 4.1.2.9 ApplicationStatus( ): 0x6a

This byte function allows the system to read the Application Status register of the bq27500/01. See [Section 6.1.3](#) for specific bit definitions.

#### 4.1.2.10 Reserved – 0x6b – 0x7f

## 4.2 DATA FLASH INTERFACE

### 4.2.1 ACCESSING THE DATA FLASH

The bq27500/1 data flash is a non-volatile memory that contains bq27500/1 initialization, default, cell status, calibration, configuration, and user information. The data flash can be accessed in several different ways, depending on what mode the bq27500/1 is operating in and what data is being accessed.

Commonly accessed data flash memory locations, frequently read by a system, are conveniently accessed through specific instructions, already described in [Section 4.1 DATA COMMANDS](#). These commands are available when the bq27500/1 is either in UNSEALED or SEALED modes.

Most data flash locations, however, are only accessible in UNSEALED mode by use of the bq27500/1 evaluation software or by data flash block transfers. These locations should be optimized and/or fixed during the development and manufacture processes. They become part of a golden image file and can then be written to multiple battery packs. Once established, the values generally remain unchanged during end-equipment operation.

To access data flash locations individually, the block containing the desired data flash location(s) must be transferred to the command register locations, where they can be read to the system or changed directly. This is accomplished by sending the set-up command *BlockDataControl( )* (0x61) with data 0x00. Up to 32 bytes of data can be read directly from the *BlockData( )* (0x40...0x5f), externally altered, then re-written to the *BlockData( )* command space. Alternatively, specific locations can be read, altered, and re-written if their corresponding offsets are used to index into the *BlockData( )* command space. Finally, the data residing in the command space is transferred to data flash, once the correct checksum for the whole block is written to *BlockDataChecksum( )* (0x60).

Occasionally, a data flash CLASS will be larger than the 32-byte block size. In this case, the *DataFlashBlock( )* command is used to designate in which 32-byte block the desired locations resides. The correct command address is then given by  $0x40 + \text{offset modulo } 32$ . For example, to access **Terminate Voltage** in the *Gas Gauging* class, *DataFlashClass( )* is issued 80 (0x50) to set the class. Because the offset is 48, it must reside in the second 32-byte block. Hence, *DataFlashBlock( )* is issued 0x01 to set the block offset, and the offset used to index into the *BlockData( )* memory area is  $0x40 + 48 \text{ modulo } 32 = 0x40 + 16 = 0x40 + 0x10 = 0x50$ .

Reading and writing subclass data are block operations up to 32 bytes in length. If during a write the data length exceeds the maximum block size, then the data is ignored.

None of the data written to memory are bounded by the bq27500/1– the values are not rejected by the fuel gauge. Writing an incorrect value may result in hardware failure due to firmware program interpretation of the invalid data. The written data is persistent, so a Power-On-Reset does resolve the fault.



### 4.3 MANUFACTURER INFORMATION BLOCKS

The bq27350 contains 96 bytes of user programmable data flash storage: **Manufacturer Info Block A**, **Manufacturer Info Block B**, **Manufacturer Info Block C**. The method for accessing these memory locations is slightly different, depending on whether the device is in UNSEALED or SEALED modes.

When in UNSEALED mode and when and “0x00” has been written to *BlockDataControl()*, accessing the Manufacturer Info Blocks is identical to accessing general data flash locations. First, a *DataFlashClass()* command is used to set the subclass, then a *DataFlashBlock()* command sets the offset for the first data flash address within the subclass. The *BlockData()* command codes contain the referenced data flash data. When writing the data flash, a checksum is expected to be received by *BlockDataChecksum()*. Only when the checksum is received and verified is the data actually written to data flash.

As an example, the data flash location for **Manufacturer Info Block B** is defined as having a Subclass = 58 and an Offset = 32 through 63 (32 byte block). The specification of Class = System Data is not needed to address **Manufacturer Info Block B**, but is used instead for grouping purposes when viewing data flash info in the bq27500/1 evaluation software.

When in SEALED mode or when “0x01” *BlockDataControl()* does not contain “0x00”, data flash is no longer available in the manner used in UNSEALED mode. Rather than issuing subclass information, a designated Manufacturer Information Block is selected with the *DataFlashBlock()* command. Issuing a 0x01, 0x02, or 0x03 with this command causes the corresponding information block (A, B, or C, respectively) to be transferred to the command space 0x40...0x5f for editing or reading by the system. Upon successful writing of checksum information to *BlockDataChecksum()*, the modified block is returned to data flash. **Note:** **Manufacturer Info Block A** is “read only” when in SEALED mode.

### 4.4 ACCESS MODES

The bq27500/1 provides three security modes in which control data flash access permissions according to [Table 4-6](#). *Public Access* refers to those data flash locations, specified in [Table 4-7](#), that are accessible to the user. *Private Access* refers to reserved data flash locations used by the bq27500/1 system. Care should be taken to avoid writing to *Private* data flash locations when performing block writes in FULL ACCESS mode, by following the procedure outlined in [Section 4.2.1](#).

**Table 4-6. Data Flash Access**

Security Mode	DF – Public Access	DF – Private Access
BOOTROM	N/A	N/A
FULL ACCESS	R/W	R/W
UNSEALED	R/W	R/W
SEALED	R	N/A

Although FULL ACCESS and UNSEALED modes appear identical, FULL ACCESS allows the bq27500/1 to directly transition to BOOTROM mode and also write access mode transition keys. The UNSEAL mode lacks these abilities.

### 4.5 SEALING/UNSEALING DATA FLASH

The bq27500/1 implements a key-access scheme to transition between SEALED, UNSEALED, and FULL-ACCESS modes. Each transition requires that a unique set of 2 keys be sent to the bq27500/1 via the *Control()* control command. The keys must be sent consecutively, with no other data being written to the *Control()* register in between. Note that to avoid conflict, the keys must be different from the codes presented in the *CNTL DATA* column of [Table 4-2 Control\(\) subcommands.](#)

When in SEALED mode the *Control Status()*'s [SS] bit is set, but when the UNSEAL keys are correctly received by the bq27500/1, the [SS] bit is cleared. When the FULL-ACCESS keys are correctly received then the *Control Status()* [FAS] bit is cleared.

Both the sets of keys for each level are 2 bytes each in length and are stored in data flash. The UNSEAL key (stored at **Unseal Key 0** and **Unseal Key 1**) and the FULL-ACCESS key (stored at **Full Access Key 0** and **Full Access Key 1**) can only be updated when in FULL-ACCESS mode. The order of the bytes entered through the *Control()* command is the reverse of what is read from the part. For example, if the 1st and 2nd word of **Unseal Key 0** read returns 0x1234 and 0x5678, then the *Control()* should supply 0x3412 and 0x7856 to unseal the part.

#### 4.6 DATA FLASH SUMMARY

Table 4-7 summarizes the data flash locations available to the user, including their default, minimum, and maximum values.

Table 4-7. Data Flash Summary

Class	Subclass ID	Subclass	Offset	Name	Data Type	Min Value	Max Value	Default Value	Units
Configuration	2	Safety	0	OT Chg	I2	0	1200	550	0.1°C
Configuration	2	Safety	2	OT Chg Time	U1	0	60	2	s
Configuration	2	Safety	3	OT Chg Recovery	I2	0	1200	500	0.1°C
Configuration	2	Safety	5	OT Dsg	I2	0	1200	600	0.1°C
Configuration	2	Safety	7	OT Dsg Time	U1	0	60	2	s
Configuration	2	Safety	8	OT Dsg Recovery	I2	0	1200	550	0.1°C
Configuration	32	Charge Inhibit Config	0	Charge Inhibit Temp Low	I2	-400	1200	0	0.1°C
Configuration	32	Charge Inhibit Config	2	Charge Inhibit Temp High	I2	-400	1200	450	0.1°C
Configuration	32	Charge Inhibit Config	4	Temp Hys	I2	0	100	50	0.1°C
Configuration	34	Charge	2	Charging Voltage	I2	0	20000	4200	mV
Configuration	34	Charge	4	Delta Temperature	I2	0	500	50	0.1°C
Configuration	34	Charge	6	Suspend Temperature Low	I2	-400	1200	-50	0.1°C
Configuration	34	Charge	8	Suspend Temperature High	I2	-400	1200	550	0.1°C
Configuration	36	Charge Termination	2	Taper Current	I2	0	1000	100	mA
Configuration	36	Charge Termination	4	Minimum Taper Charge	I2	0	1000	64	mAh
Configuration	36	Charge Termination	6	Taper Voltage	I2	0	1000	100	mV
Configuration	36	Charge Termination	8	Current Taper Window	U1	0	60	40	s
Configuration	48	Data	0	SOC1 Set	I2	0	700	100	mAh
Configuration	48	Data	6	Initial Standby Current	I1	-256	0	-10	mA
Configuration	48	Data	7	Initial Max Load Current	I2	-32767	0	-1000	mA
Configuration	48	Data	9	CC Threshold	I2	100	32767	1400	mAh
Configuration	48	Data	12	Design Capacity	I2	0	65535	1500	mAh
Configuration	48	Data	39	Device Name	S8	x	x	bq27500 or bq27501	-
Configuration	49	Discharge	0	SOCF Set %	I1	-1	100	6	%
Configuration	49	Discharge	2	SOCF Clear %	I1	-1	100	8	%
Configuration	49	Discharge	4	Max Load RSOC	I1	0	100	50	%
System Data	58	Manufacturer Info	0–31	Block A [0–31]	H1	0x00	0xff	0x00	-
System Data	58	Manufacturer Info	32–63	Block B [0–31]	H1	0x00	0xff	0x00	-
System Data	58	Manufacturer Info	64–95	Block C [0–31]	H1	0x00	0xff	0x00	-

**Table 4-7. Data Flash Summary (continued)**

Class	Subclass ID	Subclass	Offset	Name	Data Type	Min Value	Max Value	Default Value	Units
Configuration	64	Registers	0	Operation Configuration	H2	0x0000	0xffff	0x0979	–
Configuration	64	Registers	2	Pack 0 Voltage <sup>(1)</sup>	U2	0	4200	1000	mV
Configuration	64	Registers	4	Pack 1 Voltage <sup>(1)</sup>	U2	0	4200	4000	mV
Configuration	64	Registers	8	Pack V% Range <sup>(1)</sup>	U1	0	100	5	%
Configuration	68	Power	0	Flash Update OK Voltage	I2	0	4200	2800	mV
Configuration	68	Power	7	Sleep Current	I2	0	100	10	mA
Configuration	68	Power	16	Bat Low Threshold	I2	0	700	100	mAh
Configuration	68	Power	18	Hibernate Voltage Threshold	U2	2400	3000	2550	mV
Gas Gauging	80	IT Cfg	0	Load Select	U1	0	255	1	–
Gas Gauging	80	IT Cfg	1	Load Mode	U1	0	255	0	–
Gas Gauging	80	IT Cfg	48	Terminate Voltage	I2	–32768	32767	3000	mV
Gas Gauging	80	IT Cfg	53	User Rate-mA	I2	0	9000	0	mA
Gas Gauging	80	IT Cfg	55	User Rate-mW	I2	0	14000	0	10mW
Gas Gauging	80	IT Cfg	57	Reserve Cap-mAh	I2	0	9000	0	mAh
Gas Gauging	80	IT Cfg	59	Reserve Cap-mWh	I2	0	14000	0	10mWh
Gas Gauging	81	Current Thresholds	0	Dsg Current Threshold	I2	0	2000	75	mA
Gas Gauging	81	Current Thresholds	2	Chg Current Threshold	I2	0	2000	75	mA
Gas Gauging	81	Current Thresholds	4	Quit Current	I2	0	1000	50	mA
Gas Gauging	81	Current Thresholds	6	Dsg Relax Time	U2	0	8191	1800	s
Gas Gauging	81	Current Thresholds	8	Chg Relax Time	U1	0	255	60	s
Gas Gauging	81	Current Thresholds	9	Quit Relax Time	U1	0	63	1	s
Gas Gauging	82	State	0	IT Enable	H1	0x00	0xff	0x00	–
Gas Gauging	82	State	1	Application Status	H1	0x00	0xff	0x00	–
Gas Gauging	82	State	2	Qmax 0	I2	0	32767	1500	mAh
Gas Gauging	82	State	4	Cycle Count 0	U2	0	65535	0	–
Gas Gauging	82	State	6	Update Status 0	H1	0x00	0x03	0x00	–
Gas Gauging	82	State	7	Qmax 1	I2	0	32767	1500	mAh
Gas Gauging	82	State	9	Cycle Count 1	U2	0	65535	0	–
Gas Gauging	82	State	11	Update Status 1	H1	0x00	0x03	0x00	–
Gas Gauging	82	State	16	Avg I Last Run	I2	–32768	32767	300	mA
Gas Gauging	82	State	18	Avg P Last Run	I2	–32768	32767	1200	mAh
OCVTables	83	OCVa0 Table	0-45	See Note <sup>(2)</sup>					
OCVTables	84	OCVa1 Table	0-45						
OCVTables	85	OCVb0 Table	0-64						
OCVTables	86	OCVb1 Table	0-64						
Default Ra Tables	87	Def0 Ra	0-18	See Note <sup>(2)</sup>					
Default Ra Tables	88	Def1 Ra	0-18						
Rb Tables	89	Rb0 Table	0-18	See Note <sup>(2)</sup>					
Rb Tables	90	Rb1 Table	0-18						

(1) bq27501 only.

(2) Encoded battery profile information created by bqEASY software.

Table 4-7. Data Flash Summary (continued)

Class	Subclass ID	Subclass	Offset	Name	Data Type	Min Value	Max Value	Default Value	Units
Ra Tables	91	Pack0 Ra	0-18	See Note <sup>(2)</sup>					
Ra Tables	92	Pack1 Ra	0-18						
Ra Tables	93	Pack0 Rax	0-18						
Ra Tables	94	Pack1 Rax	0-18						
Calibration	104	Data	0	CC Gain	F4	0.1	4	0.47095	mΩ
Calibration	104	Data	4	CC Delta	F4	29826	1193046	280932.6	mΩ
Calibration	104	Data	8	CC Offset	I2	-32768	32767	-1667	mV
Calibration	104	Data	10	Board Offset	I1	-128	127	0	mV
Calibration	104	Data	11	Int Temp Offset	I1	-128	127	0	0.1°C
Calibration	104	Data	12	Ext Temp Offset	I1	-128	127	0	0.1°C
Calibration	104	Data	13	Pack V Offset	I1	-128	127	0	0.1°C
Calibration	107	Current	1	Deadband	U1	0	255	3	mA
Security	112	Codes	0	Usealed Key0	H2	0x0000	0xffff	-	-
Security	112	Codes	2	Usealed Key1	H2	0x0000	0xffff	-	-
Security	112	Codes	4	Full-Access Key0	H2	0x0000	0xffff	-	-
Security	112	Codes	6	Full-Access Key1	H2	0x0000	0xffff	-	-

## 5 FUNCTIONAL DESCRIPTION

### 5.1 FUEL GAUGING

The bq27500/1 measures the cell voltage, temperature, and current to determine battery SOC. The bq27500/1 monitors charge and discharge activity by sensing the voltage across a small-value resistor (5mΩ to 20 mΩ typ.) between the SRP and SRN pins and in series with the cell. By integrating charge passing through the battery, the cell's SOC is adjusted during battery charge or discharge.

The total battery capacity is found by comparing states of charge before and after applying the load with the amount of charge passed. When an application load is applied, the impedance of the cell is measured by comparing the OCV obtained from a predefined function for present SOC with the measured voltage under load. Measurements of OCV and charge integration determine chemical state of charge and Chemical Capacity (Qmax). The initial Qmax values are taken from a cell manufacturers' data sheet multiplied by the number of parallel cells. It is also used for the value in **Design Capacity**. The bq27500/1 acquires and updates the battery-impedance profile during normal battery usage. It uses this profile, along with SOC and the Qmax value, to determine *FullChargeCapacity()* and *StateOfCharge()*, specifically for the present load and temperature. *FullChargeCapacity()* is reported as capacity available from a fully charged battery under the present load and temperature until *Voltage()* reaches the **Term Voltage**. *NominalAvailableCapacity()* and *FullAvailableCapacity()* are the uncompensated (no or light load) versions of *RemainingCapacity()* and *FullChargeCapacity()* respectively.

The bq27500/1 has two flags accessed by the *Flags()* function that warns when the cell's SOC has fallen to critical levels. When *RemainingCapacity()* falls below the first capacity threshold, specified in **SOC1 Set**, the [SOC1] ("State of Charge Initial") flag is set. The flag is cleared, once *RemainingCapacity()* rises above **SOC1 Set**. All units are in mAh.

When *RemainingCapacity()* falls below the second capacity threshold, **SOCF Set**, the [SOCF] ("State of Charge Final") flag is set, serving as a final discharge warning. If **SOCF Set** = -1, the flag is inoperative during discharge.

Similarly, when *RemainingCapacity()* rises above **SOCF Clear** and the [SOCF] flag has already been set, the [SOCF] flag will be cleared, provided **SOCF Set** ≠ -1. All units are in mAh.

## 5.2 IMPEDANCE TRACK™ VARIABLES

The bq27500/1 has several data flash variables that permit the user to customize the Impedance Track™ algorithm for optimized performance. These variables are dependent upon the power characteristics of the application as well as the cell itself.

### Load Mode

*Load Mode* is used to select either the constant current or constant power model for the Impedance Track™ algorithm as used in *Load Select* (see *Load Select*). When *Load Mode* is 0, the *Constant Current Model* is used (default). When 1, the *Constant Power Model* is used. The [LDMD] bit of CONTROL STATUS reflects the status of *Load Mode*.

### Load Select

*Load Select* defines the type of power or current model to be used to compute load-compensated capacity in the Impedance Track™ algorithm. If *Load Mode* = 0 (*Constant Current*) then the options presented in [Table 5-1](#) are available.

**Table 5-1. Constant-Current Model Used When Load Mode = 0**

LoadSelect Value	Current Model Used
0	Average discharge current from previous cycle: There is an internal register that records the average discharge current through each entire discharge cycle. The previous average is stored in this register.
1 (default)	Present average discharge current: This is the average discharge current from the beginning of this discharge cycle until present time.
2	Average Current: based on <i>AverageCurrent()</i>
3	Current: based off of a low-pass-filtered version of <i>AverageCurrent()</i> ( $\tau = 14s$ )
4	Design Capacity / 5: C Rate based off of Design Capacity /5 or a C/5 rate in mA.
5	AtRate (mA): Use whatever current is in <i>AtRate()</i>
6	User_Rate-mA: Use the value in <i>User_Rate()</i> . This gives a completely user configurable method.

If *ILoad Mode* = 1 (*Constant Power*) then the following options shown in [Table 5-2](#) are available.

**Table 5-2. Constant-Power Model Used When Load Mode = 1**

LoadSelect Value	Power Model Used
0	Average discharge power from previous cycle: There is an internal register that records the average discharge power through each entire discharge cycle. The previous average is stored in this register.
1 (default)	Present average discharge power: This is the average discharge power from the beginning of this discharge cycle until present time.
2	Average Current×Voltage: based off the <i>AverageCurrent()</i> and <i>Voltage()</i> .
3	Current ×Voltage: based off of a low-pass-filtered version of <i>AverageCurrent()</i> ( $\tau = 14s$ ) and <i>Voltage()</i>
4	Design Energy / 5: C Rate based off of Design Energy /5 or a C/5 rate in mA.
5	AtRate (10 mW): Use whatever value is in <i>AtRate()</i> .
6	User_Rate-10mW: Use the value in <i>User_Rate()</i> mW. This gives a completely user configurable method.

### Reserve Cap-mAh

*Reserve Cap-mAh* determines how much actual remaining capacity exists after reaching 0 *RemainingCapacity()*, before *Terminate Voltage* is reached. A no-load rate of compensation is applied to this reserve.

### Reserve Cap-mWh

*Reserve Cap-mWh* determines how much actual remaining capacity exists after reaching 0 *AvailableEnergy()*, before *Terminate Voltage* is reached. A no-load rate of compensation is applied to this reserve capacity.

### Dsg Current Threshold

This register is used as a threshold by many functions in the bq27350 to determine if actual discharge current is flowing into or out of the cell. The default for this register is 100mA which should be sufficient for most applications. This threshold should be set low enough to be below any normal application load current but high enough to prevent noise or drift from affecting the measurement.

### Chg Current Threshold

This register is used as a threshold by many functions in the bq27500/1 to determine if actual charge current is flowing into or out of the cell. The default for this register is 50mA which should be sufficient for most applications. This threshold should be set low enough to be below any normal charge current but high enough to prevent noise or drift from affecting the measurement.

### Quit Current, Dsg Relax Time, Chg Relax Time, and Quit Relax Time

The **Quit Current** is used as part of the Impedance Track™ algorithm to determine when the bq27500 enters relaxation mode from a current flowing mode in either the charge direction or the discharge direction. The value of **Quit Current** is set to a default value of 10mA and should be above the standby current of the system.

Either of the following criteria must be met to enter relaxation mode:

1.  $|AverageCurrent()| < |Quit\ Current|$  for **Dsg Relax Time**.
2.  $|AverageCurrent()| < |Quit\ Current|$  for **Chg Relax Time**.

After about 30 minutes in relaxation mode, the bq27500 attempts to take accurate OCV readings. An additional requirement of  $dV/dt < 4\ \mu V/sec$  is required for the bq27500/1 to perform Qmax updates. These updates are used in the Impedance Track™ algorithms. It is critical that the battery voltage be relaxed during OCV readings to and that the current is not be higher than C/20 when attempting to go into relaxation mode.

**Quit Relax Time** specifies the minimum time required for *AverageCurrent()* to remain above the **QuitCurrent** threshold before exiting relaxation mode.

### Qmax 0 and Qmax 1

Generically called **Qmax**, these dynamic variables contain the respective maximum chemical capacity of the active cell profiles, and are determined by comparing states of charge before and after applying the load with the amount of charge passed. They also correspond to capacity at very low rate of discharge, such as C/20 rate. For high accuracy, this value is periodically updated by the bq27500/1 during operation. Based on the battery cell capacity information, the initial value of chemical capacity should be entered in the **Qmax n** field for each default cell profile. The Impedance Track™ algorithm will update these values and maintain them the associated actual cell profiles.

### Update Status 0 and Update Status 1

Bit 1 (0x02) of the **Update Status n** registers indicates that the bq27500/1 has learned new Qmax parameters and is accurate. The remaining bits are reserved. Bits 1 is user-configurable; however, it is also a status flag that can be set by the bq27500/1. Bit 1 should never be modified except when creating a golden image file as explained in the application note "Preparing Optimized Default Flash Constants for specific Battery Types" (see [SLUA334.pdf](#)). Bit 1 is updated as needed by the bq27500/1.

### Avg I Last Run

The bq27500 logs the current averaged from the beginning to the end of each discharge cycle. It stores this average current from the previous discharge cycle in this register. This register should never need to be modified. It is only updated by the bq27500/1 when required.

### Avg P Last Run

The bq27500/1 logs the power averaged from the beginning to the end of each discharge cycle. It stores this average power from the previous discharge cycle in this register. To get a correct average power reading the bq27500/1 continuously multiplies instantaneous current times *Voltage()* to get power. It then logs this data to derive the average power. This register should never need to be modified. It is only updated by the bq27500/1 when required.

### Delta Voltage

The bq27500/1 stores the maximum difference of *Voltage()* during short load spikes and normal load, so the Impedance Track™ algorithm can calculate remaining capacity for pulsed loads. It is not recommended to change this value.

### OCV, Default Ra, Rb, and Ra Tables

These tables contain encoded data and, with the exception of the **Default Ra Tables**, are automatically updated during device operation. No user changes should be made except for reading/writing the values from a pre-learned pack (part of the process for creating golden image files).

## 5.3 DETAILED DESCRIPTION OF DEDICATED PINS

### 5.3.1 The Operation Configuration Register

Some bq27500/1 pins are configured via the **Operation Configuration** data flash register, as indicated in [Table 5-3](#). This register is programmed/read via the methods described in [Section 4.2.1 Accessing the Data Flash](#). The register is located at subclass = 64, offset = 0.

**Table 5-3. Operation Configuration Bit Definition**

Operation Cfg	bit7	bit6	bit5	bit4	bit3	bit2	bit1	bit0
High Byte	RESCAP	–	–	PFC_CFG1	PFC_CFG0	IWAKE	RSNS1	RSNS0
Low Byte	–	IDSELEN	SLEEP	RMFCC	BATL_POL	BATG_POL	–	TEMPS

RESCAP = No-load rate of compensation is applied to the reserve capacity calculation. True when set. Default is 0.

PFC\_CFG1/PFC\_CFG0 = Pin Function Code (PFC) mode selection: PFC 0, 1, or 2 selected by 0/0, 0/1, or 1/0, respectively. Default is PFC 1 (0/1).

IWAKE/RSNS1/RSNS0 = These bits configure the current wake function (ref. [Table 5-3](#)). Default is 0/0/1.

IDSELEN = Enables cell profile selection feature. True when set. Default is 1.

SLEEP = The fuel gauge can enter sleep, if operating conditions allow. True when set. Default is 1.

RMFCC = RM is updated with the value from FCC, on valid charge termination. True when set. Default is 1.

BATL\_POL = BAT\_LOW pin is active-high. True when set. Default is 1.

BATG\_POL = BAT\_GD pin is active-low. True when cleared. Default is 0.

TEMPS = Selects external thermistor for Temperature( ) measurements. True when set. Default is 1.

### 5.3.2 Pin Function Code Descriptions

The bq27500/1 has three possible pin-function variations that can be selected in accordance with the circuit architecture of the end application. Each variation has been assigned a Pin Function Code, or PFC.

When the PFC is set to 0, only the bq27500/1 measures battery temperature under discharge and relaxation conditions. The charger does not receive any information from the bq27500/1 about the temperature readings, and therefore operates open-loop with respect to battery temperature.

A PFC of 1 is like a PFC of 0, except temperature is also monitored during battery charging. If charging temperature falls outside of the preset range defined in data flash, a charger can be disabled via the BAT\_GD pin, until cell temperature recovers. See [Section 5.6.2 Charge Inhibit](#) for additional details.

Finally when the PFC is set to 2, the battery thermistor can be shared between the fuel gauge and the charger. The charger has full usage of the thermistor during battery charging, while the fuel gauge uses the thermistor exclusively during discharge and battery relaxation.

The PFC is specified in **Operation Configuration [PFC\_CFG1, PFC\_CFG0]**. The default is PFC = 1.

### 5.3.3 BAT\_LOW Pin

The BAT\_LOW pin provides a system processor with an electrical indicator of battery status. The signaling on the BAT\_LOW pin follows the status of the [SOC1] bit in the Flags( ) register. Note that the polarity of the BAT\_LOW pin can be inverted via the [BATL\_POL] bit of **Operation Configuration**.

### 5.3.4 Power Path Control with the BAT\_GD Pin

The bq27500/1 must operate in conjunction with other electronics in a system appliance, such as chargers and other IC's and subcircuits that draw appreciable power. After a battery is inserted into the system, this electronics must be disabled, so that an accurate OCV can be read. The OCV is used for helping determine which battery profile to use, as it constitutes part of the battery impedance measurement.

When a battery is inserted into a system, the Impedance Track™ algorithm requires that no charging of the battery takes place and that any discharge is limited to less than C/20—these conditions are sufficient

for the fuel gauge to take an accurate OCV reading. To disable these functions, the  $\overline{\text{BAT\_GD}}$  pin is merely set *high* (floating output pulled high). Once an OCV reading has been made, the  $\overline{\text{BAT\_GD}}$  pin is pulled *low*, thereby enabling battery charging and regular discharge of the battery. The **Operation Configuration [BATG\_POL]** bit can be used to set the polarity of the battery good signal, should the default configuration need to be changed.

The flowchart of [Figure 5-1](#) details how the  $\overline{\text{BAT\_GD}}$  pin functions in the context of battery insertion and removal, as well as NORMAL vs SLEEP modes.

In PFC 1, the  $\overline{\text{BAT\_GD}}$  pin is also used to disable battery charging when the bq27500/1 reads battery temperatures outside the range defined by [**Charge Inhibit Temp Low, Charge Inhibit Temp High**]. The  $\overline{\text{BAT\_GD}}$  line is returned to *low* once temperature falls within the range [**Charge Inhibit Temp Low + Temp Hys, Charge Inhibit Temp High – Temp Hys**].

### 5.3.5 Battery Detection Using the BI/TOUT Pin

During power-up or HIBERNATE activities, or any other activity where the bq27500/1 needs to determine whether a battery is connected or not, the fuel gauge applies a test for battery presence. First, the BI/TOUT pin is put into high-Z status. The weak 1.8M $\Omega$  pull-up resistor will keep the pin high while no battery is present. When a battery is inserted (or is already inserted) into the system device, the BI/TOUT pin will be pulled low. This state is detected by the fuel gauge, which polls this pin every second when the gauge has power. A *battery disconnected* status is assumed when the bq27500/1 reads a thermistor voltage that is near 2.5V.



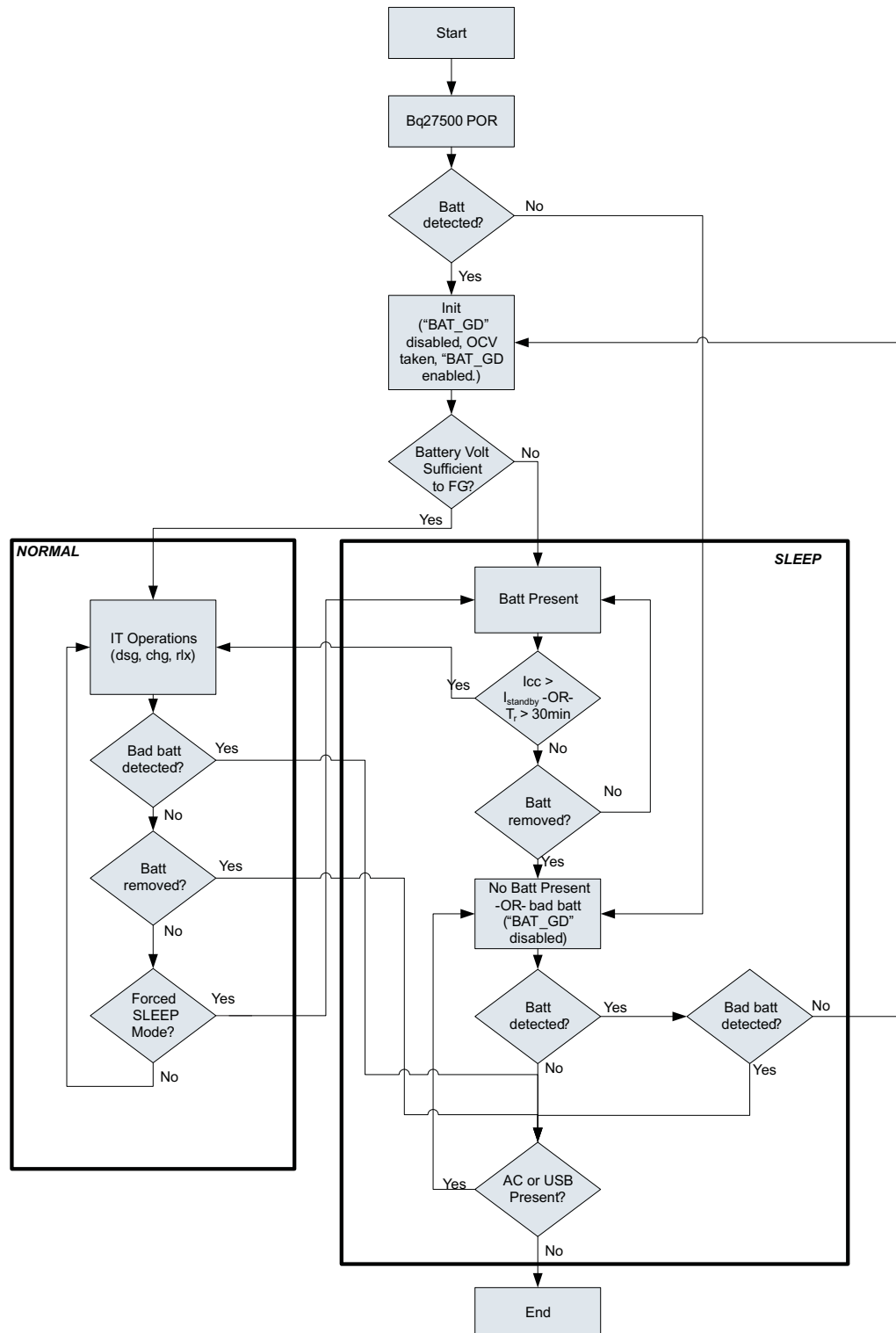

Figure 5-1. BAT\_GD Pin Operation, Based Upon Battery Presence and bq27500 Operating Mode

## 5.4 TEMPERATURE MEASUREMENT

The bq27500/1 measures battery temperature via its TS input, in order to supply battery temperature status information to Impedance Track™ and charger control sections of the gauge. Alternatively, it can also measure internal temperature via its on-chip temperature sensor, but only if the **[TEMPS]** bit of **Operation Configuration** register is cleared.

Regardless of which sensor is used for measurement, a system processor can request the current battery temperature by calling the *Temperature( )* function (see [Section 4.1.1 Standard Data Commands](#) for specific information).

The recommended thermistor circuit uses an external 103AT-type thermistor. Additional circuit information for connecting this thermistor to the bq27500/1 is shown in the [Section 8 Reference Schematic](#).

## 5.5 OVERTEMPERATURE INDICATION

### 5.5.1 Overtemperature: Charge

If during charging, *Temperature( )* reaches the threshold of **OT Chg** for a period of **OT Chg Time** and *AverageCurrent( )* > **Chg Current Threshold**, then the **[OTC]** bit of *Flags( )* is set. Note: if **OT Chg Time** = 0 then feature is completely disabled.

When *Temperature( )* falls to **OT Chg Recovery**, the **[OTC]** of *Flags( )* is reset.

### 5.5.2 Overtemperature: Discharge

If during discharging, *Temperature( )* reaches the threshold of **OT Dsg** for a period of **OT Dsg Time**, and *AverageCurrent( )* ≤ **-Dsg Current Threshold**, then the **[OTD]** bit of *Flags( )* is set. Note: if **OT Dsg Time** = 0, then feature is completely disabled.

When *Temperature( )* falls to **OT Dsg Recovery**, the **[OTD]** bit of *Flags( )* is reset.

## 5.6 CHARGING AND CHARGE-TERMINATION INDICATION

### 5.6.1 Detecting Charge Termination

For proper bq27500/1 operation, the cell charging voltage must be specified by the user. The default value for this variable is **Charging Voltage** = 4200mV.

The bq27500/1 detects charge termination when (1) during 2 consecutive periods of **Current Taper Window**, the *AverageCurrent( )* is < **Taper Current** and (2) during the same periods, the accumulated change in capacity > 0.25mAh / **Current Taper Window** and (3) *Voltage( )* > **Charging Voltage – Taper Voltage**. When this occurs, the **[CHG]** bit of *Flags( )* is cleared. Also, if the **[RMFCC]** bit of **Operation Configuration** is set, and *RemainingCapacity( )* is set equal to *FullChargeCapacity( )*.

### 5.6.2 Charge Inhibit

When PFC = 1, the bq27500/1 can indicate when battery temperature has fallen below or risen above predefined thresholds (**Charge Inhibit Temp Low** and **Charge Inhibit Temp High**, respectively). In this mode, the  $\overline{\text{BAT\_GD}}$  line is made *high* to indicate this condition, and is returned to its *low* state, once battery temperature returns to the range **[Charge Inhibit Temp Low + Temp Hys, Charge Inhibit Temp High – Temp Hys]**.

When PFC = 0 or 2, the bq27500/1 must be queried by the system in order to determine the battery temperature. At that time, the bq27500/1 will sample the temperature. This saves battery energy when operating from battery, as periodic temperature updates are avoided during charging mode.

## 5.7 POWER MODES

The bq27500/1 has four power modes: NORMAL, SLEEP, HIBERNATE, and BAT INSERT CHECK. In NORMAL mode, the bq27500/1 is fully powered and can execute any allowable task. In SLEEP mode, the fuel gauge exists in a reduced-power state, periodically taking measurements and performing calculations. In HIBERNATE mode, the fuel gauge is in its lowest power state, but can be woken up by communication activity or certain I/O activity. Finally, the BAT INSERT CHECK mode is a powered-up, but low-power halted, state, where the bq27500/1 resides when no battery is inserted into the system.

The relationship between these modes is shown in [Figure 5-2](#).

### 5.7.1 NORMAL MODE

The fuel gauge is in NORMAL Mode when not in any other power mode. During this mode, *AverageCurrent()*, *Voltage()* and *Temperature()* measurements are taken, and the interface data set is updated. Decisions to change states are also made. This mode is exited by activating a different power mode.

Because the gauge consumes the most power in NORMAL mode, the Impedance Track™ algorithm minimizes the time the fuel gauge remains in this mode.

### 5.7.2 SLEEP MODE

SLEEP mode is entered automatically if the feature is enabled (*Operation Configuration [SLEEP]* = 1) and *AverageCurrent()* is below the programmable level **Sleep Current**. Once entry into SLEEP mode has been qualified, but prior to entering it, the bq27500/1 performs an ADC autocalibration to minimize offset.

During SLEEP mode, the bq27500/1 periodically takes data measurements and updates its data set. However, a majority of its time is spent in an idle condition.

The bq27500/1 exits SLEEP if any entry condition is broken, specifically when (1) *AverageCurrent()* rises above **Sleep Current**, or (2) a current in excess of  $I_{WAKE}$  through  $R_{SENSE}$  is detected.

In the event that a battery is removed from the system while a charger is present (and powering the gauge), Impedance Track™ updates are not necessary. Hence, the fuel gauge enters a state that checks for battery insertion and does not continue executing the Impedance Track™ algorithm.

### 5.7.3 BAT INSERT CHECK MODE

This mode is a halted-CPU state that occurs when an adapter, or other power source, is present to power the bq27500/1 (and system), yet no battery has been detected. When battery insertion is detected, a series of initialization activities begin, which include: OCV measurement, setting the BAT\_GD pin, and selecting the appropriate battery profiles.

Some commands, issued by a system processor, can be processed while the bq27500/1 is halted in this mode. The gauge will wake up to process the command, then return to the halted state awaiting battery insertion.

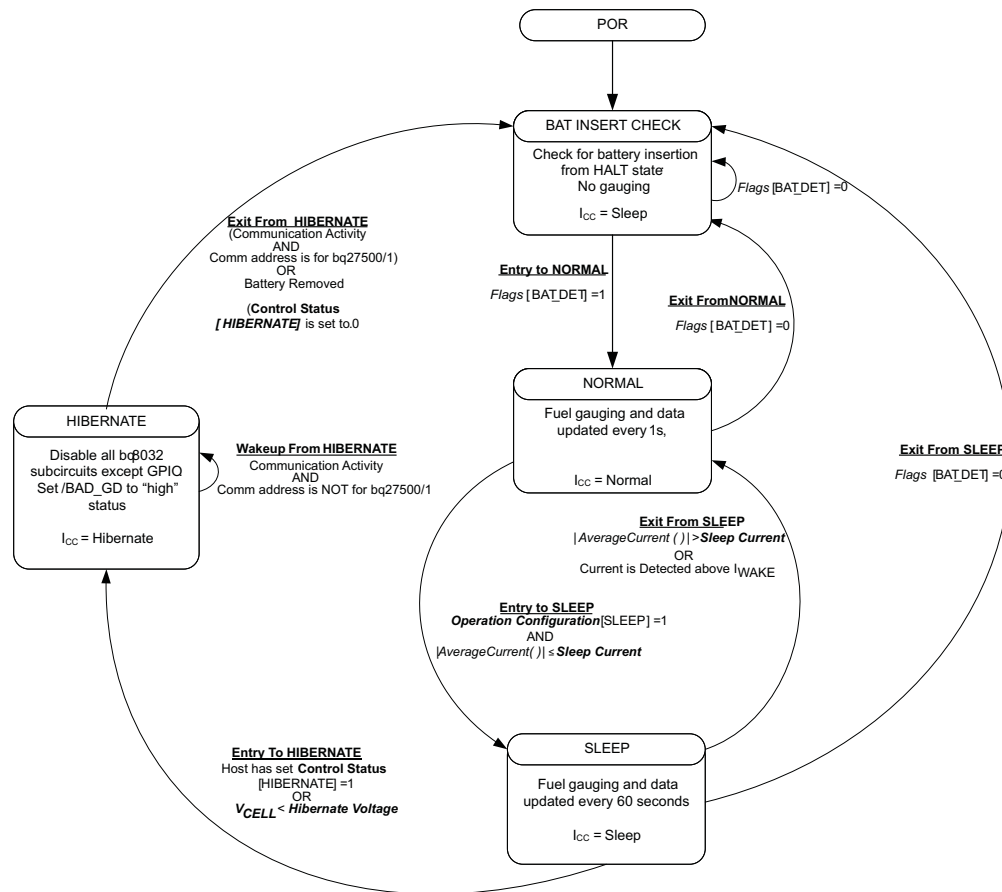

Figure 5-2. Power Mode Diagram

#### 5.7.4 HIBERNATE MODE

HIBERNATE mode should be used when the system equipment needs to enter a very low-power state, and minimal gauge power consumption is required. This mode is ideal when a system equipment is set to its own SLEEP, HIBERNATE, or SHUTDOWN modes.

To enter HIBERNATE mode, either the system must set the [HIBERNATE] bit of the CONTROL STATUS register OR the cell voltage must fall below **Hibernate Voltage**. The gauge will remain in HIBERNATE mode until the battery is removed, or the system issues a direct I<sup>2</sup>C command to the gauge. I<sup>2</sup>C Communication that is not directed to the gauge will not wake the gauge.

It is important that  $\overline{\text{BAT\_GD}}$  be set to *disable* status (no battery charging/discharging). This prevents a charger application from inadvertently charging the battery before an OCV reading can be taken. It is the system's responsibility to wake the bq27500/1 after it has gone into HIBERNATE mode. After waking, the gauge can proceed with the initialization of the battery information (OCV, profile selection, etc.)

## 5.8 POWER CONTROL

### 5.8.1 RESET FUNCTIONS

When the bq27500 detects software reset (*[RESET]* bit of *Control()* initiated), it determines the type of reset and increments the corresponding counter. This information is accessible by issuing the command *Control()* function with the *RESET\_DATA* subcommand.

As shown in [Figure 5-3](#) if a partial reset was detected, a RAM checksum is generated and compared against the previously stored checksum. If the checksum values do not match, the RAM is reinitialized (a *Full Reset*). The stored checksum is updated every time RAM is altered.

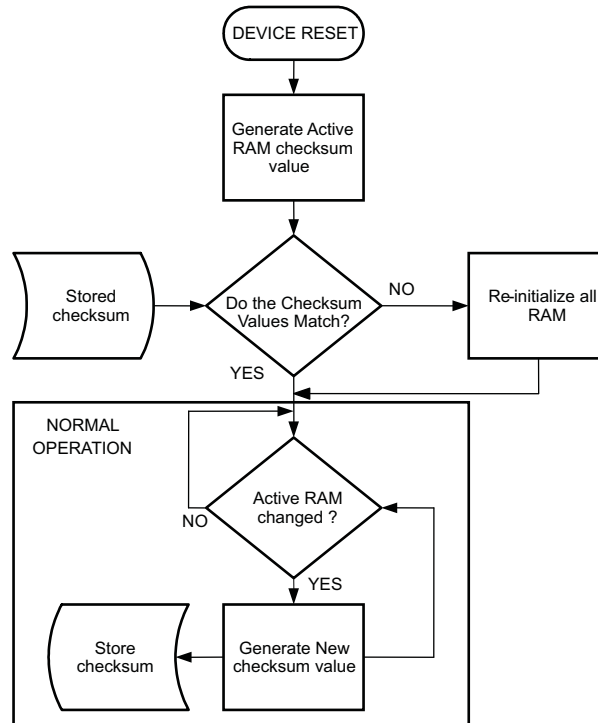

**Figure 5-3. Partial Reset Flow Diagram**

### 5.8.2 WAKE-UP COMPARATOR

The wake up comparator is used to indicate a change in cell current while the bq27500/1 is in either SLEEP or HIBERNATE modes. **Operation Configuration** uses bits **[RSNS1-RSNS0]** to set the sense resistor selection. **Operation Configuration** also uses the **[IWAKE]** bit to select one of two possible voltage threshold ranges for the given sense resistor selection. An internal interrupt is generated when the threshold is breached in either charge or discharge directions. Setting both **[RSNS1]** and **[RSNS0]** to "0" disables this feature.

**Table 5-4. I<sub>WAKE</sub> Threshold Settings<sup>(1)</sup>**

RSNS1	RSNS0	IWAKE	Vth(SRP-SRN)
0	0	0	Disabled
0	0	1	Disabled
0	1	0	1.25 mV or –1.25 mV
0	1	1	2.5 mV or –2.5 mV
1	0	0	2.5 mV or –2.5 mV
1	0	1	5 mV or –5 mV
1	1	0	5 mV or –5 mV
1	1	1	10 mV or –10 mV

(1) The actual resistance value vs. the setting of the sense resistor is not important just the actual voltage threshold when calculating the configuration.

### 5.8.3 FLASH UPDATES

Data Flash can only be updated if  $Voltage( ) \geq \text{Flash Update OK Voltage}$ . Flash programming current can cause an increase in LDO dropout. The value of **Flash Update OK Voltage** should be selected such that the bq27500/1  $V_{CC}$  voltage does not fall below its minimum of 2.4V during Flash write operations.

### 5.9 AUTO CALIBRATION

The bq27500 provides an autocalibration feature that measures the voltage offset error across SRP and SRN as operating conditions change. It subtracts the resulting offset error from normal sense resistor voltage,  $V_{SR}$ , for maximum measurement accuracy.

Auto calibration of the ADC begins on entry to SLEEP mode, except if  $Temperature( )$  is  $\leq 5^{\circ}\text{C}$  or  $Temperature( ) \geq 45^{\circ}\text{C}$ .

The fuel gauge also performs a single offset when (1) the condition of  $AverageCurrent( ) \leq 100\text{mA}$  and (2) {voltage change since last offset calibration  $\geq 256\text{mV}$ } or {temperature change since last offset calibration is greater than  $80^{\circ}\text{C}$  for  $\geq 60\text{s}$ }.

Capacity and current measurements will continue at the last measured rate during the offset calibration when these measurements cannot be performed. If the battery voltage drops more than 32mV during the offset calibration, the load current has likely increased considerably; hence, the offset calibration will be aborted.

## 6 APPLICATION-SPECIFIC INFORMATION

### 6.1 BATTERY PROFILE STORAGE AND SELECTION

#### 6.1.1 General Profile Description

When a battery pack is removed from system equipment that implements the bq27500/01, the fuel gauge will maintain some of the battery's information in case it is re-inserted. This way, the Impedance Track™ algorithm has a means of recovering battery-status information, thereby, maintaining good State-of-Charge (SOC) estimates.

Two default battery profiles are available to store battery information. They are used to provide the Impedance Track™ algorithm with the default information on two possible battery types expected to be used with the end-equipment. These default profiles can be used to support batteries of different chemistry, same chemistry but different capacities, or same chemistry but different models. Default profiles are programmed by the end-equipment manufacturer. Note that in the case of bq27500, only one of the default profiles can be selected, and this selection cannot be changed during end-equipment operation.

In addition to the default profiles, the bq27500/01 maintains two abbreviated profiles. These tables hold **dynamic** battery data, and keep track of the status for up to two of the most recent batteries used. In most cases the bq27500/01 can administrate information on two removable battery packs.

#### 6.1.2 Activities Upon Pack Insertion

##### 6.1.2.1 First OCV and Impedance Measurement

At power-up the  $\overline{\text{BAT\_GD}}$  pin is inactive, so that the system cannot obtain power from the battery (this depends on actual implementation). In this state, the battery is put in an open-circuit condition. Next, the bq27500/1 measures its first open-circuit voltage (OCV) via the BAT pin. From the OCV(SOC) table, the SOC of the inserted battery is found. Then the  $\overline{\text{BAT\_GD}}$  pin is made active, and the impedance of the inserted battery is calculated from the measured voltage and the load current:  $Z(\text{SOC}) = (\text{OCV}(\text{SOC}) - V) / I$ . This impedance is compared with the impedance of the dynamic profiles, **Packn Ra**, and default profiles, **Defn Ra**, for the same SOC (the letter "n" depicts either a "0" or "1").

##### 6.1.2.2 Reading Application Status

The **Application Status** data flash location contains cell profile status information, and can be read using the *ApplicationStatus( )* Extended Command (0x6a/0x6b). The bit configuration of this function/location is shown in [Section 6.1.3](#).

Table 6.1.3. ApplicationStatus( ) bit Definitions.

Application Configuration	bit7	bit6	bit5	bit4	bit3	bit2	bit1	bit0
Byte	—	—	—	—	—	—	UNSUPBAT	LU_PROF

UNSUPBAT = Flag indicating inserted battery is not supported in the current cell profiles. True when set. bq27501 only.  
LU\_PROF = Last profile used by gas gauge. Cell0 last used when cleared. Cell1 last used when set. Default is 0.

### 6.2 APPLICATION-SPECIFIC FLOW AND CONTROL

#### 6.2.1 Simple Battery (bq27500 Only)

The bq27500 supports only one type of battery profile. This profile is stored in both the **Def0 Ra** and **Def1 Ra** profiles. When a battery pack is inserted for the first time, the default profile is copied into the **Packn Ra** profiles. Then the Impedance Track™ algorithm begins gas gauging, regularly updating **Packn Ra** as the battery is used.

When an existing pack is removed from the bq27500 and a different (or same) pack is inserted, cell

impedance is measured immediately after battery detection. The bq27500 chooses the profile which is closest to the measured impedance, starting with the **Packn Ra** profiles. That is, if the measured impedance matches **Pack0 Ra**, then the **Pack0 Ra** profile is used. If the measured impedance matches **Pack1 Ra**, then the **Pack1 Ra** profile is used. If the measured impedance does not match the impedance stored in either **Pack0 Ra** or **Pack1 Ra**, the battery pack is deemed new (not any of the previously used packs). Either the **Def0 Ra** or **Def1 Ra** profile is copied into either the **Pack0 Ra** or **Pack1 Ra** profile, depending on which default impedance profile most closely matches. Care is taken not to over-write the last used **Packn Ra** profile.

### 6.2.2 Battery With Resistor ID (bq27501 Only)

The bq27501 can administrate the information of up to two battery packs. For a given pack connected to the fuel gauge, the identity of the battery is determined by a combination of (1) reading the pack ID resistor and (2) measuring the impedance of the currently connected pack, and (3) remembering which pack characteristics were most recently used by the gauge.

A battery pack's ID resistor should connect to the RID pin of the fuel gauge. Either 'A'  $\Omega$  or 'B'  $\Omega$  resistor values should be used, to indicate the battery type. If a battery connection is detected, bq27501 measures the voltage developed at RID. If the voltage is **Pack 0 Voltage**, then it is identified as battery pack with 'A' resistor and bq27501 will use the **Pack0 Ra** profile. If the voltage measured is **Pack 1 Voltage** then it is identified as battery pack with 'B' resistor and the bq27501 will use **Pack1 Ra** profile. The measurement window around each threshold is specified by **Pack V% Range**, which indicates the positive or negative deviation around each level. Choosing RID values of 500 $\Omega$  and 8k $\Omega$  for 'A' and 'B', correspond to **Pack 0 Voltage** and **Pack 1 Voltage** threshold levels of 110mV and 1070mV, respectively. These resistance values assume a 300 $\Omega$  resistance already exists in front of the RID pin for ESD protection.

If the bq27501 measures a voltage other than **Pack 0 Voltage** or **Pack 1 Voltage**, then it sets the **Application Configuration[UNSUPBAT]** to '1', alerting the system that the inserted battery is not supported. The system can use this information to download the default profile for this battery if one exists. The system should unseal the gauge, then download the new battery profile into the older **Defn Ra** memory profile. The last-used profile is indicated by the **Application Configuration[LU\_PROF]** bit. Overwriting the older default profile allows the bq27501 to retain information stored regarding the most recently used battery. After the new default profile is downloaded, the bq27501 clears the **Application Configuration[UNSUPBAT]**.

When the bq27501 starts operation for the first time, it copies the **Def0 Ra** profile into the **Pack0 Ra** profile and the **Def1 Ra** profile into the **Pack1 Ra** profile. Then when a battery pack is inserted for the first time, the bq27501 starts gauging using **Pack0 Ra** profile if the voltage measured on the RID pin is **Pack 0 Voltage**, or starts gauging using **Pack1 Ra** profile if the voltage measured on the RID pin is **Pack 1 Voltage**. The Impedance Track™ algorithm regularly updates the specific **Packn Ra** profile as the battery is used.

If a pack is replaced with a second pack having the same resistor ID as the first, cell impedance is measured after pack detection, as explained in [Section 6.1.2.1 First OCV and Impedance Measurement](#). This impedance is compared with the associated **Packn Ra** and **Defn Ra** profiles that correspond to the current RID. If the impedance matches the **Packn Ra** impedance then the **Packn Ra** profile is used. If not, the bq27501 resets the **Packn Ra** data, by copying the **Defn Ra** profile into the **Packn Ra** profile (this operation overwrites the previously stored information). The Impedance Track™ algorithm begins converging on the data for the new battery and storing it in the **Packn Ra** profile.



## 7 COMMUNICATIONS

### 7.1 I<sup>2</sup>C INTERFACE

The fuel gauge supports the standard I<sup>2</sup>C read, incremental read, one-byte write quick read, and functions. The 7-bit device address (ADDR) is the most significant 7 bits of the hex address and is fixed as 1010101. The 8-bit device address is therefore 0xAA or 0xAB for write or read, respectively.

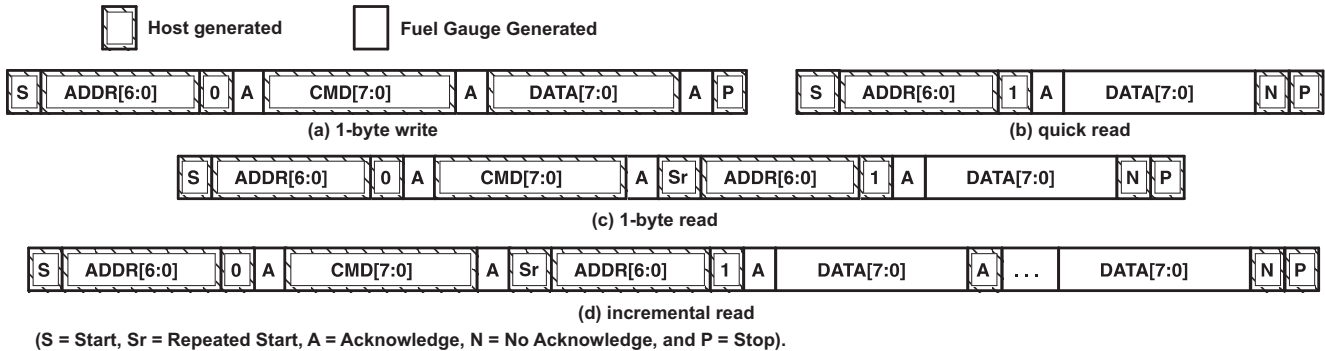
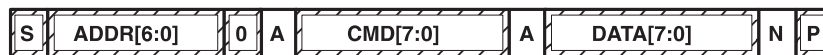

Figure 7-1. Supported I<sup>2</sup>C Formats

The *quick read* returns data at the address indicated by the address pointer. The address pointer, a register internal to the I<sup>2</sup>C communication engine, increments whenever data is acknowledged by the bq27500 or the I<sup>2</sup>C master. *Quick writes* function in the same manner and are a convenient means of sending multiple bytes to consecutive command locations (such as two-byte commands that require two bytes of data).

Attempt to write a read-only address (NACK after data sent by master):



Attempt to read an address above 0x7F (NACK command):



Attempt at incremental writes (NACK all extra data bytes sent):

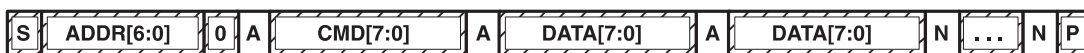

Incremental read at the maximum allowed read address:



The I<sup>2</sup>C engine releases both SDA and SCL if the I<sup>2</sup>C bus is held low for  $t_{(BUSERR)}$ . If the fuel gauge was holding the lines, releasing them frees the master to drive the lines. If an external condition is holding either of the lines low, the I<sup>2</sup>C engine enters the low-power sleep mode.

## 8 REFERENCE SCHEMATICS

### 8.1 SCHEMATIC

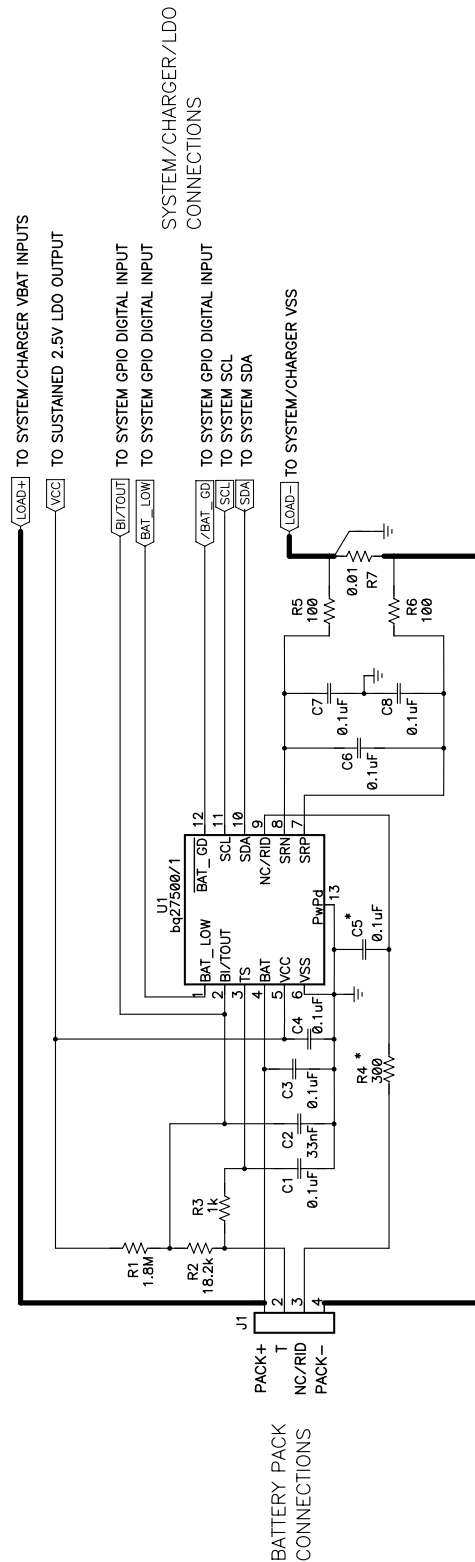

\* RID components not present for bq27500 application.

**PACKAGING INFORMATION**

Orderable Device	Status <sup>(1)</sup>	Package Type	Package Drawing	Pins	Package Qty	Eco Plan <sup>(2)</sup>	Lead/Ball Finish	MSL Peak Temp <sup>(3)</sup>
BQ27500DRZR	ACTIVE	SON	DRZ	12	3000	TBD	Call TI	Call TI
BQ27500DRZT	ACTIVE	SON	DRZ	12	250	TBD	Call TI	Call TI

<sup>(1)</sup> The marketing status values are defined as follows:

**ACTIVE:** Product device recommended for new designs.

**LIFEBUY:** TI has announced that the device will be discontinued, and a lifetime-buy period is in effect.

**NRND:** Not recommended for new designs. Device is in production to support existing customers, but TI does not recommend using this part in a new design.

**PREVIEW:** Device has been announced but is not in production. Samples may or may not be available.

**OBsolete:** TI has discontinued the production of the device.

<sup>(2)</sup> Eco Plan - The planned eco-friendly classification: Pb-Free (RoHS), Pb-Free (RoHS Exempt), or Green (RoHS & no Sb/Br) - please check <http://www.ti.com/productcontent> for the latest availability information and additional product content details.

**TBD:** The Pb-Free/Green conversion plan has not been defined.

**Pb-Free (RoHS):** TI's terms "Lead-Free" or "Pb-Free" mean semiconductor products that are compatible with the current RoHS requirements for all 6 substances, including the requirement that lead not exceed 0.1% by weight in homogeneous materials. Where designed to be soldered at high temperatures, TI Pb-Free products are suitable for use in specified lead-free processes.

**Pb-Free (RoHS Exempt):** This component has a RoHS exemption for either 1) lead-based flip-chip solder bumps used between the die and package, or 2) lead-based die adhesive used between the die and leadframe. The component is otherwise considered Pb-Free (RoHS compatible) as defined above.

**Green (RoHS & no Sb/Br):** TI defines "Green" to mean Pb-Free (RoHS compatible), and free of Bromine (Br) and Antimony (Sb) based flame retardants (Br or Sb do not exceed 0.1% by weight in homogeneous material)

<sup>(3)</sup> MSL, Peak Temp. -- The Moisture Sensitivity Level rating according to the JEDEC industry standard classifications, and peak solder temperature.

**Important Information and Disclaimer:**The information provided on this page represents TI's knowledge and belief as of the date that it is provided. TI bases its knowledge and belief on information provided by third parties, and makes no representation or warranty as to the accuracy of such information. Efforts are underway to better integrate information from third parties. TI has taken and continues to take reasonable steps to provide representative and accurate information but may not have conducted destructive testing or chemical analysis on incoming materials and chemicals. TI and TI suppliers consider certain information to be proprietary, and thus CAS numbers and other limited information may not be available for release.

In no event shall TI's liability arising out of such information exceed the total purchase price of the TI part(s) at issue in this document sold by TI to Customer on an annual basis.

DRZ (S-PDSO-N12)

PLASTIC SMALL OUTLINE

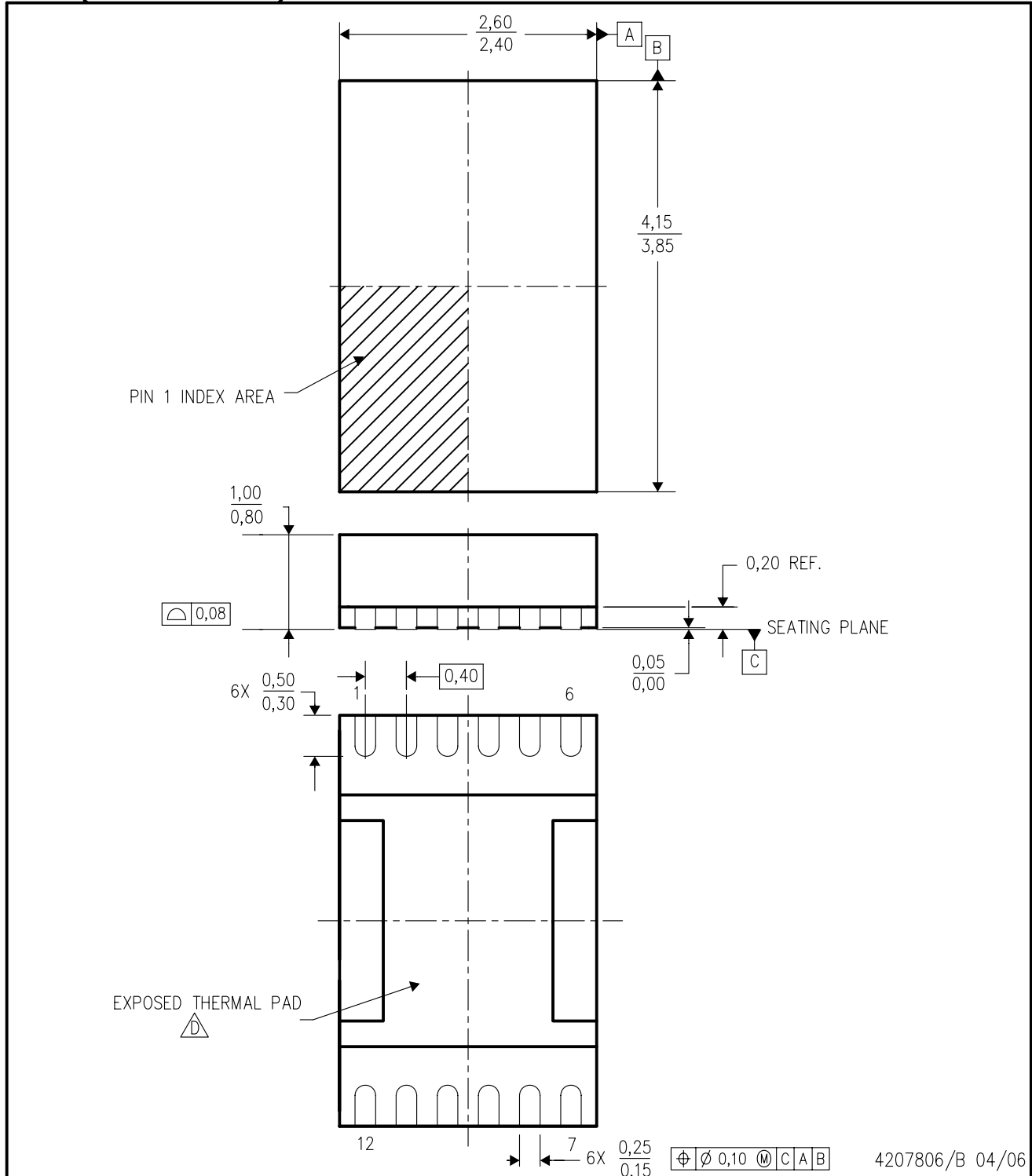

- NOTES:
- A. All linear dimensions are in millimeters. Dimensioning and tolerancing per ASME Y14.5M-1994.
  - B. This drawing is subject to change without notice.
  - C. Small Outline No-Lead (SON) package configuration.
  -  D. The package thermal pad must be soldered to the board for thermal and mechanical performance. See the Product Data Sheet for details regarding the exposed thermal pad dimensions.
  - E. This package is lead-free.

**THERMAL INFORMATION**

This package incorporates an exposed thermal pad that is designed to be attached directly to an external heatsink. The thermal pad must be soldered directly to the printed circuit board (PCB), the PCB can be used as a heatsink. In addition, through the use of thermal vias, the thermal pad can be attached directly to a ground plane or special heatsink structure designed into the PCB. This design optimizes the heat transfer from the integrated circuit (IC).

For information on the Quad Flatpack No-Lead (QFN) package and its advantages, refer to Application Report, Quad Flatpack No-Lead Logic Packages, Texas Instruments Literature No. SCBA017. This document is available at [www.ti.com](http://www.ti.com).

The exposed thermal pad dimensions for this package are shown in the following illustration.

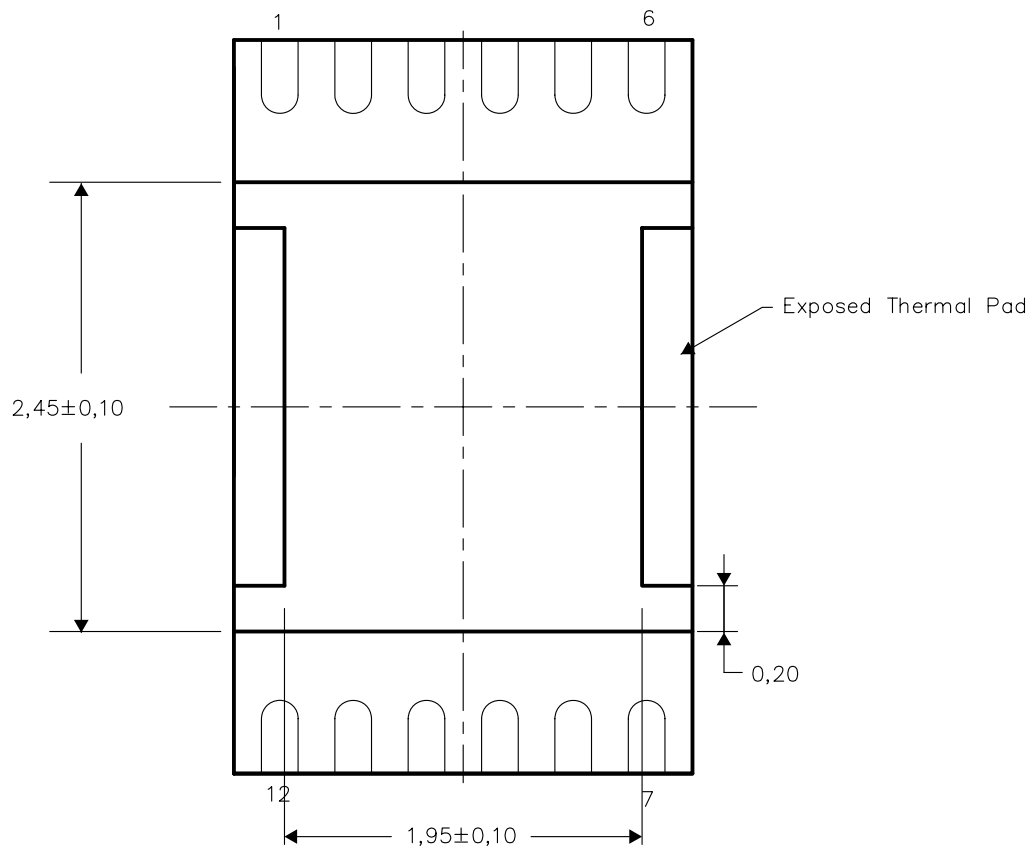

Bottom View

NOTE: All linear dimensions are in millimeters

Exposed Thermal Pad Dimensions

DRZ (S-PDSO-N12)

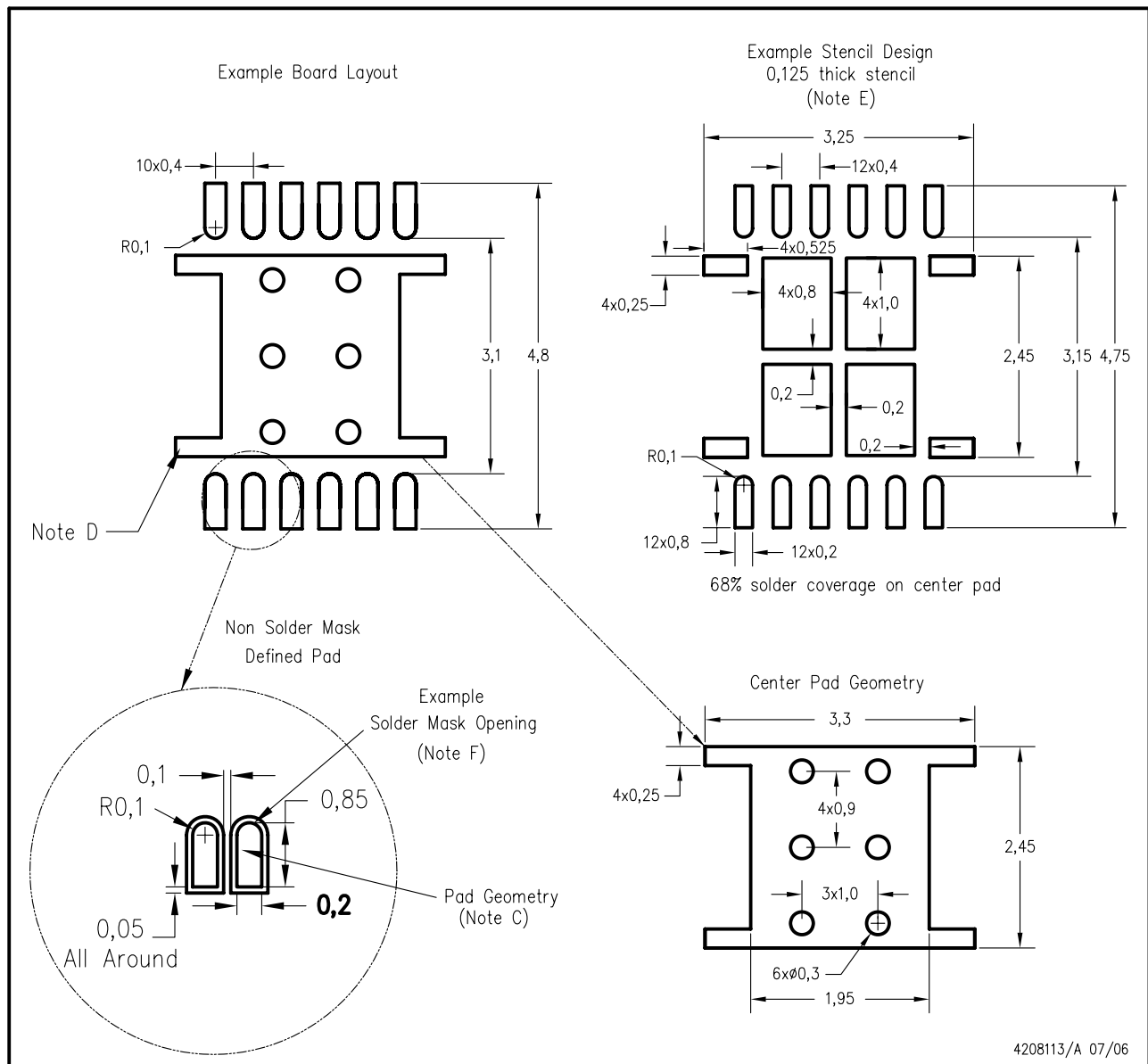

- NOTES:
- A. All linear dimensions are in millimeters.
  - B. This drawing is subject to change without notice.
  - C. Publication IPC-7351 is recommended for alternate designs.
  - D. This package is designed to be soldered to a thermal pad on the board. Refer to Application Note, Quad Flat-Pack Packages, Texas Instruments Literature No. SCBA017, SLUA271, and also the Product Data Sheets for specific thermal information, via requirements, and recommended board layout. These documents are available at [www.ti.com](http://www.ti.com) <<http://www.ti.com>>.
  - E. Laser cutting apertures with trapezoidal walls and also rounding corners will offer better paste release. Customers should contact their board assembly site for stencil design recommendations. Refer to IPC 7525 for stencil design considerations.
  - F. Customers should contact their board fabrication site for minimum solder mask web tolerances between signal pads.

## IMPORTANT NOTICE

Texas Instruments Incorporated and its subsidiaries (TI) reserve the right to make corrections, modifications, enhancements, improvements, and other changes to its products and services at any time and to discontinue any product or service without notice. Customers should obtain the latest relevant information before placing orders and should verify that such information is current and complete. All products are sold subject to TI's terms and conditions of sale supplied at the time of order acknowledgment.

TI warrants performance of its hardware products to the specifications applicable at the time of sale in accordance with TI's standard warranty. Testing and other quality control techniques are used to the extent TI deems necessary to support this warranty. Except where mandated by government requirements, testing of all parameters of each product is not necessarily performed.

TI assumes no liability for applications assistance or customer product design. Customers are responsible for their products and applications using TI components. To minimize the risks associated with customer products and applications, customers should provide adequate design and operating safeguards.

TI does not warrant or represent that any license, either express or implied, is granted under any TI patent right, copyright, mask work right, or other TI intellectual property right relating to any combination, machine, or process in which TI products or services are used. Information published by TI regarding third-party products or services does not constitute a license from TI to use such products or services or a warranty or endorsement thereof. Use of such information may require a license from a third party under the patents or other intellectual property of the third party, or a license from TI under the patents or other intellectual property of TI.

Reproduction of TI information in TI data books or data sheets is permissible only if reproduction is without alteration and is accompanied by all associated warranties, conditions, limitations, and notices. Reproduction of this information with alteration is an unfair and deceptive business practice. TI is not responsible or liable for such altered documentation. Information of third parties may be subject to additional restrictions.

Resale of TI products or services with statements different from or beyond the parameters stated by TI for that product or service voids all express and any implied warranties for the associated TI product or service and is an unfair and deceptive business practice. TI is not responsible or liable for any such statements.

TI products are not authorized for use in safety-critical applications (such as life support) where a failure of the TI product would reasonably be expected to cause severe personal injury or death, unless officers of the parties have executed an agreement specifically governing such use. Buyers represent that they have all necessary expertise in the safety and regulatory ramifications of their applications, and acknowledge and agree that they are solely responsible for all legal, regulatory and safety-related requirements concerning their products and any use of TI products in such safety-critical applications, notwithstanding any applications-related information or support that may be provided by TI. Further, Buyers must fully indemnify TI and its representatives against any damages arising out of the use of TI products in such safety-critical applications.

TI products are neither designed nor intended for use in military/aerospace applications or environments unless the TI products are specifically designated by TI as military-grade or "enhanced plastic." Only products designated by TI as military-grade meet military specifications. Buyers acknowledge and agree that any such use of TI products which TI has not designated as military-grade is solely at the Buyer's risk, and that they are solely responsible for compliance with all legal and regulatory requirements in connection with such use.

TI products are neither designed nor intended for use in automotive applications or environments unless the specific TI products are designated by TI as compliant with ISO/TS 16949 requirements. Buyers acknowledge and agree that, if they use any non-designated products in automotive applications, TI will not be responsible for any failure to meet such requirements.

Following are URLs where you can obtain information on other Texas Instruments products and application solutions:

<b>Products</b>		<b>Applications</b>	
Amplifiers	<a href="http://amplifier.ti.com">amplifier.ti.com</a>	Audio	<a href="http://www.ti.com/audio">www.ti.com/audio</a>
Data Converters	<a href="http://dataconverter.ti.com">dataconverter.ti.com</a>	Automotive	<a href="http://www.ti.com/automotive">www.ti.com/automotive</a>
DSP	<a href="http://dsp.ti.com">dsp.ti.com</a>	Broadband	<a href="http://www.ti.com/broadband">www.ti.com/broadband</a>
Interface	<a href="http://interface.ti.com">interface.ti.com</a>	Digital Control	<a href="http://www.ti.com/digitalcontrol">www.ti.com/digitalcontrol</a>
Logic	<a href="http://logic.ti.com">logic.ti.com</a>	Military	<a href="http://www.ti.com/military">www.ti.com/military</a>
Power Mgmt	<a href="http://power.ti.com">power.ti.com</a>	Optical Networking	<a href="http://www.ti.com/opticalnetwork">www.ti.com/opticalnetwork</a>
Microcontrollers	<a href="http://microcontroller.ti.com">microcontroller.ti.com</a>	Security	<a href="http://www.ti.com/security">www.ti.com/security</a>
RFID	<a href="http://www.ti-rfid.com">www.ti-rfid.com</a>	Telephony	<a href="http://www.ti.com/telephony">www.ti.com/telephony</a>
Low Power Wireless	<a href="http://www.ti.com/lpw">www.ti.com/lpw</a>	Video & Imaging	<a href="http://www.ti.com/video">www.ti.com/video</a>
		Wireless	<a href="http://www.ti.com/wireless">www.ti.com/wireless</a>

Mailing Address: Texas Instruments, Post Office Box 655303, Dallas, Texas 75265  
Copyright © 2007, Texas Instruments Incorporated

## Free Manuals Download Website

<http://myh66.com>

<http://usermanuals.us>

<http://www.somanuals.com>

<http://www.4manuals.cc>

<http://www.manual-lib.com>

<http://www.404manual.com>

<http://www.luxmanual.com>

<http://aubethermostatmanual.com>

Golf course search by state

<http://golfingnear.com>

Email search by domain

<http://emailbydomain.com>

Auto manuals search

<http://auto.somanuals.com>

TV manuals search

<http://tv.somanuals.com>