

Owner's Manual — 200 HT LGR Dehumidifier

Installation, Operation and Service Instructions

Read and Save These Instructions

The Phoenix 200 HT features LGR (low grain refrigerant) technology. This technology enables the 200 HT to remove more water and create more grain depression than standard refrigerant dehumidifiers.

Combined with this performance, the multiple ducting and the superior high temperature performance makes the Phoenix 200 HT the most effective and versatile drying device made.

The Phoenix 200 HT LGR Dehumidifier

In-Board Wheels - Reduces outer dimensions for tighter storage setups and does not catch on obstructions for easier movement around the jobsite.

Recessed Condensate Hose - Does not catch on obstructions and allows for dense storage setups by reducing overall width of the unit.

Increased Capacity - The Phoenix 200 HT removes 5% more water than the 200 MAX.

Improved High-Ambient Performance - Patent pending technology allows superior efficiency in high-ambient conditions.

Focused Airflow - Patent pending focused outlet directs air toward the most wet surface.

325 CFM - More processed air speeds drying and provides superior static pressure for ducting.

More Grain Depression - The driest air from an LGR gets your jobs drier quicker.

Air Filter - A MERV-11 is standard.

Multiple Ducting Options - 12" intake, 10" exhaust.

Energy Efficiency - Draws 7.5 amps.

Skid Plate - Protects the 200 HT from damage while transporting, loading and unloading.



Phoenix 200 HT
PN 4025900

Table of Contents

Introduction	1
1. Specifications.....	2
2. Operation	2
2.1 Transporting	2
2.2 Electrical Requirements	2
2.3 Condensate Removal	2
2.4 Ducting.....	2
2.5 Power Switch	3
2.6 Pump Purge Switch	3
2.7 Hour Meter	3
2.8 Temperature Specific Operation	3
2.9 Low Pressure Control	4
3. Maintenance	4
3.1 Air Filter	4
3.2 Storage	4
4. Service	4
4.1 Technical description	5
4.2 Troubleshooting	5
4.3 Blower Replacement	6
4.4 Defrost Thermostat and Timer	6
4.5 Condensate Pump	6
4.6 Gravity Drain Option	6
4.7 Relay.....	7
5. Options and Accessories	7
6. Wiring Diagram	7
7. Service Parts	8
8. Warranty	9

Serial No. _____

Purchase Date ____/____/____

Dealer's Name _____

Read the operation and maintenance instructions carefully before using this unit. Proper adherence to these instructions is essential to obtain maximum benefit from your Phoenix 200 HT dehumidifier.

WARNING

- It is designed to be used **INDOORS ONLY**.
- If used in a wet area, plug it into a **GROUND FAULT INTERRUPTER**.
- **DO NOT** use the Phoenix 200 HT as a bench or table.
- It must always be used in the upright position.

1 Specifications

Part No.	4025900
Power	7.5 amps, 110-120 VAC, Grounded
Water Removal	140 pints/day @ AHAM (80°F, 60%) 26 pints/day @ saturation 32 gal/day maximum @ saturation
Blower	325 CFM without external ducting 310 CFM @ .15 IWG external static
Operating Range	33°F min., 125°F max.
Refrigerant Charge	1 lbs., 14 oz. R-22
Filters	16" x 20" x 2" Pleated Media MERV-11
Duct Options	Intake – 12" Flex-Duct Supply – 10" Lay-Flat
Warranty	Five years; 1st year 100% of Parts and Labor 2nd–5th year 100% of Parts of sealed refrigeration system.

Dimensions

	Machine	Shipping
Width	20.25"	24"
Height	40"	45.25"
Depth	21.375"	25.5"
Weight	138 lb	164 lb

2 Operation

2.1 Transporting

The Phoenix 200 HT must always be upright when transported by vehicle. It may be tipped onto its handle and back for loading and moving by hand. The Phoenix 200 HT features a high-impact plastic skid plate which protects the unit while navigating obstacles such as curbs, stairways, and while loading into vehicles.

2.2 Electrical Requirements

The Phoenix 200 HT plugs into a common grounded outlet on a 15 Amp circuit. It draws 7.5 Amps at 80°F, 60% RH. If used in a wet area, a ground fault interrupter (GFI) is required. If an extension cord is required, it must have a minimum of 14 gauge conductors if 25 feet long or less and 12 gauge conductors if greater than 25 feet long.

2.3 Condensate Removal

The Phoenix 200 HT is equipped with an internal condensate pump to remove the water that is condensed during dehumidification. This allows the condensate to be pumped 20' with the attached hose. If the condensate must be pumped more than 20 feet above the unit, a second pump must be added to relay the condensate. If the pump fails and the unit must be used before it can be replaced, the condensate can be drained by gravity.

The air inlet on top and the side outlet must be at least 1 foot from walls and other obstructions to air flow. If the humid area is very large, dehumidification can be improved by adding an outlet duct to circulate air to stagnant areas.

2.4 Ducting

A detachable rectangular exhaust collar is supplied to allow 10" round lay-flat duct to be attached to the Phoenix 200 HT outlet. Lay-flat plastic ducting is available. See accessories on page 6. To attach ducting to a collar, put the plastic duct end through the collar center and roll the duct end outward so that it overlaps the outside of the collar. The duct and collar may then be quickly attached to the Phoenix 200 HT by snapping the collar over the four screws at the blower outlet.

2.5 Power Switch

The power switch (right of hour meter) lights up when the unit is turned on. The unit will continue to run in all conditions until the switch is turned off; there is no dehumidistat. If the unit is going to run for more than 2 hours in an area below 50°F, the defrost timer should be adjusted to improve performance.

2.6 Purge Switch

Pressing and holding the purge switch (left of hour meter) will cause the condensate pump to run. This pump minimizes the water left in the condensate reservoir prior to moving or storage. Hold the switch in until the flow from the condensate hose stops.

2.7 Hour Meter

The digital hour meter measures the cumulative time that the unit is turned on to tenths of an hour. It stores its total when the unit is unplugged; the previous total will be displayed when the unit is next turned on. It resets to zero after 99,999.9 hours of operation.

2.8 Temperature Specific Operation

Above 90°F - When the Phoenix 200 HT is used in high temperature conditions (above 90°F), the refrigerant pressure inside the condenser rises. By removing the grain control magnet from the bypass openings, additional airflow is directed over the condenser and less airflow

is directed across the evaporator. This airflow lowers the refrigerant pressure in the condenser and improves dehumidifier efficiency. The relative reduction or slowing of airflow across the evaporator allows more time for the air temperature to be lowered to the dew point, which also increased dehumidifier efficiency. These higher temperatures are often found after the first 24 hours. See Figure 1 for correct grain control magnet position for operating in temperatures above 90°F.

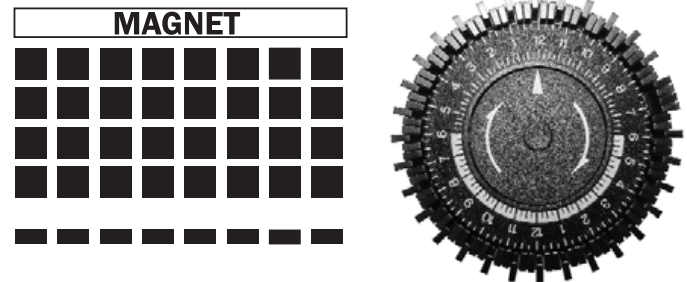

Figure 1: Defrost timer and grain control magnet position for operating in temperatures above 90°F.

Between 50°F - 90°F - When the Phoenix 200 HT is used in normal dehumidifier operating temperatures (70°F to 90°F), the grain control magnet should cover the bypass openings.

This allows increased airflow across the evaporator and increases performance by increasing the amount of air that is dehumidified. This temperature range is often found during the first 24 hours of a drying job. When the Phoenix 200 HT is used in cooler operating temperatures (50°F to 70°F), the grain control magnet increases airflow across the evaporator and reduces frost formation. See Figure 2 below for correct grain control magnet position for operating in temperatures from 50°F to 90°F.

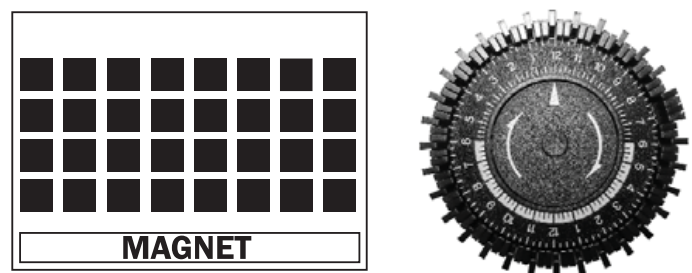

Figure 2: Defrost timer and grain control magnet position for operating in temperatures above 50°F to 90°F.

Below 50°F -When the Phoenix 200 HT is used in very cool operating temperatures (below 50°F), frost will form on the evaporator coil as it dehumidifies. When enough frost forms, the defrost thermostat will initiate the timed defrost cycle. The cycle periodically turns off the compressor while allowing the blower to run. The grain control magnet should cover the bypass openings in this operating range because the increased airflow and static pressure will help defrost

the evaporator more quickly and efficiently. See Figure 3 below for correct grain control magnet position and defrost timer for operating in temperatures below 50°F.

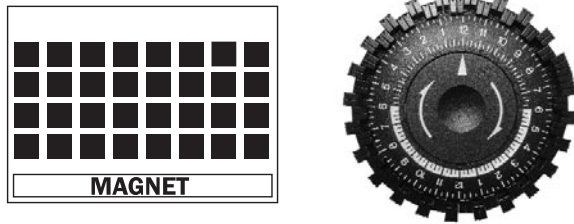

Figure 3: Defrost timer and grain control magnet position for operating in temperatures below 50°F.

DRYING TIP: Air's ability to absorb moisture from wet surroundings and the Phoenix 200 HT's ability to remove moisture from that air is greatly improved at higher temperatures. The defrost cycle is automatic and designed for optimum performance above 50°F. If the unit is used in an area that is below 50°F for more than 2 hours, adjustment of the defrost timer is recommended.

To adjust the defrost timer:

1. Unplug the unit.
2. Remove the top panel and the front cover (6 screws).
3. The timer is fastened to the base at the front of the unit. Every third peg around the dial is pushed out from the dial center except one section with 4 pegs out in a row. The grain control (8 holes at the intake of the unit below the filter) should be open. Refer to Figures 2 and 3.
4. To improve performance below 50°F, the compressor "off" time must be increased to allow the frost to completely melt. To do this, push the pegs out from the dial center so that the pegs alternate with 2 toward the center, then 2 out from the center, all the way around the dial except for the section now with 6 pegs out in a row. Refer to Figure 3.
5. Replace the cover and top panel.

2.9 Low Pressure Control

If the low side refrigerant pressure drops to 15 PSIG, the low pressure control opens and shuts off the compressor and blower. It is an automatically reset control. Its primary function is to prevent damage to the compressor if a leak develops in the refrigeration system. It may also open if the unit is A) used in a cool area (below 50°F) and the defrost timer is not adjusted or B) stored where it is below 40°F and then started. Under these conditions, the unit will restart within several minutes; it may cycle several times until the unit warms up.

3 Maintenance

3.1 Air Filter

The Phoenix 200 HT is equipped with a pleated fabric air filter that must be checked regularly. The standard filter is a MERV-11 high efficiency filter. Operating the unit with a dirty filter will reduce the dehumidifier's capacity and efficiency and may cause the compressor to cycle off and on unnecessarily on the defrost control.

The filter can generally be vacuumed clean several times before needing replacement. Replacement filters can be ordered from the factory or purchased locally if available.

! WARNING

WARNING: *DO NOT operate the unit without the filter or with a less effective filter as the heat exchange coils inside the unit could become clogged and require disassembly to clean.*

3.2 Storage

There are two issues to consider when the Phoenix 200 HT is stored between uses and both pertain to the water trapped in the unit: damage caused by freezing or biological growth.

The effect of the trapped water can be greatly reduced if precautions are taken to remove as much as possible before storage.

1. Use the pump purge switch to reduce the water level in the reservoir.
2. Stretch the hose flat to drain it completely.

If the unit will not be exposed to freezing temperatures, an alternative to reduce biological growth is to flush the unit with a bio-fungicide that is approved for use with copper, aluminum and polyethylene. To flush:

1. Run the hose to a drain.
2. Remove the air filter. Slowly pour a quart of the chemical through the top grille so that it drains into the plastic slots.
4. Hold in the pump purge switch to reduce the water level in the reservoir.

4 Service

! WARNING

WARNING: *Servicing the Phoenix 200 HT with its high pressure refrigerant system and high voltage circuitry presents a health hazard which could result in death, serious bodily injury, and/or property damage. Only qualified service people should service this unit.*

Do not operate unit without the front panel in place.

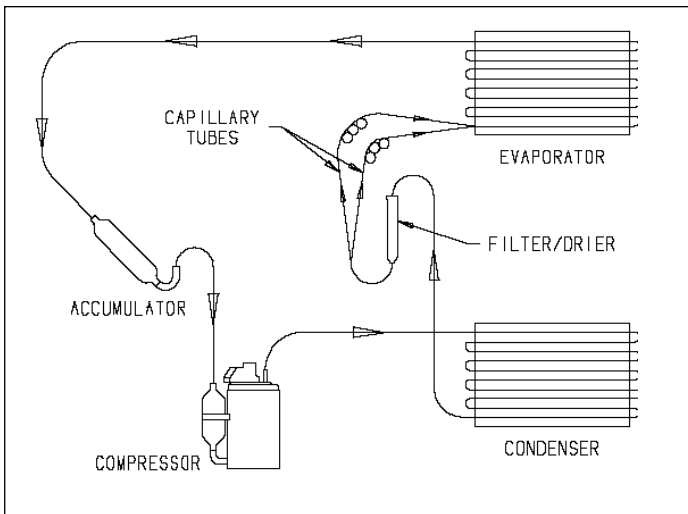

Figure 4: Refrigeration system

4.1 Technical Description

The Phoenix 200 HT uses a refrigeration system similar to an air conditioner's to remove heat and moisture from incoming air and to add heat to the air that is discharged.

Hot, high pressure refrigerant gas is routed from the compressor to the condenser coil. The refrigerant is cooled and condensed by giving up its heat to the air that is about to be discharged from the unit. The refrigerant liquid then passes through a filter/drier and capillary tubing which cause the refrigerant pressure and temperature to drop. It next enters the evaporator coil where it absorbs heat from the incoming air and evaporates.

The evaporator operates in a flooded condition, which means that all the evaporator tubes contain liquid refrigerant during normal operation. A flooded evaporator should maintain constant pressure and temperature across the entire coil, from inlet to outlet.

The mixture of gas and liquid refrigerant enter the accumulator after leaving the evaporator coil. The accumulator prevents any liquid refrigerant from reaching the compressor. The compressor evacuates the cool refrigerant gas from the accumulator and compresses it to a high pressure and temperature to repeat the process.

4.2 Troubleshooting

No dehumidification, neither blower nor compressor run and power switch does not light when ON.

1. Unit unplugged or no power to outlet.
2. Power switch defective.
3. Loose connection in internal wiring.

No dehumidification, neither blower nor compressor run with power switch ON and lit.

1. Low pressure control open.
2. Power switch defective.
3. Loose connection in internal wiring.

Some dehumidification, blower runs continuously but compressor only runs sporadically.

1. Unit is in defrost cycle.
2. Defrost thermostat defective or loose.
3. Loose connection in compressor circuit.
4. Defective compressor overload.
5. Defective compressor.
6. Defective relay.

No dehumidification, blower runs but compressor does not.

1. Bad connection in compressor circuit.
2. Pump safety switch closed.
3. Defective compressor capacitor.
4. Defective compressor overload.
5. Defective compressor.
6. Defective relay.

Blower does not run. Compressor runs briefly but cycles on and off.

1. Loose connection in blower circuit.
2. Obstruction prevents impeller rotation.
3. Defective blower.

Unit removes some water but not as much as expected.

1. Air temperature and/or humidity have dropped.
2. Humidity meter and/or thermometer used are out of calibration.
3. Unit has entered defrost cycle.
4. Air filter dirty.
5. Defrost timer incorrectly set for conditions.
6. Defective defrost thermostat.
7. Low refrigerant charge.
8. Air leak such as loose cover.
9. Defective compressor.
10. Restrictive exhaust ducting.

Unit runs but does not pump water.

1. Hose kinked or plugged.
2. Pump motor or float switch defective.
3. Pump check valve plugged.
4. Bad connection in pump circuit.
5. Hose disconnected internally.

Unit pumps water automatically but not when purge switch is pushed.

1. Bad connection in purge switch circuit.
2. Defective purge switch.

Evaporator coil frosted continuously, low dehumidifying capacity.

1. Defrost thermostat loose or defective.
2. Defrost timer incorrectly set or defective.
3. Low refrigerant charge.
4. Dirty air filter or air flow restricted.

Compressor runs with power switch OFF.

1. Defective relay.
2. Defective power switch.

4.3 Blower Replacement

The motorized impeller has a PSC motor and internal thermal overload protection. If defective, the complete assembly must be replaced.

1. Unplug the power cord.
2. Remove the top panel and cabinet front (6 screws).
3. Disconnect the impeller leads.
4. Remove four screws holding the impeller to the impeller brackets.
5. Remove four screws holding the impeller brackets to the condenser shroud.
6. Remove impeller and impeller brackets. Use care to avoid hooking wiring, tubing or electrical components.
7. Reassemble with the new impeller in the above procedure reversed.

4.4 Defrost Thermostat and Timer

The defrost thermostat is attached to the refrigerant suction tube between the accumulator and compressor. If the low side refrigerant temperature drops due to excessive frost formation on the evaporator coil, the thermostat opens. The compressor is then cycled off and on by the defrost timer. The blower will continue to run, causing air to flow through the evaporator coil and melt the ice when the compressor is off. When the air temperature and/or humidity increase, the evaporator temperature will rise and the thermostat will close to end the defrost cycle. To improve performance in low temperatures refer to Section 3 for defrost timer adjustment.



Figure 5: Defrost thermostat



Figure 6: Defrost timer

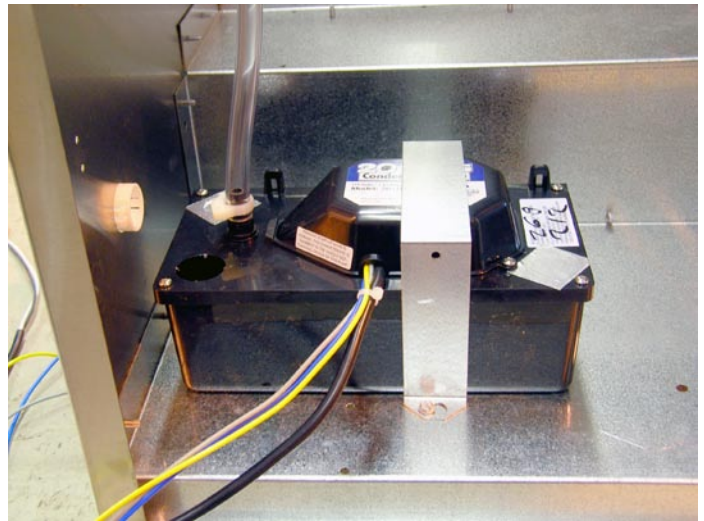

Figure 7: Condensate pump

4.5 Condensate Pump

Condensate is automatically pumped when the water level in the pump's reservoir rises to close the float switch or if the pump purge switch is held in.

To replace the condensate pump:

1. Remove the metal strap holding the pump by loosening the 2 screws holding it in place.
2. Disconnect the leads.
3. Installation is the reverse of above, but check that the plastic inlet and outlet hoses do not rub against copper refrigerant tubes.

4.6 Gravity Drain Option

If the condensate pump fails and cannot be replaced immediately, the Phoenix 200 HT can be used by draining by gravity.

1. Unplug the unit and remove the front cover.
2. Push the plastic plug on the left side out from inside the unit.
3. Locate the heavy vinyl hose that connects the drain pan to the condensate pump. Pull the end out of the pump.
4. Push that end of the vinyl hose through the hole in the left side.
5. Connect a garden hose and run it to a drain. Keep the hose as flat to the floor as possible to avoid air pockets that would hinder draining. Placing the unit on something above the floor will also improve draining.

4.7 Relay

The contacts of the single pole, single throw relay complete the power circuit to the compressor. The contacts are closed when power is provided to the relay coil via the control circuit. The control circuit includes the power switch, low pressure control, defrost thermostat and timer.

5 Options and Accessories

- 4024682 Air Filter, Pleated, 2" x 16" x 20" 57% MERV-8
- 4024750 Intake Flex Duct 12" x 25" Metalized Polyester
- 4024935 Lay-Flat Duct, 10" Round x 250' Roll

6 Wiring Diagram

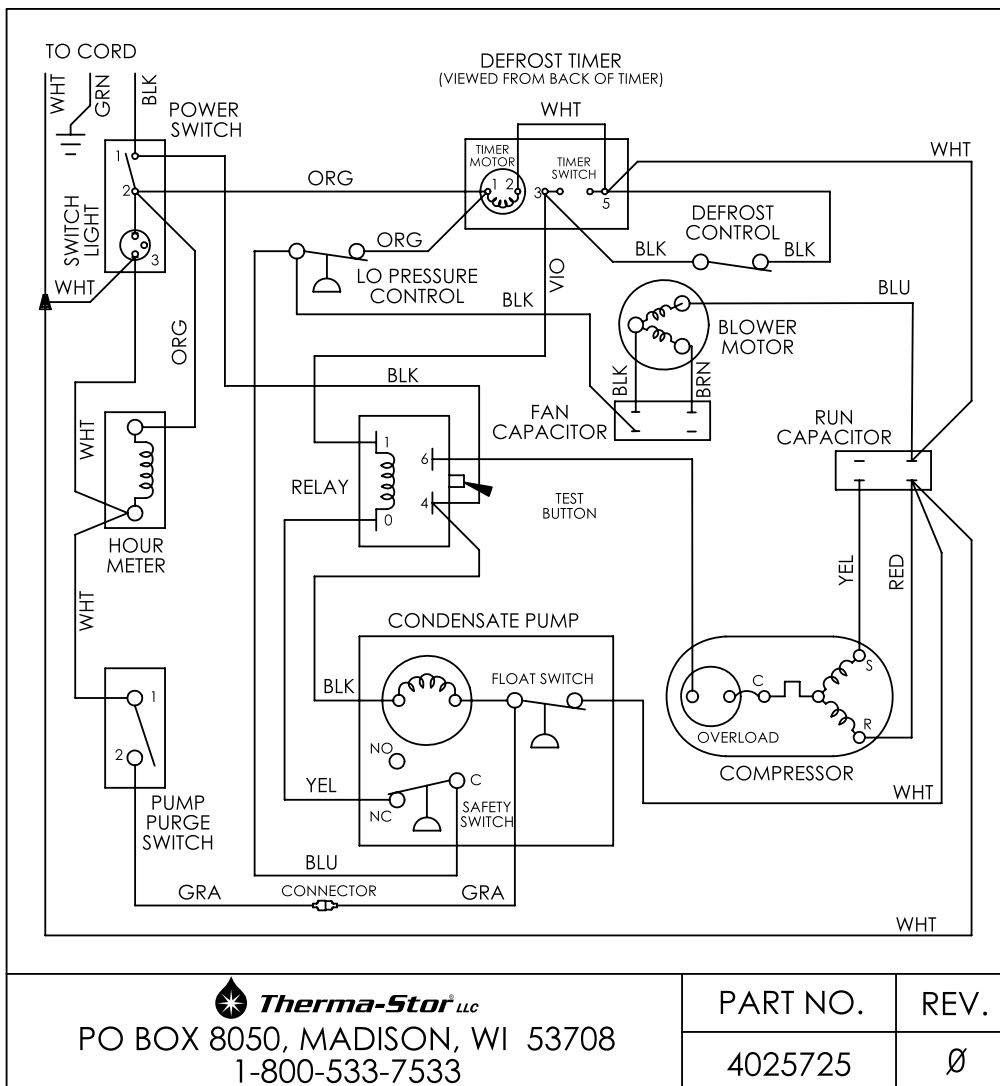

Figure 8: Wiring diagram

8 Service Parts

Item	Description	Qty	Part No.
1	Air Filter, Pleated, 2 X 16 X 20	1	4021475
2	Cord	1	4025078
3	Front Panel Retaining Nut, 1/4-20	1	4023362
4	Wheel, 8"	2	4025676
	Wheel Hub Cap	2	4024816
	Retaining Ring	2	4025454
	Hub Cap Retaining Washer	2	4025295
5	Coupling Body, 1/4 Tube	1	4024910
6	Foot	2	4024073
7	Defrost Timer	1	4021823
8	Low Pressure Control	1	4022219
9	Filter/Drier	1	4025087
10	Compressor, Carlyle (P/N EAA090111A)	1	4022213
	Overload, Carlyle Compressor	1	4022476
11	Capillary Tubes	2	4021589
12	Defrost Thermostat	1	4021470
	Defrost Thermostat Mounting Clip	1	4021648
13	Evaporator Coil	1	4021395
14	Accumulator	1	4022254
15	Top	1	4024903
16	Handle Assembly	1	4026094

Item	Description	Qty	Part No.
17	Pump Purge Switch	1	4021796
18	Hour Meter	1	4021597
19	Power Switch	1	4021822
20	Skid Plate	1	4025691
21	Instruction Label	1	4025723
22	Handle Screw (M10-1.5 x 35)	1	1177792
	Handle Washer	1	4025517
	Handle Nut (M10-1.5)	1	1223780

Items listed below are not shown

Drain Hose (.25 ID X 33' long)	1	4024916
Front Panel Screw, 1/4-20 X 1/2	1	1096006
Wire Duct Collar (Discharge)	1	4024078
Magnet, Grain Control Cover	1	4025728
Condenser Coil	1	4021396
Condensate Pump	1	4023649
Motorized Impeller Fan	1	4025076
Relay, Compressor	1	1970010
Run Capacitor, Comp. 25 µF	1	4024912
Run Capacitor, Fan, 15 µF	1	4025224

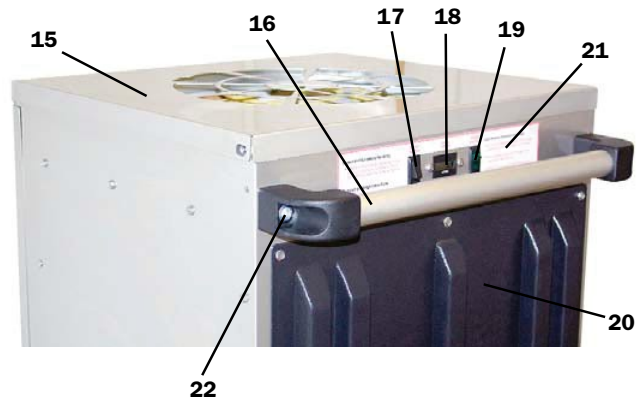
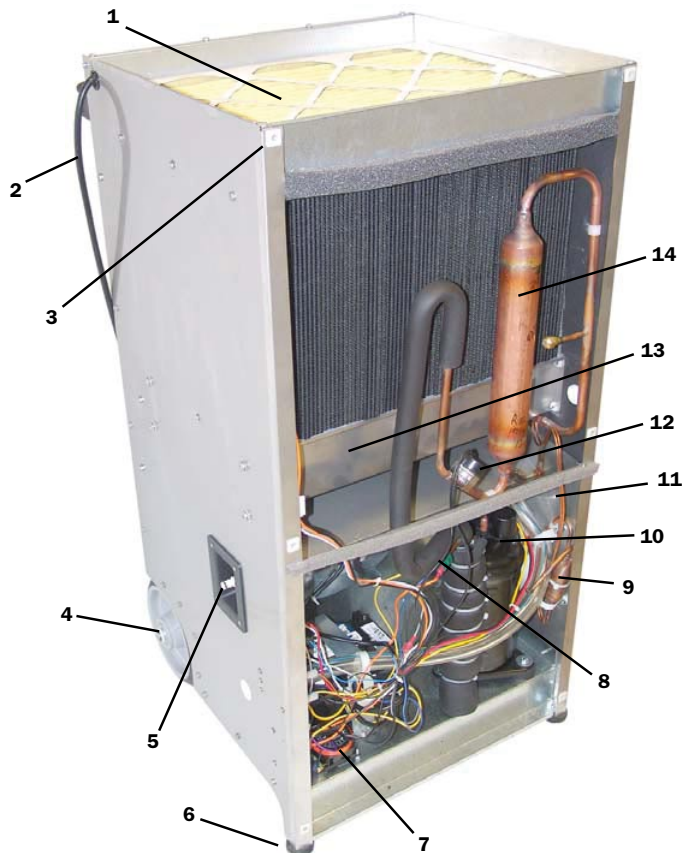

Specifications subject to change without notice.

Phoenix 200 HT Dehumidifier Limited Warranty

Warrantor:

Therma-Stor LLC
PO Box 8680
Madison, WI 53708
Telephone: 1-800-533-7533

Who Is Covered: This warranty extends only to the original end-user of the Phoenix 200 HT dehumidifier, and may not be assigned or transferred.

Year One: Therma-Stor LLC warrants that, for one (1) year the Phoenix 200 HT dehumidifier will operate free from any defects in materials and workmanship, or Therma-Stor LLC will, at its option, repair or replace the defective part(s), free of any charge.

Years Two Through Five: Therma-Stor LLC further warrants that for a period of five (5) years, the condenser, evaporator, and compressor of the Phoenix 200 HT dehumidifier will operate free of any defects in material or workmanship, or Therma-Stor LLC, at its option, will repair or replace the defective part(s), provided that all labor and transportation charges for the part(s) shall be borne by the end-user.

End-User Responsibilities: Warranty service must be performed by a Servicer authorized by Therma-Stor LLC. If the end-user is unable to locate or obtain warranty service from an authorized Servicer, he should call Therma-Stor LLC at the above number and ask for the Therma-Stor Service Department, which will then arrange for covered warranty service. Warranty service will be performed during normal working hours.

The end-user must present proof of purchase (lease) upon request, by use of the warranty card or other reasonable and reliable means. The enduser is responsible for normal care. This warranty does not cover any defect, malfunction, etc. resulting from misuse, abuse, lack of normal care, corrosion, freezing, tampering, modification, unauthorized or improper repair or installation, accident, acts of nature or any other cause beyond Therma-Stor LLC's reasonable control.

Limitation and Exclusions: If any Phoenix 200 HT Dehumidifier part is repaired or replaced, the new part shall be warranted for only the remainder of the original warranty period applicable thereto (but all warranty periods will be extended by the period of time, if any, that the Phoenix 200 HT Dehumidifier is out of service while awaiting covered warranty service).

UPON THE EXPIRATION OF THE WRITTEN WARRANTY APPLICABLE TO THE PHOENIX 200 HT DEHUMIDIFIER OR ANY PART THEREOF, ALL OTHER WARRANTIES IMPLIED BY LAW, INCLUDING MERCHANTABILITY AND FITNESS FOR A PARTICULAR PURPOSE, SHALL ALSO EXPIRE.

ALL WARRANTIES MADE BY THERMA-STOR LLC ARE SET FORTH HEREIN, AND NO CLAIM MAY BE MADE AGAINST THERMA-STOR LLC BASED ON ANY ORAL WARRANTY. IN NO EVENT SHALL THERMA-STOR LLC, IN CONNECTION WITH THE SALE, INSTALLATION, USE, REPAIR OR REPLACEMENT OF ANY PHOENIX 200 HT DEHUMIDIFIER OR PART THEREOF BE LIABLE UNDER ANY LEGAL THEORY FOR ANY SPECIAL, INDIRECT OR CONSEQUENTIAL DAMAGES INCLUDING WITHOUT LIMITATION WATER DAMAGE (THE END-USER SHOULD TAKE PRECAUTIONS AGAINST SAME), LOST PROFITS, DELAY, OR LOSS OF USE OR DAMAGE TO ANY REAL OR PERSONAL PROPERTY.

Some states do not allow limitations on how long an implied warranty lasts, and some do not allow the exclusion or limitation of incidental or consequential damages, so one or both of these limitation may not apply to you.

Legal Rights: This warranty gives you specific legal rights, and you may also have other rights which vary from state to state.



Free Manuals Download Website

<http://myh66.com>

<http://usermanuals.us>

<http://www.somanuals.com>

<http://www.4manuals.cc>

<http://www.manual-lib.com>

<http://www.404manual.com>

<http://www.luxmanual.com>

<http://aubethermostatmanual.com>

Golf course search by state

<http://golfingnear.com>

Email search by domain

<http://emailbydomain.com>

Auto manuals search

<http://auto.somanuals.com>

TV manuals search

<http://tv.somanuals.com>