

Thermador[®]

Care and Use Manual

for
ExtraLow[™]
Gas Cooktops

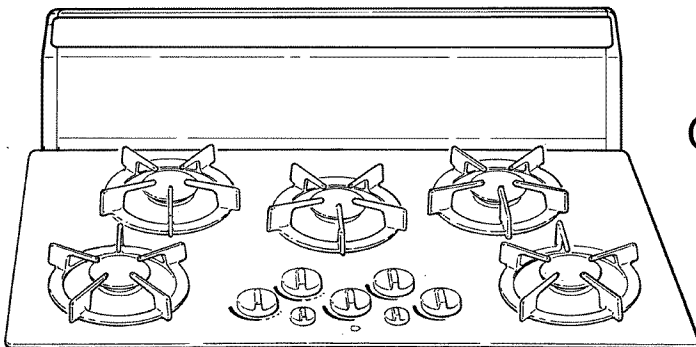
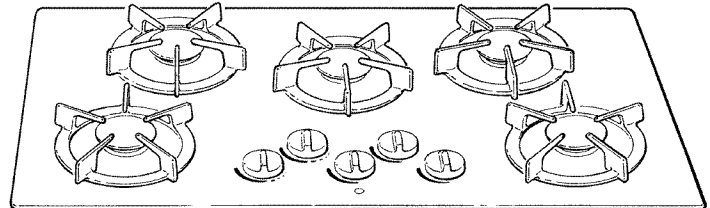

Models
GG30/36/365, GGSCV30/
36/365, SGS30/36G,
SGSCV36G

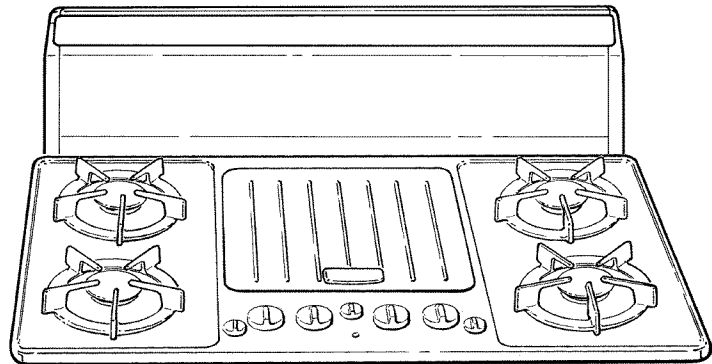

and
Traditional Series Gas Cooktops

Models
GGN30/36/365, GGNCV30/36/365, SGN30/36G, SGNCV36G

To the Installer: Leave this owner's manual with the cooktop.

To the Consumer: Retain this Care & Use Manual for future reference. Be sure to fill in the information on Page 28 for warranty validation.

A Special Message to Our Customers,

Thank you for selecting a Thermador Gas Cooktop. If you follow the few simple procedures and suggestions in this manual, the cooktop should give you years of service.

You have either a steel top or a glass top. The glass cooktop fully meets the safety and durability requirements of the American Gas Association, the Canadian Gas Association and the Tempered Glass Association as well as the stringent test requirements imposed by Thermador. Testing includes dropping a 1.2 pound steel ball from about 2 feet and hitting the glass with a 4 pound "pan bottom" 10 times. The cooktop is tough, but it is glass. Severe abuse or excessively rough treatment may break the glass. Tempered glass derives its excellent strength and heat resistance from powerful internal tensions throughout the piece. When any part of the glass is broken, these tensions are released throughout the piece. In this unlikely event, the entire glass will break into many small, blunt pieces called popcorn (the average count is 20 pieces per square inch). The pieces may scatter somewhat and since most particles are transparent, food on or near the cooktop should not be eaten. The cooktop should not be used again until it is repaired by a qualified service technician. Remember, the steel top is covered with porcelain enamel, which is also a very durable glass. Severe abuse or excessively rough treatment may cause the porcelain enamel to chip.

There is no limit to the types of food which can be cooked on your cooktop, but some utensils could harm it. Do not use any utensil which spans two burners because this will excessively heat the space between them. Utensils which have large overhangs beyond the burner grate may cause over heating or tipping, if used for long periods of time. Of course, hard impact should be avoided.

We recommend that you read this entire manual before using your new cooktop. We know you will enjoy cooking on your new cooktop. Please contact us if you have questions or comments. When you write, please include the model and serial numbers of your cooktop.

Sincerely,

The Home Economics Staff

TABLE OF CONTENTS

Propane Installation	2	Section Four: Using the Cooktop	10 to 21
Section One:		Cooktop Operation	11
General Safety Instructions	3 to 6	Proper Cookware	14
Safety/Electrical Requirements	3	Flame Setting Chart	16
Precautions	4	Griddle'N Grill Operation	19
Section Two: Before you Begin	6	Cook'n'Vent Operation	21
Before using your Cooktop	6	Section Five: General Care	22 to 27
Section Three: Description	7 to 10	General Care	22
Models GGS30, GGN30, GGSCV30		Cleaning Chart	23
GGNCV30	7	Cook'n'Vent Care	26
Models GGSCV36, GGSCV365, GGNCV36,		Section Six: Service	28 to 29
GGNCV365	8	Before Calling For Service	28
Models GGS36, GGN36, GGS365,		Warranty	29
GGN365	9		
Models SGS30, SGN30, SGS36G,			
SGN36G, SGSCV36G, SGNCV36G.	10		



WARNING

If the information in this manual is not followed exactly, a fire or explosion may result causing property damage, personal injury or death.

— Do not store or use gasoline or other flammable vapors and liquids in the vicinity of this or any other appliance.

WHAT TO DO IF YOU SMELL GAS

- Do not try to light any appliance.
- Do not touch any electrical switch; do not use any phone in your building.
- Immediately call your gas supplier from a neighbor's phone. Follow the gas supplier's instructions.
- If you cannot reach your gas supplier, call the fire department.

— Installation and service must be performed by a qualified installer, service agency or the gas supplier.

PROpane INSTALLATION

PROPANE GAS INSTALLATION

The cooktop is ready for use with natural gas. It may be converted for use with propane gas using the Burner Propane Conversion Kit, Model NLPKIT6, Part Number 35-00-688. A qualified service technician or installer can convert the cooktop. Be sure the unit being installed is correct for the type of gas being used. Refer to the Rating plate on the right side underneath the cooktop, see pages 7 to 10 for the location.



CAUTION

When connecting the unit to propane gas, make certain the propane tank is equipped with its own high pressure regulator. In addition the pressure regulator supplied with the cooktop must be on the inlet gas pipe of this unit. **The maximum gas pressure to this appliance is not to exceed 14.0 inches water column from the propane gas tank pressure regulator.**

TESTED IN ACCORDANCE WITH ANSI Z21.1, STANDARD FOR HOUSEHOLD COOKING GAS APPLIANCES, and CAN/CGA 1.1 DOMESTIC GAS RANGES.

Check your local building codes for the proper method of installation. In the absence of local codes this unit should be installed in accordance with the National Fuel Gas Code No. Z223.1 Current Issue and National Electrical Code ANSI/NFPA No. 70 Current Issue or the CAN - B149 Installation Codes for Gas Burning Appliances and C22.1 Canadian Electrical Code Part 1.

ELECTRICAL REQUIREMENTS AND GROUNDING INSTRUCTIONS

PLEASE READ CAREFULLY

MODELS: GG30/36/365,
GGSCV30/36/365,
SG30, GGN30/36/365
GGNCV30/36/365 &
SGN30

Rated 120 volt, 60 Hz., 1.0 Amp.

MODELS: SG36G, SGSCV36G
SGN36G & SGNCV36G

Rated 120 volt, 60 Hz., 11.7 Amp

See Installation Instructions for electrical requirements and grounding instructions.

DO NOT UNDER ANY CIRCUMSTANCES CUT OR REMOVE THE THIRD (GROUND) PRONG FROM THE POWER CORD PLUG.

If the electrical outlet you intend to use does not accept the 3-prong plug, it is the personal responsibility and obligation of you, the user, to have it replaced with a properly grounded 3-prong wall receptacle in accordance with the National Electrical Code and/or applicable local codes and ordinances, by a qualified electrician.

**FOR PERSONAL SAFETY,
 THIS APPLIANCE MUST BE
 PROPERLY GROUNDED.**

ALWAYS DISCONNECT THE ELECTRICAL PLUG FROM THE WALL RECEPTACLE BEFORE SERVICING THIS UNIT.

The power cord on your cooktop is equipped with a three prong grounding plug with polarized parallel blades. This type of plug is for your protection against shock hazard. This cord must be plugged directly into a properly grounded 3-prong wall receptacle that is **connected to a correctly polarized 120 volt electric power supply**. It is recommended that a separate circuit serving each appliance be provided.

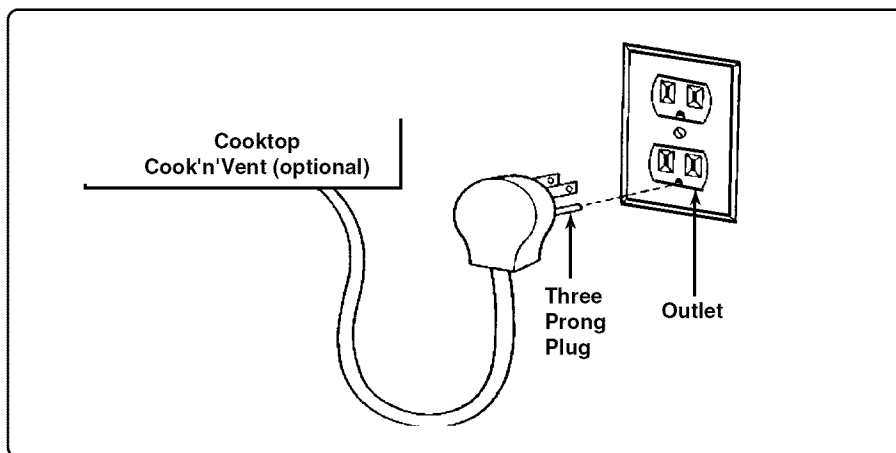

CAUTION - ALL MODELS

IN CASE OF AN ELECTRICAL FAILURE

If for any reason a gas control knob is turned ON and there is no electric power to operate the electronic igniter of the cooktop, **turn OFF the gas control knob and wait 5 minutes** for the gas to dissipate before lighting the burner manually. **On the models with the ExtraLow™ Gas the two left burners cannot be turned on manually.**

To light the burners, carefully hold a lighted match to the burner ports and turn the gas control knob to HI. During a power failure you can use the cooktop burners, but each must be lit with a match.

PRECAUTIONS

SAFETY PRACTICES TO AVOID PERSONAL INJURY

IMPORTANT SAFETY INSTRUCTIONS

WARNING - TO REDUCE THE RISK OF FIRE, ELECTRIC SHOCK, OR INJURY TO PERSONS, OBSERVE THE FOLLOWING:

- A. Use this unit only in the manner intended by the manufacturer. If you have any questions, contact the manufacturer.
- B. Before servicing or cleaning unit, switch power off at service panel and lock service panel to prevent power from being switched on accidentally.
- C. Use high range settings on range only when necessary. Heat oil slowly on low to medium setting.
- D. Do not leave range unattended when cooking.
- E. Always use cookware and utensils appropriate for the type and amount of food being prepared.

CAUTION: For General Ventilating Use Only. Do Not Use To Exhaust Hazardous or Explosive Materials and Vapors.

WARNING - TO REDUCE THE RISK OF FIRE, ELECTRIC SHOCK, OR INJURY TO PERSONS, OBSERVE THE FOLLOWING:

- A. SMOTHER FLAMES with a close-fitting lid, cookie sheet, or other metal tray, then turn off the gas burner or the elec-

tric element. BE CAREFUL TO PREVENT BURNS. If the flames do not go out immediately EVACUATE AND CALL THE FIRE DEPARTMENT.

- B. NEVER PICK UP A FLAMING PAN - You may be burned.
- C. DO NOT USE WATER, including wet dishcloths or towels - a violent steam explosion will result.
- D. Use an extinguisher **ONLY** if:
 1. You know you have a Class ABC extinguisher, and you already know how to operate it.
 2. The fire is small and contained in the area where it started.
 3. The fire department is being called.
 4. You can fight fire with your back to an exit.

WARNING - TO REDUCE THE RISK OF INJURY TO PERSONS, IN THE EVENT OF A RANGE TOP GREASE FIRE, OBSERVE THE FOLLOWING:

When properly used and cared for your new Thermador Cooktop has been designed to be a safe, reliable appliance. When using kitchen appliances, basic safety precautions must be followed, including the following:

Read this Care and Use Manual carefully before using your new cooktop to reduce the risk of fire, electric shock, or injury to persons.

Begin by insuring proper installation and servicing. Follow the installation instructions provided with this product. Have the cooktop installed and grounded by a qualified technician. Have the installer show you where the gas shut-off valve is located so that you know how and where to turn off the gas to the cooktop.

If you smell gas, your installer has not done a proper job of checking for leaks. Connections can loosen in transit. If the connections are not perfectly tight, you can have a small leak and therefore a faint gas smell. Finding a gas leak is not a "do-it-yourself" procedure. Some leaks can only be found with the burner control in the ON position.

For proper lighting and performance of the burners, **keep the igniters clean.** It is necessary to clean these when there is a boil over, or when the burner does not light even though the electronic igniters click. See page 22.

The cooktop is factory

assembled for natural gas. It should be correctly adjusted by a qualified service person or installer for the type of gas with which it is used. (See page 2 for propane gas.)

Do not repair or replace any part of the appliance unless specifically recommended in this manual. All other servicing should be referred to a qualified technician.

Children should not be left alone or unattended in an area where appliances are in use. They should never be allowed to sit or stand on any part of the appliance.

CAUTION: Do not store items of interest to children above the cooktop or at the back. If children should climb onto the appliance to reach these items, they could be seriously injured.

Do not store flammable materials on or near the cooktop.

Do not use water on grease fires. Turn appliance off and smother fire with baking soda or use a dry chemical or foam-type extinguisher.

Never let clothing, potholders, or other flammable materials come in contact with the burners or burner grates, until they are cool to the touch.

Use only dry potholders; moist or damp potholders on hot surfaces may cause burns from steam. Do not use a towel or other bulky cloth in place of potholders. Do not let potholders touch hot burners or burner grates.

For personal safety, wear proper apparel. Loose fitting garments or hanging sleeves should never be worn while cooking.

Do not use aluminum foil to line any part of the cooktop. Improper use of a foil liner could result in a shock, fire hazard or it could obstruct the flow of combustion and ventilation air. Foil is an excellent heat insulator and heat will be trapped beneath it. This will upset the cooking performance and can damage the cooktop finish.

Warning: The appliance is for cooking. Based on safety considerations never use the cooktop to warm or heat a room. Also, such use can be damaging to the cooktop.

Do not heat unopened food containers; a buildup of pressure may cause the container to burst.

When using the cooktop: **DO NOT TOUCH THE BURNER GRATES or THE IMMEDIATE SURROUNDING AREA.** Areas adjacent to the burners may become hot enough to cause burns.

Never leave the burners unattended when using high flame settings. Boil overs cause smoking, and greasy spillovers that may ignite. More importantly, if the flame is smothered, unburned gas will be coming into the room. See "What to do if you smell Gas", Page 1.

Always use utensils that have flat bottoms. Hold the handle of the pan to prevent movement of the utensil when stirring or turning food.

To minimize burns, ignition of flammable materials and unintentional spillovers, **position handles of utensils inward** so they do not extend over adjacent work areas, burners, or the edge of the cooktop.

During cooking, **set the burner control so that the flame heats only the bottom of the pan** and does not extend beyond the edge of the pan.

Take care that drafts like those from fans or forced air vents **do not blow flammable material toward the flames** or push the flames so that they extend beyond the edges of a pot.

Only certain types of glass, heat-proof glass-ceramic, ceramic, earthenware, or other glazed utensils are suitable for cooktop use. This type of utensil may break with sudden temperature changes. Use only on low or medium flame settings according to the manufacturer's directions.

If the cooktop is near a window, **be certain the curtains do not blow over or near the burners;** they could catch on fire.

In the event a burner goes out and **gas escapes,** open a window or a door. Do not attempt to use the cooktop until the gas has had time to dissipate. **Wait at least 5 minutes before using the cooktop.**

PRECAUTIONS

Clean the cooktop with caution. Avoid steam burns; do not use a wet sponge or cloth to clean the cooktop while it is hot. Some cleaners produce noxious fumes if applied to a hot surface.

Clean the hood above or the ventilator at the back of your cooktop frequently so grease from cooking vapors does not accumulate on the filters or on the intake.

Turn the ventilator OFF in case of fire or when intentionally "flaming" liquor or other spirits on the cooktop. The blower, if in operation, could unsafely spread the flames.

The **electric element** is removeable, however it should **never be immersed in water**. Turn the element on and it will clean itself. **DONOT** leave it unattended when burning off food soil.

California Proposition 65 - **Warning:** Burning gas cooking fuel generates some by-products which are on the list of substances which are known by the State of California to cause cancer or reproductive harm. California law requires businesses to warn customers of potential exposure to such substances. To minimize exposure to these substances, always operate this unit according to the instructions contained in this booklet and provide good ventilation.

SAVE THESE INSTRUCTIONS

Section Two: Before You Begin

BEFORE USING YOUR COOKTOP FOR THE FIRST TIME

Remove all packaging materials and labels before using your cooktop.

1. Check that you have these items.

**GG30/36, GGSCV30/36
GGN30/36, GGNCV30/36**

- /
- ▲ 4 Burner Grates
- ▲ 4 Burner Caps
- ▲ 2 Ventilator Filters*
- ▲ Care and Use Manual (warranty found on Page 29).

**GG365, GGSCV365
GGN365, GGNCV365**

- ▲ 5 Burner Grates
- ▲ 5 Burner Caps
- ▲ 2 Ventilator Filters*
- ▲ Care and Use Manual (warranty found on Page 29).

SGS30, SGS36G, SGSCV36G

- ▲ 4 Burner Grates
- ▲ 4 Burner Caps
- ▲ Griddle'n Grill™ (drip pan, cover, griddle, grill, removable element)**
- ▲ 2 Ventilator Filters*
- ▲ Care and Use Manual (warranty found on Page 29).

SGN30, SGN36G, SGNCV36G

- ▲ 4 Burner Grates
- ▲ 4 Burner Caps
- ▲ Griddle (drip pan, cover, griddle, removable element)**
- ▲ 2 Ventilator Filters*
- ▲ Care and Use Manual (warranty found on Page 29).

2. Record the Model and Serial Number as described on page 28.

These may be used for any future contacts with your servicer or the factory.

* Cook'n'Vent models only.

** Griddle'n Grill or griddle models only.

MODEL AND PARTS IDENTIFICATION

Models GGS30* & GGN30

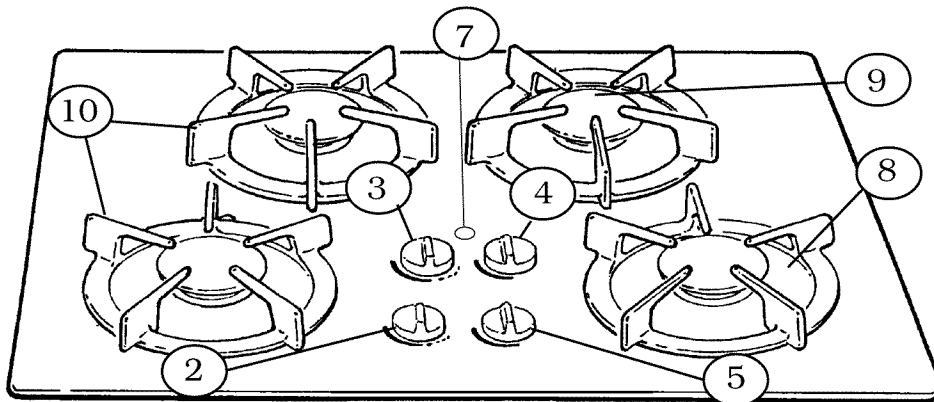

Model GGSCV30* & GGNCV30

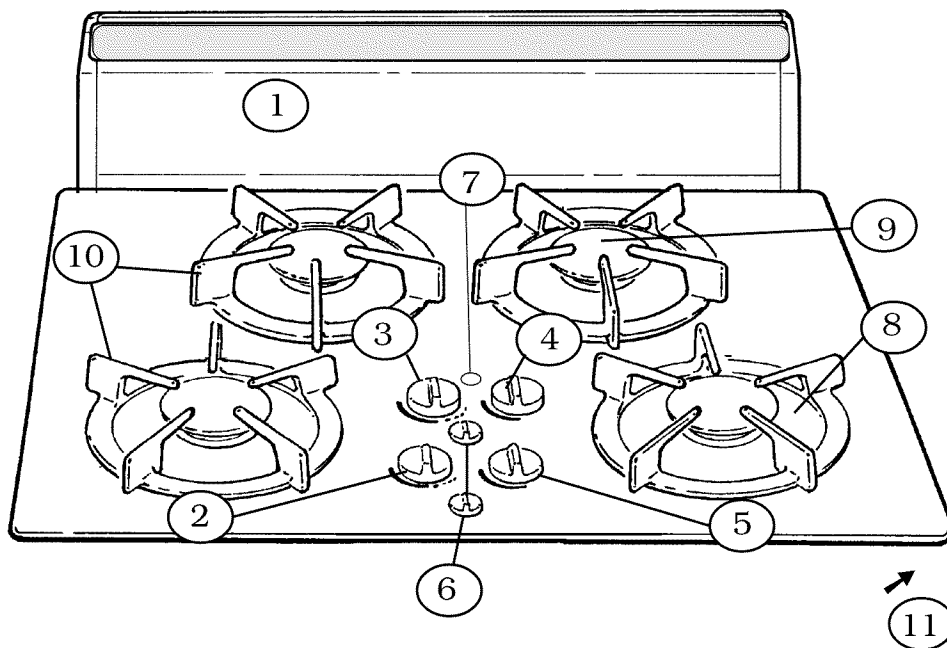

- | | |
|---|--|
| <p>1. Cook'nVent™</p> <p>2. <u>Models GGS</u> - ExtraLow™ 300 to 9,100 BTU/HR Burner & Control Knob
<u>Models GGN</u> - 950 to 6,500 BTU/HR Burner & Control Knob</p> <p>3. <u>Models GGS</u> - ExtraLow™ 365 to 11,000 BTU/HR Burner & Control Knob
<u>GGN Models</u> - 1650 to 11,000 BTU/HR Burner & Control Knob</p> <p>4. <u>Models GGS</u> - 1300 to 9100 BTU/HR Burner & Control Knob
<u>Models GGN</u> - 950 to 6500 BTU/HR Burner & Control Knob</p> | <p>5. 1650 to 11,000 BTU/HR Burner & Control Knob</p> <p>6. Ventilator Controls</p> <p>7. <u>Models GGS</u> - "ON" Light</p> <p>8. Burner Plate</p> <p>9. Burner Cap</p> <p>10. Grates</p> <p>11. Rating Plate, Right Side, underneath Cooktop</p> |
|---|--|

* GGS models illustrated

MODEL AND PARTS IDENTIFICATION

Model GGSCV36* & GGNCV36

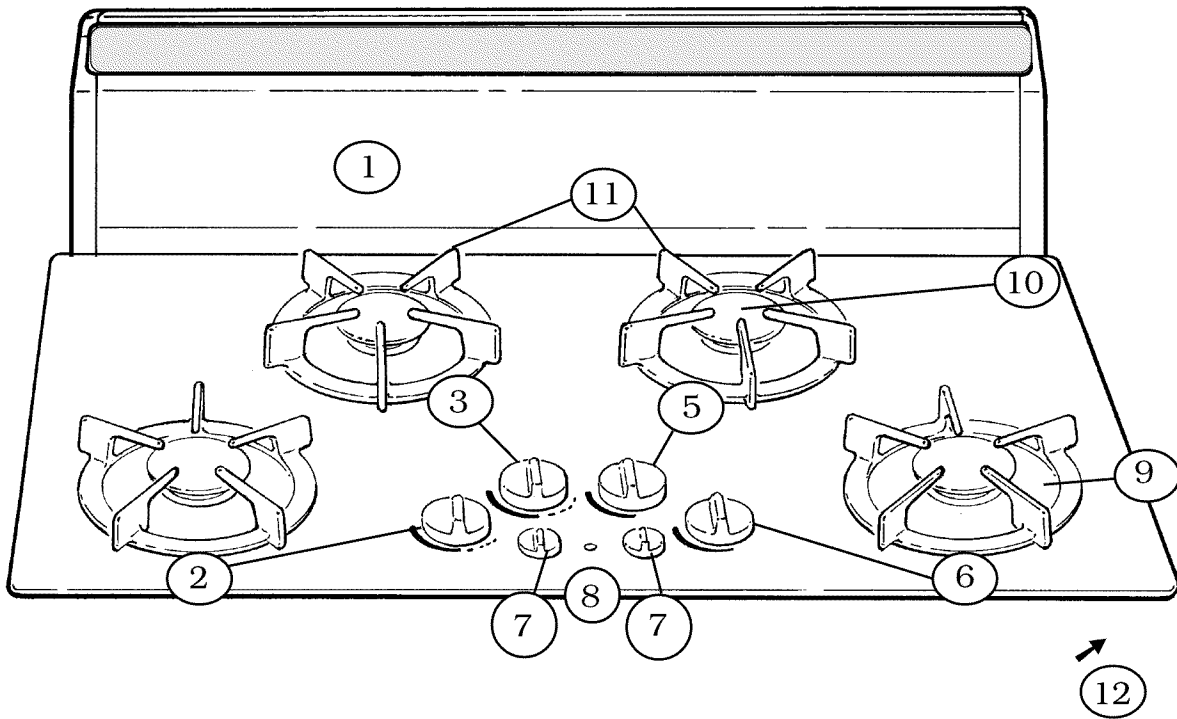

Model GGSCV365* & GGNCV365

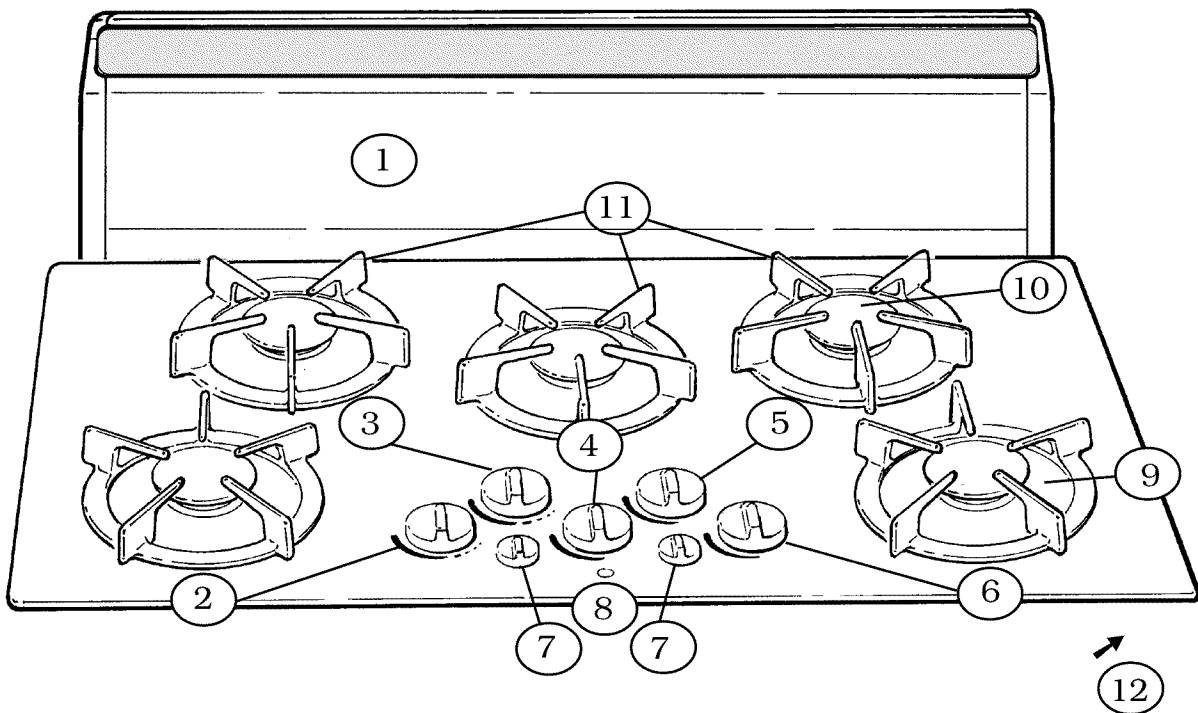

*GGSCV models illustrated

Models GGS36* & GGN36

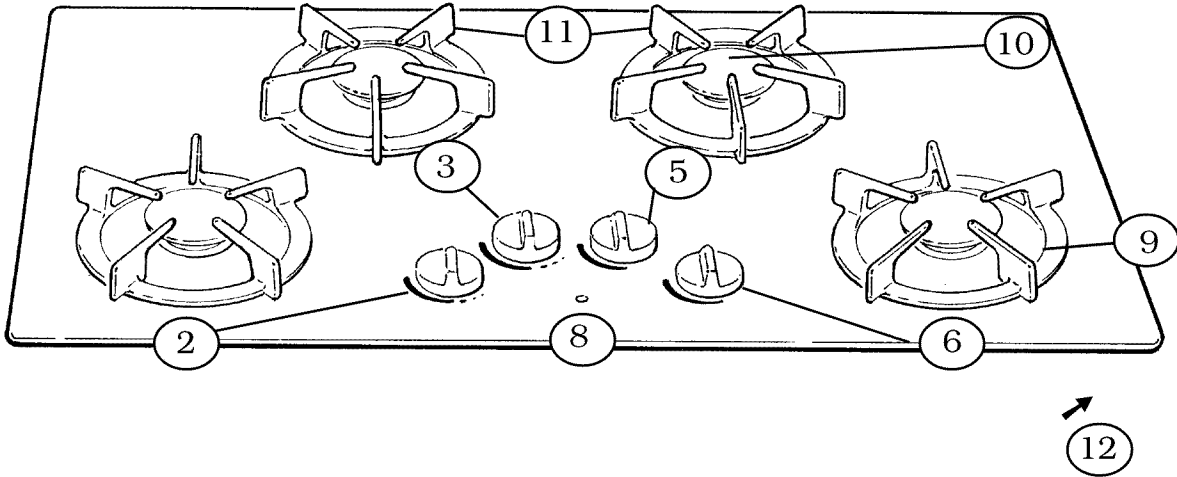

Models GGS365* & GGN365

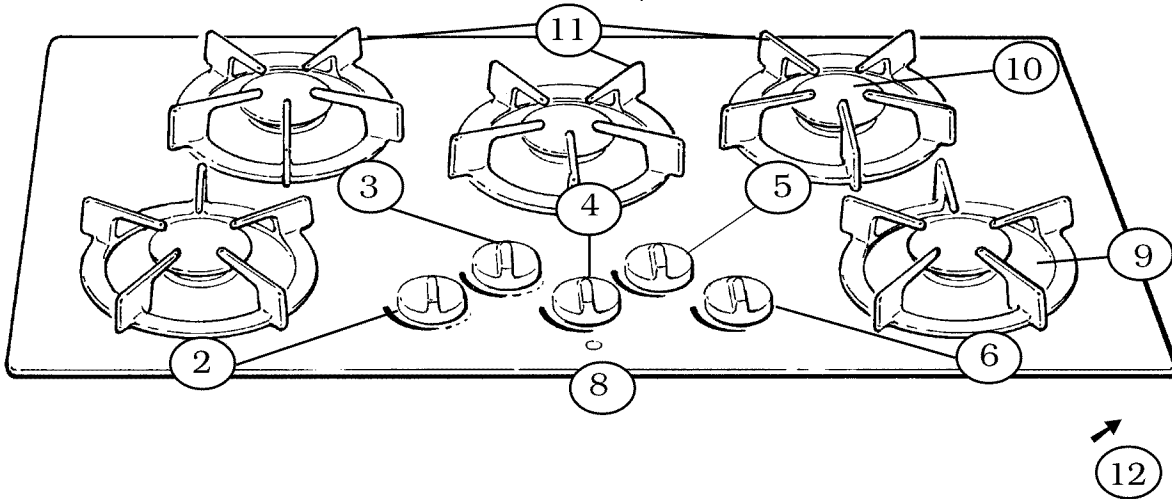

- | | |
|--|---|
| <p>1. Cook'nVent</p> <p>2. <u>Models GGS - ExtraLow™ 300 to 9100 BTU/HR Burner & Control Knob</u>
<u>Models GGN - 950 to 6,500 BTU/HR Burner & Control Knob</u></p> <p>3. <u>Models GGS - ExtraLow™ 365 to 11,000 BTU/HR Burner & Control Knob</u>
<u>Models GGN - 1650 to 11,000 BTU/HR Burner & Control Knob</u></p> <p>4. <u>Models GGSCV365, GGS365 & GGN365 - 950 to 6,500 BTU/HR Burner & Control Knob</u></p> | <p>5. <u>Models GGS - 1300 to 9,100 BTU/HR Burner & Control Knob</u>
<u>Models GGN 950 to 6,500 BTU/HR Burner & Control Knob</u></p> <p>6. 1650 to 11,000 BTU/HR Burner & Control Knob</p> <p>7. Ventilator Controls</p> <p>8. <u>Models GGS - "ON" Light</u></p> <p>9. Burner Plate</p> <p>10. Burner Cap</p> <p>11. Grate</p> <p>12. Rating Plate, Right Side, Underneath Cooktop</p> |
|--|---|

*GGS models illustrated

MODEL AND PARTS IDENTIFICATION

Models SGS30* & SGN30

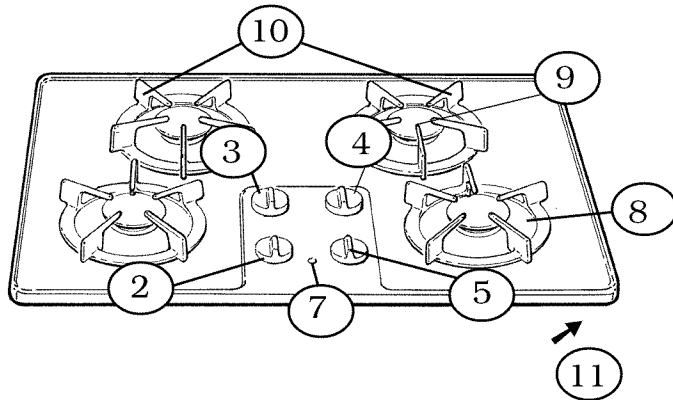

Models SGS36G* & SGN36G

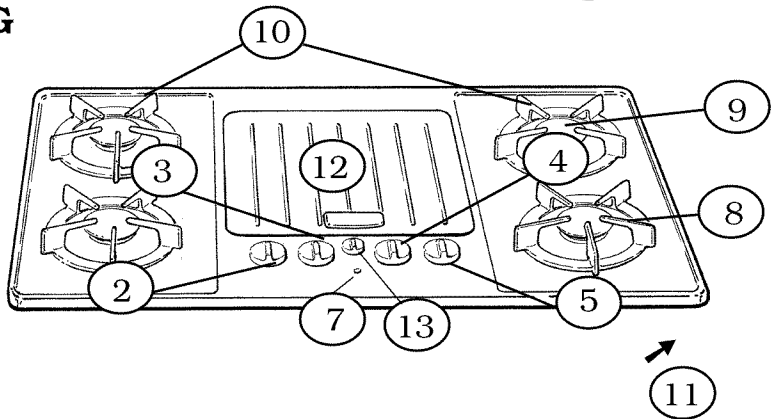

Model SGSCV36G* & SGNCV36G

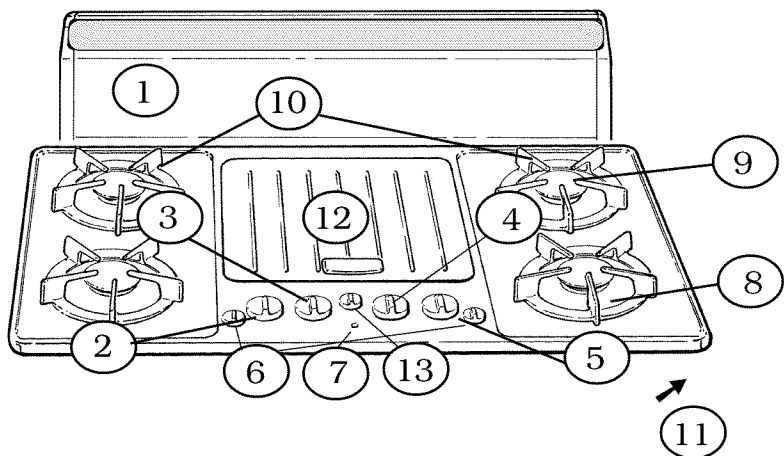

- | | | | |
|---|---|--|---|
| 1. Cook'n Vent | 3. <u>Models SGS - ExtraLow™ 365 to 11,000 BTU/HR</u> Burner & Control Knob | 5. 1650 to 11,000 BTU/HR Burner & Control Knob | 10. Grates |
| 2. <u>Models SGS - ExtraLow™ 300 to 9100 BTU/HR</u> Burner & Control Knob | 4. <u>Models SGS - 1300 to 9,100 BTU/HR</u> Burner & Control Knob | 6. Ventilator Controls | 11. Rating Plate, Right Side, Underneath Cooktop |
| 3. <u>Models SGS - ExtraLow™ 365 to 11,000 BTU/HR</u> Burner & Control Knob | 5. 1650 to 11,000 BTU/HR Burner & Control Knob | 7. "ON" Light except SGN30 | 12. <u>Models SGS - Griddle'n Grill</u> |
| 4. <u>Models SGS - 1300 to 9,100 BTU/HR</u> Burner & Control Knob | 6. Ventilator Controls | 8. Burner Plate | 13. <u>Models SGSG - Griddle'n Grill</u> Control Knob
<u>Models SGNG - Griddle only</u> Control Knob |
| | 7. "ON" Light except SGN30 | 9. Burner Cap | |

*SGS models illustrated

CONTROL KNOB — ALL STANDARD BURNERS

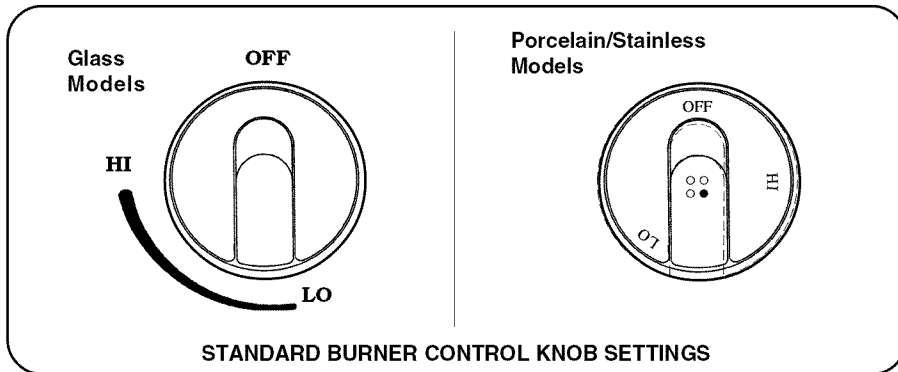

All the controls are push in to turn and have an infinite number of heat settings, with no fixed positions. Select the appropriate control knob and turn it counterclockwise to the **HI** position (detent) until the burner lights. Adjust the flame size. Turn off by turning the control clockwise to **OFF**.

CONTROL KNOB — Thermador® ExtraLow™ BURNERS

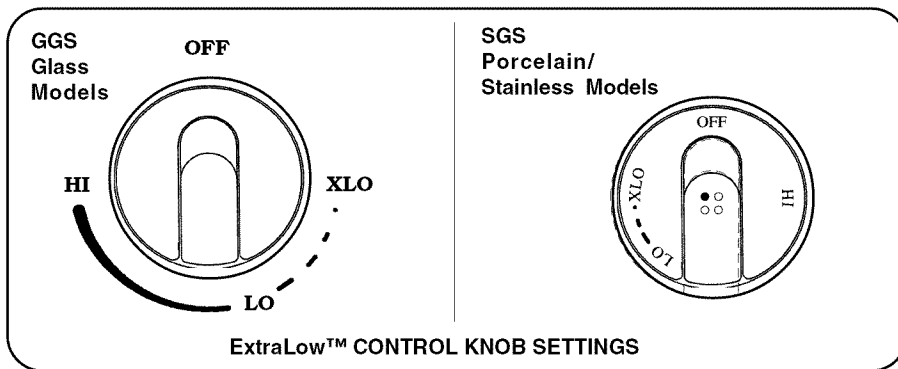

Both ExtraLow controls are push in to turn and have an infinite number of heat settings, with no fixed positions. The ExtraLow settings are between **XLO** and just after **LO**, at the detent, shown by the broken line.

THERMADOR® EXTRALOW™ BURNERS (Models GGS/SGS)

The left front 9,100 BTU/HR burner and left rear 11,000 BTU/HR burner are designed to provide flame settings which enable you to simmer, poach, melt and hold cooked food at a serving temperature, without scorching or burning. This is accomplished by cycling the flame **OFF** and **ON** for varying lengths of time.

HOW THEY WORK

- The BTU/HR usage on the 9,100 BTU/HR burner ranges from **HI** (at 9,000) to **XLO** (at 300). The BTU/HR usage on the 11,000 BTU/HR burner ranges from **HI** (at 11,000) to **XLO** (at 365).
- There are an infinite number of settings between **HI** and **XLO**; the control knob can be set at any position.
- The burner flame will pulse **ON** and **OFF** when the setting is at any position between **LO** and **XLO**.
- The length of time the flame is **ON** and **OFF** varies.
- With a setting just below **LO**, the flame will be **ON** approximately 50 seconds and **OFF** 10 seconds of each minute.
- With a setting at the **XLO** position, the flame is **ON** approximately 10 seconds and **OFF** 50 seconds of each minute.

FOR THE BEST RESULTS

- Temperature control will be more accurate if a lid is used.
- Bring food to a rolling boil; stir well to be sure all the food is boiling; cover and reduce the heat to just below **LO**.
- Check periodically to see if the control knob should be turned to a lower setting.

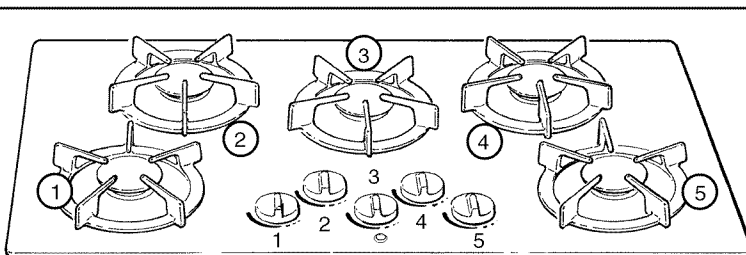

- | | |
|---|----------------------|
| 1. ExtraLow™ 300 to 9,100 BTU/HR Burner and Control Knob | GGSCV365 and GGS365) |
| 2. ExtraLow™ 365 to 11,000 BTU/HR Burner and Control Knob | |
| 3. 950 to 6,500 BTU/HR Burner and Control Knob (Models | Model GGS365 |
| 4. 1300 to 9,100 BTU/HR Burner and Control Knob | |
| 5. 1650 to 11,000 BTU/HR Burner and Control Knob | |

COOKTOP OPERATION

- Adjust control knob to lower settings in small steps.
- If control is set too low to maintain simmer, bring the food back to a boil before setting a higher simmer setting.

WHAT TO EXPECT

- The type and quantity of the food will affect which setting to use.
- The size, type and material of your pan will affect which setting to use.
- When a large pan is used on a small burner, it may cause the simmer action to occur mainly in the center of the pan. When the food is stirred, the cooler food near the edges of the pan may result in an overall temperature too cool to simmer. If this happens, turn the burner up slightly.
- It is normal to stir food occasionally. This is especially important when simmering for several hours. For example: a homemade spaghetti sauce or beans.
- It is normal not to see simmer bubbles immediately after the food has been stirred.
- While the flame is **ON** there may be bubbling; there should be at least steam and a slight quivering of the liquid's surface.
- Simmer bubbles may not be seen when the flame has cycled **OFF**. (Models GGS & SGS)

SIGNAL LIGHT

The Signal Light (not on all models), or "ON" Light is located in the area of the Control Knobs. For location see "Section Three: Description", located on pages 7 to 9, to identify your model. This light turns on when any Control Knob is set.

SEALED BURNERS

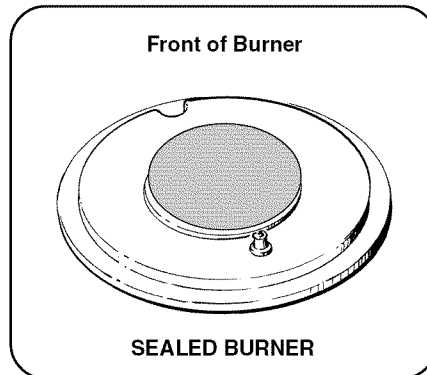

Your new cooktop features four or five sealed gas burners. On Models GGS30/36/365, GGSCV30/36/365, SGS30/30G and SGSCV36G you have two 9,100 BTU/HR burners, two 11,000 BTU/HR burners and on the GGSCV365 or GGS365 there is one 6,500 BTU/HR burner. On Models GGN30/36/365 and SGN30/36 there are two 11,000 BTU/HR and two or three 6,500 BTU/HR burners. Each burner is sealed to the cooktop for easier cleaning.

BURNER CAPS

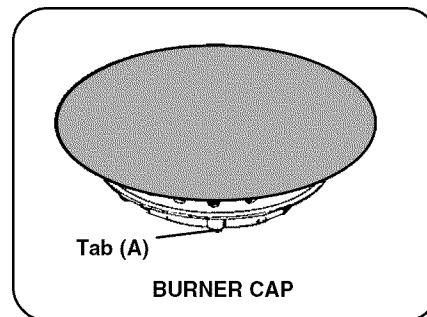

The Burner Cap top is porcelain enamel and has a tab (A) on the underside that fits into the notch (B) on the burner base (C).

BE SURE ALL BURNERS ARE IN THE OFF POSITION BEFORE WIPING OR CLEANING THE COOKTOP.

BURNER PLATES

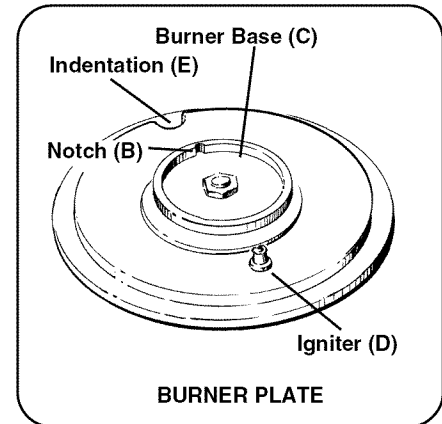

The Burner Plate has a notch (B) on the burner base, directly across from the igniter (D). This is where the tab (A) on the burner cap fits.

□ **NOTE:** For proper burner operation be sure the tab (A) on the underside of the burner cap fits into the corresponding notch (B) on the burner plate.

GRATES

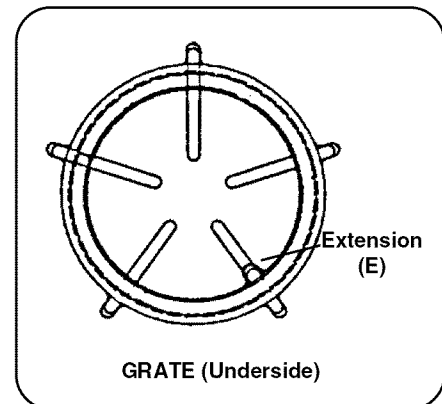

The five finger grates are porcelain enameled cast iron or steel and have an extension (E) that is longer (underneath) than the other four. This extension fits into the indentation (E) on the burner plate, which is directly across from the igniter (D).

ELECTRONIC IGNITION

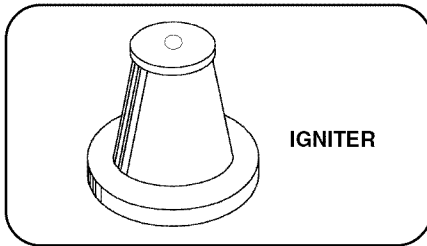

The cooktop uses electronic igniters to light the burners. Each burner has its own igniter that sparks when any burner is turned on. When the igniters are clicking (sparking), do not touch the burners. If a burner fails to ignite, see "Before Calling For Service," Page 28.

AUTOMATIC RE-IGNITION

If any burner flame blows out, the electronic igniter automatically sparks on all burners to relight the flame. Do not touch any burner while the igniters are clicking.

POWER FAILURE

In the event of a power failure, only the standard burners can be lit manually (the burners on the left on Models GGS & SGS cannot be lit). It is necessary to light each standard series burner individually.

If the cooktop is being used when the power failure occurs, turn all the burner control knobs to the OFF position. Then, the standard burners can be lit by holding a match at the ports and turning the control knob to the HI position. Wait until the flame is burning all the way around the burner cap before adjusting the flame to the desired height.

The two ExtraLow™ (Models GGS & SGS) burners, on the left side, cannot be used during a power failure. Be sure to turn them OFF if a power failure occurs, as they will not turn back on until both control knobs are turned OFF and then turned back on again. See "What To Do If You Smell Gas," Page 1.

FLAME HEIGHT

The correct height of the flame depends on the size and material of the utensil being used, the food being cooked and how much liquid is in the utensil. Here are some basic rules for selecting the flame height.

- s The flame should never extend beyond the bottom of the pan.
- s Utensils which conduct heat slowly (such as glass-ceramic) should be used with a low or medium flame unless you are cooking with a large amount of liquid.

BURNER EFFICIENCY and FLAME CHARACTERISTICS

The burner flame should be blue in color and stable with no yellow tips, excessive noise or fluttering. It should burn completely around the burner cap.

Foreign particles in the gas line may cause an orange flame during initial use. This should disappear with use.

If the flame does not burn evenly all the way around the burner cap, be sure the cap is resting correctly on the burner base.

If the ports are clogged, use a wire, a straightened paper clip or a needle to clear the ports. **Do not use a toothpick; it could break off inside the port.** If the condition persists, contact a service agency for adjustment.

The burner should light in 4 seconds or less. If a burner does not light, check to see that the cap is resting correctly on the burner base.



CAUTION

- ▲ **Foods packaged in aluminum foil** should *not* be placed directly on the burner grate for cooking; aluminum foil can melt.
- ▲ **Plastic, paper and cloth can melt or burn** when in contact with a hot burner grate. **Do not** let these items come in contact with the burner grate.
- ▲ **Do not allow pans to boil dry.** This can damage the pan, the burner grate, the cooktop glass and/or the burner plate.

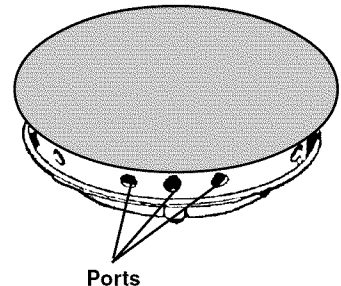

BURNER CAP

**FOR PROPER COMBUSTION
DO NOT USE THE COOKTOP
WITHOUT THE BURNER GRATES IN PLACE.**

PROPER COOKWARE

Top performance of your new cooktop is directly related to the use of proper pots and pans. An out-of-shape pan, without a lid, cannot possibly cook with the same speed and evenness as a pan with a heavy, flat bottom and a good fitting lid.

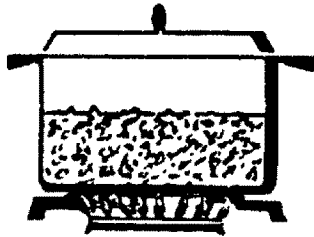

FLAT

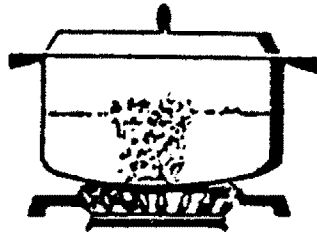

CONVEX (rounded)

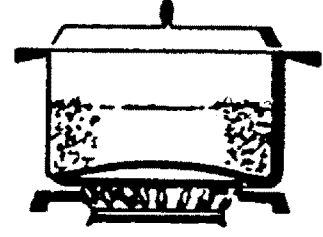

CONCAVE (hollow)

Cookware should have the following characteristics:

- s Good heat conductivity
- s Bottom diameter matching the size of the burner used
- s Good balance (pan bottom remains level on burner grate)
- s Smooth, heavy bottom that does not warp when hot; provides even heat
- s Proper fitting lid (when needed for specific cooking methods)

Do not use cookware with these characteristics:

- s Thin bottom
- s Concave bottom when heated
- s Convex bottom when heated
- s Poor balance (rocks back from weight of handle)

Many different types of pans can be used on this cooktop. To get the best cooking results, choose pans having the following qualities:

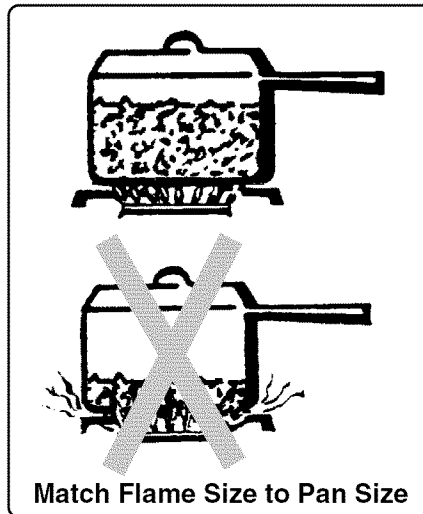

Match Flame Size to Pan Size

Match the flame to the bottom diameter of the pan. The flame should be the same size as the pan or slightly smaller. Small utensils and high flames result in energy loss and increase the potential for burns.

Use cookware that has good heat conductive qualities. Metal cookware that has copper or aluminum imbedded in a stainless steel disk bottom ("tri-ply construction") conducts heat better than other cookware.

Use medium to heavy gauge pans. These pans resist warping and last

longer than thin pans. The weight or thickness of the pan material (gauge) should be heavy enough to conduct heat evenly over the bottom of the pan for even browning and to avoid scorching.

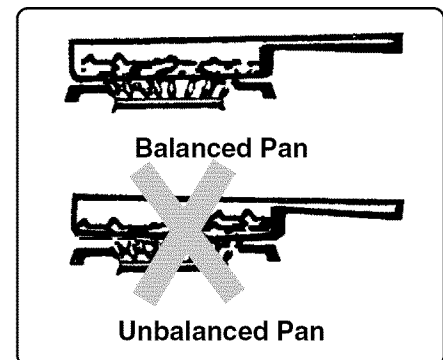

Balanced Pan

Unbalanced Pan

Use balanced pans that sit level on the burner grate without tilting from the weight of the handle.

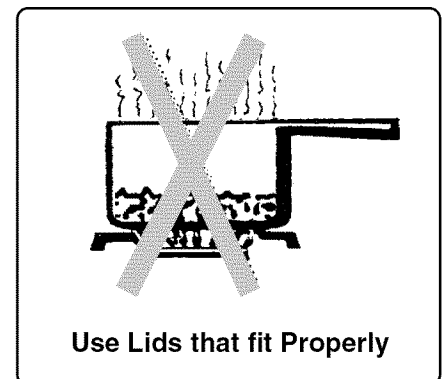

Use Lids that fit Properly

Use lids that fit the cookware properly to help shorten cooking time and to allow food to cook in a minimum amount of liquid on a lower heat setting.

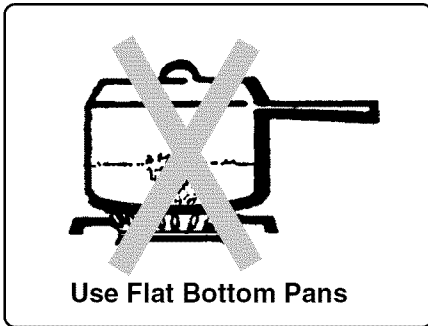

Use flat, heavy bottom pans that stay flat when heated for the best results. Avoid cookware that is warped, dented, ridged or thin. A warped or ridged pan receives the most heat at the points that contact the flame. This can result in burning or scorching of the food being prepared.

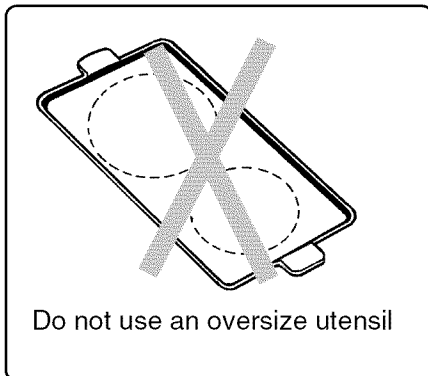

Specialty pans such as woks, lobster pots, pressure cookers, griddles, French fryers, etc. must meet similar design requirements as regular cookware: flat bottom, balanced, correct size, and proper cover (if applicable). **Do not use** utensils such as griddles, roasting pans, au gratin pans, fish poachers or other cooking utensils that must fit across two burners. Use of these products can result in damage to the glass cooktop and porcelain burner pans.

Heat and cool pans gradually to help maintain a flat bottom on your cookware. Do not place pans under cold water while still hot, unless recommended by the manufacturer, as they may warp.

Use only a flat bottom wok. A round bottom wok cannot be used with or without its support ring. The wok is unstable without the ring, and the ring may restrict air to the burners.

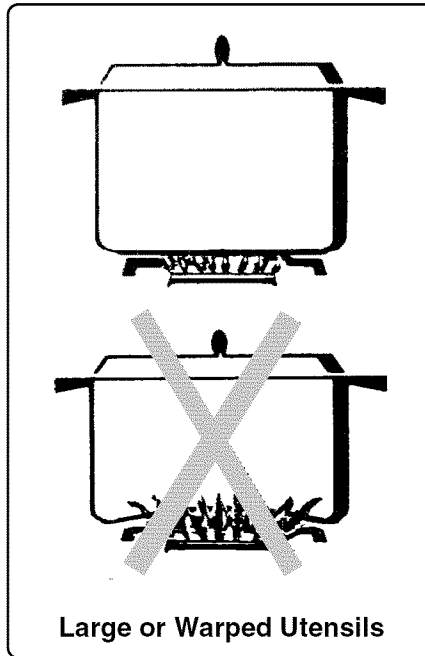

Do not use unusually large or warped utensils such as canners and stock pots on HI heat for an extended period of time. This may cause heat build up which can result in damage to the cooktop or the surrounding countertop. Once food has reached temperature, turn the control setting down to maintain the cooking heat.

Use canners and stock pots that have a flat bottom and extend no more than 2 inches beyond the burner grate.

Canning Tips:

An oversize canning pot can be used with success following these suggestions.

- ▲ Use a canner with a dark or dull finish to reduce heat reflecting back to the cooktop surface.
- ▲ Select a canner with a flat bottom, rather than one with a concave, convex or rippled bottom.
- ▲ Allow at least 3/8 inch of air space between the canner overhang and the cooktop surface.
- ▲ Use the lowest heat setting possible to maintain a boil or pressure.
- ▲ Be sure to cover all containers.
- ▲ Follow the canning instructions given in a standard cookbook or manufacturer's instructions provided with the canning jars.
- ▲ Use care to prevent burns from the large amount of steam generated by the canning process.

Look for canners fitting this description:

- ▲ **Water Bath Canner:** Standard 21 to 22-quart canners with an 11 to 12-inch diameter and a 9 to 11-inch depth.
- ▲ **Pressure Canner:** Canners vary in size from 8 to 22 quarts with 8 to 11-inch bottom diameters and a 6-1/2 to 12-inch depth.

SUGGESTED FLAME SETTINGS

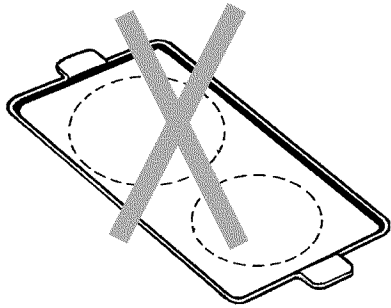

CAUTION

The tempered glass, porcelain and stainless steel used for your cooktop is heat resistant; however, **the use of improper utensils can possibly damage it.** Large or warped utensils or utensils that span two burners, trap heat against the cooktop. The trapped heat goes into the cooktop and overheats the glass which through repeated use of could eventually cause the glass to break; the porcelain top could craze (fine hairlike lines) or the steel top could show heat discoloration.

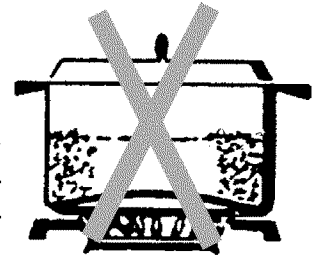

FLAME SETTING CHART GUIDELINES

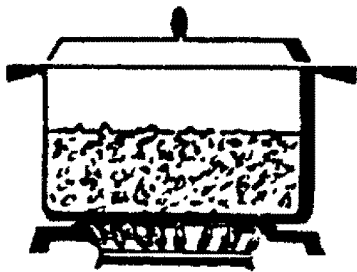

Use the right size flame for the cooking job

The Flame Setting Chart, on Pages 17 and 18, is to be used as a **guide**. Your pans and your manner of cooking may need a different setting than what is suggested. All flame settings were determined **using a variety of good quality, flat bottom pans with lids** (unless the method of cooking did not require a covered pan). The flame was matched to the size of the pan and the method of cooking: simmering, frying, braising, etc.

How to Use the Chart

The chart is divided into two sections: the food and the flame settings. The flame settings section shows an initial Start Cooking setting, a second Continue Cooking setting and /or an ExtraLow™ Heat setting. There may or may not be a change between the two Start Cooking and the Continue Cooking settings depending on the food prepared. The ExtraLow™ Heat (see pages 17-18) setting can be either a cooking, or a holding setting.

Models GGS/SGS shown

OFF

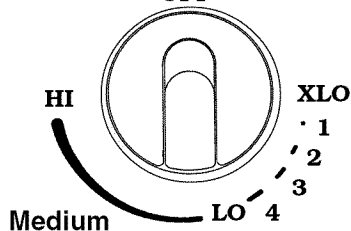

All the controls have an infinite number of heat settings, with no fixed positions between **HI, LO** or **XLO**. The word (**Medium**) and number designations are for reference only and are guides to the flame settings referenced in the following chart.

Guidelines:

1. **The actual flame setting used to cook is selected from the range of flame settings given.** Whether the higher or lower setting is selected depends on the quality of the pan, the amount of food, and the BTU/HR rating of the burner used.
2. **Raise or lower the flame setting gradually.** Allow time for the pan and food to adjust to the new setting. Changes are more satisfactory when the increased or decreased setting is only one or two markings on the control.

Before using this chart, read Page 16.

FOOD	START COOKING	CONTINUE COOKING	EXTRALOW™ HEAT SETTINGS
BEVERAGES Cocoa	Med. — heat milk, cover	LO — finish heating	XLO — keep warm, cover*
BREADS French Toast, Pancakes, Grilled Sandwiches	Med. — preheat skillet	Med. Lo to Med. — cook	
BUTTER			4 to 3 — allow 5 to 10 minutes to melt XLO — to hold
CEREALS Cornmeal, Grits, Oatmeal	HI — cover, bring water to a boil, add cereal	Med. Lo to Med. — finish cooking according to package directions	XLO — to hold, cover*
CHOCOLATE			2 to XLO — allow 10 to 15 minutes to melt XLO — to hold*
DESSERTS Candy	Med. Lo to Med. — cook following recipe	Med. Lo to Med.	
Pudding and Pie Filling Mix	Med. to Med. Hi — cook according to package directions	Med. to Med. HI	
Pudding	Med. Lo — Bring milk to a boil		3 to 2 — to cook
EGGS Cooked in Shell	HI — cover, bring water to a boil, add eggs, cover		XLO — cook 3 to 4 minutes for soft cooked; or 15 to 20 minutes for hard cooked
Fried, Scrambled	Med. to Med. Hi — melt butter, add eggs	LO to Med. Lo — finish cooking	XLO — to hold for a short period*
Poached	HI — bring water to the steaming point, add eggs		4 to 3 — finish cooking
MEAT, FISH, POULTRY Bacon, Sausage Patties	HI — until meat starts to sizzle	Med. Lo to Med. — finish cooking	
Braising: Swiss Steak, Pot Roast, Stew Meat	HI — melt fat, then brown on Med. Hi to HI , add liquid, cover,		3 to 2 — simmer until tender
Quick Frying: Breakfast Steaks	Med. Hi to HI — pre-heat skillet	Med. Hi to HI — fry quickly	
Frying: Chicken	HI — heat oil, then brown on Med.	LO — cover, finish cooking	
Deep Frying: Shrimp	HI — heat oil	Med. Hi to HI — to maintain temperature	
Pan Frying: Lamb Chops, Thin Steaks, Hamburgers, Link Sausage	HI — preheat skillet	Med. to Med. HI — brown meat	4 to 3 — to hold, covered 3 to 2 — to hold, uncovered
Poaching: Chicken, whole or pieces, Fish	HI — Cover, bring liquids to a boil		2 to 1 — to finish cooking

SUGGESTED FLAME SETTINGS

FOOD	START COOKING	CONTINUE COOKING	EXTRALOW™ HEAT SETTINGS
Simmering: Stewed Chicken, Corned Beef, Tongue, etc.	HI — cover, bring liquid to a boil		4 to 1 — simmer slowly
PASTAS Macaroni, Noodles, Spaghetti	HI — bring water to a boil, add pasta	Med. Hi to HI — to maintain a rolling boil	
POPCORN (use a heavy, flat bottom pan)	HI — cover, heat until kernels start to pop	Med. to Med. Hi — finish popping	
PRESSURE COOKER Meat	Med. Hi to HI — build up pressure	Med. Lo to Med. — maintain pressure	
Vegetables	HI — build up pressure	Med. Lo to Med. — maintain pressure	
RICE	HI — cover, bring water to a boil, add rice, cover		4 to 2 — cook according to package directions XLO — to hold, cover
SAUCES Tomato Base	Med. Hi to HI — cook meat/vegetables, follow recipe		2 to XLO — simmer (2 to 3 to thicken sauce, uncovered)*
White, Cream, Bernaise, Hollandaise	Med. Lo — melt fat, follow recipe	LO to Med. Lo — finish cooking	XLO — to hold, cover*
SOUPS, STOCK	HI — cover, bring liquid to a boil		3 to 2 — simmer XLO — to hold, cover*
VEGETABLES Fresh	HI — cover, bring water and vegetables to a boil	Med. Lo to Med. — cook 10 to 30 minutes, or until tender	XLO — to hold, cover
Frozen	HI — cover, bring water and vegetables to a boil	Med. Lo to Med. — cook according to package directions	
Deep Frying	HI — heat oil	Med. to Med. Hi — maintain frying temperature	
In Pouch	HI — cover, bring water and vegetables to a boil	LO to Med. Lo — cook according to package directions	
Saute	HI — heat oil or melt butter; add vegetables	Med. Lo to Med. — cook to desired doneness	
Stir Fry	HI — heat oil, add vegetables	Med. Hi to HI — finish cooking	

* We recommend that these foods be stirred occasionally.

**GRIDDLE'N GRILL™
(Model SGS)
GRIDDLE ONLY
(Model SGN)**

Your new Thermador Griddle'n Grill is a dual purpose electric appliance; a griddle and a grill. The griddle and the grill are used separately and must sit directly on the element for best cooking results. If the griddle or the grill does not sit on the element, it will not heat enough for foods to cook properly.

The Griddle'n Grill control has an infinite number of heat settings. There are no fixed positions between **HI** and **LO**.

To turn the element ON, push in on the control knob and turn it in either direction to the desired setting. See chart for the **griddle settings**.

When **ON**, this element cycles a percentage of **HI** power on and off to maintain the selected heat setting. On **HI** it does not cycle.

Griddle Finish

The aluminum griddle is very durable. It features a stick resistant surface that is an integral part of the metal; it is not a coating. This hardness is achieved through a special anodizing process which changes the surface metal structure. This surface will not rust, chip or peel. Because of its hardness, metal utensils may be used on it while cooking; however, cutting food with a knife or other sharp utensil should be avoided.

Stains, Shadows

Stains on the finish usually result from improper cleaning of the griddle. Minor stains, shadows or images are considered normal and do not effect the performance of the griddle. To maintain good performance and appearance, always follow the cleaning instructions, see Page 24.

BEFORE USING THE GRIDDLE or THE GRILL
Wash the griddle and the grill with hot sudsy water, then rinse thoroughly with clear hot water and dried. This should remove any manufacturing oils which may still be on the surface. A small amount of oil or butter applied after preheating helps to prevent sticking.

GRIDDLE/GRILL CONTROL KNOB and SIGNAL LIGHT

The signal light turns on when any heat setting is selected for the griddle or the grill

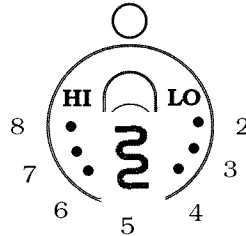

The number designations, on the illustration, are for reference only and are guides to the heat settings in this chart.

SUGGESTED HEAT SETTINGS CHART GRIDDLE		
FOOD	PREHEAT AT SETTING	COOK AT SETTING
BREADS French Toast, Pan cakes, Grilled Sandwiches	6 to 8 — to pre-heat, until water dances, about 8 minutes	7 to 8 — to cook
EGGS Fried, Scrambled	5 to 6 — to pre-heat, about 5 minutes, then melt butter, add eggs	4 to 6 — to cook
FISH Fish Sticks	HI — to preheat	7 to 8 — to cook
MEAT Bacon, Sausage Patties and Links	Put meat on cold griddle. HI — until meat starts to sizzle, about 3 to 4 minutes	6 to 8 — to cook.
Hamburgers, Ham Slice	HI — until meat starts to sizzle	8 to HI — to cook.
Vegetables Hash Brown Potatoes	HI — to brown	8 to HI — to cook.

GRIDDLE 'N GRILL OPERATION

USING THE GRIDDLE

1. Remove the Griddle'n Grill cover and be sure the element is plugged all the way into the receptacle. The two fixed supports on the bottom of the element must rest in the indentations in the bottom of the drip pan.
Place the griddle directly on top of the element.
3. **Preheat the griddle according to the chart. After preheating, lightly coat griddle surface with cooking oil or butter.** (A paper towel coated with oil works well to cover surface evenly.)
4. Place food on the griddle.
5. Adjust the heat setting for the food being cooked.

Griddle settings may need to be adjusted to a lower setting if the griddle is used for an extended period of time. When cooking foods such as bacon, the well may need to be drained of grease. When draining grease from the well, always drain away from the cooktop. It is a good idea to turn the gas flame off before moving the griddle so that any grease that spills will not flare up. Be sure to wipe any drips off the griddle before returning it to the cooktop.

If a residue develops while cooking try sprinkling the surface with salt. Rub the salt vigorously into the surface of the griddle with a paper towel. Wipe salt off and continue cooking.

It is important that the griddle be thoroughly cleaned after each use (see Cleaning Chart on Page 24).

THE GRILL (MODEL SGS)

DO NOT leave the grill unattended while grilling food.

1. Remove the Griddle'n Grill cover. Be sure the element is plugged all the way into the receptacle. The two fixed supports on the bottom of the element must rest in the indentations in the bottom of the drip pan.

DO NOT USE BRIQUETS OR COALS OF ANY KIND UNDER THE GRILL

2. Place the grill directly on top of the element.
3. Turn the control knob to HI and preheat the grill for 10 minutes.

NOTE: The hot grill will sear the food sealing in the juices. The longer the preheat, the faster the meat browns and the darker the grill marks.

4. Place the food on the grill and cook to desired doneness (most foods are cooked on HI heat setting for the entire cooking time).

GRILLING HINTS

Foods cooked for a long time or basted with a sugary marinade may need a lower heat setting near the end of the cooking time. The control knob may be set at any indicated setting or to any position in between.

If large amounts of meat are cooked at one time, occasionally there will be grease drippings that ignite and create minor puffs of flame for a brief second or two. This is a normal part of the cooking process. **Should flame become excessive, remove the food from the grill, turn the control to OFF. Use baking soda to extinguish the flames.**

NOTE: Quantities of accumulated grease may flame or flare up suddenly.

The doneness of meat, whether rare, medium, or well done, is affected to a large degree by the thickness of the cut. Expert chefs say it is impossible to have a rare doneness with a thin cut of meat.

The cooking time is affected by: the kind of meat, the size and shape of the cut, the temperature of the meat when cooking begins, and the degree of doneness desired.

Use a spatula instead of tongs or a fork to turn the meat, as a spatula will not puncture the meat and let the juices run out.

To get the juiciest meats: add seasoning or salt after the cooking is finished; turn the meat only once (juices are lost when the meat is turned several times); and turn the meat just after the juices begin to bubble to the surface.

Trim any excess fat from the meat before cooking. To prevent steaks or chops from curling during cooking, slit the fat around the edges at 1 to 1-1/2 - inch intervals.

To test for doneness, make a small slash in the center of the meat, not at the edge. This will prevent loss of juices.

VENTILATOR

Models GGSCV30/36/365 and SGSCV36G

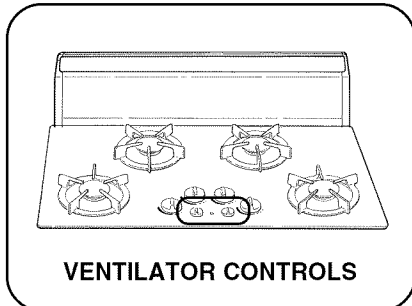

The ventilator is a 500 CFM exhaust system that can be hidden away when not in use. It has a variable speed blower. The amount of drawing power can be adjusted to the cooking job; **HI** exhaust for frying, **LO** for light simmering, or anywhere in between.

RAISING AND LOWERING THE VENTILATOR

The ventilator is raised and lowered by the control knob on the right. It must complete either the up or down cycle before it can be moved in the opposite direction. Be certain it is completely raised or lowered before trying to move it in the opposite direction.

To raise the vent, turn the Vent control knob to the right (UP) until the vent intake no longer moves upward. It automatically stops moving when the maximum height is reached or when the push-button is released.

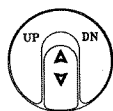

To lower the vent, turn the Vent control knob to the left (DN) until the vent intake is completely lowered. You will hear a **click** when it is completely lowered.

BLOWER SPEED CONTROL

The blower control allows you to select the drawing power needed for a particular food or cooking method.

The vent intake must be in the raised position for the blower to turn on. If it is not fully raised, the blower will not turn on.

To turn the blower ON, turn the control knob clockwise for power continue turning to the right for **LO**.

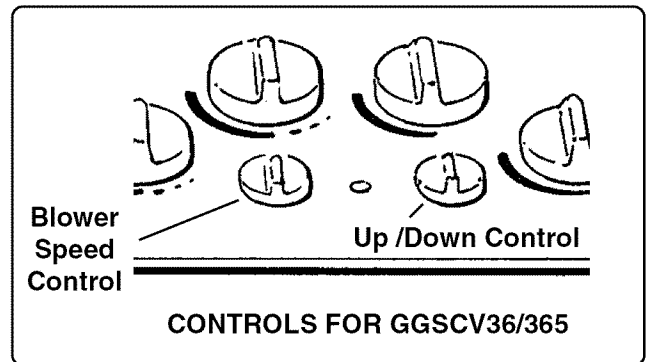

The control knob does not have to be turned OFF manually before the vent intake is lowered. It turns OFF automatically when the Vent DOWN control knob is turned towards the down position. If the control knob is not turned off, it will automatically be ON the next time the intake is fully raised.

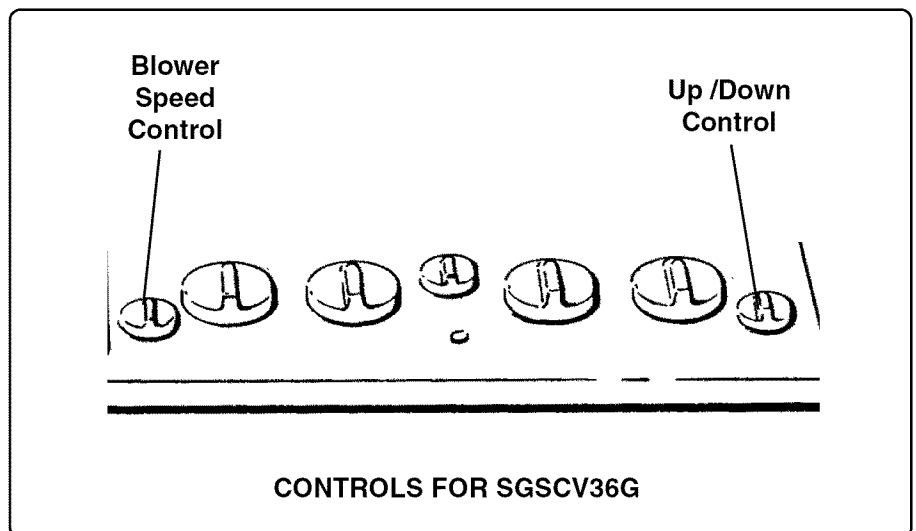
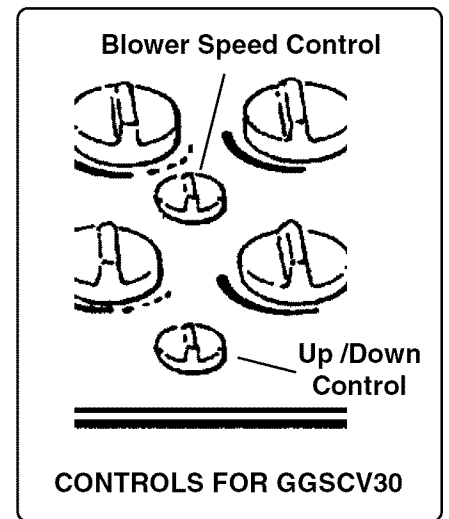

GENERAL CARE

Before cleaning be certain the burners are turned off and the grates are cool.

Any part of the cooktop can be cleaned with hot, sudsy water, then rinsed and dried with a clean, dry

BURNERS

The best cleaning method is prevention. Follow the recommended cleaning procedures and never let the burners get too dirty. If you have a spillover, let the burner cool, then clean immediately. If stains and cooking oils are allowed to burn into the burner, they become more difficult to remove. Refer to Cleaning Chart Page 24, for specific instructions.

DAILY CLEANING

Wipe the burner with a cloth dipped in warm sudsy water, then rinse with a cloth dipped in clean water. **Avoid getting excess water on the igniter.**

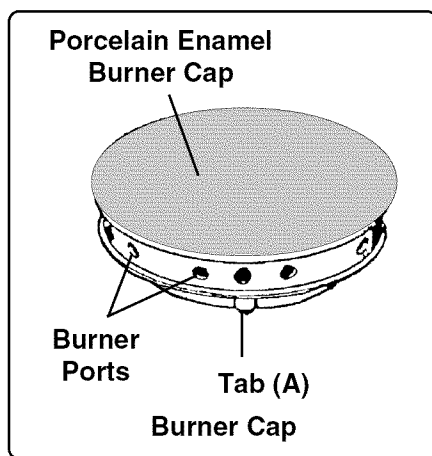

BURNER CAPS

Over a period of time the porcelain enamel burner cap may craze (get fine hair like lines) and discolor or become iridescent. This is normal.

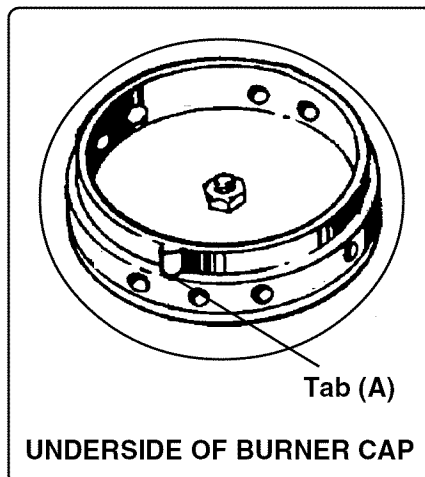

Be sure the burner cap fits correctly; the flame will not burn completely or correctly if cap is not positioned with Tab A in Notch B. **Keep the burner ports clear.** If the ports are clogged, use a wire, a straightened paper clip or a needle to clear the ports. **Do not use a toothpick; it could break off in the ports.**

IGNITERS

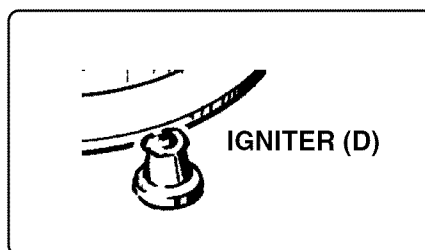

Each burner has an igniter (D) located on the burner plate. Keep the igniters clean. **Avoid getting excess water or liquid cleaner on the igniter.** If the igniter becomes too wet, it may continue to click but not ignite the burner. If the burner does not ignite in 4 seconds, turn off the control and wait until the igniter is dry.

BURNER PLATES

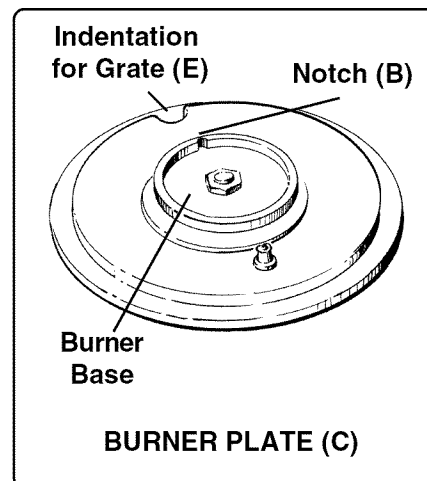

The porcelain enamel finish of the burner plate (C) is acid resistant, but not acid proof. Acid foods, such as citric juices, tomatoes, rhubarb, vinegar, alcohol or milk, should be wiped up immediately. If not removed, they may affect the porcelain finish. Use a paper towel or dry cloth on warm surfaces.

Other food soils can be wiped up with warm soapy water after the cooktop has cooled. Rinse and wipe dry.

BURNER GRATES

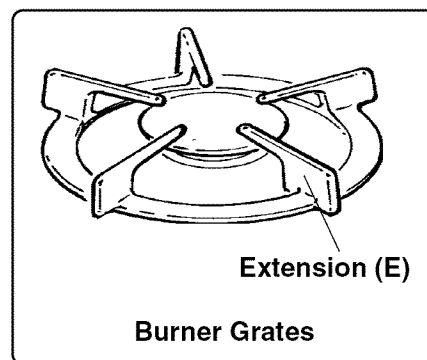

The grates are porcelain enameled cast iron or steel. They should be washed regularly and especially after spillovers. When replacing grates on the burner plates (C), the extension (E) is indexed into indentation (E) directly across from the igniter (D). See illustration Page 22, under Burner Plates.

GENERAL CARE

CONTROL KNOBS

To Remove: Turn the control knob to the **OFF** position and pull up.

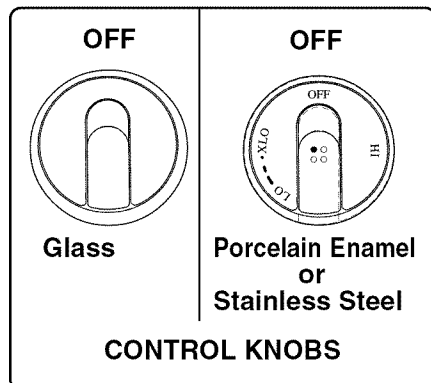

To Replace: Hold the knob with the **OFF** position up, so that the control knob stem opening on the underside of the knob aligns with stem. Push knob down. **Do not force the knob onto the stem.**

To clean, see Cleaning Chart, "PLASTIC," Page 25. **Do not soak knobs.**

COOKTOP FINISH

Glass

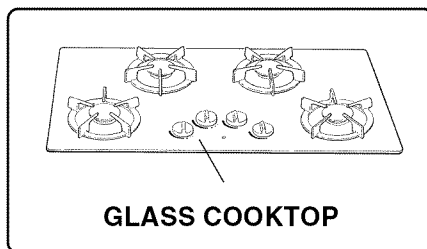

The glass on your cooktop has been fully tempered to withstand the sudden temperature changes it will experience during cooking. It is also highly impact resistant. Treat this glass with the normal care you would give any glass material. To clean, see Cleaning Chart, "GLASS," Page 24.

PORCELAIN ENAMEL

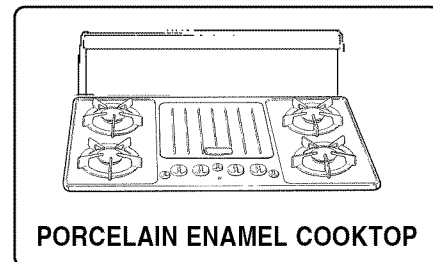

The porcelain enamel finish of the burner plate (C) and the cooktop are acid resistant, but not acid proof. Acid foods, such as citric juices, tomatoes, rhubarb, vinegar, alcohol or milk, should be wiped up immediately. If not removed, they may affect the porcelain finish. Use a paper towel or dry cloth on warm surfaces.

Other food soils can be wiped up with warm soapy water after the cooktop has cooled. Rinse and wipe dry. To clean, see Cleaning Chart, "PORCELAIN ENAMEL," Page 25. See "Stainless Steel" info on Page 25.

DO NOT CLEAN ANY REMOVABLE COOKTOP PARTS IN ANY SELF-CLEANING OVEN. DO NOT USE THE COOKTOP WITHOUT THE BURNER GRATES IN PLACE. BE SURE ALL BURNERS ARE IN THE OFF POSITION BEFORE WIPING OR CLEANING COOKTOP.

CLEANING CHART

When cleaning various parts of the cooktop:

1. Use the mildest cleaning procedure that will do the job efficiently and effectively. Some cleaners of the same type are harsher than others. Try a small area first.
2. Use only clean soft cloths, paper towels, and soap-filled pads for cleaning and scouring.
3. Any part of this appliance can be cleaned with hot sudsy water. Rinse thoroughly with fresh water after every cleaning operation.
4. Always wipe dry to avoid water marks.

The chart on the following page gives directions for cleaning the various parts of the cooktop.

BRAND NAMES

The use of brand names is intended only to indicate a type of cleaner. This does not constitute an endorsement. The omission of any brand name cleaner does not imply its adequacy or inadequacy. Many products are regional in distribution and can be found in the supermarkets.

It is imperative that all products be used in strict accordance with instructions on the package.

CLEANING CHART

DO NOT CLEAN ANY REMOVABLE PARTS OF THIS APPLIANCE IN ANY SELF-CLEANING OVEN. BE SURE ALL BURNERS ARE IN THE OFF POSITION BEFORE WIPING OR CLEANING COOKTOP

MATERIAL/PART	CLEANING PRODUCTS/DIRECTION
	<p>Any part of this appliance can be washed with hot sudsy water, except element.</p> <ul style="list-style-type: none"> Wash thoroughly, rinse and dry.
<p>ALUMINUM Filters (Models GGSCV30/36/365 & SGSCV36G)</p>	<p>Hot sudsy water or wash in dishwasher</p> <ul style="list-style-type: none"> Agitate in hot soapy water, rinse thoroughly and allow to dry, or put through a dishwasher cycle.
<p>Burner Base</p>	<p>Fiber or steel wool soap pad: PanHandl'rs®, S.O.S®</p> <ul style="list-style-type: none"> Rub in circular motion, as small scratch lines will be noticeable. Rinse and dry. Aluminum cleaners may dull the surface. <p>Revereware® Metal Polish will help to retain the luster.</p> <ul style="list-style-type: none"> Follow the directions on the package.
<p>Griddle • Normal</p>	<p>Hot sudsy water, sponge or nylon pad.</p> <ul style="list-style-type: none"> Wash thoroughly with hot soapy water, rinse and dry. Always wash and rinse the griddle thoroughly after each use. Some discoloration may occur with use, but will not affect performance. When not thoroughly cleaned you will feel a film of food residue; this will cause food to stick.
<p>• Hard to Remove Soil</p>	<p>Scouring Pad: Medium grade, Scotch Brite®</p> <ul style="list-style-type: none"> Wash thoroughly with this type scrubber. If necessary sprinkle 1 - 2 Tablespoons baking soda or mild cleanser on wet griddle, rub with a paper towel or nylon pad to remove food soil. Wash with hot soapy water, rinse and dry. <div style="border: 1px solid black; padding: 5px; margin-top: 10px;"> <p>Never wash the griddle in the dishwasher. The caustic detergent used in the dishwasher will discolor the surface. Never use oven cleaners or other harsh cleaning agents, this could destroy the surface.</p> </div>
<p>Grill • Normal</p>	<p>Hot sudsy water</p> <ul style="list-style-type: none"> Always wash and rinse the grill thoroughly after each use. It can be washed in the dishwasher if burned on residue is removed first.
<p>• Hard to Remove Soil</p>	<ul style="list-style-type: none"> Soak grill in hot, sudsy water to which a household cleaner like ammonia has been added.
<p>CERAMIC Igniters</p>	<p>Avoid excess water on the igniters. If an igniter becomes too wet, it may continue to click, but not ignite the burner. If the burner does not ignite in 4 seconds, turn off the control and wait until the igniter is dry.</p> <p>Cotton Swab or toothpick</p> <ul style="list-style-type: none"> Wipe with dampened swab. If necessary, scrape with a toothpick. Be careful not to damage the igniter.
<p>GLASS Cooktop Surface</p>	<p>Glass or window Cleaners: Windex®, Glass Plus®, ammonia and water, or vinegar and water solution</p> <ul style="list-style-type: none"> Spray on and wipe dry. Use a clean dry cloth, paper towel or newspaper to polish.
<p>• Water Spots</p>	<p>Undiluted vinegar.</p> <ul style="list-style-type: none"> Rub on with a dampened cloth or sponge, rinse, and dry. <p>Soft Scrub®, mild abrasive liquid cleanser.</p> <ul style="list-style-type: none"> Use sparingly and rub gently with a damp sponge or soft cloth. If rubbing is hard or if an abrasive pad is used, scratching may occur. Rinse and dry.

CLEANING CHART

MATERIAL/PART	CLEANING PRODUCTS/DIRECTION
<p>ELEMENT Griddle Element</p>	<p>DO NOT RINSE OR IMMERSE ANY ELEMENT IN WATER. The element will clean itself when turned onto the HI setting. The drip pan must always be in place when cooking on the Griddle'n Grill. Do not leave the cooktop unattended when cleaning the element.</p>
<p>PLASTIC Control Knobs</p>	<p>Hot sudsy water.</p> <ul style="list-style-type: none"> • Pull knobs straight up from cooktop. Wash, do not soak. Rinse, then dry. When replacing knobs match the stem opening on the back of the knob with the stem. Do not force knobs onto stems. • Some knobs may discolor temporarily from food stains; this color will lighten and disappear in a few days. Do not wash knobs in the dishwasher.
<p>PORCELAIN ENAMEL Burner Caps, Burner Plates, Grates, Cooktop Surface</p>	<p>The Porcelain Enamel used on the cooktop is acid resistant, but not acid proof. If foods such as citric juices, tomatoes, vinegar, milk, etc. are spilled, wipe up immediately or it may effect the finish.</p> <p>Hot sudsy water.</p> <ul style="list-style-type: none"> • Wash, rinse thoroughly with hot water, and dry. • For burned on food soil, soak the grates in hot soapy water. <p>Mild Cleansers: Bon-ami, Soft Scrub.</p> <ul style="list-style-type: none"> • Apply to a damp sponge or cloth. Rub lightly. Rinse thoroughly and dry. <p>Fiber or steel wool soap pads: PanHandl'rs, S.O.S, Brillo.</p> <ul style="list-style-type: none"> • For stubborn stains, the occasional use of abrasive cleansers is okay, but, if used vigorously or too often, they can eventually harm the enamel. Dampen pad, rub lightly, rinse thoroughly, and dry.
<p>STAINLESS STEEL Cooktop, Ventilator</p> <ul style="list-style-type: none"> • Grease, food spatters, fingerprints 	<p>The quality of this material resists most stains and pitting, providing the surface is kept clean and protected.</p> <p>Nonabrasive Cleaners: Hot soapy water ammonia, or detergent and water.</p> <ul style="list-style-type: none"> • Apply with sponge or cloth, then wipe clean using a clean cloth and thoroughly dry the surface. Apply stainless steel cleaner-polish such as; Stainless Steel Magic® to protect the finish and leave a soft lustre. • Wipe off the stainless steel front and back panels of the vent after each use. Rinse, then polish with a dry cloth, rubbing in the direction of the grain. • If grease has accumulated on the inside of the back panel of the vent, use a nylon or other soft-touch spatula to lift the accumulated grease from the back panel. To reach the back panel, remove the front panel and filters. See page 26. <p>Mild Cleaners: Stainless Steel Magic®, general kitchen cleaners such as Fantastik®, Formula 409®.</p> <p>Vinegar: to remove hard water spots.</p> <ul style="list-style-type: none"> • Apply with sponge or cloth, then wipe clean using a clean cloth and thoroughly dry the surface. <p>Mild abrasive Cleaners: RevereWare Instant Stainless Steel Cleaner®, Kleen King® Stainless Steel Cleaner.</p> <ul style="list-style-type: none"> • Apply with a damp sponge or cloth. <i>Rub lightly in direction of the polish lines.</i> Wipe clean using damp cloth or sponge and dry surface. <div style="border: 1px solid black; padding: 5px; margin-top: 10px;"> <p>Remember, chlorine or chlorine compounds (check the labels) are corrosive even to stainless steel. It is very important to rinse thoroughly and dry if a cleaning agent with chlorine is used.</p> </div>
<ul style="list-style-type: none"> • Heat Tint or discoloration 	<p>Abrasive Cleaners: RevereWare Instant Stainless Steel Cleaner, Zud®.</p> <ul style="list-style-type: none"> • Apply with a damp cloth or sponge. Satisfactory for uses on all finishes if rubbing is light. <i>Use in direction of polish lines.</i>

COOK'N'VENT® VENTILATOR CARE*

See "SAFETY PRACTICES," on Page 4.

The efficiency of the exhaust system depends on the cleanliness of the ventilator, especially the filters. The frequency of cleaning depends on the amount and type of cooking performed.

FILTERS and INTAKE PANEL

Filters become soiled in a short period of time and should be cleaned regularly. The filters may be cleaned by agitating them in a hot detergent solution or by washing in the dishwasher.

Do not use the ventilating system without the filters in place.

TO REMOVE THE FILTERS AND CLEAN THE PANEL

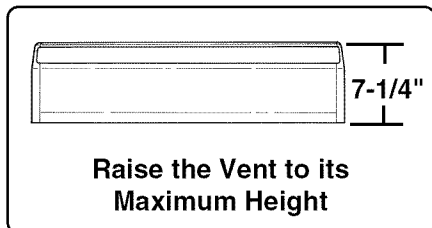

1. Raise the ventilator intake to its maximum height. If the blower is on, turn it off.

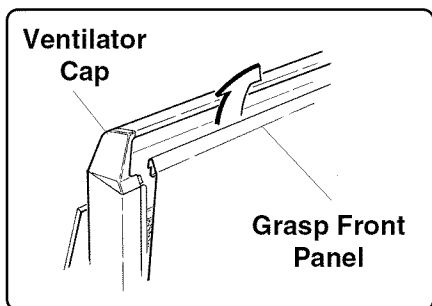

2. Grasp the front panel at the top towards the sides and pull up and forward: remove and set aside.
3. Remove the ventilator cap by grasping both ends of the cap and lifting up.
4. Lift out the filters and clean.

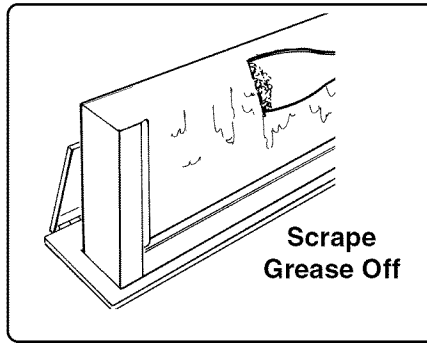

5. Using a nylon or other soft-touch spatula, lift the accumulated grease from the back panel - behind the filters. Clean front and back panels using a mild grease solvent (See Cleaning Chart for Stainless Steel).

TIP: Wipe the intake off after each use.

TO REPLACE THE FILTERS AND THE FRONT PANEL

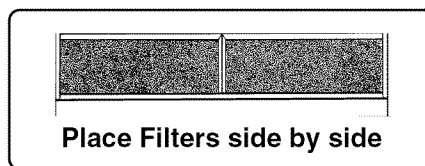

6. Place the filters side by side on the support bars in front of the back panel. They will lean forward and the tops will rest against the inside of the front panel supports.
7. Replace ventilator cap. Be certain all sides of the cap fit inside the ventilator sides and back panel.

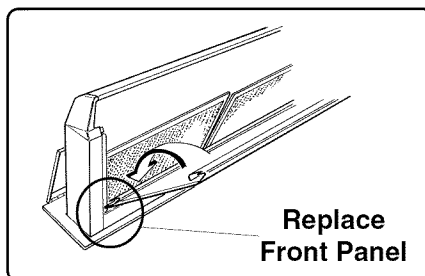

8. Replace the front panel by hooking the lower front edge of the front panel over the lower front edge of the ventilator.

Side Supports

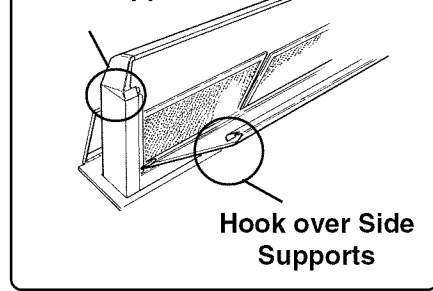

9. Hook the top of the front intake panel over the side supports at the top of the ventilator.

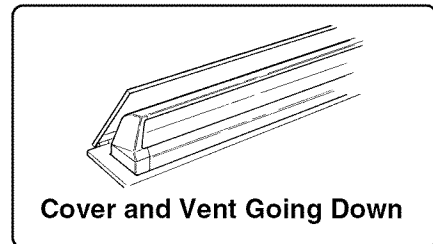

10. As the ventilator intake is lowered, the cover will return to its position covering the ventilator.

To Clean Gap Area Between Ventilator & Cooktop

1. With ventilator in up position, remove front panel, ventilator cap and filters.
2. Lower ventilator completely.
3. Clean gap area using a mild grease solvent (see Cleaning Chart).
4. Raise ventilator completely and replace filters, cap and front panel.

* Not on all Models.

GENERAL CARE AND MAINTENANCE - COOK'N'VENT

ACCESS PANELS AND ELECTRICAL CONNECTIONS

Frequency of cleaning depends on how often the filters and back panel at the top of the unit are cleaned.

There are four different ways the Access Panels **A** and **B** could have been installed. **DO NOT OPEN ELECTRICAL BOX "E"**. See Installation Instructions.

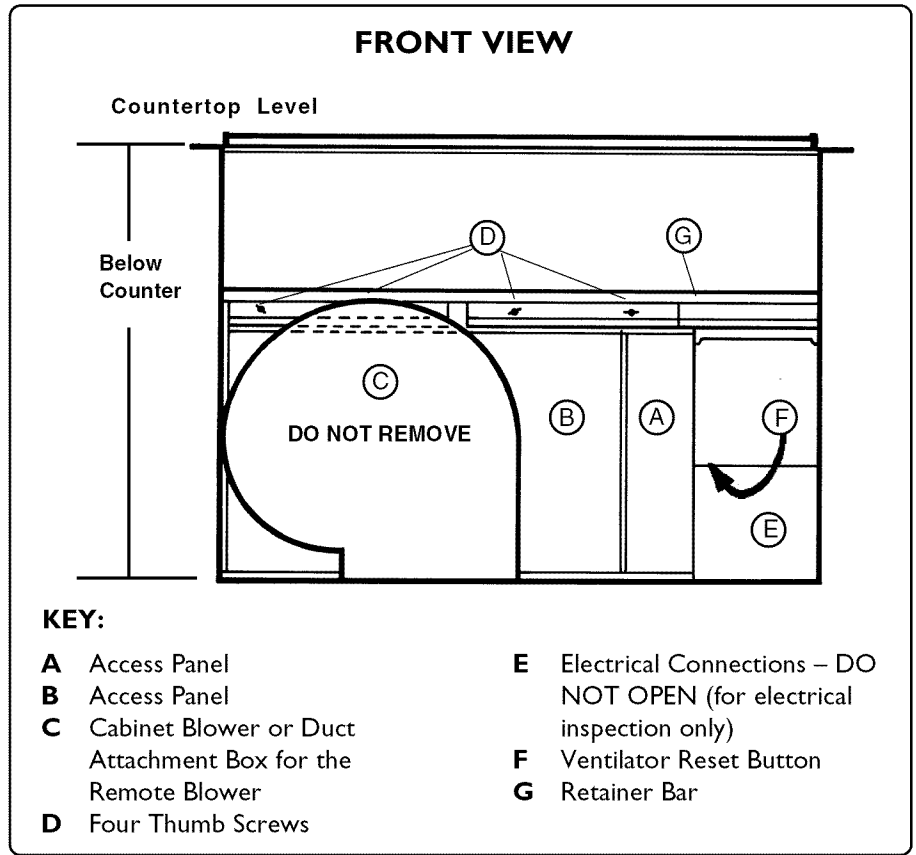
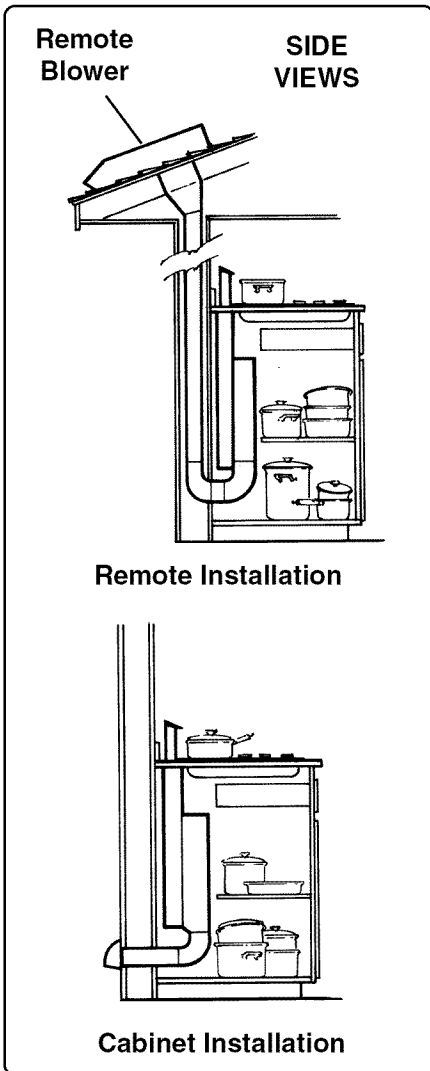

You have either a remote or a cabinet blower **C** installed on the ventilation system of your Cook'n'Vent cooktop.

There are access panels at the base of the ventilator system inside the cabinet. If there is a shelf under the cooktop, it must be removable as the Access Panels **A** and **B** and the Electrical Connection Box **E** must be accessible for cleaning, electrical inspection or service.

Periodically – approximately every six months – check the enclosure behind the access panels **A** and **B** for food soil.

TO REACH CLEAN OUT AREA

1. Loosen (but do not remove) the thumb screws (Item **D**).
2. While holding **C** (it is heavy), move the retainer bar **G** up and lift out panels **A** and **B**. Lower the retainer bar **G** so it will hold **C** in place.

DO NOT REMOVE BLOWER or DUCT ATTACHMENT BOX C
(remote blower installation).

3. Do not open the electrical box **E** on the right.
4. Wipe up any accumulated grease inside the area. Wipe with a cloth dampened with hot soapy water or use a general household spray for grease. Rinse and dry before closing the compartment.
5. After cleaning, replace the access panels and securely tighten the thumb screws.

BEFORE CALLING FOR SERVICE

Before calling for service, check the following to avoid unnecessary service charges.

<p>The burners do not light within 4 seconds:</p>	<ul style="list-style-type: none"> ▲ Are the igniters sparking? ▲ Is there excess water or liquid cleaner on the igniter? ▲ Is the burner cap level and properly positioned on the burner base? See Page 12. ▲ Are the burner ports clogged? See page 13. ▲ Is the gas shutoff valve in the ON position? ▲ Is the gas supply to the house or the area turned off?
<p>The igniters do not spark:</p>	<ul style="list-style-type: none"> ▲ Is the power cord plugged all the way into the wall receptacle? ▲ Is the circuit breaker tripped or household fuse blown? ▲ Is there a power outage in the area?
<p>The igniters spark intermittently:</p>	<ul style="list-style-type: none"> ▲ Is there a draft in the room? ▲ Check that the wires to the electric outlet have not been reversed. See Note below re: polarity. ▲ Was a liquid cleaner sprayed on the igniter?
<p>The burner flame is yellow, distorted or does not burn completely around the burner cap:</p>	<ul style="list-style-type: none"> ▲ Is the burner cap level and properly positioned on the burner base? See Page 12. ▲ Are the burner ports dirty or clogged? See Page 13. ▲ Was the the cooktop installed correctly? (Have it checked by a qualified technician.)
<p>Models SGS36G, SGSCV36G, SGNCV36G & SGN36G — If the Griddle element does not heat:</p>	<ul style="list-style-type: none"> ▲ Check to be certain the element terminals are pushed securely into the receptacle. If element needs replacement, use only original Thermador parts.
<p>Models GGNCV30/36, SGNCV36G, SGSCV36G: If the ventilation system does not operate:</p>	<ul style="list-style-type: none"> ▲ Check the reset button located at the bottom of the intake assembly, see Page 27, front view, item F.
<p>If there is a power failure:</p>	<ul style="list-style-type: none"> ▲ See Page 13.

NOTE: Polarity —In older houses, wiring polarity was not always observed. Although polarized receptacles (3 Prong) may have been installed, they could have been wired incorrectly. If they were wired incorrectly, the igniters see a grounded condition and may click intermittently even with both the control knobs turned OFF.

SERVICE INFORMATION

For handy reference, copy the information below from the rating plate. Keep your invoice for warranty validation.

Model Number

Serial Number

Date of Purchase

Dealer's Name

Dealer's Telephone Number

Service Center's Name

Service Center's Telephone Number

RATING PLATE

The Rating Plate shows the model number and serial number of your cooktop. It is located underneath the cooktop at the right front corner of the rough-in box.

WARRANTY

GG30/36/365 - GGSCV30/36/365 - SGS30 -SGS36G - SGSCV36G -
GGN30/36/365 - GGNCV30/36/365 - SGN30 - SGN36G - SGNCV36G

FULL ONE YEAR WARRANTY

Covers one year from date of installation, or date of occupancy on a new, or previously unoccupied dwelling. Save your dated receipt or other evidence of installation/ occupancy date.

Thermador Will Pay For:

All repair labor and replacement parts found to be defective due to materials and workmanship.

Service must be provided by a Factory Authorized Service Agency, during normal working hours. For a Service Agency nearest you, please call 800/735-4328.

Thermador Will Not Pay For:

1. Service by an unauthorized agency. Damage or repairs due to service by an unauthorized agency or the use of unauthorized parts.
2. Service visits to:
 - Teach you how to use the appliance.
 - Correct defects or repairs due to improper installation. You are responsible for providing electrical wiring and other connecting facilities.
 - Reset circuit breakers or replace home fuses.
 - Damage caused from accident, alteration, misuse, abuse, improper installation or installation not in accordance with local electrical codes or plumbing codes, or improper storage of the appliance.
 - Service labor during limited warranty period.
 - Travel fees and associated charges incurred when the product is installed in a location with limited or restricted access. (i.e., airplane flights, ferry charges, isolated geographic regions).
 - Repairs due to other than normal home use.

This warranty applies to appliances used in residential applications; it does not cover their use in commercial installations.

The warranty is for products purchased and retained in the 50 states of the U. S. A., the District of Columbia and Canada. Should the appliance be sold by the original purchaser during the warranty period, the new owner continues to be protected until the expiration date of the original purchaser's warranty period. Products for use in Canada must be purchased through the Canadian distribution channel to ensure regulatory compliance and warranty coverage.

This warranty gives you specific legal rights. You may also have other rights which vary from state to state.

HOW TO OBTAIN SERVICE

- Contact the Factory Authorized Service Agent in your area
- Contact the Dealership where you purchased the appliance.
- Call the Thermador Customer Support Call Center at 800-735-4328
- Write us to at: Thermador 5551 McFadden Avenue, Huntington Beach CA, 92649

Thermador Commitment:

Thermador wants to ensure that we exceed your expectations of support not only with your current appliance purchase, but well into the future. If an issue arises that is not resolved to your satisfaction, please let us know by calling or writing to us at the telephone number or address shown above.

Specifications are for planning purposes only. Refer to installation instructions and consult your countertop supplier prior to making counter opening. Consult with a heating and ventilating engineer for your specific ventilation requirements. For the most detailed information, refer to installation instructions accompanying product or write Thermador indicating model number.

We reserve the right to change specifications or design without notice. Some models are certified for use in Canada. Thermador is not responsible for products which are transported from the United States for use in Canada. Check with your local Canadian distributor or dealer.

For the most up to date critical installation dimensions by fax, use your fax handset and call 702/833-3600. Use code #8030.

Thermador[®]

5551 McFadden Avenue, Huntington Beach, CA 92649 • 800/735-4328
ECO 5V0065 • 20-02-373I • © 2001 BSH Home Appliances Corp. • Litho in U. S. A. 5/01

ECO 5V0065 • Part Number 50 60 00 05 01

Thermador[®]

Care and Use Manual

for
ExtraLow[™]
Gas Cooktops

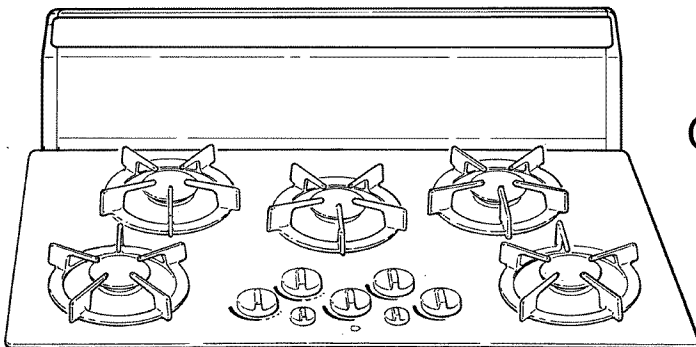
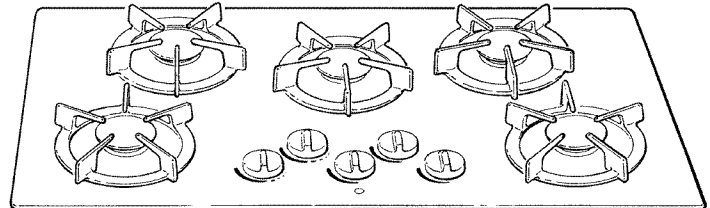

Models
GG30/36/365, GGSCV30/
36/365, SGS30/36G,
SGSCV36G

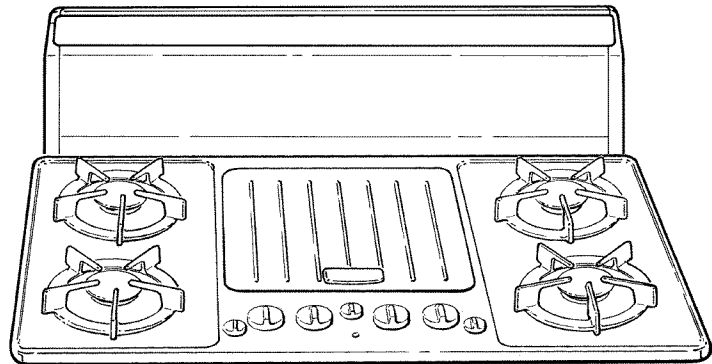

and
Traditional Series Gas Cooktops

Models
GGN30/36/365, GGNCV30/36/365, SGN30/36G, SGNCV36G

To the Installer: Leave this owner's manual with the cooktop.

To the Consumer: Retain this Care & Use Manual for future reference. Be sure to fill in the information on Page 28 for warranty validation.

A Special Message to Our Customers,

Thank you for selecting a Thermador Gas Cooktop. If you follow the few simple procedures and suggestions in this manual, the cooktop should give you years of service.

You have either a steel top or a glass top. The glass cooktop fully meets the safety and durability requirements of the American Gas Association, the Canadian Gas Association and the Tempered Glass Association as well as the stringent test requirements imposed by Thermador. Testing includes dropping a 1.2 pound steel ball from about 2 feet and hitting the glass with a 4 pound "pan bottom" 10 times. The cooktop is tough, but it is glass. Severe abuse or excessively rough treatment may break the glass. Tempered glass derives its excellent strength and heat resistance from powerful internal tensions throughout the piece. When any part of the glass is broken, these tensions are released throughout the piece. In this unlikely event, the entire glass will break into many small, blunt pieces called popcorn (the average count is 20 pieces per square inch). The pieces may scatter somewhat and since most particles are transparent, food on or near the cooktop should not be eaten. The cooktop should not be used again until it is repaired by a qualified service technician. Remember, the steel top is covered with porcelain enamel, which is also a very durable glass. Severe abuse or excessively rough treatment may cause the porcelain enamel to chip.

There is no limit to the types of food which can be cooked on your cooktop, but some utensils could harm it. Do not use any utensil which spans two burners because this will excessively heat the space between them. Utensils which have large overhangs beyond the burner grate may cause over heating or tipping, if used for long periods of time. Of course, hard impact should be avoided.

We recommend that you read this entire manual before using your new cooktop. We know you will enjoy cooking on your new cooktop. Please contact us if you have questions or comments. When you write, please include the model and serial numbers of your cooktop.

Sincerely,

The Home Economics Staff

TABLE OF CONTENTS

Propane Installation	2	Section Four: Using the Cooktop	10 to 21
Section One:		Cooktop Operation	11
General Safety Instructions	3 to 6	Proper Cookware	14
Safety/Electrical Requirements	3	Flame Setting Chart	16
Precautions	4	Griddle'N Grill Operation	19
Section Two: Before you Begin	6	Cook'n'Vent Operation	21
Before using your Cooktop	6	Section Five: General Care	22 to 27
Section Three: Description	7 to 10	General Care	22
Models GGS30, GGN30, GGSCV30		Cleaning Chart	23
GGNCV30	7	Cook'n'Vent Care	26
Models GGSCV36, GGSCV365, GGNCV36,		Section Six: Service	28 to 29
GGNCV365	8	Before Calling For Service	28
Models GGS36, GGN36, GGS365,		Warranty	29
GGN365	9		
Models SGS30, SGN30, SGS36G,			
SGN36G, SGSCV36G, SGNCV36G.	10		



WARNING

If the information in this manual is not followed exactly, a fire or explosion may result causing property damage, personal injury or death.

— Do not store or use gasoline or other flammable vapors and liquids in the vicinity of this or any other appliance.

WHAT TO DO IF YOU SMELL GAS

- Do not try to light any appliance.
- Do not touch any electrical switch; do not use any phone in your building.
- Immediately call your gas supplier from a neighbor's phone. Follow the gas supplier's instructions.
- If you cannot reach your gas supplier, call the fire department.

— Installation and service must be performed by a qualified installer, service agency or the gas supplier.

PROpane INSTALLATION

PROPANE GAS INSTALLATION

The cooktop is ready for use with natural gas. It may be converted for use with propane gas using the Burner Propane Conversion Kit, Model NLPKIT6, Part Number 35-00-688. A qualified service technician or installer can convert the cooktop. Be sure the unit being installed is correct for the type of gas being used. Refer to the Rating plate on the right side underneath the cooktop, see pages 7 to 10 for the location.



CAUTION

When connecting the unit to propane gas, make certain the propane tank is equipped with its own high pressure regulator. In addition the pressure regulator supplied with the cooktop must be on the inlet gas pipe of this unit. **The maximum gas pressure to this appliance is not to exceed 14.0 inches water column from the propane gas tank pressure regulator.**

TESTED IN ACCORDANCE WITH ANSI Z21.1, STANDARD FOR HOUSEHOLD COOKING GAS APPLIANCES, and CAN/CGA 1.1 DOMESTIC GAS RANGES.

Check your local building codes for the proper method of installation. In the absence of local codes this unit should be installed in accordance with the National Fuel Gas Code No. Z223.1 Current Issue and National Electrical Code ANSI/NFPA No. 70 Current Issue or the CAN - B149 Installation Codes for Gas Burning Appliances and C22.1 Canadian Electrical Code Part 1.

ELECTRICAL REQUIREMENTS AND GROUNDING INSTRUCTIONS

PLEASE READ CAREFULLY

MODELS: GG30/36/365,
GGSCV30/36/365,
SG30, GGN30/36/365
GGNCV30/36/365 &
SGN30

Rated 120 volt, 60 Hz., 1.0 Amp.

MODELS: SG36G, SGSCV36G
SGN36G & SGNCV36G

Rated 120 volt, 60 Hz., 11.7 Amp

See Installation Instructions for electrical requirements and grounding instructions.

DO NOT UNDER ANY CIRCUMSTANCES CUT OR REMOVE THE THIRD (GROUND) PRONG FROM THE POWER CORD PLUG.

If the electrical outlet you intend to use does not accept the 3-prong plug, it is the personal responsibility and obligation of you, the user, to have it replaced with a properly grounded 3-prong wall receptacle in accordance with the National Electrical Code and/or applicable local codes and ordinances, by a qualified electrician.

**FOR PERSONAL SAFETY,
 THIS APPLIANCE MUST BE
 PROPERLY GROUNDED.**

ALWAYS DISCONNECT THE ELECTRICAL PLUG FROM THE WALL RECEPTACLE BEFORE SERVICING THIS UNIT.

The power cord on your cooktop is equipped with a three prong grounding plug with polarized parallel blades. This type of plug is for your protection against shock hazard. This cord must be plugged directly into a properly grounded 3-prong wall receptacle that is **connected to a correctly polarized 120 volt electric power supply**. It is recommended that a separate circuit serving each appliance be provided.

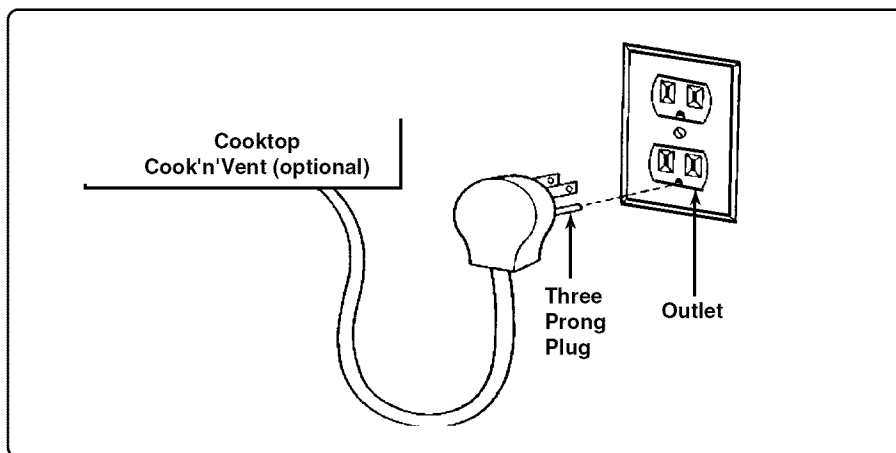

CAUTION - ALL MODELS

IN CASE OF AN ELECTRICAL FAILURE

If for any reason a gas control knob is turned ON and there is no electric power to operate the electronic igniter of the cooktop, **turn OFF the gas control knob and wait 5 minutes** for the gas to dissipate before lighting the burner manually. **On the models with the ExtraLow™ Gas the two left burners cannot be turned on manually.**

To light the burners, carefully hold a lighted match to the burner ports and turn the gas control knob to HI. During a power failure you can use the cooktop burners, but each must be lit with a match.

PRECAUTIONS

SAFETY PRACTICES TO AVOID PERSONAL INJURY

IMPORTANT SAFETY INSTRUCTIONS

WARNING - TO REDUCE THE RISK OF FIRE, ELECTRIC SHOCK, OR INJURY TO PERSONS, OBSERVE THE FOLLOWING:

- A. Use this unit only in the manner intended by the manufacturer. If you have any questions, contact the manufacturer.
- B. Before servicing or cleaning unit, switch power off at service panel and lock service panel to prevent power from being switched on accidentally.
- C. Use high range settings on range only when necessary. Heat oil slowly on low to medium setting.
- D. Do not leave range unattended when cooking.
- E. Always use cookware and utensils appropriate for the type and amount of food being prepared.

CAUTION: For General Ventilating Use Only. Do Not Use To Exhaust Hazardous or Explosive Materials and Vapors.

WARNING - TO REDUCE THE RISK OF FIRE, ELECTRIC SHOCK, OR INJURY TO PERSONS, OBSERVE THE FOLLOWING:

- A. SMOTHER FLAMES with a close-fitting lid, cookie sheet, or other metal tray, then turn off the gas burner or the elec-

tric element. BE CAREFUL TO PREVENT BURNS. If the flames do not go out immediately EVACUATE AND CALL THE FIRE DEPARTMENT.

- B. NEVER PICK UP A FLAMING PAN - You may be burned.
- C. DO NOT USE WATER, including wet dishcloths or towels - a violent steam explosion will result.
- D. Use an extinguisher **ONLY** if:
 1. You know you have a Class ABC extinguisher, and you already know how to operate it.
 2. The fire is small and contained in the area where it started.
 3. The fire department is being called.
 4. You can fight fire with your back to an exit.

WARNING - TO REDUCE THE RISK OF INJURY TO PERSONS, IN THE EVENT OF A RANGE TOP GREASE FIRE, OBSERVE THE FOLLOWING:

When properly used and cared for your new Thermador Cooktop has been designed to be a safe, reliable appliance. When using kitchen appliances, basic safety precautions must be followed, including the following:

Read this Care and Use Manual carefully before using your new cooktop to reduce the risk of fire, electric shock, or injury to persons.

Begin by insuring proper installation and servicing. Follow the installation instructions provided with this product. Have the cooktop installed and grounded by a qualified technician. Have the installer show you where the gas shut-off valve is located so that you know how and where to turn off the gas to the cooktop.

If you smell gas, your installer has not done a proper job of checking for leaks. Connections can loosen in transit. If the connections are not perfectly tight, you can have a small leak and therefore a faint gas smell. Finding a gas leak is not a "do-it-yourself" procedure. Some leaks can only be found with the burner control in the ON position.

For proper lighting and performance of the burners, **keep the igniters clean.** It is necessary to clean these when there is a boil over, or when the burner does not light even though the electronic igniters click. See page 22.

The cooktop is factory

assembled for natural gas. It should be correctly adjusted by a qualified service person or installer for the type of gas with which it is used. (See page 2 for propane gas.)

Do not repair or replace any part of the appliance unless specifically recommended in this manual. All other servicing should be referred to a qualified technician.

Children should not be left alone or unattended in an area where appliances are in use. They should never be allowed to sit or stand on any part of the appliance.

CAUTION: Do not store items of interest to children above the cooktop or at the back. If children should climb onto the appliance to reach these items, they could be seriously injured.

Do not store flammable materials on or near the cooktop.

Do not use water on grease fires. Turn appliance off and smother fire with baking soda or use a dry chemical or foam-type extinguisher.

Never let clothing, potholders, or other flammable materials come in contact with the burners or burner grates, until they are cool to the touch.

Use only dry potholders; moist or damp potholders on hot surfaces may cause burns from steam. Do not use a towel or other bulky cloth in place of potholders. Do not let potholders touch hot burners or burner grates.

For personal safety, wear proper apparel. Loose fitting garments or hanging sleeves should never be worn while cooking.

Do not use aluminum foil to line any part of the cooktop. Improper use of a foil liner could result in a shock, fire hazard or it could obstruct the flow of combustion and ventilation air. Foil is an excellent heat insulator and heat will be trapped beneath it. This will upset the cooking performance and can damage the cooktop finish.

Warning: The appliance is for cooking. Based on safety considerations never use the cooktop to warm or heat a room. Also, such use can be damaging to the cooktop.

Do not heat unopened food containers; a buildup of pressure may cause the container to burst.

When using the cooktop: **DO NOT TOUCH THE BURNER GRATES or THE IMMEDIATE SURROUNDING AREA.** Areas adjacent to the burners may become hot enough to cause burns.

Never leave the burners unattended when using high flame settings. Boil overs cause smoking, and greasy spillovers that may ignite. More importantly, if the flame is smothered, unburned gas will be coming into the room. See "What to do if you smell Gas", Page 1.

Always use utensils that have flat bottoms. Hold the handle of the pan to prevent movement of the utensil when stirring or turning food.

To minimize burns, ignition of flammable materials and unintentional spillovers, **position handles of utensils inward** so they do not extend over adjacent work areas, burners, or the edge of the cooktop.

During cooking, **set the burner control so that the flame heats only the bottom of the pan** and does not extend beyond the edge of the pan.

Take care that drafts like those from fans or forced air vents **do not blow flammable material toward the flames** or push the flames so that they extend beyond the edges of a pot.

Only certain types of glass, heat-proof glass-ceramic, ceramic, earthenware, or other glazed utensils are suitable for cooktop use. This type of utensil may break with sudden temperature changes. Use only on low or medium flame settings according to the manufacturer's directions.

If the cooktop is near a window, **be certain the curtains do not blow over or near the burners;** they could catch on fire.

In the event a burner goes out and **gas escapes,** open a window or a door. Do not attempt to use the cooktop until the gas has had time to dissipate. **Wait at least 5 minutes before using the cooktop.**

PRECAUTIONS

Clean the cooktop with caution. Avoid steam burns; do not use a wet sponge or cloth to clean the cooktop while it is hot. Some cleaners produce noxious fumes if applied to a hot surface.

Clean the hood above or the ventilator at the back of your cooktop frequently so grease from cooking vapors does not accumulate on the filters or on the intake.

Turn the ventilator OFF in case of fire or when intentionally "flaming" liquor or other spirits on the cooktop. The blower, if in operation, could unsafely spread the flames.

The **electric element** is removeable, however it should **never be immersed in water**. Turn the element on and it will clean itself. **DONOT** leave it unattended when burning off food soil.

California Proposition 65 - **Warning:** Burning gas cooking fuel generates some by-products which are on the list of substances which are known by the State of California to cause cancer or reproductive harm. California law requires businesses to warn customers of potential exposure to such substances. To minimize exposure to these substances, always operate this unit according to the instructions contained in this booklet and provide good ventilation.

SAVE THESE INSTRUCTIONS

Section Two: Before You Begin

BEFORE USING YOUR COOKTOP FOR THE FIRST TIME

Remove all packaging materials and labels before using your cooktop.

1. Check that you have these items.

**GG30/36, GGSCV30/36
GGN30/36, GGNCV30/36**

- /
- ▲ 4 Burner Grates
- ▲ 4 Burner Caps
- ▲ 2 Ventilator Filters*
- ▲ Care and Use Manual (warranty found on Page 29).

**GG365, GGSCV365
GGN365, GGNCV365**

- ▲ 5 Burner Grates
- ▲ 5 Burner Caps
- ▲ 2 Ventilator Filters*
- ▲ Care and Use Manual (warranty found on Page 29).

SGS30, SGS36G, SGSCV36G

- ▲ 4 Burner Grates
- ▲ 4 Burner Caps
- ▲ Griddle'n Grill™ (drip pan, cover, griddle, grill, removable element)**
- ▲ 2 Ventilator Filters*
- ▲ Care and Use Manual (warranty found on Page 29).

SGN30, SGN36G, SGNCV36G

- ▲ 4 Burner Grates
- ▲ 4 Burner Caps
- ▲ Griddle (drip pan, cover, griddle, removable element)**
- ▲ 2 Ventilator Filters*
- ▲ Care and Use Manual (warranty found on Page 29).

2. Record the Model and Serial Number as described on page 28.

These may be used for any future contacts with your servicer or the factory.

* Cook'n'Vent models only.

** Griddle'n Grill or griddle models only.

MODEL AND PARTS IDENTIFICATION

Models GGS30* & GGN30

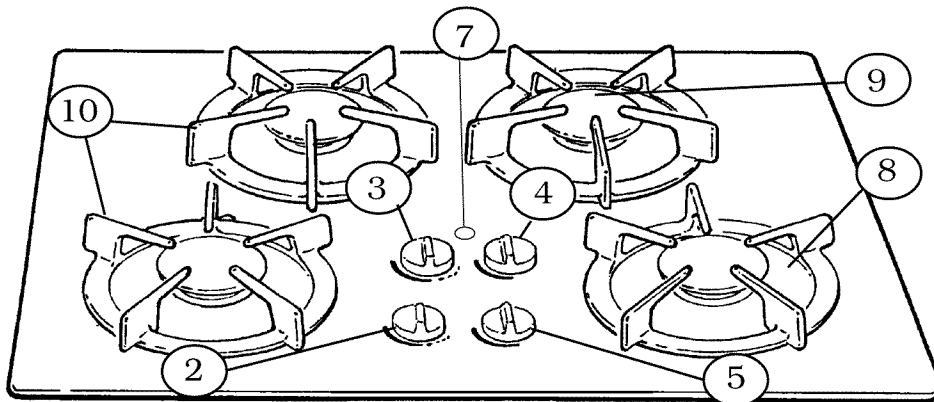

Model GGSCV30* & GGNCV30

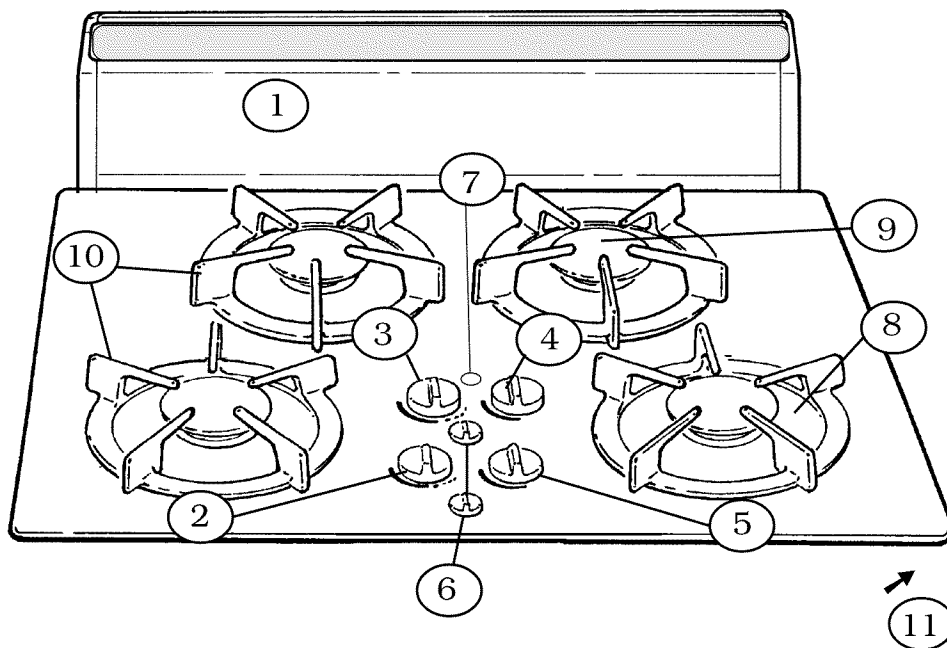

- | | |
|---|--|
| <p>1. Cook'nVent™</p> <p>2. <u>Models GGS</u> - ExtraLow™ 300 to 9,100 BTU/HR Burner & Control Knob
<u>Models GGN</u> - 950 to 6,500 BTU/HR Burner & Control Knob</p> <p>3. <u>Models GGS</u> - ExtraLow™ 365 to 11,000 BTU/HR Burner & Control Knob
<u>GGN Models</u> - 1650 to 11,000 BTU/HR Burner & Control Knob</p> <p>4. <u>Models GGS</u> - 1300 to 9100 BTU/HR Burner & Control Knob
<u>Models GGN</u> - 950 to 6500 BTU/HR Burner & Control Knob</p> | <p>5. 1650 to 11,000 BTU/HR Burner & Control Knob</p> <p>6. Ventilator Controls</p> <p>7. <u>Models GGS</u> - "ON" Light</p> <p>8. Burner Plate</p> <p>9. Burner Cap</p> <p>10. Grates</p> <p>11. Rating Plate, Right Side, underneath Cooktop</p> |
|---|--|

* GGS models illustrated

MODEL AND PARTS IDENTIFICATION

Model GGSCV36* & GGNCV36

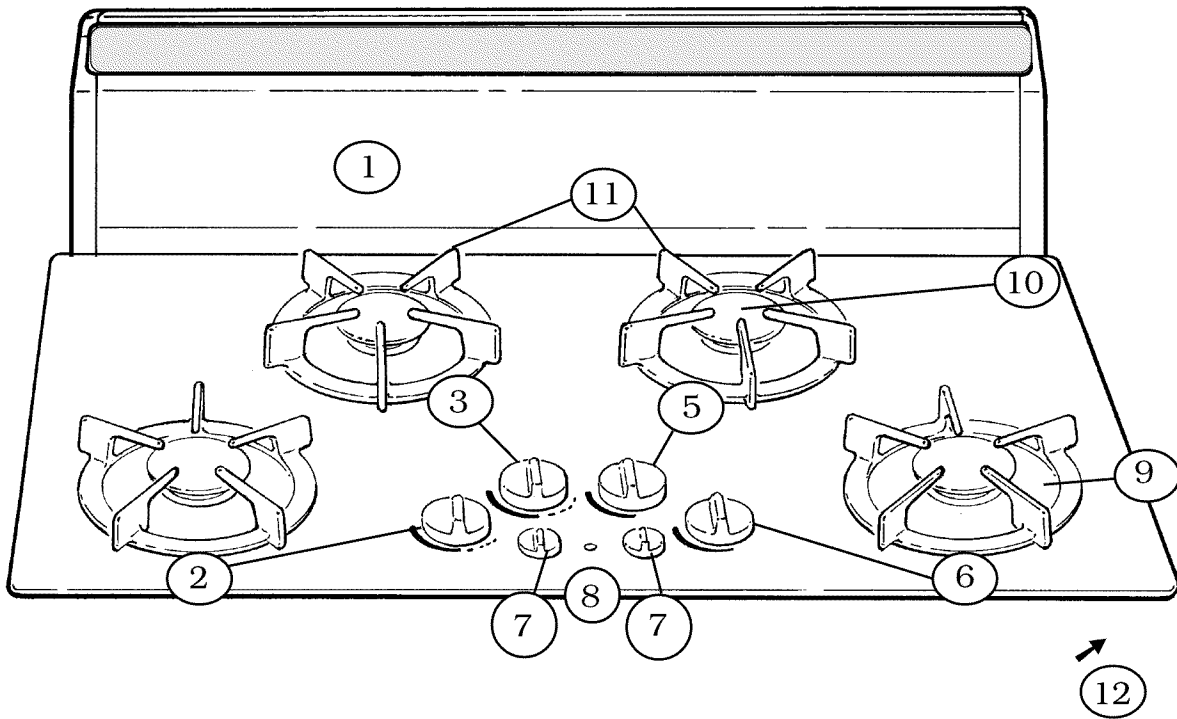

Model GGSCV365* & GGNCV365

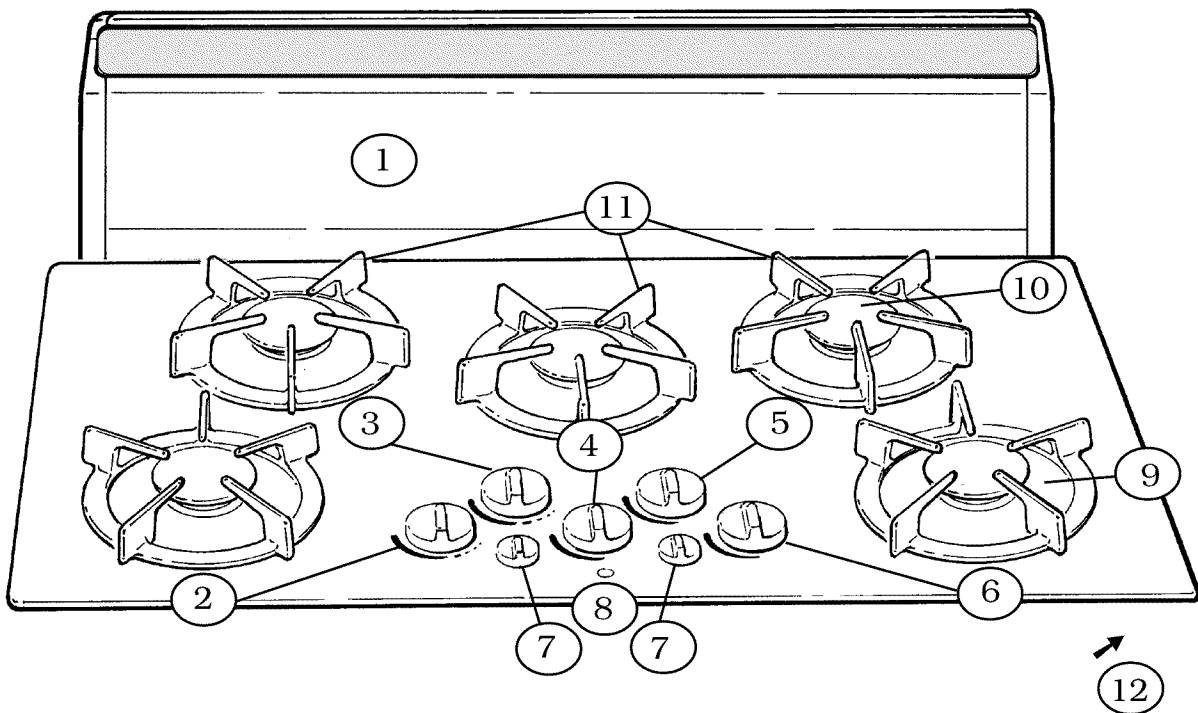

*GGSCV models illustrated

Models GGS36* & GGN36

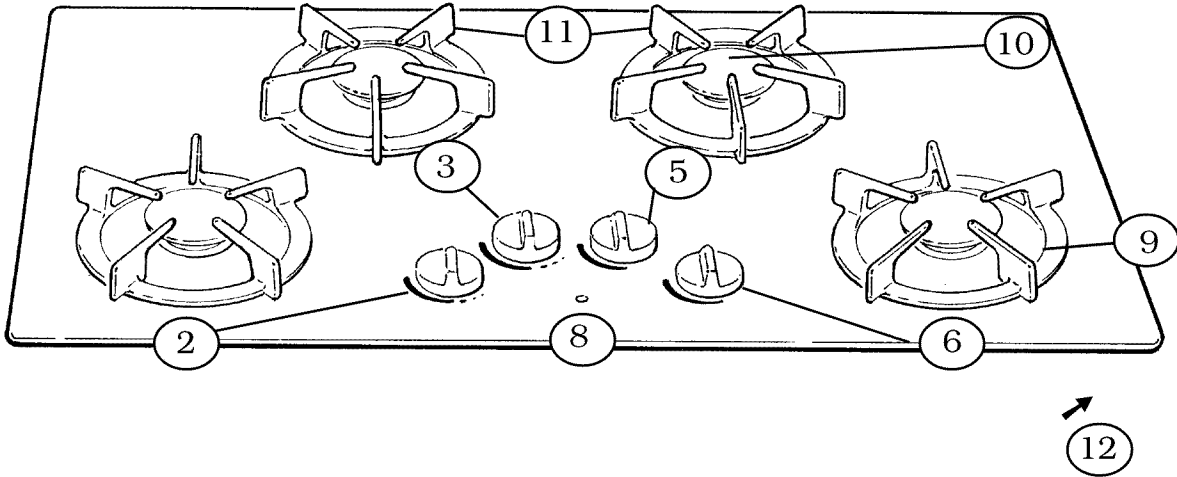

Models GGS365* & GGN365

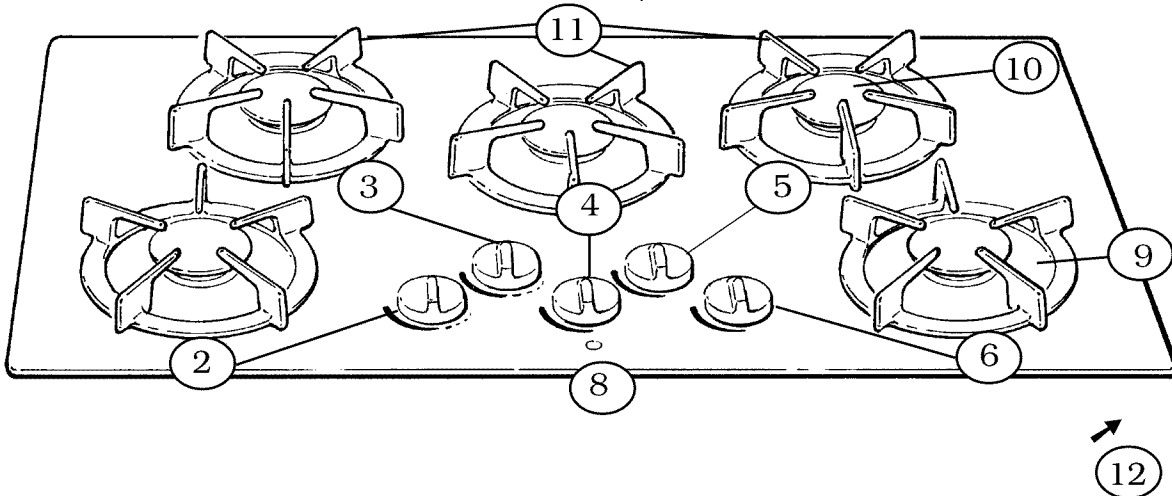

- | | |
|--|---|
| <p>1. Cook'nVent</p> <p>2. <u>Models GGS - ExtraLow™ 300 to 9100 BTU/HR Burner & Control Knob</u>
<u>Models GGN - 950 to 6,500 BTU/HR Burner & Control Knob</u></p> <p>3. <u>Models GGS - ExtraLow™ 365 to 11,000 BTU/HR Burner & Control Knob</u>
<u>Models GGN - 1650 to 11,000 BTU/HR Burner & Control Knob</u></p> <p>4. <u>Models GGSCV365, GGS365 & GGN365 - 950 to 6,500 BTU/HR Burner & Control Knob</u></p> | <p>5. <u>Models GGS - 1300 to 9,100 BTU/HR Burner & Control Knob</u>
<u>Models GGN 950 to 6,500 BTU/HR Burner & Control Knob</u></p> <p>6. 1650 to 11,000 BTU/HR Burner & Control Knob</p> <p>7. Ventilator Controls</p> <p>8. <u>Models GGS - "ON" Light</u></p> <p>9. Burner Plate</p> <p>10. Burner Cap</p> <p>11. Grate</p> <p>12. Rating Plate, Right Side, Underneath Cooktop</p> |
|--|---|

*GGS models illustrated

MODEL AND PARTS IDENTIFICATION

Models SGS30* & SGN30

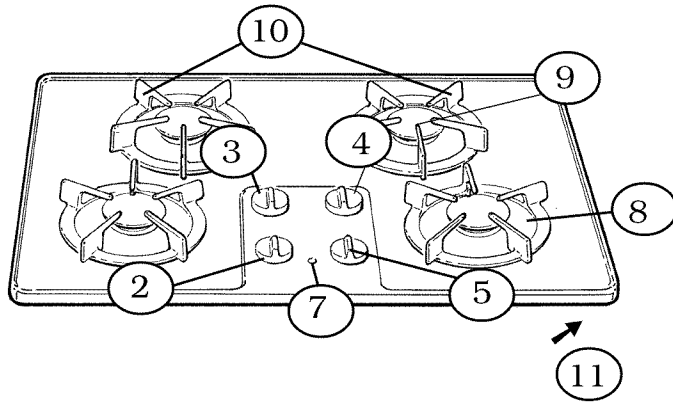

Models SGS36G* & SGN36G

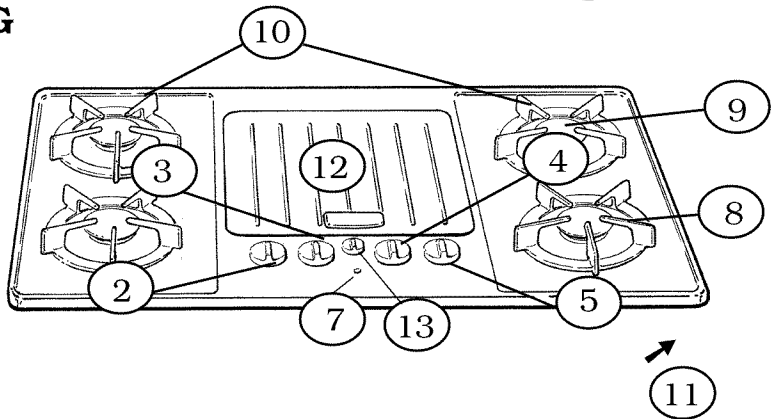

Model SGSCV36G* & SGNCV36G

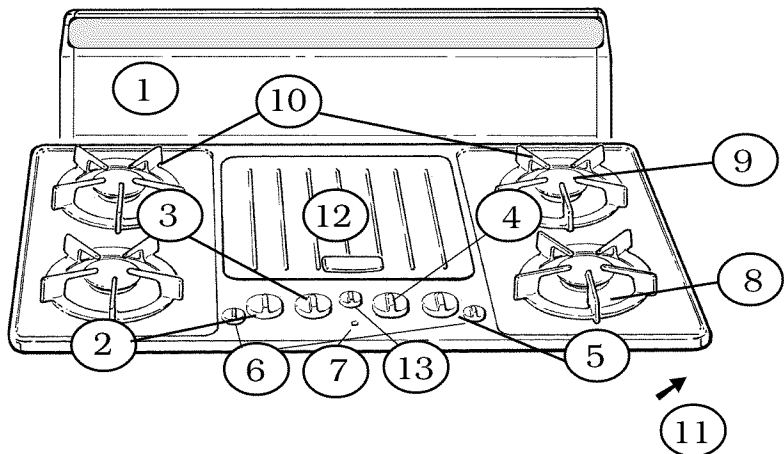

- | | | |
|--|--|---|
| 1. Cook'n'Vent | 5. 1650 to 11,000 BTU/HR Burner & Control Knob | 10. Grates |
| 2. <u>Models SGS</u> - ExtraLow™ 300 to 9100 BTU/HR Burner & Control Knob
<u>Models SGN</u> - 950 to 6,500 BTU/HR Burner & Control Knob | 6. Ventilator Controls | 11. Rating Plate, Right Side, Underneath Cooktop |
| 3. <u>Models SGS</u> - ExtraLow™ 365 to 11,000 BTU/HR Burner & Control Knob
<u>Models SGN</u> - 1650 to 11,000 BTU/HR Burner & Control Knob | 7. "ON" Light except SGN30 | 12. <u>Models SGS</u> - Griddle'n Grill |
| 4. <u>Models SGS</u> - 1300 to 9,100 BTU/HR | 8. Burner Plate | 13. <u>Models SGSG</u> - Griddle'n Grill Control Knob
<u>Models SGNG</u> - Griddle only Control Knob |
| | 9. Burner Cap | |

*SGS models illustrated

CONTROL KNOB — ALL STANDARD BURNERS

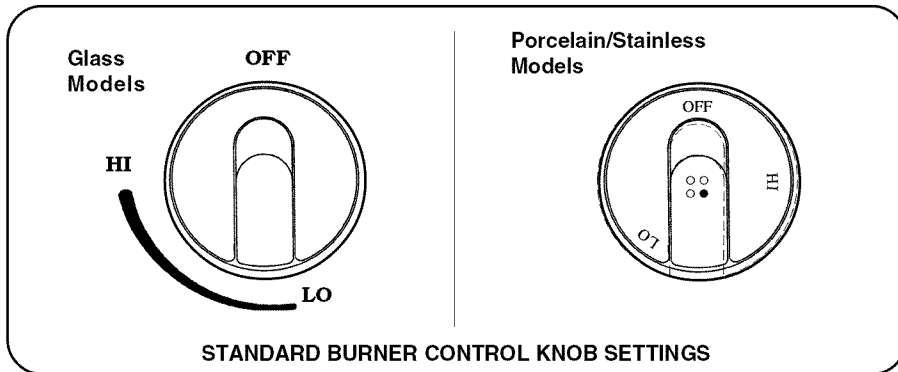

All the controls are push in to turn and have an infinite number of heat settings, with no fixed positions. Select the appropriate control knob and turn it counterclockwise to the **HI** position (detent) until the burner lights. Adjust the flame size. Turn off by turning the control clockwise to **OFF**.

CONTROL KNOB — Thermador® ExtraLow™ BURNERS

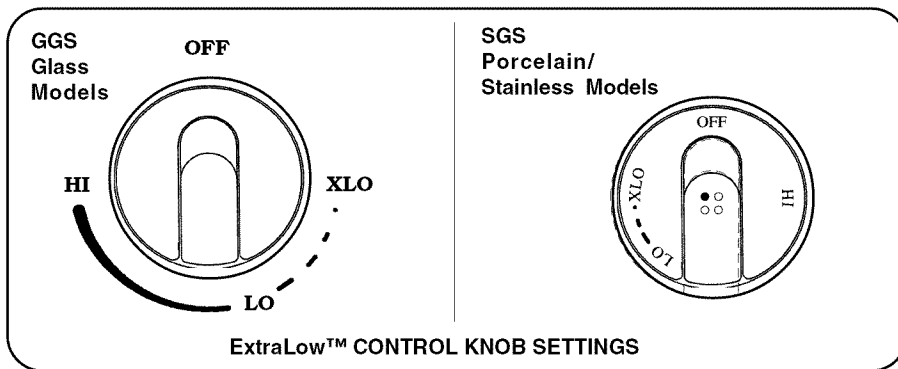

Both ExtraLow controls are push in to turn and have an infinite number of heat settings, with no fixed positions. The ExtraLow settings are between **XLO** and just after **LO**, at the detent, shown by the broken line.

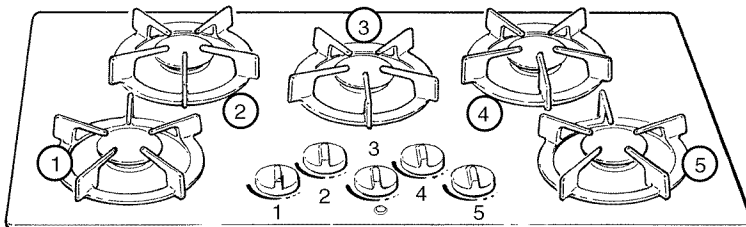

- | | |
|---|----------------------|
| 1. ExtraLow™ 300 to 9,100 BTU/HR Burner and Control Knob | GGSCV365 and GGS365) |
| 2. ExtraLow™ 365 to 11,000 BTU/HR Burner and Control Knob | |
| 3. 950 to 6,500 BTU/HR Burner and Control Knob (Models | Model GGS365 |
| 4. 1300 to 9,100 BTU/HR Burner and Control Knob | |
| 5. 1650 to 11,000 BTU/HR Burner and Control Knob | |

THERMADOR® EXTRALOW™ BURNERS (Models GGS/SGS)

The left front 9,100 BTU/HR burner and left rear 11,000 BTU/HR burner are designed to provide flame settings which enable you to simmer, poach, melt and hold cooked food at a serving temperature, without scorching or burning. This is accomplished by cycling the flame OFF and ON for varying lengths of time.

HOW THEY WORK

- The BTU/HR usage on the 9,100 BTU/HR burner ranges from **HI** (at 9,000) to **XLO** (at 300). The BTU/HR usage on the 11,000 BTU/HR burner ranges from **HI** (at 11,000) to **XLO** (at 365).
- There are an infinite number of settings between **HI** and **XLO**; the control knob can be set at any position.
- The burner flame will pulse ON and OFF when the setting is at any position between **LO** and **XLO**.
- The length of time the flame is ON and OFF varies.
- With a setting just below **LO**, the flame will be ON approximately 50 seconds and OFF 10 seconds of each minute.
- With a setting at the **XLO** position, the flame is ON approximately 10 seconds and OFF 50 seconds of each minute.

FOR THE BEST RESULTS

- Temperature control will be more accurate if a lid is used.
- Bring food to a rolling boil; stir well to be sure all the food is boiling; cover and reduce the heat to just below **LO**.
- Check periodically to see if the control knob should be turned to a lower setting.

COOKTOP OPERATION

- Adjust control knob to lower settings in small steps.
- If control is set too low to maintain simmer, bring the food back to a boil before setting a higher simmer setting.

WHAT TO EXPECT

- The type and quantity of the food will affect which setting to use.
- The size, type and material of your pan will affect which setting to use.
- When a large pan is used on a small burner, it may cause the simmer action to occur mainly in the center of the pan. When the food is stirred, the cooler food near the edges of the pan may result in an overall temperature too cool to simmer. If this happens, turn the burner up slightly.
- It is normal to stir food occasionally. This is especially important when simmering for several hours. For example: a homemade spaghetti sauce or beans.
- It is normal not to see simmer bubbles immediately after the food has been stirred.
- While the flame is **ON** there may be bubbling; there should be at least steam and a slight quivering of the liquid's surface.
- Simmer bubbles may not be seen when the flame has cycled **OFF**. (Models GGS & SGS)

SIGNAL LIGHT

The Signal Light (not on all models), or "ON" Light is located in the area of the Control Knobs. For location see "Section Three: Description", located on pages 7 to 9, to identify your model. This light turns on when any Control Knob is set.

SEALED BURNERS

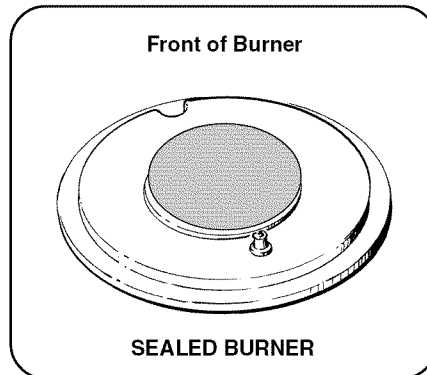

Your new cooktop features four or five sealed gas burners. On Models GGS30/36/365, GGSCV30/36/365, SGS30/30G and SGSCV36G you have two 9,100 BTU/HR burners, two 11,000 BTU/HR burners and on the GGSCV365 or GGS365 there is one 6,500 BTU/HR burner. On Models GGN30/36/365 and SGN30/36 there are two 11,000 BTU/HR and two or three 6,500 BTU/HR burners. Each burner is sealed to the cooktop for easier cleaning.

BURNER CAPS

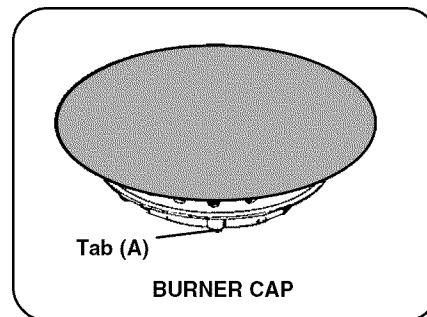

The Burner Cap top is porcelain enamel and has a tab (A) on the underside that fits into the notch (B) on the burner base (C).

BE SURE ALL BURNERS ARE IN THE OFF POSITION BEFORE WIPING OR CLEANING THE COOKTOP.

BURNER PLATES

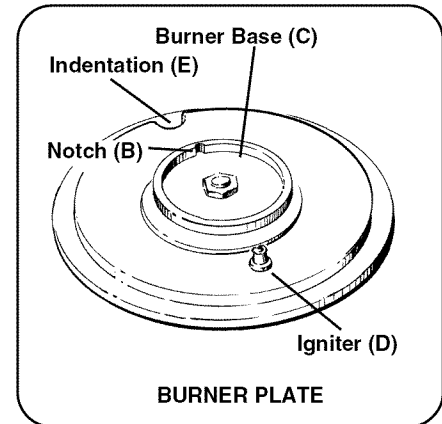

The Burner Plate has a notch (B) on the burner base, directly across from the igniter (D). This is where the tab (A) on the burner cap fits.

❑ **NOTE:** For proper burner operation be sure the tab (A) on the underside of the burner cap fits into the corresponding notch (B) on the burner plate.

GRATES

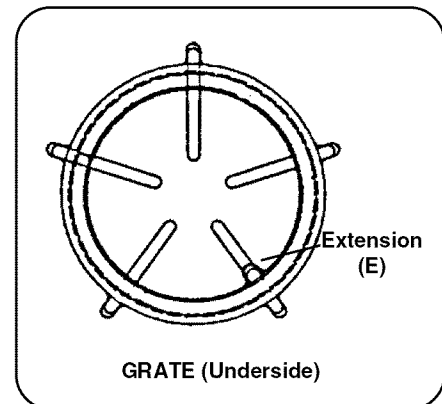

The five finger grates are porcelain enameled cast iron or steel and have an extension (E) that is longer (underneath) than the other four. This extension fits into the indentation (E) on the burner plate, which is directly across from the igniter (D).

ELECTRONIC IGNITION

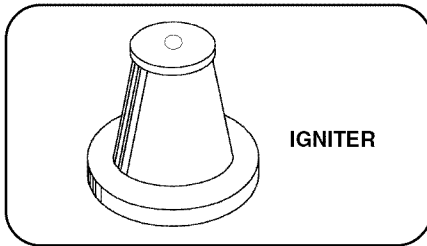

The cooktop uses electronic igniters to light the burners. Each burner has its own igniter that sparks when any burner is turned on. When the igniters are clicking (sparking), do not touch the burners. If a burner fails to ignite, see "Before Calling For Service," Page 28.

AUTOMATIC RE-IGNITION

If any burner flame blows out, the electronic igniter automatically sparks on all burners to relight the flame. Do not touch any burner while the igniters are clicking.

POWER FAILURE

In the event of a power failure, only the standard burners can be lit manually (the burners on the left on Models GGS & SGS cannot be lit). It is necessary to light each standard series burner individually.

If the cooktop is being used when the power failure occurs, turn all the burner control knobs to the OFF position. Then, the standard burners can be lit by holding a match at the ports and turning the control knob to the HI position. Wait until the flame is burning all the way around the burner cap before adjusting the flame to the desired height.

The two ExtraLow™ (Models GGS & SGS) burners, on the left side, cannot be used during a power failure. Be sure to turn them OFF if a power failure occurs, as they will not turn back on until both control knobs are turned OFF and then turned back on again. See "What To Do If You Smell Gas," Page 1.

FLAME HEIGHT

The correct height of the flame depends on the size and material of the utensil being used, the food being cooked and how much liquid is in the utensil. Here are some basic rules for selecting the flame height.

- s The flame should never extend beyond the bottom of the pan.
- s Utensils which conduct heat slowly (such as glass-ceramic) should be used with a low or medium flame unless you are cooking with a large amount of liquid.

BURNER EFFICIENCY and FLAME CHARACTERISTICS

The burner flame should be blue in color and stable with no yellow tips, excessive noise or fluttering. It should burn completely around the burner cap.

Foreign particles in the gas line may cause an orange flame during initial use. This should disappear with use.

If the flame does not burn evenly all the way around the burner cap, be sure the cap is resting correctly on the burner base.

If the ports are clogged, use a wire, a straightened paper clip or a needle to clear the ports. **Do not use a toothpick; it could break off inside the port.** If the condition persists, contact a service agency for adjustment.

The burner should light in 4 seconds or less. If a burner does not light, check to see that the cap is resting correctly on the burner base.



CAUTION

- ▲ **Foods packaged in aluminum foil** should *not* be placed directly on the burner grate for cooking; aluminum foil can melt.
- ▲ **Plastic, paper and cloth can melt or burn** when in contact with a hot burner grate. **Do not** let these items come in contact with the burner grate.
- ▲ **Do not allow pans to boil dry.** This can damage the pan, the burner grate, the cooktop glass and/or the burner plate.

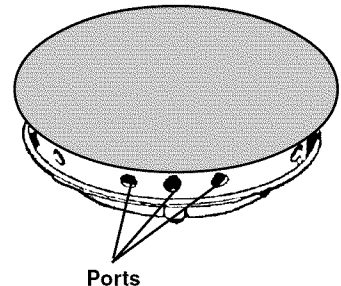

BURNER CAP

**FOR PROPER COMBUSTION
DO NOT USE THE COOKTOP
WITHOUT THE BURNER GRATES IN PLACE.**

PROPER COOKWARE

Top performance of your new cooktop is directly related to the use of proper pots and pans. An out-of-shape pan, without a lid, cannot possibly cook with the same speed and evenness as a pan with a heavy, flat bottom and a good fitting lid.

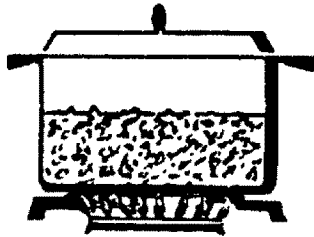

FLAT

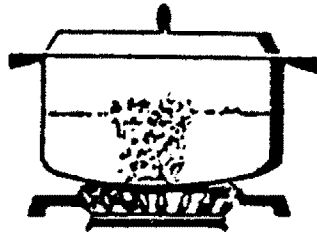

CONVEX (rounded)

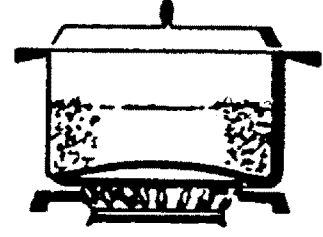

CONCAVE (hollow)

Cookware should have the following characteristics:

- s Good heat conductivity
- s Bottom diameter matching the size of the burner used
- s Good balance (pan bottom remains level on burner grate)
- s Smooth, heavy bottom that does not warp when hot; provides even heat
- s Proper fitting lid (when needed for specific cooking methods)

Do not use cookware with these characteristics:

- s Thin bottom
- s Concave bottom when heated
- s Convex bottom when heated
- s Poor balance (rocks back from weight of handle)

Many different types of pans can be used on this cooktop. To get the best cooking results, choose pans having the following qualities:

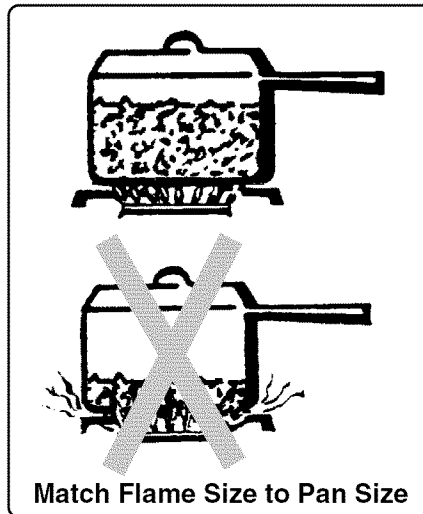

Match Flame Size to Pan Size

Match the flame to the bottom diameter of the pan. The flame should be the same size as the pan or slightly smaller. Small utensils and high flames result in energy loss and increase the potential for burns.

Use cookware that has good heat conductive qualities. Metal cookware that has copper or aluminum imbedded in a stainless steel disk bottom ("tri-ply construction") conducts heat better than other cookware.

Use medium to heavy gauge pans. These pans resist warping and last

longer than thin pans. The weight or thickness of the pan material (gauge) should be heavy enough to conduct heat evenly over the bottom of the pan for even browning and to avoid scorching.

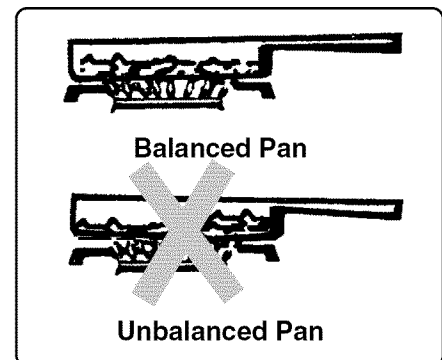

Balanced Pan

Unbalanced Pan

Use balanced pans that sit level on the burner grate without tilting from the weight of the handle.

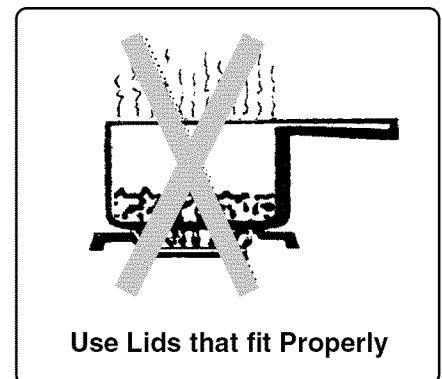

Use Lids that fit Properly

Use lids that fit the cookware properly to help shorten cooking time and to allow food to cook in a minimum amount of liquid on a lower heat setting.

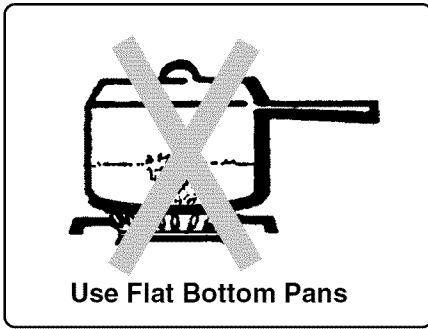

Use flat, heavy bottom pans that stay flat when heated for the best results. Avoid cookware that is warped, dented, ridged or thin. A warped or ridged pan receives the most heat at the points that contact the flame. This can result in burning or scorching of the food being prepared.

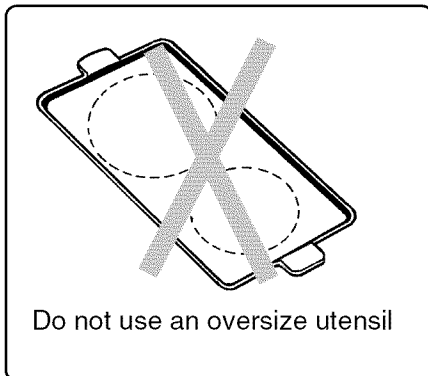

Specialty pans such as woks, lobster pots, pressure cookers, griddles, French fryers, etc. must meet similar design requirements as regular cookware: flat bottom, balanced, correct size, and proper cover (if applicable). **Do not use** utensils such as griddles, roasting pans, au gratin pans, fish poachers or other cooking utensils that must fit across two burners. Use of these products can result in damage to the glass cooktop and porcelain burner pans.

Heat and cool pans gradually to help maintain a flat bottom on your cookware. Do not place pans under cold water while still hot, unless recommended by the manufacturer, as they may warp.

Use only a flat bottom wok. A round bottom wok cannot be used with or without its support ring. The wok is unstable without the ring, and the ring may restrict air to the burners.

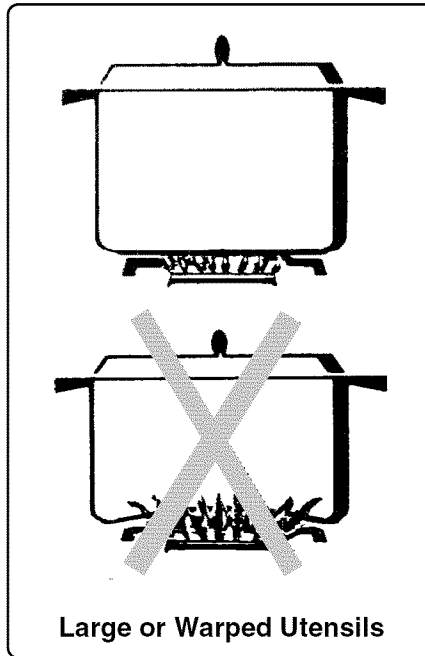

Do not use unusually large or warped utensils such as canners and stock pots on HI heat for an extended period of time. This may cause heat build up which can result in damage to the cooktop or the surrounding countertop. Once food has reached temperature, turn the control setting down to maintain the cooking heat.

Use canners and stock pots that have a flat bottom and extend no more than 2 inches beyond the burner grate.

Canning Tips:

An oversize canning pot can be used with success following these suggestions.

- ▲ Use a canner with a dark or dull finish to reduce heat reflecting back to the cooktop surface.
- ▲ Select a canner with a flat bottom, rather than one with a concave, convex or rippled bottom.
- ▲ Allow at least 3/8 inch of air space between the canner overhang and the cooktop surface.
- ▲ Use the lowest heat setting possible to maintain a boil or pressure.
- ▲ Be sure to cover all containers.
- ▲ Follow the canning instructions given in a standard cookbook or manufacturer's instructions provided with the canning jars.
- ▲ Use care to prevent burns from the large amount of steam generated by the canning process.

Look for canners fitting this description:

- ▲ **Water Bath Canner:** Standard 21 to 22-quart canners with an 11 to 12-inch diameter and a 9 to 11-inch depth.
- ▲ **Pressure Canner:** Canners vary in size from 8 to 22 quarts with 8 to 11-inch bottom diameters and a 6-1/2 to 12-inch depth.

SUGGESTED FLAME SETTINGS

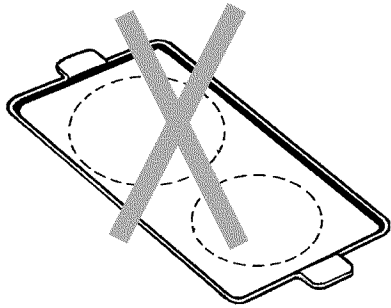

CAUTION

The tempered glass, porcelain and stainless steel used for your cooktop is heat resistant; however, **the use of improper utensils can possibly damage it.** Large or warped utensils or utensils that span two burners, trap heat against the cooktop. The trapped heat goes into the cooktop and overheats the glass which through repeated use of could eventually cause the glass to break; the porcelain top could craze (fine hairlike lines) or the steel top could show heat discoloration.

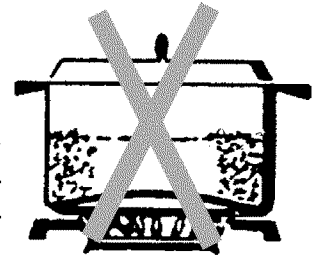

FLAME SETTING CHART GUIDELINES

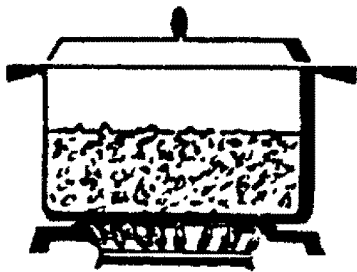

Use the right size flame for the cooking job

The Flame Setting Chart, on Pages 17 and 18, is to be used as a **guide**. Your pans and your manner of cooking may need a different setting than what is suggested. All flame settings were determined **using a variety of good quality, flat bottom pans with lids** (unless the method of cooking did not require a covered pan). The flame was matched to the size of the pan and the method of cooking: simmering, frying, braising, etc.

How to Use the Chart

The chart is divided into two sections: the food and the flame settings. The flame settings section shows an initial Start Cooking setting, a second Continue Cooking setting and /or an ExtraLow™ Heat setting. There may or may not be a change between the two Start Cooking and the Continue Cooking settings depending on the food prepared. The ExtraLow™ Heat (see pages 17-18) setting can be either a cooking, or a holding setting.

Models GGS/SGS shown

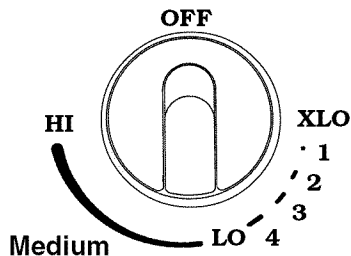

All the controls have an infinite number of heat settings, with no fixed positions between **HI**, **LO** or **XLO**. The word (**Medium**) and number designations are for reference only and are guides to the flame settings referenced in the following chart.

Guidelines:

1. The actual flame setting used to cook is selected from the range of flame settings given. Whether the higher or lower setting is selected depends on the quality of the pan, the amount of food, and the BTU/HR rating of the burner used.
2. Raise or lower the flame setting gradually. Allow time for the pan and food to adjust to the new setting. Changes are more satisfactory when the increased or decreased setting is only one or two markings on the control.

Before using this chart, read Page 16.

FOOD	START COOKING	CONTINUE COOKING	EXTRALOW™ HEAT SETTINGS
BEVERAGES Cocoa	Med. — heat milk, cover	LO — finish heating	XLO — keep warm, cover*
BREADS French Toast, Pancakes, Grilled Sandwiches	Med. — preheat skillet	Med. Lo to Med. — cook	
BUTTER			4 to 3 — allow 5 to 10 minutes to melt XLO — to hold
CEREALS Cornmeal, Grits, Oatmeal	HI — cover, bring water to a boil, add cereal	Med. Lo to Med. — finish cooking according to package directions	XLO — to hold, cover*
CHOCOLATE			2 to XLO — allow 10 to 15 minutes to melt XLO — to hold*
DESSERTS Candy	Med. Lo to Med. — cook following recipe	Med. Lo to Med.	
Pudding and Pie Filling Mix	Med. to Med. Hi — cook according to package directions	Med. to Med. HI	
Pudding	Med. Lo — Bring milk to a boil		3 to 2 — to cook
EGGS Cooked in Shell	HI — cover, bring water to a boil, add eggs, cover		XLO — cook 3 to 4 minutes for soft cooked; or 15 to 20 minutes for hard cooked
Fried, Scrambled	Med. to Med. Hi — melt butter, add eggs	LO to Med. Lo — finish cooking	XLO — to hold for a short period*
Poached	HI — bring water to the steaming point, add eggs		4 to 3 — finish cooking
MEAT, FISH, POULTRY Bacon, Sausage Patties	HI — until meat starts to sizzle	Med. Lo to Med. — finish cooking	
Braising: Swiss Steak, Pot Roast, Stew Meat	HI — melt fat, then brown on Med. Hi to HI , add liquid, cover,		3 to 2 — simmer until tender
Quick Frying: Breakfast Steaks	Med. Hi to HI — pre-heat skillet	Med. Hi to HI — fry quickly	
Frying: Chicken	HI — heat oil, then brown on Med.	LO — cover, finish cooking	
Deep Frying: Shrimp	HI — heat oil	Med. Hi to HI — to maintain temperature	
Pan Frying: Lamb Chops, Thin Steaks, Hamburgers, Link Sausage	HI — preheat skillet	Med. to Med. HI — brown meat	4 to 3 — to hold, covered 3 to 2 — to hold, uncovered
Poaching: Chicken, whole or pieces, Fish	HI — Cover, bring liquids to a boil		2 to 1 — to finish cooking

SUGGESTED FLAME SETTINGS

FOOD	START COOKING	CONTINUE COOKING	EXTRALOW™ HEAT SETTINGS
Simmering: Stewed Chicken, Corned Beef, Tongue, etc.	HI — cover, bring liquid to a boil		4 to 1 — simmer slowly
PASTAS Macaroni, Noodles, Spaghetti	HI — bring water to a boil, add pasta	Med. Hi to HI — to maintain a rolling boil	
POPCORN (use a heavy, flat bottom pan)	HI — cover, heat until kernels start to pop	Med. to Med. Hi — finish popping	
PRESSURE COOKER Meat	Med. Hi to HI — build up pressure	Med. Lo to Med. — maintain pressure	
Vegetables	HI — build up pressure	Med. Lo to Med. — maintain pressure	
RICE	HI — cover, bring water to a boil, add rice, cover		4 to 2 — cook according to package directions XLO — to hold, cover
SAUCES Tomato Base	Med. Hi to HI — cook meat/vegetables, follow recipe		2 to XLO — simmer (2 to 3 to thicken sauce, uncovered)*
White, Cream, Bernaise, Hollandaise	Med. Lo — melt fat, follow recipe	LO to Med. Lo — finish cooking	XLO — to hold, cover*
SOUPS, STOCK	HI — cover, bring liquid to a boil		3 to 2 — simmer XLO — to hold, cover*
VEGETABLES Fresh	HI — cover, bring water and vegetables to a boil	Med. Lo to Med. — cook 10 to 30 minutes, or until tender	XLO — to hold, cover
Frozen	HI — cover, bring water and vegetables to a boil	Med. Lo to Med. — cook according to package directions	
Deep Frying	HI — heat oil	Med. to Med. Hi — maintain frying temperature	
In Pouch	HI — cover, bring water and vegetables to a boil	LO to Med. Lo — cook according to package directions	
Saute	HI — heat oil or melt butter; add vegetables	Med. Lo to Med. — cook to desired doneness	
Stir Fry	HI — heat oil, add vegetables	Med. Hi to HI — finish cooking	

* We recommend that these foods be stirred occasionally.

**GRIDDLE'N GRILL™
(Model SGS)
GRIDDLE ONLY
(Model SGN)**

Your new Thermador Griddle'n Grill is a dual purpose electric appliance; a griddle and a grill. The griddle and the grill are used separately and must sit directly on the element for best cooking results. If the griddle or the grill does not sit on the element, it will not heat enough for foods to cook properly.

The Griddle'n Grill control has an infinite number of heat settings. There are no fixed positions between **HI** and **LO**.

To turn the element ON, push in on the control knob and turn it in either direction to the desired setting. See chart for the **griddle settings**.

When **ON**, this element cycles a percentage of **HI** power on and off to maintain the selected heat setting. On **HI** it does not cycle.

Griddle Finish

The aluminum griddle is very durable. It features a stick resistant surface that is an integral part of the metal; it is not a coating. This hardness is achieved through a special anodizing process which changes the surface metal structure. This surface will not rust, chip or peel. Because of its hardness, metal utensils may be used on it while cooking; however, cutting food with a knife or other sharp utensil should be avoided.

Stains, Shadows

Stains on the finish usually result from improper cleaning of the griddle. Minor stains, shadows or images are considered normal and do not effect the performance of the griddle. To maintain good performance and appearance, always follow the cleaning instructions, see Page 24.

BEFORE USING THE GRIDDLE or THE GRILL
Wash the griddle and the grill with hot sudsy water, then rinse thoroughly with clear hot water and dried. This should remove any manufacturing oils which may still be on the surface. A small amount of oil or butter applied after preheating helps to prevent sticking.

GRIDDLE/GRILL CONTROL KNOB and SIGNAL LIGHT

The signal light turns on when any heat setting is selected for the griddle or the grill

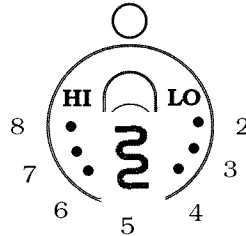

The number designations, on the illustration, are for reference only and are guides to the heat settings in this chart.

SUGGESTED HEAT SETTINGS CHART GRIDDLE		
FOOD	PREHEAT AT SETTING	COOK AT SETTING
BREADS French Toast, Pan cakes, Grilled Sandwiches	6 to 8 — to pre-heat, until water dances, about 8 minutes	7 to 8 — to cook
EGGS Fried, Scrambled	5 to 6 — to pre-heat, about 5 minutes, then melt butter, add eggs	4 to 6 — to cook
FISH Fish Sticks	HI — to preheat	7 to 8 — to cook
MEAT Bacon, Sausage Patties and Links	Put meat on cold griddle. HI — until meat starts to sizzle, about 3 to 4 minutes	6 to 8 — to cook.
Hamburgers, Ham Slice	HI — until meat starts to sizzle	8 to HI — to cook.
Vegetables Hash Brown Potatoes	HI — to brown	8 to HI — to cook.

GRIDDLE 'N GRILL OPERATION

USING THE GRIDDLE

1. Remove the Griddle'n Grill cover and be sure the element is plugged all the way into the receptacle. The two fixed supports on the bottom of the element must rest in the indentations in the bottom of the drip pan.
Place the griddle directly on top of the element.
3. **Preheat the griddle according to the chart. After preheating, lightly coat griddle surface with cooking oil or butter.** (A paper towel coated with oil works well to cover surface evenly.)
4. Place food on the griddle.
5. Adjust the heat setting for the food being cooked.

Griddle settings may need to be adjusted to a lower setting if the griddle is used for an extended period of time. When cooking foods such as bacon, the well may need to be drained of grease. When draining grease from the well, always drain away from the cooktop. It is a good idea to turn the gas flame off before moving the griddle so that any grease that spills will not flare up. Be sure to wipe any drips off the griddle before returning it to the cooktop.

If a residue develops while cooking try sprinkling the surface with salt. Rub the salt vigorously into the surface of the griddle with a paper towel. Wipe salt off and continue cooking.

It is important that the griddle be thoroughly cleaned after each use (see Cleaning Chart on Page 24).

THE GRILL (MODEL SGS)

DO NOT leave the grill unattended while grilling food.

1. Remove the Griddle'n Grill cover. Be sure the element is plugged all the way into the receptacle. The two fixed supports on the bottom of the element must rest in the indentations in the bottom of the drip pan.
2. Place the grill directly on top of the element.
3. Turn the control knob to HI and preheat the grill for 10 minutes.
4. Place the food on the grill and cook to desired doneness (most foods are cooked on HI heat setting for the entire cooking time).

NOTE: The hot grill will sear the food sealing in the juices. The longer the preheat, the faster the meat browns and the darker the grill marks.

GRILLING HINTS

Foods cooked for a long time or basted with a sugary marinade may need a lower heat setting near the end of the cooking time. The control knob may be set at any indicated setting or to any position in between.

If large amounts of meat are cooked at one time, occasionally there will be grease drippings that ignite and create minor puffs of flame for a brief second or two. This is a normal part of the cooking process. **Should flame become excessive, remove the food from the grill, turn the control to OFF. Use baking soda to extinguish the flames.**

NOTE: Quantities of accumulated grease may flame or flare up suddenly.

The doneness of meat, whether rare, medium, or well done, is affected to a large degree by the thickness of the cut. Expert chefs say it is impossible to have a rare doneness with a thin cut of meat.

The cooking time is affected by: the kind of meat, the size and shape of the cut, the temperature of the meat when cooking begins, and the degree of doneness desired.

Use a spatula instead of tongs or a fork to turn the meat, as a spatula will not puncture the meat and let the juices run out.

To get the juiciest meats: add seasoning or salt after the cooking is finished; turn the meat only once (juices are lost when the meat is turned several times); and turn the meat just after the juices begin to bubble to the surface.

Trim any excess fat from the meat before cooking. To prevent steaks or chops from curling during cooking, slit the fat around the edges at 1 to 1-1/2 - inch intervals.

To test for doneness, make a small slash in the center of the meat, not at the edge. This will prevent loss of juices.

VENTILATOR

Models GGSCV30/36/365 and SGSCV36G

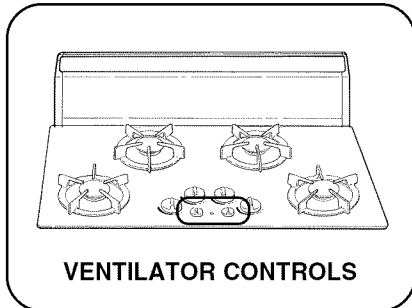

The ventilator is a 500 CFM exhaust system that can be hidden away when not in use. It has a variable speed blower. The amount of drawing power can be adjusted to the cooking job; **HI** exhaust for frying, **LO** for light simmering, or anywhere in between.

RAISING AND LOWERING THE VENTILATOR

The ventilator is raised and lowered by the control knob on the right. It must complete either the up or down cycle before it can be moved in the opposite direction. Be certain it is completely raised or lowered before trying to move it in the opposite direction.

To raise the vent, turn the Vent control knob to the right (UP) until the vent intake no longer moves upward. It automatically stops moving when the maximum height is reached or when the push-button is released.

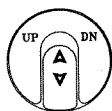

To lower the vent, turn the Vent control knob to the left (DN) until the vent intake is completely lowered. You will hear a **click** when it is completely lowered.

BLOWER SPEED CONTROL

The blower control allows you to select the drawing power needed for a particular food or cooking method.

The vent intake must be in the raised position for the blower to turn on. If it is not fully raised, the blower will not turn on.

To turn the blower ON, turn the control knob clockwise for power continue turning to the right for **LO**.

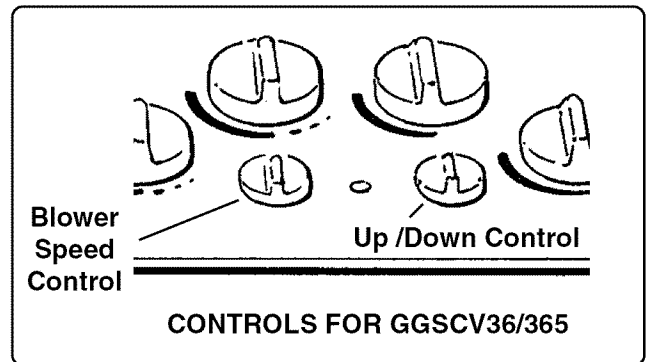
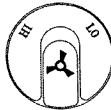

The control knob does not have to be turned OFF manually before the vent intake is lowered. It turns OFF automatically when the Vent DOWN control knob is turned towards the down position. If the control knob is not turned off, it will automatically be ON the next time the intake is fully raised.

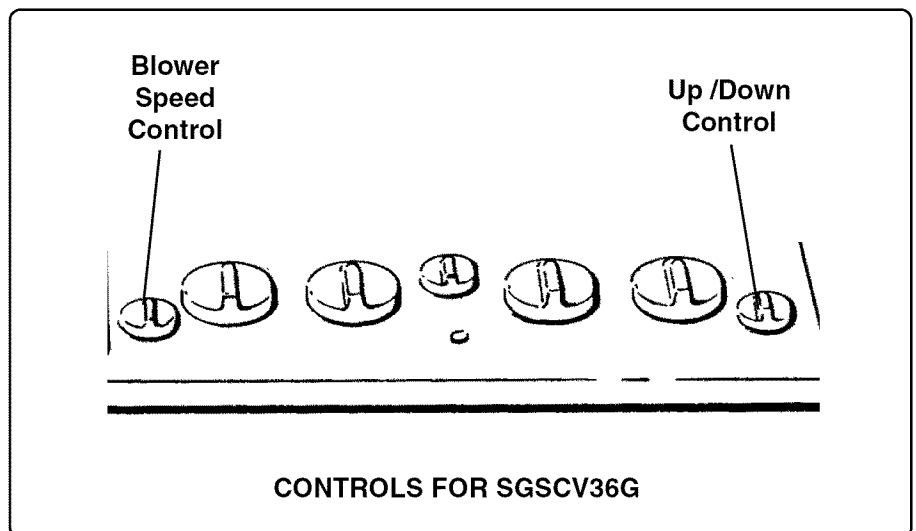
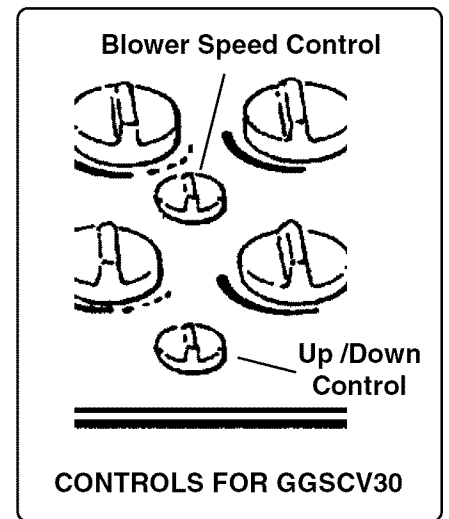

GENERAL CARE

Before cleaning be certain the burners are turned off and the grates are cool.

Any part of the cooktop can be cleaned with hot, sudsy water, then rinsed and dried with a clean, dry

BURNERS

The best cleaning method is prevention. Follow the recommended cleaning procedures and never let the burners get too dirty. If you have a spillover, let the burner cool, then clean immediately. If stains and cooking oils are allowed to burn into the burner, they become more difficult to remove. Refer to Cleaning Chart Page 24, for specific instructions.

DAILY CLEANING

Wipe the burner with a cloth dipped in warm sudsy water, then rinse with a cloth dipped in clean water. **Avoid getting excess water on the igniter.**

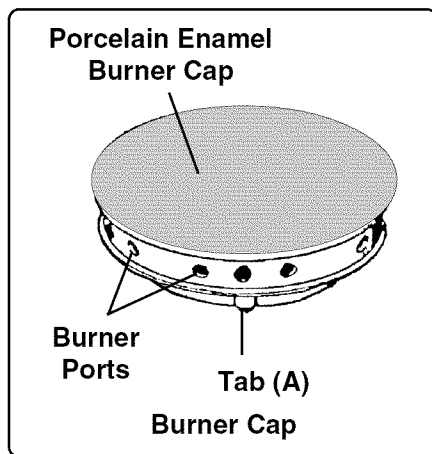

BURNER CAPS

Over a period of time the porcelain enamel burner cap may craze (get fine hair like lines) and discolor or become iridescent. This is normal.

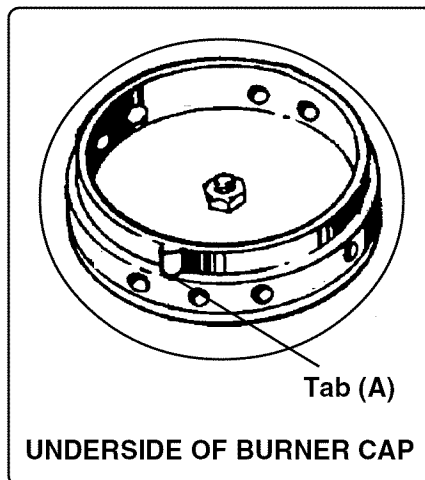

Be sure the burner cap fits correctly; the flame will not burn completely or correctly if cap is not positioned with Tab A in Notch B. **Keep the burner ports clear.** If the ports are clogged, use a wire, a straightened paper clip or a needle to clear the ports. **Do not use a toothpick; it could break off in the ports.**

IGNITERS

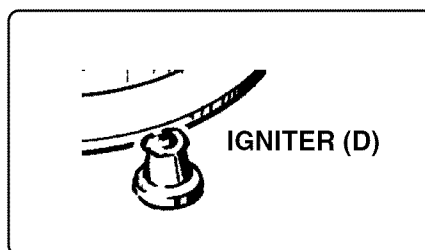

Each burner has an igniter (D) located on the burner plate. Keep the igniters clean. **Avoid getting excess water or liquid cleaner on the igniter.** If the igniter becomes too wet, it may continue to click but not ignite the burner. If the burner does not ignite in 4 seconds, turn off the control and wait until the igniter is dry.

BURNER PLATES

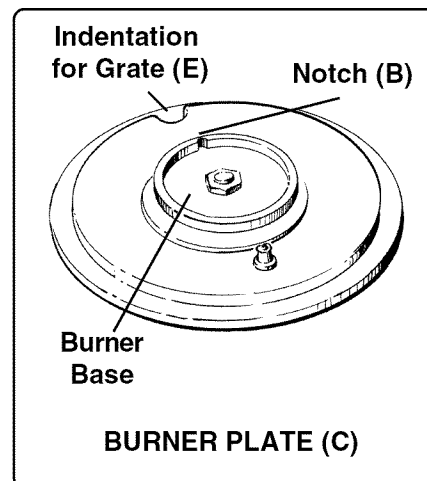

The porcelain enamel finish of the burner plate (C) is acid resistant, but not acid proof. Acid foods, such as citric juices, tomatoes, rhubarb, vinegar, alcohol or milk, should be wiped up immediately. If not removed, they may affect the porcelain finish. Use a paper towel or dry cloth on warm surfaces.

Other food soils can be wiped up with warm soapy water after the cooktop has cooled. Rinse and wipe dry.

BURNER GRATES

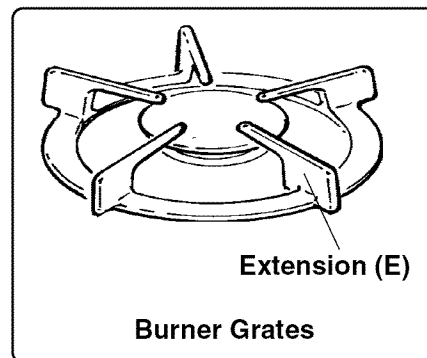

The grates are porcelain enameled cast iron or steel. They should be washed regularly and especially after spillovers. When replacing grates on the burner plates (C), the extension (E) is indexed into indentation (E) directly across from the igniter (D). See illustration Page 22, under Burner Plates.

GENERAL CARE

CONTROL KNOBS

To Remove: Turn the control knob to the **OFF** position and pull up.

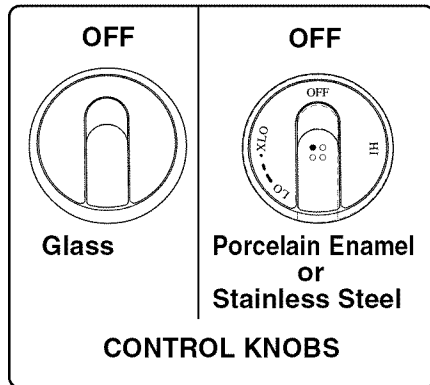

To Replace: Hold the knob with the **OFF** position up, so that the control knob stem opening on the underside of the knob aligns with stem. Push knob down. **Do not force the knob onto the stem.**

To clean, see Cleaning Chart, "PLASTIC," Page 25. **Do not soak knobs.**

COOKTOP FINISH

Glass

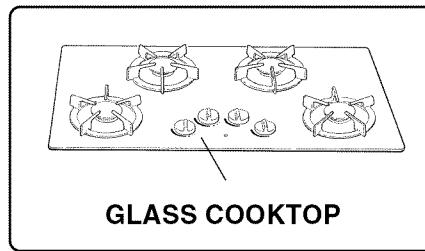

The glass on your cooktop has been fully tempered to withstand the sudden temperature changes it will experience during cooking. It is also highly impact resistant. Treat this glass with the normal care you would give any glass material. To clean, see Cleaning Chart, "GLASS," Page 24.

PORCELAIN ENAMEL

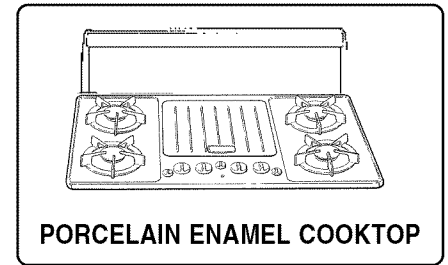

The porcelain enamel finish of the burner plate (C) and the cooktop are acid resistant, but not acid proof. Acid foods, such as citric juices, tomatoes, rhubarb, vinegar, alcohol or milk, should be wiped up immediately. If not removed, they may affect the porcelain finish. Use a paper towel or dry cloth on warm surfaces.

Other food soils can be wiped up with warm soapy water after the cooktop has cooled. Rinse and wipe dry. To clean, see Cleaning Chart, "PORCELAIN ENAMEL," Page 25. See "Stainless Steel" info on Page 25.

DO NOT CLEAN ANY REMOVABLE COOKTOP PARTS IN ANY SELF-CLEANING OVEN. DO NOT USE THE COOKTOP WITHOUT THE BURNER GRATES IN PLACE. BE SURE ALL BURNERS ARE IN THE OFF POSITION BEFORE WIPING OR CLEANING COOKTOP.

CLEANING CHART

When cleaning various parts of the cooktop:

1. Use the mildest cleaning procedure that will do the job efficiently and effectively. Some cleaners of the same type are harsher than others. Try a small area first.
2. Use only clean soft cloths, paper towels, and soap-filled pads for cleaning and scouring.
3. Any part of this appliance can be cleaned with hot sudsy water. Rinse thoroughly with fresh water after every cleaning operation.
4. Always wipe dry to avoid water marks.

The chart on the following page gives directions for cleaning the various parts of the cooktop.

BRAND NAMES

The use of brand names is intended only to indicate a type of cleaner. This does not constitute an endorsement. The omission of any brand name cleaner does not imply its adequacy or inadequacy. Many products are regional in distribution and can be found in the supermarkets.

It is imperative that all products be used in strict accordance with instructions on the package.

CLEANING CHART

DO NOT CLEAN ANY REMOVABLE PARTS OF THIS APPLIANCE IN ANY SELF-CLEANING OVEN. BE SURE ALL BURNERS ARE IN THE OFF POSITION BEFORE WIPING OR CLEANING COOKTOP

MATERIAL/PART	CLEANING PRODUCTS/DIRECTION
	<p>Any part of this appliance can be washed with hot sudsy water, except element.</p> <ul style="list-style-type: none"> Wash thoroughly, rinse and dry.
<p>ALUMINUM Filters (Models GGSCV30/36/365 & SGSCV36G)</p>	<p>Hot sudsy water or wash in dishwasher</p> <ul style="list-style-type: none"> Agitate in hot soapy water, rinse thoroughly and allow to dry, or put through a dishwasher cycle.
<p>Burner Base</p>	<p>Fiber or steel wool soap pad: PanHandl'rs®, S.O.S®</p> <ul style="list-style-type: none"> Rub in circular motion, as small scratch lines will be noticeable. Rinse and dry. Aluminum cleaners may dull the surface. <p>Revereware® Metal Polish will help to retain the luster.</p> <ul style="list-style-type: none"> Follow the directions on the package.
<p>Griddle • Normal</p>	<p>Hot sudsy water, sponge or nylon pad.</p> <ul style="list-style-type: none"> Wash thoroughly with hot soapy water, rinse and dry. Always wash and rinse the griddle thoroughly after each use. Some discoloration may occur with use, but will not affect performance. When not thoroughly cleaned you will feel a film of food residue; this will cause food to stick.
<p>• Hard to Remove Soil</p>	<p>Scouring Pad: Medium grade, Scotch Brite®</p> <ul style="list-style-type: none"> Wash thoroughly with this type scrubber. If necessary sprinkle 1 - 2 Tablespoons baking soda or mild cleanser on wet griddle, rub with a paper towel or nylon pad to remove food soil. Wash with hot soapy water, rinse and dry. <div style="border: 1px solid black; padding: 5px; margin-top: 10px;"> <p>Never wash the griddle in the dishwasher. The caustic detergent used in the dishwasher will discolor the surface. Never use oven cleaners or other harsh cleaning agents, this could destroy the surface.</p> </div>
<p>Grill • Normal</p>	<p>Hot sudsy water</p> <ul style="list-style-type: none"> Always wash and rinse the grill thoroughly after each use. It can be washed in the dishwasher if burned on residue is removed first.
<p>• Hard to Remove Soil</p>	<ul style="list-style-type: none"> Soak grill in hot, sudsy water to which a household cleaner like ammonia has been added.
<p>CERAMIC Igniters</p>	<p>Avoid excess water on the igniters. If an igniter becomes too wet, it may continue to click, but not ignite the burner. If the burner does not ignite in 4 seconds, turn off the control and wait until the igniter is dry.</p> <p>Cotton Swab or toothpick</p> <ul style="list-style-type: none"> Wipe with dampened swab. If necessary, scrape with a toothpick. Be careful not to damage the igniter.
<p>GLASS Cooktop Surface</p>	<p>Glass or window Cleaners: Windex®, Glass Plus®, ammonia and water, or vinegar and water solution</p> <ul style="list-style-type: none"> Spray on and wipe dry. Use a clean dry cloth, paper towel or newspaper to polish.
<p>• Water Spots</p>	<p>Undiluted vinegar.</p> <ul style="list-style-type: none"> Rub on with a dampened cloth or sponge, rinse, and dry. <p>Soft Scrub®, mild abrasive liquid cleanser.</p> <ul style="list-style-type: none"> Use sparingly and rub gently with a damp sponge or soft cloth. If rubbing is hard or if an abrasive pad is used, scratching may occur. Rinse and dry.

CLEANING CHART

MATERIAL/PART	CLEANING PRODUCTS/DIRECTION
<p>ELEMENT Griddle Element</p>	<p>DO NOT RINSE OR IMMERSE ANY ELEMENT IN WATER. The element will clean itself when turned onto the HI setting. The drip pan must always be in place when cooking on the Griddle'n Grill. Do not leave the cooktop unattended when cleaning the element.</p>
<p>PLASTIC Control Knobs</p>	<p>Hot sudsy water.</p> <ul style="list-style-type: none"> • Pull knobs straight up from cooktop. Wash, do not soak. Rinse, then dry. When replacing knobs match the stem opening on the back of the knob with the stem. Do not force knobs onto stems. • Some knobs may discolor temporarily from food stains; this color will lighten and disappear in a few days. Do not wash knobs in the dishwasher.
<p>PORCELAIN ENAMEL Burner Caps, Burner Plates, Grates, Cooktop Surface</p>	<p>The Porcelain Enamel used on the cooktop is acid resistant, but not acid proof. If foods such as citric juices, tomatoes, vinegar, milk, etc. are spilled, wipe up immediately or it may effect the finish.</p> <p>Hot sudsy water.</p> <ul style="list-style-type: none"> • Wash, rinse thoroughly with hot water, and dry. • For burned on food soil, soak the grates in hot soapy water. <p>Mild Cleansers: Bon-ami, Soft Scrub.</p> <ul style="list-style-type: none"> • Apply to a damp sponge or cloth. Rub lightly. Rinse thoroughly and dry. <p>Fiber or steel wool soap pads: PanHandl'rs, S.O.S, Brillo.</p> <ul style="list-style-type: none"> • For stubborn stains, the occasional use of abrasive cleansers is okay, but, if used vigorously or too often, they can eventually harm the enamel. Dampen pad, rub lightly, rinse thoroughly, and dry.
<p>STAINLESS STEEL Cooktop, Ventilator</p> <ul style="list-style-type: none"> • Grease, food spatters, fingerprints 	<p>The quality of this material resists most stains and pitting, providing the surface is kept clean and protected.</p> <p>Nonabrasive Cleaners: Hot soapy water ammonia, or detergent and water.</p> <ul style="list-style-type: none"> • Apply with sponge or cloth, then wipe clean using a clean cloth and thoroughly dry the surface. Apply stainless steel cleaner-polish such as; Stainless Steel Magic® to protect the finish and leave a soft lustre. • Wipe off the stainless steel front and back panels of the vent after each use. Rinse, then polish with a dry cloth, rubbing in the direction of the grain. • If grease has accumulated on the inside of the back panel of the vent, use a nylon or other soft-touch spatula to lift the accumulated grease from the back panel. To reach the back panel, remove the front panel and filters. See page 26. <p>Mild Cleaners: Stainless Steel Magic®, general kitchen cleaners such as Fantastik®, Formula 409®.</p> <p>Vinegar: to remove hard water spots.</p> <ul style="list-style-type: none"> • Apply with sponge or cloth, then wipe clean using a clean cloth and thoroughly dry the surface. <p>Mild abrasive Cleaners: RevereWare Instant Stainless Steel Cleaner®, Kleen King® Stainless Steel Cleaner.</p> <ul style="list-style-type: none"> • Apply with a damp sponge or cloth. <i>Rub lightly in direction of the polish lines.</i> Wipe clean using damp cloth or sponge and dry surface. <div style="border: 1px solid black; padding: 5px; margin-top: 10px;"> <p>Remember, chlorine or chlorine compounds (check the labels) are corrosive even to stainless steel. It is very important to rinse thoroughly and dry if a cleaning agent with chlorine is used.</p> </div>
<ul style="list-style-type: none"> • Heat Tint or discoloration 	<p>Abrasive Cleaners: RevereWare Instant Stainless Steel Cleaner, Zud®.</p> <ul style="list-style-type: none"> • Apply with a damp cloth or sponge. Satisfactory for uses on all finishes if rubbing is light. <i>Use in direction of polish lines.</i>

COOK'N'VENT® VENTILATOR CARE*

See "SAFETY PRACTICES," on Page 4.

The efficiency of the exhaust system depends on the cleanliness of the ventilator, especially the filters. The frequency of cleaning depends on the amount and type of cooking performed.

FILTERS and INTAKE PANEL

Filters become soiled in a short period of time and should be cleaned regularly. The filters may be cleaned by agitating them in a hot detergent solution or by washing in the dishwasher.

Do not use the ventilating system without the filters in place.

TO REMOVE THE FILTERS AND CLEAN THE PANEL

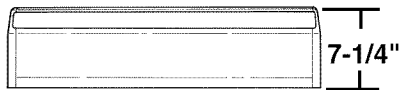

Raise the Vent to its Maximum Height

1. Raise the ventilator intake to its maximum height. If the blower is on, turn it off.

Ventilator Cap

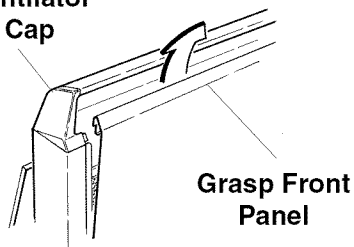

Grasp Front Panel

2. Grasp the front panel at the top towards the sides and pull up and forward: remove and set aside.
3. Remove the ventilator cap by grasping both ends of the cap and lifting up.
4. Lift out the filters and clean.

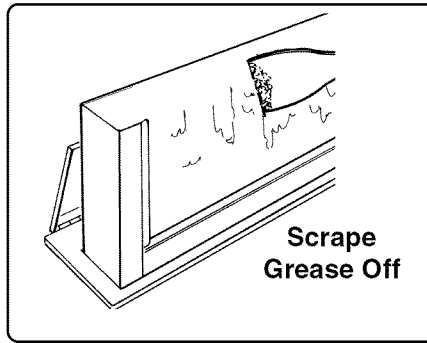

Scrape Grease Off

5. Using a nylon or other soft-touch spatula, lift the accumulated grease from the back panel - behind the filters. Clean front and back panels using a mild grease solvent (See Cleaning Chart for Stainless Steel).

TIP: Wipe the intake off after each use.

TO REPLACE THE FILTERS AND THE FRONT PANEL

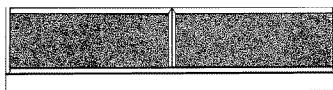

Place Filters side by side

6. Place the filters side by side on the support bars in front of the back panel. They will lean forward and the tops will rest against the inside of the front panel supports.
7. Replace ventilator cap. Be certain all sides of the cap fit inside the ventilator sides and back panel.

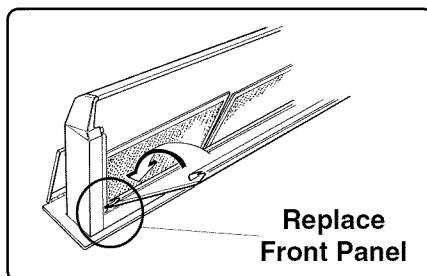

Replace Front Panel

8. Replace the front panel by hooking the lower front edge of the front panel over the lower front edge of the ventilator.

Side Supports

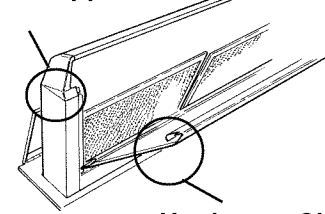

Hook over Side Supports

9. Hook the top of the front intake panel over the side supports at the top of the ventilator.

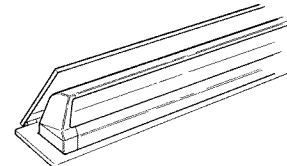

Cover and Vent Going Down

10. As the ventilator intake is lowered, the cover will return to its position covering the ventilator.

To Clean Gap Area Between Ventilator & Cooktop

1. With ventilator in up position, remove front panel, ventilator cap and filters.
2. Lower ventilator completely.
3. Clean gap area using a mild grease solvent (see Cleaning Chart).
4. Raise ventilator completely and replace filters, cap and front panel.

* Not on all Models.

GENERAL CARE AND MAINTENANCE - COOK'N'VENT

ACCESS PANELS AND ELECTRICAL CONNECTIONS

Frequency of cleaning depends on how often the filters and back panel at the top of the unit are cleaned.

There are four different ways the Access Panels **A** and **B** could have been installed. **DO NOT OPEN ELECTRICAL BOX "E"**. See Installation Instructions.

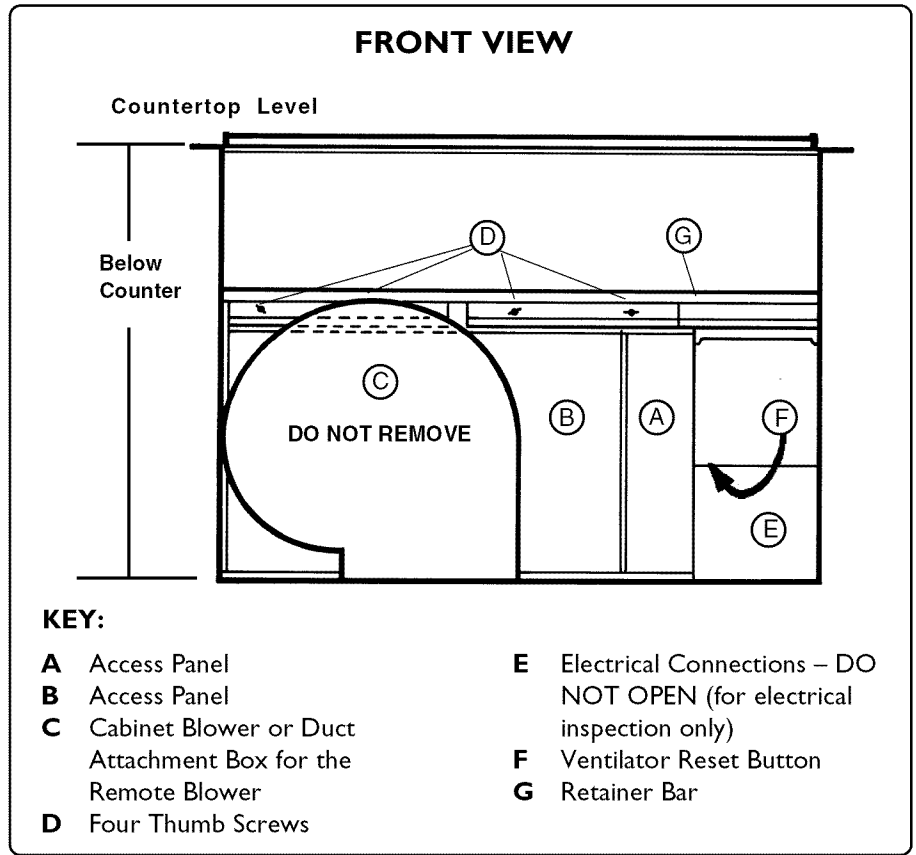
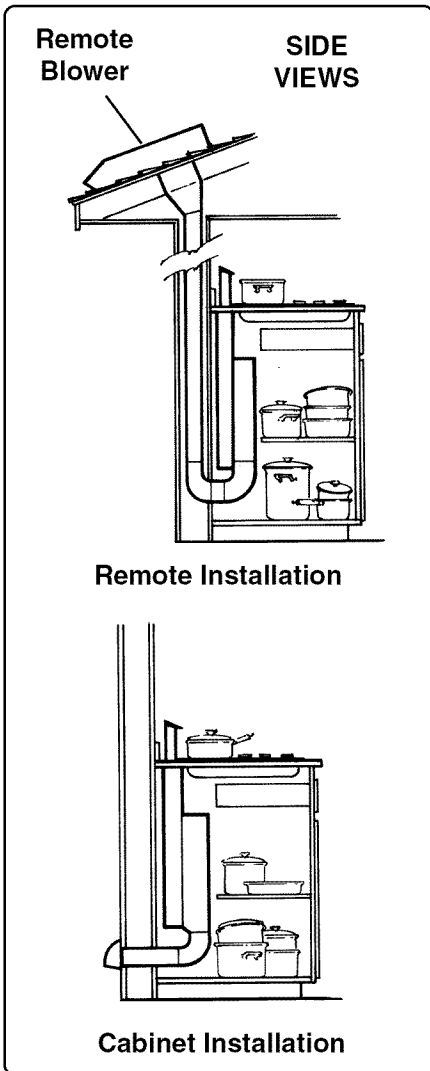

TO REACH CLEAN OUT AREA

1. Loosen (but do not remove) the thumb screws (Item D).
2. While holding C (it is heavy), move the retainer bar G up and lift out panels A and B. Lower the retainer bar G so it will hold C in place.

DO NOT REMOVE BLOWER or DUCT ATTACHMENT BOX C
(remote blower installation).

3. Do not open the electrical box E on the right.
4. Wipe up any accumulated grease inside the area. Wipe with a cloth dampened with hot soapy water or use a general household spray for grease. Rinse and dry before closing the compartment.
5. After cleaning, replace the access panels and securely tighten the thumb screws.

You have either a remote or a cabinet blower C installed on the ventilation system of your Cook'n'Vent cooktop.

There are access panels at the base of the ventilator system inside the cabinet. If there is a shelf under the cooktop, it must be removable as the Access Panels A and B and the Electrical Connection Box E must be accessible for cleaning, electrical inspection or service.

Periodically – approximately every six months – check the enclosure behind the access panels A and B for food soil.

BEFORE CALLING FOR SERVICE

Before calling for service, check the following to avoid unnecessary service charges.

<p>The burners do not light within 4 seconds:</p>	<ul style="list-style-type: none"> ▲ Are the igniters sparking? ▲ Is there excess water or liquid cleaner on the igniter? ▲ Is the burner cap level and properly positioned on the burner base? See Page 12. ▲ Are the burner ports clogged? See page 13. ▲ Is the gas shutoff valve in the ON position? ▲ Is the gas supply to the house or the area turned off?
<p>The igniters do not spark:</p>	<ul style="list-style-type: none"> ▲ Is the power cord plugged all the way into the wall receptacle? ▲ Is the circuit breaker tripped or household fuse blown? ▲ Is there a power outage in the area?
<p>The igniters spark intermittently:</p>	<ul style="list-style-type: none"> ▲ Is there a draft in the room? ▲ Check that the wires to the electric outlet have not been reversed. See Note below re: polarity. ▲ Was a liquid cleaner sprayed on the igniter?
<p>The burner flame is yellow, distorted or does not burn completely around the burner cap:</p>	<ul style="list-style-type: none"> ▲ Is the burner cap level and properly positioned on the burner base? See Page 12. ▲ Are the burner ports dirty or clogged? See Page 13. ▲ Was the the cooktop installed correctly? (Have it checked by a qualified technician.)
<p>Models SGS36G, SGSCV36G, SGNCV36G & SGN36G — If the Griddle element does not heat:</p>	<ul style="list-style-type: none"> ▲ Check to be certain the element terminals are pushed securely into the receptacle. If element needs replacement, use only original Thermador parts.
<p>Models GGNCV30/36, SGNCV36G, SGSCV36G: If the ventilation system does not operate:</p>	<ul style="list-style-type: none"> ▲ Check the reset button located at the bottom of the intake assembly, see Page 27, front view, item F.
<p>If there is a power failure:</p>	<ul style="list-style-type: none"> ▲ See Page 13.

NOTE: Polarity —In older houses, wiring polarity was not always observed. Although polarized receptacles (3 Prong) may have been installed, they could have been wired incorrectly. If they were wired incorrectly, the igniters see a grounded condition and may click intermittently even with both the control knobs turned OFF.

SERVICE INFORMATION

For handy reference, copy the information below from the rating plate. Keep your invoice for warranty validation.

Model Number

Serial Number

Date of Purchase

Dealer's Name

Dealer's Telephone Number

Service Center's Name

Service Center's Telephone Number

RATING PLATE

The Rating Plate shows the model number and serial number of your cooktop. It is located underneath the cooktop at the right front corner of the rough-in box.

WARRANTY

GG30/36/365 - GGSCV30/36/365 - SGS30 -SGS36G - SGSCV36G -
GGN30/36/365 - GGNCV30/36/365 - SGN30 - SGN36G - SGNCV36G

FULL ONE YEAR WARRANTY

Covers one year from date of installation, or date of occupancy on a new, or previously unoccupied dwelling. Save your dated receipt or other evidence of installation/ occupancy date.

Thermador Will Pay For:

All repair labor and replacement parts found to be defective due to materials and workmanship.

Service must be provided by a Factory Authorized Service Agency, during normal working hours. For a Service Agency nearest you, please call 800/735-4328.

Thermador Will Not Pay For:

1. Service by an unauthorized agency. Damage or repairs due to service by an unauthorized agency or the use of unauthorized parts.
2. Service visits to:
 - Teach you how to use the appliance.
 - Correct defects or repairs due to improper installation. You are responsible for providing electrical wiring and other connecting facilities.
 - Reset circuit breakers or replace home fuses.
 - Damage caused from accident, alteration, misuse, abuse, improper installation or installation not in accordance with local electrical codes or plumbing codes, or improper storage of the appliance.
 - Service labor during limited warranty period.
 - Travel fees and associated charges incurred when the product is installed in a location with limited or restricted access. (i.e., airplane flights, ferry charges, isolated geographic regions).
 - Repairs due to other than normal home use.

This warranty applies to appliances used in residential applications; it does not cover their use in commercial installations.

The warranty is for products purchased and retained in the 50 states of the U. S. A., the District of Columbia and Canada. Should the appliance be sold by the original purchaser during the warranty period, the new owner continues to be protected until the expiration date of the original purchaser's warranty period. Products for use in Canada must be purchased through the Canadian distribution channel to ensure regulatory compliance and warranty coverage.

This warranty gives you specific legal rights. You may also have other rights which vary from state to state.

HOW TO OBTAIN SERVICE

- Contact the Factory Authorized Service Agent in your area
- Contact the Dealership where you purchased the appliance.
- Call the Thermador Customer Support Call Center at 800-735-4328
- Write us to at: Thermador 5551 McFadden Avenue, Huntington Beach CA, 92649

Thermador Commitment:

Thermador wants to ensure that we exceed your expectations of support not only with your current appliance purchase, but well into the future. If an issue arises that is not resolved to your satisfaction, please let us know by calling or writing to us at the telephone number or address shown above.

Specifications are for planning purposes only. Refer to installation instructions and consult your countertop supplier prior to making counter opening. Consult with a heating and ventilating engineer for your specific ventilation requirements. For the most detailed information, refer to installation instructions accompanying product or write Thermador indicating model number.

We reserve the right to change specifications or design without notice. Some models are certified for use in Canada. Thermador is not responsible for products which are transported from the United States for use in Canada. Check with your local Canadian distributor or dealer.

For the most up to date critical installation dimensions by fax, use your fax handset and call 702/833-3600. Use code #8030.

Thermador[®]

5551 McFadden Avenue, Huntington Beach, CA 92649 • 800/735-4328
ECO 5V0065 • 20-02-373I • © 2001 BSH Home Appliances Corp. • Litho in U. S. A. 5/01

ECO 5V0065 • Part Number 50 60 00 05 01

Thermador[®]

Care and Use Manual

for
ExtraLow[™]
Gas Cooktops

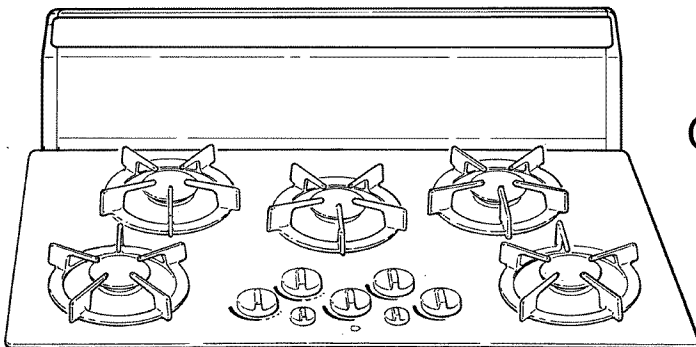
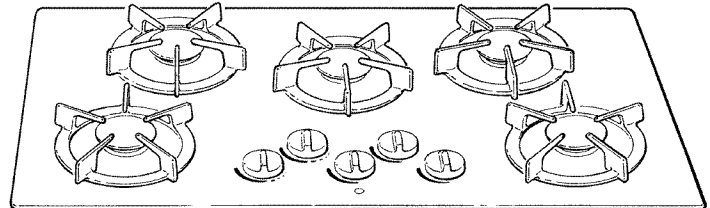

Models
GG30/36/365, GGSCV30/
36/365, SGS30/36G,
SGSCV36G

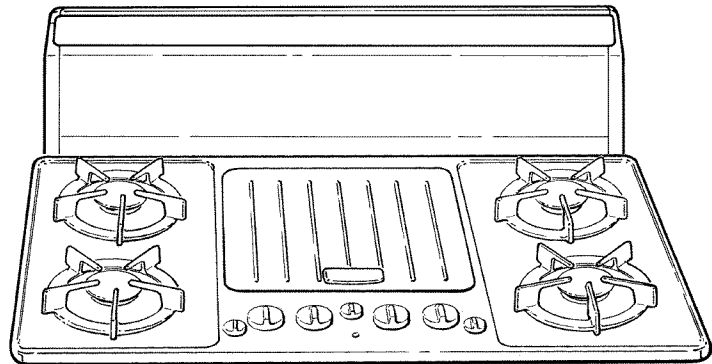

and
Traditional Series Gas Cooktops

Models
GGN30/36/365, GGNCV30/36/365, SGN30/36G, SGNCV36G

To the Installer: Leave this owner's manual with the cooktop.

To the Consumer: Retain this Care & Use Manual for future reference. Be sure to fill in the information on Page 28 for warranty validation.

A Special Message to Our Customers,

Thank you for selecting a Thermador Gas Cooktop. If you follow the few simple procedures and suggestions in this manual, the cooktop should give you years of service.

You have either a steel top or a glass top. The glass cooktop fully meets the safety and durability requirements of the American Gas Association, the Canadian Gas Association and the Tempered Glass Association as well as the stringent test requirements imposed by Thermador. Testing includes dropping a 1.2 pound steel ball from about 2 feet and hitting the glass with a 4 pound "pan bottom" 10 times. The cooktop is tough, but it is glass. Severe abuse or excessively rough treatment may break the glass. Tempered glass derives its excellent strength and heat resistance from powerful internal tensions throughout the piece. When any part of the glass is broken, these tensions are released throughout the piece. In this unlikely event, the entire glass will break into many small, blunt pieces called popcorn (the average count is 20 pieces per square inch). The pieces may scatter somewhat and since most particles are transparent, food on or near the cooktop should not be eaten. The cooktop should not be used again until it is repaired by a qualified service technician. Remember, the steel top is covered with porcelain enamel, which is also a very durable glass. Severe abuse or excessively rough treatment may cause the porcelain enamel to chip.

There is no limit to the types of food which can be cooked on your cooktop, but some utensils could harm it. Do not use any utensil which spans two burners because this will excessively heat the space between them. Utensils which have large overhangs beyond the burner grate may cause over heating or tipping, if used for long periods of time. Of course, hard impact should be avoided.

We recommend that you read this entire manual before using your new cooktop. We know you will enjoy cooking on your new cooktop. Please contact us if you have questions or comments. When you write, please include the model and serial numbers of your cooktop.

Sincerely,

The Home Economics Staff

TABLE OF CONTENTS

Propane Installation	2	Section Four: Using the Cooktop	10 to 21
Section One:		Cooktop Operation	11
General Safety Instructions	3 to 6	Proper Cookware	14
Safety/Electrical Requirements	3	Flame Setting Chart	16
Precautions	4	Griddle'N Grill Operation	19
Section Two: Before you Begin	6	Cook'n'Vent Operation	21
Before using your Cooktop	6	Section Five: General Care	22 to 27
Section Three: Description	7 to 10	General Care	22
Models GGS30, GGN30, GGSCV30		Cleaning Chart	23
GGNCV30	7	Cook'n'Vent Care	26
Models GGSCV36, GGSCV365, GGNCV36,		Section Six: Service	28 to 29
GGNCV365	8	Before Calling For Service	28
Models GGS36, GGN36, GGS365,		Warranty	29
GGN365	9		
Models SGS30, SGN30, SGS36G,			
SGN36G, SGSCV36G, SGNCV36G	10		



WARNING

If the information in this manual is not followed exactly, a fire or explosion may result causing property damage, personal injury or death.

— Do not store or use gasoline or other flammable vapors and liquids in the vicinity of this or any other appliance.

WHAT TO DO IF YOU SMELL GAS

- Do not try to light any appliance.
- Do not touch any electrical switch; do not use any phone in your building.
- Immediately call your gas supplier from a neighbor's phone. Follow the gas supplier's instructions.
- If you cannot reach your gas supplier, call the fire department.

— Installation and service must be performed by a qualified installer, service agency or the gas supplier.

PROpane INSTALLATION

PROPANE GAS INSTALLATION

The cooktop is ready for use with natural gas. It may be converted for use with propane gas using the Burner Propane Conversion Kit, Model NLPKIT6, Part Number 35-00-688. A qualified service technician or installer can convert the cooktop. Be sure the unit being installed is correct for the type of gas being used. Refer to the Rating plate on the right side underneath the cooktop, see pages 7 to 10 for the location.



CAUTION

When connecting the unit to propane gas, make certain the propane tank is equipped with its own high pressure regulator. In addition the pressure regulator supplied with the cooktop must be on the inlet gas pipe of this unit. **The maximum gas pressure to this appliance is not to exceed 14.0 inches water column from the propane gas tank pressure regulator.**

TESTED IN ACCORDANCE WITH ANSI Z21.1, STANDARD FOR HOUSEHOLD COOKING GAS APPLIANCES, and CAN/CGA 1.1 DOMESTIC GAS RANGES.

Check your local building codes for the proper method of installation. In the absence of local codes this unit should be installed in accordance with the National Fuel Gas Code No. Z223.1 Current Issue and National Electrical Code ANSI/NFPA No. 70 Current Issue or the CAN - B149 Installation Codes for Gas Burning Appliances and C22.1 Canadian Electrical Code Part 1.

ELECTRICAL REQUIREMENTS AND GROUNDING INSTRUCTIONS

PLEASE READ CAREFULLY

MODELS: GG30/36/365,
GGSCV30/36/365,
SG30, GGN30/36/365
GGNCV30/36/365 &
SGN30

Rated 120 volt, 60 Hz., 1.0 Amp.

MODELS: SG36G, SGSCV36G
SGN36G & SGNCV36G

Rated 120 volt, 60 Hz., 11.7 Amp

See Installation Instructions for electrical requirements and grounding instructions.

DO NOT UNDER ANY CIRCUMSTANCES CUT OR REMOVE THE THIRD (GROUND) PRONG FROM THE POWER CORD PLUG.

If the electrical outlet you intend to use does not accept the 3-prong plug, it is the personal responsibility and obligation of you, the user, to have it replaced with a properly grounded 3-prong wall receptacle in accordance with the National Electrical Code and/or applicable local codes and ordinances, by a qualified electrician.

**FOR PERSONAL SAFETY,
 THIS APPLIANCE MUST BE
 PROPERLY GROUNDED.**

ALWAYS DISCONNECT THE ELECTRICAL PLUG FROM THE WALL RECEPTACLE BEFORE SERVICING THIS UNIT.

The power cord on your cooktop is equipped with a three prong grounding plug with polarized parallel blades. This type of plug is for your protection against shock hazard. This cord must be plugged directly into a properly grounded 3-prong wall receptacle that is **connected to a correctly polarized 120 volt electric power supply**. It is recommended that a separate circuit serving each appliance be provided.

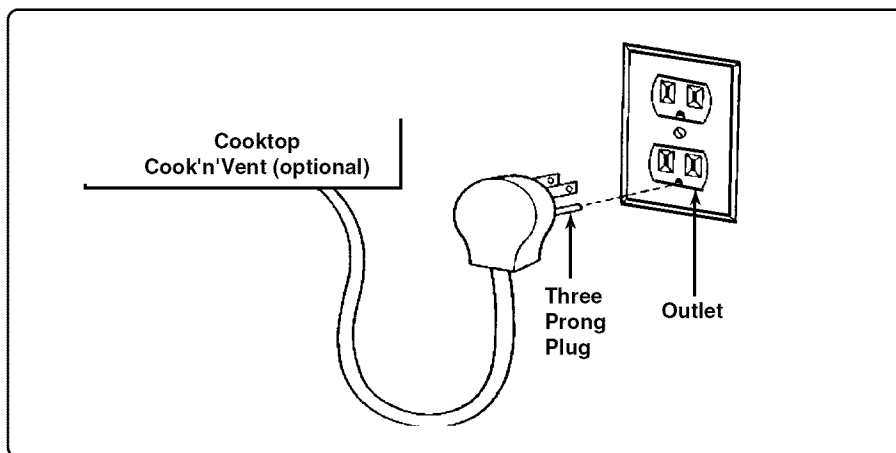

CAUTION - ALL MODELS

IN CASE OF AN ELECTRICAL FAILURE

If for any reason a gas control knob is turned ON and there is no electric power to operate the electronic igniter of the cooktop, **turn OFF the gas control knob and wait 5 minutes** for the gas to dissipate before lighting the burner manually. **On the models with the ExtraLow™ Gas the two left burners cannot be turned on manually.**

To light the burners, carefully hold a lighted match to the burner ports and turn the gas control knob to HI. During a power failure you can use the cooktop burners, but each must be lit with a match.

PRECAUTIONS

SAFETY PRACTICES TO AVOID PERSONAL INJURY

IMPORTANT SAFETY INSTRUCTIONS

WARNING - TO REDUCE THE RISK OF FIRE, ELECTRIC SHOCK, OR INJURY TO PERSONS, OBSERVE THE FOLLOWING:

- A. Use this unit only in the manner intended by the manufacturer. If you have any questions, contact the manufacturer.
- B. Before servicing or cleaning unit, switch power off at service panel and lock service panel to prevent power from being switched on accidentally.
- C. Use high range settings on range only when necessary. Heat oil slowly on low to medium setting.
- D. Do not leave range unattended when cooking.
- E. Always use cookware and utensils appropriate for the type and amount of food being prepared.

CAUTION: For General Ventilating Use Only. Do Not Use To Exhaust Hazardous or Explosive Materials and Vapors.

WARNING - TO REDUCE THE RISK OF FIRE, ELECTRIC SHOCK, OR INJURY TO PERSONS, OBSERVE THE FOLLOWING:

- A. SMOTHER FLAMES with a close-fitting lid, cookie sheet, or other metal tray, then turn off the gas burner or the elec-

tric element. BE CAREFUL TO PREVENT BURNS. If the flames do not go out immediately EVACUATE AND CALL THE FIRE DEPARTMENT.

- B. NEVER PICK UP A FLAMING PAN - You may be burned.
- C. DO NOT USE WATER, including wet dishcloths or towels - a violent steam explosion will result.
- D. Use an extinguisher **ONLY** if:
 1. You know you have a Class ABC extinguisher, and you already know how to operate it.
 2. The fire is small and contained in the area where it started.
 3. The fire department is being called.
 4. You can fight fire with your back to an exit.

WARNING - TO REDUCE THE RISK OF INJURY TO PERSONS, IN THE EVENT OF A RANGE TOP GREASE FIRE, OBSERVE THE FOLLOWING:

When properly used and cared for your new Thermador Cooktop has been designed to be a safe, reliable appliance. When using kitchen appliances, basic safety precautions must be followed, including the following:

Read this Care and Use Manual carefully before using your new cooktop to reduce the risk of fire, electric shock, or injury to persons.

Begin by insuring proper installation and servicing. Follow the installation instructions provided with this product. Have the cooktop installed and grounded by a qualified technician. Have the installer show you where the gas shut-off valve is located so that you know how and where to turn off the gas to the cooktop.

If you smell gas, your installer has not done a proper job of checking for leaks. Connections can loosen in transit. If the connections are not perfectly tight, you can have a small leak and therefore a faint gas smell. Finding a gas leak is not a "do-it-yourself" procedure. Some leaks can only be found with the burner control in the ON position.

For proper lighting and performance of the burners, **keep the igniters clean.** It is necessary to clean these when there is a boil over, or when the burner does not light even though the electronic igniters click. See page 22.

The cooktop is factory

assembled for natural gas. It should be correctly adjusted by a qualified service person or installer for the type of gas with which it is used. (See page 2 for propane gas.)

Do not repair or replace any part of the appliance unless specifically recommended in this manual. All other servicing should be referred to a qualified technician.

Children should not be left alone or unattended in an area where appliances are in use. They should never be allowed to sit or stand on any part of the appliance.

CAUTION: Do not store items of interest to children above the cooktop or at the back. If children should climb onto the appliance to reach these items, they could be seriously injured.

Do not store flammable materials on or near the cooktop.

Do not use water on grease fires. Turn appliance off and smother fire with baking soda or use a dry chemical or foam-type extinguisher.

Never let clothing, potholders, or other flammable materials come in contact with the burners or burner grates, until they are cool to the touch.

Use only dry potholders; moist or damp potholders on hot surfaces may cause burns from steam. Do not use a towel or other bulky cloth in place of potholders. Do not let potholders touch hot burners or burner grates.

For personal safety, wear proper apparel. Loose fitting garments or hanging sleeves should never be worn while cooking.

Do not use aluminum foil to line any part of the cooktop. Improper use of a foil liner could result in a shock, fire hazard or it could obstruct the flow of combustion and ventilation air. Foil is an excellent heat insulator and heat will be trapped beneath it. This will upset the cooking performance and can damage the cooktop finish.

Warning: The appliance is for cooking. Based on safety considerations never use the cooktop to warm or heat a room. Also, such use can be damaging to the cooktop.

Do not heat unopened food containers; a buildup of pressure may cause the container to burst.

When using the cooktop: **DO NOT TOUCH THE BURNER GRATES or THE IMMEDIATE SURROUNDING AREA.** Areas adjacent to the burners may become hot enough to cause burns.

Never leave the burners unattended when using high flame settings. Boil overs cause smoking, and greasy spillovers that may ignite. More importantly, if the flame is smothered, unburned gas will be coming into the room. See "What to do if you smell Gas", Page 1.

Always use utensils that have flat bottoms. Hold the handle of the pan to prevent movement of the utensil when stirring or turning food.

To minimize burns, ignition of flammable materials and unintentional spillovers, **position handles of utensils inward** so they do not extend over adjacent work areas, burners, or the edge of the cooktop.

During cooking, **set the burner control so that the flame heats only the bottom of the pan** and does not extend beyond the edge of the pan.

Take care that drafts like those from fans or forced air vents **do not blow flammable material toward the flames** or push the flames so that they extend beyond the edges of a pot.

Only certain types of glass, heat-proof glass-ceramic, ceramic, earthenware, or other glazed utensils are suitable for cooktop use. This type of utensil may break with sudden temperature changes. Use only on low or medium flame settings according to the manufacturer's directions.

If the cooktop is near a window, **be certain the curtains do not blow over or near the burners;** they could catch on fire.

In the event a burner goes out and **gas escapes,** open a window or a door. Do not attempt to use the cooktop until the gas has had time to dissipate. **Wait at least 5 minutes before using the cooktop.**

PRECAUTIONS

Clean the cooktop with caution. Avoid steam burns; do not use a wet sponge or cloth to clean the cooktop while it is hot. Some cleaners produce noxious fumes if applied to a hot surface.

Clean the hood above or the ventilator at the back of your cooktop frequently so grease from cooking vapors does not accumulate on the filters or on the intake.

Turn the ventilator OFF in case of fire or when intentionally "flaming" liquor or other spirits on the cooktop. The blower, if in operation, could unsafely spread the flames.

The **electric element** is removeable, however it should **never be immersed in water**. Turn the element on and it will clean itself. **DONOT** leave it unattended when burning off food soil.

California Proposition 65 - **Warning:** Burning gas cooking fuel generates some by-products which are on the list of substances which are known by the State of California to cause cancer or reproductive harm. California law requires businesses to warn customers of potential exposure to such substances. To minimize exposure to these substances, always operate this unit according to the instructions contained in this booklet and provide good ventilation.

SAVE THESE INSTRUCTIONS

Section Two: Before You Begin

BEFORE USING YOUR COOKTOP FOR THE FIRST TIME

Remove all packaging materials and labels before using your cooktop.

1. Check that you have these items.

**GG30/36, GGSCV30/36
GGN30/36, GGNCV30/36**

- /
- ▲ 4 Burner Grates
- ▲ 4 Burner Caps
- ▲ 2 Ventilator Filters*
- ▲ Care and Use Manual (warranty found on Page 29).

**GG365, GGSCV365
GGN365, GGNCV365**

- ▲ 5 Burner Grates
- ▲ 5 Burner Caps
- ▲ 2 Ventilator Filters*
- ▲ Care and Use Manual (warranty found on Page 29).

SGS30, SGS36G, SGSCV36G

- ▲ 4 Burner Grates
- ▲ 4 Burner Caps
- ▲ Griddle'n Grill™ (drip pan, cover, griddle, grill, removable element)**
- ▲ 2 Ventilator Filters*
- ▲ Care and Use Manual (warranty found on Page 29).

SGN30, SGN36G, SGNCV36G

- ▲ 4 Burner Grates
- ▲ 4 Burner Caps
- ▲ Griddle (drip pan, cover, griddle, removable element)**
- ▲ 2 Ventilator Filters*
- ▲ Care and Use Manual (warranty found on Page 29).

2. Record the Model and Serial Number as described on page 28.

These may be used for any future contacts with your servicer or the factory.

* Cook'n'Vent models only.

** Griddle'n Grill or griddle models only.

MODEL AND PARTS IDENTIFICATION

Models GGS30* & GGN30

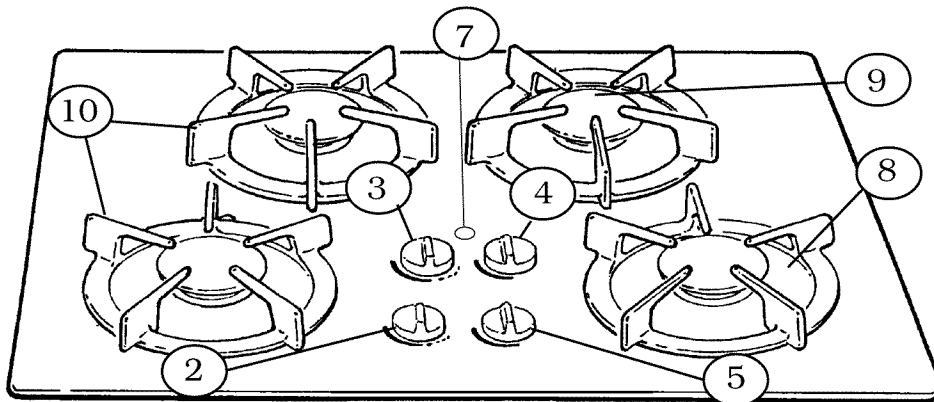

Model GGSCV30* & GGNCV30

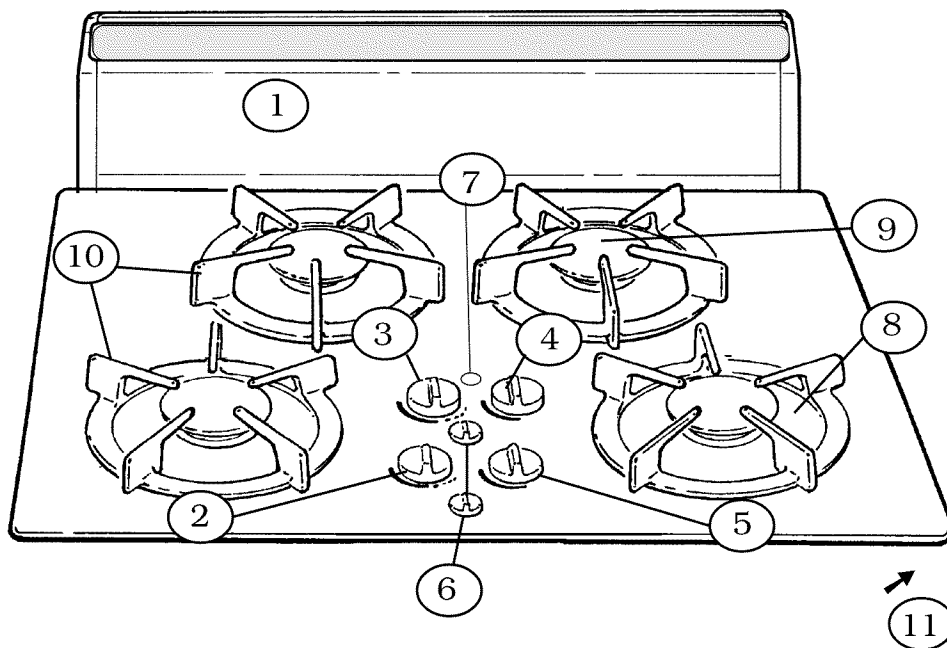

- | | |
|---|--|
| <p>1. Cook'nVent™</p> <p>2. <u>Models GGS</u> - ExtraLow™ 300 to 9,100 BTU/HR Burner & Control Knob
<u>Models GGN</u> - 950 to 6,500 BTU/HR Burner & Control Knob</p> <p>3. <u>Models GGS</u> - ExtraLow™ 365 to 11,000 BTU/HR Burner & Control Knob
<u>GGN Models</u> - 1650 to 11,000 BTU/HR Burner & Control Knob</p> <p>4. <u>Models GGS</u> - 1300 to 9100 BTU/HR Burner & Control Knob
<u>Models GGN</u> - 950 to 6500 BTU/HR Burner & Control Knob</p> | <p>5. 1650 to 11,000 BTU/HR Burner & Control Knob</p> <p>6. Ventilator Controls</p> <p>7. <u>Models GGS</u> - "ON" Light</p> <p>8. Burner Plate</p> <p>9. Burner Cap</p> <p>10. Grates</p> <p>11. Rating Plate, Right Side, underneath Cooktop</p> |
|---|--|

* GGS models illustrated

MODEL AND PARTS IDENTIFICATION

Model GGSCV36* & GGNCV36

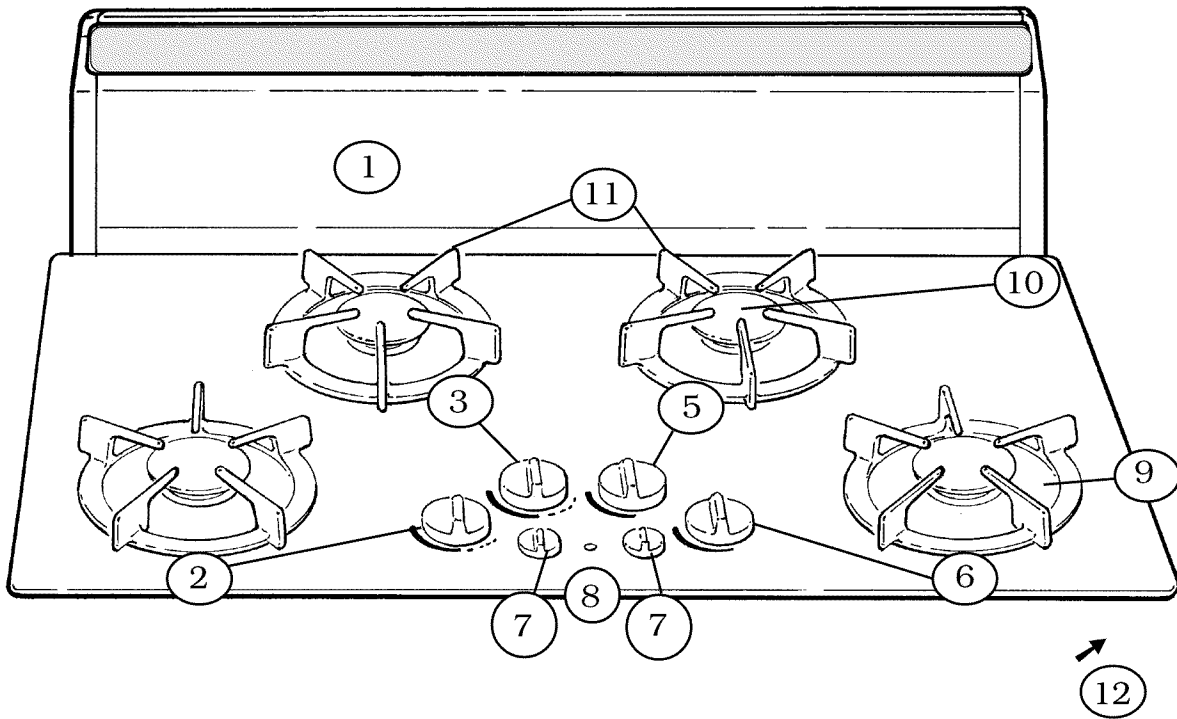

Model GGSCV365* & GGNCV365

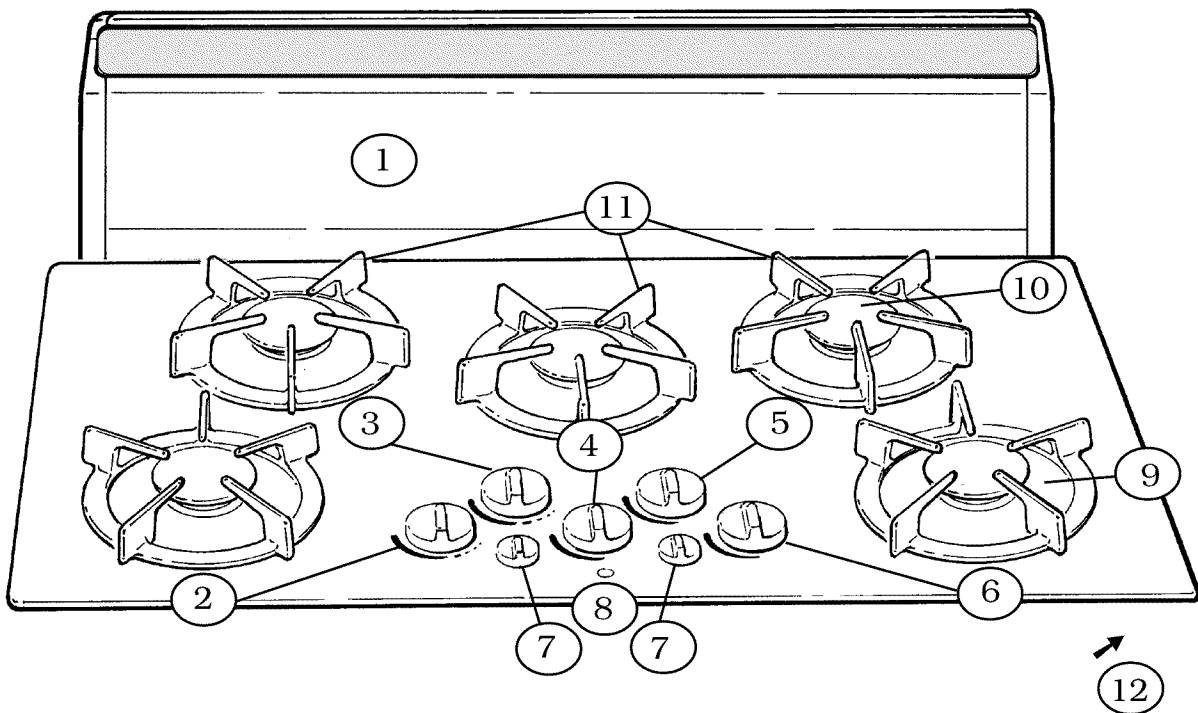

*GGSCV models illustrated

Models GGS36* & GGN36

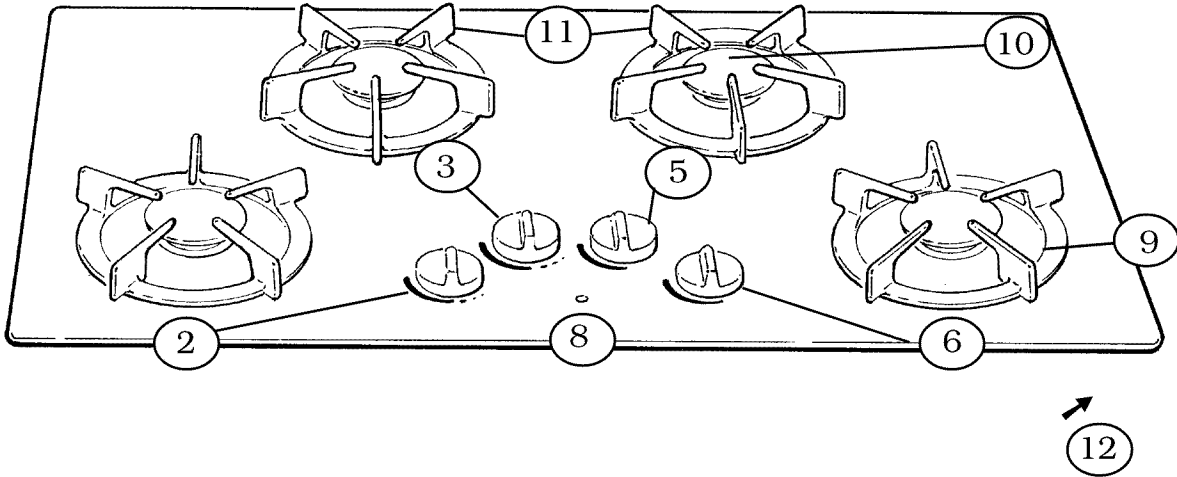

Models GGS365* & GGN365

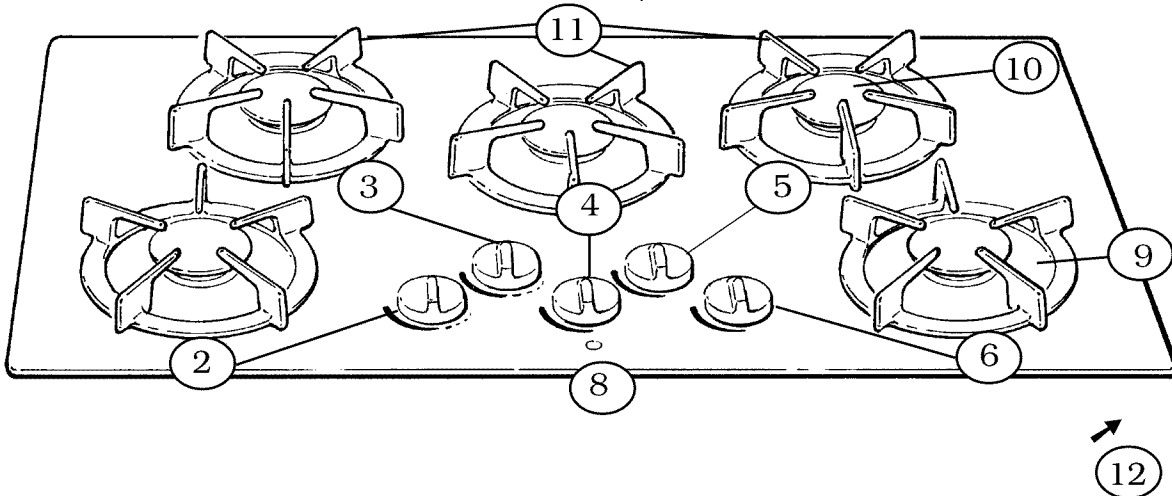

- | | |
|--|---|
| <p>1. Cook'nVent</p> <p>2. <u>Models GGS - ExtraLow™ 300 to 9100 BTU/HR Burner & Control Knob</u>
<u>Models GGN - 950 to 6,500 BTU/HR Burner & Control Knob</u></p> <p>3. <u>Models GGS - ExtraLow™ 365 to 11,000 BTU/HR Burner & Control Knob</u>
<u>Models GGN - 1650 to 11,000 BTU/HR Burner & Control Knob</u></p> <p>4. <u>Models GGSCV365, GGS365 & GGN365 - 950 to 6,500 BTU/HR Burner & Control Knob</u></p> | <p>5. <u>Models GGS - 1300 to 9,100 BTU/HR Burner & Control Knob</u>
<u>Models GGN 950 to 6,500 BTU/HR Burner & Control Knob</u></p> <p>6. 1650 to 11,000 BTU/HR Burner & Control Knob</p> <p>7. Ventilator Controls</p> <p>8. <u>Models GGS - "ON" Light</u></p> <p>9. Burner Plate</p> <p>10. Burner Cap</p> <p>11. Grate</p> <p>12. Rating Plate, Right Side, Underneath Cooktop</p> |
|--|---|

*GGS models illustrated

MODEL AND PARTS IDENTIFICATION

Models SGS30* & SGN30

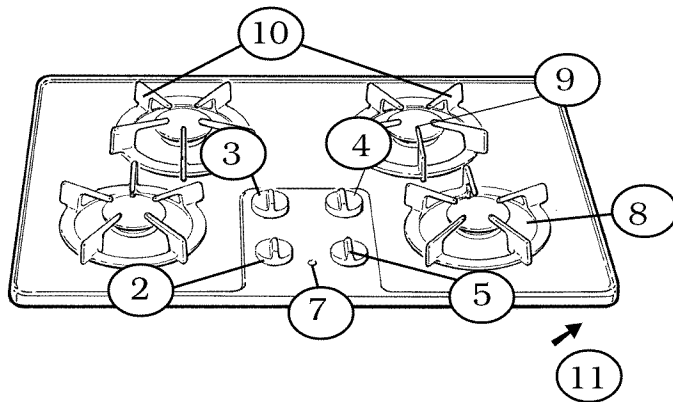

Models SGS36G* & SGN36G

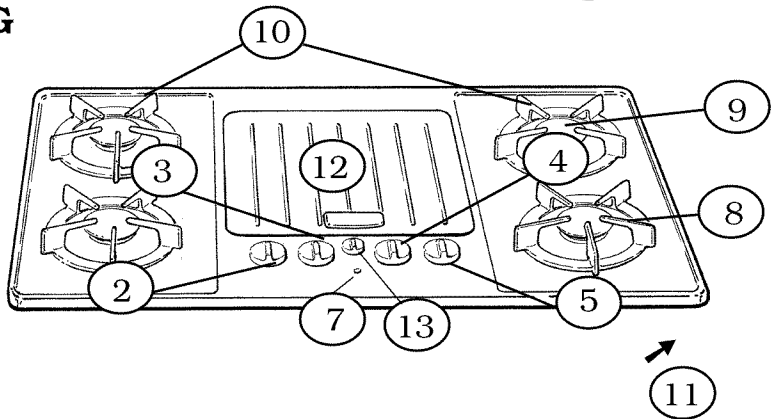

Model SGSCV36G* & SGNCV36G

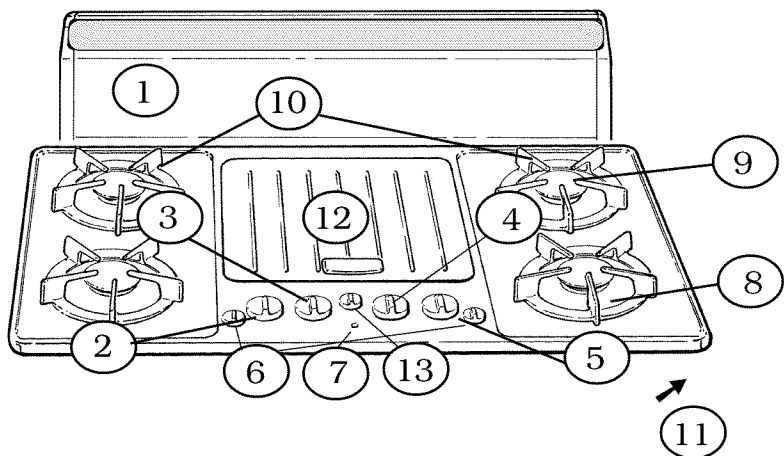

- | | | | | | | | | | | | |
|----------------|---|---|--|------------------------|----------------------------|-----------------|---------------|------------|--|---|---|
| 1. Cook'n Vent | 3. <u>Models SGS - ExtraLow™ 365 to 11,000 BTU/HR Burner & Control Knob</u> | 4. <u>Models SGS - 1300 to 9,100 BTU/HR Burner & Control Knob</u> | 5. <u>Models SGN - 950 to 6,500 BTU/HR Burner & Control Knob</u> | 6. Ventilator Controls | 7. "ON" Light except SGN30 | 8. Burner Plate | 9. Burner Cap | 10. Grates | 11. Rating Plate, Right Side, Underneath Cooktop | 12. <u>Models SGS - Griddle'n Grill</u> | 13. <u>Models SGSG - Griddle'n Grill Control Knob</u>
<u>Models SGNG - Griddle only Control Knob</u> |
|----------------|---|---|--|------------------------|----------------------------|-----------------|---------------|------------|--|---|---|

*SGS models illustrated

CONTROL KNOB — ALL STANDARD BURNERS

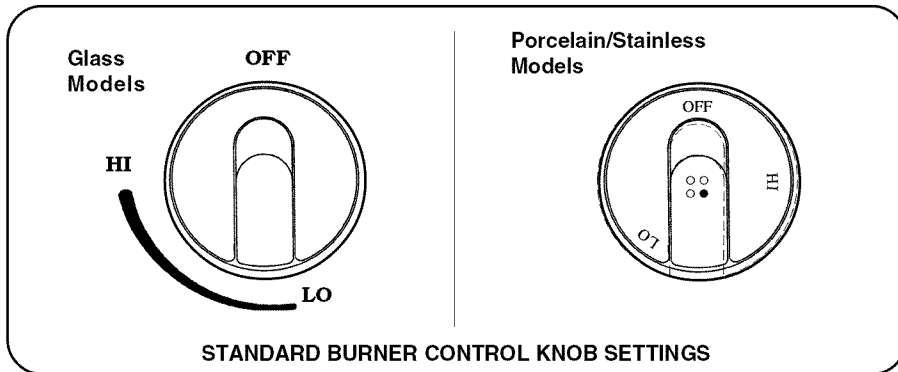

All the controls are push in to turn and have an infinite number of heat settings, with no fixed positions. Select the appropriate control knob and turn it counterclockwise to the **HI** position (detent) until the burner lights. Adjust the flame size. Turn off by turning the control clockwise to **OFF**.

CONTROL KNOB — Thermador® ExtraLow™ BURNERS

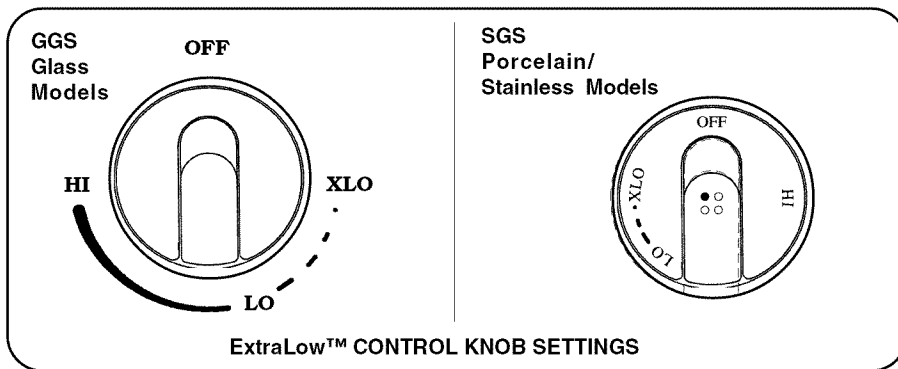

Both ExtraLow controls are push in to turn and have an infinite number of heat settings, with no fixed positions. The ExtraLow settings are between **XLO** and just after **LO**, at the detent, shown by the broken line.

THERMADOR® EXTRALOW™ BURNERS (Models GGS/SGS)

The left front 9,100 BTU/HR burner and left rear 11,000 BTU/HR burner are designed to provide flame settings which enable you to simmer, poach, melt and hold cooked food at a serving temperature, without scorching or burning. This is accomplished by cycling the flame OFF and ON for varying lengths of time.

HOW THEY WORK

- The BTU/HR usage on the 9,100 BTU/HR burner ranges from **HI** (at 9,000) to **XLO** (at 300). The BTU/HR usage on the 11,000 BTU/HR burner ranges from **HI** (at 11,000) to **XLO** (at 365).
- There are an infinite number of settings between **HI** and **XLO**; the control knob can be set at any position.
- The burner flame will pulse ON and OFF when the setting is at any position between **LO** and **XLO**.
- The length of time the flame is ON and OFF varies.
- With a setting just below **LO**, the flame will be ON approximately 50 seconds and OFF 10 seconds of each minute.
- With a setting at the **XLO** position, the flame is ON approximately 10 seconds and OFF 50 seconds of each minute.

FOR THE BEST RESULTS

- Temperature control will be more accurate if a lid is used.
- Bring food to a rolling boil; stir well to be sure all the food is boiling; cover and reduce the heat to just below **LO**.
- Check periodically to see if the control knob should be turned to a lower setting.

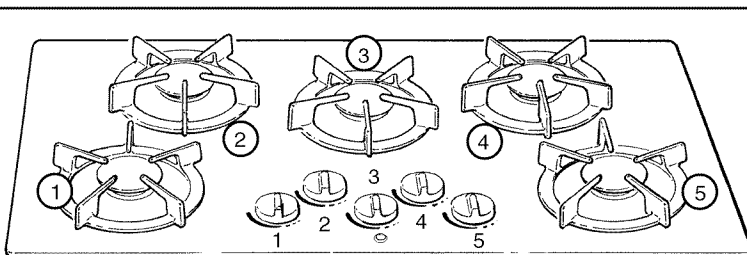

- | | |
|---|----------------------|
| 1. ExtraLow™ 300 to 9,100 BTU/HR Burner and Control Knob | GGSCV365 and GGS365) |
| 2. ExtraLow™ 365 to 11,000 BTU/HR Burner and Control Knob | |
| 3. 950 to 6,500 BTU/HR Burner and Control Knob (Models | Model GGS365 |
| 4. 1300 to 9,100 BTU/HR Burner and Control Knob | |
| 5. 1650 to 11,000 BTU/HR Burner and Control Knob | |

COOKTOP OPERATION

- Adjust control knob to lower settings in small steps.
- If control is set too low to maintain simmer, bring the food back to a boil before setting a higher simmer setting.

WHAT TO EXPECT

- The type and quantity of the food will affect which setting to use.
- The size, type and material of your pan will affect which setting to use.
- When a large pan is used on a small burner, it may cause the simmer action to occur mainly in the center of the pan. When the food is stirred, the cooler food near the edges of the pan may result in an overall temperature too cool to simmer. If this happens, turn the burner up slightly.
- It is normal to stir food occasionally. This is especially important when simmering for several hours. For example: a homemade spaghetti sauce or beans.
- It is normal not to see simmer bubbles immediately after the food has been stirred.
- While the flame is **ON** there may be bubbling; there should be at least steam and a slight quivering of the liquid's surface.
- Simmer bubbles may not be seen when the flame has cycled **OFF**. (Models GGS & SGS)

SIGNAL LIGHT

The Signal Light (not on all models), or "ON" Light is located in the area of the Control Knobs. For location see "Section Three: Description", located on pages 7 to 9, to identify your model. This light turns on when any Control Knob is set.

SEALED BURNERS

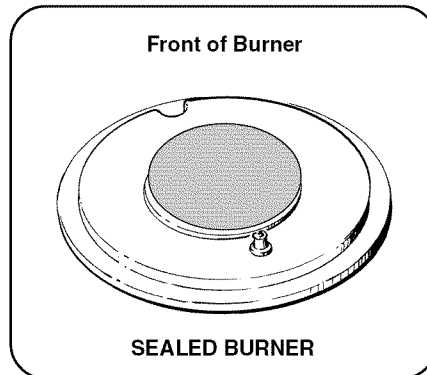

Your new cooktop features four or five sealed gas burners. On Models GGS30/36/365, GGSCV30/36/365, SGS30/30G and SGSCV36G you have two 9,100 BTU/HR burners, two 11,000 BTU/HR burners and on the GGSCV365 or GGS365 there is one 6,500 BTU/HR burner. On Models GGN30/36/365 and SGN30/36 there are two 11,000 BTU/HR and two or three 6,500 BTU/HR burners. Each burner is sealed to the cooktop for easier cleaning.

BURNER CAPS

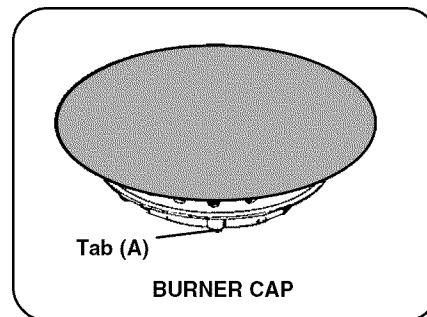

The Burner Cap top is porcelain enamel and has a tab (A) on the underside that fits into the notch (B) on the burner base (C).

BE SURE ALL BURNERS ARE IN THE OFF POSITION BEFORE WIPING OR CLEANING THE COOKTOP.

BURNER PLATES

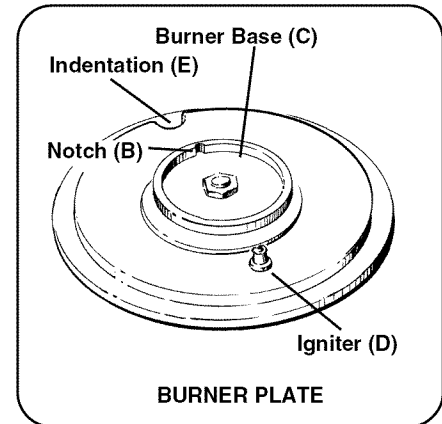

The Burner Plate has a notch (B) on the burner base, directly across from the igniter (D). This is where the tab (A) on the burner cap fits.

□ **NOTE:** For proper burner operation be sure the tab (A) on the underside of the burner cap fits into the corresponding notch (B) on the burner plate.

GRATES

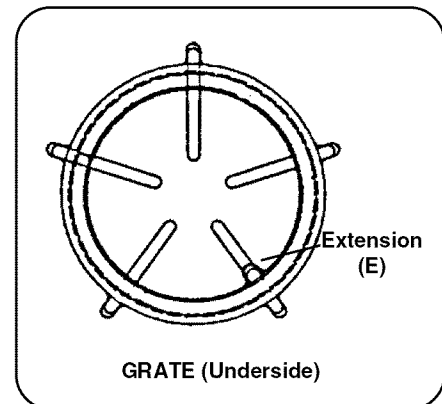

The five finger grates are porcelain enameled cast iron or steel and have an extension (E) that is longer (underneath) than the other four. This extension fits into the indentation (E) on the burner plate, which is directly across from the igniter (D).

ELECTRONIC IGNITION

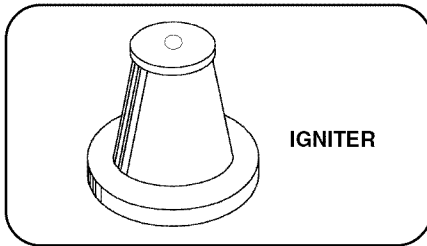

The cooktop uses electronic igniters to light the burners. Each burner has its own igniter that sparks when any burner is turned on. When the igniters are clicking (sparking), do not touch the burners. If a burner fails to ignite, see "Before Calling For Service," Page 28.

AUTOMATIC RE-IGNITION

If any burner flame blows out, the electronic igniter automatically sparks on all burners to relight the flame. Do not touch any burner while the igniters are clicking.

POWER FAILURE

In the event of a power failure, only the standard burners can be lit manually (the burners on the left on Models GGS & SGS cannot be lit). It is necessary to light each standard series burner individually.

If the cooktop is being used when the power failure occurs, turn all the burner control knobs to the OFF position. Then, the standard burners can be lit by holding a match at the ports and turning the control knob to the HI position. Wait until the flame is burning all the way around the burner cap before adjusting the flame to the desired height.

The two ExtraLow™ (Models GGS & SGS) burners, on the left side, cannot be used during a power failure. Be sure to turn them OFF if a power failure occurs, as they will not turn back on until both control knobs are turned OFF and then turned back on again. See "What To Do If You Smell Gas," Page 1.

FLAME HEIGHT

The correct height of the flame depends on the size and material of the utensil being used, the food being cooked and how much liquid is in the utensil. Here are some basic rules for selecting the flame height.

- s The flame should never extend beyond the bottom of the pan.
- s Utensils which conduct heat slowly (such as glass-ceramic) should be used with a low or medium flame unless you are cooking with a large amount of liquid.

BURNER EFFICIENCY and FLAME CHARACTERISTICS

The burner flame should be blue in color and stable with no yellow tips, excessive noise or fluttering. It should burn completely around the burner cap.

Foreign particles in the gas line may cause an orange flame during initial use. This should disappear with use.

If the flame does not burn evenly all the way around the burner cap, be sure the cap is resting correctly on the burner base.

If the ports are clogged, use a wire, a straightened paper clip or a needle to clear the ports. **Do not use a toothpick; it could break off inside the port.** If the condition persists, contact a service agency for adjustment.

The burner should light in 4 seconds or less. If a burner does not light, check to see that the cap is resting correctly on the burner base.



CAUTION

- ▲ **Foods packaged in aluminum foil** should *not* be placed directly on the burner grate for cooking; aluminum foil can melt.
- ▲ **Plastic, paper and cloth can melt or burn** when in contact with a hot burner grate. **Do not** let these items come in contact with the burner grate.
- ▲ **Do not allow pans to boil dry.** This can damage the pan, the burner grate, the cooktop glass and/or the burner plate.

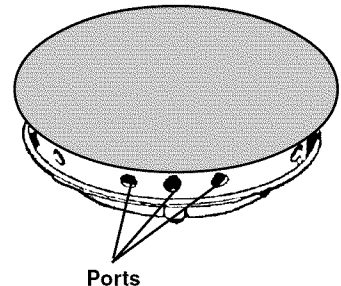

BURNER CAP

**FOR PROPER COMBUSTION
DO NOT USE THE COOKTOP
WITHOUT THE BURNER GRATES IN PLACE.**

PROPER COOKWARE

Top performance of your new cooktop is directly related to the use of proper pots and pans. An out-of-shape pan, without a lid, cannot possibly cook with the same speed and evenness as a pan with a heavy, flat bottom and a good fitting lid.

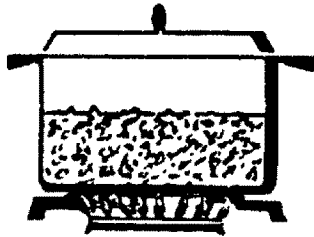

FLAT

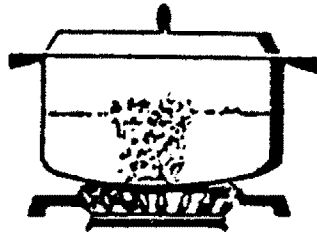

CONVEX (rounded)

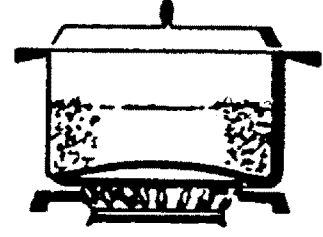

CONCAVE (hollow)

Cookware should have the following characteristics:

- s Good heat conductivity
- s Bottom diameter matching the size of the burner used
- s Good balance (pan bottom remains level on burner grate)
- s Smooth, heavy bottom that does not warp when hot; provides even heat
- s Proper fitting lid (when needed for specific cooking methods)

Do not use cookware with these characteristics:

- s Thin bottom
- s Concave bottom when heated
- s Convex bottom when heated
- s Poor balance (rocks back from weight of handle)

Many different types of pans can be used on this cooktop. To get the best cooking results, choose pans having the following qualities:

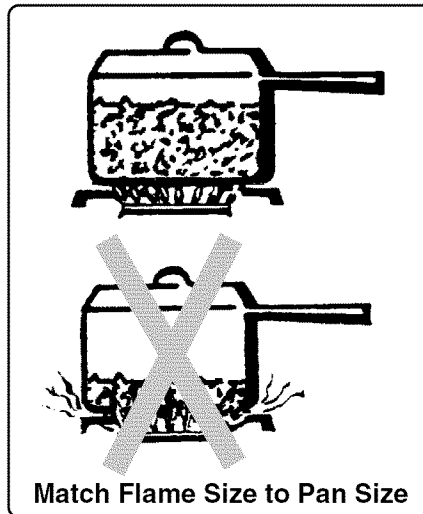

Match Flame Size to Pan Size

Match the flame to the bottom diameter of the pan. The flame should be the same size as the pan or slightly smaller. Small utensils and high flames result in energy loss and increase the potential for burns.

Use cookware that has good heat conductive qualities. Metal cookware that has copper or aluminum imbedded in a stainless steel disk bottom ("tri-ply construction") conducts heat better than other cookware.

Use medium to heavy gauge pans. These pans resist warping and last

longer than thin pans. The weight or thickness of the pan material (gauge) should be heavy enough to conduct heat evenly over the bottom of the pan for even browning and to avoid scorching.

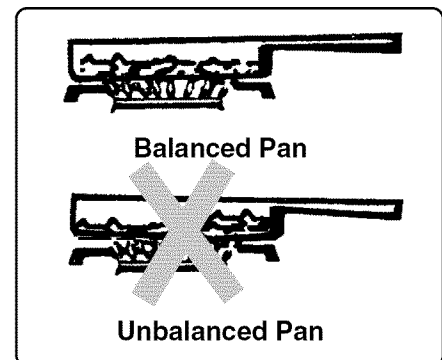

Use balanced pans that sit level on the burner grate without tilting from the weight of the handle.

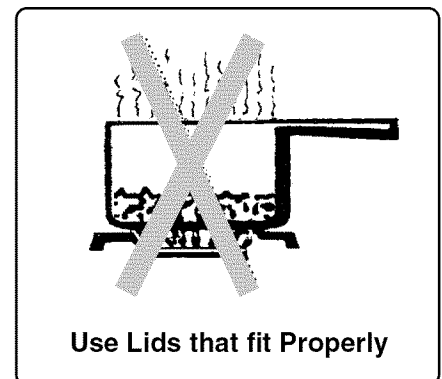

Use Lids that fit Properly

Use lids that fit the cookware properly to help shorten cooking time and to allow food to cook in a minimum amount of liquid on a lower heat setting.

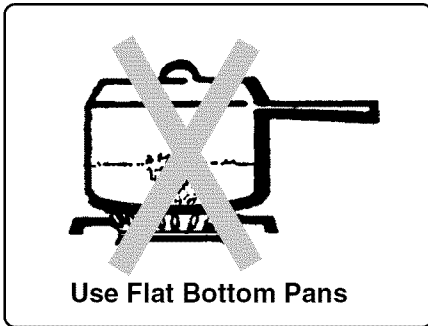

Use flat, heavy bottom pans that stay flat when heated for the best results. Avoid cookware that is warped, dented, ridged or thin. A warped or ridged pan receives the most heat at the points that contact the flame. This can result in burning or scorching of the food being prepared.

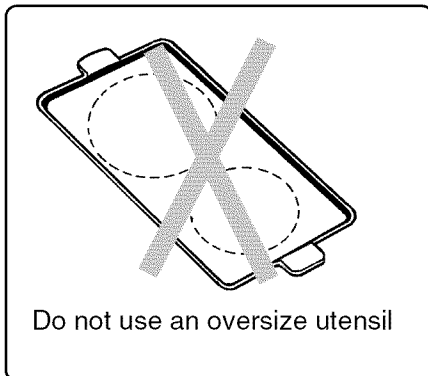

Specialty pans such as woks, lobster pots, pressure cookers, griddles, French fryers, etc. must meet similar design requirements as regular cookware: flat bottom, balanced, correct size, and proper cover (if applicable). **Do not use** utensils such as griddles, roasting pans, au gratin pans, fish poachers or other cooking utensils that must fit across two burners. Use of these products can result in damage to the glass cooktop and porcelain burner pans.

Heat and cool pans gradually to help maintain a flat bottom on your cookware. Do not place pans under cold water while still hot, unless recommended by the manufacturer, as they may warp.

Use only a flat bottom wok. A round bottom wok cannot be used with or without its support ring. The wok is unstable without the ring, and the ring may restrict air to the burners.

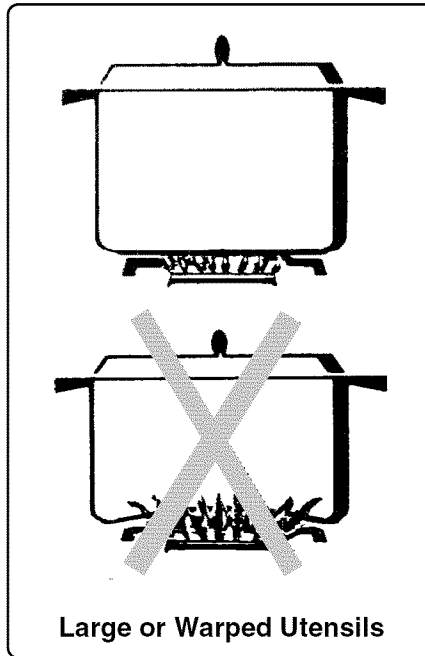

Do not use unusually large or warped utensils such as canners and stock pots on HI heat for an extended period of time. This may cause heat build up which can result in damage to the cooktop or the surrounding countertop. Once food has reached temperature, turn the control setting down to maintain the cooking heat.

Use canners and stock pots that have a flat bottom and extend no more than 2 inches beyond the burner grate.

Canning Tips:

An oversize canning pot can be used with success following these suggestions.

- ▲ Use a canner with a dark or dull finish to reduce heat reflecting back to the cooktop surface.
- ▲ Select a canner with a flat bottom, rather than one with a concave, convex or rippled bottom.
- ▲ Allow at least 3/8 inch of air space between the canner overhang and the cooktop surface.
- ▲ Use the lowest heat setting possible to maintain a boil or pressure.
- ▲ Be sure to cover all containers.
- ▲ Follow the canning instructions given in a standard cookbook or manufacturer's instructions provided with the canning jars.
- ▲ Use care to prevent burns from the large amount of steam generated by the canning process.

Look for canners fitting this description:

- ▲ **Water Bath Canner:** Standard 21 to 22-quart canners with an 11 to 12-inch diameter and a 9 to 11-inch depth.
- ▲ **Pressure Canner:** Canners vary in size from 8 to 22 quarts with 8 to 11-inch bottom diameters and a 6-1/2 to 12-inch depth.

SUGGESTED FLAME SETTINGS

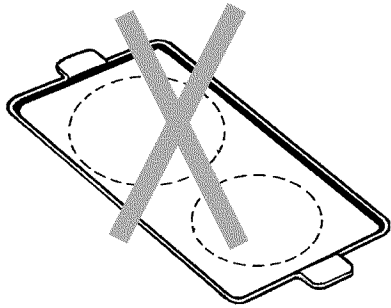

CAUTION

The tempered glass, porcelain and stainless steel used for your cooktop is heat resistant; however, **the use of improper utensils can possibly damage it.** Large or warped utensils or utensils that span two burners, trap heat against the cooktop. The trapped heat goes into the cooktop and overheats the glass which through repeated use of could eventually cause the glass to break; the porcelain top could craze (fine hairlike lines) or the steel top could show heat discoloration.

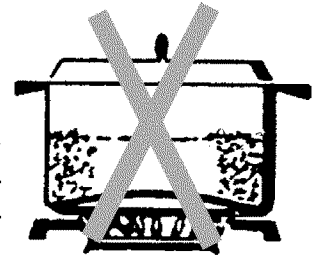

FLAME SETTING CHART GUIDELINES

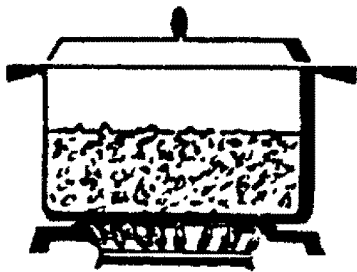

Use the right size flame for the cooking job

The Flame Setting Chart, on Pages 17 and 18, is to be used as a **guide**. Your pans and your manner of cooking may need a different setting than what is suggested. All flame settings were determined **using a variety of good quality, flat bottom pans with lids** (unless the method of cooking did not require a covered pan). The flame was matched to the size of the pan and the method of cooking: simmering, frying, braising, etc.

How to Use the Chart

The chart is divided into two sections: the food and the flame settings. The flame settings section shows an initial Start Cooking setting, a second Continue Cooking setting and /or an ExtraLow™ Heat setting. There may or may not be a change between the two Start Cooking and the Continue Cooking settings depending on the food prepared. The ExtraLow™ Heat (see pages 17-18) setting can be either a cooking, or a holding setting.

Models GGS/SGS shown

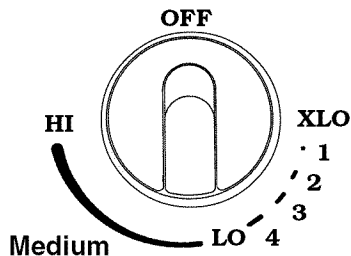

All the controls have an infinite number of heat settings, with no fixed positions between **HI, LO** or **XLO**. The word (**Medium**) and number designations are for reference only and are guides to the flame settings referenced in the following chart.

Guidelines:

1. **The actual flame setting used to cook is selected from the range of flame settings given.** Whether the higher or lower setting is selected depends on the quality of the pan, the amount of food, and the BTU/HR rating of the burner used.
2. **Raise or lower the flame setting gradually.** Allow time for the pan and food to adjust to the new setting. Changes are more satisfactory when the increased or decreased setting is only one or two markings on the control.

Before using this chart, read Page 16.

FOOD	START COOKING	CONTINUE COOKING	EXTRALOW™ HEAT SETTINGS
BEVERAGES Cocoa	Med. — heat milk, cover	LO — finish heating	XLO — keep warm, cover*
BREADS French Toast, Pancakes, Grilled Sandwiches	Med. — preheat skillet	Med. Lo to Med. — cook	
BUTTER			4 to 3 — allow 5 to 10 minutes to melt XLO — to hold
CEREALS Cornmeal, Grits, Oatmeal	HI — cover, bring water to a boil, add cereal	Med. Lo to Med. — finish cooking according to package directions	XLO — to hold, cover*
CHOCOLATE			2 to XLO — allow 10 to 15 minutes to melt XLO — to hold*
DESSERTS Candy	Med. Lo to Med. — cook following recipe	Med. Lo to Med.	
Pudding and Pie Filling Mix	Med. to Med. Hi — cook according to package directions	Med. to Med. HI	
Pudding	Med. Lo — Bring milk to a boil		3 to 2 — to cook
EGGS Cooked in Shell	HI — cover, bring water to a boil, add eggs, cover		XLO — cook 3 to 4 minutes for soft cooked; or 15 to 20 minutes for hard cooked
Fried, Scrambled	Med. to Med. Hi — melt butter, add eggs	LO to Med. Lo — finish cooking	XLO — to hold for a short period*
Poached	HI — bring water to the steaming point, add eggs		4 to 3 — finish cooking
MEAT, FISH, POULTRY Bacon, Sausage Patties	HI — until meat starts to sizzle	Med. Lo to Med. — finish cooking	
Braising: Swiss Steak, Pot Roast, Stew Meat	HI — melt fat, then brown on Med. Hi to HI , add liquid, cover,		3 to 2 — simmer until tender
Quick Frying: Breakfast Steaks	Med. Hi to HI — pre-heat skillet	Med. Hi to HI — fry quickly	
Frying: Chicken	HI — heat oil, then brown on Med.	LO — cover, finish cooking	
Deep Frying: Shrimp	HI — heat oil	Med. Hi to HI — to maintain temperature	
Pan Frying: Lamb Chops, Thin Steaks, Hamburgers, Link Sausage	HI — preheat skillet	Med. to Med. HI — brown meat	4 to 3 — to hold, covered 3 to 2 — to hold, uncovered
Poaching: Chicken, whole or pieces, Fish	HI — Cover, bring liquids to a boil		2 to 1 — to finish cooking

SUGGESTED FLAME SETTINGS

FOOD	START COOKING	CONTINUE COOKING	EXTRALOW™ HEAT SETTINGS
Simmering: Stewed Chicken, Corned Beef, Tongue, etc.	HI — cover, bring liquid to a boil		4 to 1 — simmer slowly
PASTAS Macaroni, Noodles, Spaghetti	HI — bring water to a boil, add pasta	Med. Hi to HI — to maintain a rolling boil	
POPCORN (use a heavy, flat bottom pan)	HI — cover, heat until kernels start to pop	Med. to Med. Hi — finish popping	
PRESSURE COOKER Meat	Med. Hi to HI — build up pressure	Med. Lo to Med. — maintain pressure	
Vegetables	HI — build up pressure	Med. Lo to Med. — maintain pressure	
RICE	HI — cover, bring water to a boil, add rice, cover		4 to 2 — cook according to package directions XLO — to hold, cover
SAUCES Tomato Base	Med. Hi to HI — cook meat/vegetables, follow recipe		2 to XLO — simmer (2 to 3 to thicken sauce, uncovered)*
White, Cream, Bernaise, Hollandaise	Med. Lo — melt fat, follow recipe	LO to Med. Lo — finish cooking	XLO — to hold, cover*
SOUPS, STOCK	HI — cover, bring liquid to a boil		3 to 2 — simmer XLO — to hold, cover*
VEGETABLES Fresh	HI — cover, bring water and vegetables to a boil	Med. Lo to Med. — cook 10 to 30 minutes, or until tender	XLO — to hold, cover
Frozen	HI — cover, bring water and vegetables to a boil	Med. Lo to Med. — cook according to package directions	
Deep Frying	HI — heat oil	Med. to Med. Hi — maintain frying temperature	
In Pouch	HI — cover, bring water and vegetables to a boil	LO to Med. Lo — cook according to package directions	
Saute	HI — heat oil or melt butter; add vegetables	Med. Lo to Med. — cook to desired doneness	
Stir Fry	HI — heat oil, add vegetables	Med. Hi to HI — finish cooking	

* We recommend that these foods be stirred occasionally.

**GRIDDLE'N GRILL™
(Model SGS)
GRIDDLE ONLY
(Model SGN)**

Your new Thermador Griddle'n Grill is a dual purpose electric appliance; a griddle and a grill. The griddle and the grill are used separately and must sit directly on the element for best cooking results. If the griddle or the grill does not sit on the element, it will not heat enough for foods to cook properly.

The Griddle'n Grill control has an infinite number of heat settings. There are no fixed positions between **HI** and **LO**.

To turn the element ON, push in on the control knob and turn it in either direction to the desired setting. See chart for the **griddle settings**.

When **ON**, this element cycles a percentage of **HI** power on and off to maintain the selected heat setting. On **HI** it does not cycle.

Griddle Finish

The aluminum griddle is very durable. It features a stick resistant surface that is an integral part of the metal; it is not a coating. This hardness is achieved through a special anodizing process which changes the surface metal structure. This surface will not rust, chip or peel. Because of its hardness, metal utensils may be used on it while cooking; however, cutting food with a knife or other sharp utensil should be avoided.

Stains, Shadows

Stains on the finish usually result from improper cleaning of the griddle. Minor stains, shadows or images are considered normal and do not effect the performance of the griddle. To maintain good performance and appearance, always follow the cleaning instructions, see Page 24.

BEFORE USING THE GRIDDLE or THE GRILL
Wash the griddle and the grill with hot sudsy water, then rinse thoroughly with clear hot water and dried. This should remove any manufacturing oils which may still be on the surface. A small amount of oil or butter applied after preheating helps to prevent sticking.

GRIDDLE/GRILL CONTROL KNOB and SIGNAL LIGHT

The signal light turns on when any heat setting is selected for the griddle or the grill

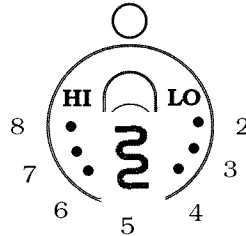

The number designations, on the illustration, are for reference only and are guides to the heat settings in this chart.

SUGGESTED HEAT SETTINGS CHART GRIDDLE		
FOOD	PREHEAT AT SETTING	COOK AT SETTING
BREADS French Toast, Pan cakes, Grilled Sandwiches	6 to 8 — to pre-heat, until water dances, about 8 minutes	7 to 8 — to cook
EGGS Fried, Scrambled	5 to 6 — to pre-heat, about 5 minutes, then melt butter, add eggs	4 to 6 — to cook
FISH Fish Sticks	HI — to preheat	7 to 8 — to cook
MEAT Bacon, Sausage Patties and Links	Put meat on cold griddle. HI — until meat starts to sizzle, about 3 to 4 minutes	6 to 8 — to cook.
Hamburgers, Ham Slice	HI — until meat starts to sizzle	8 to HI — to cook.
Vegetables Hash Brown Potatoes	HI — to brown	8 to HI — to cook.

GRIDDLE 'N GRILL OPERATION

USING THE GRIDDLE

1. Remove the Griddle'n Grill cover and be sure the element is plugged all the way into the receptacle. The two fixed supports on the bottom of the element must rest in the indentations in the bottom of the drip pan. Place the griddle directly on top of the element.
2. **Preheat the griddle according to the chart. After preheating, lightly coat griddle surface with cooking oil or butter.** (A paper towel coated with oil works well to cover surface evenly.)
3. Place food on the griddle.
4. Adjust the heat setting for the food being cooked.

Griddle settings may need to be adjusted to a lower setting if the griddle is used for an extended period of time. When cooking foods such as bacon, the well may need to be drained of grease. When draining grease from the well, always drain away from the cooktop. It is a good idea to turn the gas flame off before moving the griddle so that any grease that spills will not flare up. Be sure to wipe any drips off the griddle before returning it to the cooktop.

If a residue develops while cooking try sprinkling the surface with salt. Rub the salt vigorously into the surface of the griddle with a paper towel. Wipe salt off and continue cooking.

It is important that the griddle be thoroughly cleaned after each use (see Cleaning Chart on Page 24).

THE GRILL (MODEL SGS)

DO NOT leave the grill unattended while grilling food.

1. Remove the Griddle'n Grill cover. Be sure the element is plugged all the way into the receptacle. The two fixed supports on the bottom of the element must rest in the indentations in the bottom of the drip pan.
2. Place the grill directly on top of the element.
3. Turn the control knob to HI and preheat the grill for 10 minutes.
4. Place the food on the grill and cook to desired doneness (most foods are cooked on HI heat setting for the entire cooking time).

NOTE: The hot grill will sear the food sealing in the juices. The longer the preheat, the faster the meat browns and the darker the grill marks.

GRILLING HINTS

Foods cooked for a long time or basted with a sugary marinade may need a lower heat setting near the end of the cooking time. The control knob may be set at any indicated setting or to any position in between.

If large amounts of meat are cooked at one time, occasionally there will be grease drippings that ignite and create minor puffs of flame for a brief second or two. This is a normal part of the cooking process. **Should flame become excessive, remove the food from the grill, turn the control to OFF. Use baking soda to extinguish the flames.**

NOTE: Quantities of accumulated grease may flame or flare up suddenly.

The doneness of meat, whether rare, medium, or well done, is affected to a large degree by the thickness of the cut. Expert chefs say it is impossible to have a rare doneness with a thin cut of meat.

The cooking time is affected by: the kind of meat, the size and shape of the cut, the temperature of the meat when cooking begins, and the degree of doneness desired.

Use a spatula instead of tongs or a fork to turn the meat, as a spatula will not puncture the meat and let the juices run out.

To get the juiciest meats: add seasoning or salt after the cooking is finished; turn the meat only once (juices are lost when the meat is turned several times); and turn the meat just after the juices begin to bubble to the surface.

Trim any excess fat from the meat before cooking. To prevent steaks or chops from curling during cooking, slit the fat around the edges at 1 to 1-1/2 - inch intervals.

To test for doneness, make a small slash in the center of the meat, not at the edge. This will prevent loss of juices.

VENTILATOR

Models GGSCV30/36/365 and SGSCV36G

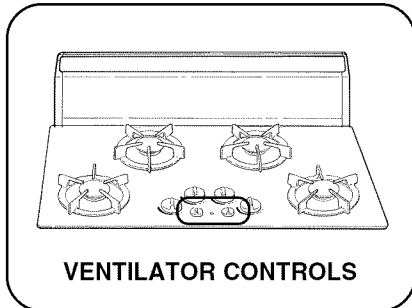

The ventilator is a 500 CFM exhaust system that can be hidden away when not in use. It has a variable speed blower. The amount of drawing power can be adjusted to the cooking job; **HI** exhaust for frying, **LO** for light simmering, or anywhere in between.

RAISING AND LOWERING THE VENTILATOR

The ventilator is raised and lowered by the control knob on the right. It must complete either the up or down cycle before it can be moved in the opposite direction. Be certain it is completely raised or lowered before trying to move it in the opposite direction.

To raise the vent, turn the Vent control knob to the right (UP) until the vent intake no longer moves upward. It automatically stops moving when the maximum height is reached or when the push-button is released.

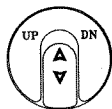

To lower the vent, turn the Vent control knob to the left (DN) until the vent intake is completely lowered. You will hear a **click** when it is completely lowered.

BLOWER SPEED CONTROL

The blower control allows you to select the drawing power needed for a particular food or cooking method.

The vent intake must be in the raised position for the blower to turn on. If it is not fully raised, the blower will not turn on.

To turn the blower ON, turn the control knob clockwise for power continue turning to the right for **LO**.

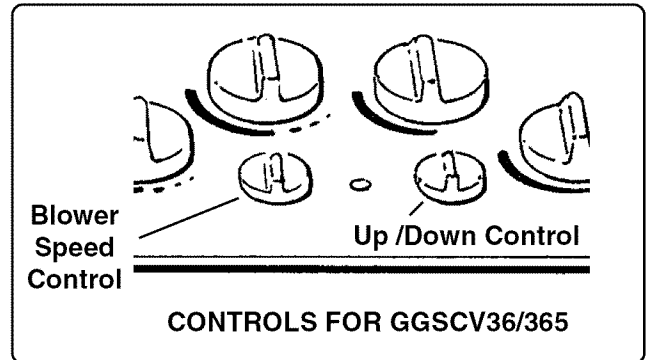
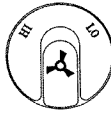

The control knob does not have to be turned OFF manually before the vent intake is lowered. It turns OFF automatically when the Vent DOWN control knob is turned towards the down position. If the control knob is not turned off, it will automatically be ON the next time the intake is fully raised.

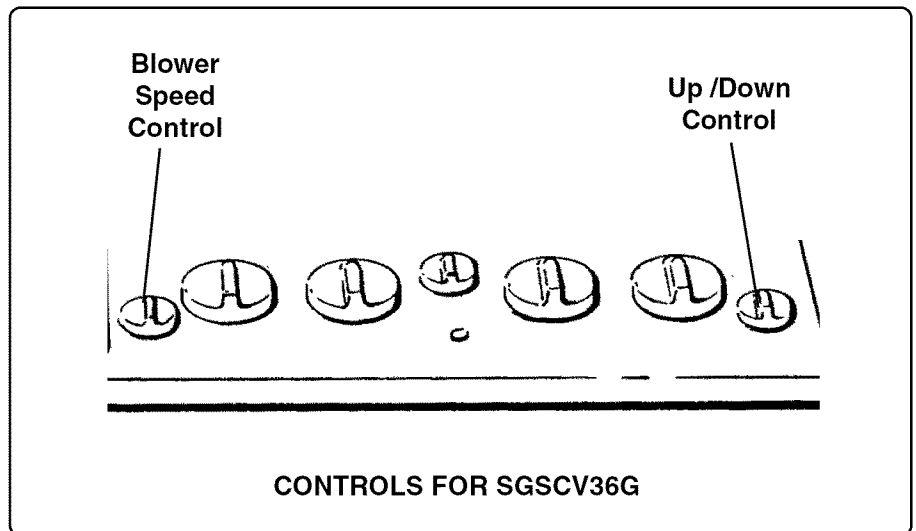
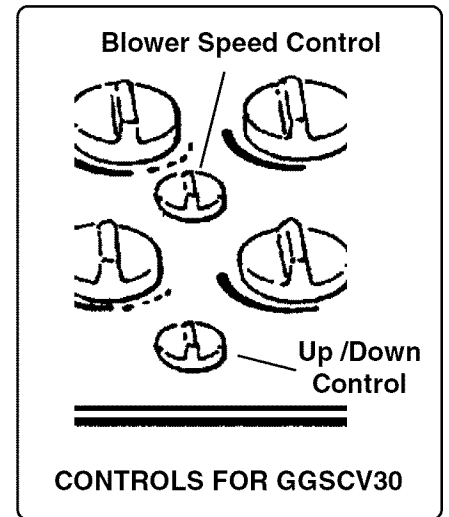

GENERAL CARE

Before cleaning be certain the burners are turned off and the grates are cool.

Any part of the cooktop can be cleaned with hot, sudsy water, then rinsed and dried with a clean, dry

BURNERS

The best cleaning method is prevention. Follow the recommended cleaning procedures and never let the burners get too dirty. If you have a spillover, let the burner cool, then clean immediately. If stains and cooking oils are allowed to burn into the burner, they become more difficult to remove. Refer to Cleaning Chart Page 24, for specific instructions.

DAILY CLEANING

Wipe the burner with a cloth dipped in warm sudsy water, then rinse with a cloth dipped in clean water. **Avoid getting excess water on the igniter.**

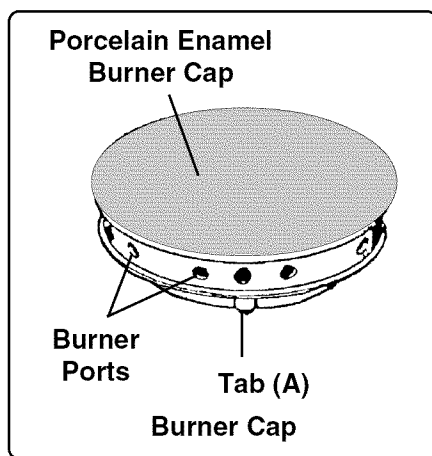

BURNER CAPS

Over a period of time the porcelain enamel burner cap may craze (get fine hair like lines) and discolor or become iridescent. This is normal.

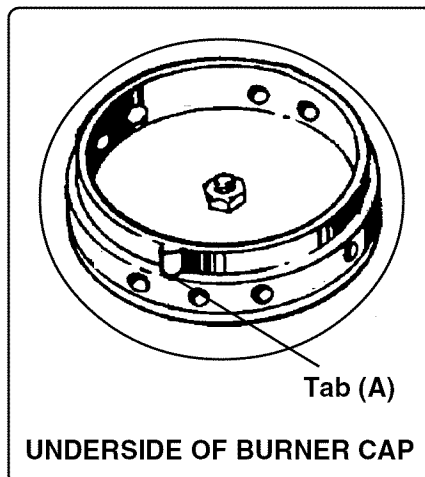

Be sure the burner cap fits correctly; the flame will not burn completely or correctly if cap is not positioned with Tab A in Notch B. **Keep the burner ports clear.** If the ports are clogged, use a wire, a straightened paper clip or a needle to clear the ports. **Do not use a toothpick; it could break off in the ports.**

IGNITERS

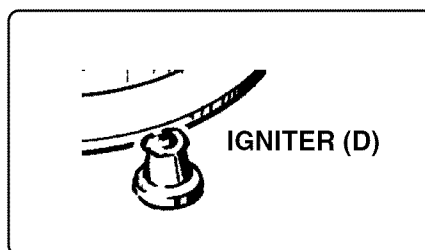

Each burner has an igniter (D) located on the burner plate. Keep the igniters clean. **Avoid getting excess water or liquid cleaner on the igniter.** If the igniter becomes too wet, it may continue to click but not ignite the burner. If the burner does not ignite in 4 seconds, turn off the control and wait until the igniter is dry.

BURNER PLATES

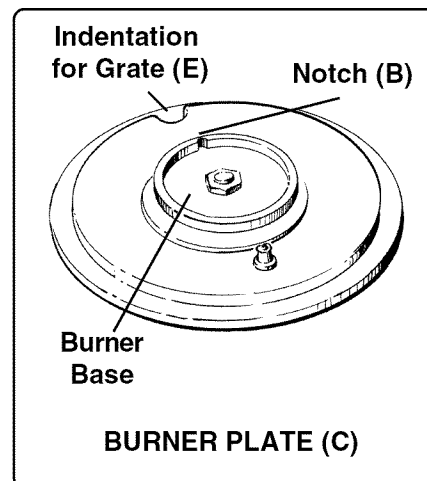

The porcelain enamel finish of the burner plate (C) is acid resistant, but not acid proof. Acid foods, such as citric juices, tomatoes, rhubarb, vinegar, alcohol or milk, should be wiped up immediately. If not removed, they may affect the porcelain finish. Use a paper towel or dry cloth on warm surfaces.

Other food soils can be wiped up with warm soapy water after the cooktop has cooled. Rinse and wipe dry.

BURNER GRATES

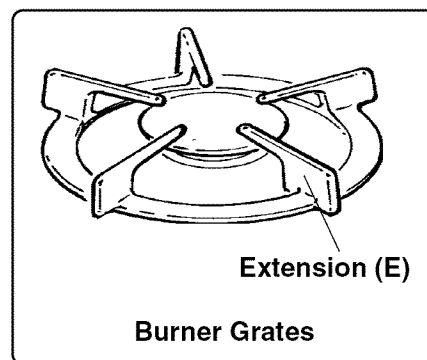

The grates are porcelain enameled cast iron or steel. They should be washed regularly and especially after spillovers. When replacing grates on the burner plates (C), the extension (E) is indexed into indentation (E) directly across from the igniter (D). See illustration Page 22, under Burner Plates.

GENERAL CARE

CONTROL KNOBS

To Remove: Turn the control knob to the **OFF** position and pull up.

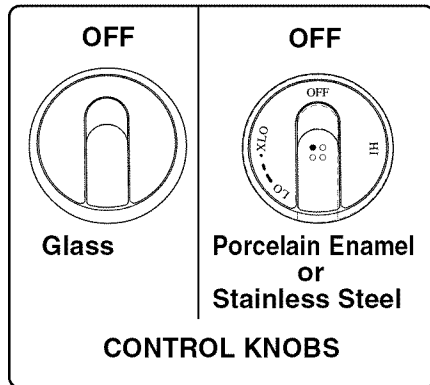

To Replace: Hold the knob with the **OFF** position up, so that the control knob stem opening on the underside of the knob aligns with stem. Push knob down. **Do not force the knob onto the stem.**

To clean, see Cleaning Chart, "PLASTIC," Page 25. **Do not soak knobs.**

COOKTOP FINISH

Glass

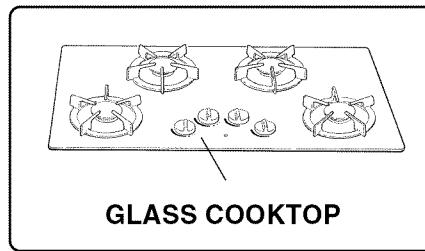

The glass on your cooktop has been fully tempered to withstand the sudden temperature changes it will experience during cooking. It is also highly impact resistant. Treat this glass with the normal care you would give any glass material. To clean, see Cleaning Chart, "GLASS," Page 24.

PORCELAIN ENAMEL

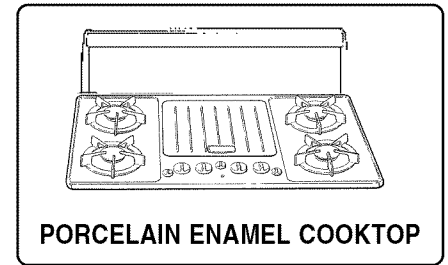

The porcelain enamel finish of the burner plate (C) and the cooktop are acid resistant, but not acid proof. Acid foods, such as citric juices, tomatoes, rhubarb, vinegar, alcohol or milk, should be wiped up immediately. If not removed, they may affect the porcelain finish. Use a paper towel or dry cloth on warm surfaces.

Other food soils can be wiped up with warm soapy water after the cooktop has cooled. Rinse and wipe dry. To clean, see Cleaning Chart, "PORCELAIN ENAMEL," Page 25. See "Stainless Steel" info on Page 25.

DO NOT CLEAN ANY REMOVABLE COOKTOP PARTS IN ANY SELF-CLEANING OVEN. DO NOT USE THE COOKTOP WITHOUT THE BURNER GRATES IN PLACE. BE SURE ALL BURNERS ARE IN THE OFF POSITION BEFORE WIPING OR CLEANING COOKTOP.

CLEANING CHART

When cleaning various parts of the cooktop:

1. Use the mildest cleaning procedure that will do the job efficiently and effectively. Some cleaners of the same type are harsher than others. Try a small area first.
2. Use only clean soft cloths, paper towels, and soap-filled pads for cleaning and scouring.
3. Any part of this appliance can be cleaned with hot sudsy water. Rinse thoroughly with fresh water after every cleaning operation.
4. Always wipe dry to avoid water marks.

The chart on the following page gives directions for cleaning the various parts of the cooktop.

BRAND NAMES

The use of brand names is intended only to indicate a type of cleaner. This does not constitute an endorsement. The omission of any brand name cleaner does not imply its adequacy or inadequacy. Many products are regional in distribution and can be found in the supermarkets.

It is imperative that all products be used in strict accordance with instructions on the package.

CLEANING CHART

DO NOT CLEAN ANY REMOVABLE PARTS OF THIS APPLIANCE IN ANY SELF-CLEANING OVEN. BE SURE ALL BURNERS ARE IN THE OFF POSITION BEFORE WIPING OR CLEANING COOKTOP

MATERIAL/PART	CLEANING PRODUCTS/DIRECTION
	<p>Any part of this appliance can be washed with hot sudsy water, except element.</p> <ul style="list-style-type: none"> Wash thoroughly, rinse and dry.
<p>ALUMINUM Filters (Models GGSCV30/36/365 & SGSCV36G)</p>	<p>Hot sudsy water or wash in dishwasher</p> <ul style="list-style-type: none"> Agitate in hot soapy water, rinse thoroughly and allow to dry, or put through a dishwasher cycle.
<p>Burner Base</p>	<p>Fiber or steel wool soap pad: PanHandl'rs®, S.O.S®</p> <ul style="list-style-type: none"> Rub in circular motion, as small scratch lines will be noticeable. Rinse and dry. Aluminum cleaners may dull the surface. <p>Revereware® Metal Polish will help to retain the luster.</p> <ul style="list-style-type: none"> Follow the directions on the package.
<p>Griddle • Normal</p>	<p>Hot sudsy water, sponge or nylon pad.</p> <ul style="list-style-type: none"> Wash thoroughly with hot soapy water, rinse and dry. Always wash and rinse the griddle thoroughly after each use. Some discoloration may occur with use, but will not affect performance. When not thoroughly cleaned you will feel a film of food residue; this will cause food to stick.
<p>• Hard to Remove Soil</p>	<p>Scouring Pad: Medium grade, Scotch Brite®</p> <ul style="list-style-type: none"> Wash thoroughly with this type scrubber. If necessary sprinkle 1 - 2 Tablespoons baking soda or mild cleanser on wet griddle, rub with a paper towel or nylon pad to remove food soil. Wash with hot soapy water, rinse and dry. <div style="border: 1px solid black; padding: 5px; margin-top: 10px;"> <p>Never wash the griddle in the dishwasher. The caustic detergent used in the dishwasher will discolor the surface. Never use oven cleaners or other harsh cleaning agents, this could destroy the surface.</p> </div>
<p>Grill • Normal</p>	<p>Hot sudsy water</p> <ul style="list-style-type: none"> Always wash and rinse the grill thoroughly after each use. It can be washed in the dishwasher if burned on residue is removed first.
<p>• Hard to Remove Soil</p>	<ul style="list-style-type: none"> Soak grill in hot, sudsy water to which a household cleaner like ammonia has been added.
<p>CERAMIC Igniters</p>	<p>Avoid excess water on the igniters. If an igniter becomes too wet, it may continue to click, but not ignite the burner. If the burner does not ignite in 4 seconds, turn off the control and wait until the igniter is dry.</p> <p>Cotton Swab or toothpick</p> <ul style="list-style-type: none"> Wipe with dampened swab. If necessary, scrape with a toothpick. Be careful not to damage the igniter.
<p>GLASS Cooktop Surface</p>	<p>Glass or window Cleaners: Windex®, Glass Plus®, ammonia and water, or vinegar and water solution</p> <ul style="list-style-type: none"> Spray on and wipe dry. Use a clean dry cloth, paper towel or newspaper to polish.
<p>• Water Spots</p>	<p>Undiluted vinegar.</p> <ul style="list-style-type: none"> Rub on with a dampened cloth or sponge, rinse, and dry. <p>Soft Scrub®, mild abrasive liquid cleanser.</p> <ul style="list-style-type: none"> Use sparingly and rub gently with a damp sponge or soft cloth. If rubbing is hard or if an abrasive pad is used, scratching may occur. Rinse and dry.

CLEANING CHART

MATERIAL/PART	CLEANING PRODUCTS/DIRECTION
<p>ELEMENT Griddle Element</p>	<p>DO NOT RINSE OR IMMERSE ANY ELEMENT IN WATER. The element will clean itself when turned onto the HI setting. The drip pan must always be in place when cooking on the Griddle'n Grill. Do not leave the cooktop unattended when cleaning the element.</p>
<p>PLASTIC Control Knobs</p>	<p>Hot sudsy water.</p> <ul style="list-style-type: none"> • Pull knobs straight up from cooktop. Wash, do not soak. Rinse, then dry. When replacing knobs match the stem opening on the back of the knob with the stem. Do not force knobs onto stems. • Some knobs may discolor temporarily from food stains; this color will lighten and disappear in a few days. Do not wash knobs in the dishwasher.
<p>PORCELAIN ENAMEL Burner Caps, Burner Plates, Grates, Cooktop Surface</p>	<p>The Porcelain Enamel used on the cooktop is acid resistant, but not acid proof. If foods such as citric juices, tomatoes, vinegar, milk, etc. are spilled, wipe up immediately or it may effect the finish.</p> <p>Hot sudsy water.</p> <ul style="list-style-type: none"> • Wash, rinse thoroughly with hot water, and dry. • For burned on food soil, soak the grates in hot soapy water. <p>Mild Cleansers: Bon-ami, Soft Scrub.</p> <ul style="list-style-type: none"> • Apply to a damp sponge or cloth. Rub lightly. Rinse thoroughly and dry. <p>Fiber or steel wool soap pads: PanHandl'rs, S.O.S, Brillo.</p> <ul style="list-style-type: none"> • For stubborn stains, the occasional use of abrasive cleansers is okay, but, if used vigorously or too often, they can eventually harm the enamel. Dampen pad, rub lightly, rinse thoroughly, and dry.
<p>STAINLESS STEEL Cooktop, Ventilator</p> <ul style="list-style-type: none"> • Grease, food spatters, fingerprints 	<p>The quality of this material resists most stains and pitting, providing the surface is kept clean and protected.</p> <p>Nonabrasive Cleaners: Hot soapy water ammonia, or detergent and water.</p> <ul style="list-style-type: none"> • Apply with sponge or cloth, then wipe clean using a clean cloth and thoroughly dry the surface. Apply stainless steel cleaner-polish such as; Stainless Steel Magic® to protect the finish and leave a soft lustre. • Wipe off the stainless steel front and back panels of the vent after each use. Rinse, then polish with a dry cloth, rubbing in the direction of the grain. • If grease has accumulated on the inside of the back panel of the vent, use a nylon or other soft-touch spatula to lift the accumulated grease from the back panel. To reach the back panel, remove the front panel and filters. See page 26. <p>Mild Cleaners: Stainless Steel Magic®, general kitchen cleaners such as Fantastik®, Formula 409®.</p> <p>Vinegar: to remove hard water spots.</p> <ul style="list-style-type: none"> • Apply with sponge or cloth, then wipe clean using a clean cloth and thoroughly dry the surface. <p>Mild abrasive Cleaners: RevereWare Instant Stainless Steel Cleaner®, Kleen King® Stainless Steel Cleaner.</p> <ul style="list-style-type: none"> • Apply with a damp sponge or cloth. <i>Rub lightly in direction of the polish lines.</i> Wipe clean using damp cloth or sponge and dry surface. <div style="border: 1px solid black; padding: 5px; margin-top: 10px;"> <p>Remember, chlorine or chlorine compounds (check the labels) are corrosive even to stainless steel. It is very important to rinse thoroughly and dry if a cleaning agent with chlorine is used.</p> </div>
<ul style="list-style-type: none"> • Heat Tint or discoloration 	<p>Abrasive Cleaners: RevereWare Instant Stainless Steel Cleaner, Zud®.</p> <ul style="list-style-type: none"> • Apply with a damp cloth or sponge. Satisfactory for uses on all finishes if rubbing is light. <i>Use in direction of polish lines.</i>

COOK'N'VENT® VENTILATOR CARE*

See "SAFETY PRACTICES," on Page 4.

The efficiency of the exhaust system depends on the cleanliness of the ventilator, especially the filters. The frequency of cleaning depends on the amount and type of cooking performed.

FILTERS and INTAKE PANEL

Filters become soiled in a short period of time and should be cleaned regularly. The filters may be cleaned by agitating them in a hot detergent solution or by washing in the dishwasher.

Do not use the ventilating system without the filters in place.

TO REMOVE THE FILTERS AND CLEAN THE PANEL

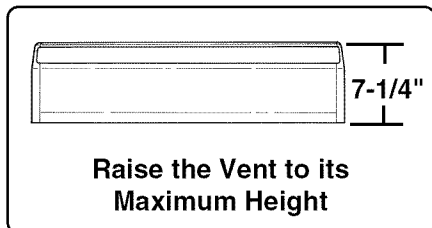

1. Raise the ventilator intake to its maximum height. If the blower is on, turn it off.

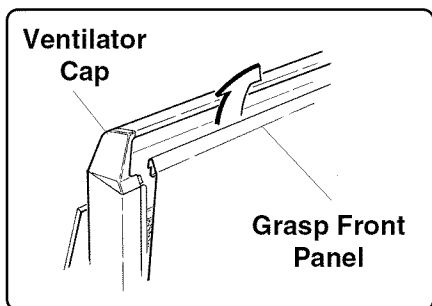

2. Grasp the front panel at the top towards the sides and pull up and forward: remove and set aside.
3. Remove the ventilator cap by grasping both ends of the cap and lifting up.
4. Lift out the filters and clean.

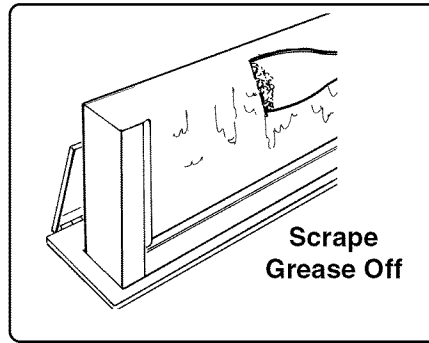

5. Using a nylon or other soft-touch spatula, lift the accumulated grease from the back panel - behind the filters. Clean front and back panels using a mild grease solvent (See Cleaning Chart for Stainless Steel).

TIP: Wipe the intake off after each use.

TO REPLACE THE FILTERS AND THE FRONT PANEL

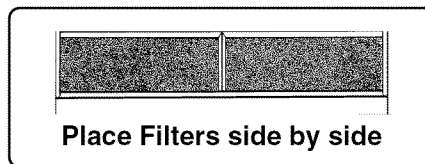

6. Place the filters side by side on the support bars in front of the back panel. They will lean forward and the tops will rest against the inside of the front panel supports.
7. Replace ventilator cap. Be certain all sides of the cap fit inside the ventilator sides and back panel.

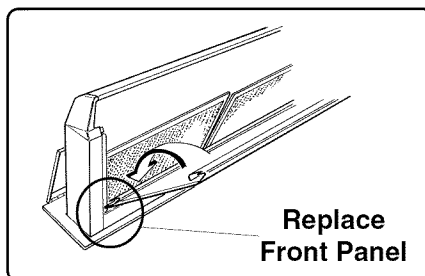

8. Replace the front panel by hooking the lower front edge of the front panel over the lower front edge of the ventilator.

Side Supports

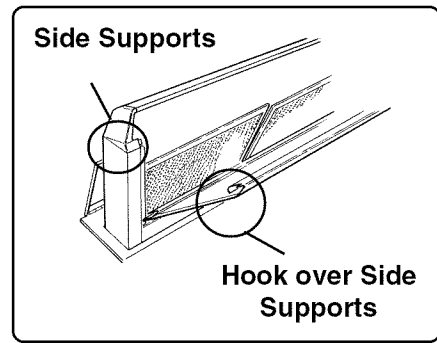

9. Hook the top of the front intake panel over the side supports at the top of the ventilator.

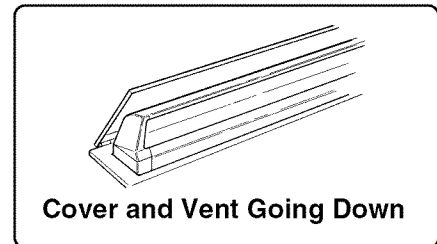

10. As the ventilator intake is lowered, the cover will return to its position covering the ventilator.

To Clean Gap Area Between Ventilator & Cooktop

1. With ventilator in up position, remove front panel, ventilator cap and filters.
2. Lower ventilator completely.
3. Clean gap area using a mild grease solvent (see Cleaning Chart).
4. Raise ventilator completely and replace filters, cap and front panel.

* Not on all Models.

GENERAL CARE AND MAINTENANCE - COOK'N'VENT

ACCESS PANELS AND ELECTRICAL CONNECTIONS

Frequency of cleaning depends on how often the filters and back panel at the top of the unit are cleaned.

There are four different ways the Access Panels **A** and **B** could have been installed. **DO NOT OPEN ELECTRICAL BOX "E"**. See Installation Instructions.

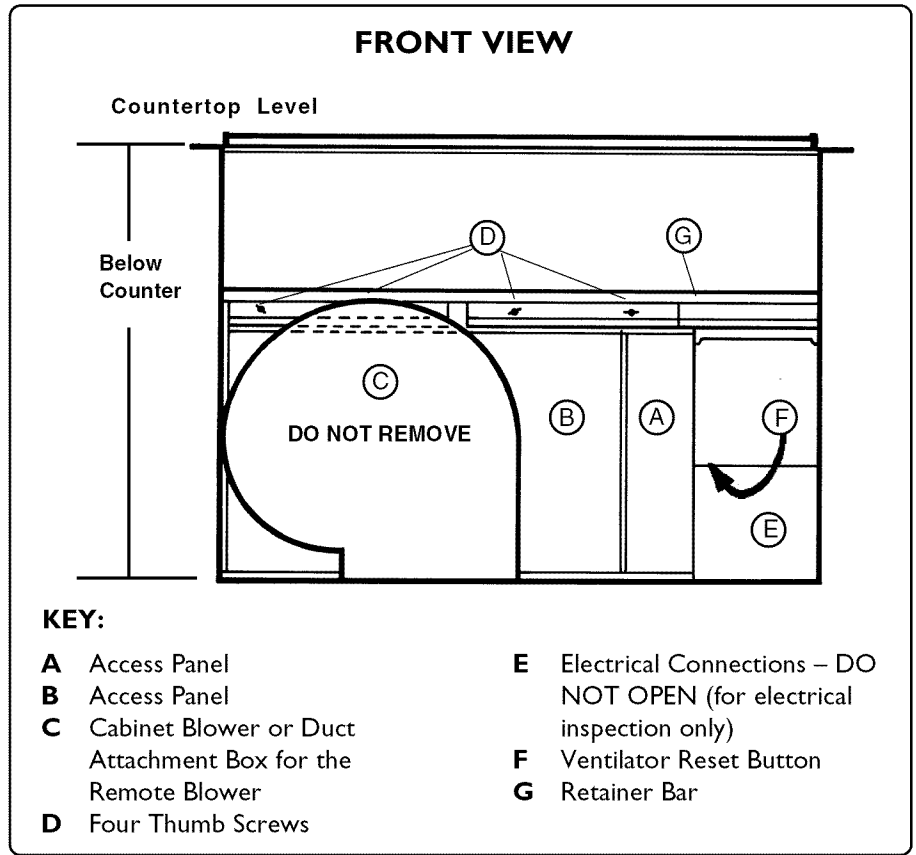
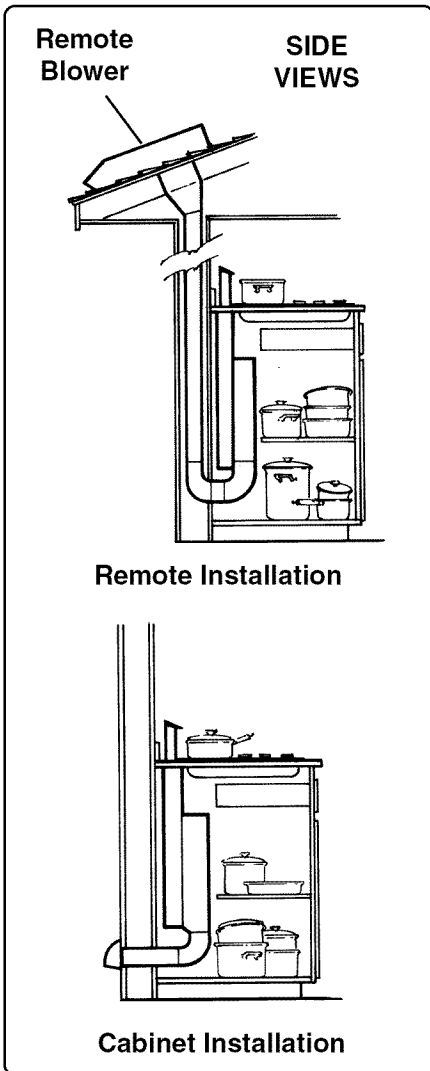

TO REACH CLEAN OUT AREA

1. Loosen (but do not remove) the thumb screws (Item D).
2. While holding C (it is heavy), move the retainer bar G up and lift out panels A and B. Lower the retainer bar G so it will hold C in place.

DO NOT REMOVE BLOWER or DUCT ATTACHMENT BOX C
(remote blower installation).

3. Do not open the electrical box E on the right.
4. Wipe up any accumulated grease inside the area. Wipe with a cloth dampened with hot soapy water or use a general household spray for grease. Rinse and dry before closing the compartment.
5. After cleaning, replace the access panels and securely tighten the thumb screws.

You have either a remote or a cabinet blower C installed on the ventilation system of your Cook'n'Vent cooktop.

There are access panels at the base of the ventilator system inside the cabinet. If there is a shelf under the cooktop, it must be removable as the Access Panels A and B and the Electrical Connection Box E must be accessible for cleaning, electrical inspection or service.

Periodically – approximately every six months – check the enclosure behind the access panels A and B for food soil.

BEFORE CALLING FOR SERVICE

Before calling for service, check the following to avoid unnecessary service charges.

<p>The burners do not light within 4 seconds:</p>	<ul style="list-style-type: none"> ▲ Are the igniters sparking? ▲ Is there excess water or liquid cleaner on the igniter? ▲ Is the burner cap level and properly positioned on the burner base? See Page 12. ▲ Are the burner ports clogged? See page 13. ▲ Is the gas shutoff valve in the ON position? ▲ Is the gas supply to the house or the area turned off?
<p>The igniters do not spark:</p>	<ul style="list-style-type: none"> ▲ Is the power cord plugged all the way into the wall receptacle? ▲ Is the circuit breaker tripped or household fuse blown? ▲ Is there a power outage in the area?
<p>The igniters spark intermittently:</p>	<ul style="list-style-type: none"> ▲ Is there a draft in the room? ▲ Check that the wires to the electric outlet have not been reversed. See Note below re: polarity. ▲ Was a liquid cleaner sprayed on the igniter?
<p>The burner flame is yellow, distorted or does not burn completely around the burner cap:</p>	<ul style="list-style-type: none"> ▲ Is the burner cap level and properly positioned on the burner base? See Page 12. ▲ Are the burner ports dirty or clogged? See Page 13. ▲ Was the the cooktop installed correctly? (Have it checked by a qualified technician.)
<p>Models SGS36G, SGSCV36G, SGNCV36G & SGN36G — If the Griddle element does not heat:</p>	<ul style="list-style-type: none"> ▲ Check to be certain the element terminals are pushed securely into the receptacle. If element needs replacement, use only original Thermador parts.
<p>Models GGNCV30/36, SGNCV36G, SGSCV36G: If the ventilation system does not operate:</p>	<ul style="list-style-type: none"> ▲ Check the reset button located at the bottom of the intake assembly, see Page 27, front view, item F.
<p>If there is a power failure:</p>	<ul style="list-style-type: none"> ▲ See Page 13.

NOTE: Polarity —In older houses, wiring polarity was not always observed. Although polarized receptacles (3 Prong) may have been installed, they could have been wired incorrectly. If they were wired incorrectly, the igniters see a grounded condition and may click intermittently even with both the control knobs turned OFF.

SERVICE INFORMATION

For handy reference, copy the information below from the rating plate. Keep your invoice for warranty validation.

Model Number

Serial Number

Date of Purchase

Dealer's Name

Dealer's Telephone Number

Service Center's Name

Service Center's Telephone Number

RATING PLATE

The Rating Plate shows the model number and serial number of your cooktop. It is located underneath the cooktop at the right front corner of the rough-in box.

WARRANTY

GG30/36/365 - GGSCV30/36/365 - SGS30 -SGS36G - SGSCV36G -
GGN30/36/365 - GGNCV30/36/365 - SGN30 - SGN36G - SGNCV36G

FULL ONE YEAR WARRANTY

Covers one year from date of installation, or date of occupancy on a new, or previously unoccupied dwelling. Save your dated receipt or other evidence of installation/ occupancy date.

Thermador Will Pay For:

All repair labor and replacement parts found to be defective due to materials and workmanship.

Service must be provided by a Factory Authorized Service Agency, during normal working hours. For a Service Agency nearest you, please call 800/735-4328.

Thermador Will Not Pay For:

1. Service by an unauthorized agency. Damage or repairs due to service by an unauthorized agency or the use of unauthorized parts.
2. Service visits to:
 - Teach you how to use the appliance.
 - Correct defects or repairs due to improper installation. You are responsible for providing electrical wiring and other connecting facilities.
 - Reset circuit breakers or replace home fuses.
 - Damage caused from accident, alteration, misuse, abuse, improper installation or installation not in accordance with local electrical codes or plumbing codes, or improper storage of the appliance.
 - Service labor during limited warranty period.
 - Travel fees and associated charges incurred when the product is installed in a location with limited or restricted access. (i.e., airplane flights, ferry charges, isolated geographic regions).
 - Repairs due to other than normal home use.

This warranty applies to appliances used in residential applications; it does not cover their use in commercial installations.

The warranty is for products purchased and retained in the 50 states of the U. S. A., the District of Columbia and Canada. Should the appliance be sold by the original purchaser during the warranty period, the new owner continues to be protected until the expiration date of the original purchaser's warranty period. Products for use in Canada must be purchased through the Canadian distribution channel to ensure regulatory compliance and warranty coverage.

This warranty gives you specific legal rights. You may also have other rights which vary from state to state.

HOW TO OBTAIN SERVICE

- Contact the Factory Authorized Service Agent in your area
- Contact the Dealership where you purchased the appliance.
- Call the Thermador Customer Support Call Center at 800-735-4328
- Write us to at: Thermador 5551 McFadden Avenue, Huntington Beach CA, 92649

Thermador Commitment:

Thermador wants to ensure that we exceed your expectations of support not only with your current appliance purchase, but well into the future. If an issue arises that is not resolved to your satisfaction, please let us know by calling or writing to us at the telephone number or address shown above.

Specifications are for planning purposes only. Refer to installation instructions and consult your countertop supplier prior to making counter opening. Consult with a heating and ventilating engineer for your specific ventilation requirements. For the most detailed information, refer to installation instructions accompanying product or write Thermador indicating model number.

We reserve the right to change specifications or design without notice. Some models are certified for use in Canada. Thermador is not responsible for products which are transported from the United States for use in Canada. Check with your local Canadian distributor or dealer.

For the most up to date critical installation dimensions by fax, use your fax handset and call 702/833-3600. Use code #8030.

Thermador[®]

5551 McFadden Avenue, Huntington Beach, CA 92649 • 800/735-4328
ECO 5V0065 • 20-02-373I • © 2001 BSH Home Appliances Corp. • Litho in U. S. A. 5/01

ECO 5V0065 • Part Number 50 60 00 05 01

Free Manuals Download Website

<http://myh66.com>

<http://usermanuals.us>

<http://www.somanuals.com>

<http://www.4manuals.cc>

<http://www.manual-lib.com>

<http://www.404manual.com>

<http://www.luxmanual.com>

<http://aubethermostatmanual.com>

Golf course search by state

<http://golfingnear.com>

Email search by domain

<http://emailbydomain.com>

Auto manuals search

<http://auto.somanuals.com>

TV manuals search

<http://tv.somanuals.com>