

# USE AND CARE MANUAL

Built-in Ovens

Model:  
POD301  
POD302

**Thermador**® | *An American Icon*™

This Thermador Appliance is made by  
BSH Home Appliances Corporation  
5551 McFadden Ave.  
Huntington Beach, CA 92649

## **Questions?**

1-800-735-4328

[www.thermador.com](http://www.thermador.com)

**We look forward to hearing from you!**

<b>About This Manual</b> .....	<b>1</b>
How This Manual is Organized .....	1
<b>Safety</b> .....	<b>2</b>
<b>Getting Started</b> .....	<b>5</b>
<b>Parts and Accessories</b> .....	<b>5</b>
Parts* .....	5
Accessories .....	6
Inserting Rack .....	7
<b>Control*</b> .....	<b>9</b>
<b>Before Using the Oven for the First Time</b> .....	<b>10</b>
<b>Operation</b> .....	<b>11</b>
<b>About the Appliance</b> .....	<b>11</b>
<b>Basic Features</b> .....	<b>11</b>
Setting the Clock .....	11
Setting the Cooking Mode and Temperature .....	11
Heating Time Limitation .....	12
Timer .....	12
Fast Preheat .....	13
Max Cook .....	13
<b>Special Features</b> .....	<b>14</b>
Cook Time .....	14
Stop Time .....	15
Sabbath Mode .....	16
Probe .....	17
Temperature Offset .....	17
<b>Getting the Most Out of Your Appliance</b> .....	<b>18</b>
<b>General Tips</b> .....	<b>18</b>
<b>Bake</b> .....	<b>19</b>
<b>True Convection</b> .....	<b>20</b>
<b>Roast</b> .....	<b>21</b>
<b>Convection Roast</b> .....	<b>21</b>
<b>Broil/Max Broil</b> .....	<b>23</b>
<b>Convection Broil/Max Convection Broil</b> .....	<b>24</b>

<b>Speed Convection</b> .....	<b>25</b>
<b>Warm</b> .....	<b>26</b>
<b>Dehydrate</b> .....	<b>26</b>
<b>Rotisserie</b> .....	<b>28</b>
Assembling the Rotisserie .....	29
Trussing Poultry for the Rotisserie .....	30
<b>Cleaning</b> .....	<b>31</b>
Self-Clean .....	31
Avoid These Cleaners .....	31
Cleaning Guide .....	32
<b>Maintenance</b> .....	<b>33</b>
Replacing an Oven Light .....	33
Removing the Oven Door .....	34
<b>Service</b> .....	<b>36</b>
<b>Before Calling Service</b> .....	<b>36</b>
Troubleshooting Chart .....	36
Data Plate .....	37
How to Obtain Service or Parts .....	37
<b>STATEMENT OF LIMITED PRODUCT WARRANTY</b> .....	<b>38</b>

---

# About This Manual

## How This Manual is Organized

You can get the most out of your new oven by reading this manual from beginning to end. This way you will systematically get to know your appliance and become familiar with its operation and features.

The manual consists of the following sections:

- The "Safety" section provides information on how to safely operate your oven.
- "Getting Started" introduces you to the oven components and features.
- The "Operation" section offers you step-by-step instructions on how to operate your oven.
- In "Getting the Most Out of Your Appliance" you can find a list of many common foods with the appropriate oven mode, temperature, rack position and bake time. This section also provides you with several bakeware and preparation tips.
- "Cleaning and Maintenance" provides you with information on how to clean and care for the various oven parts.
- The "Service" section includes your warranty and do-it-yourself troubleshooting tips.
- Pay special attention to the important safety instructions in the "Safety" section.

# Safety

	<b>Important Safety Instructions</b>
	READ AND SAVE THESE INSTRUCTIONS

	<b>Warning:</b>
	When properly cared for, your new appliance has been designed to be safe and reliable. Read all instructions carefully before use. These precautions will reduce the risk of burns, electric shock, fire and injury to persons. When using kitchen appliances, basic safety precautions must be followed, including those in the following pages.

## Proper Installation and Maintenance

Have the installer show you the location of the circuit breaker or fuse. Mark it for easy reference.

This appliance must be properly installed and grounded by a qualified technician. Connect only to a properly grounded outlet. Refer to the Installation Instructions for details.

This appliance is intended for normal family household use only. It is not approved for outdoor use. See the Warranty. If you have any questions, contact the manufacturer.

Do not store or use corrosive chemicals, vapors, flammables or nonfood products in or near this appliance. It is specifically designed for use when heating or cooking food. The use of corrosive chemicals in heating or cleaning will damage the appliance and could result in injury.

Do not operate this appliance if it is not working properly, or if it has been damaged. Contact an authorized servicer.

Do not obstruct oven vents.

Do not repair or replace any part of the appliance unless specifically recommended in this manual. Refer all servicing to a factory authorized service center.

In the event of an error the display flashes and beeps continuously. If this happens during self-clean, disconnect appliance from the power supply and call a qualified technician.

In the event of an error the display flashes and beeps continuously. Disconnect appliance from the power supply and call a qualified technician.

## Fire Safety

Do not use aluminum foil or protective liners to line any part of the appliance, especially the oven bottom. Installing these liners may result in risk of electric shock or fire.

If materials inside an oven should ignite, keep door closed. Turn off the appliance, and disconnect the circuit at the circuit breaker box.

Use this appliance only for its intended purpose as described in this manual. For example, never use the appliance for warming or heating the room. Never use the appliance for storage.

Always have a working smoke detector near the kitchen.

In the event that personal clothing or hair catches fire, drop and roll immediately to extinguish flames.



## Important Safety Instructions

READ AND SAVE THESE INSTRUCTIONS

Smother flames from food fires other than grease fires with baking soda. Never use water on cooking fires.

Have an appropriate fire extinguisher available, nearby, highly visible and easily accessible near the oven.

**WARNING** - TO REDUCE THE RISK OF PERSONAL INJURY IN THE EVENT OF A GREASE FIRE, OBSERVE THE FOLLOWING:

- SMOTHER FLAMES with a close-fitting lid, cookie sheet, or metal tray, then turn off the burner. EXERCISE CAUTION TO PREVENT BURNS. If the flames do not go out immediately, EVACUATE AND CALL THE FIRE DEPARTMENT.
- NEVER PICK UP A FLAMING PAN - You could be burned.
- DO NOT USE WATER, including wet rags or towels - a violent steam explosion will result.
- Use an extinguisher ONLY if:
  1. You know you have a CLASS ABC extinguisher, and you already know how to operate it.
  2. The fire is small and contained in the area where it started.
  3. The fire department is being called.
  4. You can fight the fire with your back to an exit.

### Burn Prevention

DO NOT TOUCH HEATING ELEMENTS OR INTERIOR SURFACES OF OVEN - Heating elements may be hot even though they are dark in color. Interior surfaces of an oven become hot enough to cause burns. During and after use, do not touch, or let clothing, potholders, or other flammable materials contact heating elements or interior surfaces of oven until they have had sufficient time to cool. Other surfaces of the appliance may become hot enough to cause burns. Among these surfaces are oven vent openings, surfaces near these openings and oven doors.

Exercise caution when opening the appliance. Standing to the side, open the door slowly and slightly to let hot air and/or steam escape. Keep your face clear of the opening and make sure there are no children or pets near the unit. After the release of hot air and/or steam, proceed with your cooking. Keep doors shut unless necessary for cooking or cleaning purposes. Do not leave open doors unattended.

Do not heat or warm unopened food containers. Build-up of pressure may cause the container to burst and cause injury.

Always place oven racks in desired location while oven is cool. If a rack must be moved while oven is hot, do not let potholder contact the heating elements.

Always use dry potholders. Moist or damp potholders on hot surfaces may result in burns from steam. Do not let potholder touch hot heating elements. Do not use a towel or other bulky cloth.

Secure all loose garments, etc. before beginning. Tie long hair so that it does not hang loose, and do not wear loose fitting clothing or hanging garments, such as ties, scarves, jewelry, or dangling sleeves.

### Child Safety

When children become old enough to use the appliance, it is the legal responsibility of the parents or legal guardians to ensure that they are instructed in safe operation of the appliance by qualified persons.



## Important Safety Instructions

READ AND SAVE THESE INSTRUCTIONS

Do not allow anyone to climb, stand, lean, sit, or hang on any part of an appliance, especially a door, warming drawer or storage drawer. This can damage the appliance, and the unit may tip over, potentially causing severe injury.

Do not allow children to use this appliance unless closely supervised by an adult. Children and pets should not be left alone or unattended in the area where the appliance is in use. They should never be allowed to play in its vicinity, whether or not the appliance is in use.

**CAUTION** - Items of interest to children should not be stored in an appliance, in cabinets above an appliance or on the backsplash. Children climbing on an appliance to reach items could be seriously injured.

### Cleaning Safety

Do not clean the appliance while it is still hot. Some cleaners produce noxious fumes when applied to a hot surface. Wet cloths or sponges can cause burns from steam.

**IMPORTANT SAFETY NOTICE:** The California Safe Drinking and Toxic Enforcement Act requires the Governor of California to publish a list of substances known to the state to cause cancer, birth defects or other reproductive harm, and requires businesses to warn customers of potential exposure to such substances. The burning of gas cooking fuel and the elimination of soil during self-cleaning can generate small amounts of Carbon Monoxide. The fiberglass insulation in self-clean ovens gives off very small amounts of formaldehyde during the first several cleaning cycles. California lists formaldehyde as a potential cause of cancer. Carbon Monoxide is a potential cause of reproductive toxicity. Exposure to these substances can be minimized by:

1. Providing good ventilation when cooking with gas.
2. Providing good ventilation during and immediately after self-cleaning the oven.
3. Operating the unit according to the instructions in this manual.

When self-cleaning, confirm that the door locks and will not open. If the door does not lock, do not run Self-Clean. Contact service.

Wipe out excessive spillage before self-cleaning the oven.

Birds have very sensitive respiratory systems. Keep pet birds out of the kitchen or other rooms where kitchen fumes could reach them. During self-clean, fumes are released that may be harmful to birds. Other kitchen fumes such as overheating margarines and cooking oils may also be harmful.

Keep oven free from grease build up.

### Cookware Safety

Do not place food directly on oven bottom.

Follow the manufacturer's directions when using cooking or roasting bags.

Do not clean parts or accessories in the self-clean oven.



# Getting Started

## Parts and Accessories

### Parts\*

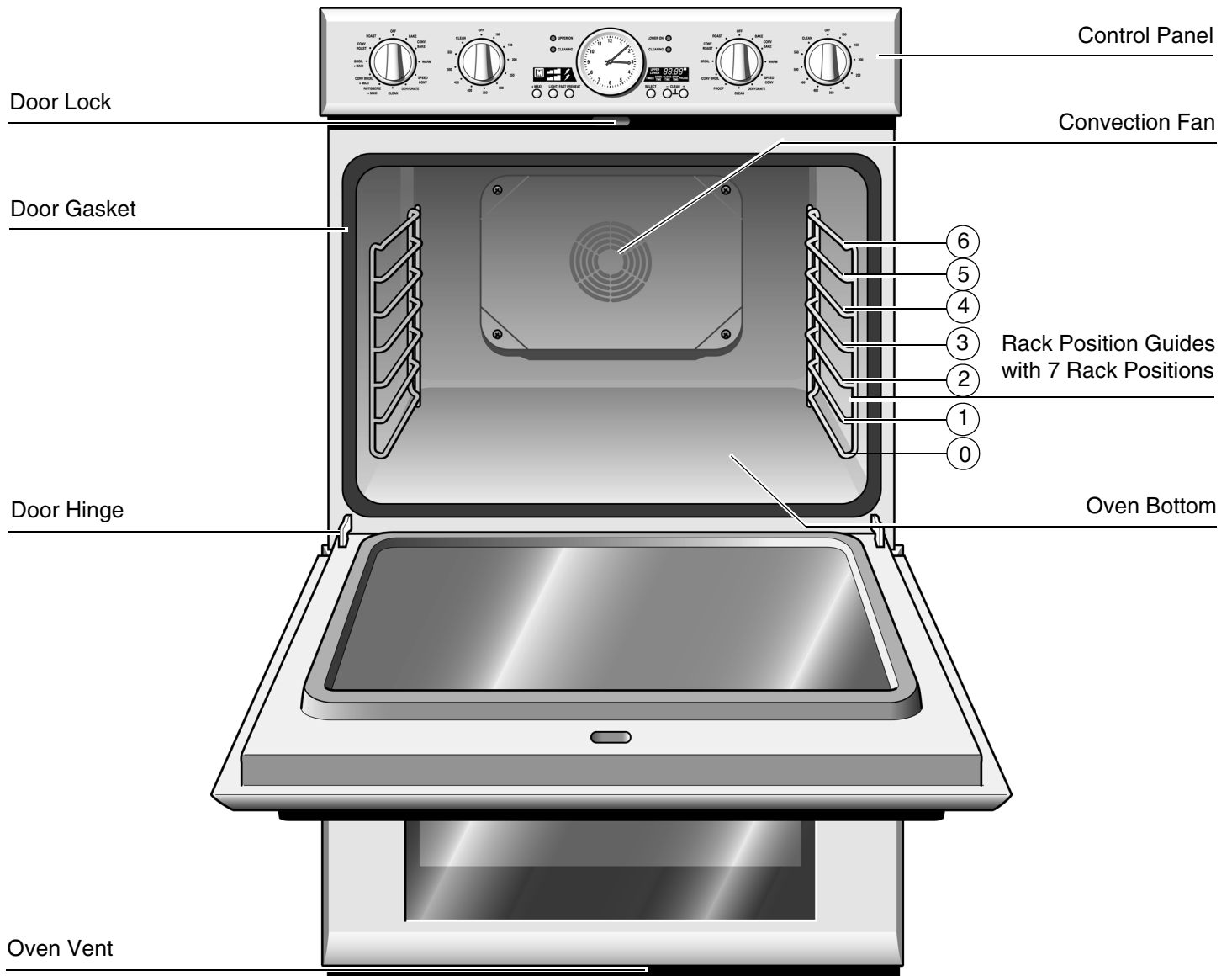

\*Picture shows double oven. Your appliance may vary slightly.

### Cooling Fan

The cooling fan runs during all cooking modes. The fan can be heard when it is running, and warm air may be felt as it is released from the oven vent. The fan may also run after the oven is off.

### Oven Vent

The oven vent is located at the bottom of the unit. Warm air may be released from the vent before, during and after cooking. It is normal to see steam escaping from the vent, and condensation may collect in this area. This area may be warm when the oven is in use. Do not block the vent, since it is important for air circulation.

## Convection Fan

The convection fan operates during all convection modes. When the oven is operating in a convection mode, the fan turns off automatically when the door is opened. The convection fan may also run during self-clean.



## Oven Bottom

The oven bottom conceals the lower heating element. As a result the element is protected from damage and spills.

**Note:** Do not place food directly on the oven bottom.

	<p><b>Warning:</b></p> <p>Do not use aluminum foil or protective liners to line any part of the appliance, especially the oven bottom. Installation of these liners may result in a risk of electric shock or fire.</p>
---	---

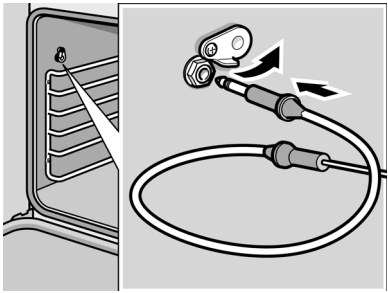
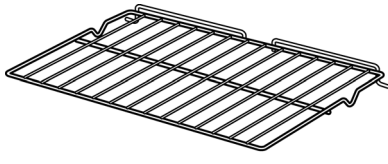
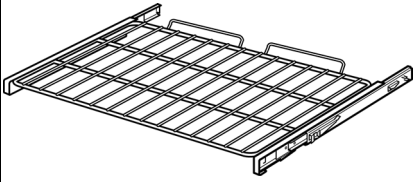
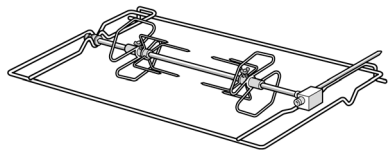
## Accessories

	<p><b>Probe</b></p> <p>The probe can be used to determine the internal doneness or the end temperature of many foods, especially meats and poultry.</p>
	<p><b>Flat Rack</b></p> <p>Do not clean in the self-clean oven.</p>
	<p><b>Telescopic Rack</b></p> <p>This rack allows for easier access when inserting or removing food. Do not clean in the self-clean oven.</p>
	<p><b>Rotisserie</b></p> <p>Use this accessory when using the rotisserie mode. See "Rotisserie" under "Getting the Most Out of Your Appliance" for additional information. Do not clean in the self-clean oven.</p>
	<p><b>Broil Pan and Grid</b></p> <p>Use for broiling and roasting. Do not clean in the self-clean oven.</p>

# Inserting Rack

## Flat Rack

The rack is designed with a stop so it will stop before coming completely out of the oven and not tilt.



### Caution:

To avoid burns, place oven racks in desired positions before turning oven on. Always use oven mitts when the oven is warm. If a rack must be moved while the oven is hot, do not let oven mitts contact hot heating elements.

### Inserting Rack into Oven:

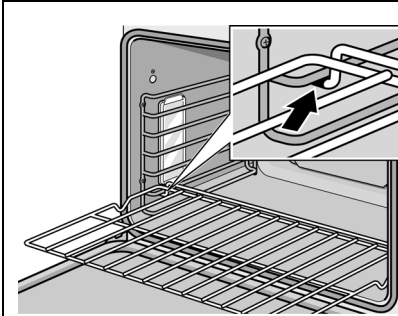

1. Grasp rack firmly on both sides.
2. Insert rack (see picture).
3. Tilt rack up to allow stop into rack guide.
4. Bring rack to a horizontal position and push the rest of the way in. Rack should be straight and flat, not crooked.

### Removing Rack from Oven:

1. Grasp rack firmly on both sides and pull rack toward you.
2. When the stop is reached, tilt rack up and pull the rest of the way out.

## Telescopic Rack



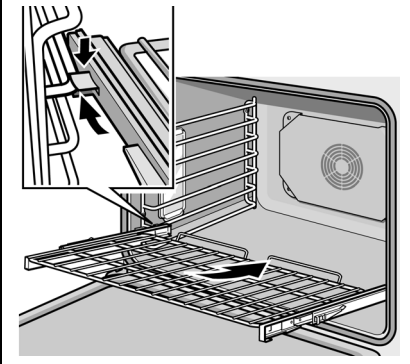
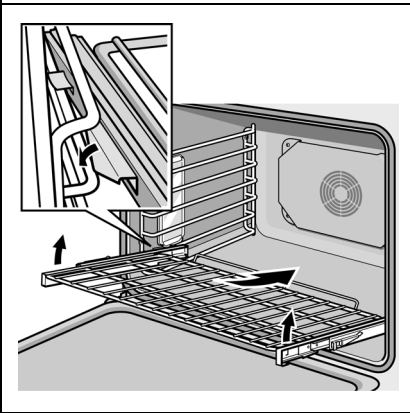
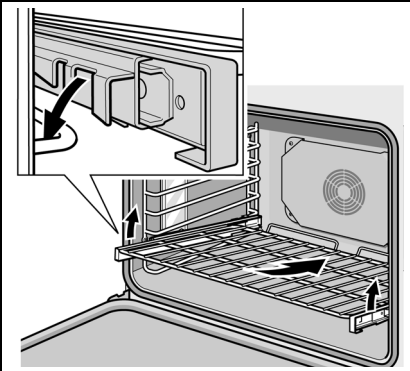

### Inserting telescopic rack into oven:

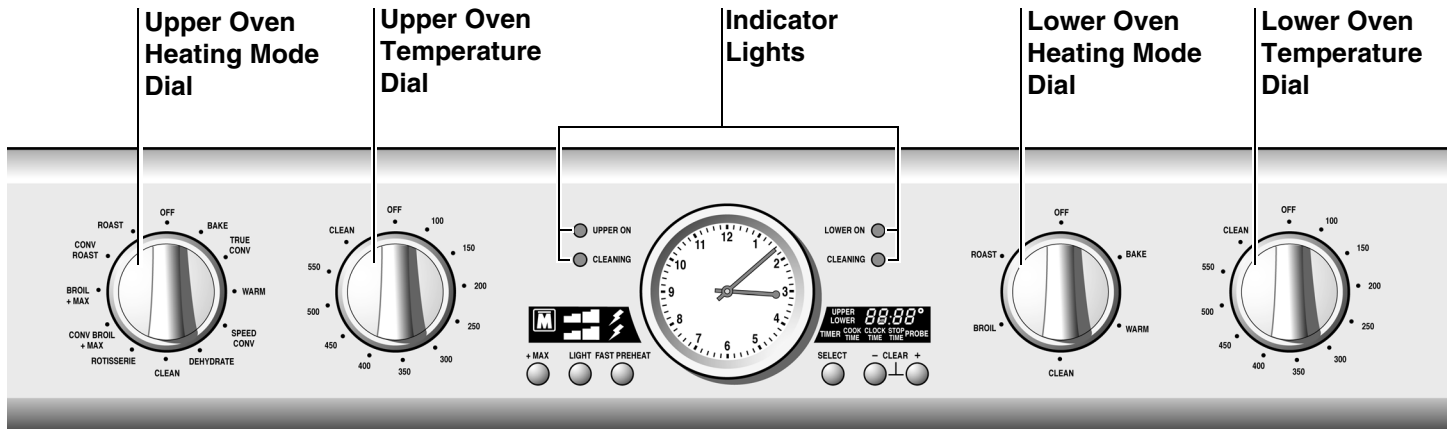
	<ol style="list-style-type: none"><li>1. Hold the rack on a slight angle.</li></ol>
	<ol style="list-style-type: none"><li>2. Engage the rear hooks in the accessory brackets.</li><li>3. Hold the rack straight.</li><li>4. Push the rack in until it is even with the front hooks.</li></ol>
	<ol style="list-style-type: none"><li>5. Lift the rack up.</li><li>6. Push the rack in completely.</li><li>7. Engage the rack's front hooks in the accessory brackets.</li></ol>



# Control\*



## Buttons

<p><b>+MAX</b></p> 	<p>Turns on Max Cook. This feature increases the heating area of the upper heating element. Available for the upper oven in Broil and Convection Broil.</p>
<p><b>LIGHT</b></p> 	<p>Turns oven light on or off. Not possible in self-clean mode.</p>
<p><b>FAST PREHEAT</b></p> 	<p>Turns Fast Preheat on and off. Available in Bake, True Convection, Roast and Convection Roast modes.</p>
<p><b>SELECT</b></p> 	<p>Calls up menu items: Timer, Cook Time, Clock Time, Stop Time, Clock and Probe.</p>
<p><b>- CLEAR +</b></p> 	<p>Increases (+) and decreases (-) setting values. Pressing + and - simultaneously: The current displayed setting is cleared.</p>

## Display Icons

	<p>Max Cook is on when this icon is lit.</p>
	<p>The preheat monitor consists of four bars. Only the first bar is visible when the oven is cold. The display fills with bars while the oven is preheating. All four bars are visible when the set temperature is reached.</p>
	<p>Fast Preheat is on when this icon is lit.</p>

\*Picture shows double oven control panel. Your control panel may vary slightly.

# Before Using the Oven for the First Time

- Oven must be properly installed by a qualified technician before use.
- Remove all packing materials from inside and outside the oven.
- While cool, wipe with a clean, damp cloth and dry.
- There may be a slight odor during first uses; this is normal and will disappear.
- Optimum cooking results depend on proper cookware being used.
- Read and understand all safety precautions and Use and Care Manual information prior to operating.

---

# Operation

## About the Appliance

Thermador Professional combines timeless design, modern technology and premium operating convenience.

The classic design of Thermador has made it a symbol of the perfect American kitchen for over 70 years. Our ovens today lead the way in continuing this tradition.

Behind the classic design is modern and perfected technology that ensures a high degree of efficiency. For instance, we have further improved the distribution of heat in the oven by using newly designed elements. The advantage of this results in shorter cooking times, perfect results and lower energy costs.

The oven also includes features that fulfill all of your needs. The rotisserie makes food crisp on all sides. The probe can be used to determine the internal doneness of food, especially meat and poultry. Similarly, the broil pan and grid included with the oven offer the flexibility you need when cooking, since they can be used to hold food, collect fat or provide a supporting surface.

This oven is very convenient and easy to operate, even with the wide variety of options. The cooking mode and temperature can be adjusted with very little effort. The additional functions such as Fast Preheat, Cook Time and Sabbath Mode can be set at the touch of a button in just a few seconds, and the display always presents the most important information while you are cooking.

## Basic Features

### Setting the Clock

To set the clock, no Stop Time can be active.

#### To set the analog clock:

1. Press SELECT repeatedly until "CLOCK" appears in the display.
2. Press and hold "+" until the desired time is reached.

The time is accepted after a few seconds and the clock starts running. "CLOCK" disappears from the display.

### Setting the Cooking Mode and Temperature

#### To set the cooking mode and temperature:

1. Turn the heating mode dial to the preferred cooking mode.
2. Turn the temperature dial to the desired temperature.

The light next to "OVEN ON" ("UPPER ON"/"LOWER ON" for double ovens) illuminates as soon as a valid cooking mode temperature has been selected.

#### Preheat monitor:

The preheat monitor fills with bars while the oven heats up. All of the four bars are visible and a beep sounds when the programmed temperature is reached.

#### Note:

- The cooking mode temperature ranges are limited. The oven will not start if an invalid temperature is set. A beep sounds and "Err" appears in the display.
- For double oven models: if Speed Convection is set for one oven, the other oven cannot run at the same time.

## Heating Time Limitation

The maximum heating time is limited. If you forget to turn off the oven, it turns off automatically after a set period of time (see table below), unless using Cook Time. The maximum time allowed for Dehydrate mode is 48 hours. The maximum time for Sabbath mode is 74 hours. For all other cooking modes, the maximum time allowed depends on the temperature:

Temperature in °F	Max. time allowed without activity
100 - 200	24 h
201 - 550	12 h

Heating stops until a setting is changed.

## Timer

### To set the timer:

1. Press SELECT.

"TIMER" and the flashing numbers 0:00 appear in the display:



2. Use the "+" and "-" buttons to set the amount of time.

The numbers stop flashing after a few seconds and the timer starts.

A beep sounds when the timer ends. Press any button or open the door to cancel the beep and timer.

### To change a running timer:

1. Press SELECT.

The numbers flash.

2. Set the new time using the "+" and "-" buttons.

The numbers stop flashing after a few seconds and the timer starts.

### Note:

- To clear the programmed time, press "+" and "-" at the same time.
- The timer can be set for a maximum of 12 hours.



## Fast Preheat

Fast Preheat heats the oven quicker than standard preheat. It is available for Bake, Roast, Convection Roast and True Convection modes.

### To set Fast Preheat:

1. Set the cooking mode and temperature.
2. Press FAST PREHEAT.

The flash icon appears in the display:



Fast Preheat stays on until all preheat monitor bars are visible. Then the flash icon disappears.

### Note:

- To use Fast Preheat, the temperature must be set to at least 200 °F.
- Fast Preheat can also be activated when the oven is already operating and the programmed temperature has not yet been reached.
- Fast Preheat remains on even if you switch to a different cooking mode after starting Fast Preheat. If Fast Preheat is not available for the new mode, standard preheat is activated and the flash symbol disappears.

## Max Cook

The Max feature increases the area heated by the upper element. Use the Max feature to prepare large amounts of food at the same time. For best results, use the broil pan included with the appliance.

Max Cook is available for the upper oven in Broil and Convection Broil.

Press +MAX to turn Max Cook on and off.

# Special Features

The special features provide you with additional conveniences when cooking. Learn more about these special features in the following sections:

- Cook Time
- Stop Time
- Sabbath Mode
- Probe
- Temperature Offset

## Cook Time

Use the Cook Time feature to operate the cooking mode for a set period of time. The oven starts immediately and then turns off automatically when the set time is up.

	<b>Caution:</b>
To maintain food safety, do not leave food in the oven for more than one hour before or after cooking.	

### To set the Cook Time:

1. Set the cooking mode and temperature.
2. Press SELECT twice (in double ovens, the upper oven is now selected. Press one more time to select the lower oven).

"COOK TIME" and the flashing numbers 0:00 appear in the display. For double ovens, "UPPER" or "LOWER" is displayed for the active oven.

3. Use the "+" and "-" buttons to set the Cook Time.

Example: Cook Time is set for 1:30 hours:



The numbers stop flashing after a few seconds and Cook Time starts.

The oven turns off and a beep sounds at the end of the programmed time.

"End" appears in the display.

To increase the programmed Cook Time, press SELECT and program a new time.

Press "+" and "-" simultaneously, or open the oven door to clear.

### Note:

- Cook Time cannot be used if a temperature probe is in use.
- The maximum Cook Time setting is 12 hours.
- Use SELECT to display other functions such as the Timer or Stop Time during Cook Time.

## Stop Time

Use STOP TIME to delay the start of a timed mode. Enter the desired time for the mode to end. The oven calculates the proper start time. It starts and stops automatically.

	<b>Caution:</b>
	To maintain food safety, do not leave food in the oven for more than one hour before or after cooking.

**Note:** a separate digital clock must be set before starting Stop Time. This is indicated by "CLOCK TIME" in the display.

### To set the Clock Time and Stop Time:

1. Set the Cook Time as described in "Cook Time".
2. Press SELECT.  
"CLOCK TIME" and the flashing Clock Time numbers appear in the display.
3. Use the "+" and "-" buttons to set the Clock Time (sets the current time of the day).
4. Press SELECT.  
"CLOCK TIME" disappears and "STOP TIME" appears.
5. Use the "+" and "-" buttons to set the Stop Time.

Example: Stop Time is at 12:00:

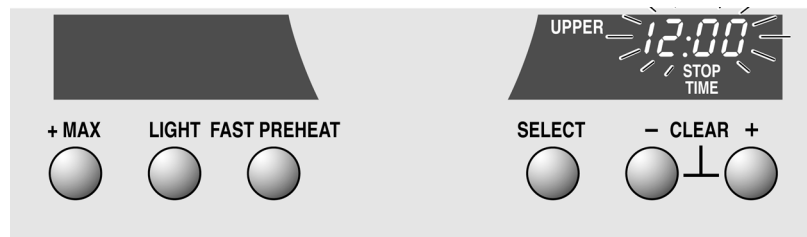

The numbers stop flashing after a few seconds and the oven enters delayed mode. The oven turns on when it is time to start.

The oven turns off and a beep sounds at the end of the programmed time. Press "+" and "-" simultaneously, or open the oven door to clear.

### Note:

- Stop Time cannot be used if a temperature probe is in use.
- The maximum Stop Time is 11:59 hours.

## Sabbath Mode

Sabbath Mode is for religious faiths with "no work" requirements on the Sabbath. In Sabbath Mode, the oven continues to operate for a maximum of 74 hours.

### To set Sabbath Mode:

1. Turn the heating mode dial to "BAKE".
2. Set the temperature (100 °F - 450 °F).
3. Press and hold "+" for four seconds.

"SAb" appears in the display during Sabbath Mode:

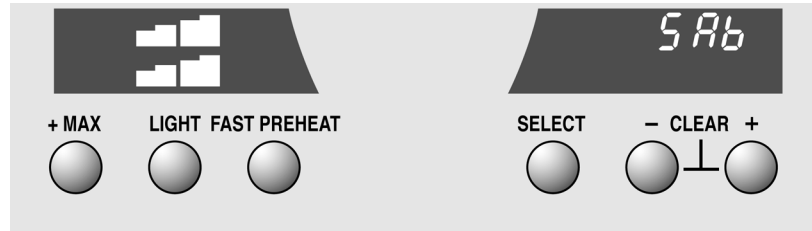

### Note:

- Turn the heating mode dial to "OFF" to cancel Sabbath Mode.
- For double oven models: if the second oven is turned on while the first oven is in Sabbath Mode, both ovens switch to normal operation.
- For double oven models: to set both ovens to Sabbath Mode, first set the "BAKE" cooking mode and the temperature for both ovens. Then press and hold "+" for four seconds.

## Probe

The probe measures the internal temperature of the food. The probe is available for Bake, Roast and all convection cooking modes except Convection Broil.

### Positioning the probe:

Insert the tip of the probe where the least amount of heat penetrates the meat. The best location is in the middle and thickest part of the meat. Make sure the probe is not touching fat, bone, parts of the oven or pan.

### To use the probe:

1. Insert the probe into the meat as described above.
2. Set the cooking mode and temperature.
3. Connect the probe to the oven.

**Note:** to prevent burns, do not attempt to insert the probe in a hot oven. "PROBE" and the default temperature of 160 °F appear in the display:

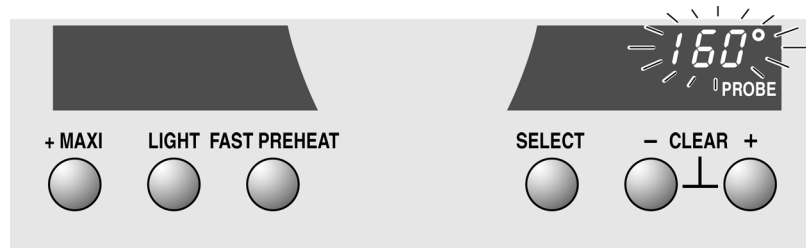

4. Use the "+" and "-" buttons to set the probe temperature. See Cooking Charts for appropriate probe temperatures.

The display stops flashing after a few seconds and the programmed setting is accepted. The display switches between the current and programmed probe temperature as soon as the probe reached 100 °F.

The oven turns off and a beep sounds once the programmed probe temperature is reached. The probe icon disappears when the probe is removed.

### Note:

- Probe is not available when Cook Time has been set.
- The range for the probe temperature is between 135 °F and 200 °F.
- In double oven models the probe is only available for the upper oven .

## Temperature Offset

This feature is useful if food is consistently either too brown or too light. When an offset value is selected, the actual oven temperature in Bake, True Convection, Roast, Convection Roast and Speed Convection is raised or lowered by this value.

**Note:** the oven must be turned off in order to set an offset value.

### To change the oven temperature offset:

1. **Single oven:** Press and hold FAST PREHEAT and "+" simultaneously for 3 seconds.

**Double oven:** Press and hold FAST PREHEAT and "+" simultaneously for 3 seconds to select the upper oven.

Press and hold FAST PREHEAT and "-" simultaneously for 3 seconds to select the lower oven.

2. Use "+" and "-" to set the desired value.

---

# Getting the Most Out of Your Appliance

## General Tips

### Pan Placement

Baking results are better if pans are placed in the center of the oven. If baking more than one pan on a rack, allow at least 1" to 1 ½" of air space around the pan. When baking four cake layers at the same time, stagger pans on two racks so that one pan is not directly above the other.

### Aluminum Foil

Do not use aluminum foil or protective liners to line any part of the appliance, especially the oven bottom. Installing these liners may result in risk of electric shock or fire.

### Preheating the Oven

- Place oven racks in desired position before heating the oven.
- Preheat the oven when using the (Max) Broil, (Max) Convection Broil, Bake and True Convection modes.
- Preheat is not used for Speed Convection.
- Allow oven to preheat while preparing recipe ingredients or food items.
- Setting a higher temperature does not shorten preheat time.
- Once oven is preheated, place food in the oven as quickly as possible to minimize the loss of heat and reduction of oven temperature.
- Use Fast Preheat to speed up preheating.

### For Best Results

- Use the cooking recommendations as a guide.
- Open the door as briefly as possible to avoid temperature reduction.
- Use the interior oven light to view the food through the oven window rather than opening the door frequently.
- Use the Timer to keep track of cooking times.

### Baking Pans and Dishes

- Glass baking dishes absorb heat. Follow manufacturers' recommendations.
- For tender, light, golden brown crusts, use light, shiny metal bakeware.
- Dark, rough or dull pans (nonstick or anodized) will absorb heat and result in a browner, crisper crust. Some manufacturers recommend reducing the temperature 25 °F when using this type of pan. Follow manufacturers' recommendations.
- Insulated cookie sheets or bakeware may increase the length of cooking time.
- Do not set broil pans or any other heavy object on the open oven door.
- Do not keep the empty broil pan in the oven during cooking as this changes cooking performance. Store the broil pan outside the oven.

### High Altitude Baking

- When cooking at high altitudes, recipes and cooking times will vary. For accurate information, write the Extension Service, Colorado State University, Fort Collins, Colorado 80521. There may be a cost for the guides. Specify which high altitude food preparation guide you prefer: general information, cakes, cookies, breads, etc.

### Condensation

- It is normal for certain amount of moisture to evaporate from the food during any cooking process. The amount depends on the moisture content of the food. The moisture may condense on any surface cooler than the inside of the oven, such as the control panel.

# Bake

r	<b>Bake</b> is cooking with dry, heated air. Both the upper and lower elements cycle to maintain the oven temperature.
---	--

The Bake mode can be used to prepare a variety of food items, from pastries to casseroles. Refer to recipe or package directions for oven temperature and baking time.

## Tips

- Preheat the oven if the recipe recommends it.
- Baking time will vary with the size, shape and finish of the bakeware. Dark metal pans or nonstick coatings will cook faster with darker results. Insulated bakeware will lengthen the cook time for most foods.
- For best results, bake food on a single rack with at least 1-1 $\frac{1}{2}$ " space between pans or dishes and oven walls.
- Eliminate heat loss from the oven by using the window to periodically check food for doneness instead of opening the door.
- If multiple racks are necessary, use a maximum of 2 racks. For cakes use rack positions 3 and 5, for cookies use rack positions 2 and 5. Stagger pans so that one is not directly above the other (see graphic below). See "Pan Placement" under "General Tips" for more info. You may also consider using a convection mode.

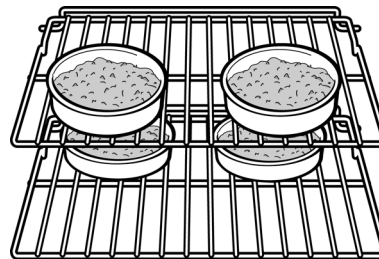

# True Convection



**True Convection** cooks with heat from a third element behind the back wall of the oven. The heat is circulated throughout the oven by the convection fan.

True Convection is well suited for cooking individual serving-sized foods such as cookies and biscuits. It is also good for cooking on multiple racks (2 or 3) at the same time. Baking cookies is possible on 6 racks simultaneously. In this case, the baking time increases slightly. The benefits of True Convection include:

- Even browning.
- Time savings as a result of using multiple racks at one time.
- Reduce recipe temperature by 25 °F. Refer to True Convection chart.
- Place food in low-sided, uncovered pans such as cookie sheets without sides.
- If baking more than one pan on a rack, allow at least 1" to 1 ½" of air space around the pan.
- For cakes use rack positions 2 and 5 (see graphic below).

## Tips

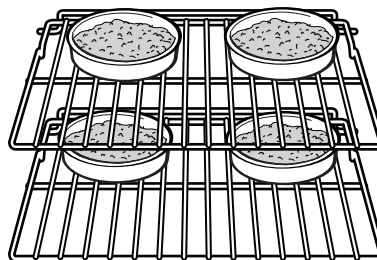

## True Convection Chart

Food Item	Rack Position			Temp.	Time
	1 rack	2 racks	3 racks		
<b>Cakes</b>					
Cupcakes	4	2+5	1+3+5	325	17-27
Bundt Cake	2			300	45-65
Angel Food	1			325	35-50
Layers (8" or 9")	3	2+5		325	25-40
Rectangle (9x13)	2			350	45-60
<b>Pie</b>					
2 Crust, fresh, 9"	2			350	45-60
2 Crust, frozen fruit, 9"	2			350	65-85
Meringue Topping Pie	2			350	15-20
Nut Pie	2			350	45-60
Custard	2			425 350	12-15 38-50
<b>Cookies</b>					
Sugar	3	2+5	1+3+5	350	6-10
Chocolate Chip	3	2+5	1+3+5	325	8-17
<b>Bar Cookies</b>					
Lemon	3			350	23-33
Brownie	3			325	33-40



Food Item	Rack Position			Temp.	Time
	1 rack	2 racks	3 racks		
<b>Breads</b>					
Yeast Bread, loaf, 9x5	2			400	22-35
Dinner Rolls	3	1+4	1+3+5	350	10-20
Quick Bread, loaf, 8x4	2			350	45-65
Biscuits	2	2+5	1+3+5	325	10-20
Muffins	3	2+5	1+3+5	400	14-25
<b>Cream Puffs</b>					
Fresh	3	2+5	1+3+5	400	23-33
<b>Pizza</b>					
Frozen	3			375	18-25
Fresh	3			400	15-20

## Roast

r	<p><b>Roast</b> uses both the upper and lower elements to maintain the oven temperature. Roasting uses more intense heat from the upper element than the lower element. This results in more browning of the exterior while the inside remains especially moist.</p>
---	--

Roast is best suited for large cuts of meat and poultry.

### Tips

- Use a high-sided broil pan, or cover dish with a lid or foil.
- Add liquids, such as water, juice, wine, bouillon or stock for flavor and moisture.
- Roasting bags are suitable for use in this mode.
- When roasting whole chicken or turkey, tuck wings behind back and loosely tie legs with kitchen string.

## Convection Roast

	<p><b>Convection Roast</b> uses heat from the top and bottom elements as well as heat circulated by the convection fan.</p>
---	---

The Convection Roast mode is well suited for preparing tender cuts of meat and poultry.

The benefits of Convection Roast mode include:

- As much as 25% faster cooking than non-convection modes.
- Rich, golden browning.
- Use the same temperature as indicated in the recipe.
- Check doneness early, since roasting time may decrease. Refer to Convection Roast chart for examples.
- Do not cover meat or use cooking bags.
- Use the broil pan and grid provided with the oven for roasting. A shallow, uncovered pan can also be used.
- Use a meat thermometer to determine the internal temperature of the meat.
- If the meat is browned to your liking, but is not yet done, a small strip of foil can be placed over the meat to prevent overbrowning.
- Let meat stand covered with foil 10-15 minutes after removing it from the oven.
- Refer to chart for recommended rack positions.

### Tips

## Convection Roast Chart

Food Item	Rack Pos.	Weight	Oven Temp.	Time (min/lb)*	Internal Temp.
<b>Beef</b>					
Rib Eye Roast (boneless)					
Medium rare	2	3.0-5.5	325	27-31	145
Medium	2	3.0-5.5	325	30-38	160
Rump, eye, tip, sirloin (boneless)					
Medium rare	2	3.0-6.0	325	18-33	145
Medium	2	3.0-6.0	325	30-35	160
<b>Pork</b>					
Tenderloin Roast (medium rare)	2	2.0-3.0	425	15-24	145
Loin Roast (boneless or bone in)	2	1.5-3.0	350	19-36	160
Loin Roast (boneless or bone in)	2	3.0-6.0	350	14-21	160
Tenderloin	2	2.0-3.0	425	21-28	160
<b>Poultry</b>					
Chicken, whole	2	3.5-8.0	375	13-20	180
Turkey, unstuffed**	1	12-15	325	10-14	180
Turkey, unstuffed**	1	16-20	325	9-13	180
Turkey, unstuffed**	1	21-25	325	6-12	180
Turkey Breast	2	4.0-8.0	325	19-23	170
Cornish Hen	2	1.0-1.5	350	45-75 (total time)	180
<b>Lamb</b>					
Leg, boneless					
Medium	2	4.0-6.0	325	30-35	170

\*Roasting times are approximate and may vary depending on shape of the meat.

\*\*Stuffed turkey requires additional roasting time. The minimum safe temperature for stuffing in poultry is 165 °F.

# Broil/Max Broil

W	<p><b>Broil</b> uses intense heat radiated from the upper element.</p> <p><b>Max Broil</b> uses a larger broil element which allows you to broil more food at one time. See "Max Cook" in "Basic Features" for more information.</p>
---	--

The Broil mode is best suited for cooking thin, tender cuts of meat (1" or less), poultry and fish. It can also be used to brown breads and casseroles. Always broil with the door closed.

To use the broil pan and grid:

- For normal Broil: food should be placed in the center of the broil pan and grid.
- For Max Broil: food should be spread out over the entire broil pan and grid.

The benefits of broiling include:

- Fast and efficient cooking.
- Cooking without the addition of fats or liquids.
- Preheat oven 3-4 minutes. Do not preheat for more than 5 minutes.
- Steaks and chops should be at least ¾" thick.
- Brush fish and poultry with butter or oil to prevent sticking.
- Use the broil pan and grid included with the oven.
- Do not cover the broil grid with foil. It is designed to drain fats and oils away from the cooking surface to prevent smoking and spattering.
- Turn meats once during the recommended cook time (see Broil Chart for examples).
- When top browning casseroles, use only metal or glass ceramic dishes such as Corningware®.
- Never use heat-proof glass (Pyrex®); it cannot tolerate the high temperature.

## Tips

## Broil/Max Broil Chart

Food Item	Rack Pos.	Broil Setting (°F)	Internal Temp.	Time side 1*	Time side 2*
<b>Beef</b>					
Steak, ¾" to 1"					
Medium Rare	6	550	145	5-7	4-6
Medium	5	550	160	8-9	5-7
Well	5	550	170	10-11	7-9
Hamburger, ¾" to 1"					
Medium	6	550	160	5-8	4-6
<b>Poultry</b>					
Chicken Thighs	3	450	180	14-15	12-13
<b>Pork</b>					
Pork Chops, 1"	4	500	160	8-10	8-9
Sausage - fresh	4	550	160	3-5	2-4
Ham Slice, ½"	5	550	160	4-5	3-4
<b>Seafood</b>					
Fish Filets, ¾" to 1" buttered	3	450	145	11-15	Do not turn

Food Item	Rack Pos.	Broil Setting (°F)	Internal Temp.	Time side 1*	Time side 2*
<b>Lamb</b>					
Chops, 1"					
Medium Rare	4	550	145	4-6	4-5
Medium	4	550	160	5-7	5-6
Well	4	550	170	6-8	6-7

\*Broiling times are approximate and may vary slightly. Times are based on cooking with a preheated broil element.

## Convection Broil/Max Convection Broil

	<p><b>Convection Broil</b> is similar to Broil. It combines intense heat from the upper element with heat circulated by a convection fan.</p> <p><b>Max Convection Broil</b> uses a larger broil element which allows you to broil more food at one time.</p>
---	---

Convection Broil mode is well suited for cooking thick, tender cuts of meat, poultry and fish. Convection Broil is not recommended for browning breads, casseroles and other foods. Always use Convection Broil with the door closed.

In addition to the benefits of standard broiling, convection broiling is faster.

To use the broil pan:

- For normal Convection Broil: food should be placed in the center of the broil pan and grid.
- For Max Convection Broil: food should be spread out over the entire broil pan and grid.
- Preheat oven 3-4 minutes. Do not preheat for more than 5 minutes.
- Steaks and Chops should be at least 1½" thick.
- Use the broil pan and grid included with your oven.
- Do not cover the broil grid with foil. It is designed to drain fats and oils away from the cooking surface to prevent smoking and spattering.
- Turn meats once during the recommended cook time (see Convection Broil Chart for examples).
- Never use heat-proof glass (Pyrex®); it cannot tolerate the high temperature.

### Tips

## Convection Broil/Max Convection Broil Chart

Food Item	Rack Pos.	Broil Setting (°F)	Internal Temp.	Time side 1*	Time side 2*
<b>Beef</b>					
Steak, 1½" or more					
Medium Rare	3	550	145	11-13	9-11
Medium	3	550	160	13-15	11-13
Well	3	550	170	15-17	13-15
Hamburger, 1" or more					
Medium	4	550	160	11-14	8-11
<b>Poultry</b>					
Chicken Breast	3	450	170	18-20	17-19

Food Item	Rack Pos.	Broil Setting (°F)	Internal Temp.	Time side 1*	Time side 2*
<b>Pork</b>					
Pork Chops, 1¼"	4	550	160	9-11	8-10
Sausage - fresh	4	550	180	5-7	3-5

\*Convection broiling times are approximate and may vary slightly. Times are based on cooking with a preheated broil element.

## Speed Convection



**Speed Convection** uses all heating elements as well as the convection fan to evenly distribute heat throughout the oven cavity. The main difference between speed convection and other convection modes is that it does not require preheating.

Speed Convection is well suited for frozen convenience foods such as fish sticks and chicken nuggets. The benefits of Speed Convection include:

- Decrease in cook time since preheating is not necessary.
- Crispy and evenly browned frozen foods.
- Begin cooking all frozen convenience products in a cold, non-preheated oven. The food will still be done in package time.
- Follow package instructions for time and temperature.
- Flipping of food halfway through recommended cook time is not necessary.
- Frozen foods that are sold in microwaveable plastic containers should not be used in this mode.
- Cook food items on rack position 3 unless directed otherwise by the product manufacturer.
- If baking more than one product simultaneously, use rack positions 2 and 5.
- Evenly space food items on pan.
- For double ovens, only one cavity is available when using Speed Convection.

### Tips

## Speed Convection Chart

Food Item	Rack Position	Temp.	Time
<b>Frozen Food</b>			
Pizza Bites	3	450	9-11
Fish Sticks	3	475	10-14
Onion Rings	3	425	14-16
French Toast Sticks	3	450	7-11
Turnovers	3	400	19-26
Filled Pockets	3	350	27-31
Chicken Nuggets	3	400	9-13
Garlic Bread	3	450	7-11
Shoestring Fries	3	450	11-16

# Warm



In **Warm**, the upper and lower elements maintain a low temperature in the oven cavity in order to keep food at serving temperature.

- Use the Warm mode to keep cooked foods hot until ready to serve.
- Warm mode temperatures are 150 °F - 225 °F.
- Foods that must be kept moist should be covered with a lid or aluminum foil.



## Caution:

When using Warm mode, follow these guidelines:

- Do not use the Warm mode to heat cold food.
- Be sure to maintain proper food temperature. The USDA recommends holding hot food at 140 °F or warmer.
- DO NOT warm food longer than one hour.

# Dehydrate



**Dehydrate** dries with heat from a third element behind the back wall of the oven. The heat is circulated throughout the oven by the convection fan.

Use Dehydrate to dry and/or preserve foods such as fruits, vegetables and herbs. This mode holds an optimum low temperature (100 °F - 175 °F) while circulating the heated air to slowly remove moisture. The oven stays on for 48 hours before shutting off automatically.

## Tips

- Dry most fruits and vegetables at 150 °F. Dry herbs at 100 °F (refer to the Dehydrate Chart for examples).
- Drying times vary depending on the moisture and sugar content of the food, the size of the pieces, the amount being dried and the humidity in the air. Check food at the minimum drying time.
- Multiple drying racks (not included) can be used simultaneously.
- Treat fruits with antioxidants to avoid discoloration.
- Consult a food preservation book, county Cooperative Extension Office or library for additional information.

## Dehydrate Chart

Food Item	Preparation	Approx. drying time (hrs)	Test for done-ness
<b>Fruit</b>			
Apples	Dipped in ¼ cup lemon juice and 2 cups water, ¼" slices.	11-15	Slightly pliable.
Bananas	Dipped in ¼ cup lemon juice and 2 cups water, ¼" slices.	11-15	Slightly pliable.
Cherries	Wash and towel dry. For fresh cherries, remove pits.	10-15	Pliable leathery, chewy.
Orange peels	Orange part of skin thinly peeled from oranges.	2-4	Dry and brittle.
Orange slices	¼" slices of orange.	12-16	Skins are dry and brittle, fruit is slightly moist.
Pineapple rings canned	Towel dried.	9-13	Soft and pliable.
fresh	Towel dried.	8-12	Soft and pliable.
Strawberries	Wash and towel dry. Sliced ½" thick, skin (outside) down on rack.	12-17	Dry and brittle.
<b>Vegetables</b>			
Peppers	Wash and towel dry. Remove membrane of peppers, coarsely chopped about 1" pieces.	15-17	Leathery with no moisture inside.
Mushrooms	Wash and towel dry. Cut off stem end. Cut into 1/8" slices.	7-12	Tough and leathery, dry.
Tomatoes	Wash and towel dry. Cut thin slices, 1/8" thick, drain well.	15-20	Dry, brick red color.

Food Item	Preparation	Approx. drying time (hrs)	Test for doneness
<b>Herbs</b> Oregano, Sage, Parsley, Thyme, Fennel	Rinse and dry with paper towel.	Dry at 100 °F 4-6 hours.	Crisp and brittle.
Basil	Use basil leaves 3 to 4 inches from the top. Spray with water, shake off moisture and pat dry.	Dry at 100 °F 4-6 hours.	Crisp and brittle.

## Rotisserie

	Rotisserie uses heat radiated from the upper element. The food is turned slowly on a skewer in the center of the oven. As a result, the food receives equal heat distribution on all sides.
---	---

The Rotisserie mode is best suited to cooking large pieces of meat (for example, a roast, a turkey or a chicken).

**Note:** the maximum weight allowed for the rotisserie is 12 lbs.

The benefits of Rotisserie cooking include:

- Sealed in flavor and juices.
- Cooking without the addition of fats or liquids.
- Use a meat thermometer to check the internal temperature of the meat.

Tip

## Rotisserie Chart

Food Item	Weight	Temp.	Time (min. per lbs)	Internal Temp.
<b>Beef</b>				
Rib Eye Roast				
Medium rare	3.0-5.5	400 °F	17-23	145
Medium	3.0-5.5	400 °F	18-27	160
Rib, boneless				
Medium rare	3.0-5.5	400 °F	17-22	145
Medium	3.0-5.5	400 °F	18-24	160
<b>Pork</b>				
Loin Roast, boneless	1.5-4.0	400 °F	20-26	160
<b>Poultry</b>				
Chicken whole	4.0-8.0	450 °F	12-17	180
Turkey whole	10.0-12.0	400 °F	10-12	180
Turkey Breast	4.0-6.0	400 °F	16-19	180
4 Cornish Hens	1.5 each	450 °F	60-70 min. total	180
<b>Lamb</b>				
Leg, boneless				
Medium	4.0-5.0	400 °F	20-23	160
Well	4.0-5.0	400 °F	27-29	170

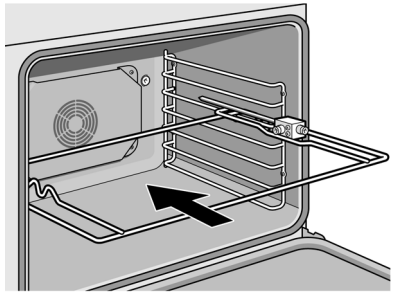
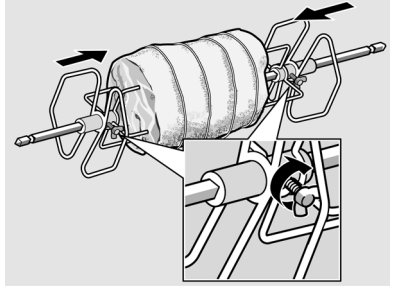
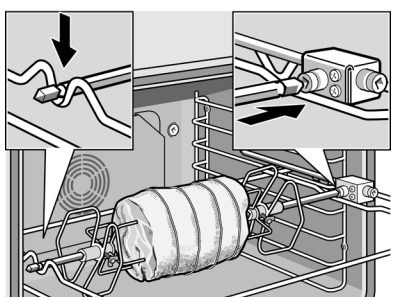
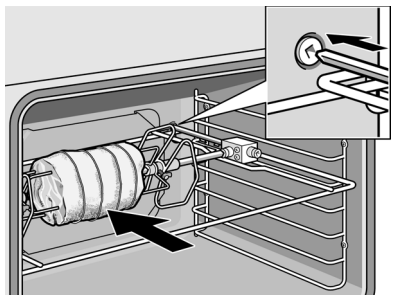

## Assembling the Rotisserie

	<ol style="list-style-type: none"> <li>1. Insert rotisserie rack half way into the oven on rack position 4.</li> </ol>
	<ol style="list-style-type: none"> <li>2. Slide the left fork onto the skewer and tighten the screw.</li> <li>3. Slide meat or poultry for roasting onto the skewer.</li> <li>4. Slide the right fork onto the skewer and tighten the screw.</li> <li>5. Check the balance of the food on the skewer by rolling the skewer in the palms of your hands. Food not evenly balanced will not cook evenly.</li> </ol>
	<ol style="list-style-type: none"> <li>6. Place the rotisserie skewer onto the rack.</li> </ol>
	<ol style="list-style-type: none"> <li>7. Place the skewer rack into the oven and insert the drive shaft into the opening on the back oven wall.</li> <li>8. If necessary, turn the rotisserie skewer slightly so that the drive shaft fits properly into the opening.</li> <li>9. Insert rack on position 0 and insert broil pan to catch drippings.</li> </ol>

## Trussing Poultry for the Rotisserie

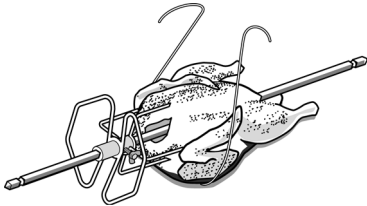
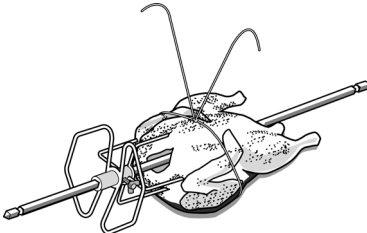
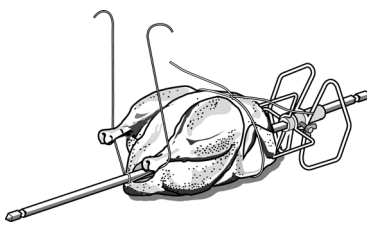
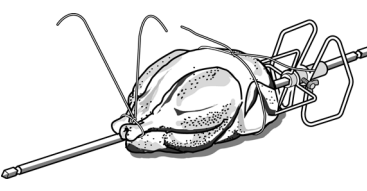
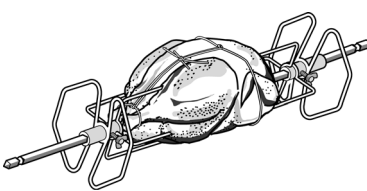
	<ol style="list-style-type: none"> <li>1. Slip one of the forks on the skewer with the tines pointing to the tip of the skewer. Loosely tighten the screw to keep it from slipping.</li> <li>2. Insert the skewer through the bird securing with the fork.</li> <li>3. Cut 24" of kitchen string and lay it under the bird, breast side up, with equal lengths of string on each side.</li> </ol>
	<ol style="list-style-type: none"> <li>4. Wrap each end of the string around each of the wings; catch each wing tip as the string is brought tightly together at the top and knotted. Do not cut off the extra string.</li> </ol>
	<ol style="list-style-type: none"> <li>5. Cut another 20" of string and lay it under the back. Wrap it around the tail then around the skewer. Cinch tightly.</li> </ol>
	<ol style="list-style-type: none"> <li>6. Pull legs forward; cross them on top of the skewer; bring string around and tie a tight knot.</li> </ol>
	<ol style="list-style-type: none"> <li>7. Connect the string holding the legs to the string holding the wings; then knot. Add the other fork and push tines into the drumsticks to secure.</li> <li>8. Check the balance by rolling the skewer in your palms. The bird should not rotate or be loose in any way. If so, redo the trussing. The bird will not cook evenly if it moves on the skewer.</li> </ol>

---

# Cleaning and Maintenance

## Cleaning

### Self-Clean

During Self-Clean, the oven is heated to a very high temperature. Soil is burned off at this temperature.

**ATTENTION:** Wipe out excessive spillage before self-cleaning the oven.

**ATTENTION:** Do not clean parts or accessories in the Self-Clean oven.

**To set the Self-Clean mode:**

1. Turn the heating mode dial to "CLEAN".
2. Turn the temperature dial to "CLEAN".
3. Set the cleaning time (1:30 to 2:30 hours) using "+" and "-".

Self-Clean starts after a few seconds and the oven is locked. The oven can be opened again only after the oven has cooled.

To cancel Self-Clean, turn the heating mode dial to "OFF" position.

A moist cloth is the best way to wipe remaining ash from the oven.

**Note:**

- For double oven models: while Self-Clean is in progress in one oven, the other oven must be off.
- The oven light cannot be turned on during self-cleaning.
- The special heat-resistant enamel and the polished components in the oven can become discolored over time. This is normal and does not affect operation. Under no circumstances should scouring pads or abrasive cleaners be used to treat discolorations.

### Avoid These Cleaners

Do not use commercial oven cleaners such as Easy Off®. They may damage the oven finish or parts.

Never use scouring pads or abrasive cleaners.

## Cleaning Guide

Part	Recommendations
Broil Pan and Grid	Wash with hot soapy water. Rinse thoroughly and dry, or gently rub with cleansing powder or soap-filled pads as directed. DO NOT clean broil pan and grid in the self-cleaning oven.
Rotisserie	Wash with hot soapy water. Rinse thoroughly and dry, or gently rub with cleansing powder or soap-filled pads as directed. Soak the forks and skewer in warm soapy water for maximum one hour. The food soil can then be easily removed. DO NOT clean rotisserie parts in the self-cleaning oven.
Flat Rack	Wash with hot soapy water. Rinse thoroughly and dry, or gently rub with cleansing powder or soap-filled pads as directed. DO NOT clean the rack in the self-cleaning oven.
Telescopic Rack	Wash with hot soapy water. Rinse thoroughly and dry, or gently rub with cleansing powder or soap-filled pads as directed. Avoid getting cleansing powder in the telescopic slides. Relubrication may become necessary. Use only high-temperature food-grade lubricants or PAM to re-lubricate slides. DO NOT clean the rack in the self-cleaning oven.
Fiberglass Gasket	DO NOT CLEAN GASKET.
Glass	Wash with soap and water or glass cleaner. Use Fantastik® or Formula 409® to remove grease splatters and stubborn stains.
Painted Surfaces	Clean with hot soapy water or apply Fantastik® or Formula 409® to a clean sponge or paper towel and wipe clean. Avoid using powder cleaning agents, steel wool pads and oven cleaners.
Porcelain Surfaces	Immediately wipe up acid spills like fruit juice, milk and tomatoes with a dry cloth. Do not use a moistened sponge/cloth on hot porcelain. When cool, clean with hot soapy water or apply Bon-Ami® or Soft Scrub® to a damp sponge. Rinse and dry. For stubborn stains, use soap-filled pads. It is normal for porcelain to show fine lines with age due to exposure to heat and food soil.
Stainless Steel Surfaces	Always wipe or rub in the direction of the grain. Clean with a soapy sponge, then rinse and dry, or wipe with Fantastik® or Formula 409® sprayed on a paper towel. Protect and polish with Stainless Steel Magic® and a soft cloth. Remove water spots with a cloth dampened with white vinegar. Use Bar Keeper's Friend® to remove heat discoloration.
Plastic & Controls	When cool, clean with soapy water, rinse and dry.
Probe	Wipe with soapy water. Do not submerge. Do not wash in the dishwasher.
Printed areas (words & numbers)	Do not use abrasive cleansers.

# Maintenance

## Replacing an Oven Light



### Caution:

- Make sure the appliance and lights are cool and power to the appliance has been turned off before replacing the light bulb(s). Failure to do so could result in electrical shock or burns.
- The lenses must be in place when using the appliance.
- The lenses serve to protect the light bulb from breaking.
- The lenses are made of glass. Handle carefully to avoid breaking. Broken glass could cause an injury.
- Light socket is live when door is open.

Use only 10 Watt, 12 Volt bi-pin halogen light bulbs. These bulbs can be purchased through retail stores.

Use a clean, dry cloth to handle halogen light bulbs. This will increase the life of the bulb.

### To replace the halogen bulb on the oven ceiling:

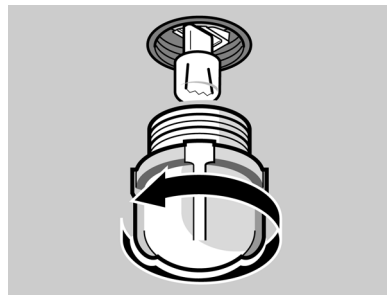

1. Turn off power to the oven at the main power supply (fuse or breaker box).
2. Remove the glass cover by unscrewing it.

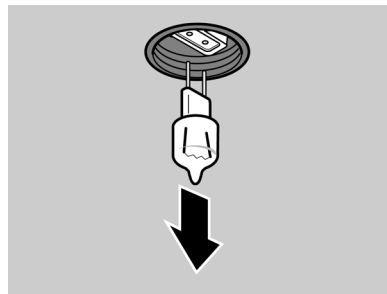

3. Remove the halogen bulb and replace. Grasp the new bulb with a clean, dry cloth.
4. Screw the glass cover back on.
5. Turn power back on at the main power supply (fuse or breaker box).

### To replace the halogen bulb on the oven sidewall:

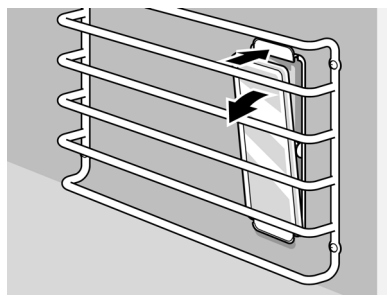

1. Turn off power to the oven at the main power supply (fuse or breaker box).
2. Push the top mounting clip back and remove the glass cover.

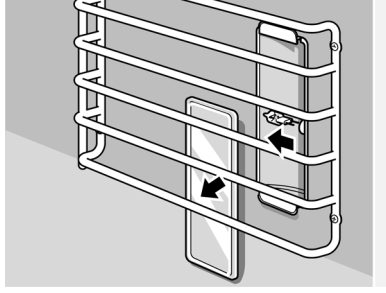
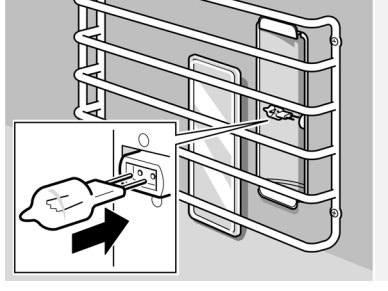
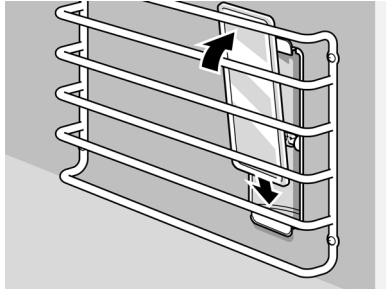
	<p>3. Pull the halogen bulb from its socket.</p>
	<p>4. Replace the halogen bulb. Grasp the new bulb with a clean, dry cloth.</p>
	<p>5. Put the glass cover back on by inserting it into the lower mounting clip and pressing upward until it locks into place.</p> <p>6. Turn power back on at the main power supply (fuse or breaker box).</p>

## Removing the Oven Door

	<p><b>Caution:</b> When removing the door:</p> <ul style="list-style-type: none"> <li>• Make sure oven is cool and power to the oven has been turned off before removing the door. Failure to do so could result in electrical shock or burns.</li> <li>• The oven door is heavy and fragile. Use both hands to remove the oven door. The door front is glass. Handle carefully to avoid breaking.</li> <li>• Grasp only the sides of the oven door. Do not grasp the handle as it may swing in your hand and cause damage or injury.</li> <li>• Failure to grasp the oven door firmly and properly could result in personal injury or product damage.</li> <li>• To avoid injury from hinge bracket snapping closed, be sure that both levers are securely in place before removing the door. Also, do not force door open or closed - the hinge could be damaged and injury could result.</li> </ul>
---	--

### To remove the oven door:

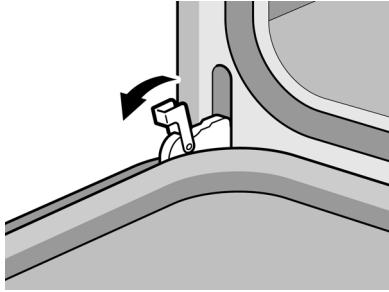
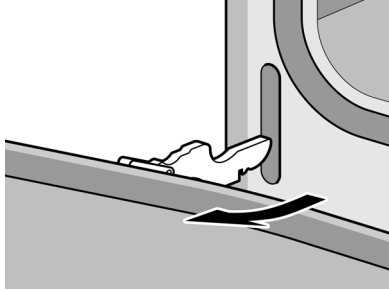
	<ol style="list-style-type: none"><li>1. Be sure to read the above WARNING before attempting to remove the door.</li><li>2. Open the door completely.</li><li>3. Flip levers on hinges toward you.</li></ol>
	<ol style="list-style-type: none"><li>4. Close door carefully until it stops. It will be about half way closed.</li><li>5. Holding the door firmly on both sides using both hands, pull the door up and out of the hinge slots. Hold firmly; the door is heavy.</li><li>6. Place the door in a convenient and stable location for cleaning.</li></ol>

### To replace the oven door:

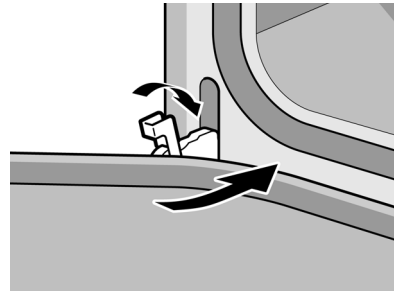
	<ol style="list-style-type: none"><li>1. Holding the door firmly in both hands, place hinges in hinge slots.</li><li>2. Open door all the way to expose hinges and slots.</li><li>3. Push lever down and away from you until flush with the bracket.</li><li>4. Close and open door slowly to be sure it is correctly and securely in place. Door must be straight, not crooked.</li></ol>
---	--

# Service

## Before Calling Service

### Troubleshooting Chart

Oven Problem	Possible Causes and Suggested Solutions
Oven door is locked and will not open, even after cooling.	Turn the oven off at the circuit breaker and wait five minutes. Turn breaker back on. The oven should reset itself and will be operable.
Oven is not heating.	Check circuit breaker or fuse box to your house. Make sure there is proper electrical power to the oven. Be sure oven temperature has been selected.
Oven is not cooking evenly.	Refer to cooking charts for recommended rack position. Check "Getting the Most Out of Your Appliance" for tips and suggestions.
Baking results are not as expected.	Refer to cooking charts for recommended rack position. Check "Getting the Most Out of Your Appliance" for tips and suggestions. Adjust oven calibration if necessary. See "Oven Temperature Offset" under "User Settings".
Food takes longer to cook than expected.	The oven is carefully calibrated to provide accurate results. However, the temperature can be offset if food is consistently too brown or too light. See "Oven Temperature Offset" under "User Settings".
Food is overcooked.	The oven is carefully calibrated to provide accurate results. However, the temperature can be offset if food is consistently too brown or too light. See "Oven Temperature Offset" under "User Settings".
True Convection results are not as expected.	The oven temperature must be manually reduced by 25 °F. Refer to cooking charts and tips for rack positions, cooking times and pan selection. Adjust oven calibration if necessary. See "Oven Temperature Offset" under "User Settings".
Oven temperature is too hot or too cold.	The oven thermostat needs adjustment. See "Oven Temperature Offset" under "Special Features".
Oven light is not working properly.	Replace or reinsert the light bulb if loose or defective. Touching the bulb with fingers may cause the bulb to burn out.
Oven light does not turn off.	Check for obstruction in oven door. Check to see if hinge is bent.
Cannot remove lens cover on light.	There may be soil build-up around the lens cover. Wipe lens cover area with a clean dry towel prior to attempting to remove the lens cover.
Oven is not self-cleaning properly.	Allow the oven to cool before running self-clean. Always wipe out loose soils or heavy spillovers before running self-clean. If oven is badly soiled, set oven for the maximum self-clean time.
Clock and timer are not working properly.	Make sure there is electrical power to oven.
"E" and a number appears in display and control beeps.	This is a fault code. Press "+" and "-" simultaneously to stop beeping and clear display. Reset oven if necessary. If fault code remains, record fault code, cancel oven and call authorized service technician.
With a new oven there is a strong odor when oven is turned on.	This is normal with a new oven and will disappear after a few uses. Operating the self-clean cycle also "burns-off" the smell more quickly.



Oven Problem	Possible Causes and Suggested Solutions
Control does not react when a key is touched.	Be sure that pad is clean. Touch the center of the touchpad. Use the flat part of your finger.
Fan is running during modes that do not use convection	On some models, the convection fan runs while the oven is preheating for the bake mode. This is normal.
Warm air or steam escapes from oven vent.	It is normal to see or feel steam or warm air escaping from the oven vent. Do not block the vent.
Cooling fan runs even when the oven is turned off.	This is normal. The cooling fan will continue to run, even after the oven has been turned off, until the oven has cooled sufficiently.

## Data Plate

The data plate shows the model and serial number. Refer to the data plate on the appliance when requesting service. The data plate location is shown in the following picture.

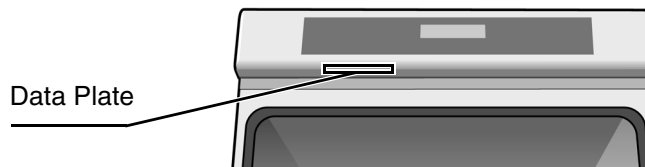

## How to Obtain Service or Parts

To reach a service representative, see the contact information at the front of the manual. Please be prepared with the information printed on your product data plate when calling.

# STATEMENT OF LIMITED PRODUCT WARRANTY

## What this Warranty Covers & Who it Applies to

The limited warranty provided by BSH Home Appliances Thermador in this Statement of Limited Product Warranty applies only to the Thermador appliance sold to you, the first using purchaser, provided that the Product was purchased:

- For your normal, household (non-commercial) use, and has in fact at all times only been used for normal household purposes.
- New at retail (not a display, "as is", or previously returned model), and not for resale, or commercial use.
- Within the United States or Canada, and has at all times remained within the country of original purchase.

The warranties stated herein apply only to the first purchaser of the Product and are not transferable.

Please make sure to return your registration card; while not necessary to effectuate warranty coverage, it is the best way for Thermador to notify you in the unlikely event of a safety notice or product recall.

## How Long the Warranty Lasts

Thermador warrants that the Product is free from defects in materials and workmanship for a period of twelve (12) months from the date of purchase. The foregoing timeline begins to run upon the date of purchase, and shall not be stalled, tolled, extended, or suspended, for any reason whatsoever.

## Repair/Replace as Your Exclusive Remedy

During this warranty period, Thermador or one of its authorized service providers will repair your Product without charge to you (subject to certain limitations stated herein) if your Product proves to have been manufactured with a defect in materials or workmanship. If reasonable attempts to repair the Product have been made without success, then Thermador will replace your Product (upgraded models may be available to you, in Thermador's sole discretion, for an additional charge). All removed parts and components shall become the property of Thermador at its sole option. All replaced and/or repaired parts shall assume the identity of the original part for purposes of this warranty and this warranty shall not be extended with respect to such parts. Thermador's sole liability and responsibility hereunder is to repair manufacturer-defective Product only, using a Thermador-authorized service provider during normal business hours. For safety and property damage concerns, Thermador highly recommends that you do not attempt to repair the Product yourself, or use an un-authorized servicer; Thermador will have no responsibility or liability for repairs or work performed by a non-authorized servicer. If you choose to have someone other than an authorized service provider work on your Product, **THIS WARRANTY WILL AUTOMATICALLY BECOME NULL AND VOID.** Authorized service providers are those persons or companies that have been specially trained on Thermador products, and who possess, in Thermador's opinion, a superior reputation for customer service and technical ability (note that they are independent entities and are not agents, partners, affiliates or representatives of Thermador). Notwithstanding the foregoing, Thermador will not incur any liability, or have responsibility, for the Product if it is located in a remote area (more than 100 miles from an authorized service provider) or is reasonably inaccessible, hazardous, threatening, or treacherous locale, surroundings, or environment; in any such event, if you request, Thermador would still pay for labor and parts and ship the parts to the nearest authorized service provider, but you would still be fully liable and responsible for any travel time or other special charges by the service company, assuming they agree to make the service call.

## Out of Warranty Product

Thermador is under no obligation, at law or otherwise, to provide you with any concessions, including repairs, pro-rates, or Product replacement, once this warranty has expired.

## Warranty Exclusions

The warranty coverage described herein excludes all defects or damage that are not the direct fault of Thermador, including without limitation, one or more of the following:

- Use of the Product in anything other than its normal, customary and intended manner (including without limitation, any form of commercial use, use or storage of an indoor product outdoors, use of the Product in conjunction with air or water-going vessels).
- Any party's willful misconduct, negligence, misuse, abuse, accidents, neglect, improper operation, failure to maintain, improper or negligent installation, tampering, failure to follow operating instructions, mishandling, unauthorized service (including self-performed "fixing" or exploration of the appliance's internal workings).
- Adjustment, alteration or modification of any kind.
- A failure to comply with any applicable state, local, city, or county electrical, plumbing and/or building codes, regulations, or laws, including failure to install the product in strict conformity with local fire and building codes and regulations.
- Ordinary wear and tear, spills of food, liquid, grease accumulations, or other substances that accumulate on, in, or around the Product.
- Any external, elemental and/or environmental forces and factors, including without limitation, rain, wind, sand, floods, fires, mud slides, freezing temperatures, excessive moisture or extended exposure to humidity, lightning, power surges, structural failures surrounding the appliance, and acts of God.

In no event shall Thermador have any liability or responsibility whatsoever for damage to surrounding property, including cabinetry, floors, ceilings, and other structures or objects around the Product. Also excluded from this warranty are scratches, nicks, minor dents, and cosmetic damages on external surfaces and exposed parts; Products on which the serial numbers have been altered, defaced, or removed; service visits to teach you how to use the Product, or visits where there is nothing wrong with the Product; correction of installation problems (you are solely responsible for any structure and setting for the Product, including all electrical, plumbing or other connecting facilities, for proper foundation/flooring, and for any alterations including without limitation cabinetry, walls, floors, shelving, etc.); and resetting of breakers or fuses.

**TO THE EXTENT ALLOWED BY LAW, THIS WARRANTY SETS OUT YOUR EXCLUSIVE REMEDIES WITH RESPECT TO PRODUCT, WHETHER THE CLAIM ARISES IN CONTRACT OR TORT (INCLUDING STRICT LIABILITY, OR NEGLIGENCE) OR OTHERWISE. THIS WARRANTY IS IN LIEU OF ALL OTHER WARRANTIES, WHETHER EXPRESS OR IMPLIED. ANY WARRANTY IMPLIED BY LAW, WHETHER FOR MERCHANTABILITY OR FITNESS FOR A PARTICULAR PURPOSE, OR OTHERWISE, SHALL BE EFFECTIVE ONLY FOR THE PERIOD THAT THIS EXPRESS LIMITED WARRANTY IS EFFECTIVE. IN NO EVENT WILL THE MANUFACTURER BE LIABLE FOR CONSEQUENTIAL, SPECIAL, INCIDENTAL, INDIRECT, "BUSINESS LOSS", AND/OR PUNITIVE DAMAGES, LOSSES, OR EXPENSES, INCLUDING WITHOUT LIMITATION TIME AWAY FROM WORK, HOTELS AND/OR RESTAURANT MEALS, REMODELLING EXPENSES IN EXCESS OF DIRECT DAMAGES WHICH ARE DEFINITELY CAUSED EXCLUSIVELY BY THERMADOR, OR OTHERWISE. SOME STATES DO NOT ALLOW THE EXCLUSION OR LIMITATION OF INCIDENTAL OR CONSEQUENTIAL DAMAGES, AND SOME STATES DO NOT ALLOW LIMITATIONS ON HOW LONG AN IMPLIED WARRANTY LASTS, SO THE ABOVE LIMITATIONS MAY NOT APPLY TO YOU. THIS WARRANTY GIVES YOU SPECIFIC LEGAL RIGHTS, AND YOU MAY ALSO HAVE OTHER RIGHTS WHICH VARY FROM STATE TO STATE.**

No attempt to alter, modify or amend this warranty shall be effective unless authorized in writing by an officer of BSH.

# Notes:







**Thermador**<sup>®</sup> | *An American Icon*<sup>™</sup>

5551 McFadden Avenue, Huntington Beach, CA 92649 • 800-735-4328 • [www.thermador.com](http://www.thermador.com)  
9000175021 • 5V09FP • Rev. B • 11/06 © BSH Home Appliances Corporation, 2007 • All rights reserved  
Litho in USA



## Free Manuals Download Website

<http://myh66.com>

<http://usermanuals.us>

<http://www.somanuals.com>

<http://www.4manuals.cc>

<http://www.manual-lib.com>

<http://www.404manual.com>

<http://www.luxmanual.com>

<http://aubethermostatmanual.com>

Golf course search by state

<http://golfingnear.com>

Email search by domain

<http://emailbydomain.com>

Auto manuals search

<http://auto.somanuals.com>

TV manuals search

<http://tv.somanuals.com>