

Thermador[®]

Care & Use Manual

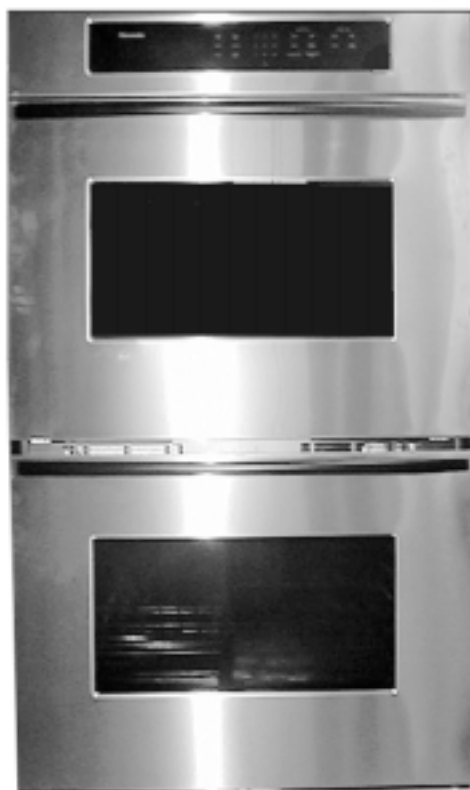

for
Thermador[®] Built-In Oven

Models:
SCD302 / SCD272
SC302 / SC301 / SC272

A Special Message to Our Customers

Thank you for buying a Thermador oven. We recommend that you take the time to read this entire booklet before using your new appliance.

We hope that the information in this manual will help you easily operate and care for your oven for years of satisfaction.

Please contact us if you have any questions or comments. Phone us at **1-800-735-4328** or reach us through our website at **www.thermador.com**.

You may write to us at:

Customer Support Call Center
Thermador
5551 McFadden Avenue
Huntington Beach, CA 92649

Always include the model number and serial number with all communications.

Sincerely,

Thermador Test Kitchen Consumer Scientists

Table of Contents

Safety Instructions

Safety Instructions (English) 2 – 3

Les Instructions de Securite Important
(Safety Instructions in French) 4 – 5

Features of Your Oven

Parts Identification 6

Description of Touch Pad Functions 7

What You Will Hear And See 8

Operating Instructions

Setting the Clock 9

Setting the Timer 10

General Oven Tips 11

Oven Voltage 11

Oven Racks 12

Bake, Convection or
Convection Roast Mode Operation 13

Baking Techniques 14

Proofing Techniques 14

Convection Techniques 15

Dehydrating Techniques 15

Bake and Convection Chart 16 – 18

Convection Roast Techniques 19

Food Safety Guidelines 19

Meat Roasting Chart 20

Poultry Roasting Chart 21

Broil Techniques 22

Broil Mode Operation 23

Broiling Chart 24

Timed Cooking Feature Operation 25 – 27

Child Lockout Feature Operation 27

Oven Cleaning and Care

Self-Cleaning: Before and After 28

Setting the Self Clean Mode 29

General Oven Care 30

Oven Finishes / Cleaning Method 31

Do-It-Yourself Maintenance

Replacing the Oven Light 32

24-Hour Clock and Centigrade Format 32

Removing the Oven Door 33

Oven Temperature and Calibration 34

Signals and Control Panel Display 34

Problem Solving 35 – 36

Solving Baking Problems 35

Solving Operational Problems 36

How to Obtain Service 36

Thermador® Built-In Oven Warranty 37

Service Data Record 37

Location of Model and Serial Number 6

General Appliance and Oven SAFETY PRECAUTIONS

Please read all instructions before using this appliance.



WARNING

When properly cared for, your new Thermador oven has been designed to be a safe, reliable appliance. **Read all instructions carefully before using this oven. These precautions will reduce the risk of burns, electric shock, fire, and injury to persons. When using kitchen appliances, basic safety precautions must be followed, including the following:**

- This appliance must be properly installed and grounded by a qualified technician. Connect only to a properly grounded outlet. See “Grounding Instructions” found in the Installation Instructions.
 - This appliance should be serviced only by qualified service technician. Contact the nearest **authorized service center** for examination, repair or adjustment.
 - **Do not** repair or replace any part of the oven unless specifically recommended. Refer service to an authorized servicer.
 - **Do not** operate this appliance if it is not working properly or if it has been damaged, until an authorized servicer has examined it.
 - Install or locate this appliance only in accordance with the Installation Instructions.
 - Use this oven only as intended by the manufacturer. If you have any questions, contact the manufacturer.
 - **Do not cover** or block any openings on this appliance.
 - Use this appliance only for its intended use as described in this manual. Do not use corrosive chemicals, vapors, or nonfood products in this appliance. This type of oven is specifically designed to heat or cook. It is not designed for industrial or laboratory use. The use of corrosive chemicals in heating or cleaning will damage the appliance.
 - In the event that personal clothing or hair catches fire, **DROP AND ROLL IMMEDIATELY** to extinguish flames.
- **Do not** allow children to use this appliance, unless closely supervised by an adult. Children and pets should not be left alone or unattended in the area where the appliance is in use. Never allow children to sit or stand on any part of the oven.
 - **Do not** store items of interest to children above the oven. If children should climb onto the appliance to reach these items, they could be seriously injured.

To reduce the risk of fire in the oven cavity:

1. **Do not** store flammable materials in or near the oven.
2. **Do not** use water on a grease fire. Smother fire or use a dry chemical or foam-type extinguisher.
3. It is highly recommended that a fire extinguisher be readily available and highly visible next to any cooking appliance.
4. **Do not** overcook food. Carefully attend oven if paper, plastic or other combustible materials are placed inside the oven.
5. **Do not** use the cavity for storage purposes. Do not leave paper products, cooking utensils or food in the cavity when not being used.
6. If materials inside the oven should ignite, keep oven door closed. Turn oven off and disconnect the circuit at the circuit breaker box.
7. **Do not** block any vent openings.
8. Be sure the blower fan runs whenever the oven is in operation. If the fan does not operate, **do not** use the oven. Call an authorized service center.
9. Never use the oven to warm or heat a room. This can damage the oven parts.
10. For personal safety, wear proper clothing. Loose fitting or garments with hanging sleeves should never be worn while using this appliance.

Continued on next page

IMPORTANT SAFETY INSTRUCTIONS

Please read all instructions before using this appliance.

SAFETY FOR THE OVEN

- Tie long hair so that it doesn't hang loose.
- Do not touch heating elements or interior surfaces of oven.
- The heating elements may be hot even though they are dark in color. Interior surfaces of an oven become hot enough to cause burns.
- During and after use, do not touch or let clothing or other flammable materials contact the heating elements or the interior surfaces of the oven until they have had sufficient time to cool.
- The trim on the top and sides of the oven door may become hot enough to cause burns.
- Use care when opening the door. Open the door slightly to let hot air or steam escape before removing or replacing food.
- Do not heat unopened food containers. Build-up of pressure may cause the container to burst and result in injury.
- Always place oven racks in desired location while oven is cool. If a rack must be moved while oven is hot, do not let potholder contact the hot heating elements.
- Use only dry pot holders. Moist or damp pot holders on hot surfaces may result in burns from steam. Do not let pot holder touch hot elements. Do not use a towel or other bulky cloth as a pot holder.

SAFETY FOR THE SELF-CLEANING OVEN

- Confirm that the door locks and will not open once START is touched and the door lock icon appears. If door does not lock, touch OVEN OFF and do not run Self Clean. Phone 800/735-4328 for service (see Page 36 for obtaining service).
- Do not clean the door gasket. It is essential for a good seal. Care should be taken not to rub, damage, move or remove the door gasket.
- Do not use commercial oven cleaners or oven liner protective coatings of any kind in or around any part of the oven.
- Clean only oven parts listed in this manual.
- Before self-cleaning the oven, remove the broiler pan, oven racks, other utensils and excess soft spillage.
- Listen for fan. A fan noise should be heard sometimes during the cleaning cycle. If no fan is heard, call for service.



WARNING

The California Safe Drinking Water and Toxic Enforcement Act requires businesses to warn customers of potential exposure to substances which are known by the State of California to cause cancer or reproductive harm.

The elimination of soil during self-cleaning generates some by-products which are on this list of substances.

To minimize exposure to these substances, always operate this oven according to the instructions in this manual and provide good ventilation to the room during and immediately after self-cleaning the oven.

LES INSTRUCTIONS DE SÉCURITÉ IMPORTANT

Veillez lire les instructions entières avant de continuer.



AVERTISSEMENT

Lorsque l'entretien est effectué de façon approprié, ce nouveau four Thermador a été conçu pour offrir sécurité et fiabilité. Lire toutes les instructions attentivement avant d'utiliser ce four. Ces précautions permettront de réduire tout risque de brûlures, de chocs électrique et de blessures. Au moment d'utiliser des appareils électroménagers, des précautions de base doivent être observées, incluant ce qui suit.

LA SÉCURITÉ POUR TOUS LES APPAREILS

- Utiliser cet appareil seulement dans la manière destinée par le fabricant. Si vous avez des questions, contacter le fabricant.
- Faire installer et mettre à la terre la cuisinière par un technicien qualifié.
- Les enfants ne doivent pas être laissés seuls ou sans surveillance dans un endroit où les appareils sont en marche. Il ne doit jamais être permis à laisser s'asseoir ou poser le pied sur aucune partie de l'appareil.
- Ne jamais utiliser le four pour chauffer une chambre. Tel emploi peut endommager le four.
- Pour la sécurité personnelle, porter le vêtement adéquat. Les vêtements amples ou suspendus ne doivent jamais être portés pendant l'utilisation de cet appareil.
- Ne pas réparer ou remplacer aucune partie de l'appareil à moins que recommandé spécifiquement dans ce manuel. Tout autre entretien doit être rapporté à un technicien qualifié.
- Ne pas emmagasiner les matières inflammable dans ou près le four.
- Ne pas utiliser de l'eau sur les feus de la graisse. Mettre l'appareil à l'arrêt et s'éteuffer le feu avec le bicarbonate de soude ou utiliser un extincteur de chimique sec ou de type écumé.
- Utiliser seulement les poignées sèches. Les poignées mouillées ou humides sur les surfaces chaudes peuvent causer les becs du vapeur. Ne pas utiliser une serviette ou d'autre tissu volumineux au lieu des poignées. Ne pas permettre les poignées de toucher les éléments chauds, les becs chauds, ou les grilles du bec.
- Dans l'événement que l'habillement personnel prend feu. **TOMBER ET ROULER IMMÉDIATEMENT** pour éteindre les flammes.

- Comme une précaution, c'est extrêmement recommandé qu'un extincteur de feu soit facilement disponible et très à côté d'aucun appareil de la cuisine.

LA SÉCURITÉ POUR LE FOUR

- Ne pas toucher les éléments de chauffage ou les surfaces intérieures du four.
- Les éléments de chauffage (cuire au four et griller) peuvent être chauds bien qu'ils sont foncés en couleur. Les surfaces intérieures d'un four s'échauffent assez de causer les brûlures.
- Pendant et après l'utilisation, ne pas toucher ou permettre l'habillement ou d'autres matières inflammables de contacter les éléments de chauffage (cuire au four et griller) ou les surface intérieures du four jusqu'à ce qu'elles ont eu le temps suffisant de rafraîchir.
- Les moulures sur le sommet et les côtés de la porte du four peuvent s'échauffer assez de causer les brûlures.
- Utiliser le soin en ouvrant la porte. Ouvrez la porte légèrement permettre l'air chaud ou lavapeur d'échapper avant d'enlever ou de remplacer la nourriture.
- Ne pas chauffer les récipients de la nourriture non ouvert; une intensification de pression peut causer le récipient d'éclater.
- Toujours mettre les étagères du four à l'endroit désiré pendant que le four soit frais. Si une étagère doit être déplacée quand le four est chaud, ne pas permettre la poignée de contacter les éléments de chauffage chauds.

LA SÉCURITÉ POUR LE FOUR AUTO-NETTOYANT

- Ne pas nettoyer le joint de la porte. C'est essentiel pour un bon sceau. Le soin doit être pris de ne pas froter, endommager, ou enlever le joint de la porte.
- Ne pas utiliser les nettoyeurs du four commerciaux ou les revêtements de protection du revêtement du four d'aucunes sortes dans ou autour aucune partie du four.
- Nettoyer seulement les parties du four inscrites dans ce manuel.
- Avant de auto-nettoyer le four, enlever la casserole du gril, les étagères du four, les autres ustensiles et un excédent de liquide.

LES INSTRUCTIONS DE SÉCURITÉ IMPORTANT

Veillez lire les instructions entières avant de continuer.

SÉCURITÉ POUR LE FOUR

- Ne pas toucher aux éléments chauffants ni les surfaces intérieures du four.
- Les éléments chauffants peuvent être très chauds même s'ils sont de couleur foncée. Les surfaces intérieures du four deviennent très chaudes et peuvent causer des brûlures.
- Pendant et après l'utilisation, ne pas toucher ni laisser des vêtements ou autres matériaux inflammables entrer en contact avec les éléments chauffants ou les surfaces intérieures du four, tant qu'ils n'ont pas suffisamment refroidis.
- La garniture sur le haut et les côtés de la porte du four peut être suffisamment chaude pour causer des brûlures.
- Faire attention en ouvrant la porte. Ouvrir légèrement la porte afin que l'air chaud et la vapeur puissent s'échapper avant de mettre ou enlever des aliments.
- Ne pas faire chauffer des contenants non ouverts. L'accumulation de la pression peut faire exploser le contenant et causer des blessures.
- Toujours placer les tablettes à l'endroit désiré pendant que le four est froid. Si la tablette doit être déplacée pendant que le four est chaud, les mouffes ou tire-plats ne doivent pas entrer en contact avec les éléments chauffants.

SÉCURITÉ POUR LE FOUR AUTO-NETTOYANT

- S'assurer que la porte se verrouille et qu'elle ne peut être ouverte une fois que la touche marche (START) est pressée et que l'icône de porte verrouillée est affiché. Si la porte ne se verrouille pas, presser la touche four arrêt (OVEN OFF) et ne pas effectuer le nettoyage. Téléphoner au 800/735-4328 pour un service (voir Page 36 pour plus de détails).
- NE pas nettoyer le joint de la porte. Cela est essentiel pour une bonne étanchéité. Il faut faire attention pour ne pas récurer, endommager, déplacer ni enlever le joint de la porte.
- Ne pas utiliser de produits nettoyants de type commercial ni d'enduit protecteur sur et dans le four.
- Nettoyer seulement les parties indiquées dans ce guide.
- Avant d'effectuer le nettoyage du four, enlever le plateau, les tablettes, les ustensiles et tout déversement.
- * Le bruit du ventilateur doit être audible pendant le cycle de nettoyage, sinon, communiquer avec le service.



AVERTISSEMENT

Le règlement « California Safe Drinking Water and Toxic Enforcement Act » exige que les compagnies avisent les clients du danger potentiel d'exposition aux substances reconnues par l'état de la Californie comme pouvant causer le cancer ou des problèmes de santé reliés à la reproduction.

L'élimination des résidus pendant le fonctionnement auto-nettoyant peut générer certains sous produits dérivés donnés dans la liste.

Afin de minimiser l'exposition à ces substances, toujours faire fonctionner ce four conformément aux instructions de ce guide et assurer une bonne ventilation à la pièce pendant et immédiatement après le nettoyage du four.

Features of Your Oven

Not all features are on all models

**MODEL SC301
SINGLE OVEN**

**MODELS SCD302, SCD272
SC302, SC272
DOUBLE OVENS**

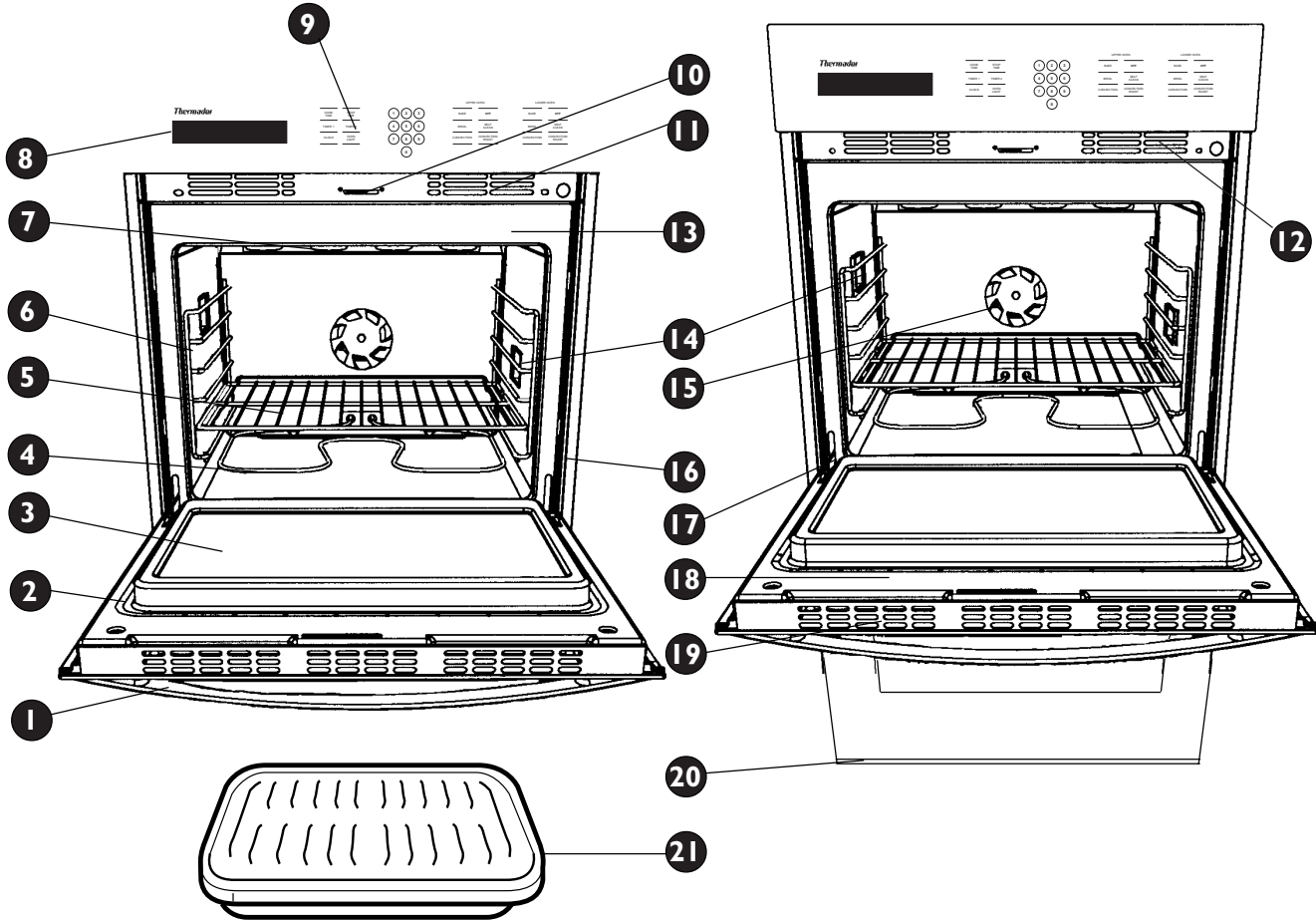

Parts Identification

Feature Index	Explained on page	Feature Index	Explained on page		
1	Door Handle	30, 31	12	Model & Serial No. Location (look through vents)	30, 37
2	Oven Door Gasket	3, 28, 30, 31	13	Front Frame	30, 31
3	Window	28, 30, 31	14	Halogen Oven Lamps (2)	28, 32
4	Easy-lift Bake Element	28	15	Convection Fan and Cover	8, 14, 19
5	Removable Oven Racks	3, 12, 28, 30, 31	16	Side Trim	28, 30, 31
6	Rack Supports	12	17	Door Hinge	33
7	Broil Element	22, 23	18	Removable Door	33
8	Display Window	6, 7	19	Door Vents	2, 30, 31
9	Glass Touch Control Panel	6, 30, 31	20	Exhaust Vent Trim	30, 31
10	Automatic Door Lock Latch	28, 36	21	Broiler Pan and Grid	3, 19, 20, 21, 22, 30, 31
11	Oven Cooling Vents	30, 31			

Description of Touch Pad Functions

The control panel contains a series of electronic touch pads that enable you to set the oven. As you touch these control pads, you will notice that numbers and words appear in the display window. These numbers and words are called prompts and show you what is set and what must be done next.

Take a moment to familiarize yourself with these controls. To set the oven, touch only one control pad at a time.

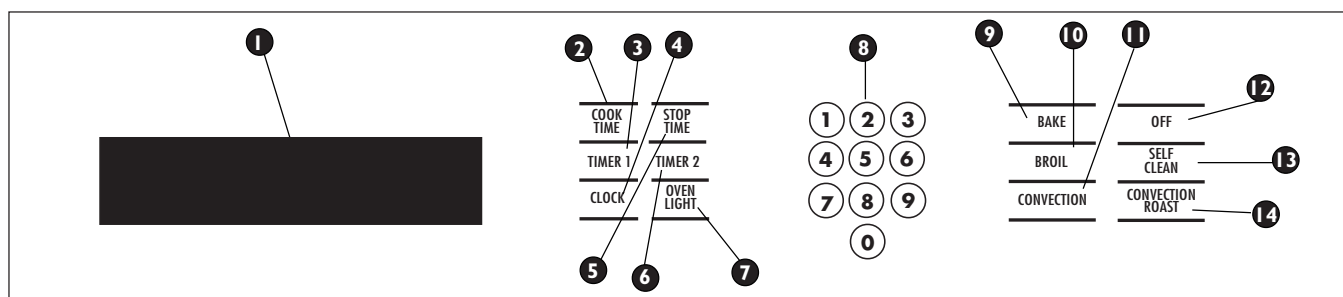

Oven Control Panel showing all of functions.

- | | |
|--|--|
| <p>1 Window Display Clock display and cooking modes.</p> <p>2 Cook Time Touch to set cooking time in minutes or hours for Bake, Convection or Convection Roast modes. When this pad is used instead of Timer 1 or 2, the oven will turn off automatically after the Cook Time has ended.</p> <p>3 Timer 1 Touch to set as an audio reminder kitchen timer. Press again and hold to cancel the minute timer.</p> <p>4 Clock Touch to set the time of day on the 12-hour clock.</p> <p>5 Stop Time Touch after setting Cook Time or Self Clean to set the time of day the oven will automatically turn off.</p> <p>6 Timer 2 Touch to set as a second audio reminder. Press again and hold to cancel the minute timer.</p> | <p>7 Oven Light Touch to turn on oven light. Touch again to turn off oven light.</p> <p>8 Number Pads Touch each number to set time and temperature.</p> <p>9 Bake Touch to select the Bake Mode.</p> <p>10 Broil Touch to select the Broil Mode.</p> <p>11 Convection Touch to select the Convection Mode.</p> <p>12 Off Touch to cancel any mode except Timer 1 and 2.</p> <p>13 Self Clean Touch to select the Self Clean Mode.</p> <p>14 Convection Roast Touch to select the Convection Roast Mode.</p> |
|--|--|

If an "F-and a number" flash in the display, this indicates a function error code. Touch the oven OFF pad or turn off power at the circuit breaker. Wait for 3 minutes and turn it back on. Try again to program your oven function. If function error code repeats, note the code number, disconnect power to the oven and call for service.

What You Will Hear And See

WHAT YOU WILL HEAR

Convection Fan – Operates during any convection mode. It turns off if the door is opened.

Component Cooling Fan – Activates during any cooking or self-cleaning mode to cool electronic components and outer door surfaces. It will stay on until components have cooled sufficiently. This air is exhausted through the vent located below the oven.

Oven Audible Signals – Beeps & Chimes

1. **Pad Touch Response:** A single short beep whenever a function or number is pressed.
2. **Invalid Entry:** Three short beeps.
3. **Self Clean is Selected and Door is Not Closed:** Four short beeps.
4. **Indicates a Failure:** Continuous series of long beeps.
5. **Preheat tone:** Single non-repeating chime.
6. **One minute left on timer:** Single non-repeating chime.
7. **Timer Has Counted Down To Zero:** Four chimes, one second apart followed by two chimes, one second apart every 30 seconds up to 5 minutes.
8. **End of Timed Cooking Cycle:** Four chimes, one second apart followed by one chime every 60 seconds for up to 10 minutes.

WHAT YOU WILL SEE

Control Panel Flashing – Any flashing in the control window indicates the selected function is not completely programmed and requires another step.

Power-up Flashing – The Clock Time flashes following the initial application of power to the unit or after a power failure.

Illuminated Numbers – These numbers indicate Time of Day, Time to Cook, Timers, or Temperature. Digits will move to the left as new digits are entered. Temperatures in Fahrenheit will adjust to the nearest 5°F.

Illuminated Lock – When the word "LOCK" is displayed, the door will not open. Wait for the word to disappear, designating the automatic door latch is in the open position.

Err – Flashes if invalid oven temperatures or times are entered.

F Numbers – Various error codes of F1 to F9, FC, FF, F- and Fr may appear if there is a problem; please consult "Solving Operational Problems," Page 36.

C – Will appear if Centigrade format is selected, see Page 32.

1 and **2** – Indicate Timer 1 and Timer 2.

CONTROL PANEL DISPLAY WINDOW

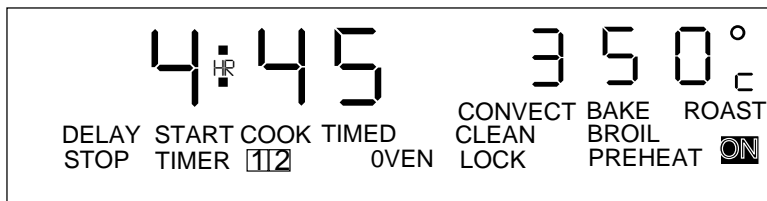

Setting the Clock

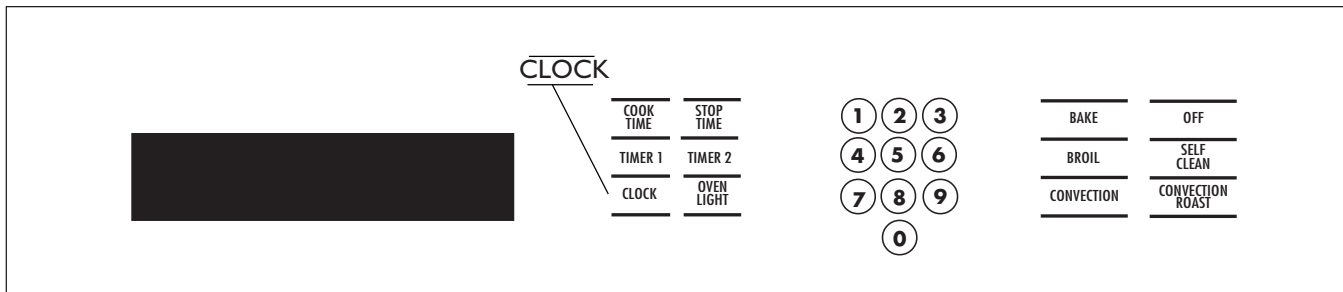

Note: Your oven is preset to a 12 hour clock and does not indicate AM or PM. The Time of Day is displayed in hours and minutes. A 24-hour clock format option may be selected. See "Do It Yourself Maintenance," Page 32.

TO SET THE CLOCK:

WHAT YOU WILL DO	WHAT YOU WILL SEE
<p>1. Touch CLOCK.</p> <p>2. While TIME flashes, touch number pads. Example: touch 5, 2, 9 to set correct Time of Day of 5:29.</p> <p><i>If more than 5 seconds elapse between touching the CLOCK pad and touching each number pad, you must start again with Step 1.</i></p> <p><i>Three seconds after touching the last number, time is set.</i></p>	

TO RECALL TIME OF DAY:

WHAT YOU WILL DO	WHAT YOU WILL SEE
<p>Touch CLOCK once to briefly, display Time of Day if another timed mode is showing.</p> <p>Note: The Time of Day cannot be changed if the oven has been programmed for Timed Bake, Timed Convection, Timed Convection Roast or Self Clean. Cancel the program before reprogramming clock.</p>	

Setting the Timer

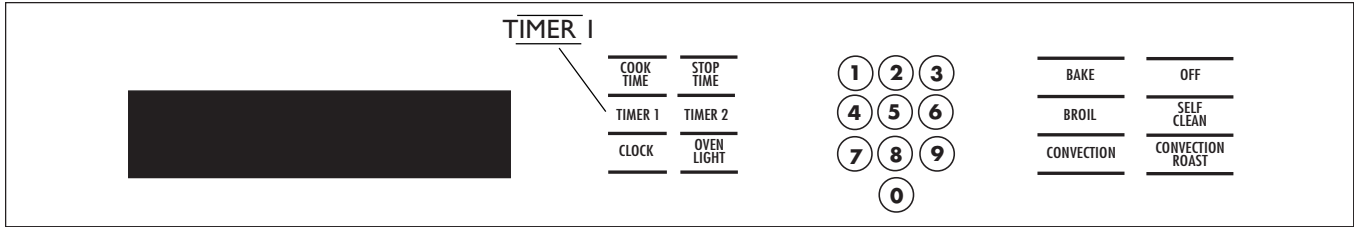

Your oven is equipped with two timers. Operating independently of each other, either timer can be used to remind you when a period from 1 minute up to 11 hours and 55 minutes has expired. They do not control oven operations.

TO SET THE TIMER:

WHAT YOU WILL DO	WHAT YOU WILL SEE
1. Touch TIMER 1 .	
2. When TIMER flashes, touch number pad 5 to set 5 minutes.	
<i>After 3 seconds, the timer will stop flashing and start the 5 minute countdown. When timer reaches 1 minute, a notification chime sounds and display changes to a minutes/seconds mode.</i>	
IMPORTANT: Except for the last minute countdown, the Timer counts in hours and minutes. Example: Touch 10 (:10) for 10 minutes. Touch 100 (1:00) for 1 hour.	

TO CHANGE TIME AFTER STARTING:

- | | |
|---------------------------|------------------------------------|
| 1. Touch TIMER 1 . | 2. Touch number pads for new time. |
|---------------------------|------------------------------------|

WHEN TIME IS UP:

WHAT YOU WILL DO	WHAT YOU WILL SEE
<i>At the end of the time set, the Timer will chime 4 times. If not canceled, 2 chimes will sound every 30 seconds for 5 minutes.</i>	

TO CANCEL TIMER:

WHAT YOU WILL DO	WHAT YOU WILL SEE
Touch Timer 1 and then 0 , or touch and hold Timer 1 for 4 seconds. Important: Touching OFF to cancel the chimes cancels ALL selected oven programming, NOT the Timer! <i>This display shows time of day.</i>	

Note: To set timer for 2 hours and 30 minutes, touch the numbers **2, 3, 0**. The display will show **2:30, TIMER 1**. A timer will always have display priority over the clock. The Timer with the least amount of time remaining will have the first priority. Touching the **CLOCK** or other **TIMER** will briefly display the Time of Day or the time remaining on the other Timer.

General Oven Tips

Preheating the Oven

For best results, preheat the oven when using the BAKE, CONVECTION or CONVECTION ROAST modes.

- Place racks in the oven before preheating.
- Allow oven to preheat while preparing recipe or food.
- The oven is preheated when the oven chimes and the selected temperature is displayed.
- Once oven is preheated, place food in the oven as quickly as possible to minimize the loss of heat.

For Best Results

- Use Baking, Roasting and Broiling Charts found on Pages 16 to 18, 20 to 21 and 24 for suggested rack level and cooking time.
- Minimize opening the door.
- Use TIMER 1 or TIMER 2.
- Use the interior oven light to view the food.
- Store the broiler pan or other utensils outside the oven. An extra pan, without food, affects the browning and cooking.
- Use pans that give you the desired browning:
 - For tender, golden brown crusts, use light nonstick/anodized or shiny metal utensils.
 - For brown, crisp crusts, use dark nonstick/anodized or dark, dull metal utensils or glass bakeware.

CAUTION: Never use aluminum foil to cover the oven racks or to line the oven. It can damage the oven if it touches the heating element or damage the oven liner if heat is trapped under it.

High Altitude Baking

When baking at high altitudes, in either BAKE, CONVECTION or CONVECTION ROAST mode, recipes and baking times vary. For information to adjust recipes, write the Extension Service, Colorado State University, Fort Collins, Colorado 80521. There may be a cost for the bulletins. Specify the type of information you want (example: cakes, cookies, breads, etc.).

Condensation

It is normal for a certain amount of moisture to evaporate from the food during any cooking process. The amount depends on the moisture content of the food. The moisture may condense on any surface cooler than the inside of the oven.

Electronic Temperature Sensor

Your new Thermador® oven has an electronic temperature sensor which accurately maintains the temperature selected. Your previous oven may have had a mechanical thermostat that drifted to a higher temperature with age. You may experience an adjustment period when cooking your favorite recipes with your new Thermador® convection oven.

IF CONNECTING TO 208/120 VOLTS

This oven can be connected to a 208/120 volt or 240/120 volt power source. When connected to a 208/120 volt power source, optimum results are achieved in Bake, Convection Bake and Convection by preheating the oven. Pre-heat times may be slightly longer. Do not preheat the oven in Broil. All timings may be longer than those shown in the Baking Charts. The Self Clean mode may need a longer time than with 240/120 volt connections, depending on the amount of spill.

Oven Racks

Safety Stops

- The racks are designed with safety stops and a back rail. When the racks are placed correctly in the oven, they will stop before coming completely out from the oven. They will not tilt when placing food on them.
- When placing food on a rack, pull the rack out to the stop position. Place the food on the rack, then slide the rack back into the oven. This will eliminate reaching into a hot oven.

Self-Cleaning the Racks

- The racks may be cleaned in the oven during the Self Clean cycle; however, they will lose their shiny finish and change to a metallic gray. See Oven Cleaning Chart on Page 30.
- Rack supports should not be removed.

Rack Levels

- Rack levels are numbered from the bottom rack support to the top.
- The correct rack level for baking a food item depends on the recipe and the cooking mode. See Baking, Roasting and Broiling Charts on Pages 16 to 18, 20 to 21 and 24. Place rack(s) in the proper level before turning on the oven.

Insert The Rack As Follows:

1. Hold the rack with the back rail up and towards the back of the oven. Rest the rear of the rack on the desired rack slide.
2. Push the rack into the oven as far as it will go. It will "drop" into position.
3. Pull the rack forward to confirm safety stops are below rack guide.

Remove Or Reposition The Racks As Follows:

1. Slide the rack to the front of the oven.
2. Lift the front of the rack up so the safety stops slide over the rack slides.
3. Pull the rack forward to remove.

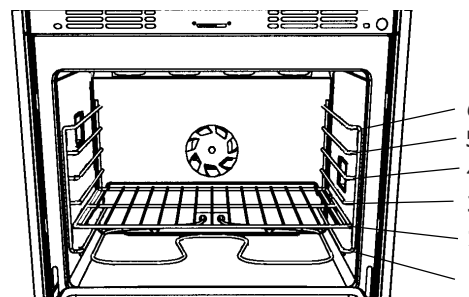

Rack Levels

Bake, Convection or Convection Roast Mode Operation

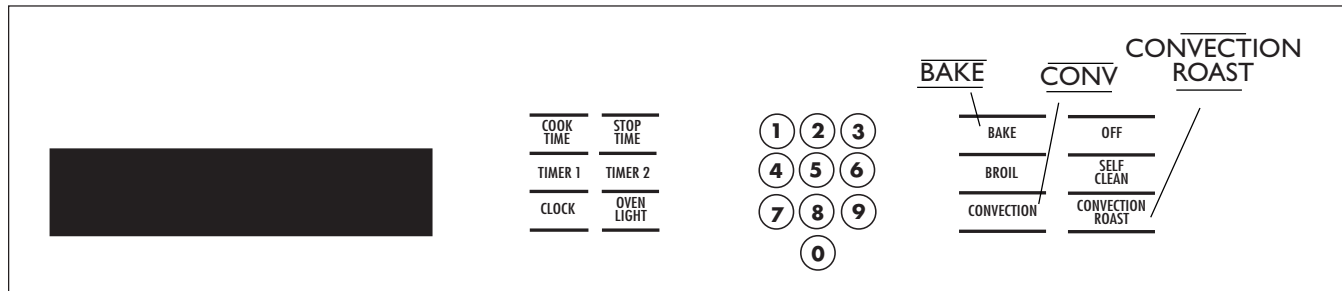

TO SET BAKE, CONVECTION OR CONVECTION ROAST:

WHAT YOU WILL DO	WHAT YOU WILL SEE
<ol style="list-style-type: none"> 1. Touch BAKE, CONVECTION or CONVECTION ROAST. 	
<ol style="list-style-type: none"> 2. While mode flashes, touch number pads to select desired oven temperature from 200°F to 550°F (94° to 290°C). <i>Example: touch 3,5,0 for 350°F.</i> <p><i>The oven will start automatically in 6 seconds.</i></p> <p><i>The display will show 100° (38°C) and will count up in 5° (1°C) increments until the temperature selected is displayed.</i></p> <p><i>When the oven has reached the temperature selected, a chime will sound.</i></p>	

Optional: Set a **TIMER**, as a reminder to check doneness of the food. See Page 10.

Note: To check the already selected oven temperature during preheat, touch the mode pad once.

TO CANCEL BAKE, CONVECTION OR CONVECTION ROAST:

WHAT YOU WILL DO	WHAT YOU WILL SEE
Touch OFF pad. The Time of Day displays.	

TO CHANGE THE OVEN MODE AND / OR TEMPERATURE:

Repeat Steps 1 and 2 above.

- If revising temperature to a lower setting, a chime will sound briefly, indicating the selected temperature has been reached. The PREHEAT and ON lights in the display will go out.
- If revising to a higher temperature, the oven will heat as in Step 2.

Baking Techniques

BAKE MODE

Baking is cooking with heated air. Both upper and lower elements in the oven are used to heat the air, but no fan is used to circulate the heat.

Follow the recipe, convenience food directions for baking temperature, time and rack level. Baking time will vary with the temperature of ingredients and the size, shape and finish of the baking utensil.

General Guidelines

- For best results, bake food on a single rack with at least 1" space between utensils and oven walls.
- Use a maximum of 2 racks when selecting the bake mode. Stagger pans or baking sheets so that one is not directly above another.

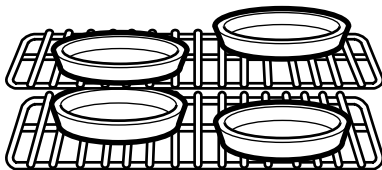

Staggered cake pans

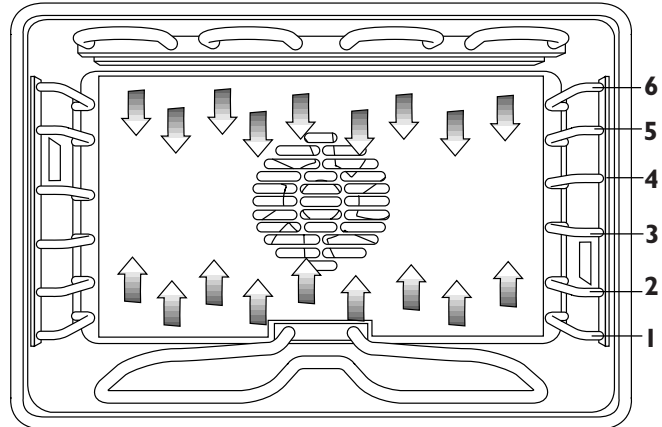

- Check for doneness at the minimum time.
- Use metal bakeware (with or without a nonstick finish), heatproof glass, glass-ceramic, pottery or other utensils suitable for the oven.
- When using heatproof glass, reduce temperature 25°F (14°C) from recommended temperature.
- Use baking sheets with or without sides or jelly roll pans.
- See Baking Charts found on Pages 16 to 18 for specific rack levels for a variety of foods .
- Tips for Solving Baking Problems are found on Page 35.
- Avoid using the opened door as a shelf to place pans.

Proofing Techniques

A **BAKE** mode becomes a Proofing mode when the temperature is set at 100° to 110°F (38° to 43°C). It is possible to proof large bowls of bread dough or many smaller pans in less time than at room temperature. Cover bread dough with plastic wrap while rising. Be sure to remove plastic before baking. Check proofing progress early.

Convection Techniques

CONVECTION MODE

The heat for convection baking comes from the third element at the back of the oven. This mode uses a fan surrounded by the element to circulate the heat throughout the oven. This accelerated air movement allows for multiple rack baking and a 25° to 50°F (14° to 28°C) temperature reduction from the standard bake setting. Generally speaking, the longer the cooking time the greater the time savings.

Foods recommended for convection mode:

Air Leavened Foods (Souffles, Meringue, Cream Puffs, Angel Food Cakes, Chiffon Cakes)

Appetizers

Biscuits

Coffee Cakes

Cookies (2 to 6 racks)

Yeast Breads

Popovers

Dehydrating a variety of foods

Main Dishes

Meats, Roasts and Poultry

Fish and Seafood Items

Oven Meals (1 to 4 racks)

General Guidelines

- The number of racks used is determined by the height of the food to be cooked.
- Use low sided pans when possible for best air circulation.
- To fully utilize the convection system, cook foods that are uncovered.
- Use shiny aluminum pans for best result unless otherwise specified.
- Dark metal pans and heatproof glass or ceramic can be used. Reduce temperature another 25°F (14°C) when using heatproof glass pans for a total reduction of 50°F (28°C).

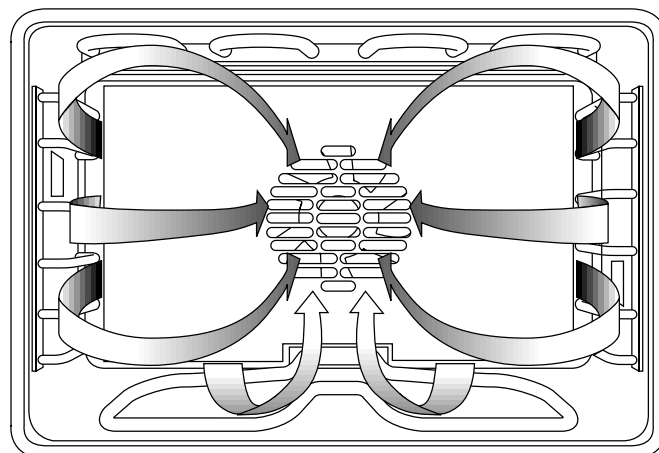

- Use an aluminum cookie sheet with only two turned up edges.
- Multiple rack cooking for cakes and oven meals are done on racks 1, 3 and 5 and up to 6 racks for cookies, biscuits, rolls and appetizers.

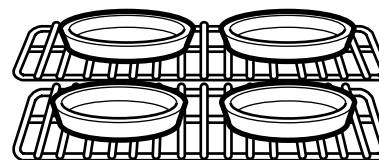

Pans do not need to be staggered.

- Convection Baking Charts are found on Pages 16 to 18.
- Tips for Solving Baking Problems are found on Page 35.

A quick and easy recipe conversion from standard Bake to Convection: Reduce the temperature by 25°F. Use the same cooking time as BAKE if under 15 minutes. If food is cooked over 30 minutes, check 5 to 10 minutes sooner.

Dehydrating Techniques

A **CONVECTION** mode becomes a Dehydrating mode when the temperature is set at 140°F (60°C). You may dehydrate a variety of fruits, vegetables, herbs and meat strips. Drying screens or cookie sheets may be used for this purpose. Consult a food preservation book for times and temperatures. If a temperature other than 140°F (60°C) is required for a specific food, select the Convection Mode and press the desired temperature pads.

Bake and Convection Chart

FOOD ITEM	RACK LEVEL		BAKE Temperature /Time	CONVECTION Temperature /Time
	Bake	Convection		
Breads - Quick				
Biscuits	4	4	450°F (232°C) 10 to 12 min.	425°F (218°C) 10 to 12 min.
Cornbread	3	2	400°F (204°C) 20 to 30 min.	375°F (190°C) 20 to 30 min.
Nut Breads	3	2	Follow package or recipe directions	25°F (14°C) lower than package directions
Muffins	3	4	Follow package or recipe directions	25°F (14°C) lower than package directions
Packaged Refrigerator Rolls	2 or 3	3	Follow package directions	25°F (14°C) lower than package directions
Popovers	3	3	375°F (190°C) 50 to 55 min.	425°F (218°C) for 15 min. then 325°F (163°C) for 20 min. in well-greased Pyrex® cups
Breads-Yeast				
Bread	2	3	375°F (190°C) 30 to 35 min.	350°F (177°C) 40 to 45 min.
Rolls	2, 3	3, 5	Follow package directions	350°F (177°C) 10 to 12 min.
Frozen Dough	3	3	375°F (190°C) 30 to 25 min.	350°F (177°C) 20 to 25 min.
Pizza With Toppings	1	1	NPH 450°F (232°C) 20-30 min.	NPH 425°F (218°C) 20-30 min.

NPH= Non Preheated

Bake and Convection Chart

FOOD ITEM	RACK LEVEL Bake Convection		BAKE Temperature / Time	CONVECTION Temperature / Time
Cakes				
Angel Food Mix	2	2	350°F (177°C) 40 to 50 min.	325°F (163°C) 40 to 45 min.
Cake Mix	3 2 & 4	3 3 & 5	350°F (177°C) Follow package directions	325°F (163°C) Check before minimum bake time.
Scratch Cakes	2	3	Follow recipe directions	25°F (14°C) lower than recipe directions
Cupcakes - Mix	2 & 4	2 & 4	350°F (177°C) Follow package directions	25°F (14°C) lower than recipe or package directions. Check before minimum bake time.
Specialty Cake Mixes	3	3	350°F (177°C) Follow package directions	25°F (14°C) lower than package directions. Check before minimum baketime.
Cookies				
Brownies 9 to 23 oz.	3	3	350°F (177°C) Follow recipe or package directions	25°F (14°C) lower than recipe or package directions
Drop Cookies	3 & 5	2, 4, 6 or	375°F (190°C) 8 to 10 min.	350°F (177°C) all six racks 8 to 12 min.
Bar Cookies Mix	3	3	Follow package directions	25°F (14°C) lower than recipe or package directions
Refrigerated Cookie Doughs	3 & 5	1,3,5	Follow package directions	25°F (14°C) lower than package directions
Desserts				
Fruit Desserts	3	3	Follow recipe directions	25°F (14°C) lower than recipe directions
Cream Puffs	2	3	400°F (204°C)	375°F (190°C) 35 to 40 min.

Bake and Convection Chart

FOOD ITEM	RACK LEVEL		BAKE Temperature / Time	CONVECTION Temperature / Time
	Bake	Convection		
Pies				
2 Crust Fruit Scratch	1	1	425°F (218°C) 35 to 50 min*	400°F (204°C) 40 to 50 min.
Frozen	1	1	Follow package directions	25°F (14°C) lower than package directions
Custard Type Pumpkin Scratch	2	2	425°F (218°C) 15 minutes, then 350°F (177°C) 345 to 50 min.	400°F (204°C) 15 min. then 325°F (163°C) 5 to 40 min.
Frozen	2	2	Follow package directions	50°F (28°C) lower than package directions
Meringue (top)	2	2	350°F (177°C) 20 to 25 min.	325°F (163°C) 20 to 25 min.
Nut Pies	2	2	375°F (190°C) 45 to 50 min.	350°F (177°C) 35 to 45 min.
Pie Crusts				
Graham Cracker	2	2	375°F (190°C) 8 to 10 min.	350°F (177°C) 10 to 12 min.
Pastry – Scratch	12	3	450°F (246°C) 0 to 12 min.	425°F (218°C) 8 to 10 min.
Pastry – Refrigerated	2	3	450°F (232°C) 9 to 11 min.	425°F (218°C) 8 to 10 min.
Pastry – Frozen	2	3	Follow package directions	375°F (190°C)

Scratch pies based on 9" diameter aluminum pie pan

For browner, flakier pie crusts:

- Use a dark metal pie pan, or
- Use a shiny aluminum pie pan placed on a small cookie sheet pre-heated in the oven

Convection Roast Techniques

CONVECTION ROAST MODE

The heat for convection roasting comes from the third element at the back of the oven and from the lower bake element. This mode uses a fan, surrounded by the element, to circulate the heat throughout the oven. The combination of bottom heat and convection heat produces a deeper, brown roast and crispier poultry skin than Bake. This accelerated air movement allows for roasting at a 25° to 50°F (14° to 28°C) temperature reduction from a standard bake setting. Generally speaking, the longer the cooking time the greater the time savings.

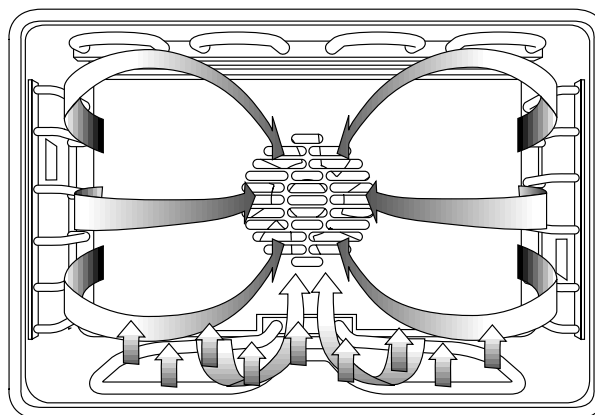

Meats Recommended for Convection Roast Mode:

- Beef Roasts
- Lamb
- Poultry - Turkey, Chicken,
Cornish Game Hens
- Pork Roasts
- Veal Roasts

General Guidelines

- Use low-sided pans for roasting. Allow as much of the circulating heat as possible to reach the food without restriction by high sided pans.
- The 2-piece broil pan is suitable for Convection Roast.
- Cook only tender cuts of meats listed above in this mode. Other less tender cuts of meat benefit from long, slow, moist cooking in a covered pan.
- See Convection Roasting Charts on Pages 20 and 21.

Food Safety Guidelines

FOOD SERVING TEMPERATURE GUIDELINES FROM FSIS

(USDA Food Safety & Inspection Service)

140°F (60°C)

- Ham, pre-cooked (to reheat)

145°F (63°C)

- Fresh Beef, Veal, Lamb (medium rare)

160°F (71°C)

- Ground Meat & Meat Mixtures (Beef, Pork, Veal, Lamb)
- Fresh Beef, Veal, Lamb (medium)
- Fresh Pork (medium)
- Fresh Ham (raw)
- Egg Dishes

165°F (74°C)

- Ground Meat & Meat Mixtures (Turkey, Chicken)
- Stuffing (cooked alone or in bird)
- Leftovers & Casseroles

170°F (77°C)

- Fresh Beef, Veal, Lamb (well done)
- Poultry breasts
- Fresh Pork (well done)

180°F (82°C)

- Chicken & Turkey, whole
- Poultry thighs & wings
- Duck & Goose

NOTE: Eggs (not in a dish) – cook until yolk & white are firm.

Meat Roasting Chart

FOOD ITEM (Weight Range)	CARVING TEMPERATURE	CONVECTION ROAST Minutes per lb. / Temperature
Beef Standing Rib 4 to 6 lbs.	Med. Rare – 145°F (63°C) Med. – 160°F (71°C) Well – 170°F (77°C)	23 to 28 min. at 300°F (149°C) 28 to 32 min. at 300°F (149°C) 32 to 37 min. at 300°F (149°C)
Standing Rib 6 to 8 lbs.	Med. Rare - 145°F (63°C) Med. – 160°F (71°C) Well – 170°F (77°C)	20 to 24 min. at 300°F (149°C) 25 to 29 min. at 300°F (149°C) 29 to 33 min. at 300°F (149°C)
Rolled Rib to 4 lbs.	Med Rare – 145°F (63°C) Med – 160°F (71°C) Well – 170°F (77°C)	28 to 31 min. at 325°F (163°C) 32 to 35 min. at 325°F (163°C) 36 to 38 min. at 325°F (163°C)
5 to 7 lbs.	Med Rare – 145°F (63°C) Med. – 160°F (71°C) Well – 170°F (77°C)	24 to 28 min at 325°F (163°C) 29 to 31 min at 325°F (163°C) 34 to 36 min. at 325°F (163°C)
Boneless Sirloin, Rump, Tri-tip 3 to 6 lbs.	145° to 170°F (63° to 77°C)	25 to 35 min. at 300°F (149°C)
Meatloaf 1 to 2 lbs.	160°F (71°C)	40 to 50 min. total time at 325°F (163°C)
Lamb Leg 4 to 8 lbs.	145°F (63°C)	24 to 30 min. at 325°F (163°C)
Pork Loin 1 to 2 lbs. 3 to 5 lbs.	160°F (71°C)	37 to 43 min. at 325°F (163°C) 33 to 37 min. at 325°F (163°C)
Boneless, Picnic Shoulder 3 to 5 lbs.	160°F (71°C)	30 to 37 min. at 325°F (163°C)
*Ham Half (Fully cooked) 5 to 7 lbs. *Canned 3 to 5 lbs.	140°F (60°C) 130°F (54°C)	15 to 19 min. @ 325°F (163°C) Follow directions on can
Veal Loin roast (bone in) 2 to 4 lbs.	160°F (71°C)	35 to 40 min. at 325°F (163°C)

* Ham prepared with Convection Roast may be covered for juicier results or prepared in the Bake mode.

Techniques

- Roast meats on rack level 2 (larger cuts) or rack level 3 (smaller cuts).
- Use the 2-piece broil pan that comes with the oven. Place roast directly on top of grill for better browning.

- If using a meat thermometer to cook meat to a desired temperature, food is done approximately 5°F (3°C) less than the desired carving temperature. Insert the thermometer into the center of the thickest part of the roast not touching fat or bone. Meats with bone cook somewhat faster per pound than boneless.
- After roasting, allow meat to stand loosely covered with foil for 10 to 15 minutes before carving.
- Some cuts of meat need long slow cooking and are best done covered using the Bake mode.

Poultry Roasting Chart

FOOD ITEM (Weight Range)	CARVING TEMPERATURE	CONVECTION ROAST Minutes per lb. / Temperature
Turkey 8 to 15 lbs. Unstuffed 8 to 15 lbs. Stuffed 8 to 24 lbs. Unstuffed 8 to 24 lbs. Stuffed	For all turkeys Thigh – 175° to 180°F (79° to 82°C) Breast – 170°F (77°C) Stuffing – 165°F* (74°C)	8 to 15 min. @ 325°F (163°C) 9 to 16 min. @ 325°F (163°C) 7 to 11 min. @ 300°F (149°C) 9 to 12 min. @ 300°F (149°C)
Turkey Roast Boneless, 3 to 6 lbs.	170° to 175°F (77° to 79°C)	22 to 29 min. @ 350°F (177°C)
Turkey Breast Whole 4 to 6 lbs. with bone	170° to 175°F (77° to 79°C)	16 to 21 min. @ 325°F (163°C)
Chicken Unstuffed Stuffed	175° to 180°F (79° to 82°C) 175° to 180°F (79° to 82°C)	18 to 21 min. @ 350°F (177°C) 19 to 22 min. @ 350°F (177°C)
Chicken, Halves 2-1/2 to 4 lbs. each	175° to 180°F (79° to 82°C)	20 to 25 min. @ 350°F (177°C)
Chicken Pieces	175° to 180°F (79° to 82°C)	Total Time: 60 minutes @ 375°F (177°C)
Cornish Game Hens Stuffed Unstuffed	175° to 180°F (79° to 82°C) 175° to 180°F (79° to 82°C)	40 to 50 min. total time @ 375°F (190°C) 45 to 55 min. total time @ 375°F (190°C)

*If stuffing temperature is not 165°F (74°C) when turkey is done, remove stuffing to casserole and continue to cook stuffing.

Techniques

- Roast poultry on rack level 2 or 3. For very large turkeys use rack level 1.
- Use the 2-piece broil pan that comes with your oven. Place poultry directly on top of the grid for better browning. Place turkeys larger than 20 pounds on a rack in the lower part of the broil pan.
- When roasting whole chickens or turkey, tuck wings behind and loosely tie legs with kitchen string.

- Do not truss the legs of an unstuffed bird.
- Shield ends of legs, wing tips, bony parts of the breast and any thinner parts with foil during the first half of the roasting to prevent over cooking.
- For juicer breast meat, start breast side down. Shield only the legs, wings and thin parts.
- Check 30 minutes before the estimated minimum roasting time for doneness. Juices will run clear and the drumstick (on whole birds) will move freely when poultry is done.
- Roasting bags are suitable to use in this mode.

Broil Techniques

BROIL MODE

Broiling is cooking with intense heat radiated from the upper element of the oven which produces excellent results in both cooking and top browning. This method sears the outer layer of the food.

Foods Recommended for Broil Mode:

Appetizers
Fish Fillets
Meat (tender, such as steaks or chops)
Hamburgers
Poultry Pieces
Top Browning (Breads, Casseroles)

General Guidelines

- Start with cold meat directly from the refrigerator.
- Slash the outside fat around the edges of the meat to keep it from curling.
- Place the rack in the desired position, before turning on the oven.
- Check the Broil Chart on Page 24 for the best rack level to use for the particular type and thickness of food being broiled.
- Most broiling is done on rack 5 or 6. If the outside browns too quickly, reduce the broil setting or lower the rack level.
- Most food needs to be turned over only once, after half the total cooking time. Chicken pieces and halves need to be turned over after more than half the total cooking time. Start chicken with skin side down.
- Use **TIMER 1** or **2** to set reminder time to turn food.
- **Do not preheat the broiler.** Foods broil best starting with a cold oven.
- Leave the door closed. Closed door broiling gives a deep char to the tops of food and allows the control panel to stay cool to touch.
- If the oven is hot from previous cooking, cool it before broiling, for best broiling results.

During cooking, open the oven door carefully as there will be an accumulation of smoke and steam released into the cooler air in the kitchen.

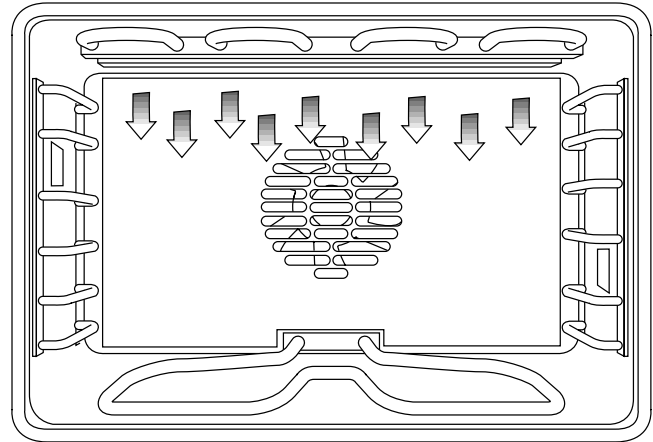

Utensils

- Use the two piece broil pan and grid provided with the oven. The slotted grid allows the meat fat to drip into the lower pan which minimizes spattering of fat. **DO NOT** cover the slotted grid (top) with aluminum foil. However, the bottom pan may be lined with foil.
- Use metal or glass-ceramic bakeware (Corning™) when top browning casseroles, main dishes, or bread.
- **DO NOT** use heatproof glass (Pyrex™) or pottery. This type of glassware cannot withstand the intense heat of the broil element.
- Avoid setting the broil pan on the opened oven door.
- Clean broil pan and grid after each use. Do not allow grease and fat to accumulate and remain in pan.
- Do not use other pans for broiling, such as cookie sheets, cake pans, half-sheet pans or jelly roll pans.

Broil Mode Operation



COOK TIME	STOP TIME
TIMER 1	TIMER 2
CLOCK	OVEN LIGHT

1	2	3
4	5	6
7	8	9
0		

BROIL	
BAKE	OFF
BROIL	SELF CLEAN
CONVECTION	CONVECTION ROAST

SETTING THE OVEN TO BROIL
For Broil Techniques and rack levels, see Page 22. For Broil timings see Chart on Page 24.

TO SET BROIL:

WHAT YOU WILL DO	WHAT YOU WILL SEE
<ol style="list-style-type: none"> 1. Touch BROIL. 2. While BROIL flashes, touch a number pad and HI broil is selected. <p style="margin-top: 10px;"><i>After 5 seconds the BROIL stops flashing and ON appears.</i></p>	

TO SET A LOWER BROIL TEMPERATURE: (Optional)

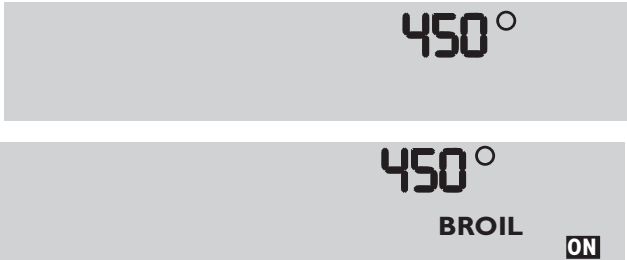
WHAT YOU WILL DO	WHAT YOU WILL SEE
<p>Follow steps 1 and 2 above. <u>Immediately</u> after HI is displayed, touch 500 for Medium Broil or 450 for Low Broil. Example: 4, 5, 0 selects 450°F.</p> <p>(450°F = 232°C and 500°F = 260°C)</p> <p><i>After 5 seconds the BROIL mode will automatically start.</i></p>	

TO STOP BROILING OR TO TURN THE OVEN OFF:

WHAT YOU WILL DO	WHAT YOU WILL SEE
<p>Touch OFF for oven being used.</p> <p>The mode disappears, showing time remaining on Timer (if in use) or the Time of Day.</p>	

Note: If more than 5 seconds elapse between touching the BROIL pad and the number pad, the oven is **not** set and it will return to the previous display. If more than 5 seconds elapses between touching each number to complete a lower broil setting, 3 beeps will sound and display will briefly show **Err** before going blank.

Broiling Chart

See Broil Techniques, Page 22.

FOOD ITEM Thickness	RACK LEVEL (Position from Bottom)	BROIL SETTING	TOTAL COOKING TIME
Beef Steaks 3/4" to 1"	6	HI 550°F (290°C)	Med. Rare – 7 to 11 min. Med. – 8 to 12 min. Well – 9 to 14 min.
1-1/4" to 1/2"	5	HI	Med. Rare – 16 to 22 min. Med. – 22 to 25 min. Well – 26 to 32 min.
Breads 3/4" to 1" English Muffins Garlic Toast	6	HI	4 to 6 min.
Chicken Pieces/ Halves	4 or 5	LO 450°F (272°C)	30 to 45 min.
Franks Hot Dogs (Whole) Polish Sausage (cut in half)	6 6	HI HI	4 to 5 min. 7 to 9 min.
Fish 1/2" to 1"	5 or 6	MED 500°F (260°C)	8 to 12 min.
Ground Beef Patties 3/4" to 1"	6	HI	Med. Rare – 8 to 12 min. Med. – 9 to 14 min. Well – 10 to 15 min.
Ham Steak 1/2" 1"	6 6	HI HI	7 to 11 min. 12 to 15 min.
Lamb Chops 1/2" to 1" 1-1/4" to 1-1/2"	6 6	HI MED 500°F (260°C)	Med. – 12 to 17 min. Well – 15 to 20 min. Med. – 21 to 27 min. Well – 27 to 33 min.
Pork Chops 1/2" to 1"	6	MED 500°F (260°C)	Well – 18 to 25 min.

Techniques:

- Do not preheat the broiler. Foods broil best starting with a cold oven. Leave the door closed. Closed door broiling gives a deep char to the tops of food.
- If the oven is hot from previous cooking, cool it before broiling, for best broiling results.

- Use caution when opening the oven door as there will be an accumulation of smoke and steam released into the cooler air in the kitchen.
- Refer to Page 19 for Food Safety Guidelines.

Timed Cooking Feature Operation

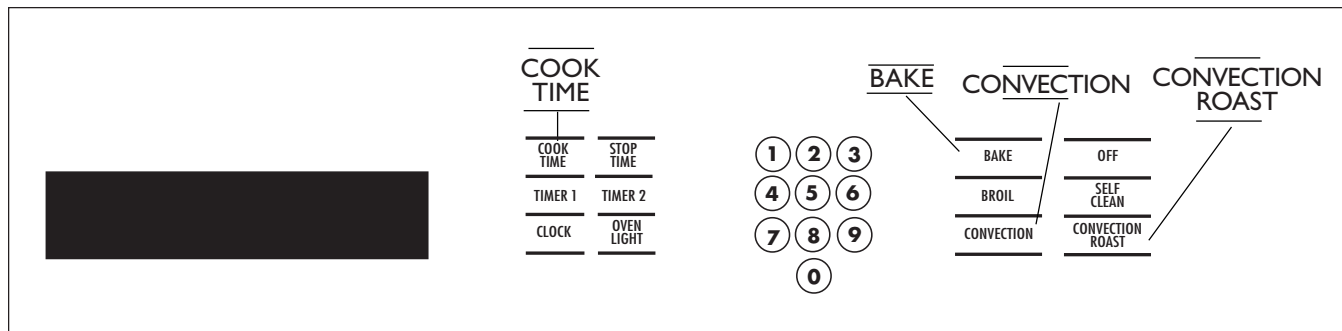

The Timed Cooking functions use the clock to automatically turn off the oven. Food left in the oven after it has turned off may overcook.

TO START NOW AND STOP AUTOMATICALLY:

Note: Before using timed cooking, make sure the clock is set to the correct time of day, see Page 9.

WHAT YOU WILL DO	WHAT YOU WILL SEE
1. Touch BAKE or CONVECTION or CONVECTION ROAST .	
2. While mode flashes, touch number pads to select desired oven temperature from 200° to 550°F (94° to 290°C). Example: touch 3, 2, 5 for 325°F.	
<p style="text-align: center;"><i>After 3 seconds the oven starts heating.</i></p>	
3. Touch COOK TIME .	
4. While mode flashes, touch number pads 1, 3, 0 to set 1 hour, 30 minutes. <i>Enter cooking time from 5 minutes to 11 hours and 55 minutes.</i>	
<p style="text-align: center;"><i>After 3 seconds the Time of Day (4:15) will reappear.</i></p>	
<p><i>When oven is preheated, the display will show Time of Day, oven temperature, oven and TIMED. If you touch STOP TIME, the time the oven will turn off displays momentarily and then returns to the Time of Day.</i></p>	

Timed Cooking (continued)

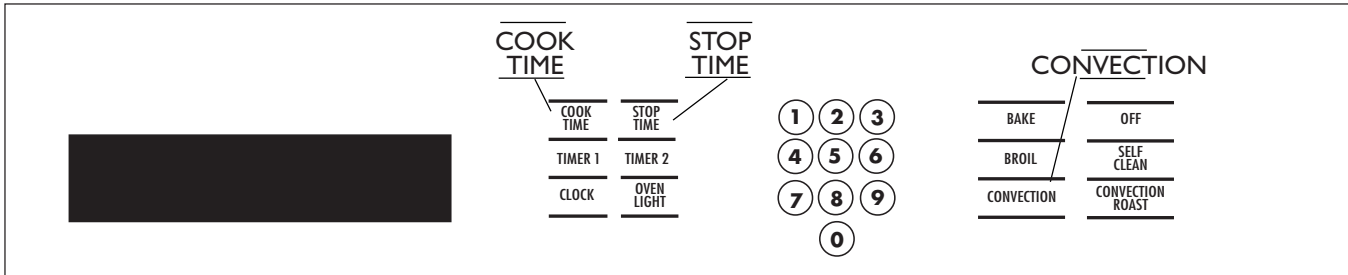

TO START AND STOP AUTOMATICALLY:

Note: Before using Timed Cooking, make sure the clock is set to the correct Time of Day.

WHAT YOU WILL DO	WHAT YOU WILL SEE
<ol style="list-style-type: none"> Follow preceding steps 1 - 4, on Page 25. Touch STOP TIME. STOP, OVEN and TIME flash. The current STOP TIME, 5:45, appears. While mode flashes, touch the number pads. Example: 6,3,0 selects 6:30. Time can be set up from 5 minutes to 11 hours and 55 minutes in the future, including the COOK TIME previously entered. 	
<p>The display will briefly show the Delay Start Time and then automatically return to the Time of Day, (example: 4:15) while indicating the oven is in a timed delay mode.</p>	
<p>The oven will turn on automatically at 5:00 and the cook time will begin to count down. Time of Day will be in the display. The oven will cook for 1 hour and 30 minutes and shut off automatically at 6:30.</p>	
<p>Touching Cook Time will cause the remaining cook time to momentarily reappear in the display. When cooking is done, the oven will shut off automatically, a chime will sound 4 times and End will appear in the display.</p>	

Notes:

- To check a **COOK TIME** or **STOP TIME**, touch the pad. Time programmed will show briefly and then Time of Day reappears in the display.
- When cooking is done, the oven will shut off automatically. A chime will sound 4 times and

End will appear in the display. If oven **OFF** is not touched, **End** will remain in the display and one chime will sound every 60 seconds for 10 minutes.

- While using Timed Cooking in the oven, the other sections can be used simultaneously.

Timed Cooking (continued)

TO CANCEL A TIMED COOK:

WHAT YOU WILL DO 1. Touch OFF pad. <i>Time of Day displays.</i>	WHAT YOU WILL SEE 
--	--

TO CANCEL THE TIMED FUNCTION ONLY:

WHAT YOU WILL DO 1. Touch and hold COOK TIME for 5 seconds. The oven will start immediately. The display will show 100° (38°C) and will count up in 5° (1°C) increments until the selected temperature is displayed.	WHAT YOU WILL SEE 
---	--

Child Lockout Feature Operation

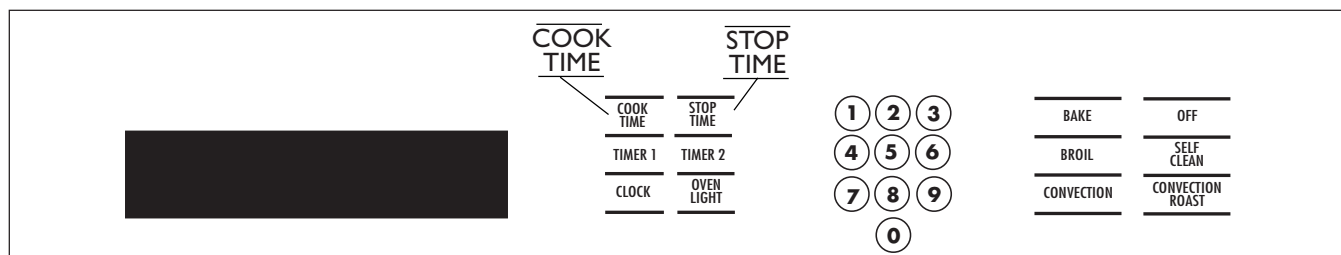

The oven has a provision for locking the control panel in the **OFF** position. This mode prevents accidentally turning on the oven while cleaning the control panel or from a child playing with the pads. Oven modes which are locked **OFF** are **BAKE, CONVECTION, CONVECTION ROAST, BROIL** and **CLEAN** for both ovens, if a double oven is being used. The functions which can always be used regardless of a lockout are: **TIMER 1** or **2, CLOCK,** and the oven **LIGHT**.

If an oven function is being used, the controls cannot be locked off.

TO SET CHILD LOCKOUT:

WHAT YOU WILL DO Touch and hold the COOK TIME pad and the STOP TIME pad simultaneously for 4 seconds.	WHAT YOU WILL SEE 
---	--

*The indicator word **OFF** will appear and remain in the display for 15 seconds. If someone touches an oven function pad, the indicator word **OFF** will again appear for 15 seconds.*

TO CANCEL CHILD LOCKOUT:

WHAT YOU WILL DO Touch and hold the COOK TIME pad and the STOP TIME pad simultaneously for 4 seconds.	WHAT YOU WILL SEE 
---	--

***OFF** will appear in the display briefly and then disappear.*

Self-Cleaning: Before and After

The oven features a pyrolytic self-cleaning mode. When set into the **CLEAN** mode, the oven reaches a high temperature that burns off the food soil.

- As a safety feature, the oven door locks during SELF CLEAN to protect you from very high temperature. Do not try to open the door during Self Clean.
- It is common to see smoke and/or an occasional flame-up during the **CLEAN** cycle, depending on the content and amount of soil remaining in the oven. If a flame persists, turn off the oven and allow it to cool before opening the door to wipe up the excessive food soil.
- The oven light will not turn on when the oven is set for a clean cycle.

NOTE: Due to the high temperatures used for self-cleaning, the oven may develop fine lines or surface roughness. This is a common condition and does not affect either the cooking or the cleaning performance of the oven.

BEFORE YOU SELF CLEAN

1. Hand-clean the oven door edge, window, outer window frame, oven front frame and oven cavity edges (shaded areas below). They do not get hot enough during the cleaning cycle for soil to burn away. Use a soapy sponge or scrubber sponge that is safe for glass. Do not rub the gasket.
2. **Wipe up large overspills and grease with paper towels.** Gently lift up bake element if necessary.
3. Remove all utensils.

4. **Remove oven racks.** If the oven racks are left in the oven during a Self Clean cycle, they will permanently lose their shiny finish and change to a dull dark finish. See the **Oven Cleaning Chart for proper care, Pages 30.**
5. Be sure the light is turned off on the control panel and the bulb and glass cover are in place, see Page 32.
6. Heat and odors are normal during the Self Clean cycle. Keep the kitchen well-ventilated.
7. **CONFIRM THAT THE OVEN DOOR LOCKS and WILL NOT OPEN before starting the SELF CLEAN mode. If the door does not lock, do not run Self Clean; phone 800/735-4328.**

AFTER SELF CLEAN

- When the oven heat drops to a safe temperature, the automatic door lock will release and the door can be opened.
- At the end of the **CLEAN** cycle, some gray ash may remain inside the oven. The amount of ash depends on how heavily soiled the oven was before it was cleaned. It is easily removed, when the oven is cold, using a damp sponge or cloth. If the racks do not slide easily after being cleaned, lightly rub rack side rails with vegetable oil.

IMPORTANT: Be sure to let the glass in the oven door cool completely before wiping up any ash left from the clean cycle.

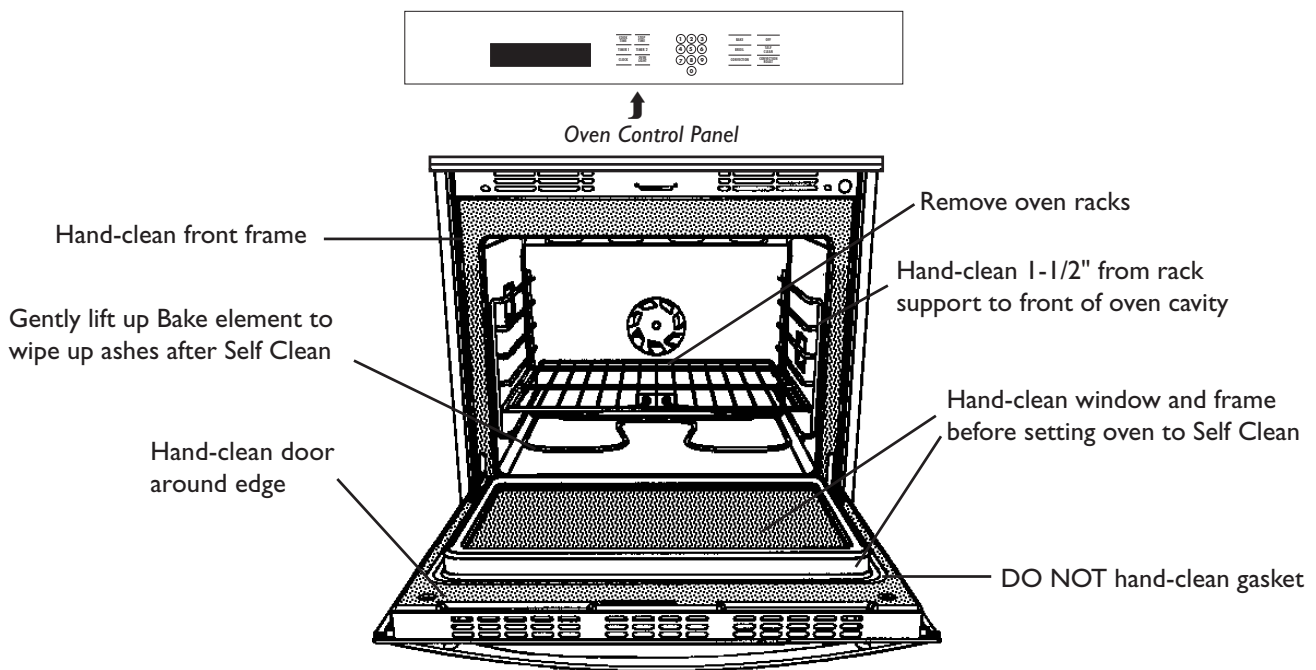

Setting the Self Clean Mode

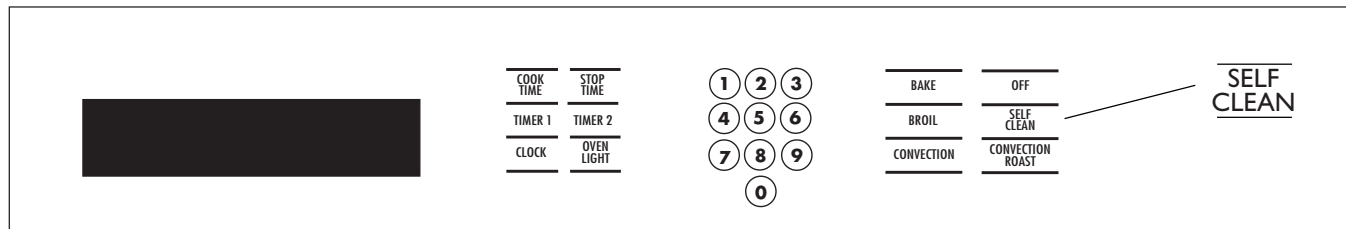

TO START SELF-CLEANING IMMEDIATELY:

WHAT YOU WILL DO	WHAT YOU WILL SEE
<p>Read and follow SELF-CLEANING: BEFORE AND AFTER on Page 28.</p> <ol style="list-style-type: none"> Close oven door and touch CLEAN. While CLEAN flashes, touch <u>any</u> number pad. It will automatically set the oven cleaning mode for 3 hours – normal soil. After 3 seconds, the flashing will disappear, the ON indicator glows, the door will auto-latch and Self Clean mode is programmed. <p>To Adjust Clean Time (optional) <i>If a shorter or longer time is desired, Follow steps 1 and 2 and when 3:00 flashes, touch 2, 0, 0 (2 hours – light soil) or 4, 0, 0 (4 hours – heavy soil).</i></p> <p>After the Self Clean cycle ends or is canceled: Time of Day (if a timer is not in use) displays.</p>	

TO DELAY THE START OF SELF CLEAN AND TURN OVEN OFF AUTOMATICALLY:

WHAT YOU WILL DO	WHAT YOU WILL SEE
<ol style="list-style-type: none"> Follow steps 1 through 2 above. Touch STOP TIME. If the Time of Day is 2:00 the STOP TIME would be 5:00. Touch 6, 0, 0 (to change the stop time to six o'clock). <p><i>After 4 seconds the program will automatically set. Display will briefly show time Self Clean will start. Display will revert to the Time of Day, and indicate a Delay Self Clean program.</i></p>	

Notes:

- If more than 4 seconds elapses between touching the **CLEAN** pad and touching a Number pad, the oven is not set and Time of Day will automatically return to the display.
- To check time remaining in self-clean cycle, touch **SELF CLEAN**. Display will briefly show the stop time and then return to Time of Day.
- To check time of day that oven will shut off, touch **STOP TIME**.
- To check Delayed Start and Stop time, touch **STOP TIME**. Display will cycle through Stop Time and Start Time before returning to Time of Day.
- If door is open, “door” will be displayed and a signal will beep for 4 seconds before returning to Time of Day. Self Clean mode cannot be selected if oven door is open.

General Oven Care

How to use the Oven Cleaning Chart

1. Locate the number of the part to be cleaned in the illustration on this page.
2. Find the part name in the chart.
 - Use the cleaning method in the left column if the oven is black or white.
 - Use the cleaning method in the shaded column if the oven is stainless steel.
3. Match the letter with the cleaning method on Page 31.

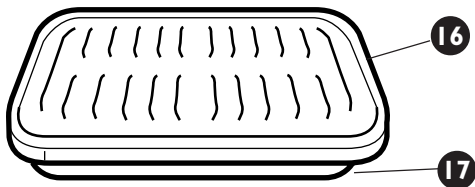
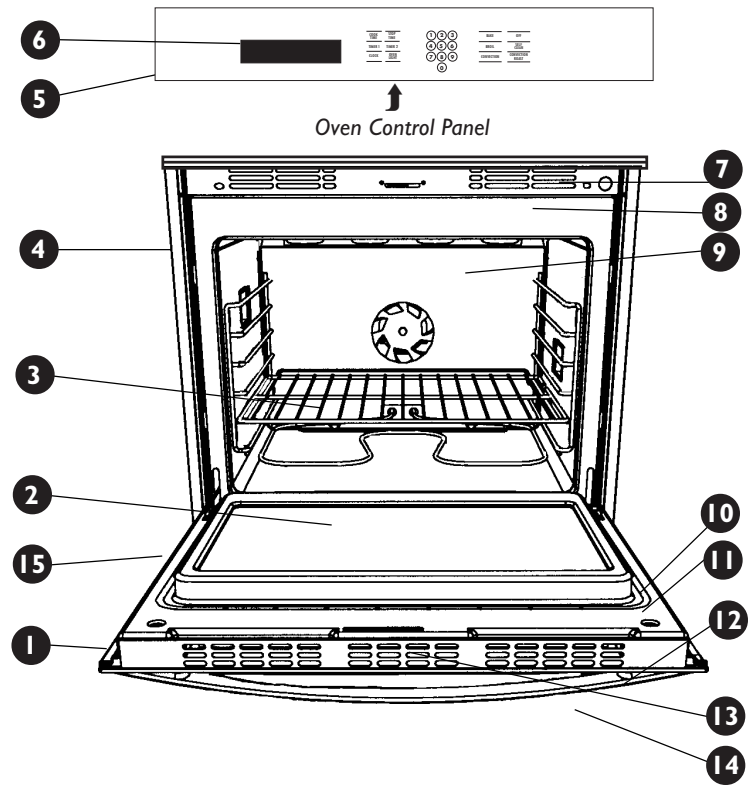

Part	Cleaning Method		Part	Cleaning Method	
	Blk / Wht Oven	Stainless Steel Oven		Blk / Wht Oven	Stainless Steel Oven
1 Door Frame	D	D	10 Seal (Gasket)	B	B
2 Interior Door Window	F	F	11 Interior Oven Door	E	E
3 Removable Oven Racks	A	A	12 Door Handle	D	D or G
4 Side Trim	D	D	13 Door Vent Trim	G	D
5 Control Panel Trim	D	D	14 Door Front	C	C & G
6 Control Panel	C	C, G	15 Vent Trim (below door)	D	D
7 Oven Cooling Vents	D	D	16 Broil Grid Top	A	A
8 Oven Front Frame	E	E	17 Broil Pan Bottom	E	E
9 Oven Cavity	E	E			

Oven Finishes / Cleaning Method

The entire oven can be safely cleaned with a soapy sponge, rinsed and dried. If stubborn soil remains, follow the recommended cleaning methods below.

- Always use the mildest cleaner that will do the job.
- Rub metal finishes in the direction of the grain.
- Use clean, soft cloths, sponges or paper towels.
- Rinse thoroughly with a minimum of water so it does not drip into door slots.
- Dry to avoid water marks.

The cleaners recommended below indicate a type and do not constitute an endorsement. Use all products according to package directions.

PART	CLEANING METHOD
A Chrome Plated	Wash with hot sudsy water. Rinse thoroughly and dry. Or, gently rub with Soft Scrub [®] , Bon-Ami [®] , Comet [®] , Ajax [®] , Brillo [®] or S.O.S. [®] pads as directed. Easy Off [®] or Dow [®] Oven Cleaners (cold oven formula) can be used, but may cause darkening and discoloration. The broil pan top may be squirted with liquid detergent and covered with wet paper towels while pan is hot. Allow to stand.
B Fiberglass Knit	DO NOT HAND-CLEAN GASKET. LEAVE AS IS.
C Glass	Spray Windex [®] or Glass Plus [®] onto a cloth first, then wipe to clean. Use Fantastik [®] or Formula 409 [®] to remove grease spatters.
D Painted	Clean with hot, sudsy water or apply Fantastik [®] or Formula 409 [®] first to a clean sponge or paper towel and wipe clean. <u>Avoid using powdered cleansers and steel wool pads.</u>
E Porcelain	Immediately wipe up acid spills like fruit juice, milk and tomatoes with a <u>dry</u> towel. Do not use a moistened sponge/towel on hot porcelain. When cool, clean with hot, sudsy water or apply Bon-Ami [®] or Soft Scrub [®] to a damp sponge. Rinse and dry. For stubborn stains, gently use Brillo [®] or S.O.S. [®] pads. It is normal for porcelain to craze (hairlike lines) with age due to exposure from heat and food soil.
F Reflective Glass Interior door Window	BEFORE SELF-CLEANING , clean with detergent and a plastic scrubber, or gently use new Brillo or S.O.S. [®] steel wool pads. Wipe thoroughly with a clean moistened sponge to remove residue. Repeated scrubbing with Brillo [®] or S.O.S. [®] pads will scratch glass. Do not use S.O.S. [®] scrubber sponges unless specified safe for glass.
G Stainless Steel	Always wipe or rub with grain. Clean with a soapy sponge; rinse and dry. Or, wipe with Fantastik [®] or Formula 409 [®] sprayed onto a paper towel. Protect and polish with Stainless Steel Magic [®] and a soft cloth. Remove water spots with a cloth dampened with white vinegar.

Do-It-Yourself Maintenance

REPLACING THE OVEN LIGHT

⚠ WARNINGS:

To prevent electrical shock and or personal injury:

- **Before replacing the light bulb, be sure the electric power is turned off at the circuit breaker.**
- Do not operate the oven unless the light cover is securely in position.
- Halogen bulbs get HOT instantly when turned ON.
- Be sure the oven and light bulb are cool.

⚠ AVERTISSEMENTS:

Pour empêcher le choc électrique et/ou la blessure personnelle:

- **Avant de remplacer l'ampoule, soyez certain l'interrupteur d'éclairage automatique sur le cadre du four est déprimé.**
- Ne pas faire fonctionner le four sauf si la couverture d'éclairage est solidement dans sa place.
- L'ampoule d'Halogène ALLUMÉE devient CHAUDE immédiatement.
- Soyez certain que le four et l'ampoule sont frais.

24-HOUR CLOCK OR CENTIGRADE FORMAT

Your oven has been preset to a 12-hour clock format and F° temperature. Two people will be needed to change the clock to a 24-Hour format or a temperature to C°.

1. Turn electric power to the oven OFF at the circuit breaker.
2. While touching either TIMER 1 or TIMER 2 pad, turn power on at breaker. Number 12 and F will appear in the clock window. Release TIMER pads.
3. Touch BAKE pad and 24 replaces 12 in the clock window. This will toggle with repeated touches of BAKE.
4. Touch BROIL pad and C replaces F. These will toggle with repeated touches of BROIL.
5. To complete the change, touch OFF pad.
6. Set the correct Time of Day, see Page 9.

CAUTION: If the light cover is damaged or broken, do not use the oven until a new cover is in place.

ATTENTION: Si la couverture d'éclairage est endommagée, ou cassée, **ne pas utiliser le four** jusqu'à une nouvelle couverture est en place.

The oven lights are located, on the left and right side walls of the oven. The lights have a removable lens cover and a halogen light bulb. The ceramic light socket housing is not removable by the user.

- Replace bulb with a 12-Volt, 10-Watt Halogen bulb only.

Before replacing bulbs, turn off oven circuit.

To replace Halogen Bulb:

1. Remove oven racks.

2. Slide the tip of a table knife blade between oven wall and the center of the side of the protective glass lens cover.

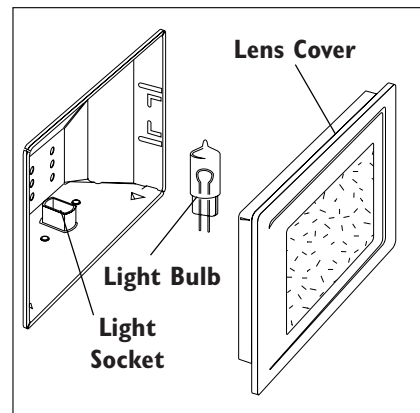

3. Support the glass lens cover with two fingers along the bottom edge to prevent the cover from falling to the bottom of the oven.
4. Gently twist the knife blade to loosen the glass lens cover.
5. Remove the glass lens cover.
6. Remove the bulb by grasping and sliding the bulb straight up until the two prongs have cleared the ceramic holder.
7. Do not touch the glass of the new replacement bulb with your fingers. It will cause the bulb to fail when it first lights. Grasp the replacement bulb with a clean paper towel or facial tissue with the prongs facing down. Locate the two prongs in the ceramic holder, gently poking until the two prongs locate in the ceramic socket.
8. Press down to seat the bulb.
9. Snap the protective glass lens cover over the bulb housing.
10. Turn on circuit breaker.

Do-It-Yourself Maintenance

REMOVING THE OVEN DOOR

The oven doors can be lifted off for your convenience in cleaning hard-to-reach areas inside the oven.

- Use caution when removing the door as it is very heavy.

To Remove the Oven Door

1. Fully open the oven door.
2. Raise the U-clip over the hook on each of the hinges to the "locked" position (see illustration below). This will prevent the hinge from snapping closed when the door is removed.
3. Grasp the door by the sides toward the back. Raise the front of the door several inches (there will be some spring resistance to overcome because of the hinge being locked). When the front of the door is high enough, you will be able to lift the hinges to clear the indents.
4. Pull the hinges out of the slots in the oven front frame.

To Replace the Oven Door

1. Grasp the sides of the door at the center and insert the ends of the hinges into the slots in the oven front frame as far as they will go (see illustration below).
2. With the door open all the way, lower the two locking clips.
3. Raise the oven door and make sure that it fits evenly with the front sides.

! WARNING:

With the door off, never release the levers and try to close the hinges. Without the weight of the door, the powerful springs will snap the hinges closed with great force.

! AVERTISSEMENT:

Avec la porte enlevée, ne jamais délivrer les leviers et essayer de fermer les charnières. Sans le poids de la porte, les ressorts puissants casseront les charnières fermées avec une grande force.

DOOR HINGE

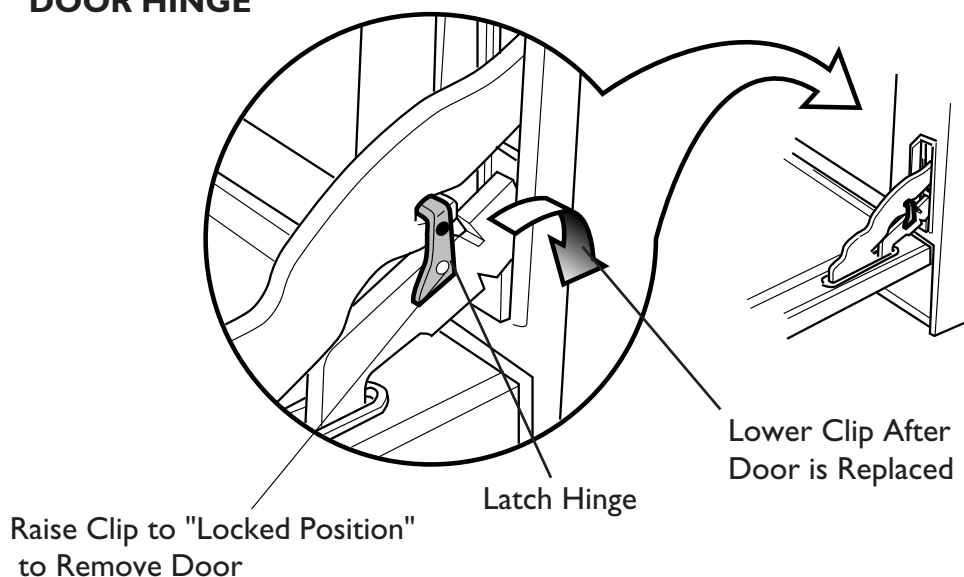

Do-It-Yourself Maintenance

OVEN TEMPERATURE CALIBRATION

Your oven has an electronic thermostat which accurately maintains the selected temperature. However, if foods generally over brown or under brown in the cooking time given in your recipe, you have the option to recalibrate the oven.

To recalibrate your oven, use the Bake pad and number pads:

1. Touch Bake and then any number between 500° to 550°F or 260° to 290°C.
2. Touch and hold Bake for 3 to 4 seconds. Display will show 00° for 4 to 5 seconds.

3. Enter desired temperature from plus or minus 0° to 35°F in 5°F increments (0° to 21°C in 3°C increments).
4. By touching Broil repeatedly, it will toggle between positive and negative degrees (–) for the increment entered.
5. Press **OFF** to exit this calibration mode or it will disappear automatically.

Notes:

1. You can verify your new calibration by repeating the above procedure.
2. If you first put in -5°F and then want to drop the temperature an additional -5°F, put in -10°F the second time you recalibrate. The numbers entered are not cumulative.

Signals and Control Panel Display

Window Display Area Shows the Following:

- Time of Day
- Countdown of time remaining when using timed mode.
- Temperature of oven as it rises to reach programmed temperature and the set temperature once it is reached.
- Recall programmed temperature or time when Clock, Bake, Convection, Convection Roast, Broil, Timer 1 or Timer 2, Start Time, and Stop Time are touched.
- Rounding of display numbers. Temperature ranges from 100° to 550°F (38° to 290°C) and can be set at any number in that range. In the Fahrenheit display, the display will round to the closest 5°F, Example: 348°F will round the temperature to 350°F.
- **1** and **2** to show which Timer is set.

Clock / Timer Priorities:

- Timers have the first priority in the window display. If a timer is in use the clock can only be viewed by touch the **CLOCK** pad.
- If two timers are being used, the one with the shortest time will have the priority. If **TIMER 1** is in use with 10 minutes remaining and **TIMER 2** is in use with 5 minutes remaining, **TIMER 2** will be displayed. The **TIMER 1** or the Time of Day may be viewed by touching the **TIMER 2** or **CLOCK** pad. **TIMER 1** or the Time of Day will display briefly and then return to **TIMER 2** countdown.

Chimes / Beeps

- A chime sound is used to designate feedback for programming, the end of a timing or cooking operation.
- A beep sound is used to designate an incorrect entry, door is open when set for a Self Clean mode, or as a fault indicator.

Solving Baking Problems

With either BAKE or CONVECTION, poor results can occur for many reasons other than a malfunction of the oven. Check the chart below for causes of the most common problems. Since the size, shape and material of baking utensils directly affect the baking results, the best solution may be to replace old baking utensils that have darkened and warped with age and use. Check the Baking Charts on Pages 16 – 18 for the correct rack level.

BAKING PROBLEM	CAUSE
Food browns unevenly	<ul style="list-style-type: none"> • Oven not preheated. • Aluminum foil on oven rack or oven bottom. • Baking utensil too large for recipe. • Pans touching each other or oven walls.
Food too brown on bottom	<ul style="list-style-type: none"> • Oven not preheated. • Using glass, dull or darkened metal pans. • Incorrect rack level. • Pans touching each other or oven walls.
Food dry or has shrunk excessively	<ul style="list-style-type: none"> • Oven temperature too high. • Baking time too long. • Oven door opened frequently. • Pan size too large.
Food baking or roasting too slowly	<ul style="list-style-type: none"> • Oven temperature too low. • Oven not preheated. • Oven door opened frequently. • Tightly sealed with aluminum foil. • Pan size too small.
Pie crusts don't brown on bottom or have soggy crust	<ul style="list-style-type: none"> • Using shiny steel pans. • Oven not preheated. • Incorrect rack level.
Cakes pale, flat and may not be done inside	<ul style="list-style-type: none"> • Oven temperature too low. • Incorrect baking time. • Cake tested too soon. • Oven door opened too often. • Pan size may be too large.
Cakes high in middle with crack on top	<ul style="list-style-type: none"> • Baking temperature too high. • Baking time too long. • Pans touching each other or oven walls. • Incorrect rack level. • Pan size too small.
Pie crust edges too brown	<ul style="list-style-type: none"> • Oven temperature too high. • Edges of crust too thin. • Crust edge not shielded with aluminum foil.

Solving Operational Problems

Before calling for service, check the following to avoid unnecessary service charges.

PROBLEM OVEN	PROBLEM SOLVING STEPS
All the numbers touched do not appear in display.	The numbers were touched too rapidly. Be sure you remove your finger from the number pad between digits. Example: 4, 0, 0.
F-1 to F-9, FC, FF, F- or Fr flash in the display.	Touch OFF or turn power off at the circuit breaker, wait 3 minutes and turn it back on. If condition persists, note the code number and call an authorized servicer
F-7	This is caused by close contact to the control panel for more that 32 seconds, such as someone leaning against the controls or objects hanging in front of controls. Follow previous solution.
Clock and timer do not work.	Make sure there is proper electrical power to the oven. See the CLOCK and TIMER sections on Pages 9 - 10.
Cooling fan continues to run after oven is turned off.	The fan turns off automatically when the electronic components have cooled sufficiently.
Oven will not work.	Make sure there is proper electrical power to the oven. Check the circuit breaker or fuse box to your house.
Oven light does not work.	Replace or reinsert the light bulb if loose or defective (See Page 32). Touching the bulb with your fingers may cause the bulb to burn out quickly. Oven light does not work if CLEAN mode is set.
Oven temperature is too hot or too cold.	The oven thermostat needs adjustment. See the OVEN TEMPERATURE CALIBRATION in Do-It-Yourself Maintenance, Page 34.
Oven will not self-clean.	The oven temperature is too high to set the Self Clean operation. Allow the oven to cool to room temperature and reset the controls. Be sure you have touched CLEAN .
The oven door will not unlock.	Allow the oven to cool below the locking temperature.
Oven is not clean after the clean cycle.	Heavily soiled ovens may need to Self Clean again or for a longer period of time. Heavy spillovers with soft or liquid centers should be wiped up before starting the clean cycle. See Self Clean the Oven, Pages 28 and 29.

HOW TO OBTAIN SERVICE

For authorized service or parts information, call 800/ 735-4328.

We want you to remain a satisfied customer. If a problem does come up that cannot be resolved to your satisfaction write to Thermador Customer Support Call Center, 5551 McFadden Avenue, Huntington Beach, CA 92649 **or** call: 800/ 735-4328.

Please include the Model Number, Serial Number and Date of Original Purchase/Installation.

Thermador® Built-In Oven Warranty

For Models:

SCD302 / SCD272 / SC302 / SC301 / SC272

WHAT IS COVERED

Full One Year Warranty

For one year from the date of installation or date of occupancy for a new previously unoccupied dwelling, any part which fails in normal home use will be repaired or replaced free of charge. Save your dated receipt or other evidence of the installation/occupancy date. Thermador® will pay for all repair labor and replacement parts found to be defective due to materials and workmanship. Service must be provided by a Factory Authorized Service Agency during normal working hours.

WHAT IS NOT COVERED

1. Service by an unauthorized agency. Damage or repairs due to service by an unauthorized agency or use of unauthorized parts.
2. Service visits to:
 - Teach you how to use the appliance.
 - Correct the installation. You are responsible for providing electrical wiring and other connecting facilities.
 - Reset circuit breakers or replace home fuses.
3. Damage resulting from accident, alteration, misuse, abuse, improper installation or installation not in accordance with local electrical codes or plumbing codes, or improper storage of the appliance.
4. Repairs due to other than normal home use.

WARRANTY APPLICATIONS

This warranty applies to appliances used in normal family households; it does not cover their use in commercial situations.

This warranty is for products purchased and retained in the 50 states of the U.S.A., the District of Columbia and Canada. The warranty applies even if you should move during the warranty period. Should the appliance be sold by the original purchaser during the warranty period, the new owner continues to be protected until the expiration date of the original purchaser's warranty period.

THERMADOR® DOES NOT ASSUME ANY RESPONSIBILITY FOR INCIDENTAL OR CONSEQUENTIAL DAMAGES. Some states do not allow the exclusion or limitation of incidental or consequential damages, so the above limitation or exclusion may not apply to you. This warranty gives you specific legal rights and you may also have other rights which may vary from state to state or province to province.

SERVICE DATA RECORD

The location of the serial tag on the product can be seen inside the front cooling vents on the right-hand side. See Item 12 on Page 6. Now is a good time to write this information in the space provided below. Keep your invoice for warranty validation. To obtain service, see Page 36.

Model Number:
Serial Number:
Date of Installation or Occupancy:

We reserve the right to change specifications or design without notice. Thermador is not responsible for products which are transported from the U.S. for use in Canada. Check with your local Canadian distributor or dealer.

For the most up-to-date critical installation dimensions by fax, use your fax handset and phone (775) 833-3600. Use code #8030.



Thermador®

Thermador Customer Support Call Center, 5551 McFadden Avenue, Huntington Beach, CA 92649 • 800/735-4328
ECO 12784 • 5020005631 • 14-38-464L • © 2003 BSH Home Appliances Corp. • Litho U.S.A. 01/03

Free Manuals Download Website

<http://myh66.com>

<http://usermanuals.us>

<http://www.somanuals.com>

<http://www.4manuals.cc>

<http://www.manual-lib.com>

<http://www.404manual.com>

<http://www.luxmanual.com>

<http://aubethermostatmanual.com>

Golf course search by state

<http://golfingnear.com>

Email search by domain

<http://emailbydomain.com>

Auto manuals search

<http://auto.somanuals.com>

TV manuals search

<http://tv.somanuals.com>