

THETA DIGITAL

C O R P O R A T I O N

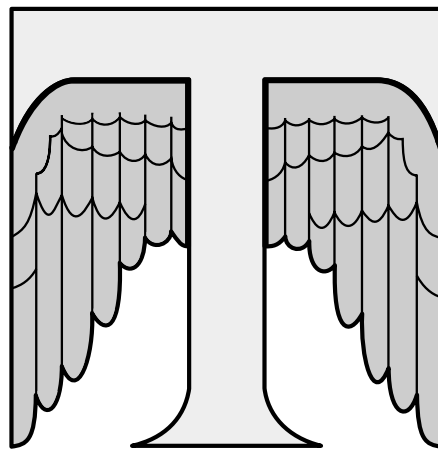

Intrepid
Owner's Manual

PREFACE

CONGRATULATIONS

You have just acquired one of the most advanced and versatile components for the amplification of audio ever to have been developed.

IMPORTANT

Save all packaging in a dry place away from fire hazards. Your Intrepid is a precision electronic instrument and should be properly packaged any time shipment is made. In the unlikely event that you have to return your Intrepid to the factory for service or updating, the original packaging will best protect the unit from shipping damage.

In order to achieve the fullest flexibility and enjoyment from your Intrepid, we at Theta recommend that you read this manual in full before connecting the unit to your audio/video system.

Note: It is imperative that the Intrepid be operated in a well-ventilated environment and that the immediate external temperature be maintained as specified. External cooling fans may be required in some cases. Do not stack any equipment directly above or below the Intrepid to protect it from overheating, as well as to protect the continued functionality of equipment near and around it.

Warning: Each channel is a balanced bridge amplifier, thus the negative speaker terminal is **NOT** a ground, and cannot be connected to a system ground or a loudspeaker system with a common ground. Consult your speaker manufacturer to ensure that any speaker in your system that will be connected to the Intrepid does **NOT** have internal circuitry with a common ground.

WARNING

United States law prohibits disposition of these commodities to Libya, Laos, North Korea, Cambodia or Cuba unless otherwise authorized by the United States.

© 2000 Theta Digital Corporation. All rights reserved.
Written and Illustrated by Glenn Buckley.

This manual is also available for download as a PDF file at Theta Digital's website. <http://www.thetadigital.com>

No part of this publication may be reproduced or transmitted in any form or by any means, electronic or mechanical, for any purpose, without the express written permission of Theta Digital Corporation.

	CAUTION RISK OF ELECTRICAL SHOCK DO NOT OPEN	
CAUTION: TO REDUCE THE RISK OF ELECTRICAL SHOCK, DO NOT REMOVE COVER (OR BACK) NO USER-SERVICEABLE PARTS INSIDE REFER SERVICING TO QUALIFIED SERVICE PERSONNEL		

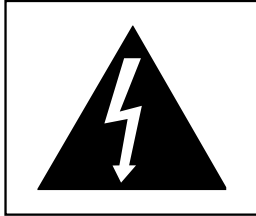

The lightning flash with arrowhead symbol, within an equilateral triangle, is intended to alert the user to the presence of uninsulated “dangerous voltage” within the product’s enclosure that may be of significant magnitude to constitute a risk of electric shock to persons.

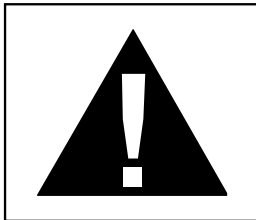

The exclamation point within an equilateral triangle is intended to alert the user to the presence of important operating and maintenance (servicing) instructions in the literature accompanying the product.

WARNING

**TO REDUCE THE RISK OF FIRE OR ELECTRIC SHOCK,
DO NOT EXPOSE THIS PRODUCT TO RAIN OR MOISTURE**

CAUTION: TO PREVENT ELECTRIC SHOCK, DO NOT USE THE AC (POLARIZED) PLUG WITH AN EXTENSION CORD, RECEPTACLE OR OTHER OUTLET UNLESS THE BLADES CAN BE FULLY INSERTED TO PREVENT BLADE EXPOSURE.

Extension cords are not recommended for use with this product.

Intrepid Identification Record

This information is for your records and for future identification of the Intrepid. Please take a moment to fill out all pertinent data now, and as upgrades and/or options are installed. **Whenever upgrades, inquiries and/or changes are requested, the serial number will be required.**

SERIAL NUMBER _____

DATE PURCHASED _____

DEALER'S NAME _____

DEALER'S ADDRESS/PHONE _____

INSTALLED CARDS/OPTIONS _____
(Date of installation)

(Date of installation)

(Date of installation)

SAFETY PRECAUTIONS

Please carefully read each item of the operating instructions and safety precautions before installing and using this product. Use extra care to follow the warnings written on the product itself and/or in the operating instructions. Keep the operating instructions and safety precautions for future reference.

CAUTION: TO REDUCE THE RISK OF ELECTRICAL SHOCK, DO NOT REMOVE ANY OF THE COVER PANELS.

NO USER-SERVICEABLE PARTS INSIDE. REFER ALL SERVICING TO QUALIFIED SERVICE PERSONNEL ONLY.

TO PREVENT FIRE OR SHOCK HAZARD, DO NOT ALLOW LIQUIDS TO SPILL OR OBJECTS TO FALL INTO ANY OPENINGS OF THE PRODUCT.

THIS UNIT IS SUPPLIED WITH A 3 PIN GROUNDED AC PLUG. ALWAYS INSERT THE AC PLUG INTO A GROUNDED OUTLET. DO NOT REMOVE THE GROUND PIN OR DISABLE THE GROUND FOR ANY PURPOSE.

BEFORE MAKING ANY CONNECTIONS TO THE INTREPID, FIRST TURN OFF THE POWER AND THEN DISCONNECT THE AC POWER CORD.

WHEN INSTALLING THE INTREPID IN YOUR SYSTEM, MAKE CERTAIN TO ALLOW A MINIMUM OF ½ INCH OF VENTILATION ON EACH SIDE OF THE UNIT. ALSO ALLOW AT LEAST 3 INCHES OF VENTILATION SPACE ABOVE THE UNIT. IMPROPER VENTILATION OF THE UNIT MAY CAUSE OVERHEATING, WHICH MAY DAMAGE THE UNIT AND CAUSE A FIRE. PLACE THE UNIT ON A SOLID SURFACE ONLY. I.E. NOT ON CARPET, ETC.

DO NOT PLACE THE INTREPID NEAR HEAT SOURCES SUCH AS DIRECT SUNLIGHT, STOVES, HEAT REGISTERS, RADIATORS OR OTHER HEAT PRODUCING EQUIPMENT.

TO PREVENT DAMAGE TO THE ANALOG OUTPUT CIRCUITRY, BE CERTAIN NOT TO SHORT THE OUTPUT SIGNAL TO GROUND. ENSURE THAT YOUR AUDIO OUTPUT CABLES DO NOT HAVE ANY INTERNAL SHORTS BEFORE CONNECTING THEM TO THE INTREPID.

IF REPLACEMENT OF THE AC LINE FUSE AND/OR ANY INTERNAL FUSE BECOMES NECESSARY, REPLACE ONLY WITH SAME VALUE AND TYPE OF FUSE. NEVER BYPASS THE FUSE.

IF THE AC CORD BECOMES DAMAGED, DO NOT USE IT. IMMEDIATELY REPLACE IT WITH A NEW ONE OF THE SAME OR BETTER RATING.

IT IS IMPERATIVE THAT THE INTREPID BE OPERATED IN A WELL VENTILATED ENVIRONMENT AND THE IMMEDIATE EXTERNAL TEMPERATURE BE MAINTAINED AS SPECIFIED. EXTERNAL COOLING FANS MAY BE REQUIRED IN SOME CASES. DO NOT STACK ANY EQUIPMENT DIRECTLY ABOVE OR BELOW THE INTREPID AS TO PROTECT IT FROM OVERHEATING, AS WELL AS THE CONTINUED FUNCTIONALITY OF ANY EQUIPMENT NEAR AND AROUND IT.

EACH CHANNEL IS A BALANCED BRIDGE AMPLIFIER, THUS THE NEGATIVE SPEAKER TERMINAL IS NOT A GROUND, AND CANNOT BE CONNECTED TO A SYSTEM GROUND OR LOUDSPEAKER SYSTEM WITH A COMMON GROUND. CONSULT YOUR SPEAKER MANUFACTURER TO ENSURE THAT ANY SPEAKER IN YOUR SYSTEM THAT WILL BE CONNECTED TO THE INTREPID DOES NOT HAVE INTERNAL CIRCUITRY WITH A COMMON GROUND.

AFTER MARKET and THIRD PARTY MODIFICATIONS

Please note that any after market and/or third party modifications will void the warranty. In the case of changing the feet on a unit, in order to prevent any damage (which will also not be covered under warranty), please verify that the screws being used to secure non-Theta feet do not screw any deeper into the chassis than the original ones. The original screw is 1/4-20 by 1/2 and goes into the chassis 1/4 inch.

Table of Contents

PREFACE	i
WARNING	ii
Intrepid Identification Record	iii
SAFETY PRECAUTIONS	iv
INTRODUCTION.....	1
Getting to know your Intrepid	1
Burn-In Time	1
Reference Manual Conventions	1
IMPORTANT NOTICE	2
Intrepid Block Diagram	3
Front Panel Layout	4
Rear Panel Layout.....	5
OPERATION	6
Connecting the Intrepid	6
Remote Trigger.....	6
RS232.....	6
Appendix A Troubleshooting Guide.....	7
Appendix B Wiring Diagram	8
Appendix C RS232 Protocol.....	9
RS232 Jumper Settings.....	12
Appendix D Specifications	13

INTRODUCTION

Getting to know your Intrepid

This Intrepid has been put through a rigorous and unique testing procedure that ensures that it will last for many years with minimal service requirements. This procedure includes the following:

- All assembled circuit boards are given a thorough visual inspection and are then tested in a bench-reference Intrepid.
- The tested, assembled circuit boards are then installed in a new Intrepid and the whole unit is tested for every function and parameter.
- The unit is put on a burn-in torture rack to test for any possible component failures.
- It is then tested on an audio analyzer for all pertinent parameters.
- The unit has all remaining chassis components installed and then undergoes a complete visual inspection, which assures that all Intrepids meet visual specifications.
- The Intrepid then undergoes a critical listening and functional test.

Burn-In Time

This unit has a break in period of about 1 week during which continuous improvement in sound quality will be observed. It is recommended that music be played continuously through the unit during this time to expedite the break in period.

Reference Manual Conventions

For clarity purposes, references to buttons and LED's will be shown in bold capital letters.

IMPORTANT NOTICE

- I. It is imperative that the Intrepid be connected to a ground via its three wire AC power cord. It is important that the AC power outlet, which the Intrepid is plugged into, is actually grounded. Failure to do so will severely compromise the performance, reliability and safety of use of the Intrepid.
- II. Ventilation is an important issue when placing the Intrepid in a system. Make certain that the Intrepid is placed in a well-ventilated area or rack unit. Heat must be dissipated and cool air must be allowed to enter the Intrepid.
- III. Please take note that some powerline conditioners defeat the AC power ground on their outlets. If the intention is to plug the Intrepid into a line conditioner, check with your dealer to make certain that the particular conditioner that is intended for use DOES NOT DEFEAT THE AC GROUND on its AC outlets. Only the highest powered line conditioners should be considered for use with the Intrepid. Otherwise, the amplifier's power output may be compromised.
- IV. DO NOT remove any cover panels from the Intrepid, as there are no user serviceable components inside. Refer servicing and updating to qualified service personnel only.
- V. Endcaps (**NOT** shorting plugs) on all unused RCA inputs will improve the sound quality and may reduce the susceptibility to RF induced anomalies.
- VI. It is imperative that the Intrepid be operated in a well ventilated environment and the immediate external temperature be maintained as specified in Appendix D of this manual. External cooling fans may be required in some cases. Do not stack any equipment directly above or below the Intrepid as to protect it from overheating, as well as the continued functionality of any equipment near and around it.
- VII. Each channel is a balanced bridge amplifier, thus the negative speaker terminal is **NOT** a ground, and cannot be connected to a ground or a loudspeaker system with a common ground. Consult your speaker manufacturer to ensure that any speaker in your system that will be connected to the Intrepid does **NOT** have internal circuitry with a common ground.

Intrepid Block Diagram

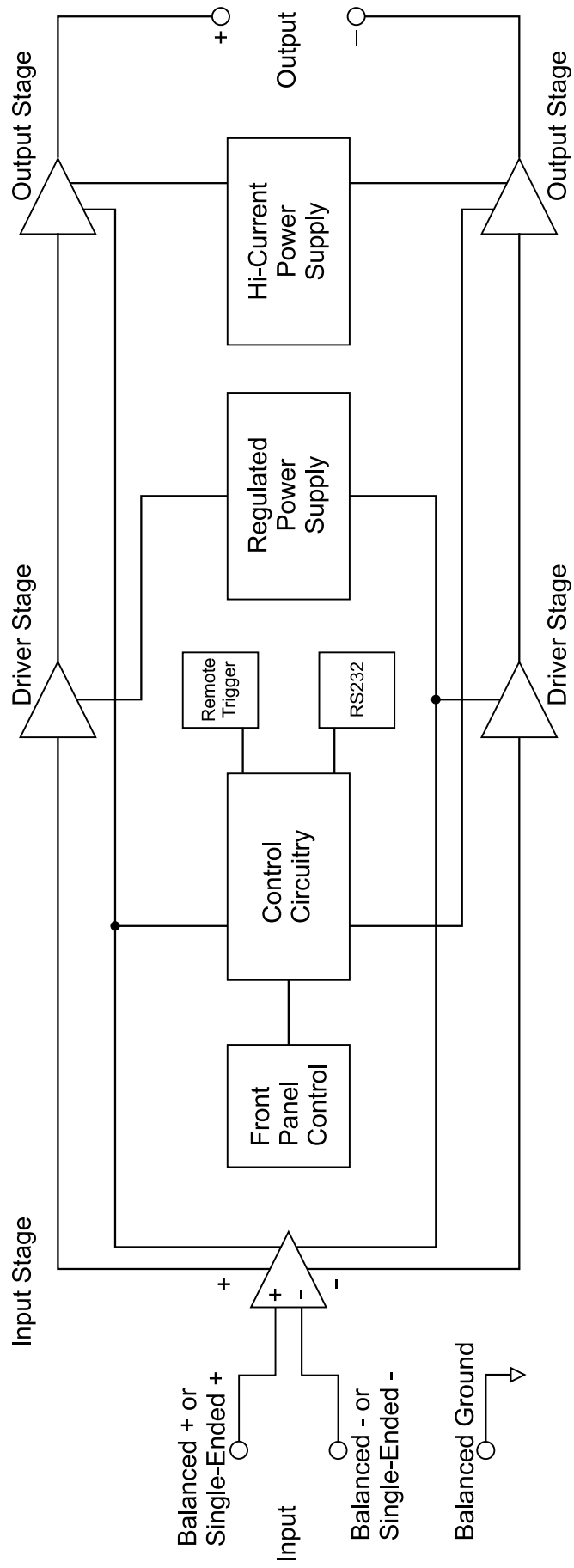

Figure 1 - Block Diagram (Intrepid showing one output module)

Front Panel Layout

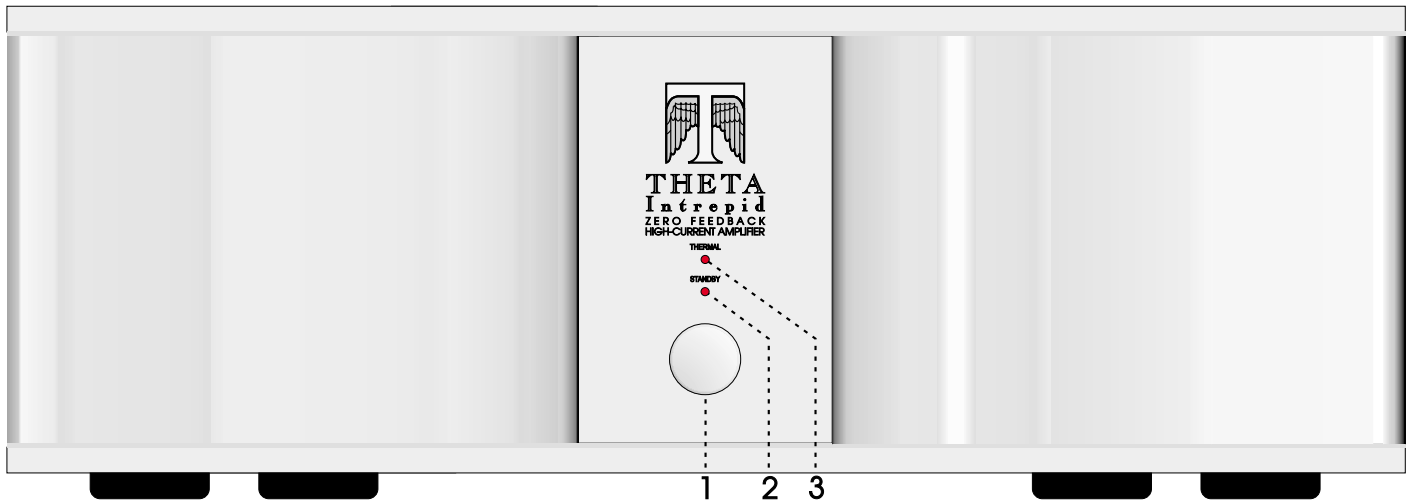

Figure 2 - Front Panel Layout

1. **STANDBY** button. After the rear panel **MAIN POWER** switch is turned on press the front panel **STANDBY** button to exit the standby mode. All channels will come out of standby.
2. **STANDBY** LED. Illuminates red when the power amplifier is in **STANDBY**, green when the amplifier is active.
3. **THERMAL** LED. Illuminates when any channel's temperature rises above the maximum operating temperature and puts the Intrepid into standby.

Rear Panel Layout

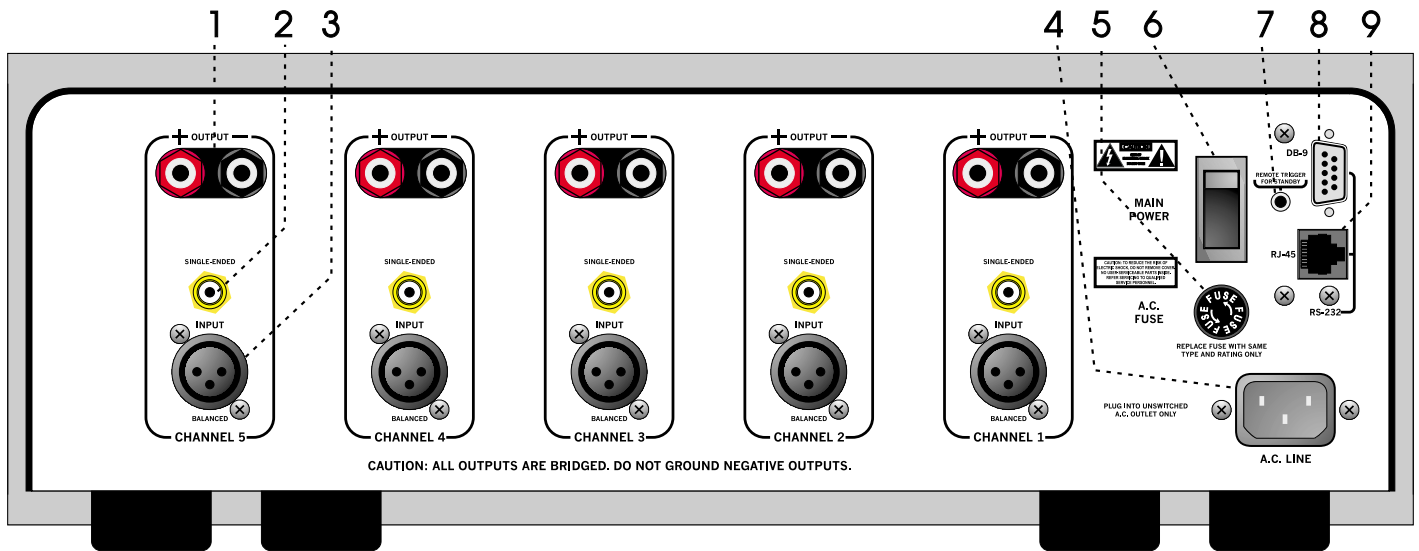

Figure 3 – Rear Panel Layout showing the optional RS-232 Jacks installed

1. **BINDING POST.** Connect plus and minus speaker wires for one speaker to appropriately marked terminals of each post. The binding posts can accept spade lugs, banana plugs or bare wire.
2. **SINGLE-ENDED** input jack.
3. **BALANCED** input jack.
4. **AC POWER INPUT.**
5. Rear panel **FUSE.** If necessary, replace with same type and rating only.
6. **Main Power Switch.** Master power switch. Disconnects AC to all circuits. It is recommended that this be left ON at all times during regular use with the exception of whenever cables are connected/disconnected or when the unit is not going to be used for an extended period of time.
7. **STANDBY REMOTE TRIGGER** jack. When the rear panel **STANDBY TRIGGER** jack receives a 5-12 VDC pulse the Intrepid will change its mode from either standby to operate, or operate to standby, depending on its current mode.
8. DB9 **RS232** connector. Used for connecting an external controller to the Intrepid to control and monitor its functions.
9. RJ45 **RS232** connector. See DB9 RS232 connector.

OPERATION

Before turning on the Intrepid, ensure that all precautions and warnings have been carefully reviewed and adhered to. Damage to the Intrepid caused by improper operation, wiring and/or ventilation will not be covered under warranty and Theta will not be liable for any consequential damage or loss.

Connecting the Intrepid

With the Intrepid's rear panel main power switch turned off, connect the signal outputs of each preamp/processor channel to either the single-ended or balanced input of the Intrepid. Connect each channel output to the input of the speaker that is intended to be driven. Please refer to figure 4.

Please Note: Each channel is a balanced bridge amplifier, thus the negative speaker terminal is **NOT** a ground, and cannot be connected to a ground or a loudspeaker system with a common ground. Consult your speaker manufacturer to ensure that any speaker in your system that will be connected to the Intrepid does **NOT** have internal circuitry with a common ground.

Connect a 12V pulse trigger source to the trigger input of the Intrepid, if it is desired to be taken in and out of standby via another device.

If the Intrepid's functionality is to be controlled from a remote controller via RS232, connect the RS232 cable between the Intrepid and the controller.

When first turning on the rear panel power switch, the red **STANDBY LED** on the front panel will illuminate, indicating that all channels are in standby mode. When in standby, the signal is muted and the output bias of each channel is reduced to approximately 40 percent.

Remote Trigger

When the rear panel **STANDBY TRIGGER** jack receives a 5-12 VDC pulse, the Intrepid will change its state from either standby to operate, or operate to standby, depending on what the current state is.

RS232

RS232 is an option in the Intrepid. It can be installed at any time either at the factory or by an authorized Theta dealer. All functions of the Intrepid can be controlled and monitored via RS232, using either the RJ45 or DB9 connector. As long as the rear panel power switch is turned on, the RS232 circuitry is always active, thus allowing the Intrepid to be taken out of **STANDBY** via RS232.

Appendix A Troubleshooting Guide

If the Intrepid should function abnormally during operation, please review the items in the following checklist. Please be sure to thoroughly check all other connected components such as speakers, preamplifiers, as well as cables.

Symptom	Possible Cause(s)	Remedy
No power or front panel lights and no sound.	Power cable is not inserted 100% into AC input connector.	Ensure that the AC cord is inserted all the way into the Intrepid and that the wall outlet is active.
	Rear panel fuse is open.	Replace with same type and rating ONLY.
No audio output.	Circuit breaker is open (AC outlet).	Check the AC outlet circuit breaker and reset, if necessary, or contact your dealer.
	Overheating	If the front panel THERMAL LED is illuminated, shut down the Intrepid until it cools. An external fan may be necessary.
Hot/Warm	Normal operation	

Appendix B Wiring Diagram

This section provides an example illustration of an input and output wiring scheme. Before making any connections, please turn off ALL audio and video devices. Unplug those that do not have a main power switch. It is recommended that all cables, including speaker cables be kept as short as possible for best sound quality.

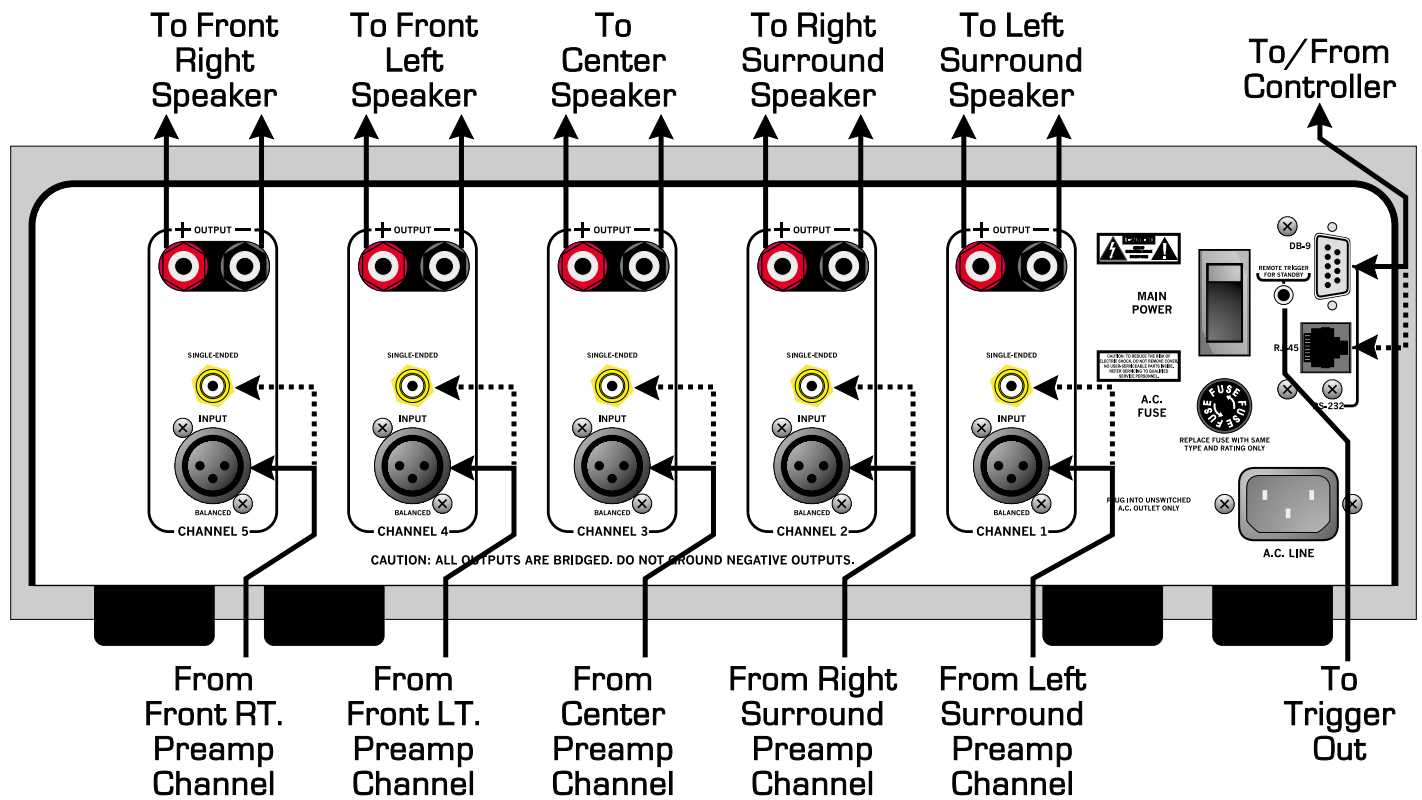

Figure 4 - Examples of Typical Input and Output Connections

----- = optional connection.

WARNING: Each channel is a balanced bridge amplifier, thus the negative speaker terminal is **NOT** a ground, and cannot be connected to a ground or a loudspeaker system with a common ground. Consult your speaker manufacturer to ensure that any speaker in your system that will be connected to the Intrepid does **NOT** have internal circuitry with a common ground. Damage will occur if the negative terminal is connected to ground, or to a terminal of another channel or module.

Appendix C RS232 Protocol

RS232 settings are internally definable via jumper blocks, to accommodate interfacing with a wide range of control products.

Baud rate	9600 or 19200
Echo status	AUTO or REQUEST

Baud rate: Maximum number of bits per second. The duration of a single bit is equal to $1 / \text{baud rate}$.
Echo status: Specifies whether the **STATUS** of each parameter shown in the protocol will automatically (**AUTO**) be echoed back to the controller when there is any change, or whether the user must manually request (**REQ**) the status information be sent to the controller. Please refer to page 12 or information on changing these settings.

All commands will follow the format:

<Header><Command Identifier><Argument 1><Argument 2><Argument 3>
where:

<Header> = <FEh><EEh>
<Command identifier> = <byte>
<Argument x> = <byte>

Each command will be able to access the system configuration directly, eliminating the need to press any button on the Intrepid front panel.

Example:

- 1) To put the Intrepid into standby: Send FE, EE, 01, 00, 00, 00 (all values in Hex).
Where FE and EE are the header, 01 = command, 00 = main standby, 00 = put unit in standby and 00 = filler (4 characters required)

Command	Description	Argument 1	Argument 1 Description	Argument 2	Argument 2 Desc	Argument 3	Arg 3 Desc
01	Standby	0	Main standby	0	Put unit in standby		
		0	Main standby	1	Take unit out of standby.		
02	Status	0	Return amplifier status.				
The RS232 can be set using a hardware jumper to automatically send changes to the RS232 port.							
Five bytes will be returned, the fifth byte contains no information.							
Status Byte #	Byte Description	bit	Value Description				
1	Standby	0	Main bus (1 = activate, 0 = standby)				
2	Temperature	0	Channel 1				
		1	Channel 2				
		2	Channel 3				
		3	Channel 4				
		4	Channel 5				
3	Fuse Plus Rail	0	Channel 1				
		1	Channel 2				
		2	Channel 3				
		3	Channel 4				
		4	Channel 5				
4	Fuse Minus Rail	0	Channel 1				
		1	Channel 2				
		2	Channel 3				
		3	Channel 4				
		4	Channel 5				
5	none		all bits = 0				

RS232 Hardware Connections

RTS and CTS are not implemented in the Intrepid

DB9

Pin	I/O	
1 - DCD	0	
2 - Intrepid sends on this pin	0	
3 - Intrepid receives on this pin	1	
4 - DTR	1	
5 - GND		
6 - DSR	0	
7 - RTS	1	
8 - CTS	0	
9 - Ring	---	

CN2

RJ45

Pin	I/O	
1 - RTS	1	
2 - DTR	1	
3 - Intrepid receives on this pin	1	
4 - GND		
5 - GND		
6 - Intrepid sends on this pin	0	
7 - DCD	0	
8 - CTS	0	

CN3

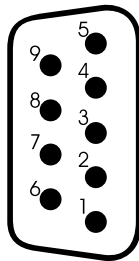

Rear panel view of DB9 connector
(From outside of unit).

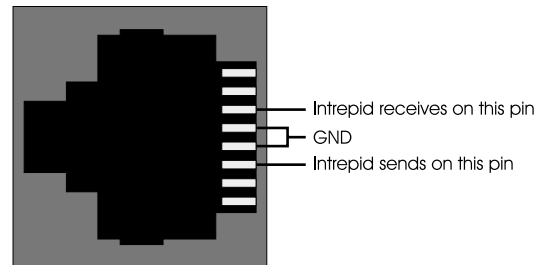

Figure 5 – Intrepid RS232 Jack Pinout

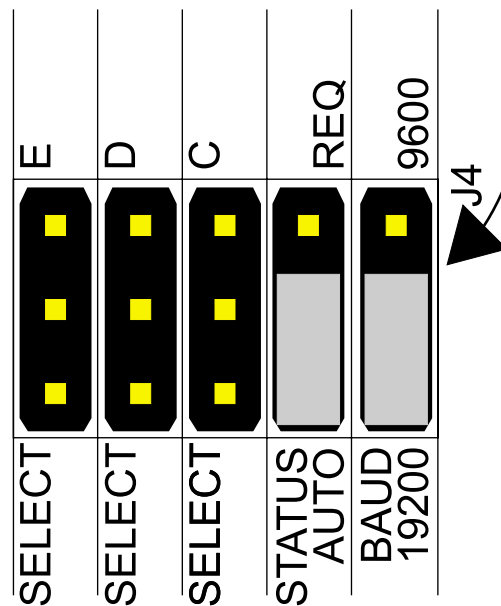
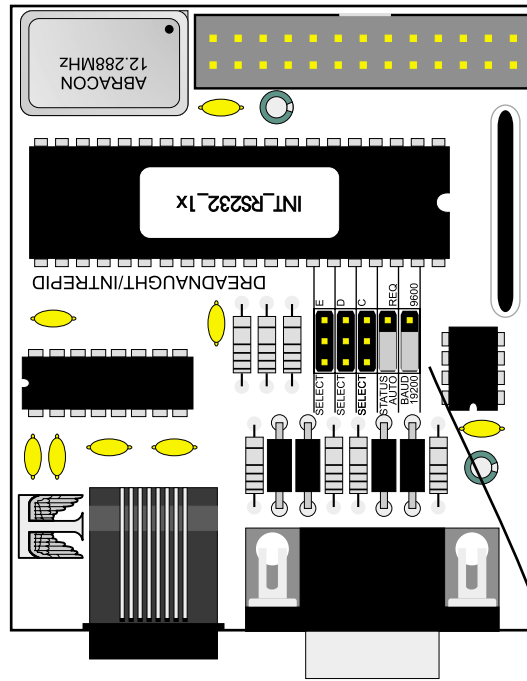

Figure 6 – Intrepid RS232 Jumper Settings

RS232 Jumper Settings

There are 2 possible Baud rates: **9600** and **19200**. The factory default is **19200**. To change the baud rate to **9600**, move the jumper to the center and top pins (if the RS232 board is orientated as in figure 6).

The **STATUS** can be returned to the controller either: automatically every time a parameter has changed, or the user can request it manually. The factory default is **AUTO**. To set the Echo **STATUS** to return Status information only upon request, move the **AUTO/REQ** jumper to the top pins, or nearer to **REQ** on the RS232 board.

The three **SELECT** jumpers are not currently implemented.

Appendix D Specifications

Inputs:	<u>Analog audio:</u> 1 Single-ended per channel (RCA). 1 Balanced per channel (XLR).
	Input Impedance: 50 K Ω Single-Ended or Balanced, for each phase.
	Input sensitivity: (Single-Ended) 1.5V RMS input for 100W into 8 ohms. (Balanced) 0.75V RMS input for 100W into 8 ohms.
	Gain: (Single-Ended) 25.5dB (19x). (Balanced) 31.5dB (38x).
	Polarity: (Single-Ended) Non-Inverting. (Balanced) Pin-2 = Positive, Pin-3 = Negative for Non-Inverting Output.
Outputs:	<u>Analog Audio:</u> 1 balanced output per channel.
I/O	<u>RS232:</u> 1 DB9 and 1 RJ45 connector.
Modes/Processes:	Standby: All channels are muted and output bias is reduced to 40%. Thermal: One or more channels has overheated; amp automatically switches to Standby.
Power Output:	(8 ohms-one channel driven) 100 W (rated) 130 W (typical) (8 ohms-five channels driven) 100 W (rated) 115 W (typical) (4 ohms-one channel driven) 200 W (rated) 210 W (typical)
Frequency Response:	(-3dB points @ full power) 0.9 Hz - 350 KHz.
THD+Noise:	<2%
Signal to Noise Ratio:	(unweighted) >100dB
Power Requirements:	117 VAC, 7.7 amp; 230 VAC, 4 amp; 50-60 Hz; for full power in all channels.
Power Consumption:	80W @ Standby; 100W @ idle; 900W @ full power.
Standby Trigger Input:	5-12 VDC Pulse between 1 and 500mS.
Dimensions:	17 5/8" W x 6 1/4" H x 20 1/2" D (448 x 159 x 521 mm)
Weight:	58 Lbs. Stand alone (26.3 Kg), 64 Lbs. Boxed with accessories (29 Kg)
Maximum Operating Temperature:	Internal: 176° F (80° C) Room: 131° F (55° C)

90 DAY LIMITED WARRANTY TERMS AND CONDITIONS
(3 Year optional extended service contract)

1. Theta Digital Corporation, henceforth referred to as Theta, warrants the product designated herein to be free of manufacturing defects in material and workmanship, subject to the conditions set forth herein, for a period of 90 days from the date of purchase by the original purchaser, henceforth referred to as purchaser. If the purchaser registers the unit with Theta by mailing in the warranty card, together with a copy of the bill of sale, within 14 days of the date of purchase, said purchaser will be registered for an extended service contract. The extended service contract extends the 90 days to a period of 3 years from the date of purchase by the original purchaser or no later than 7 years from the date of shipment to the authorized Theta dealer, whichever comes first.
2. **CONDITIONS**

This warranty is subject to the following conditions and limitations. The warranty is void and inapplicable if the product has been used or handled other than in accordance with the instructions in the owner's manual, abused or misused, damaged by accident or neglect or in being transported, or if the defect is due to the product being repaired or tampered with or modified by anyone other than Theta or an authorized Theta repair center. In the unlikely event that the unit requires service, contact Theta for an RA (Return Authorization) number. The product must be packed and returned to Theta or an authorized Theta repair center by the customer at his or her sole expense. Theta will pay return freight of its choice. A returned product must be accompanied by a written description of the defect, a photocopy of the original purchase receipt, and a daytime phone number where the owner can be reached. The unaltered receipt must clearly list model and serial number, the date of purchase, the name and address of the purchaser and authorized dealer and the purchase price. Theta reserves the right to modify the design of any product without obligation to purchasers of previously manufactured products and to change the prices or specifications of any product without notice or obligation to any person.
3. **REMEDY**

In the event the above product fails to meet the warranty, and the above conditions have been met, the purchaser's sole remedy under the limited warranty shall be to obtain an RA number and return the product to Theta or an authorized Theta repair center where the defect will be rectified without charge for parts or labor.
4. **LIMITED TO ORIGINAL PURCHASER**

This warranty is for the sole benefit of the original purchaser of the covered product and shall not be transferred to a subsequent purchaser of the product.
5. **DURATION OF WARRANTY**

This warranty expires 90 days after the date of original purchase. If Theta receives the completed warranty registration card within 14 days of original purchase, this period is extended to the third anniversary of the original date of purchase or no later than the seventh anniversary of the shipment to the authorized Theta dealer, whichever comes first.
6. **MISCELLANEOUS**

ANY IMPLIED WARRANTIES RELATING TO THE ABOVE PRODUCT SHALL BE LIMITED TO THE DURATION OF THIS WARRANTY. THE WARRANTY DOES NOT EXTEND TO ANY INCIDENTAL OR CONSEQUENTIAL COSTS OR DAMAGES TO THE PURCHASER. Some states do not allow limitations on how long an implied warranty lasts or an exclusion or limitation of incidental or consequential damages, so the above limitations or exclusions may not apply to you. This warranty gives you specific legal rights, and you may also have other rights which vary from state to state.
7. **WARRANTOR**

Inquiries regarding the above limited warranty may be sent to the following address:

THETA DIGITAL CORPORATION
5330 DERRY AVENUE, SUITE "R"
AGOURA HILLS, CA 91301

WARRANTY OUTSIDE THE USA

Theta has formal distribution in many of the countries of the free world, in each country the Theta Importer has contractually accepted the responsibility for product warranty. Warranty service should normally be obtained from the importing dealer or distributor from whom you obtained your product.

WARNINGS

1. To prevent fire or shock hazard, do not expose your Theta product to rain or moisture.
2. This unit contains voltages which can cause serious injury or death. Do not operate with covers removed. Refer all servicing to your authorized Theta dealer.
3. For continued protection against fire hazard, replace fuses only with the same type and rating of fuses as specified.

Free Manuals Download Website

<http://myh66.com>

<http://usermanuals.us>

<http://www.somanuals.com>

<http://www.4manuals.cc>

<http://www.manual-lib.com>

<http://www.404manual.com>

<http://www.luxmanual.com>

<http://aubethermostatmanual.com>

Golf course search by state

<http://golfingnear.com>

Email search by domain

<http://emailbydomain.com>

Auto manuals search

<http://auto.somanuals.com>

TV manuals search

<http://tv.somanuals.com>