

# Thule System Kit 2032

AUDI A6 Avant, 98-

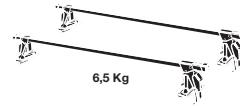

-  **64** x1
-  **65** x1
-  **26** x2

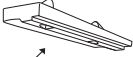
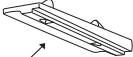
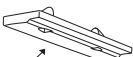
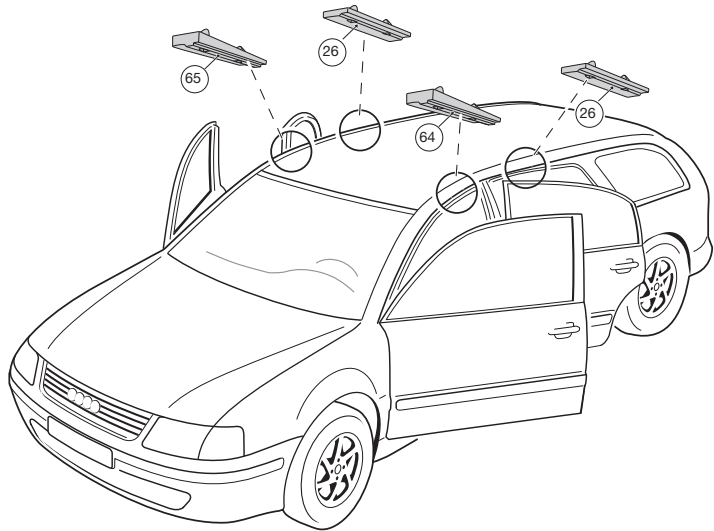
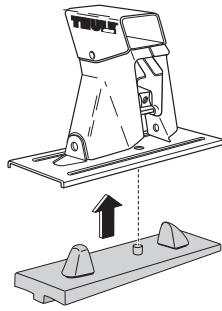

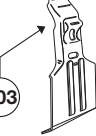
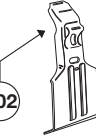
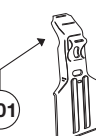
-  **403** x1
-  **402** x1
-  **401** x2

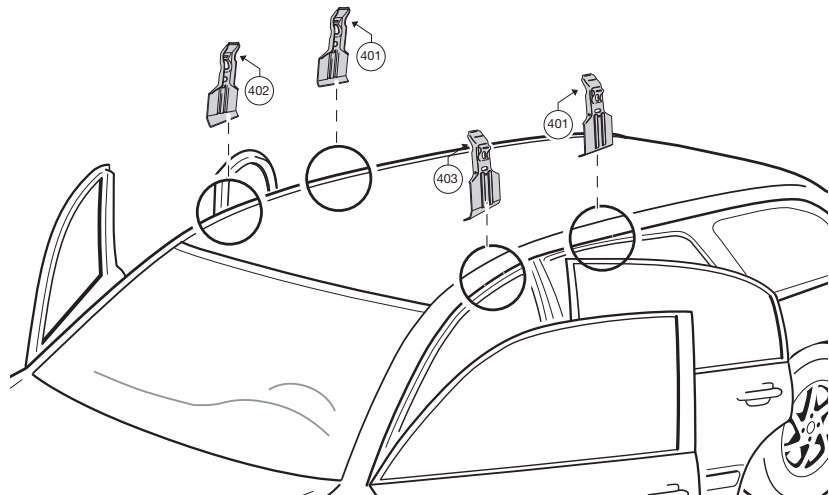

Front	Rear
968 mm / 38 1/8 inch	955 mm / 37 5/8 inch

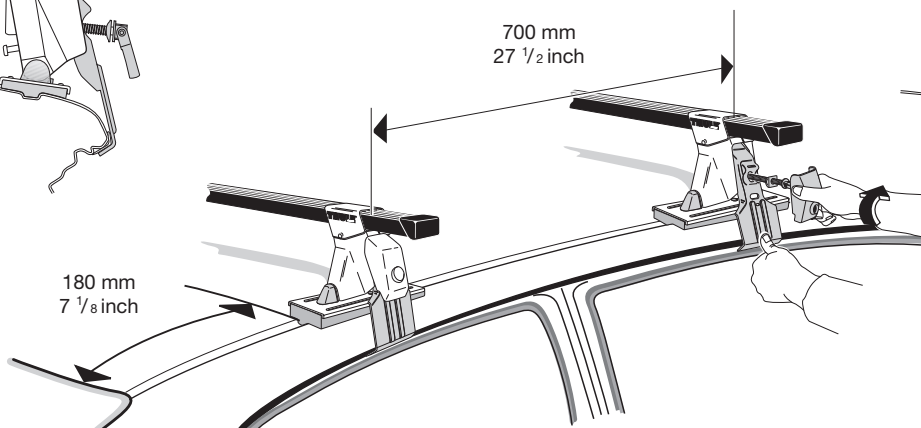
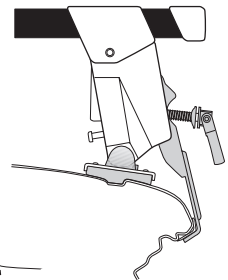
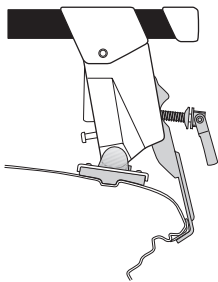

## Free Manuals Download Website

<http://myh66.com>

<http://usermanuals.us>

<http://www.somanuals.com>

<http://www.4manuals.cc>

<http://www.manual-lib.com>

<http://www.404manual.com>

<http://www.luxmanual.com>

<http://aubethermostatmanual.com>

Golf course search by state

<http://golfingnear.com>

Email search by domain

<http://emailbydomain.com>

Auto manuals search

<http://auto.somanuals.com>

TV manuals search

<http://tv.somanuals.com>