

WARNING: Your Sports Feel Bowling game contains motion detectors to sense your swing. You **DO NOT** actually roll or throw the ball. Always wear the wrist strap and keep a firm hold on the ball.

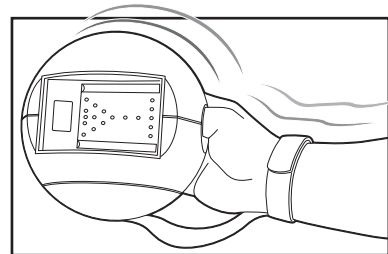

Swing but **DO NOT** release the ball!



INTRODUCTION

Let's hit the lanes! With Sports Feel Bowling, you'll actually get to aim the ball, swing the ball, control the power and spin, and listen with satisfaction as your ball strikes the pins! You can play alone, with a friend, or get in a little practice picking up those difficult spares. Sports Feel Bowling is so much like the real thing, the only thing missing is the funny shoes!

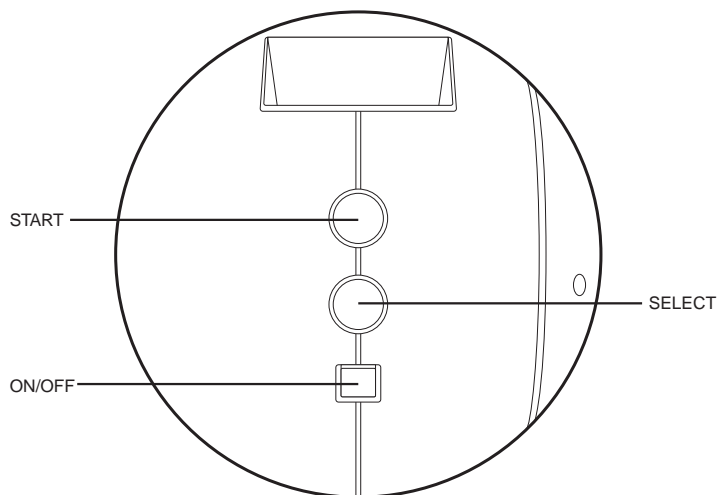
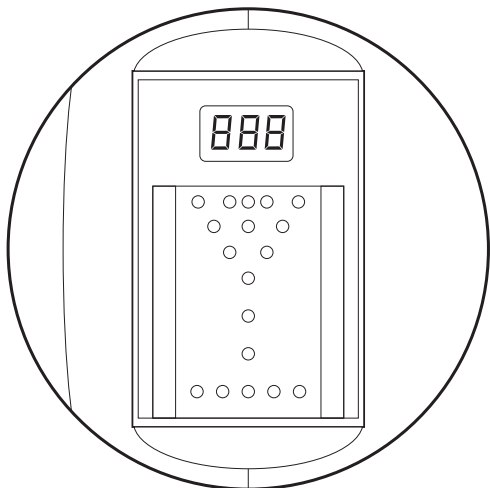

CONTROLS

- ON/OFF**
 - To turn the game on
 - To turn the game off (To conserve battery life, the game will automatically turn off after 3 minutes of no activity.)
- SELECT**
 - To choose game mode: **1-P**, **2-P**, or **SPARE** game
 - To choose left handed/right handed bowler
 - To choose bowler's stance
 - To choose ball aim
- START**
 - To confirm a selection and continue
 - To begin each frame

QUICK START

1. Press **ON** to turn on the unit.
2. Press **START** to enter **QUICKSTART** mode. The game settings are automatically set to **1-P**, right-handed, Normal game. You will start immediately with the first frame.

If you change the settings of a **1-P** game to left-handed, the next time you **QUICKSTART** the game your settings will be remembered.

GETTING STARTED

1. Press **ON** to turn on the unit. A melody will play.
2. Press **SELECT** to choose 1-Player, 2-Player, or Spare game, and **START** to confirm.
3. Press **SELECT** to choose right-handed or left-handed bowler, and **START** to confirm.
4. A melody will play and the game will begin.

NORMAL GAMES (1P or 2P)

Once the game is started, the screen will show whose turn it is (**1P** or **2P**), what frame you are on (**1F**) and your current score (**000**)

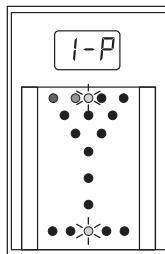

1. Press **START**. The light at the bowler's end of the lane will flash.

Press **SELECT** to move your stance along the lane. When you are positioned where you want to stand, press **START** to confirm.

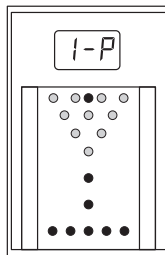

2. The light at the pins end of the lane will flash.

Press **SELECT** to move your aiming point along the lane. When you are positioned where you would like to aim, press **START** to confirm.

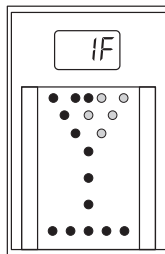

3. The pins remaining in the lane will light up.

Press **START** again to begin your swing.

You will hear a series of high-pitched beeps. These beeps indicate the power at which you will throw the ball -- one beep is a very weak throw, while five beeps is the strongest throw. Make sure that you are holding the ball firmly, with the wrist strap in place. First gently swing the ball backwards and then swing the ball just as you would in actual bowling. If you swing the ball backwards too fast or not in a smooth motion this could effect the motion sensor and change the ball movement. Make sure you bring the ball forward at just the power level you want. You will see and hear the ball travelling down the lane where it will (hopefully) strike the pins. It's as easy as that!

SCORING

All the normal rules for bowling apply. Each player bowls 10 "frames" and is allowed two throws to knock down all the pins. You receive 1 point for every pin you knock down.

If you knock down some of the pins on your first throw, and the rest of the pins on your second throw, this is called a **SPARE**. A spare is worth 10 points plus the total of your next throw.

If you knock down all 10 pins on your first throw, this is called a **STRIKE**. A strike is worth 10 points, plus the total of your next 2 throws.

If you get a **SPARE** or **STRIKE** in the 10th frame, you will receive "bonus" throws to complete the scoring. A spare in the 10th frame gives you one bonus throw. A strike in the 10th frame gives you two bonus throws.

In **2-P** games, each player is given two throws to complete the frame before play is passed to the other player.

HIGH SCORES

After a complete game, the unit will show your score as well as the high score. The high score is initially set at 150, but if you beat the high score, your new score will be kept as the new record! The highest score possible is 300 points, and is known as a perfect game. It is very difficult to achieve a perfect game.

The SPARE GAME

In this 1-player mode, the computer will offer you a number of pre-set spares.

1. Press **SELECT** to try one of eight spare configurations. Press **START** to confirm.
2. Aim and roll the ball exactly as for normal games.
3. If you score all 8 spare configurations, you will have a chance at a 9th bonus spare.
4. If you score the 9th spare, you will have a chance at a 10th bonus spare.
5. You are only allowed three misses. If you miss a 4th time, the game is over.

BOWLING TIPS

POWER: If you do not swing the ball within the first 5 beeps, the sequence will start over. After 4 sequences, if you still have not swung the ball, the frame will reset and you can start over.

SPIN: The game is sensitive to spin. If you twist your wrist left or right as you swing, the ball will spin and hook into the pins. If you know where to stand and where to aim, you can use spin to your advantage!

WRIST STRAP: You do **NOT** need to actually throw or roll the ball. Make sure you keep a firm hold on the ball at all times and use the wrist strap.

INSERTING THE BATTERIES

Using a screwdriver, loosen the screw on the battery compartment door located on the side of the unit.

Remove battery compartment door. Insert 3 "AA"/LR6 batteries, making sure to align the "+" and "-" signs.

Replace battery compartment door and screw.

CAUTION: Battery should be replaced by adult.

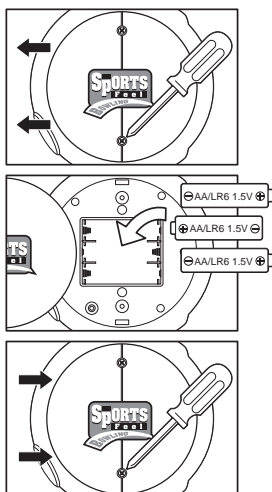

TO ENSURE PROPER FUNCTION:

- Do not mix old and new batteries.
- Do not mix alkaline, standard or rechargeable batteries.
- Battery installation should be done by adult.
- Non-rechargeable batteries are not to be recharged.
- Rechargeable batteries are to be removed from the toy before being charged (if removable).
- Rechargeable batteries are only to be charged under adult supervision.
- Only batteries of the same or equivalent type as recommended are to be used.
- Batteries are to be inserted with the correct polarity.
- Exhausted batteries are to be removed from the toy.
- The supply terminals are not to be short-circuited.

Replace with new batteries at the first sign of erratic operation.

DEFECT OR DAMAGE

If a part of your game is damaged or something has been left out, **DO NOT RETURN THE GAME TO THE STORE**. The store doesn't have replacement parts. Instead, write to us at:

TIGER REPAIR DEPARTMENT
1000 N. Butterfield Road, Unit 1023,
Vernon Hills, IL 60061, U.S.A.

In your note, mention the name of your game, your game's model number, and tell us briefly what the problem is. Also include sales slip, date, place of purchase and price paid. We will do our best to help.

90-DAY LIMITED WARRANTY

Tiger Electronics, Ltd. (TIGER) warrants to the original consumer purchaser of this product that the product will be free from defects in materials or workmanship for 90 days from the date of original purchase. This warranty does not cover damages resulting from accident, negligence, improper service or use or other causes not arising out of defects in materials or workmanship.

During this 90-day warranty period, the product will either be repaired or replaced (at TIGER'S option) without charge to the purchaser, when returned with proof of the date of purchase to either the dealer or to TIGER.

Product returned to TIGER without proof of the date of purchase or after the 90-day warranty period has expired, but prior to one year from the original date of purchase, will be repaired or replaced (at TIGER'S option) for a service fee of US\$14.00. Payments must be by check or money order payable to Tiger Electronics, Ltd.

THE FOREGOING STATES THE PURCHASER'S SOLE AND EXCLUSIVE REMEDY FOR ANY BREACH OF WARRANTY WITH RESPECT TO THE PRODUCT.

All product returned must be shipped prepaid and insured for loss or damage to:

TIGER REPAIR DEPARTMENT
1000 N. Butterfield Road, Unit 1023,
Vernon Hills, IL 60061, U.S.A.

The product should be carefully packed in the original box or other packing materials sufficient to avoid damage during shipment. Include a complete written description of the defect, a check if product is beyond the 90-day warranty period, and your printed name, address and telephone number.

THIS WARRANTY IS IN LIEU OF ALL OTHER WARRANTIES AND NO OTHER REPRESENTATIONS OR CLAIMS OF ANY NATURE SHALL BE BINDING ON OR OBLIGATE TIGER IN ANY WAY. ANY IMPLIED WARRANTIES APPLICABLE TO THIS PRODUCT, INCLUDING WARRANTIES OF MERCHANTABILITY AND FITNESS FOR A PARTICULAR PURPOSE, ARE LIMITED TO THE NINETY (90) DAY PERIOD DESCRIBED ABOVE. IN NO EVENT WILL TIGER BE LIABLE FOR ANY SPECIAL, INCIDENTAL, OR CONSEQUENTIAL DAMAGES RESULTING FROM POSSESSION, USE, OR MALFUNCTION OF THIS TIGER PRODUCT.

Some states do not allow limitations as to how long an implied warranty lasts and/or exclusions or limitations of incidental or consequential damages, so the above limitations and/or exclusions of liability may not apply to you. This warranty gives you specific rights, and you may also have other rights which vary from state to state.

For more information about Tiger Electronics, our products and special promotions, please visit our web site at: www.tigertoys.com.

TIGER
ELECTRONICS, LTD.

©, TM, & © 1999 Tiger Electronics, Ltd. All Rights Reserved.
980 Woodlands Parkway, Vernon Hills, Illinois 60061, U.S.A.

©, TM, & © 1999 Tiger Electronics UK Ltd. All Rights Reserved.
Belvedere House, Victoria Avenue, Harrogate, North Yorkshire HG1 1EL, England.
PRINTED IN CHINA
660160001IWTI-01

Free Manuals Download Website

<http://myh66.com>

<http://usermanuals.us>

<http://www.somanuals.com>

<http://www.4manuals.cc>

<http://www.manual-lib.com>

<http://www.404manual.com>

<http://www.luxmanual.com>

<http://aubethermostatmanual.com>

Golf course search by state

<http://golfingnear.com>

Email search by domain

<http://emailbydomain.com>

Auto manuals search

<http://auto.somanuals.com>

TV manuals search

<http://tv.somanuals.com>