

This warranty gives you specific legal rights and you may also have other rights which vary from state to state so the foregoing limitations may not apply to you. This warranty does not cover damages resulting from accident, unreasonable use, negligence, improper service or other causes not arising out of defects in material or workmanship.

TM & © 1995 Atari Games Corporation/Time Warner Interactive.
All Rights Reserved.

© 1996 TIGER ELECTRONICS, INC.
980 Woodlands Parkway,
Vernon Hills, Illinois 60061, USA.
© 1996 TIGER ELECTRONICS (UK) LLC.
Belvedere House, Victoria Avenue,
Harrogate, North Yorkshire, HG1 1EL

PRINTED IN HONG KONG
Download from www.Somanuals.com. All Manuals Search And Download.

TIGER
LASER GAMES
IR FIRE POWER!

MODEL 79-102

AIRBORNE 1™



TIGER
ELECTRONIC LCD GAME

The game is set at the fabled Area 51 military base in Nevada. One of the most mysterious military bases in the world, Area 51 is so top secret that as far as the public is concerned, it does not exist. There is a great deal of speculation about what actually takes place at Area 51, and more than a hint of conspiracy. Former employees claim that captured alien spacecraft (UFOs) are being studied in the vast underground laboratories. Other rumors claim that Area 51 is involved with genetic studies of dead alien bodies, development of deadly biological warfare, and nuclear weapons testing.

You are a member of the STAAR Team (Special Tactical Advanced Alien Response), a secret paramilitary force who tackle dangerous jobs beyond the ability of the conventional military. As the game begins, you must penetrate the security of the air base and set off the nuclear device located in sub-level 3 of the Control Complex. Along the way, you must avoid being hit by armed enemies, helicopters, missiles, explosions, and deadly aliens. There are plenty of hidden weapons and bonuses to help you along the way.

At first, you do not know why you are being called in to destroy Area 51. As the game goes on, you realize that events at Area 51 have gotten horribly out of control. The personnel at the base are decaying into zombie-like creatures who are just the first stage in a horrible transformation, the end stage of which is an amazing alien being who is fast, heavily armored, and equipped with deadly weapons. The alien infection spreads fast, so the only hope of humanity is to nuke the base. If you can, you may still get out alive.

To win the game, you must play through all six levels of the game and beat the aliens in the final stage. Your ultimate goal is to stop the alien infection from spreading by destroying the Area 51 base in the final stage.

The game is displayed from YOUR perspective. So, the screen will display the areas in front of YOU, with enemies appearing all over the screen. Wherever you point the gun and fire at the screen, the gun will register (and hit enemies if they are present in that portion of the screen).

You will begin the game with standard ammunition, but this can be upgraded by finding the hidden weapons throughout the game. Hidden weapons are found in crates and behind certain enemies. Power-up weapons include:



PULSE RIFLE



SHOTGUNS



GRENADES

All guns are limited, meaning that they must be re-loaded after every six shots (except for GRENADES, which can be used only ONCE). You can re-load the gun by pointing towards the RELOAD icon, and pressing the fire button.

In the early stages of the game, enemies will mostly consist of "zombies". As the game progresses through each stage, these zombie enemies will gradually be replaced by the tougher, more aggressive aliens (the entire last stage will be made up completely of aliens). It takes one hit to destroy a zombie, but aliens may require as many as three hits to destroy them.

When you destroy the required number of enemies in each stage, you will move on to the next stage, all the way up to stage 6.

The player begins the game with a full energy meter and 5 lives. Every time the player is hit, the energy meter is depleted. When the meter runs to "empty", the player loses a life. If he/she loses all 5 lives, the GAME IS OVER.

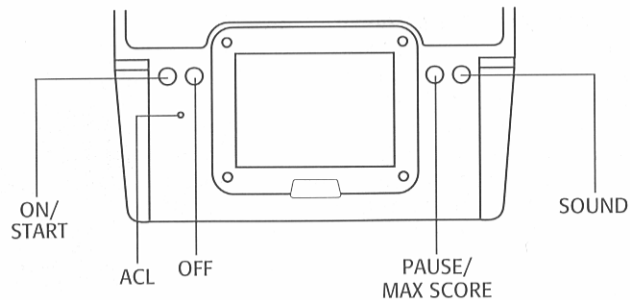
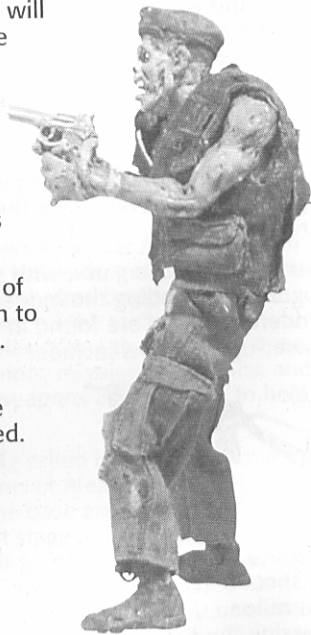

ON/START

- to turn on the LASER GAME.
- to start each stage.
- to exit pause.

SOUND

- to control sound: on/off.

PAUSE/MAX SCORE

- to pause the game during play.
- to see the maximum score during the pause between stages.

OFF

- to turn off the game.

FIRE (on GUN)

- to start each stage.
- to fire current weapon.

ACL

- press to RESET the game.

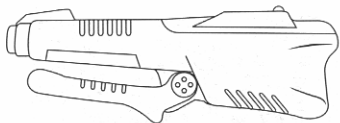

Your LASER GAME comes complete with a miniature infrared gun featuring a folding stock and trigger grip handle.

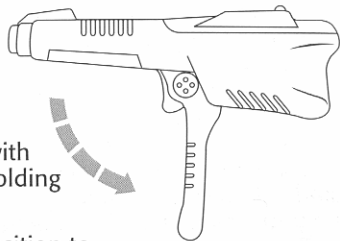

Your LASER gun comes in a folded position to fit into the gun storage area. Pull the handle back to set the LASER gun into correct firing position.

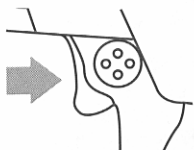

Point the LASER gun in the direction you wish to fire at on the LCD screen. Now press the RED trigger to fire at the screen. Each new stage in the game can be started when you fire your LASER gun at the screen.

Your laser gun handle is detachable to avoid breakage. The handle can be unhinged or attached as shown by snapping it off the sides of the trigger area. To re-attach, simply snap back into place.

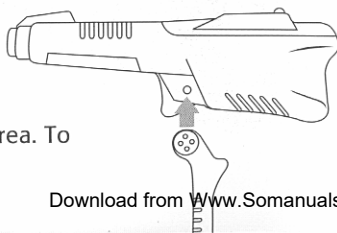

This is a target shooting "gallery" game with real arcade sound effects. The unit features a fold back compartment allowing you to stand the game up when playing, or store the LASER gun when not in use. The game unit stand will "lock" into place at either the front or back position.

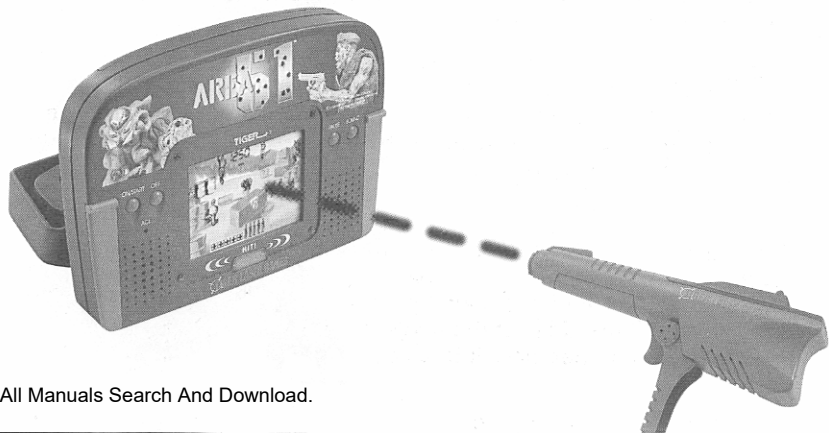
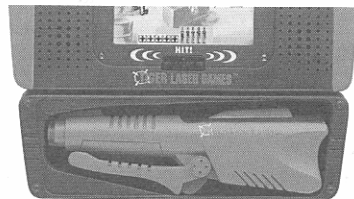

After unfolding the unit and setting up your LASER gun, press the ON/START button to turn on your LASER GAME unit. For best results, the distance between the LASER gun and the screen should be anywhere from 6 to 30 inches.

Now press the ON/START button to turn on the unit. You'll hear an ON beep, and the maximum score is displayed.

Press the ON/START button again to begin the game from STAGE 1, and a score of ZERO. There are 6 stages of play.

You start out with standard ammunition, but you can upgrade to new weapons hidden inside the base.



Enemies will start appearing from behind obstacles and vehicles immediately. You must shoot the enemies as they appear, or they will fire their weapons back.

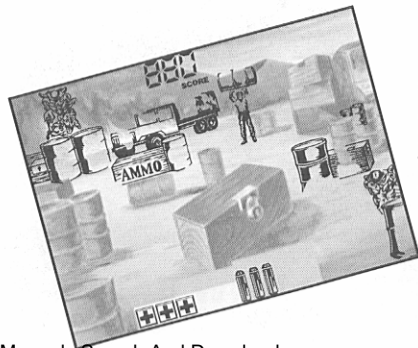
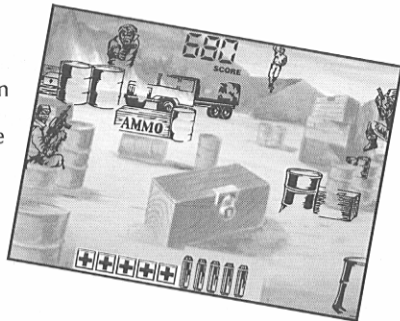

Use the gun to unload your ammunition at the enemies. Some enemies can be taken out with one hit, others may require as many as 3!

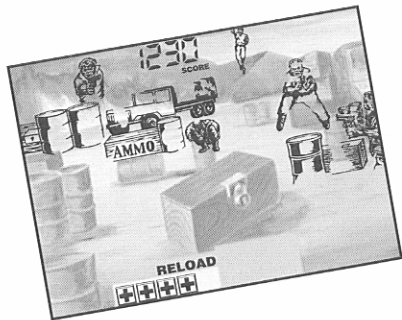

If you run out of ammunition, you'll need to reload quickly. Point the gun at the RELOAD icon, and pull the trigger. This will reload your gun with whatever is the current weapon.

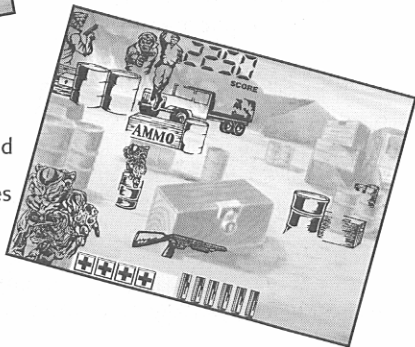

There are "power-ups" for weapons and your energy meter located throughout each stage. Shoot the barrels and crates to find these power-ups.

WEAPON ICONS:



Shoot the weapon icons to acquire the different firepower.

STANDARD AMMO:

This is your default weapon. It's handy in a pinch, but you'd be better off with a bigger weapon.

PULSE RIFLE:



A rapid fire weapon that helps "take out the trash".

SHOTGUN:



Heavy Duty equipment. When you're done messin' around.

GRENADE:



Ka-boom. Need we say more?

HEALTH ICONS:



Shoot these when you're feeling low on energy!

There is no time limit to the game. Instead you must complete each of the six stages by destroying the required number of enemies. When you do this, you advance to the next stage.

PROCEED WITH CAUTION!



You want to be sure that you don't accidentally hit any of your fellow STAAR team allies. If you do, you will lose one energy unit.

Points

Scoring is simple in this game:

10 for ZOMBIES
points

50 for ALIENS
points

The game pauses after each stage. Press the ON/START or pull the trigger button to begin the next stage.

After a GAME OVER (or after you complete all 6 stages), press the ON/START button to begin the game again from STAGE 1.

Use the SOUND button to toggle the sound: ON/OFF.

Press the OFF button when you are finished playing, or the game will shut off automatically after 3 minutes of "non-play".

INSERTING THE BATTERIES

NOTE: Your Tiger Laser Game requires separate batteries be installed in the game unit and the laser gun:

Game Unit - To insert the batteries, remove the battery compartment cover at the back of the game. (To remove cover, push in direction of the arrow.) Insert four "AA" batteries, LR6 or equivalent (not included), making sure to align "+" and "-" as shown.

Gun - Insert two "AAA" batteries, LR03 or equivalent. Installation of batteries should be done by an adult.

TO ENSURE PROPER FUNCTION:

- Do not mix old and new batteries.
- Do not mix alkaline, standard (carbon - zinc), or rechargeable batteries.
- Battery insertion/replacement should be done by an adult.
- Replacing the batteries will cause your game to reset, losing all previous scoring or stored information.

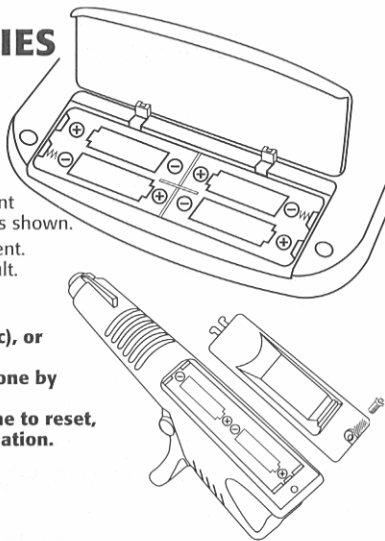
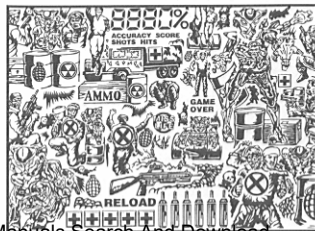

After battery insertion, the ACL switch may be pushed only if the game doesn't work properly. (Use a ball-point pen.) The display should appear as shown in the diagram at the left.

CAUTION

High temperature will destroy the unit. Do not leave unit in direct sunlight.

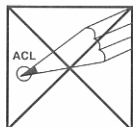

Do not use a pencil or pin to press the ACL switch. Use a ball-point pen.

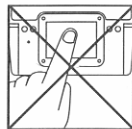

Do not press the liquid crystal display and avoid heavy shock or the display may fail.

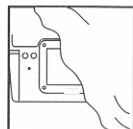

Clean only with a piece of soft dry cloth.

Replace batteries at the first sign of erratic operation.

DEFECT OR DAMAGE

If a part of your game is damaged or something has been left out, **DO NOT RETURN THE GAME TO THE STORE.** The store doesn't have replacement parts. Instead, write to us at:

TIGER ELECTRONIC TOYS REPAIR CENTER
980 Woodlands Parkway, Vernon Hills, Illinois 60061, U.S.A.

In your note, mention the name of your game, the game's model number, and tell us briefly what is the problem. Also include sales slip, date, place of purchase and price paid. We will do our best to help.

90-DAY LIMITED WARRANTY

Tiger Electronics, Inc. (TEI) warrants to the original consumer purchaser of any of its electronic games or toys that the product will be free of defects in material or workmanship for 90 days from the date of original purchase.

During this 90-day warranty period, the product will either be repaired or replaced (at our option) without charge to the purchaser, when returned either to the dealer with proof of the date of purchase or to TEI when returned prepaid and insured with proof of date of purchase.

Product returned to TEI without original receipt or after the 90-day warranty has expired, but prior to one year from the original date of purchase, will be repaired or replaced (at our option) for a service charge of US\$12.00. Make check or money order payable to Tiger Electronics, Inc.

TEI will not be liable for loss of use of the product or other incidental or consequential costs, expenses, or damages incurred by the purchaser. Any implied warranties are limited in duration to the 90-day period from the original date of purchase.

All product returned must be shipped prepaid and insured for loss or damage to:

Tiger Electronics, Inc. Repair Dept.
980 Woodlands Parkway
Vernon Hills, Illinois 60061 U.S.A.

1. Pack the product carefully in the original box or use a good-quality carton with packing materials.
2. Include a letter with a complete description of the defect, a check if product is beyond the 90-day warranty, and your printed name, address and telephone number.

Free Manuals Download Website

<http://myh66.com>

<http://usermanuals.us>

<http://www.somanuals.com>

<http://www.4manuals.cc>

<http://www.manual-lib.com>

<http://www.404manual.com>

<http://www.luxmanual.com>

<http://aubethermostatmanual.com>

Golf course search by state

<http://golfingnear.com>

Email search by domain

<http://emailbydomain.com>

Auto manuals search

<http://auto.somanuals.com>

TV manuals search

<http://tv.somanuals.com>