

## INFORMATION TO THE USER

This device complies with part 15 of the FCC Rules.

Operation is subject to the following two conditions:

- (1) This device may not cause harmful interference, and
- (2) This device must accept any interference received, including interference that may cause undesired operation.

**NOTE:** This equipment has been tested and found to comply with the limits for a Class B digital device. Pursuant to Part 15 of the FCC Rules. These limits are designed to provide reasonable protection against harmful interference in a residential installation. This equipment generates, uses and can radiate radio frequency energy and, if not installed and used in accordance with the instructions, may cause harmful interference to radio communications. However, there is no guarantee that interference will not occur in a particular installation. If this equipment does not cause harmful interference to radio or television reception which can be determined by turning the equipment off and on. The user is encouraged to try to correct the interference by one or more of the following measures:

- Reorient or relocate the receiving antenna.
- Increase the separation between the equipment and receiver.
- Connect the equipment into an outlet on a circuit different from that to which the receiver is connected.

**CAUTION:** Any changes or modifications not expressly approved by the grantee of this device could void the user's authority to operate the equipment.

**TIGER** ELECTRONICS  
INC.®

TM & © 1995 Tiger Electronics, Inc.  
Power Pack PC™ is a trademark of Tiger Electronics, Inc.  
980 Woodlands Parkway, Vernon Hills, Illinois 60061 USA.  
Tiger Electronics (UK) LLC.  
Belvedere House, Victoria Avenue, Harrogate,  
North Yorkshire HG1 1EL, England.  
PRINTED IN HONG KONG

900931WTIE-2  
All Rights Reserved

TIGER  
ED.™

For Ages 9 & Up  
Model 9-009-3

# POWER PACK PC™ Instruction Manual



1. INTRODUCTION .....	3
2. EQUIPMENT CHECKLIST .....	3
3. ADAPTOR AND BATTERY INFORMATION.....	3 -4
4. INSERTING / REPLACING THE BATTERIES .....	4
5. MOUSE .....	5
6. OPENING THE POWER PACK PC .....	5
7. THE SCREEN .....	6
8. ACTIVITY SELECTOR KEYPAD .....	7
9. POWER ON / OFF .....	8
10. LEVELS .....	8
11. ONE OR TWO PLAYERS .....	8
12. SCORING .....	8
13. KEYBOARD .....	9-10
14. TO BEGIN PLAY .....	10

15. ACTIVITIES .....	11-18
16. EXPANSION CARTRIDGES .....	18
17. TROUBLESHOOTING .....	19
18. CARE AND MAINTENANCE .....	19
19. 90-DAY LIMITED WARRANTY .....	20

## 1. INTRODUCTION

**POWER PACK PC** is a talking, laptop-style learning computer with 35 multi-level activities that teach children spelling, vocabulary, tenses, plurals, antonyms, grammar, basic mathematics, algebra and more in a fun and challenging way. Includes a fully functioning computer-like mouse and 4-line LCD screen. Over 1,000 challenging trivia questions, an 80,000 word spell checker and a calculator round out the curriculum. The touch-sensitive activity selector keypad and full-stroke QWERTY keyboard are convenient and easy to use.

## 2. EQUIPMENT CHECKLIST

- 1 **POWER PACK PC** unit
- 1 Mouse
- 1 Instruction Manual

## 3. ADAPTOR and BATTERY INFORMATION

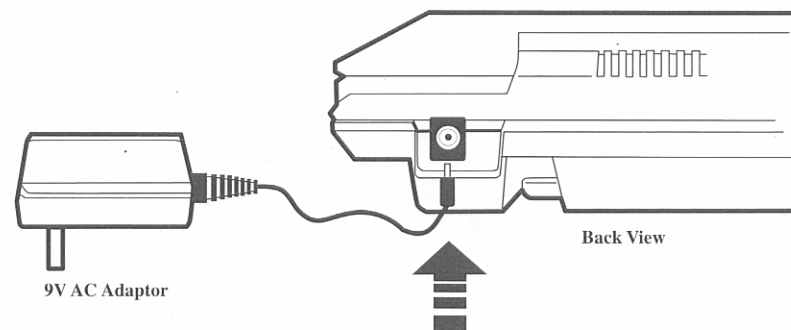

### ADAPTOR INFORMATION

Use standard 9V AC adaptor.

- Make sure your **POWER PACK PC** is turned off.
- Find the adaptor jack on the back of the unit and plug in the adaptor.
- Turn on your **POWER PACK PC**

**NOTE:** Do not leave the adaptor plugged in when you are not using your **POWER PACK PC**.

Do not insert batteries when you are using the adaptor.

## BATTERY INFORMATION

- Always install the batteries correctly according to the positive (+) and negative (-) signs.
- Do not use rechargeable batteries
- Do not mix old and new batteries
- Battery installation should be done by an adult
- Do not mix alkaline-standard (Carbon-Zinc) or rechargeable (Nickel-Cadmium) batteries.
- Remove worn out or dead batteries immediately as they might leak and damage the unit.

## 4. INSERTING / REPLACING THE BATTERIES

- Place the **POWER PACK PC** face down on a flat surface. Lift the battery compartment cover.
- Insert six "AA" (LR6) size batteries, as shown inside the battery compartment. Alkaline batteries are recommended.
- Close the battery cover.
- Remove any batteries if you will not use the unit for a long period of time.
- Do not use the adaptor when using batteries.

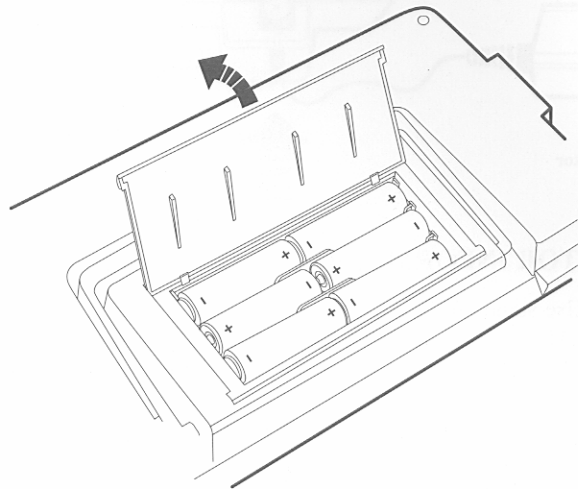

## 5. MOUSE

A fully-functioning mouse is included with your **Power Pack PC**. To connect the mouse to the unit, insert the mouse plug into the right side of the unit. When using the mouse, make certain the mouse rests on a smooth, flat surface.

The mouse will work in every activity in which the arrow keys would be used. Any time you would use the arrow keys, you could use the mouse instead, if it is plugged in. However, there are only 4 activities that will display an actual mouse cursor. They are: GRAPHING COORDINATES, SHIP ATTACK, SIGN TIME and CATEGORIES. The left button on the mouse functions as an ENTER key and the right button functions as an ERASE key.

**IMPORTANT NOTE:** Always remember to turn OFF the unit before either inserting or removing the mouse.

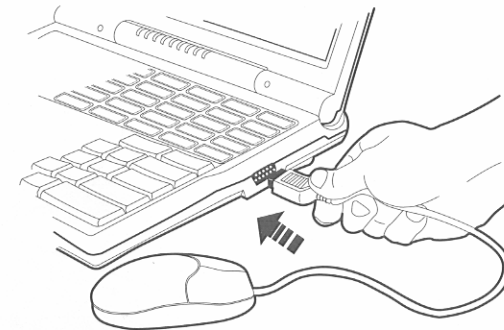

## 6. OPENING POWER PACK PC

To open **POWER PACK PC**, press the release button on the front of the cover (see Illustration 1 below). Lift the top of the unit.

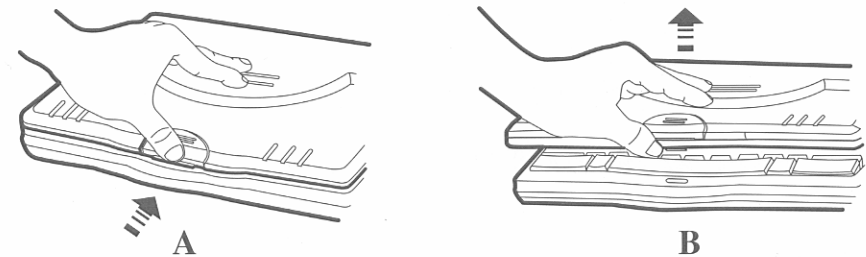

ILLUSTRATION 1

## 7. THE SCREEN

The **LCD** screen is 20 characters wide and 4 lines in height. All activities will be shown on this screen.

To change the contrast of the **LCD** screen, slide the **CONTRAST** button that is located to the left of the screen.

To increase or decrease the volume of the unit, slide the **VOLUME** button that is located to the left of the screen.

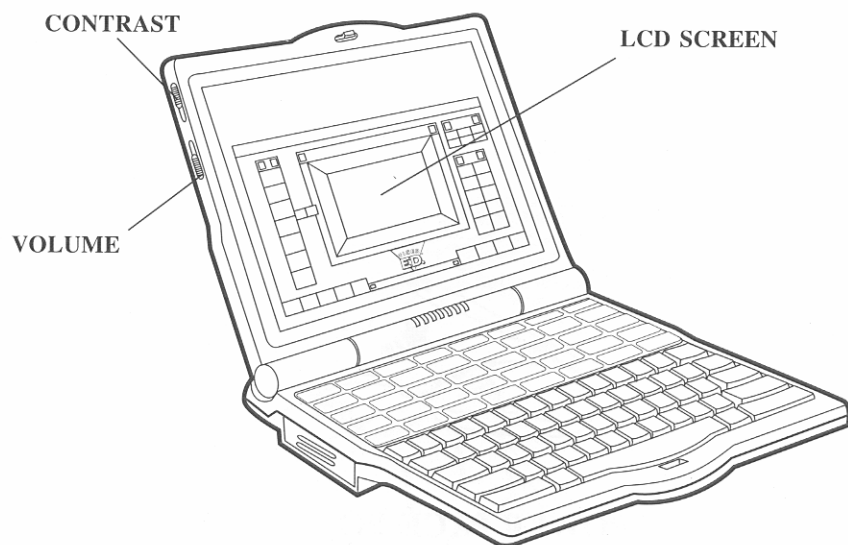

## 8. ACTIVITY SELECTOR KEYPAD

The activity selector keypad is a touch-sensitive membrane pad with 40 keys. Each key has an activity or function printed on it.

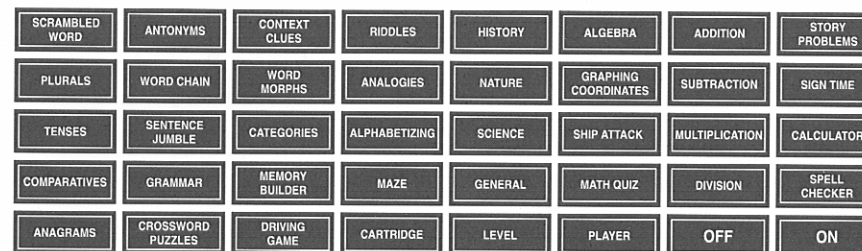

Press this key to turn on the unit.



Press this key to turn off the unit. Unit will automatically shut-off after four minutes of inactivity.



Press this key to choose either one player mode or two-player mode. See the section titled **ONE OR TWO PLAYERS** for a detailed description of this key.



Press this key to choose either Level 1, Level 2, or Level 3. See the section titled **LEVELS** for a detailed description of this key.



Press this key to begin the activities in one of the expansion cartridges. See the section titled **EXPANSION CARTRIDGES** for a detailed description of this key.

To begin an activity, simply press one of the keys and a title screen for that specific activity will appear on the **LCD** screen.

Refer to the section titled **ACTIVITIES** for a detailed description of each activity.

## 9. POWER ON/OFF

1. Open the laptop.
2. Press the **ON** button located in the bottom right corner of the activity selector keypad. The screen will show a brief animated introduction. The keyboard and keypad will not work during this introduction.
3. To turn off the unit, simply press the **OFF** button located in the bottom right corner of the activity selector keypad. Remember to turn off the unit when you are not using it to conserve battery life.

## 10. LEVELS

Most activities have three levels. Each time you enter an activity, you begin at Level 1. To change levels, press the **LEVEL** button on the activity selector keypad and then press number 1, 2 or 3.

## 11. ONE OR TWO PLAYERS

Most activities can be played with either one player or two players. To change the number of players, press the **PLAYER** button on the activity selector keypad and then press the number of players .

Type in the name of the person who will operate the **RIGHT PLAYER** key and press **ENTER**. Then type in the name of the person who will operate the **LEFT PLAYER** key and press **ENTER**. During an activity, the right and left player's name will then flash back and forth on the screen. The player who presses their player button first has the chance to answer the question. The player mode will remain the same for that activity unless you change it or turn off the unit.

## 12. SCORING

In the one-player mode, for most activities, there will be ten questions per round. You will receive 10 points for a correct answer on the first try, 8 points on the second try and 6 points on the third try. No points will be awarded if the unit displays the correct answer for you. 5 points are deducted if you press the **HELP** key.

## 13. KEYBOARD

The keyboard is a full-stroke, **QWERTY** keyboard just like a real computer with large, easy-to-use keys. Take a moment to review the keyboard before you begin play.

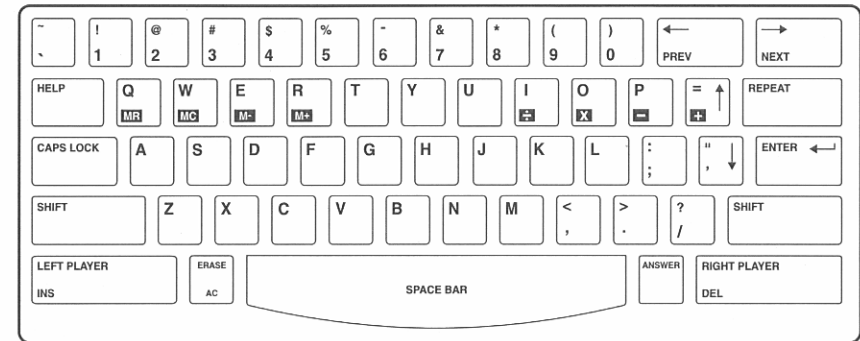

Press this key when you need help with a question and the unit will provide you with one clue. The **HELP** key will only work one time for each question.



Press this key when you are the left player and want to answer a question. The **INSERT** function does not work with the activities in this unit, but will work with activities in the expansion cartridges.



Press this key to erase an entire entry before pressing the **ENTER** button or to clear an entry in the calculator activity.



Press these keys in the calculator activity to access the memory functions and mathematical functions.



Press this key when you want the unit to provide you with the answer to a question.



Press this key when you are the right player and want to answer a question or to delete a character during an answer entry.



Press these keys to view a screen that has previously (**PREV**) appeared, to view the next (**NEXT**) screen, or to move your cursor left or right.

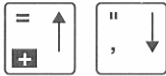

Press these keys to move your cursor up or down. This key is also used in the calculator function.



Press this key when you want the unit to repeat a question.

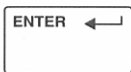

Press this key each time you enter an answer to a question.



Press these keys to enter a numeric answer.

## 14. TO BEGIN PLAY

1. Press the **ON** button.
2. Choose an activity from the activity selector keypad simply by pressing one of the keys.
3. Refer to the section titled **ACTIVITIES** for a detailed description of each activity.
4. Press the **LEVEL** button to change the level of play in any of the applicable activities. All activities begin in Level 1 unless you change the level.
5. Press the **PLAYER** button to change the player mode where applicable. All activities begin in the one-player mode unless you change it.
6. To change activities, simply press an activity key on the membrane activity keypad.
7. When you finish using **POWER PACK PC** press the OFF button. It will turn itself off after four minutes of inactivity.

## 15. ACTIVITIES

Each activity consists of 10 questions per round, unless otherwise stated. Your score will be displayed at the end of each round. Please refer to the section titled **SCORING** for complete details on the scoring system. You will be given three tries to enter the correct answer for most activities. After the third incorrect try, the correct answer will be displayed and the unit will move onto the next question.

### 1. Scrambled Word

A scrambled word will appear on the screen. Type the correct spelling of the word and press the **ENTER** key.

### 2. Plurals

A noun will appear at the top of the screen. The unit will ask you to enter the correct plural form. Type in your entire answer and press the **ENTER** key.

### 3. Tenses

A verb will appear at the top of the screen. The unit will ask you to enter the correct past tense or past participle of that verb. Type in the correct answer and press the **ENTER** key.

### 4. Comparatives

Two forms of an adjective will appear on the screen with either the comparative or superlative form missing. Type in the correct answer and press the **ENTER** key.

### 5. Anagrams

The unit will display "Word size: 6". "Word size" is the maximum amount of letters you can enter in a word. Press **ENTER**. The unit will then display "Smallest word size: 3". "Smallest word size" is the minimum amount of letters you can enter in a word. Press **ENTER**. A word will appear on the screen. Using the letters from that word, type another word with at least three letters and no more than six letters from the original word. For example, if the word that appears on the screen is **TIGER**, you could type in **GET, RIG, TIE** or **TIRE**. All these words have at least three letters, no more than six letters and consist of the letters from the original word. Press **ENTER** after each word you type. Continue to do this until you enter three correct words.



## 6. Antonyms

A word will appear on the LCD screen. The first letter in the answer, and dashes representing the remaining letters in the answer, will appear below the question word. Type in a word which has the opposite meaning as the question word and press the **ENTER** key. These clues are given to you because, although there is more than one correct answer to this type of question, only one answer could be programmed into **POWER PACK PC**.

## 7. Word Chain

The beginning portion of a word will appear on the screen with three endings to the right of that word. Only one of these endings is correct. Select the correct ending by using the up and down arrow keys (or the mouse) and pressing the **ENTER** key. That ending will then become the beginning portion of the word in the next question. Continue building to the word chain until the round is completed.

For example: If **ag > ve** appears on the screen, you would move

**cle**  
**ent**

your down arrow key until the **>** arrow is pointing to "ent" and press your **ENTER** key. This will form the word "agent". This ending will then become the beginning portion of a word in the next question which happens to be "entertainment".

## 8. Sentence Jumble

A scrambled sentence will appear on the screen. Rearrange the words to form a correct sentence. Using the left or right arrow keys, highlight each word in the order that they should appear, pressing the **ENTER** key after each word. Each word will disappear from the top of the screen and reappear at the bottom of the screen in the order that you choose them.

## 9. Grammar

A sentence will appear on the screen that is grammatically incorrect. It may be a punctuation error, incorrect capitalization, wrong word usage, or missing quotation marks, etc. Highlight the incorrect word by using the left or right arrow keys (or mouse) and press the **ENTER** key. A space will appear at the top of the screen for you to type in the correct word. Type in the correct answer and press the **ENTER** key.

**NOTE:** Only complete words can be highlighted. Therefore, when you highlight any punctuation errors or capitalization errors, the entire word that has to be capitalized, or the word that appears before the incorrect punctuation, will

highlight. When you enter your answer, the same word will have to be entered along with the correct capital letter or punctuation mark.

## 10. Crossword Puzzles

A crossword puzzle will appear on the screen with one of the hidden words flashing. Using your left or right arrow keys, move the highlighted cursor to the word that you want to guess and press **ENTER** to reveal this word's clue. Read the clue and then press **ENTER** again to go back to the crossword puzzle screen. Enter your answer and press **ENTER**. Continue to do this until you have entered all ten words.

## 11. Context Clues

Two sentences will scroll onto the screen with one word missing. The same word will complete both sentences but the word will have different meanings. Type in the correct word and press the **ENTER** key.

**NOTE:** In Level 1, the first letter in the answer and dashes representing the remaining letters in the answer will be provided as a clue. In Level 2, only dashes will be provided to make it more challenging. In Level 3, no clues will be provided.

## 12. Word Morphs

Two words will appear on the screen: a "starting" word on the left and a "target" word on the right. Add one letter to the "starting" word to form another word. Keep doing this until you reach the "target" word. Press **ENTER** after each word formed.

For example: If "yard -> lawn" appears on the screen, you would start with the word "yard" and change it to "yarn". Then you would type in "yawn" and then "lawn", which is the target word.

## 13. Categories

A word will appear on the screen that designates a category. A variety of different words will begin to scroll across the screen directly below this category word. Find the word or words that relate to the category word. When the word that you want to choose is directly below the category word, press **ENTER**.

## 14. Memory Builder

Test your memory skills! A number or word will appear on the screen and then disappear. Type in that number or word and then press **ENTER**. Two numbers or words will then appear on the



screen and then disappear. Type in the first number or word, press **ENTER** and then type in the second number or word and press **ENTER**. This will continue until you make a mistake or until you correctly remember and enter ten numbers or words in a row.

### 15. Driving Game

Start your engines! A "race track" will appear on the LCD screen. Using your arrow keys, guide your "race car" around the track as quickly as you can. When you reach the "finish line", **POWER PACK PC** will display your time as your score.

### 16. Riddles

A silly riddle will appear on the screen. Type in the correct answer and press the **ENTER** key.

**NOTE:** In Level 1, the first letter in the answer and dashes representing the remaining letters in the answer will be provided as a clue. In Level 2, only dashes will be provided to make it more challenging. In Level 3, no clues will be provided.

### 17. Analogies

Two analogies will appear on the screen, one of which is incomplete. Enter a word that will complete the analogy and press the **ENTER** key.

For example: **track : running**

**pool : s \_ \_ \_ \_ \_ \_ \_**

s w i m m i n g will correctly complete this analogy.

**NOTE:** The first letter in the answer will always be given as a clue.

### 18. Alphabetizing

Two words will appear on the screen with an empty line between them. Type in a word that alphabetically fits between these two words and press the **ENTER** key.

For example: If the following appears on the screen: **gas**

■  
**library**

you could enter any word that begins with "ge" to "le".

As long as it alphabetically fits between "gas" and "library".

### 19. Maze

A maze will appear on the screen. Using your arrow keys, maneuver the character through the maze until you reach the end. You're being timed so move as quickly as you can! Good luck!

### 20. History

A history trivia question will scroll onto the screen. Each trivia

question will require a one-word answer. Enter the answer by typing it on the line provided and then press **ENTER**.

Press the **HELP** button to display three multiple choice answers if you need help answering a question. Using your arrow keys, highlight your answer choice and press the **ENTER** key.

### 21. Nature

A trivia question about nature will scroll onto the screen. Each trivia question will require a one-word answer. Enter the answer by typing it on the line provided and then press **ENTER**.

Press the **HELP** button to display three multiple choice answers if you need help answering a question. Using your arrow keys, highlight your answer choice and press the **ENTER** key.

### 22. Science

A science trivia question will scroll onto the screen. Each trivia question will require a one-word answer. Enter the answer by typing it on the line provided and then press **ENTER**.

Press the **HELP** button to display three multiple choice answers if you need help answering a question. Using your arrow keys, highlight your answer choice and press the **ENTER** key.

### 23. General

A general trivia question will scroll onto the screen. Each trivia question will require a one-word answer. Enter the answer by typing it on the line provided and then press **ENTER**.

Press the **HELP** button to display three multiple choice answers if you need help answering a question. Using your arrow keys, highlight your answer choice and press the **ENTER** key.

### 24. Algebra

An equation will appear on the screen. In all equations, you must determine what equals "x". At the flashing cursor, type in the correct answer using the number keys and press the **ENTER** key.

### 25. Graphing Coordinates

An empty graph will appear on the screen with a coordinate to the right. Using your mouse or arrow keys, move the cursor to that coordinate on the graph, and press the **ENTER** key. As you move the cursor on the graph, the exact coordinates that you are moving to will appear to the right of the graph. This will help you to know where the coordinates are that you are looking for. After you correctly enter a coordinate, a line will appear at that location and the screen will display the next coordinate for you to find. Keep locating and entering coordinates until the picture is revealed that is hiding in the graph.

## 26. Ship Attack

Enter your boat's coordinates and prepare for battle! Play against a friend or the computer. When the grid map appears on the screen, the first thing that you need to do is place each of your three ships on this map. The first ship is the Carrier and occupies four unit spaces on the map. Using your arrow keys, move the cursor to a coordinate to select the ship's head position and press **ENTER**. Then move the cursor to another coordinate to select the ship's tail position and press **ENTER**. Make sure that the head and tail coordinates are not further than four spaces apart horizontally or vertically as your Carrier only occupies four spaces. Your next two ships will be placed on the grid map in the same way, but the sizes will differ. The Warrior ship occupies three unit spaces on the map and the S-Boat occupies two unit spaces. After placing the ships, **POWER PACK PC** will ask you to confirm if the placement is OK. Select "N" if you want to change the placement of any ships or "Y" to progress to the bombing phase. The object in the bombing phase is to bomb your opponent's ships by using your arrow keys to define a coordinate and then by pressing the **ENTER** key. A message will be displayed that tells you whether or not you have hit an enemy ship.

You will receive 50 points for successfully bombing your opponent's Carrier ship, 30 points for the Warrior Ship and 20 points for the S-Boat. The game is over when you sink all three of your opponent's ships, your opponent sinks all three of your ships, or after 10 rounds when all your bombs are used up. Good luck!

## 27. Mathematical Quiz

An addition, subtraction, multiplication or division equation will randomly appear on the LCD screen. Type in the correct answer using the number keys and press **ENTER**.

## 28. Addition

An addition equation will appear on the LCD screen. Type in the correct answer and press the **ENTER** key.

## 29. Subtraction

A subtraction equation will appear on the LCD screen. Type in the correct answer and press the **ENTER** key.

## 30. Multiplication

A multiplication equation will appear on the LCD screen. Type in the correct answer and press the **ENTER** key.

## 31. Division

A division equation will appear on the LCD screen. Type in the correct answer and press the **ENTER** key.



## 32. Story Problems

A mathematical story problem will scroll onto the screen. Read the question, type in the answer and press the **ENTER** key.

## 33. Sign Time

A mathematical equation will appear on the screen with a mathematical sign missing. Choose one of the several different mathematical symbols that will begin to scroll across the screen to correctly complete the equation. Press the **ENTER** key when the correct mathematical symbol is directly below the missing space.

## 34. Calculator

The calculator function in **POWER PACK PC** works just like a real calculator. Use the number keys on the keyboard and the eight specially-marked keys in the second row of the keyboard. Enter your equation. Press **SHIFT** and the  keys to display your answer. To clear the screen, use the  key located directly to the left of the **SPACE BAR**.

Basic Calculator Symbols:

 : Addition

 : Subtraction

 : Multiplication

 : Division

Memory Features:

 : Recalls the memory. The number saved in memory will be shown on the screen.

 : Clears the number stored in memory.

 : Subtracts the number from memory.

 : Adds the number to memory.

### 35. Spell Checker

Type in the word you would like the spell checker to find and press the **ENTER** key. **POWER PACK PC** will then proceed to search through its 80,000 word spell checker. If your word is spelled correctly, the word **CORRECT** will appear on the screen. If your word is spelled incorrectly, **POWER PACK PC** will display all the spelling choices for that particular word. Use the mouse or your arrow keys to scroll through the list of words until you find the word you are looking for or until **END OF LIST** appears on the screen. Depending on how close to the correct spelling you are, the actual word you are looking for will be displayed on the screen. If **NO WORD FOUND** appears on the screen, enter the word again using a different spelling. If you want to enter another word or exit a current word list, press the **ERASE** key.

### 16. EXPANSION CARTRIDGES

**POWER PACK PC** is expandable with additional cartridges that are sold separately. To use a cartridge, follow the steps below.

1. Turn **OFF** the power on **POWER PACK PC**.
2. Gently push the cartridge into the cartridge slot that is located on the left side of the unit's base. The cartridge label must face up and the open end of the cartridge must face towards the unit.
3. Turn **ON POWER PACK PC**.
4. Press the **CARTRIDGE** key on the membrane activity keypad.

**NOTE:** Be sure to follow the instruction manual that is included with your cartridge purchase.

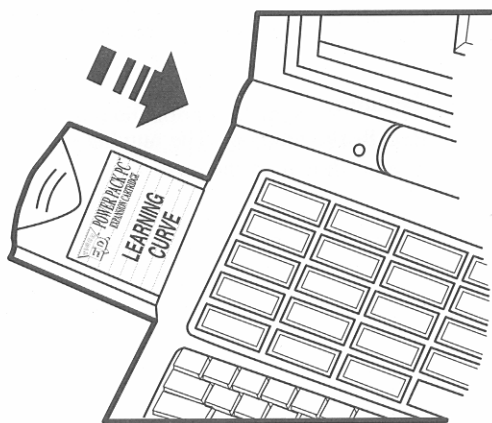

### 17. TROUBLESHOOTING

In the event of any malfunction, check the following:

1. Check the battery connection and make sure all batteries are properly inserted.
2. Change batteries:
  - 6 "AA" (LR6) size batteries are required
  - Alkaline batteries are recommended
3. Check the battery compartment cover to make certain it is securely shut.
4. If you are using the adaptor, make certain it is connected properly.

If you are still having trouble after checking all of these things, please call our toll-free number at **1-800-TIGER ED** and a representative will be happy to help you.

### 18. CARE AND MAINTENANCE

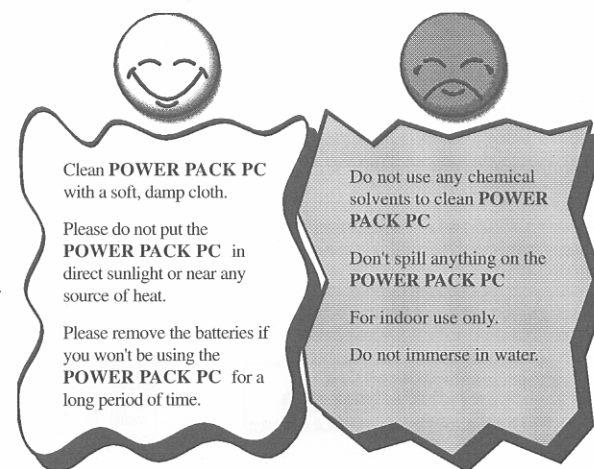

## 19. 90-DAY LIMITED WARRANTY

Tiger Electronics, Inc. (TEI) warrants to the original consumer purchaser of any of its electronic games or toys that the product will be free of defects in material or workmanship for 90 days from the date of original purchase.

During this 90-day warranty period, the product will either be repaired or replaced (at our option) without charge to the purchaser, when returned either to the dealer with proof of the date of purchase or to TEI when returned prepaid and insured with proof of date of purchase.

Product returned to TEI without original receipt or after the 90-day warranty period has expired, but prior to one year from the original date of purchase, will be repaired or replaced (at our option) for a service charge of US\$30.00. Make check or money order payable to Tiger Electronics, Inc.

TEI will not be liable for loss of use of the product or other incidental or consequential costs, expenses, or damages incurred by the purchaser. Any implied warranties are limited in duration to the 90-day period from the original date of purchase.

All product returned must be shipped prepaid and insured for loss or damage to:

Tiger Electronics, Inc. Repair Dept.  
980 Woodlands Parkway,  
Vernon Hills, Illinois 60061 U.S.A.

1. Pack the product carefully in the original box or use a good-quality carton with packing materials.
2. Include a letter with a complete description of the defect, a check if product is beyond the 90-day warranty, and your printed name, address and telephone number.

This warranty gives you specific legal rights and you may also have other rights which vary from state to state so the foregoing limitations may not apply to you. This warranty does not cover damages resulting from accident, unreasonable use, negligence, improper service or other causes not arising out of defects in material or workmanship.



## Free Manuals Download Website

<http://myh66.com>

<http://usermanuals.us>

<http://www.somanuals.com>

<http://www.4manuals.cc>

<http://www.manual-lib.com>

<http://www.404manual.com>

<http://www.luxmanual.com>

<http://aubethermostatmanual.com>

Golf course search by state

<http://golfingnear.com>

Email search by domain

<http://emailbydomain.com>

Auto manuals search

<http://auto.somanuals.com>

TV manuals search

<http://tv.somanuals.com>