

# TIMEX®

Model T736

**AM/FM Dual Alarm Clock Radio With  
Redi-Set™ Automatic Time Setting  
System, Time Projector, Simple-Set  
Keypad, and Soothing Sounds**



For additional information, online registration,  
and exclusive special offers visit our website:

[www.timexaudio.com](http://www.timexaudio.com)

For questions or comments regarding this or other products,  
please call our toll-free number 1-800-888-4491.  
Download from [www.Somanuals.com](http://www.Somanuals.com). All Manuals Search And Download.



**CAUTION**  
**RISK OF ELECTRIC SHOCK.**  
**DO NOT OPEN**



**CAUTION:** TO REDUCE THE RISK OF ELECTRIC SHOCK, DO NOT REMOVE COVER (OR BACK). NO USER-SERVICEABLE PARTS INSIDE. REFER SERVICING TO QUALIFIED SERVICE PERSONNEL.

**WARNING:** TO REDUCE THE RISK OF FIRE OR ELECTRIC SHOCK, DO NOT EXPOSE THIS APPLIANCE TO RAIN OR MOISTURE.

**AVERTISSEMENT:** POUR RÉDUIRE LE RISQUE D'INCENDIE OU DE CHOC ÉLECTRIQUE, NE PAS EXPOSER CET APPAREIL SOUS LA PLUIE ET L'HUMIDITÉ



The lightning flash with arrowhead symbol, within an equilateral triangle, is intended to alert the user of the presence of uninsulated "dangerous voltage" within the product's enclosure that may be of sufficient magnitude to constitute a risk electric shock to persons.



The exclamation point within an equilateral triangle is intended to alert the user of the presence of important operating and maintenance (servicing) instructions in the literature accompanying the appliance.

**CAUTION:** To prevent electric shock, do not use this (Polarized) plug with an extension cord receptacle, or other outlets unless the blades can be fully inserted to prevent blade exposure.

**ATTENTION:** Pour prévenir les chocs électriques ne pas utiliser cette fiche polarisée avec un prolongateur. Une prise de courant, ou une autre sortie de courant sauf si les lames peuvent être insérées à fond sans en laisser aucune partie à découvert.

## A Consumer Guide to Product Safety

- The apparatus shall not be exposed to dripping or splashing and that no objects filled with liquids, such as vases, shall be placed on apparatus.  
L'appareil ne doit pas être exposé aux écoulements ou aux éclaboussures et aucun objet ne contenant de liquide, tel qu'un vase, ne doit être placé sur l'objet.
- Main plug is used as disconnect device and it should remain readily operable during intended use. In order to disconnect the apparatus from the mains completely, the mains plug should be disconnected from the mains socket outlet completely.  
La prise du secteur ne doit pas être obstruée ou doit être facilement accessible pendant son utilisation. Pour être complètement déconnecté de l'alimentation d'entrée, la prise doit être débranchée du secteur.
- Battery shall not be exposed to excessive heat such as sunshine, fire or the like.  
Les piles ne doivent pas être exposées à de forte chaleur, tel qu'à la lumière du soleil, au feu ou autres choses de semblable.
- The marking information is located at the bottom of apparatus.  
Les marquages sont inscrits en bas de l'appareil.

# IMPORTANT SAFETY INSTRUCTIONS

This unit has been designed and manufactured to assure your personal safety. Improper use can result in potential electrical shock or fire hazards.

1. Read these Instructions.
2. Keep these Instructions.
3. Heed all Warnings.
4. Follow all instructions.
5. **Water and Moisture** - Do not use this apparatus near water. For example: near a bathtub, washbowl, kitchen sink, laundry tub, swimming pool or in a wet basement.
6. **Ventilation** - Do not block any of the ventilation openings. Install in accordance with the manufacturers instructions. For example, it should not be situated on a bed, sofa, rug or similar surface that may block ventilation openings. Also, it should not be placed in a built-in installation, such as a bookcase or cabinet that may impede the flow of air through the ventilation openings.
7. **Heat** - Do not install near any heat sources such as radiators, heat registers, stoves, or other apparatus (including amplifiers) that produce heat.
8. **Power Sources** - The unit should be connected to a power supply only of the type described in the operating instructions or as marked on the appliance.
9. **Grounding or Polarization** - Do not defeat the safety purpose of the polarized or grounding - type plug. A polarized plug has two blades with one wider than the other. A grounding type plug has two blades and a third grounding prong. The wide blade or the third prong are provided for your safety. When the provided plug does not fit into your outlet, consult an electrician for replacement of the obsolete outlet.
10. **Power-Cord Protection** - Protect the power cord from being walked on or pinched particularly at plugs, convenience receptacles, and the point where they exit from the apparatus. It is always best to have a clear area from where the cord exits the unit to where it is plugged into an AC outlet.
11. **Cleaning** - Unplug this product from the wall outlet before cleaning. Do not use liquid cleaners or aerosol cleaners. Clean only with a dry cloth.
12. **Non-Use Periods** - The power cord of the unit should be unplugged from the outlet when it is to be left unused for a long period of time.
13. **Objects and Liquid Entry** - Care should be taken so that objects do not fall and liquids are not spilled into the enclosure through openings.
14. **Attachments** - Only use attachments/accessories specified by the manufacturer.
15. **Lightning** - Unplug this apparatus during lightning storms or when unused for long periods of time.
16. **Overloading** - Do not overload wall outlets, extension cords, or integral convenience receptacles as this can result in a risk of fire or electric shock.
17. **Damage Require Service** - Refer all servicing to qualified service personnel. Servicing is required when the apparatus has been damaged in any way, such as power-supply cord or plug is damaged, liquid has been spilled or objects have fallen into the apparatus, the apparatus has been exposed to rain or moisture, does not operate normally, or has been dropped.
18. **Servicing** - The user should not attempt to service the unit beyond that described in the user's operating instructions. All other servicing should be referred to qualified service personnel.
19. **Safety Check** - Upon completion of any service or repairs to this product, ask the service technician to perform safety checks to determine that the product is in proper operating condition.
20. **Antenna** - Do not connect to an external antenna.

Questions? Service? Warranty? Visit [www.timexaudio.com](http://www.timexaudio.com)

# Table of Contents

---

FCC Information .....	1
Introduction .....	2
Preparation for Use .....	2-3
Controls and Indicators.....	4
Display with Indicators.....	5
Operating Instructions .....	5-8
Listening to The Radio .....	8-12
Changing The Lithium Back-Up Battery .....	12-13
Care and Maintenance .....	13
Warranty Information .....	14

## FCC Information

---

**This device complies with Part 15 of the FCC Rules, operation is subject to the following two conditions: (1) This device may not cause harmful interference, and (2) this device must accept any interference received, including interference that may cause undesired operation.**

This equipment complies with the limits for a Class B digital device as specified in Part 15 of FCC Rules. These limits provide reasonable protection against radio and TV interference in a residential area.

However, your equipment might cause TV or radio interference even when it is operating properly. To eliminate interference you can try one or more of the following corrective measures:

- Reorient or relocate the receiving antenna.
- Increase the distance between the equipment and the radio or TV.
- Use outlets on different electrical circuits for the equipment and the radio or TV.
- Consult your dealer or an experienced radio/television technician if the problem still exists.

Modifying or tampering with your system's internal components can cause a malfunction and might invalidate the system's warranty and void your FCC authorization to operate it.

This Class B digital apparatus complies with Canadian ICES-003.

Cet appareil numérique de la classe B est conforme à la norme NMB-003 du Canada.

## Introduction

Thank you for purchasing this Timex Dual Alarm Clock Radio with Redi-Set Automatic Time Setting System. The clock in this model will set itself to the correct year, month, date, day, and time, the first time you plug it in, and after every power interruption. The default setting is the Eastern Time zone. All you need do is set it to your own time zone once, and you may never have to adjust it again. Daylight Saving Time and Standard Time adjustments are made automatically, through the year 2099. This model is truly the cure for the annoying “flashing 12:00” display.

This model includes a programmable dual alarm system that allows you to set one or both alarms for weekdays only, weekends only, or everyday operation. And you can have one alarm wake you to the buzzer while the second alarm wakes you to your favorite radio station. There is also a Simple-Set™ direct entry keypad for time and alarm settings, a time projector, and soothing nature sounds.

And the Sure-Alarm battery back up system will operate the buzzer alarm to wake you up even if the power is off at the wake-up time. Best of all, with Xtreme Battery Back Up (XBBU) system the long life 3-volt lithium battery that is pre-installed in your unit will last for 5 to 8 years before it needs to be replaced.....a major money-saver compared to buying new 9-volt batteries every 6 months. And when the 3-volt lithium battery finally does need to be replaced, a low battery indicator begins flashing in the display.

Please read this manual completely to understand all of the great features included in your model. Please retain this manual for future reference, and because the warranty and product service info are printed at the end of this manual.

## Preparation For Use

### Unpacking And Set Up

- Remove the radio from the carton and remove all packing materials from the radio. We recommend that, if possible, you save the carton and packing materials in case your radio ever needs to be returned for service. Using the original carton and packing material is the best way to protect your radio from damage in transit. If you do dispose of the carton and packing material, please do so properly. Timex cares about our environment.
- Unwind the external FM antenna on the back cabinet and extend it to its full length for best FM reception.

### IMPORTANT! Protect Your Furniture

This radio is equipped with non-skid rubber ‘feet’ to prevent the radio from moving when you operate the controls. These ‘feet’ are made from special non-migrating rubber material formulated to avoid leaving any marks or stains on your furniture. However certain types of oil-based furniture polishes, wood preservatives, or cleaning sprays may react with the rubber ‘feet’, causing the rubber material to soften and leave marks or a rubber residue on wooden furniture. If you will be placing this radio on fine wooden furniture we strongly recommend that you place a small cloth between the radio and your furniture, or that you apply small felt pads on the bottom of the rubber ‘feet’.

# Preparation For Use

## Power Source

This radio is designed to operate on normal 120V 60Hz AC power only. Do not attempt to operate this radio on any other power source. You could cause damage to the radio and such damage is not covered by your warranty.

This radio should be connected to an AC outlet that is always 'live'. Do not connect it to an outlet that is controlled by a wall switch. When the power to the radio is interrupted the installed lithium battery takes over to maintain the time and alarm settings, and to operate the buzzer alarm if the power is 'Off' at the wake up time. To maximize the life of the lithium battery keep the radio connected to a 'live' AC outlet at all times.

This radio is equipped with a polarized AC plug with one wide blade and one narrow blade. This is a safety feature designed to minimize the chance of electric shock. If this plug will not fit into your existing AC outlet do not try to force it and do not try to file the wider blade to make it fit. Contact a qualified, licensed electrician to replace your outdated outlet.

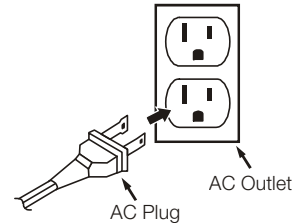

## Sure Alarm Battery Back-Up System

This Timex Redi-Set Clock Radio includes a Sure-Alarm battery back-up circuit that will wake-you up even if the power is 'off' at the selected wake-up time. If your power is 'off' at the wake up time the clock display will be off and the radio will not operate, but a separate 'mini-buzzer' will turn on automatically to wake you up, even if you selected the Wake To Radio option.

The Sure-Alarm buzzer will sound for 3 minutes and then shut off automatically.

To stop the Sure-Alarm buzzer immediately, press the RADIO ON/OFF button. The SNOOZE button has no effect during Sure-Alarm operation.

**Note:** In order to maximize the life of the built-in lithium battery please be sure to set the **Alarm 1** and **Alarm 2** switches to the **'OFF'** position if the radio will be disconnected from the AC outlet for more than a few hours. This will prevent the Sure-Alarm buzzer from turning 'On' unnecessarily.

# Controls and Indicators

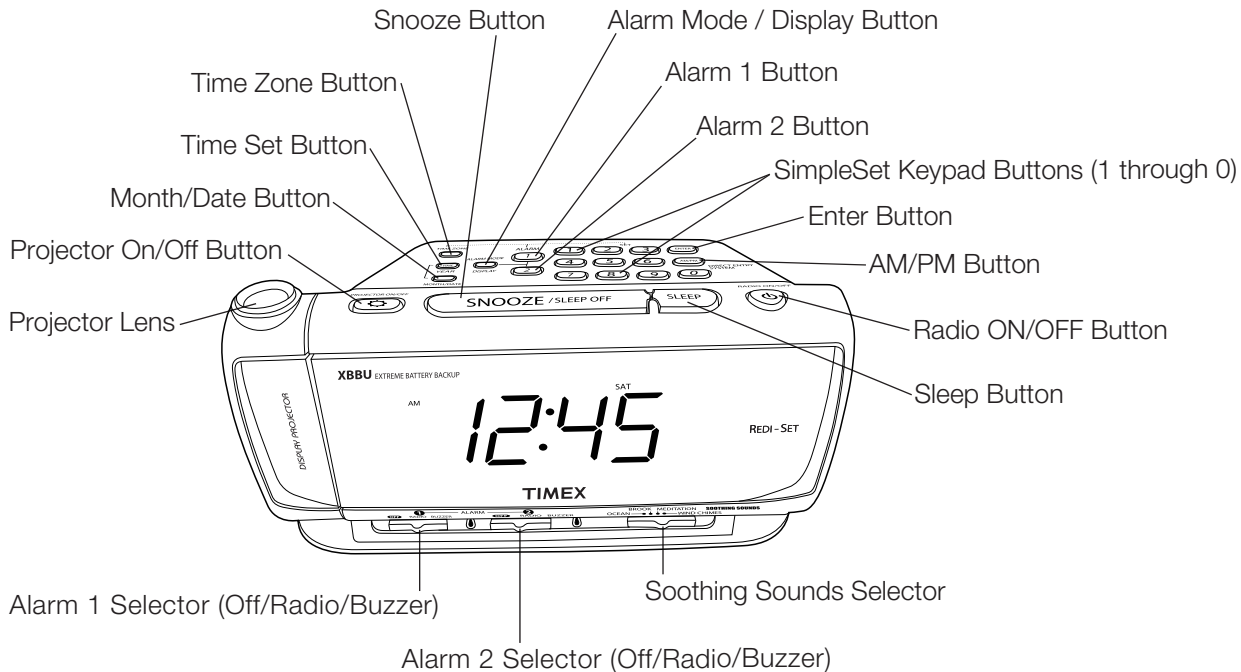

## Back View

### Left View

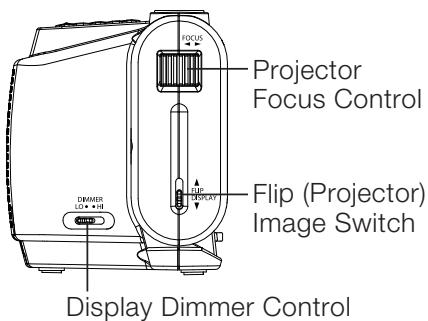

### Right View

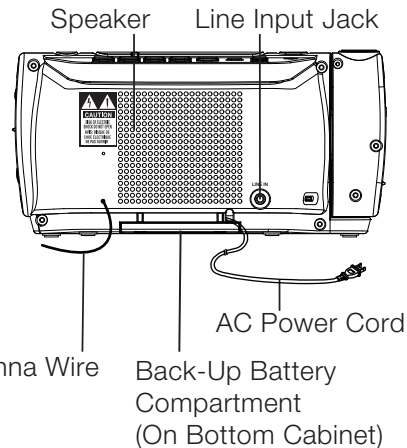
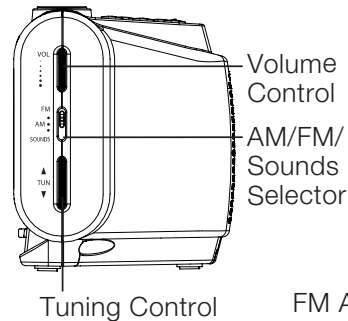

# Display with Indicators

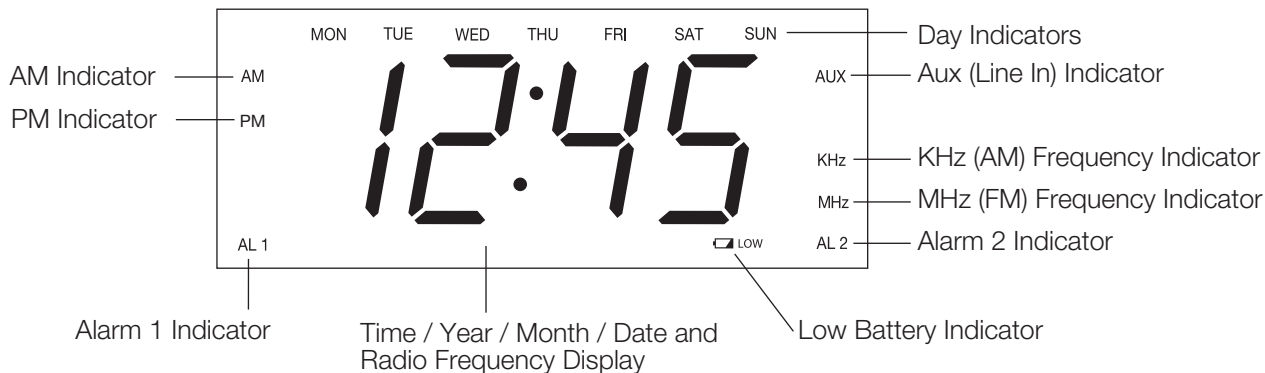

## Operating Instructions

### Setting The Time, The First Time

**IMPORTANT:** The first time you connect your Redi-Set clock radio to the AC outlet the internal computer will automatically set the time correctly for the **Eastern Time Zone**, which is the initial default setting.

The display will begin a countdown sequence (5-4-3-2-1) then the correct year will flash twice, the correct Month/Date will flash twice, and then the correct Eastern Time will be displayed. If you live in the Eastern Time Zone there is nothing else to do. Your Redi-Set clock is set correctly and running.

If you do not live in the Eastern Time zone you must change the default zone display to your own zone. You only do this one time and the Redi-Set internal computer will remember the new default zone setting and will always return to that setting after a power interruption.

There are 7 time zones programmed into your Redi-Set clock radio.

- ZONE 01 – Atlantic Time
- ZONE 02 – Eastern Time (Default Setting)
- ZONE 03 – Central Time
- ZONE 04 – Mountain Time
- ZONE 05 – Pacific Time
- ZONE 06 – Alaskan Time
- ZONE 07 – Hawaiian Time

To change the default time zone, depress and hold the **TIME ZONE button**. The number “02” will appear in the display indicating that the default zone is ZONE 02, Eastern Time, and then the display will begin flashing “0”

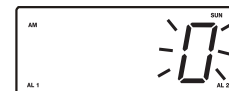



# Operating Instructions

Enter your own 2-digit time zone on the SimpleSet Keypad. For example if you live in the Pacific Time Zone enter "05" on the keypad and then press the **ENTER button**. The clock will 'beep' twice and the time display will change from Eastern Time to Pacific Time.

**Note:** You must always enter a zero (0) before your time zone number. If you do not enter a zero first you will hear a long 'beep' indicating that your time zone was not recognized. If this occurs just re-enter your 2-digit time zone correctly according to the table above on page 5.

## Date Display

To see the correct date at any time, depress the **MONTH/DATE button**. The display changes from Time to Month and Date (MM/DD).

For example, October 9th will be displayed as 10. 9.



## Year Display

To see the correct year, depress the **MONTH/DATE** and **TIME buttons** together.

The display changes from Time to Year.



## Daylight Saving Time (DST) and Leap Year Adjustments

All Daylight Saving Time and Leap Year adjustments are made automatically by the Redi-Set internal computer as follows:

- **Start of Daylight Saving Time** – At 2:00 AM on the 2<sup>nd</sup> Sunday in March the clock will automatically advance to 3:00 AM.
- **End of Daylight Saving Time** – At 3:00 AM on the 1<sup>st</sup> Sunday in November the clock will automatically reset to 2:00 AM.
- **Leap Year** – At 12:00 midnight on February 28<sup>th</sup> in a Leap Year the calendar display will automatically change to "2.29".

**Note:** If you live in an area that **does not** observe Daylight Saving Time (DST) you may disable the automatic Daylight Saving Time (DST) feature. Depress and hold the **TIME ZONE button** for 5 seconds. The display will briefly show "OFF" and then return to the correct time. The automatic DST feature is now disabled and the time **will not** change automatically from Standard Time to Daylight Saving Time. Repeat this procedure again to re-enable the automatic DST feature.

## Manual Time Adjustments

Some people like to set their clocks 5 to 10 minutes fast to make sure that they will always be 'on time'. Even though the Redi-Set internal computer sets the time automatically, you still have the option of adjusting the time manually if you wish.

To manually adjust the time display depress and hold the TIME button for 3 seconds until "0" begins flashing in the display. While the "0" is flashing in the display enter the desired time on the SimpleSet keypad, press the AM/PM button if necessary to switch between AM and PM, and then press the ENTER button. The clock will 'beep' twice to confirm that the setting was accepted and the new time will appear on the display.

**Note:** If you manually adjust the time your new setting is entered into the Redi-Set internal computer as the new default time setting. If the power is interrupted the display will return to your new setting, not the original setting, when the power is restored.

## Adjusting The Wake Up Times

Your Redi-Set clock radio has two separate alarms that can be set and used independently. You may use the alarms to wake two people at different times, or you may use one alarm for weekdays and the other for weekend wake up times.

The initial default setting for Alarm 1 is 6:00 AM. The initial default setting for Alarm 2 is 7:00 AM.

The procedure for adjusting the wake-up times is the same for both Alarm 1 and Alarm 2.

1. Depress and hold either the **ALARM 1** or **ALARM 2 Setting Button** for 3 seconds. The display will briefly show the current Alarm 1 or Alarm 2 wake up time and then "0" begins flashing.
2. Enter the desired wake-up time on the SimpleSet keypad, press the AM/PM button to switch between AM and PM wake-up time if necessary, and then press the ENTER button. The clock will 'beep' twice to confirm that the new alarm time has been accepted and the display will return to the correct time.

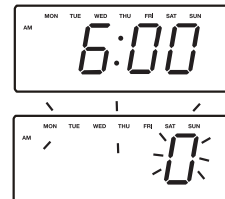

### Notes:

- Be sure that you have set the wake-up time correctly for AM or PM by observing the AM/PM indicators on the display.
- If you enter an invalid time on the keypad you will hear a long 'beep' and the display will return to the flashing "0". Re-enter a valid wake-up time and press the ENTER button again.

## Selecting The Alarm Mode

Your Redi-Set clock radio allows you to select from among three different alarm operation modes for either alarm. The alarm modes are:

- **Everyday** – the alarm will turn on all 7 days.
- **Weekdays only** – the alarm will only turn on Monday through Friday.
- **Weekends only** – the alarm will only turn on Saturday and Sunday.

To check the Alarm Mode setting for Alarm 1, depress the ALARM 1 setting button. The display will show the Alarm 1 wake-up time and the Day indicators will show you the alarm mode that is selected.

- If all 7 Day indicators are 'On', the Everyday alarm mode is selected.
- If only the **MON** (Monday) through **FRI** (Friday) indicators are 'On', the Weekdays only mode is selected.
- If only the **SAT** (Saturday) and **SUN** (Sunday) indicators are 'On', the Weekends only mode is selected.



### To change the Alarm Mode setting for Alarm 1:

1. Hold the **ALARM 1 setting button** for 3 seconds until "0" begins flashing in the display.
2. Enter a new wake-up time on the SimpleSet keypad, or re-enter the current wake up time and continue pressing the **ALARM MODE (Display) button** until the Day indicators show the desired mode, Weekdays only, Weekends only, or Everyday operation.
3. Press the **AM/PM button** if necessary and then press the **ENTER button** to save the new Alarm Mode selection.

Follow the same procedure to select the desired Alarm Mode for Alarm 2 if necessary.

## Checking The Wake-Up Times And Alarm Mode

Whenever you want to check the wake-up time or alarm mode settings, briefly press either the ALARM 1 or ALARM 2 Setting Buttons. The display will change from correct time to “wake-up time” and the DAY indicators will show you the alarm mode that is currently selected.

Release the **ALARM 1** or **ALARM 2 setting buttons** to return to the correct time.

## Listening to The Radio

### Digital Radio Frequency Display

This clock radio features a digital radio frequency display instead of a dial scale to make tuning easier, especially in a dark room. The jumbo LED time display automatically changes to a radio frequency display as soon as you begin turning the TUNING control. And the display automatically changes back to the correct time within 5 seconds after you release the TUNING control.

1. Set the **BAND AM/FM/SOUNDS selector** switch to the desired band, AM or FM.
2. Set the **VOLUME control** to a low setting.
3. Press the **RADIO ON/OFF button** to turn the radio ‘On’. The display changes from time to an AM or FM Frequency.
4. Rotate the **TUNING control** to select the desired radio frequency.



**Important: It is not necessary to set the display to the exact frequency of your desired station. Just use the display as a guide and rotate the TUNING control until you find the strongest and the best reception even if the frequency number shown on the display is slightly higher or lower than the actual station frequency.**

Within 5 seconds after you release the **TUNING control** the display automatically returns to the correct time. If you wish to check the station frequency again, press the **ALARM MODE (Display) button**. The display will change from time to radio frequency for 5 seconds and then return to time display.

5. Adjust the **VOLUME control** to the desired setting.
6. When you are finished listening press the **RADIO ON/OFF button** to turn the radio ‘Off’.

### Antenna Information

**AM** – The AM bar antenna is inside the cabinet. If AM reception is weak, change the position of the cabinet until the internal antenna picks up the strongest signal.

**FM** – Make sure the external FM antenna wire on the back cabinet is fully unwound and extended to its full length.



### Natural/Soothing Sounds

This model includes four natural soothing sounds that you can use to help you fall asleep, or to wake you up, as an alternative to the radio or the buzzer. To operate the soothing sounds:

- Press the **RADIO ON/OFF button** to turn the system ‘On’.
- Set the **AM/FM/SOUNDS selector** to SOUNDS. One of the 4 sounds will begin playing.
- Select the desired sound with the **Soothing Sounds selector** switch.
- Adjust the **VOLUME control** to the desired level.
- When you are finished listening press the **RADIO ON/OFF button** to turn the system ‘Off’.

## Wake To Radio

1. Turn the radio 'On' and select the band, station, and volume level that you wish to hear when the alarm comes 'On', then turn the radio 'Off' again.
2. Reconfirm the wake-up time and alarm mode settings for the alarm you are using, Alarm 1 or Alarm 2, or both alarms.
3. Slide the **ALARM SELECTOR control** on the front panel for one or both alarms to the Radio position. The appropriate AL 1 and/or AL 2 indicators will light up to confirm that the alarms are set.
4. At the selected wake-up time the radio will turn 'On'. It will play for one hour and then shut off automatically.
5. To stop the radio sooner, press either the appropriate **ALARM 1** or **ALARM 2 button**, or press the **RADIO ON/OFF button**. The radio will stop but the alarm remains set and will turn on again at the same time on the following day, depending on the Alarm Mode setting.
6. If you do not want the alarm to repeat on the following day, slide the appropriate **ALARM SELECTOR switch** to the 'Off' position. The AL 1 and/or AL 2 indicators turn off.

## Wake To Soothing Sounds

1. Turn the radio 'On', set the **AM/FM/SOUNDS selector** to the SOUNDS position, select the desired sound, and adjust the **VOLUME control** as desired. Then turn the radio 'Off' again.
2. Reconfirm the wake-up time and alarm mode settings for the alarm you are using, Alarm 1 or Alarm 2, or both alarms.
3. Slide the **ALARM SELECTOR control** on the front panel for one or both alarms to the Radio position. The appropriate AL 1 and/or AL 2 indicators will light up to confirm that the alarms are set.
4. At the selected wake-up time the selected sound will turn 'On'. It will play for one hour and then shut off automatically.
5. To stop the sound sooner, press either the appropriate ALARM 1 or ALARM 2 button, or press the **RADIO ON/OFF button**. The sound will stop but the alarm remains set and will turn on again at the same time on the following day, depending on the Alarm Mode setting.
6. If you do not want the alarm to repeat on the following day, slide the appropriate **ALARM SELECTOR switch** to the 'Off' position. The AL 1 and/or AL 2 indicators turn off.

## Wake To Buzzer (Crescendo Alarm)

**Note:** Alarm 1 and Alarm 2 have different buzzer sounds.

- Alarm 1 is a "Single Beep" sound.
- Alarm 2 is a "Double Beep" sound.

You will be able to tell which alarm is going off by the sound that it makes.

1. Reconfirm the wake-up time and alarm mode settings for the alarm you are using, Alarm 1 or Alarm 2, or both alarms.
2. Slide the **ALARM SELECTOR control** on the front panel for one or both alarms to the Buzz position. The appropriate AL 1 and/or AL 2 indicators will light up to confirm that the alarms are set.
3. At the selected wake-up time the buzzer will turn 'On'. It will continue for one hour and then shut off automatically.
4. To stop the alarm sooner, press the appropriate **ALARM 1** or **ALARM 2 button** or the **RADIO ON/OFF button**. The buzzer will stop but the alarm remains set and will turn on again at the same time on the following day, depending on the Alarm Mode setting. To turn the radio on immediately press the **RADIO ON/OFF button** a second time.
5. If you do not want the alarm to turn the buzzer on the following day, set the appropriate ALARM selector to the 'Off' position.

## Radio And Buzzer Operation

You may set one alarm for wake to RADIO and the other for wake to BUZZER. Just set the ALARM 1 and ALARM 2 Selector Controls to the desired positions.

## Snooze Control

After the alarm turns on in the morning you may press the **Snooze button** to stop the alarm for 9 minutes. After 9 minutes the alarm turns on again.

The Snooze operation may be repeated several times within one hour of the original alarm time. But after one hour the alarm will not turn on again.

During Snooze operation the appropriate Alarm indicator flashes in the display.

## Sleep To Music or Soothing Sounds Timer

You can program the Sleep Timer to play the radio or soothing sounds from 1 minute up to 99 minutes and then shut off automatically. The factory default sleep timer setting is 60 minutes.

1. Press the **SLEEP button**. The display will briefly show “60” and the radio or selected sound will begin to play. After 60 minutes the radio will shut off automatically. Each time you press the **SLEEP button** the sleep timer will start at 60 minutes. This is the initial sleep timer default setting.



2. To increase or decrease the amount of time that the radio will play before shutting off, hold the **Sleep button** for 3 seconds until a “0” begins flashing in the display, then use the SimpleSet keypad to enter the desired sleep timer setting between 1 minute and 99 minutes. When the desired time is showing on the display press the **ENTER button** to save the new setting. The clock will ‘beep’ twice to confirm that the new setting has been accepted.

### Notes:

- When you change the sleep timer from the 60-minute default setting to a different setting, the new setting becomes the new default setting. Whenever you activate the sleep timer it will begin with your new default setting and count down to zero from that point.
  - If you enter an invalid sleep time on the keypad you will hear a long ‘beep’ to warn you that you have entered an invalid number. Use the SimpleSet keypad to enter a valid number (1 to 99) and press the **ENTER button** again.
3. To cancel the sleep timer before it counts down to “00” and shut the radio ‘Off’ immediately, press the SNOOZE bar.

### IMPORTANT:

Remember that the station and volume settings that you choose for the “Sleep To Music” operation are the same settings that you will hear if you set the alarm for wake to radio the following morning.

## Display Dimmer Control

You can reduce the display brightness by sliding the **DIMMER control** to the Low position.

## Projector Operation

**IMPORTANT:** The projected image will be most visible when the room is dark. The image may not be visible during daylight hours or in a brightly lit room.

Please note that there is no 'PM' indicator in the projector display. If the 'AM' indicator does not appear then the time being projected is 'PM'.

1. Press the **PROJECTOR ON/OFF button** to turn the projector 'On'.
2. Turn the projector housing slowly to aim the projected image on your wall or ceiling.

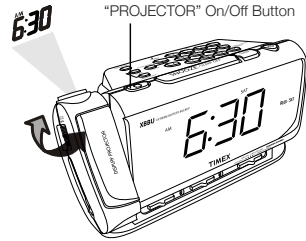

3. If the image appears to be upside down on your wall or ceiling when you are lying in bed, set the **FLIP IMAGE switch** to its alternate position.

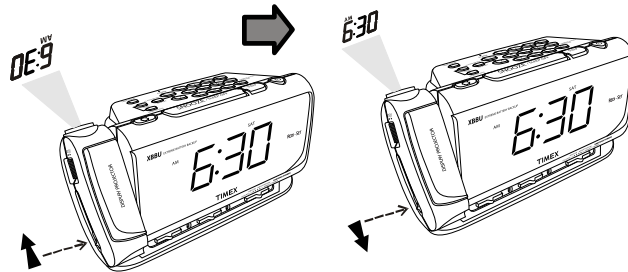

4. If the image is fuzzy or out of focus, slowly rotate the **FOCUS adjustment ring** clockwise or counter-clockwise until you achieve the sharpest focus.

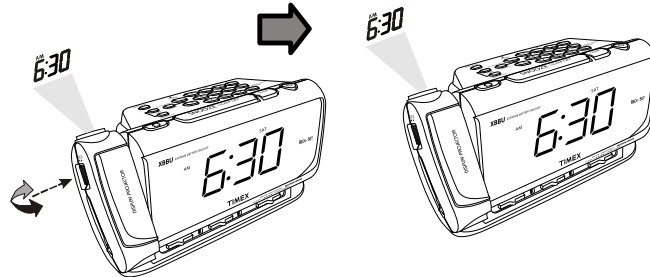

5. If you do not want to see the projected image, press the **PROJECTOR ON/OFF button** to switch the projector 'Off'.

## Line Input Jack

You may listen to the sound from an iPod, MP3 player, CD player or other external music source by connecting the external device to the Line In jack on the back of this clock radio. Use an audio cable (not included) with 3.5mm mini plugs to connect the headphone jack of the external device to the Line In jack of this unit. An AUX indicator will appear on the display when a cable is connected to the Line In jack of this radio. Begin playback on the external device and adjust the VOLUME control of this clock radio.

**Note:** You must remove the audio cable from the Line In jack of this clock radio in order to listen to AM or FM. When the audio cable is disconnected the AUX indicator turns 'Off' in the display.

## Changing The Lithium Back-Up Battery

When the back-up battery voltage drops below a certain level the Low Battery indicator (  LOW ) begins flashing in the display. When you see this indicator you should replace the battery as soon as it is convenient for you to do so.

To replace the battery, proceed as follows:

**IMPORTANT:** Leave the radio connected to the AC outlet when replacing the battery to avoid losing all of your time and alarm settings.

1. Purchase a replacement 3V lithium battery. The battery type is **CR2450**. This type battery is available almost everywhere that batteries are sold.
2. Remove the battery from the packaging so it is ready to install.
3. Place that radio face down on a towel or similar soft surface to avoid scratching the front lens.
4. Use a small Phillips screwdriver to remove the screw that secures the battery holder and slide the battery holder out of the cabinet.
5. Remove the original battery from the battery holder and insert the new battery into the holder in the same way, with the "+" side facing up. Slide the battery holder with the new battery back into the cabinet and secure the holder with the small screw.
6. Turn the radio right side up and confirm that the Low Battery indicator (  LOW ) is 'Off'.

**CAUTION:** Danger of explosion if battery is incorrectly replaced.

Replace only with the same or equivalent type.

**PRÉCAUTION:** Danger d'explosion si les piles sont remplacées de façon incorrect.

Remplacer les piles seulement par le même type de pile ou l'équivalent.

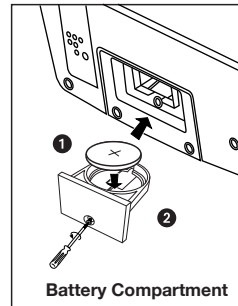

## Resetting The Clock After a Total Memory Loss

If you experience a power failure with an exhausted back-up battery in the radio, all of the time and alarm settings may be lost. In this case the clock will reset itself to its initial default settings when power is restored. If you notice that the time on the display is incorrect, press the **MONTH/DATE button** to check the calendar setting. If the Month and Date are also incorrect you probably experienced a total memory loss.

To reset the clock after a total memory loss, proceed as follows:

1. Follow the instructions on page 12 and install a fresh CR2450 lithium back-up battery.
2. Connect the radio to the AC outlet and wait until the time is displayed.
3. Press and hold the **MONTH/DATE** and **TIME buttons** together for 3 seconds. The year will appear briefly followed by a flashing "0". Use the SimpleSet keypad to enter the correct year and then press the **ENTER button**. The clock will beep twice to confirm the setting.

4. Press and hold the **MONTH/DATE button** for 3 seconds. The month and date (MM/DD) will appear briefly followed by a flashing "0". Use the SimpleSet keypad to enter the correct month and date in the MM/DD format and then press the **ENTER button**. The clock will beep twice to confirm the setting. The Day indicator will automatically change to match the Year, Month, and Date you selected.
5. Press and hold the **TIME button** for 3 seconds until a flashing "0" appears in the display. Use the SimpleSet keypad to enter the correct time, press the **AM/PM button** if necessary, and then press the **ENTER button** to save the setting. The clock will 'beep' twice to confirm that the setting was accepted and the clock will begin to run.
6. **After you have reset the Year, Month/Date, and Time displays, check your alarm time and alarm mode settings and adjust as required.**

### **Lithium Battery Precautions**

- Dispose of exhausted battery properly, in accordance with your local regulations.
- Do not leave the exhausted battery lying around where a young child or pet could play with or swallow it. If the battery is swallowed, contact a physician immediately.
- Battery may explode if mistreated. Do not attempt to recharge it or disassemble it. Do not dispose of the old battery in a fire.

## **Care and Maintenance**

There are no user serviceable parts inside this radio. Please refer all service problems to a qualified service facility.

If the cabinet becomes dusty wipe the exterior with a soft dust cloth only. Never use dusting sprays or polishes on the cabinet.

If the cabinet becomes dirty or smudged with fingerprints it may be wiped with a soft cloth that has been slightly dampened with a mild soap and water solution. Always disconnect the power cord from the AC outlet before cleaning and never allow any liquid to get inside the cabinet.



## Limited 90-Day Warranty Information

---

Timex Audio Products, a division of SDI Technologies Inc. (hereafter referred to as SDI Technologies), warrants this product to be free from defects in workmanship and materials, under normal use and conditions, for a period of 90 days from the date of original purchase.

Should service be required by reason of any defect or malfunction during the warranty period, SDI Technologies will repair or, at its discretion, replace this product without charge (except for a \$5.00 charge for handling, packing, return UPS/postage, and insurance). This decision is subject to verification of the defect or malfunction upon delivery of this product to the Factory Service Center listed below. The product must include proof of purchase, including date of purchase. The fee for service after the warranty period or without proof of purchase is \$15.00.

Before returning this product for service, please first replace the batteries (if applicable) with fresh ones, as exhausted or defective batteries are the most common cause of problems encountered.

If service is still required:

1. Remove batteries (if applicable) and pack the unit in a well-padded, heavy corrugated box.
2. Enclose a photocopy of your sales receipt, credit card statement, or other proof of the date of purchase.
3. Enclose a check or money order payable to the order of SDI Technologies, Inc. for the sum of \$5.00 (or \$15.00 if after the warranty period or without proof of purchase).
4. Send the unit prepaid to the Factory Service Center listed below:

### **Consumer Repair Department**

SDI Technologies Inc.  
Timex Audio Products Division  
1330 Goodyear Drive  
El Paso TX 79936-6420

**NOTE:** This warranty is valid only if the product is used for the purpose for which it was designed. It does not cover (i) products which have been damaged by negligence, misuse or accident, or which have been modified or repaired by unauthorized persons; (ii) cracked or broken cabinets, or units damaged by excessive heat; (iii) damage to tape cassettes (if applicable); (iv) the cost of shipping this product to the Factory Service Center and its return to the owner.

This warranty is valid only in the United States of America and does not extend to owners of the product subsequent to the original purchaser. Any applicable implied warranties are also limited to 90 days, and SDI Technologies will not be liable for consequential damages. (Some states do not allow limitations on implied warranties or exclusion of consequential damages, so these restrictions may not apply to you.) This warranty gives you specific legal rights, and you may also have other rights which vary from state to state.

**© 2009 SDI Technologies, Inc. All rights reserved**

**TIMEX is a registered trademark of Timex Corporation the United States and other countries**

## Free Manuals Download Website

<http://myh66.com>

<http://usermanuals.us>

<http://www.somanuals.com>

<http://www.4manuals.cc>

<http://www.manual-lib.com>

<http://www.404manual.com>

<http://www.luxmanual.com>

<http://aubethermostatmanual.com>

Golf course search by state

<http://golfingnear.com>

Email search by domain

<http://emailbydomain.com>

Auto manuals search

<http://auto.somanuals.com>

TV manuals search

<http://tv.somanuals.com>