



## INSTRUCTION MANUAL

**SYSTEM MANAGEMENT AMPLIFIER**

**VM-2120 (120 W)**

**VM-2240 (240 W)**

**REMOTE MICROPHONE**

**RM-200M**

**REMOTE MICROPHONE EXTENSION**

**RM-210**

**VOICE ANNOUNCEMENT BOARD**

**EV-200**

**SURVEILLANCE BOARD**

**SV-200M**

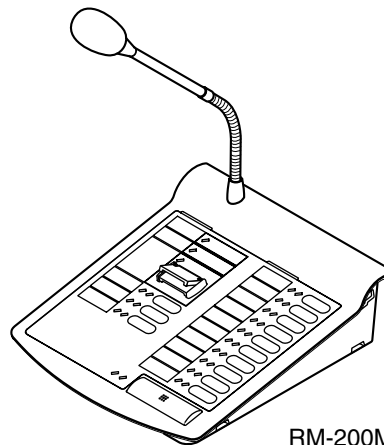

RM-200M

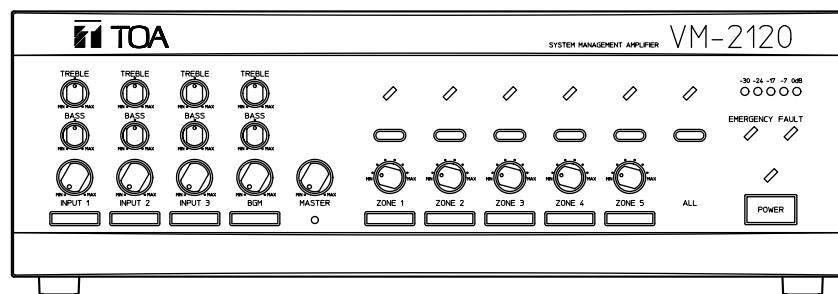

VM-2120

Please follow the instructions in this manual to obtain the optimum results from this unit. We also recommend that you keep this manual handy for future reference.

**TOA Corporation**

# TABLE OF CONTENTS

<b>1. SAFETY PRECAUTIONS</b> .....	4
<b>EQUIPMENT OUTLINES</b>	
<b>2. GENERAL DESCRIPTION</b> .....	6
<b>3. FEATURES</b> .....	6
<b>4. HANDLING PRECAUTIONS</b> .....	7
<b>5. INSTALLATION PRECAUTIONS</b> .....	7
<b>6. NOMENCLATURE AND FUNCTIONS</b>	
6.1. System Management Amplifier VM-2120/-2240 .....	8
6.2. Remote Microphone RM-200M .....	12
6.3. Remote Microphone Extension RM-210 .....	13
<b>7. SYSTEM CONFIGURATIONS</b>	
7.1. Remote Microphone/VM Amplifier Configuration (The Number of Connected Units) .....	14
7.2. Remote Microphone Operation Panel Function .....	14
7.3. Connection between Remote Microphone and VM Amplifier .....	16
7.4. Power Supply from the VM Amplifier to Remote Microphone .....	16
<b>OPERATIONS</b>	
<b>8. EMERGENCY ("ALERT" AND "EVACUATION") BROADCAST</b>	
8.1. Emergency Broadcast Equipment .....	18
8.2. Keys/Indicators Used for Emergency Broadcast .....	18
8.3. Emergency Broadcast Operation (Typical Example) .....	19
8.4. Emergency Broadcast Sequence .....	21
<b>9. BROADCAST OPERATION AT THE AMPLIFIER</b>	
9.1. Microphone Announcements (When Operated by Control Input) .....	22
9.2. Background Music Broadcast .....	22
<b>10. REMOTE MICROPHONE GENERAL-PURPOSE BROADCAST</b>	
10.1. Operation and Display Sections .....	23
10.2. Broadcast Operation .....	24
<b>11. GENERAL-PURPOSE BROADCAST PRIORITY</b>	
11.1. Broadcast Source-to-Priority Relationship .....	27
11.2. Broadcast Priority between Equipment with the Equal Priority Level	
11.2.1. Priority mode between equipment with the equal priority level .....	28
11.2.2. Priority function when 2 broadcasts with the equal priority level are simultaneously made .....	29
11.3. Priority Function during BGM Broadcast .....	29
<b>12. CHIME FUNCTION</b>	
12.1. Available Chime Tone Types	
12.1.1. Seven different chime tones .....	30
12.1.2. Six built-in chimes .....	30
12.1.3. Pre-recorded chime .....	30
12.2. How the Chime Tone Is Used	
12.2.1. Chime tone for Inputs 1 – 3 .....	30
12.2.2. Telephone paging chime tone .....	30
12.2.3. Independent chime activation (remote control) .....	31
12.2.4. Westminster chime .....	32
<b>AMPLIFIER INSTALLATION</b>	
<b>13. CHOKE COIL INSTALLATION</b> .....	33
<b>14. INPUT TRANSFORMER INSTALLATION AND     ITS BOARD MODIFICATION</b>	
14.1. Transformer Installation .....	34
14.2. Switching Off the Phantom Power Supply .....	35
14.3. Instructions When the Sub- and Master VM Amplifiers Are Connected .....	35

<b>15. MOUNTING AN OPTIONAL EV-200 VOICE ANNOUNCEMENT BOARD</b>	36
<b>16. MOUNTING AN OPTIONAL SV-200M SURVEILLANCE BOARD</b>	38
<b>17. RACK MOUNTING</b>	40
<b>AMPLIFIER CONNECTIONS</b>	
<b>18. AMPLIFIER INPUT CONNECTION</b>	
18.1. Two Amplifiers Stack-Connection	40
18.2. Microphone Connection to the VM Amplifier	40
18.3. Telephone Paging Input Connections	41
<b>19. EXTERNAL ATTENUATOR CONTROL WIRING</b>	
19.1. 4-Wire System Connection	42
19.2. 3-Wire System Connection	43
<b>20. CHANGING THE SPEAKER LINE VOLTAGE</b>	44
<b>21. CONTROL I/O CONNECTOR FUNCTIONS</b>	45
<b>22. SURVEILLANCE I/O CONNECTOR FUNCTIONS</b>	47
<b>SETTINGS</b>	
<b>23. FUNCTION SWITCH OPERATION</b>	
23.1. VM Amplifier's Rear Panel-Mounted Function Switches	48
23.2. VM Amplifier's Internal Function Switches	49
23.3. Remote Microphone's Function Switches	50
<b>24. BROADCAST GROUP/ZONE SETTING</b>	
24.1. Routing Assignment	
24.1.1. Zone-to-Group assignment	51
24.1.2. Control input/Telephone paging /Westminster chime-to-Group assignment	51
24.1.3. Recorded Message-to-Group assignment	52
24.2. Operating Keys	52
24.3. Zone-to-Group Assignment Operation	53
24.4. Control Input/Telephone Paging /Westminster Chime-to-Group Assignment Operation	56
24.5. Recorded Message-to-Group Assignment Operation	58
<b>REMOTE MICROPHONE INSTALLATION</b>	
<b>25. LINKAGE BETWEEN REMOTE MICROPHONE AND ITS EXTENSION</b>	59
<b>MISCELLANEOUS</b>	
<b>26. NAME LABEL PREPARATION</b>	
26.1. Amplifier's Label Preparation	60
26.2. Remote Microphone's Label Preparation	
26.2.1. Name label type and usable paper	60
26.2.2. Preparing the name label	60
26.2.3. Inserting the name label	60
<b>27. COMPACTFLASH (CF) CARD RECORDING</b>	
27.1. Recording	63
27.2. Message Program/Sentence Composition Example	63
27.3. Message Program Example	64
<b>28. BLOCK DIAGRAM</b>	65
<b>29. SPECIFICATIONS</b>	
System Management Amplifier VM-2120/-2240	66
Remote Microphone RM-200M	69
Remote Microphone Extension RM-210	69
Voice Announcement Board EV-200	70
Accessories	70
Optional products	70

# 1. SAFETY PRECAUTIONS

- Be sure to read the instructions in this section carefully before use.
- Make sure to observe the instructions in this manual as the conventions of safety symbols and messages regarded as very important precautions are included.
- We also recommend you keep this instruction manual handy for future reference.

## Safety Symbol and Message Conventions

Safety symbols and messages described below are used in this manual to prevent bodily injury and property damage which could result from mishandling. Before operating your product, read this manual first and understand the safety symbols and messages so you are thoroughly aware of the potential safety hazards.



Indicates a potentially hazardous situation which, if mishandled, could result in death or serious personal injury.



Indicates a potentially hazardous situation which, if mishandled, could result in moderate or minor personal injury, and/or property damage.



### When Installing the Unit

[Applicable to all models]

- Do not expose the unit to rain or an environment where it may be splashed by water or other liquids, as doing so may result in fire or electric shock.
- Use the unit only with the voltage specified on the unit. Using a voltage higher than that which is specified may result in fire or electric shock.
- Avoid installing or mounting the unit in unstable locations, such as on a rickety table or a slanted surface. Doing so may result in the unit falling down and causing personal injury and/or property damage.

[Applicable to the VM-2120/-2240]

- Do not cut, kink, otherwise damage nor modify the power supply cord. In addition, avoid using the power cord in close proximity to heaters, and never place heavy objects – including the unit itself – on the power cord, as doing so may result in fire or electric shock.

[Applicable to the RM-200M/-210]

- Install the unit only in a location that can structurally support the weight of the unit and the mounting bracket. Doing otherwise may result in the unit falling down and causing personal injury and/or property damage.

- Do not use other methods than specified to mount the bracket. Extreme force is applied to the unit and the unit could fall off, possibly resulting in personal injuries.
- Use nuts and bolts that are appropriate for the ceiling's or wall's structure and composition. Failure to do so may cause the unit to fall, resulting in material damage and possible personal injury.

### When the Unit is in Use

[Applicable to all models]

- To prevent a fire or electric shock, never open nor remove the unit case as there are high voltage components inside the unit. Refer all servicing to your nearest TOA dealer.
- Do not place cups, bowls, or other containers of liquid or metallic objects on top of the unit. If they accidentally spill into the unit, this may cause a fire or electric shock.
- Do not insert metallic objects such as pointed objects and coins, or flammable materials in the unit's openings, as this may result in fire or electric shock.
- Do not touch a plug during thunder and lightning, as this may result in electric shock.

[Applicable to the VM-2120/-2240]

- Should the following irregularity be found during use, immediately switch off the power, disconnect the power supply plug from the AC outlet and contact your nearest TOA dealer. Make no further attempt to operate the unit in this condition as this may cause fire or electric shock.
  - If you detect smoke or a strange smell coming from the unit.
  - If water or any metallic object gets into the unit
  - If the unit falls, or the unit case breaks
  - If the power supply cord is damaged (exposure of the core, disconnection, etc.)
  - If it is malfunctioning (no tone sounds.)

## CAUTION

### When Installing the Unit

[Applicable to all models]

- Avoid installing the unit in humid or dusty locations, in locations exposed to the direct sunlight, near the heaters, or in locations generating sooty smoke or steam as doing otherwise may result in fire or electric shock.

[Applicable to the VM-2120/-2240]

- Never plug in nor remove the power supply plug with wet hands, as doing so may cause electric shock.
- When unplugging the power supply cord, be sure to grasp the power supply plug; never pull on the cord itself. Operating the unit with a damaged power supply cord may cause a fire or electric shock.
- When moving the unit, be sure to remove its power supply cord from the wall outlet. Moving the unit with the power cord connected to the outlet may cause damage to the power cord, resulting in fire or electric shock. When removing the power cord, be sure to hold its plug to pull.

[Applicable to the VM-2120/-2240]

An all-pole mains switch with a contact separation of at least 3 mm in each pole shall be incorporated in the electrical installation of the building.

[Applicable to the VM-2120/-2240 and RM-200M]

The socket-outlet shall be installed near the equipment and the plug (disconnecting device) shall be easily accessible.

- Do not block the ventilation slots in the unit's cover. Doing so may cause heat to build up inside the unit and result in fire.

### When the Unit is in Use

[Applicable to all models]

- Do not place heavy objects on the unit as this may cause it to fall or break which may result in personal injury and/or property damage. In addition, the object itself may fall off and cause injury and/or damage.

[Applicable to the VM-2120/-2240]

- Make sure that the volume control is set to minimum position before power is switched on. Loud noise produced at high volume when power is switched on can impair hearing.
- Do not operate the unit for an extended period of time with the sound distorting. This is an indication of a malfunction, which in turn can cause heat to generate and result in a fire.
- Contact your TOA dealer as to the cleaning. If dust is allowed to accumulate in the unit over a long period of time, a fire or damage to the unit may result.
- If dust accumulates on the power supply plug or in the wall AC outlet, a fire may result. Clean it periodically. In addition, insert the plug in the wall outlet securely.
- Switch off the power, and unplug the power supply plug from the AC outlet for safety purposes when cleaning or leaving the unit unused for 10 days or more. Doing otherwise may cause a fire or electric shock.

## 2. GENERAL DESCRIPTION

### [System Management Amplifier VM-2120/VM-2240]

Featuring outstanding audio performance, the TOA System Management Amplifier VM-2120/-2240 satisfies the growing need for reliable and efficient communications for various applications, especially for medium-sized facilities including office building, factories, hospitals, and transportation terminals.

The VM-2120 (120 W) and VM-2240 (240 W) are multifunctional amplifiers that can be mounted in an EIA-Standard equipment rack (3-unit size). Both units come with 4 audio inputs including the background music input, and the speaker output section which has an internal attenuator and 5-zone selector. They permit not only general-purpose broadcast, but also Emergency Broadcast based on the EN60849 Standard which gives pre-recorded voice instructions\*1 in the emergency situation. Broadcast can be made from an optional RM-200M Remote Microphone as well as from the amplifier, and can be remotely controlled from external equipment. In addition, both amplifiers feature the surveillance function\*2 which automatically checks the system for failures.

\*1 An optional EV-200 Voice Announcement Board is required.

\*2 An optional SV-200M Surveillance Board is required.

### [Remote Microphone RM-200M]

The RM-200M is a dedicated unit for both the VM-2120 and VM-2240, and permits Emergency Broadcast as well as general-purpose broadcast.

### [Remote Microphone Extension RM-210]

The RM-210 is an extension unit for the RM-200M's key operating section.

## 3. FEATURES

- Broadcasts of up to 480 W can be made to up to 10 zones individually or simultaneously. (when 2 VM-2240's are used).
- Permits monitoring of individual speaker line or power amplifier failures for status indication. (Requires the optional SV-200M Surveillance Board.)
- Reproduces 5 general-purpose messages, 1 chime tone, and 2 emergency messages. (Recordable as you like using the optional EV-200 Voice Announcement Board)
- Six different built-in chimes and prerecorded chime tones (by the EV-200) can be selected to attract attention to broadcasts.
- Backup battery maintains operation during power failures.
- Emergency broadcast based on the EN60849 Standard provides prerecorded voice instructions in the emergency situation.
- Emergency broadcast bypasses both the amplifier volume control and the external attenuator, making sure that the broadcast is heard throughout all zones.
- Features following broadcast priority levels: the highest level for Emergency broadcasts and 4 levels for general-purpose broadcasts.
- Speaker lines for 100 V line applications (standard) or for 50 V or 70 V line applications (enabled by changing the unit's internal wiring).
- Up to 4 remote microphones can be connected, and their total connection cables can be extended to 800 m. (RM-200M/-210)
- Speaker zones can be programmed into up to 5 groups for group broadcast. (The remote microphone can broadcast to the Groups 1 and 2 out of the 5 groups.)
- Clear, distortion-free announcements owing to the internal compressor circuitry. (RM-200M/-210)

## 4. HANDLING PRECAUTIONS

### [VM-2120/VM-2240 and RM-200M/RM-210]

To clean, be sure to first switch off the power supply to the unit, then wipe with a dry cloth. When the unit gets very dirty, use a cloth damped in a neutral cleanser. Never use benzene, thinner or chemically-treated cleaning cloth because such volatile liquids could deform or discolor the unit.

### [VM-2120/VM-2240]

- When the EV-200 is mounted, never move the unit from one place to another with the Flash Card inserted because the EV-200 or the CompactFlash card may fail.
- Avoid inserting or withdrawing the CompactFlash card while the unit is alive.

## 5. INSTALLATION PRECAUTIONS

### [VM-2120/VM-2240 and RM-200M/RM-210]

- Do not install the unit in locations exposed to the direct sunlight or heaters, as the unit could be deformed or discolored.
- Avoid installing or storing the unit in dusty or humid locations, as doing otherwise could cause the unit's failure.
- Keep the unit as far away as possible from a fluorescent lamp, digital equipment, PC or other equipment which generate high frequency noise.

### [VM-2120/VM-2240]

- Do not block the ventilation slots on the upper, right and left, and rear sides to allow inside heat radiation.
- Keep at least 50 mm space from the unit's right and left sides for heat radiation.

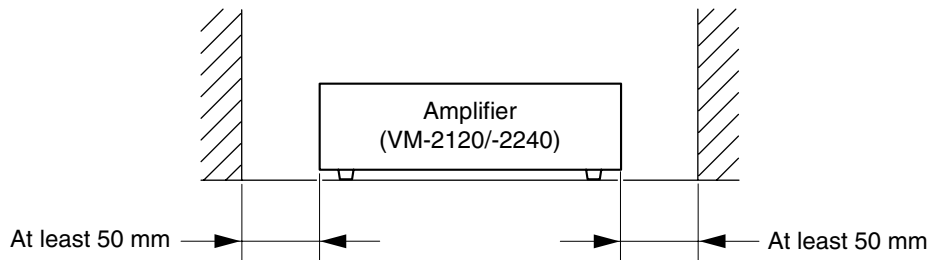

- Never connect the AC power cord to any other line voltage than that specifically designated.
- To avoid oscillation, keep the input cable away from the output cable. Particular care must be exercised when mounting the unit in an equipment rack.
- In some installations, a ground loop is formed and hum noise may be generated. In such cases, connecting the rear-mounted signal earth terminal to the body of connected equipment (BGM sound source, expansion amplifier, etc.) may reduce it.
- Never connect two amplifier outputs in parallel under any circumstances.

#### Caution

- When such work as mounting optional boards or setting switches needs to open the amplifier's top cover, leave it to a qualified service technician.
- In the case above, be sure to switch the power off before the work.
- A warning that TERMINALS marked with the symbol ⚡ are HAZARDOUS LIVE and that the external wiring connected to these TERMINALS requires installation by an INSTRUCTED PERSON or the use of ready-made leads or cords.

## 6. NOMENCLATURE AND FUNCTIONS

### 6.1. System Management Amplifier VM-2120/-2240

[Front]

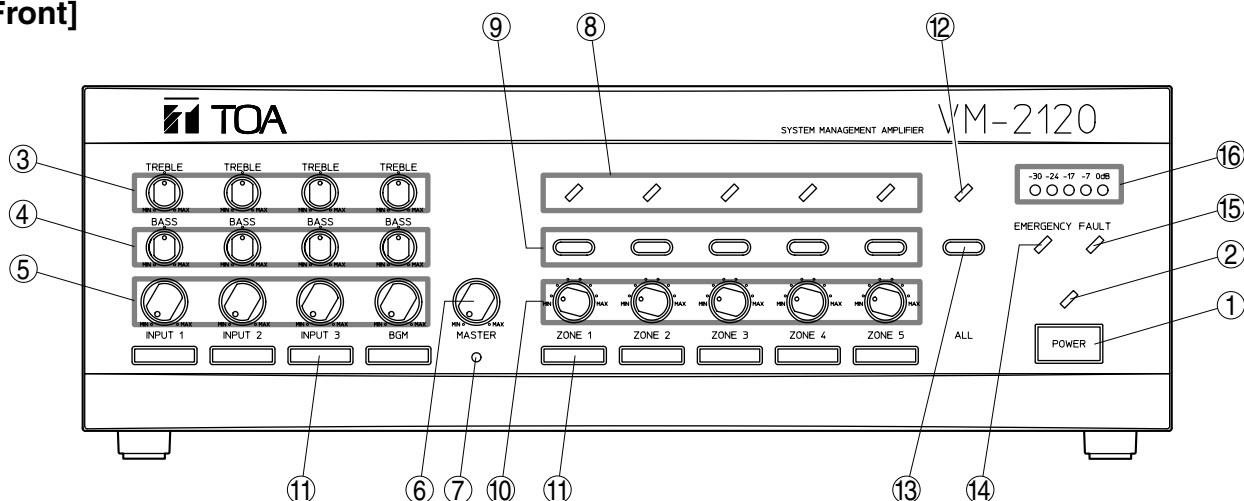

The VM-2120 is shown in the figure. The VM-2240 is the same in both appearance and function.

#### 1. Power switch [POWER]

Turns on and off the power. Press continuously for 0.3 second or more to turn off the power.

#### 2. Power indicator

Lights when the power is turned on, and is extinguished when turned off.

#### 3. Treble control [TREBLE]

Adjusts the level of high frequency sound from Inputs 1 – 3 and the BGM Input. Turn clockwise to accentuate the high frequency output and counterclockwise to attenuate it. The center click position indicates a flat frequency response.

#### 4. Bass control [BASS]

Adjusts the level of low frequency sound from Inputs 1 – 3 and the BGM Input. Turn clockwise to accentuate the low frequency output and counterclockwise to attenuate it. The center click position indicates a flat frequency response.

#### 5. Input volume control [INPUT 1 – 3, BGM]

Adjusts the sound volume for Inputs 1 – 3 and the BGM Input.

#### 6. Master volume control [MASTER]

Adjusts the mixed sound volume for Inputs 1 – 3 and the BGM Input.

#### 7. Reset key

Press this recessed key with a pointed object to reset the unit's internal computer if the unit malfunctions, key inputs are not accepted or other troubles occur. Note that other preset parameters are not reset. This key is also used in combination with other keys to enter the setting mode.

#### 8. Zone indicator

Lights to indicate the broadcast zone (Zones 1 – 5) selected with the Zone Selector key.

Flashes to show the speaker zone which is being inspected or has failed when the surveillance function operates. (See p. 11 No. 41.)

#### 9. Zone selector key

Selects the desired broadcast zone.

#### 10. Zone volume control [ZONE 1 – 5]

Adjusts the broadcast volume for Zones 1 – 5 in 6 steps: 0 dB (Max. position), –3 dB, –6 dB, –10 dB, –15 dB, and –20 dB (Min. position).

#### 11. Name label

Used for indicating the name of each input and zone. (The blank labels are supplied with the unit.)

#### 12. All-zone broadcast indicator

Lights when the All-Zone Broadcast is made.

#### 13. All-zone broadcast key [ALL]

Press this key when making the All-Zone Broadcast.

#### 14. Emergency indicator [EMERGENCY]

Lights when the unit is in Emergency mode. (See p. 21.)

#### 15. Failure indicator [FAULT]

Lights when communications with the remote microphone or expansion amplifier are not correctly performed, the Voice Announcement board malfunctions, or speaker line failure (short circuit, ground fault, or disconnection) occurs. Failure information is transmitted from the rear panel-mounted control input and output connector [CONTROL I/O] (No. 30).

#### 16. Level meter

Indicates the power amplifier's output level, reaching "0 dB" at rated output (100 V). In general use, broadcast volume should be set below the point where the red indicator (0 dB) begins to light.



[Rear]

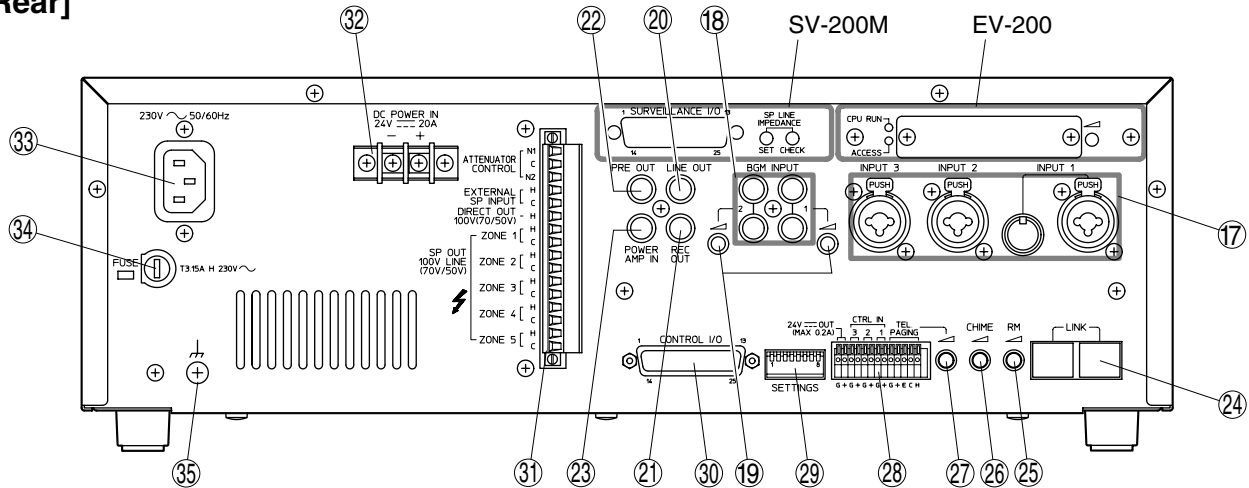

The figure above shows the 230 V AC versions of the VM-2120 and VM-2240. The 120 V AC versions are the same in both appearance and function except the rating indications of the AC inlet (No. 33) and fuse holder (No. 34).

**17. Audio input terminal [INPUT 1, 2, 3]**

The input level can be switched between MIC (-60 dB\*<sup>1</sup>, 600 Ω) and LINE (-10 dB\*<sup>1</sup>, 600 Ω) using the rear panel-mounted function switch [SETTINGS] (No. 29). Each terminal is electronically balanced\*<sup>2</sup>, and has a combined XLR (female) connector and phone jack. In addition, Input 1 features a DIN connector for connection of an optional Paging Microphone VR-1001B or PM-660D.

signal after the master volume control. Connect this jack to other power amplifier.

**23. Power amplifier input jack [POWER AMP IN]**

An RCA pin jack with 0 dB\*<sup>1</sup>, 10 kΩ. Connect a preamplifier or other external equipment. By inserting a pin plug into this jack, the sound source can be switched over to the external equipment.

**24. Link connector [LINK]**

An RJ45 female connector. Links another VM (VM-2120/-2240) amplifier\*<sup>3</sup> or optional RM-200M Remote Microphone units (up to 4 units per system). Features electronically balanced\*<sup>2</sup> input to accept audio signals from the RM-200M. When 2 VM amplifiers are stack-connected, connect the master unit's "PRE OUT" (No. 22) to the sub-unit's "POWER AMP IN" (No. 23) as well as the LINK-to-LINK connection between both units.

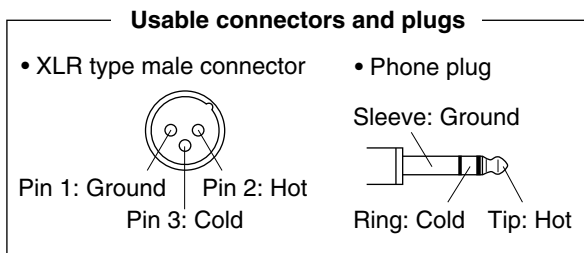

**18. BGM input jack [BGM INPUT 1, 2]**

An RCA pin jack with -20 dB\*<sup>1</sup>, 10 kΩ, monaural. Connect the background music source to this jack.

**19. BGM input volume control**

Adjusts the broadcast volume for each BGM input. The volume increases as the control is turned clockwise.

**20. Line output jack [LINE OUT]**

An RCA pin jack with 0 dB\*<sup>1</sup>, 10 kΩ. Outputs the signal before the master volume control. Connect this jack to the line input of other equipment.

**21. Recording output jack [REC OUT]**

An RCA pin jack with 0 dB\*<sup>1</sup>, 10 kΩ. This jack is connected in parallel to the line output [LINE OUT]. Connect a cassette deck, etc. when recording the broadcast contents.

**22. Preamplifier output jack [PRE OUT]**

An RCA pin jack with 0 dB\*<sup>1</sup>, 10 kΩ. Outputs the

**25. Remote microphone input volume control [RM]**

Adjusts the broadcast volume for the connected remote microphone.

**26. Chime volume control [CHIME]**

Adjusts the broadcast volume for the unit's built-in chime.

**27. Telephone paging volume control**

Adjusts the broadcast volume for the Telephone Paging Input.

**28. External connection terminal [TEL PAGING, CTRL IN 1, 2, 3, 24 V OUT]**

A push-in terminal block. This terminal block features the following connection sections.

(1) Telephone paging input [TEL PAGING]

Voice sound: Electronically-balanced input\*<sup>2</sup> with shield terminal, -10 dB\*<sup>1</sup>, 10 kΩ.

Control: No-voltage make contact input, open voltage: 30 V DC, short-circuit current: under 0.1 A

- (2) Control input for broadcast activation  
[CTRL IN 1, 2, 3]  
3 no-voltage make contact inputs, open voltage:  
3.3 V DC, short-circuit current: under 1 mA
- (3) 24 V DC Power output [24 V OUT]  
Supplies the 24 V DC/0.2 A power to an optional  
Amplifier Control Unit RU-2001/-2002.

### 29. Function switch [SETTINGS]

An 8-bit DIP switch and selects

- (1) Phantom power on-off for each input 1 – 3
- (2) Telephone paging chime on-off
- (3) 7 different types of chime tones [2-tone chime/2-tone chime (fast repeat)/4-tone chime (Up)/Single-tone chime/4-tone chime (Up & Down)/Gong, and Pre-recorded chime\*<sup>4</sup>], or chime-off
- (4) MIC/LINE gain for inputs 1 – 3  
Refer to page 48 "FUNCTION SWITCH OPERATION" for operation of the function switch.

### 30. Control input and output connector [CONTROL I/O]

A 25-pin, female D-sub connector.

- (1) External control input  
The following functions can be activated from external equipment.
- Message for an optional Voice Announcement Board
  - Chime
  - Power
  - Emergency Broadcast
  - Unit's broadcast cutoff
- (2) Status output  
When the unit is placed in the following status, the corresponding output is at make.
- Irregularity of communications with the Remote Microphone and an expansion amplifier.
  - AC power ON
  - DC power ON
  - Irregularity of the sound source of the Voice Announcement Board.
  - Failure (FAULT) indication on
  - Power switch on

### 31. Attenuator control, external speaker input, speaker output connector [ATTENUATOR CONTROL, EXTERNAL SP INPUT, DIRECT OUT, ZONE 1 – 5]

A dedicated, 16-pin plug-in screw connector and has the following input and outputs.

- (1) External attenuator control output [ATTENUATOR CONTROL]  
An output terminal for bypassing the external attenuator.

- (2) External speaker line Input [EXTERNAL SP INPUT]  
Accepts the signal from the external amplifier's speaker line. When the unit's broadcast cutoff input terminal of the Control Input and Output Connector (No. 30) is activated by an emergency equipment, the unit's power amplifier output is cut off, allowing the external signal to go through to the speakers in all zones.

- (3) Direct speaker line output [DIRECT OUT]  
Outputs the signal directly from the power amplifier transformer output.\*<sup>5</sup> The volume level is the same as that which can be provided when the Zone Volume Control (No. 10) is set to the maximum position.

- (4) Speaker output [SP OUT, ZONE 1 – 5]  
Connects to the speaker lines. This output is of 100 V line type, but can be converted to the 50 V or 70 V line type by internal connection change.

### 32. 24 V DC power input

Connect the backup battery (maximum 24 V DC/7.5 A for VM-2120, 15 A for VM-2240) to this terminal.

### 33. AC inlet [AC mains]

Connect the supplied power cord to this inlet.

### 34. Fuse holder

The following miniature fuses (20 mm type) are used.

6.3 A (for 120 V AC version)

T2.5 A of time lag type (for VM-2120 230 V AC version), T3.15 A of time lag type (for VM-2240 230 V AC version)

**Note:** When the fuse is blown off, first remove the cause, then replace with the correct type specified on the unit.

### 35. Signal earth terminal

Note this terminal is not a safety earth. When there is hum noise, connecting this terminal to the body of connected equipment (BGM sound source, expansion amplifier, etc.) may reduce it.

\*<sup>1</sup> 0 dB = 1 V

\*<sup>2</sup> Can be transformer-balanced with the addition of an optional IT-450 input transformer.

\*<sup>3</sup> Both the VM-2120 and the VM-2240 can also be combined.

\*<sup>4</sup> The chime sound source must be pre-recorded into a CF (CompactFlash) card to be inserted into the optional EV-200 Voice Announcement Board. (See p. 11.)

\*<sup>5</sup> Output signal source is switched to the EXTERNAL SP INPUT if the unit's broadcast cutoff is activated. See No. 31 (2).

## [Voice Announcement Board EV-200]

The following functions No. 36 through No. 40 are used when an optional EV-200 Board is mounted in the unit.

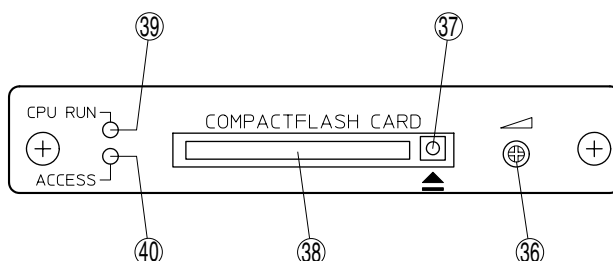

### 36. Voice Announcement board volume control

Adjusts the volume for the Voice Announcement Board.

### 37. Eject button

Press this button to eject the CompactFlash\* (CF) Card.

\* Trademark of SanDisk Corporation

### 38. CF card slot [COMPACTFLASH CARD]

Insert the CF Card, the Pre-recorded chime and message source, into this slot.

**Note:** Withdrawing the CF card during Message Broadcast will terminate the broadcast without completion.

### 39. CPU status indicator [CPU RUN]

Indicates the EV-200 Board's operation status.

Normal operation: Flashes.

Abnormal operation: Steadily on.

No operation: Extinguished.

### 40. Card access indicator [ACCESS]

Flashes when the unit is accessing the CF Card, and is steadily on when a failure occurs.

## [Surveillance Board SV-200M]

The following functions No. 41 through No. 43 are used when an optional SV-200M Board is mounted in the unit.

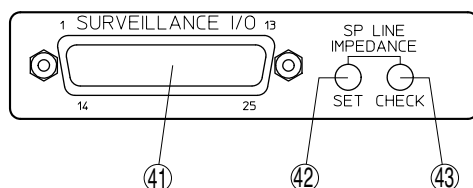

### 41. Surveillance input and output connector [SURVEILLANCE I/O]

A 25-pin, female D-sub connector.

- Features an input to activate the Surveillance (failure detection) function, and an output to indicate the result of failure detection.
- Monitors failures of operations of the unit's power amplifier section, and ground fault of the speaker line, then outputs the result of monitor lighting the Failure Indicator [FAULT] (No. 15).
- The Surveillance function for the speaker line is performed by suspending a broadcast only when the unit is activated from external equipment or the board's internal timer. In this

case, the indicators of all zones flash to indicate the broadcast is in pause. When the speaker line short is determined, the Failure Indicator [FAULT] (No. 15) lights and at the same time, the corresponding zone indicator flashes.

### 42. Speaker line impedance setting key [SET]

Measures and sets each speaker line reference impedance value. (reference value for surveillance criteria)

### 43. Line check key [CHECK]

Checks each speaker line impedance for the line failure detection.

## 6.2. Remote Microphone RM-200M

[Top]

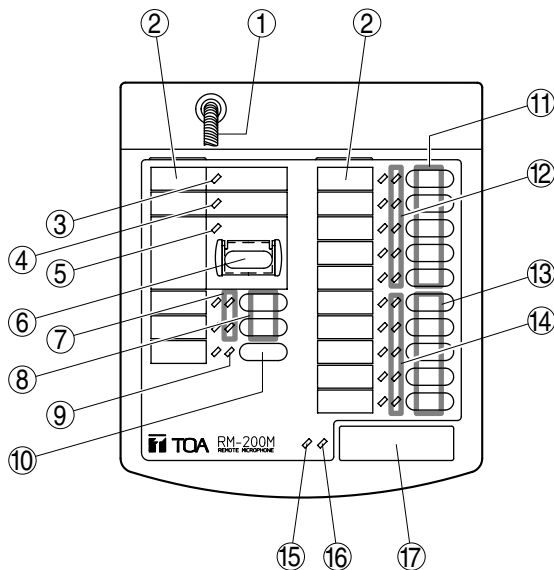

### 1. Gooseneck microphone

A unidirectional microphone.

### 2. Name label

Insert the label (not thicker than 0.2 mm) indicating the name of each panel control and indicator. (See p. 60 "NAME LABEL PREPARATION.")

### 3. Power indicator (POWER)

Lights green when the power is supplied to the unit.

### 4. Failure indicator (FAULT)

Lights yellow when the VM (VM-2120/-2240) amplifier's front panel-mounted failure indicator lights.

Flashes yellow when a communications failure occurs between the unit and the VM amplifier.

### 5. Emergency indicator (EMERGENCY)

Lights red when the VM amplifier is in Emergency mode. (See p. 21.)

### 6. Emergency broadcast switch (EMERGENCY)

Press this switch after opening the security cover when making the Emergency Broadcast.

### 7. Groups 1&2 indicator (GROUP 1, 2)

Lights green when the corresponding group is selected with the key.

### 8. Groups 1&2 broadcast key (GROUP 1, 2)

Press this key to make the Group Broadcast (Broadcast to preprogrammed multiple zones). (See p. 51 "BROADCAST GROUP/ZONE SETTING.")

### 9. All-zone indicator (ALL-ZONE)

Lights green when the All-Zone Broadcast is selected with the key.

### 10. All-zone broadcast key (ALL-ZONE)

Press this key to make the All-Zone Broadcast.

### 11. Zone selector key (ZONE 1 – 5)

Selects the desired broadcast zones (Zones 1 – 5).

### 12. Zone indicator (ZONE 1 – 5)

Lights green when the corresponding broadcast zone (Zones 1 – 5) is selected.

### 13. Message (MESSAGE 1 – 5)/zone (ZONE 6 – 10) selector key

(1) When only a single VM-2120 or VM-2240 amplifier is connected

Selects broadcast messages 1 – 5 pre-recorded on the optional Voice Announcement Board EV-200.

(2) When two VM-2120 or VM-2240 amplifiers are connected

Selects broadcast zones 6 – 10.

### 14. Message (MESSAGE 1 – 5)/zone (ZONE 6 – 10) indicator

Lights green when the corresponding Message (Zone) Selector Key is pressed.

### 15. Busy indicator (BUSY)

Flashes orange or green when other connected sound source unit is in use.

Orange: The RM-200M cannot operate.

Green: The RM-200M can interrupt the busy unit.

### 16. In-use indicator (IN-USE)

Lights green when the RM-200M is in use.

### 17. Talk key (TALK)

Either of the following two operating methods can be selected. (See p.50 "Remote Microphone's Function Switches.")

(1) Press-to-talk system

Announcements can be made from the microphone while the key is pressed, and are terminated when released.

(2) Talk lock system

One-touch depression locks the key and permits announcements to be made from the microphone. Press the key again to terminate the announcement.

### Note

In the Emergency Broadcast, the Talk key operates in the "press-to-talk" system even if set to the "Talk lock system."

## [Rear]

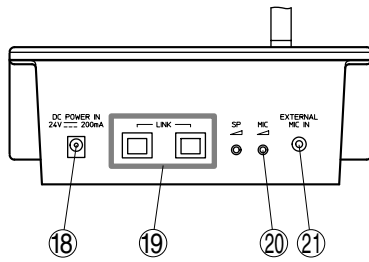

### 18. DC power input jack [DC POWER IN]

- A jack with non-polarity. Connect the 24-V DC power (AC adapter). (See the specifications on p. 69.)
- The VM amplifier can supply the power to only a single Remote Microphone.  
(Line resistance: within 24 Ω/one way)

### 19. Link connector [LINK]

A female RJ45 connector. Connects the VM amplifier or other RM-200M units (up to 4 units connectable per system) using the cable of Category 5 STP straight type.

### 20. Microphone volume control [MIC]

Adjusts the volume of the unit's gooseneck microphone or the external microphone input (No. 21).

## [Right Side]

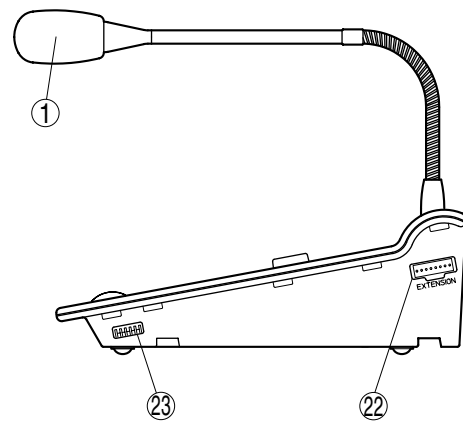

### 21. External microphone input jack [EXTERNAL MIC IN]

A 3.5 mm-diameter Mini-jack. Connects a electronic condenser microphone (ex. headset). Inserting a Mini-plug switches the microphone sound source to that which is connected to this jack.

### 22. Extension connector [EXTENSION]

Connects the RM-210 Remote Microphone Extension using the cable supplied to the RM-210.

### 23. Function setting switch

Used for setting the Remote Microphone's Unit numbers (1 – 4) and functions as shown in the "Function Setting table" below.

## 6.3. Remote Microphone Extension RM-210

The RM-210 is used to select the optional EV-200 Voice Announcement Board's voice message when connecting 2 VM-2120 or VM-2240 amplifiers.

## [Top]

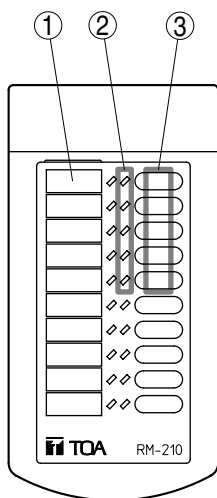

## [Left Side]

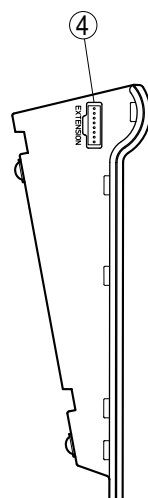

### 1. Name label

Insert the label (not thicker than 0.2 mm) indicating the name of each panel control and indicator. (See p. 60 "NAME LABEL PREPARATION.")

### 2. Message indicator

Lights green when the corresponding Message Selector Key (1 – 5) is pressed.

### 3. Message selector key

Selects the broadcast message (1 – 5).

### 4. Extension connector [EXTENSION]

Connects to the RM-200M Remote Microphone using the supplied cable.

## 7. SYSTEM CONFIGURATION

### 7.1. Remote Microphone/VM Amplifier Configuration (The Number of Connected Units)

Set the total number (0 – 5) of equipment (up to 1 sub-VM amplifier and up to 4 RM-200M Remote Microphones) connected to the master VM amplifier using the master VM amplifier's internal DIP switches SW3-No. 6, No. 7 and No. 8 "No. of connected units." Note that these switches in the sub-VM amplifier are not used.

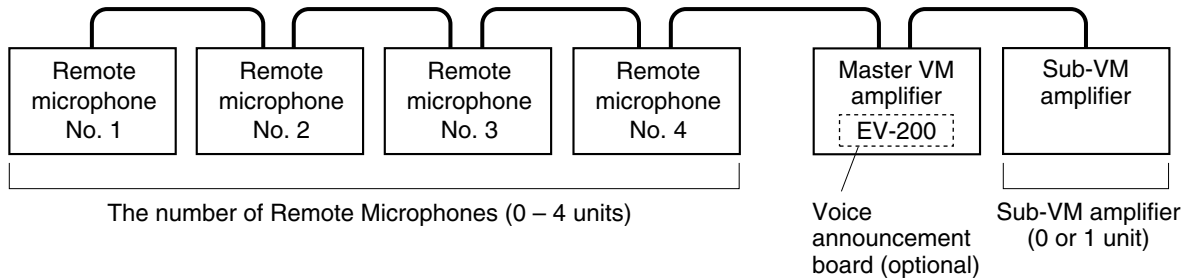

Set the Remote Microphone's Unit number (1 – 4) using DIP switches No. 1 and No. 2 on the microphone's right side panel. The Unit number may be set regardless of the unit's connection order. (See p. 49 "VM Amplifier's Internal Function Switches.")

### 7.2. Remote Microphone Operation Panel Function

The Zone/Message selector key function differs depending on the connected VM amplifier as described below.

(1) 5 speaker zones with 1 VM amplifier

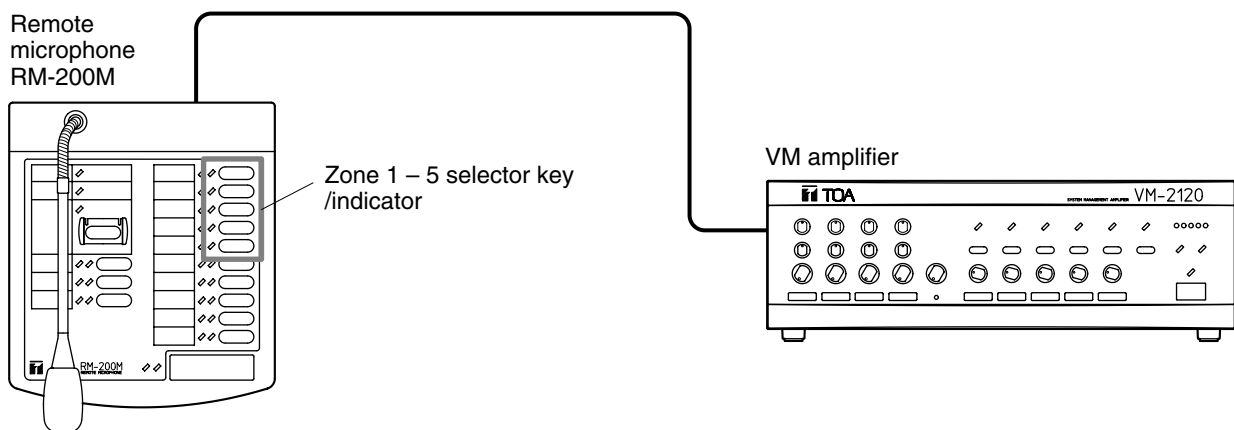

(2) 5 speaker zones with 1 VM amplifier (equipped with the EV-200 Board)

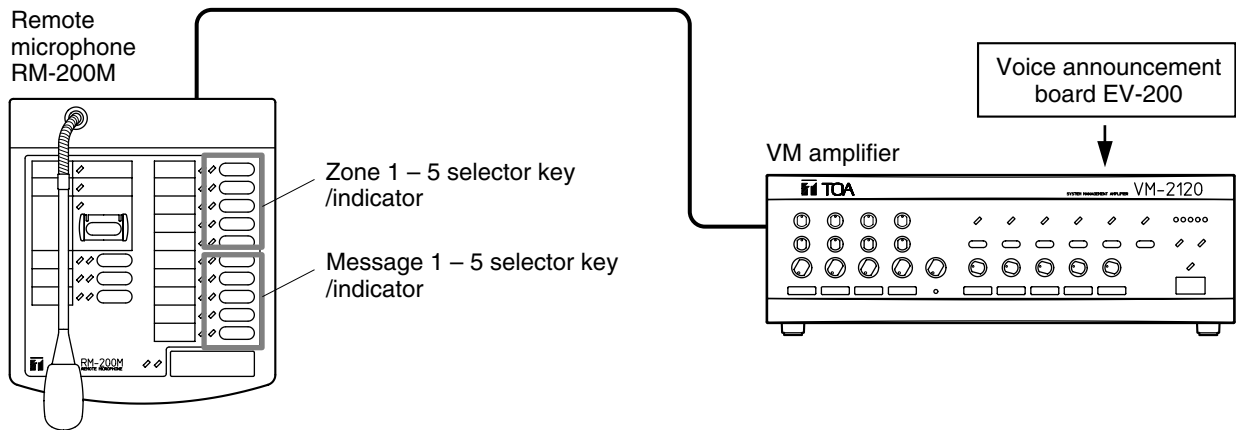

(3) 10 speaker zones with 2 VM amplifiers

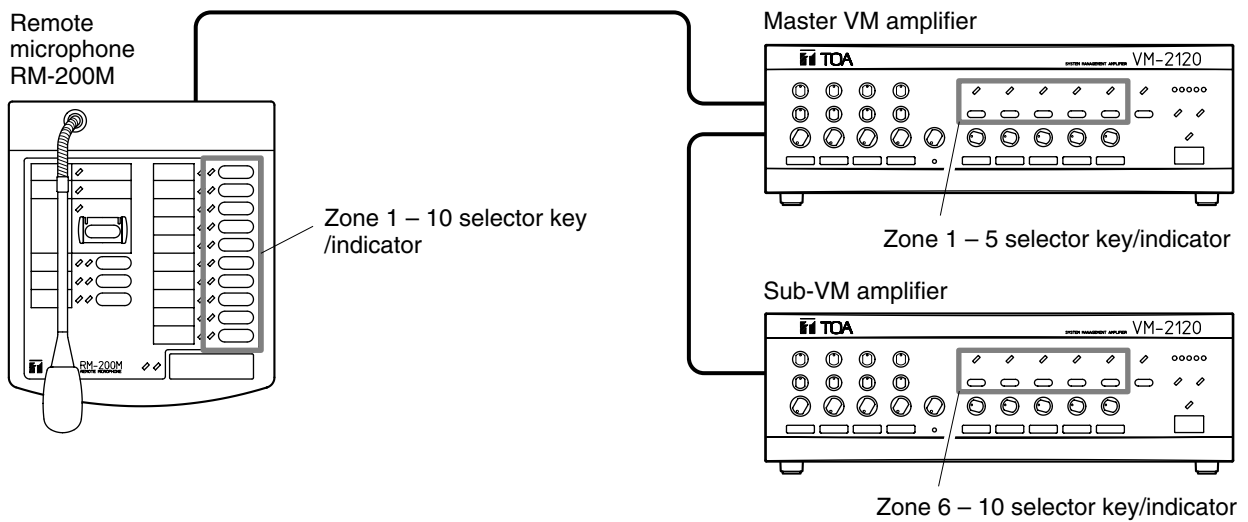

(4) 10 speaker zones with 2 VM amplifiers (equipped with the EV-200 Board)

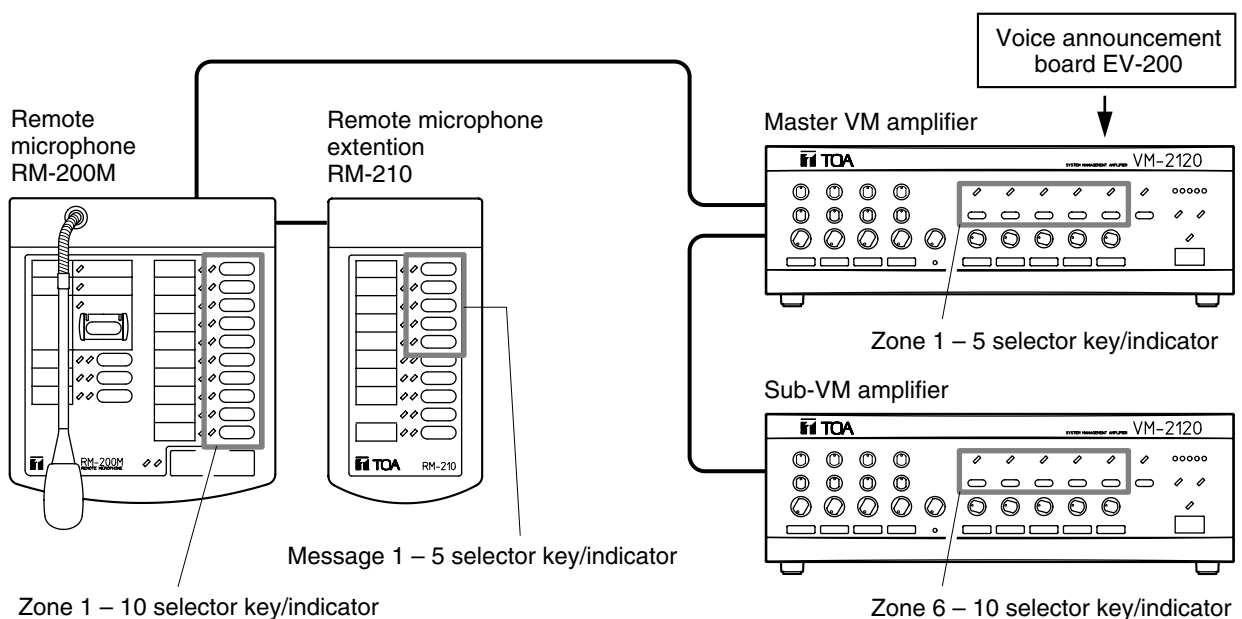

### 7.3. Connection between Remote Microphone and VM Amplifier

#### [Connection method vs. Distance]

Using the specified cable, connect between the VM amplifier(s) and Remote Microphone(s) via their LINK connectors. They can be connected in any order. (Two connection examples are shown.)

Connection example 1

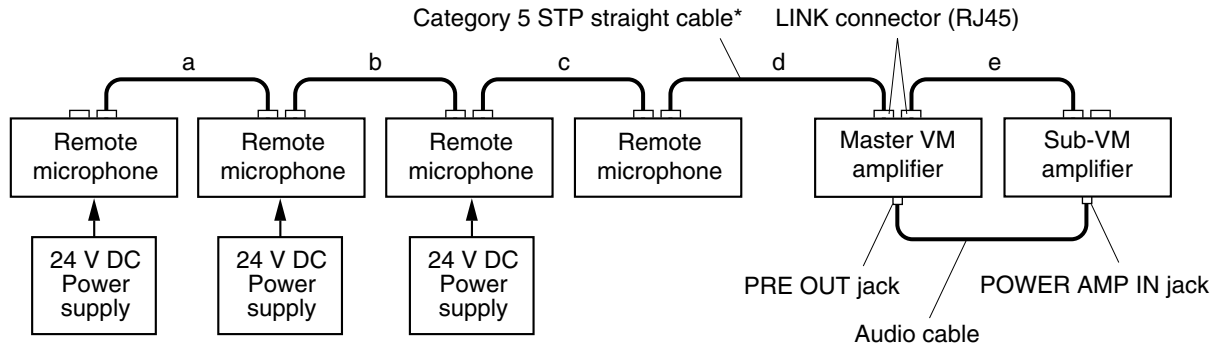

Connection example 2

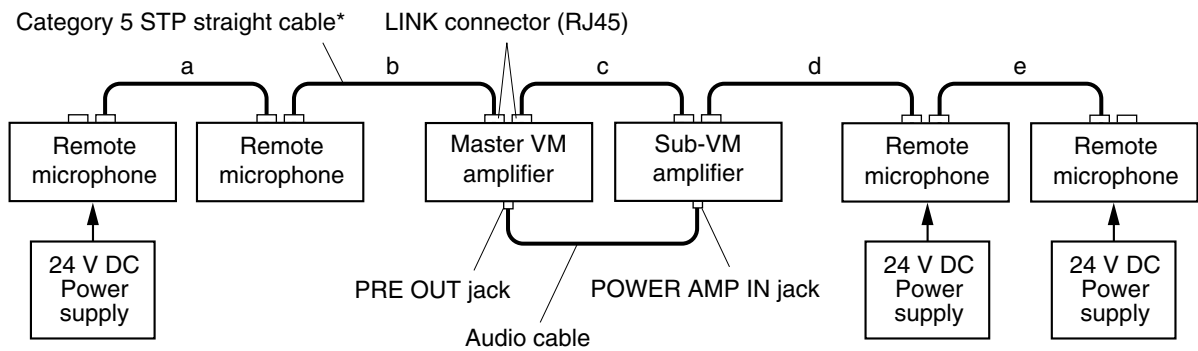

\* TIA/EIA-568A standard Category 5 Shielded Twisted-Pair cable (straight type) Abbreviated to "Cat. 5 STP cable."

The total length of LINK-to-LINK connection cables must be under 800 m (when connected using Category 5 STP cable).

$$a + b + c + d + e \leq 800 \text{ m}$$

### 7.4. Power Supply from the VM Amplifier to Remote Microphone

The VM amplifier can only supply power to one Remote Microphone. Therefore, each of the remaining Remote Microphone(s) needs to have a 24 V DC power supply (AC adapter) of its own.

(1) Power supply via Category 5 STP cable

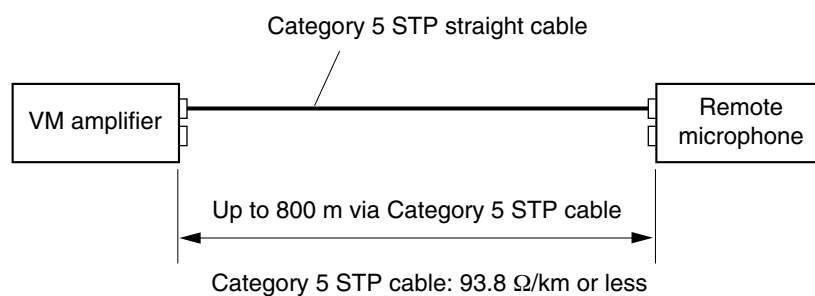



(2) Power supply using cables other than Category 5 STP cable

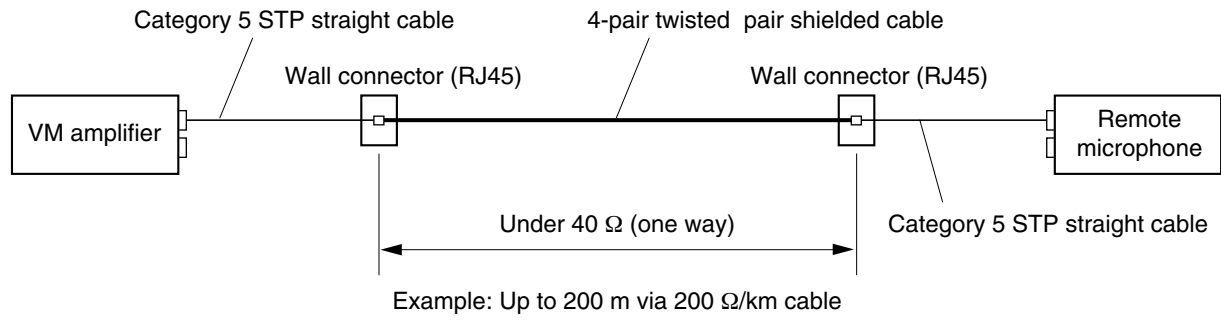

4-pair twisted pair shielded cable

Cable resistance (one way)	Extension length
200 $\Omega$ /km	Up to 200 m
100 $\Omega$ /km	Up to 400 m
50 $\Omega$ /km	Up to 800 m

## 8. EMERGENCY ("ALERT" AND "EVACUATION") BROADCAST

### 8.1. Emergency Broadcast Equipment

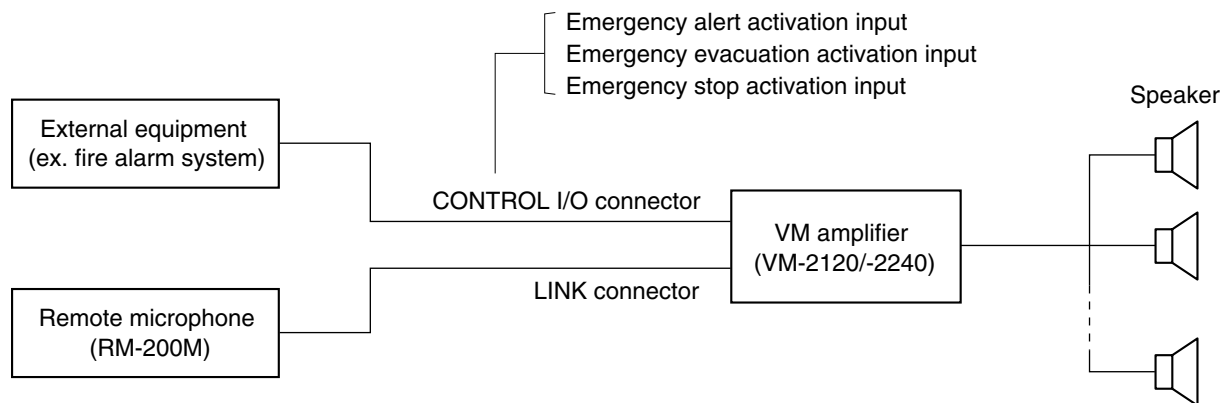

### 8.2. Keys/Indicators Used for Emergency Broadcast

#### System management amplifier VM-2120/-2240

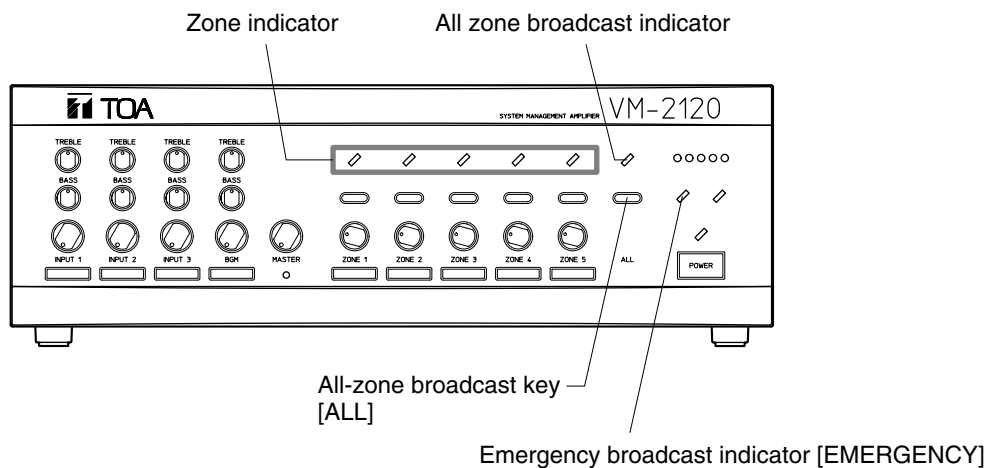

#### Remote microphone RM-200M

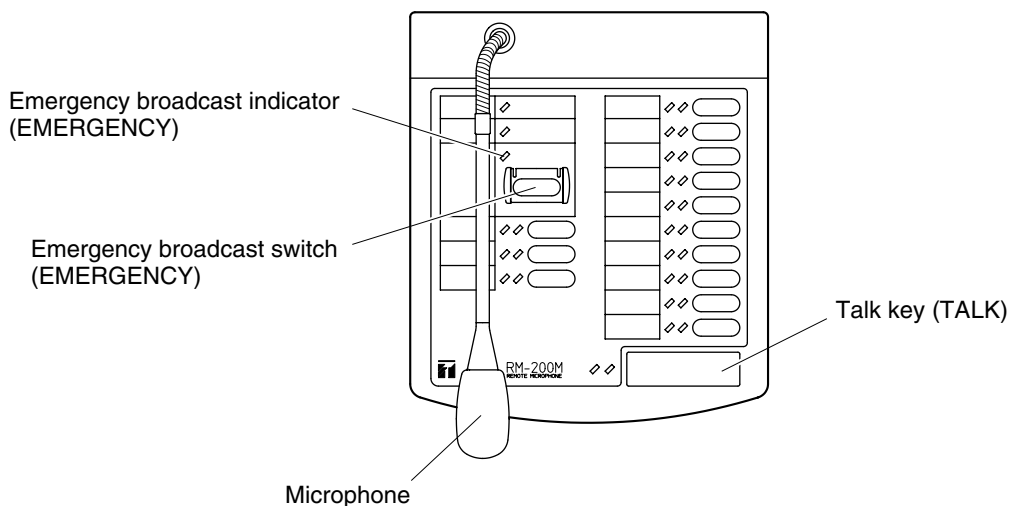

### 8.3. Emergency Broadcast Operation (Typical Example)

#### Step 1. Alert Broadcast

Open the RM-200 Remote Microphone's Emergency broadcast switch cover, and press the switch.

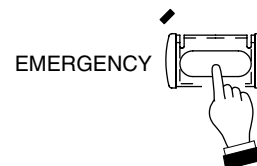

A pre-recorded Alert signal tone and Alert announcement will be alternately broadcast to the entire zone for the preset number of repetitions.\*1 The EMERGENCY indicators of the RM-200M and the VM amplifier come on.

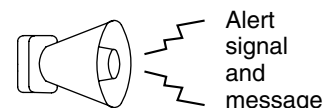

Alert (or Evacuation) broadcasts terminate all current general-purpose broadcasts.

(The Alert broadcast is also enabled when the Emergency Alert input\*2 is activated by the fire alarm system or other connected external equipment.)

#### [Alert announcement example\*3]

[Alert signal] Attention please. The fire alarm is indicating a fire. We're now investigating the cause. Please wait for further information.

#### Step 2. Evacuation Broadcast

After the Alert broadcast has been repeated as pre-programmed, it automatically switches to the Evacuation broadcast, with an Evacuation signal tone and a pre-recorded Evacuation announcement alternately broadcast to the entire zone.\*1

(The Evacuation broadcast is also enabled when the Emergency Evacuation input\*2 is activated by the fire alarm system or other connected external equipment.)

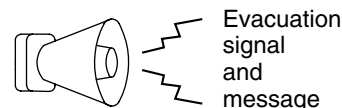

#### [Evacuation announcement example\*4]

[Evacuation signal] There is a fire. Please evacuate as quick as possible.

#### Step 3. Live Microphone Announcement

(This announcement can be made during either Step 1 or Step 2.)

- 3-1. Holding down the Remote Microphone Talk key interrupts the current Emergency broadcast (Alert or Evacuation broadcast), permitting broadcast of live microphone announcements to the entire zone.

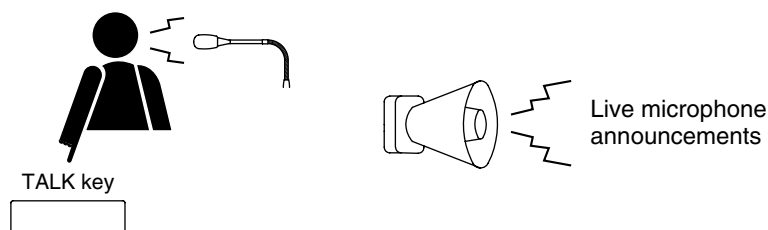

- 3-2. The microphone announcement is terminated when the Talk key is released, and operation reverts to the Evacuation broadcast regardless of whether the microphone announcement was made during an Alert or Evacuation broadcast.\*5

**Note:** In the Emergency Broadcast, the Talk key operates in the "press-to-talk" method regardless of its operation setting (by the RM-200M's function setting switch No. 4).

#### **Step 4. Emergency Broadcast Termination**

To terminate the Emergency broadcast, activate the Emergency Stop input by way of the corresponding connected external equipment. The unit returns to the general-purpose broadcast mode it was in immediately before the Emergency broadcast was started. Then, both EMERGENCY indicators of the RM-200M and the VM amplifier go out.

Note, however, that the unit does not return to the original general-purpose broadcast depending on the type of general-purpose broadcast. (See p. 21.)

#### **Notes**

- Emergency broadcasts are always made at the maximum volume level. The master and zone volume controls cannot be used during Emergency broadcast.
- Emergency broadcast cannot be terminated by the Remote Microphone.
- If emergency broadcast is stopped using the Reset key, the unit could not return to the mode it was last in before the emergency broadcast was activated.
- When the unit not equipped with the EV-200 is placed in emergency broadcast mode, announcements from the Remote Microphone can be broadcast over the entire area (by bypassing the attenuator). Press the Remote Microphone's talk switch to make the announcement.

\*1 Requires installation of the optional EV-200 Voice Announcement Board.

\*2 A terminal built in the rear-mounted CONTROL I/O connector

\*3 Requires recording of the Alert signal, broadcast message, and their number of repetitions on an installed CompactFlash (CF) card. (Consult the dealer from whom the unit was purchased.)

\*4 Requires recording of the Evacuation signal and broadcast message on an installed CompactFlash (CF) card. (Consult the dealer from whom the unit was purchased.)

\*5 The unit is placed in this operation mode when the internal function switch (SW3-3) is set to the factory-preset position. This switch can be used to switch the microphone to "silent" mode after announcement completion. (See p. 49 "VM Amplifier's Internal Function Switches.")

Note that this setting places the system in silent mode following a live microphone announcement, allowing further announcements to be made. Therefore, continuously repeat emergency announcements using the microphone to evacuate building occupants to safe locations.

## 8.4. Emergency Broadcast Sequence

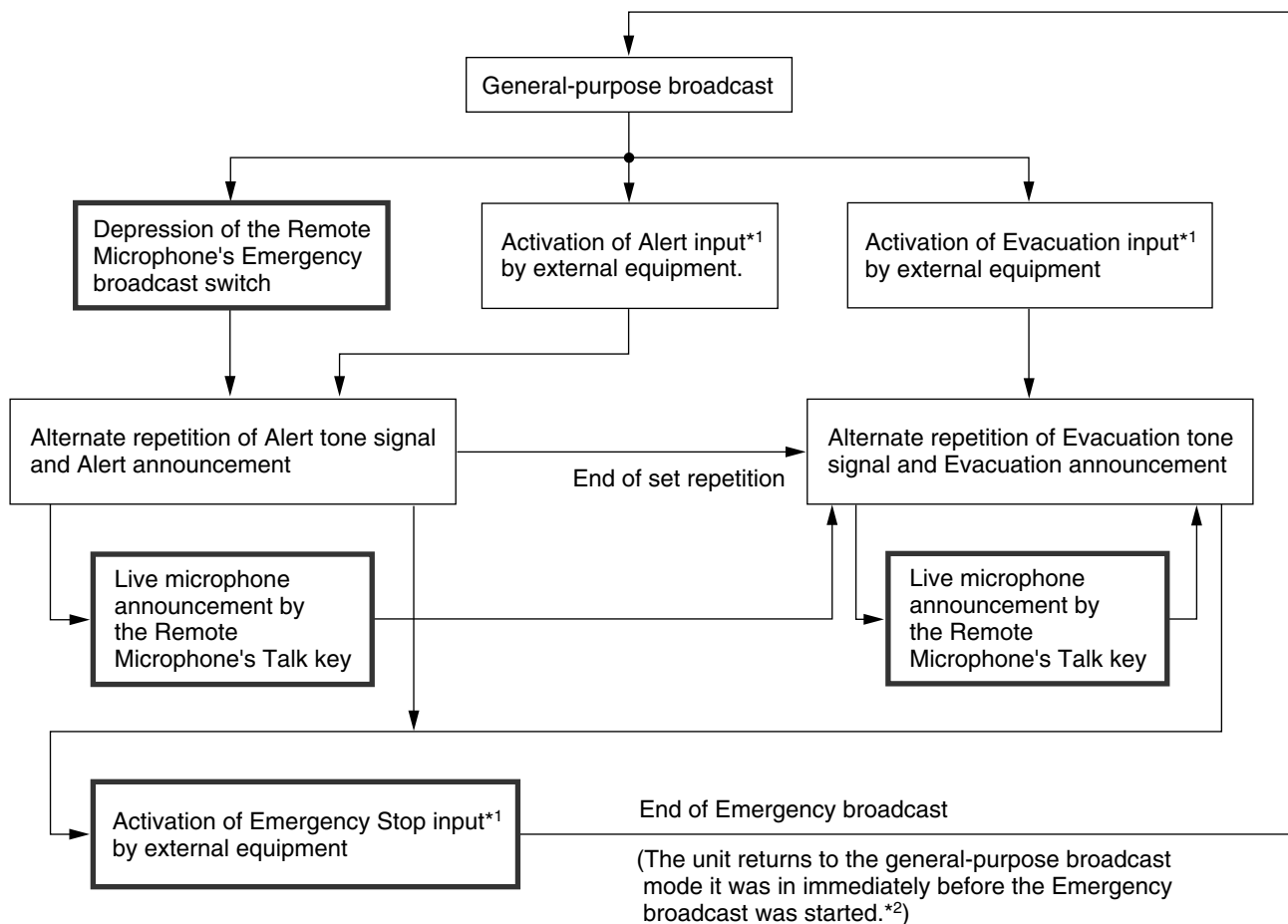

\*1 Control I/O connector terminal located on the VM amplifier's rear panel

Emergency broadcast can also be stopped by pressing the front panel-mounted Reset key. Note, however, that the zones the unit was broadcasting to just before the emergency broadcast activation may change.

\*2 General-purpose broadcast is not restored depending on its type.

### [Emergency mode]

- The emergency mode refers to the state where the VM amplifier is making emergency broadcast or where the "VM amplifier's broadcast cutoff control" signal is being transmitted from external emergency broadcast equipment to the VM amplifier (refer to p. 45 "CONTROL I/O CONNECTOR FUNCTIONS").
- When the VM amplifier is placed in the emergency mode that takes precedence over general-purpose broadcast mode, the Emergency indicators of both the amplifier and the Remote microphone will light.

### [Restoration to general-purpose broadcast]

For the general-purpose broadcasts cut off when its mode enters the emergency mode, some are restored after emergency mode completion, and some are not.

Broadcast to be restored	Broadcast not restored
Broadcast that is not activated by manual operation of or control from external equipment <ul style="list-style-type: none"> <li>• Broadcast from Inputs 1 – 3 not activated by control input (CTRL 1 – 3).</li> <li>• Broadcast from BGM Inputs 1 and 2.</li> </ul>	Broadcast that is activated by manual operation of or control from external equipment <ul style="list-style-type: none"> <li>• Broadcast from Inputs 1 – 3 activated by control input (CTRL 1 – 3).</li> <li>• Broadcast from Remote Microphone</li> <li>• Telephone paging</li> <li>• Message broadcast</li> <li>• Westminster chime</li> </ul>

## 9. BROADCAST OPERATION AT THE AMPLIFIER

### 9.1. Microphone Announcements (When Operated by Control Input)

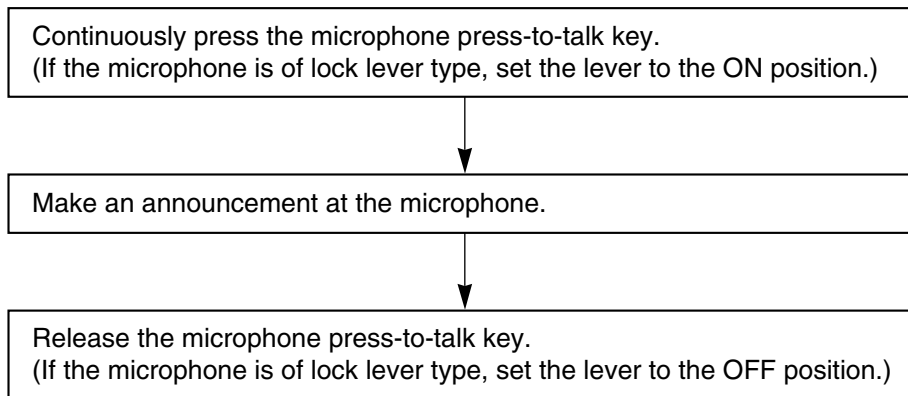

For connection of the control input (CTRL 1 – 3), refer to p. 40.

#### Notes

- TOA's Paging Microphone PM-660D (for Input 1) is equipped with the talk key.
- When using a commonly-used microphone, the press-to-talk switch needs to be made.

### 9.2. Background Music Broadcast

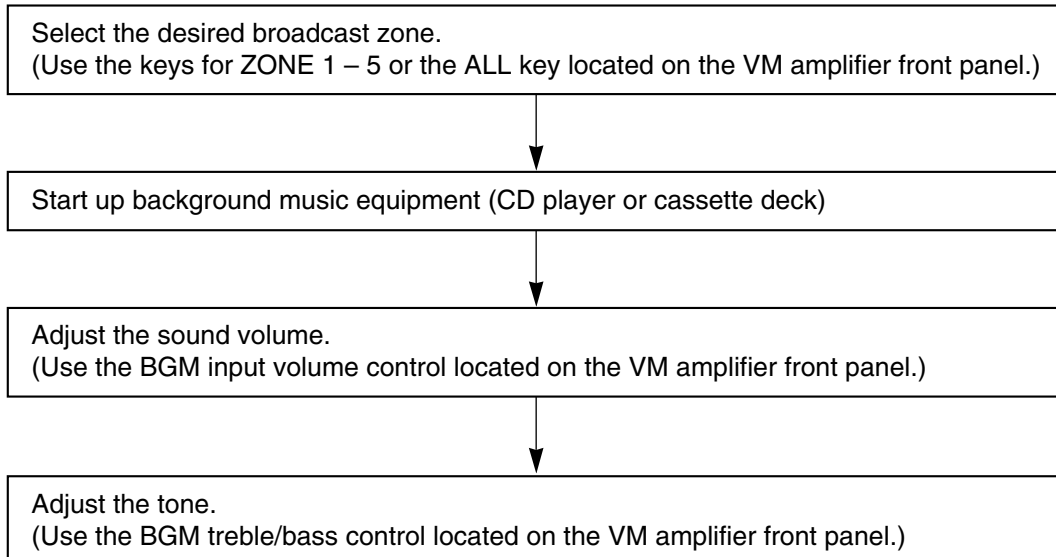

# 10. REMOTE MICROPHONE GENERAL-PURPOSE BROADCAST

## 10.1. Operation and Display Sections

The panel functions of the operation and display sections differ depending on the amplifier configuration (5 zones or 10 zones) and the use of the Recorded Message Announcement function. The figure shows an example of the operation panel function for a 5-zone single amplifier configuration with the Voice Announcement Board. (For samples of the operation panel functions for other amplifier configuration, see p. 14 "Remote Microphone Operation Panel Function.")

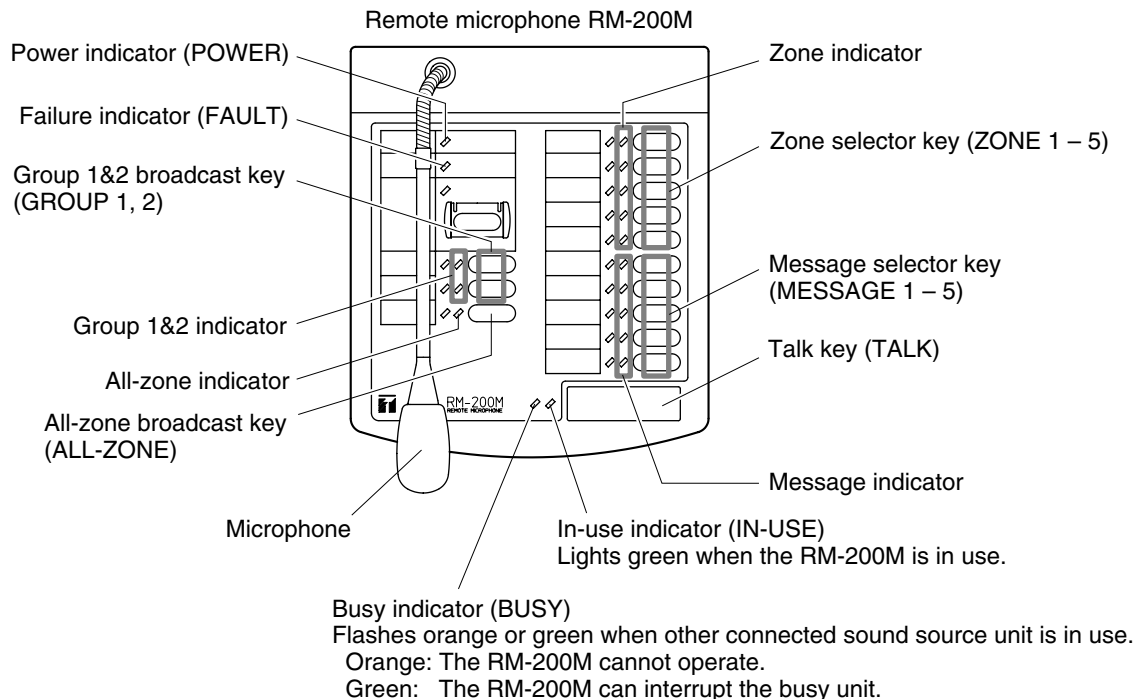

### Notes

- Both the Busy indicator and the In-use indicator indicate the ready status for live microphone announcements made after selecting the broadcast zone(s) with the All-zone, Zone, or Group selector key. Their indications have nothing to do with the Recorded message broadcast.
- For priority levels of Remote Microphone live announcements and Recorded messages, see p. 27 "GENERAL-PURPOSE BROADCAST PRIORITY."

### [Broadcast volume]

All announcements (including Recorded messages) from the Remote Microphone are broadcast at the maximum volume level regardless of the settings of the master volume control and zone volume control. Also, the amplifier performs relay control to permit the announcements to bypass external speaker attenuators.

## 10.2. Broadcast Operation

Following 4 types of broadcasts are possible: All-Zone, Individual Zone, Group, and Message Broadcasts. This section describes how to make each broadcast.

### (1) Simultaneous All-Zone Broadcast Operation

**Step 1.** Press the ALL-ZONE key.

The All-zone indicator and all zone indicators (1 – 5) will light. (Press the ALL-ZONE key again to cancel.)

➔ Go to **Step 2** on the next page.

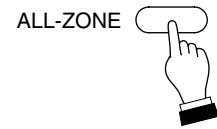

### (2) Individual Zone Broadcast Operation

**Step 1.** Select the desired broadcast zone by pressing the ZONE key.

The corresponding zone indicator will light. It is also possible to simultaneously select 2 or more zones. (To cancel the selection, press the ZONE key again.)



**Note:** When the All-zone indicator remains lit, you can not cancel individual zones by pressing their Zone keys. In this case, press the ALL-ZONE key to cancel all zones, then select individual Zones with their keys.

➔ Go to **Step 2** on the next page.

### (3) Group Broadcast Operation

Individual broadcast zones assigned to Groups 1 and 2 require to be programmed into the VM amplifier. (See p. 51 "Zone-to-Group assignment.")

Example of Group 1 broadcast

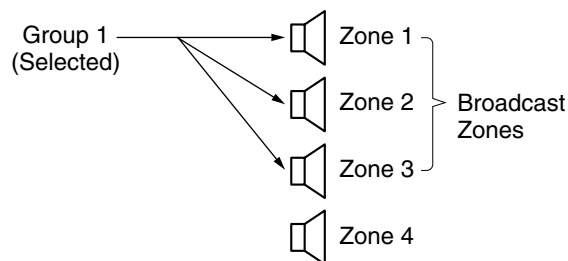

**Step 1.** Select the desired zone group by pressing the GROUP key.

Both the selected group's indicator and the indicators of the zones assigned to that group will light. It is also possible to simultaneously select 2 groups.

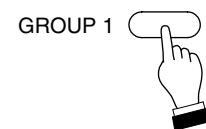

Example of 2-group broadcast

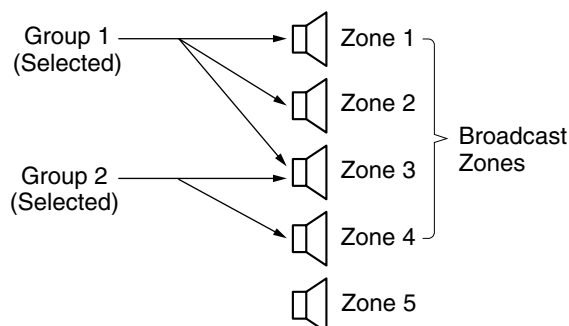

(To cancel the selection, press the GROUP key again.)

➔ Go to **Step 2** on the next page.



#### (4) Message Broadcast Operation

Messages (1 – 5) assigned to broadcast groups require to be programmed into the VM amplifier. (See p. 52 "Recorded Message-to-Group assignment.")

##### Example of Message 1 broadcast

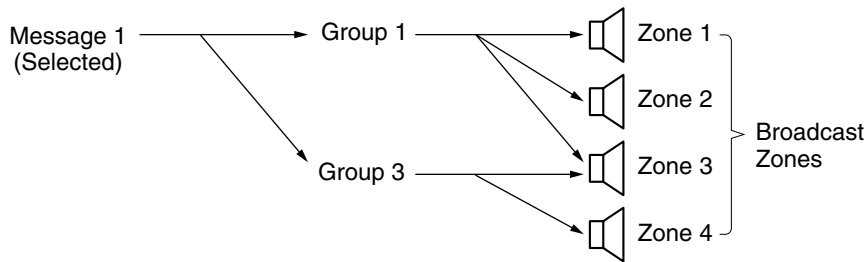

##### Step 1. Start of broadcast

Select the desired message with the MESSAGE key (MESSAGE 1 – 5). The Message indicator will light only when broadcast is possible.

**Tip:** The message broadcast can also be made by applying a control signal to the VM amplifier's rear-mounted CONTROL I/O connector. (See p. 45.)

The Recorded voice message is broadcast to its designated broadcast group.

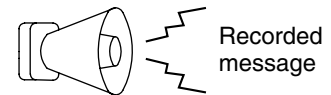
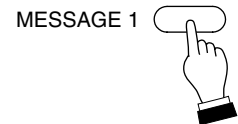

**Note:** When the Message indicator does not light, this indicates that a broadcast is being made from the sound source given higher priority.

##### Step 2. End of broadcast

- When the message broadcast is finished, the Message indicator goes out.
- Pressing the MESSAGE key again during broadcast will terminate the broadcast.

**Note:** Withdrawing the CF card during Message Broadcast will terminate the broadcast without completion.

#### Operation Common to Simultaneous All-Zone/Individual Zone/Group Broadcast

The operation below follows Step 1 on the previous page.

##### Step 2. Check the Busy indicator.

- (1) When the indicator remains off, other connected equipment are not in use for broadcast.
- (2) When the indicator flashes, other connected equipment are in use for broadcast.

##### Notes

- When the indicator flashes orange, you cannot make any broadcast.
- When the indicator flashes green, your broadcast is allowed to go through by interrupting other broadcast.

The Remote Microphone's TALK key is set for either "press-to-talk" or "lock" operation.

##### [Press-to-talk operation]

##### Step 3. Start of broadcast

###### 3-1. Hold down the TALK key.

A start chime tone will be sounded over the broadcast zone.\*  
(If the chime function is disabled, the microphone announcement can be made upon depression of the TALK key.)  
The In-use indicator will light green.

\* The unit is preset for one of 7 different types of chime tones. It is also possible to disable the chime function. (For details, see p. 30 "CHIME FUNCTION.")

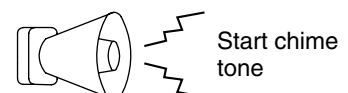
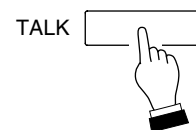

3-2. After chime play completion, make an announcement using the microphone.

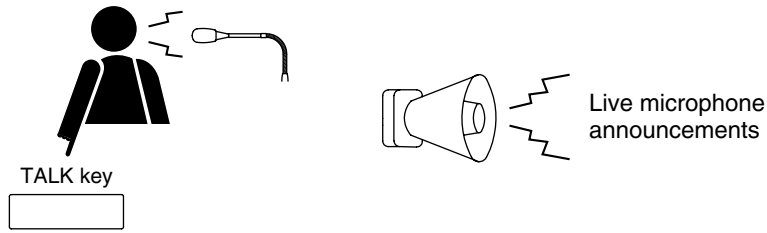

**Step 4. End of broadcast**

Releasing the Talk key will sound an end chime tone (only when the Up/Down 4-tone chime function is employed by the unit), terminating the broadcast.

Both the all zones indicators and the In-use indicator go out.

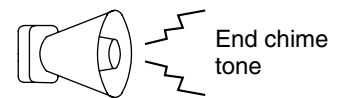
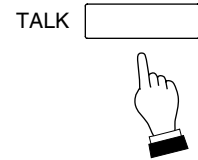

[Lock operation]

**Step 3. Start of broadcast**

3-1. One-touch press the TALK key.

A start chime tone will be sounded over the broadcast zone.\*  
(If the chime function is disabled, the microphone announcement can be made upon depression of the TALK key.)  
The In-use indicator will light green.

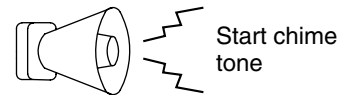
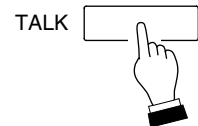

\* The unit is preset for one of 7 different types of chime tones. It is also possible to disable the chime function. (For details, see p. 30 "CHIME FUNCTION.")

3-2. After the chime play is finished, make an announcement at the microphone.

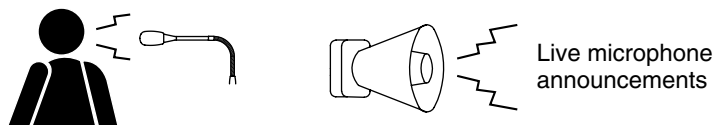

**Step 4. End of broadcast**

One-touch pressing the TALK key again will sound an end chime tone (only when the Up/Down 4-tone chime function is employed by the unit) and terminate the broadcast.

Both the all zones indicators and the In-use indicator go out.

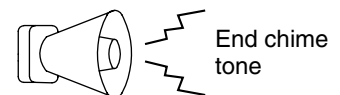
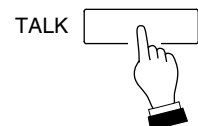

# 11. GENERAL-PURPOSE BROADCAST PRIORITY

## 11.1. Broadcast Source-to-Priority Relationship

- Making broadcast with higher priority cuts off the current lower-priority broadcast, allowing the higher priority broadcast to go through. Upon completion of the higher priority broadcast, the original broadcast is automatically restored. For background music (BGM) broadcast (Priority 4), it is also possible to mix it with other broadcasts or reduce its sound volume without cutting it off. (See p. 29 Priority Function during BGM Broadcast.)
- Broadcast sound sources to which priority levels 1 – 3 are assigned in the table below can be set to any one of such priorities with the DIP switch (exception: Priority 3 for Inputs 1 – 3).
- Underlined priority levels represent factory-preset levels.

Broadcast source	Priority level				Functional explanation	DIP switch setting	
						Switch location	Switch No.
Input 1 (MIC/LINE)* <sup>1</sup>	1	<u>2</u>	3	–	Priority 1 or 2 selectable. Priority 3 is set when broadcast is not externally activated.* <sup>2</sup>	Inside the VM amplifier	SW2-No. 1
Input 2 (MIC/LINE)* <sup>1</sup>	1	<u>2</u>	3	–			SW2-No. 2
Input 3 (MIC/LINE)* <sup>1</sup>	1	<u>2</u>	3	–			SW2-No. 3
Telephone paging	1	<u>2</u>	–	–			SW2-No. 4
Westminster chime	1	–	–	–	Set for Priority 1.	—	—
Remote Microphone No.1	1	<u>2</u>	–	–	Priority 1 or 2 selectable.	RM-200M's right side panel	No. 3
Remote Microphone No.2	1	<u>2</u>	–	–			
Remote Microphone No.3	1	<u>2</u>	–	–			
Remote Microphone No.4	1	<u>2</u>	–	–			
Message 1	1	–	–	–	Set for Priority 1.	—	—
Message 2	1	–	–	–			
Message 3	<u>1</u>	–	3	–	Priority 1 or 3 selectable.	Inside the VM amplifier	SW2-No. 5
Message 4	<u>1</u>	–	3	–			SW2-No. 6
Message 5	<u>1</u>	–	3	–			SW2-No. 7
Message 6	Highest priority (Emergency broadcast)				For Alert message	—	—
Message 7					For Evacuation message		
7 different chimes	–	–	3	–	Priority 3 is set when chime is externally activated.* <sup>3</sup>	—	—
BGM 1	–	–	–	4	Set for Priority 4.	—	—
BGM 2	–	–	–	4			

\*<sup>1</sup> Factory-preset to MIC. For the setting, see p. 48 "VM Amplifier's Rear Panel-Mounted Function Switches."

\*<sup>2</sup> Priority 1 or 2 set for the Inputs 1 – 3 applies to the broadcast activated by their respective Control inputs (CTRL IN 1 – 3), while Priority 3 applies to the broadcast activated not by the control inputs (by the VM amplifier's front-mounted zone selector key).

\*<sup>3</sup> Chime priority

- When the chime is used in Inputs 1 – 3 broadcast, Remote Microphone broadcast or telephone paging, its priority level is the same (1 or 2) as those assigned to such broadcasts.
- Chime priority level is "3" when activated by the Chime activation input (CONTROL I/O connector pin No. 9). Note that Inputs 1 – 3 need be selected with the front panel selector keys before using the chime.

## 11.2. Broadcast Priority between Equipment with the Equal Priority Level

### 11.2.1. Priority mode between equipment with the equal priority level

The following 3 priority modes are made available, which can be set using the unit's internal SW2-No. 8 and SW3-No. 1 switches.

(1) Last-come-first-served priority (factory-preset mode)

The latest broadcast takes precedence, with the earlier broadcast interrupted.

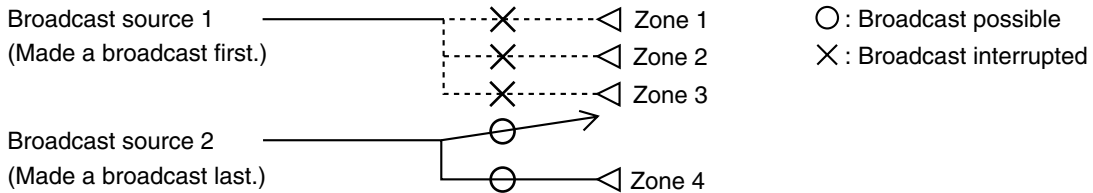

(2) First-come-first-served priority

Current broadcast is given priority, and other broadcasts cannot be made.

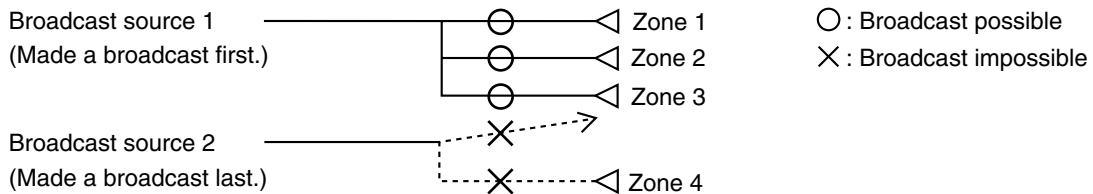

(3) Unit number priority (numerical order)

Assign the unit number to the following broadcast sound sources so they can be broadcast in numerical order.

(A) Remote Microphone (No. 1 – 4)

(B) EV-200 message (No. 1 – 5)

Figure below shows an example for the priority operation between Remote microphones No. 2 and No. 3.

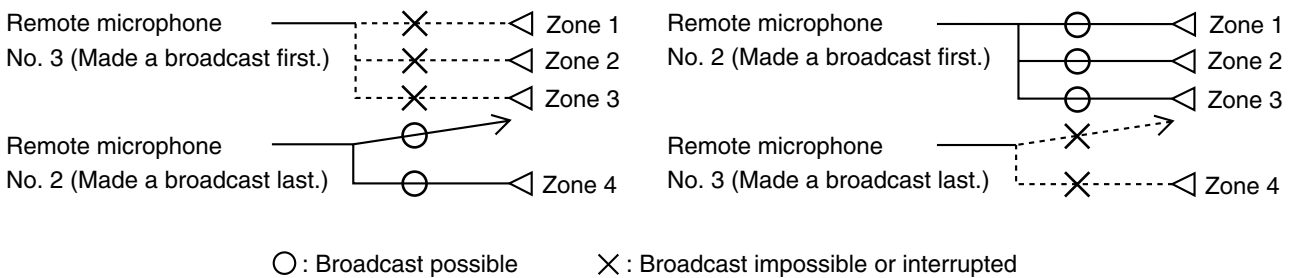

### 11.2.2. Priority function when 2 broadcasts with the equal priority level are simultaneously made

When two or more broadcasts with the equal priority level are simultaneously made, priority mode is as shown in the following table depending on the type of broadcast sound source and setting switch status.

Broadcast sound source		Competing priority level (Priority level of simultaneously made broadcasts)				
		Priority 1	Priority 2		Priority 3	Priority 4
Inputs 1 – 3		Last-come-first-served or first-come-first-served priority *1 *4 (selectable)	Last-come-first-served or first-come-first-served priority *1 *4 (selectable)	Priority 2 mixing (selectable)	Mixing	—
Telephone paging				—	—	
Remote Microphones 1 – 4		Unit No. priority *4 [Numerical order] (selectable)	Last-come-first-served or first-come-first-served priority *1 *3 *4 (selectable)	Unit No. priority *4 [Numerical order] (selectable)	—	—
Message	1 – 2			—	—	
	3 – 5	—	Last-come-first-served priority	—		
BGM 1 and 2		—	—	—	Mixing	

\*1 Has nothing to do with the setting of SW2-No. 8 switch (priority mode for the equal priority unit).

\*2 Enabled when "Mixed" is selected (factory-preset to "Not mixed") using the unit's internal SW3-No. 2 switch "Priority 2 mixing."

\*3 "Last-come-first-served" priority is selected if the unit's internal SW3-No. 2 switch "Priority 2 mixing" is set for "Mixed."

\*4 Different settings cannot be selected between "priority 1" and "priority 2."

### 11.3. Priority Function during BGM Broadcast

When other broadcast is made during the BGM broadcast (Priority level 4), the BGM broadcast is as shown in the table below depending on the priority level of such other broadcast. (The BGM broadcast is restored to the former state when the other broadcast is completed.)

Priority level of broadcast overlapping with BGM broadcast	BGM broadcast operation
Priority 1	Cut off.
Priority 2	Cut off*1 or volume is decreased*2 *3.
Priority 3	Volume is decreased*3.
Priority 4 (BGM)	Mixed.

\*1 Cut off when broadcast is made by Inputs 1 – 3 set for "Line level" inputs.

\*2 Decreased when broadcast is made by Remote Microphone, telephone paging, or Inputs 1 – 3 set for "Microphone level" inputs.

\*3 The attenuation level can be selected from the following using the unit's internal SW4-No.1 and 2 switches.

- (1) No attenuation (Mixed)
- (2) -28 dB, (audible)
- (3) -∞ dB (inaudible) (factory-preset level)

## 12. CHIME FUNCTION

### 12.1. Available Chime Tone Types

There are 7 different chimes (one of which can be selected for a pre-announcement chime), and a Westminster chime for a time signal.

#### 12.1.1. Seven different chime tones

- Six built-in chimes, and 1 pre-recorded chime that is made by recording any preferred sound source are made available for selection. It is possible to disable the chime function.
- The type of chime can be selected with the unit's rear panel-mounted SETTINGS switches No. 3 – 5. It is factory-preset to "2-tone chime". (See p. 48 "FUNCTION SWITCH OPERATION.")

**Note:** Different chime tones cannot be selected for different sound sources.

#### 12.1.2. Six built-in chimes

This lineup consists of the following types.

- 2-tone chime
- 2-tone chime (fast repeat)
- 4-tone chime (Up)\*<sup>1</sup>
- Single-tone chime
- 4-tone chime (Up & Down)\*<sup>2</sup>
- Gong

\*<sup>1</sup> An ascending 4-tone chime is sounded when the broadcast begins.

\*<sup>2</sup> An ascending 4-tone chime is sounded when the broadcast begins, and descending 4-tone chime is sounded upon broadcast completion.

#### 12.1.3. Pre-recorded chime

The optional EV-200 Voice Announcement Board is required to use this function.

A chime tone must be recorded on the Compact Flash (CF) card installed in the EV-200.

The recorded chime tone is assigned to the EV-200's Message 8. (See p. 63 "COMPACTFLASH (CF) CARD RECORDING.")

## 12.2. How the Chime Tone Is Used

### 12.2.1. Chime tone for Inputs 1 – 3

- Either MIC (factory-preset) or LINE input signal level can be set for each input.  
Setting switch: SETTINGS switches No. 6 – 8 on the unit's rear panel.
- When the input is set for MIC level and the input source with Priority 1 or 2 is broadcast by remote control (CTRL IN 1, 2, 3\*), a chime tone is automatically sounded when the broadcast is started (and completed).
- When input 1 or 2 is set for LINE level, a chime tone is not sounded when the corresponding source is broadcast.
- When Input 3 is set for LINE level and the input source with Priority 1 or 2 is broadcast by remote control (CTRL IN 3\*), a chime tone can be made to sound or not to sound when the broadcast is started (and completed).  
Setting switch: The unit's internal SW3-No. 4 switch "Input 3 (LINE) Chime ON/OFF"  
(Factory-preset position: Chime OFF)

\* The CTRL IN 1, 2, or 3 control input corresponds to the Input 1, 2, or 3, respectively.

### 12.2.2. Telephone paging chime tone

It is possible to select whether or not to sound a chime tone when the broadcast is started (and completed).

Setting switch: SETTINGS switch No. 2 "Telephone Paging Chime ON/OFF" on the unit's rear panel.  
(Factory-preset position: Chime OFF)

### 12.2.3. Independent chime activation (remote control)

- A chime tone can be sounded when the broadcast of the sound source (Priority 3) connected to Inputs 1 – 3 not activated by remote control (CTRL IN 1,2,3) is started (and completed).
- Have a chime tone remotely transmitted from the unit's rear panel-mounted CONTROL I/O connector pin No. 9 "Chime activation." (See p. 45 "CONTROL I/O CONNECTOR FUNCTIONS.") Make a chime activation switch and connect it to between the pin and GND terminal.

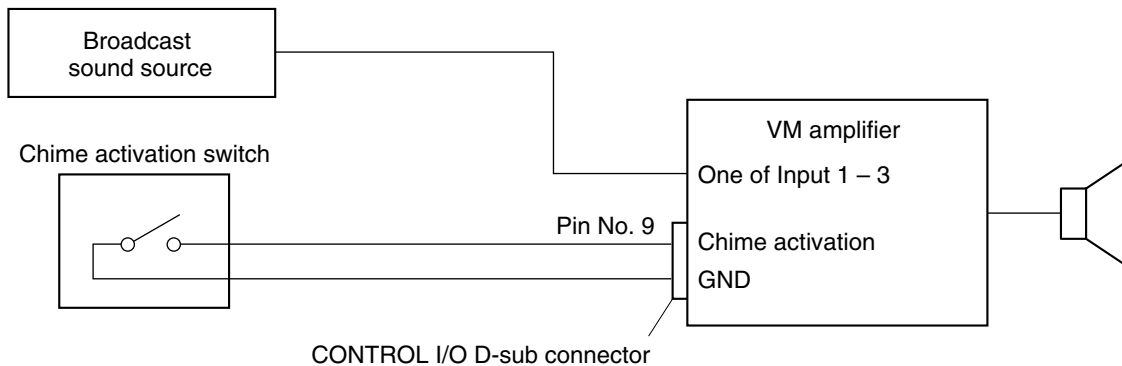

#### [Operating procedure]

**Step 1.** Using the unit's front panel-mounted zone selector key (Zone 1 – 5) or All-zone broadcast key, select the desired zone(s) to broadcast the sound source connected to Input 1, 2, or 3.

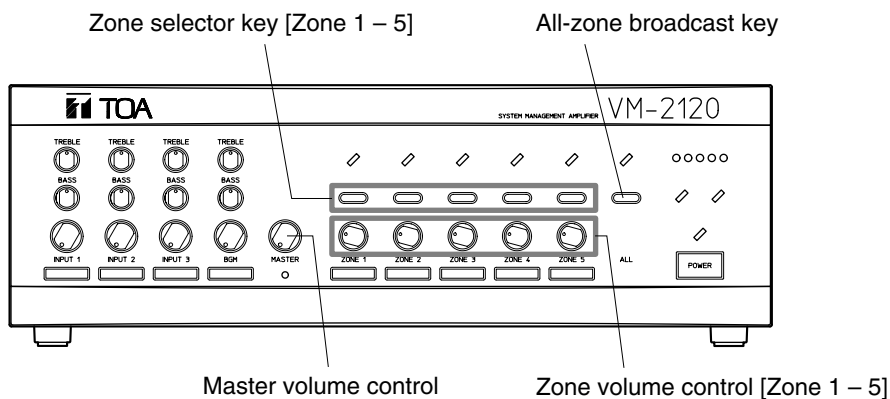

**Note:** The chime sound volume depends on the broadcast volume level adjusted with the master volume control and zone volume control.

**Step 2.** Turn on (make) the Chime switch. A pre-announcement chime tone will be sent out to the zone(s) selected in Step 1.

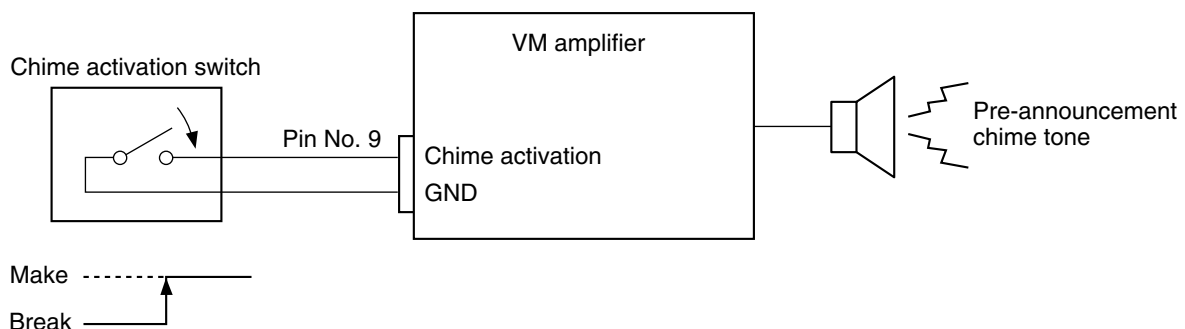

**Step 3.** Turn off (break) the Chime switch when the broadcast is completed. A post-announcement chime tone will be sent out to the zone(s). (Only when the "ascending/descending 4-tone chime" has been selected.)

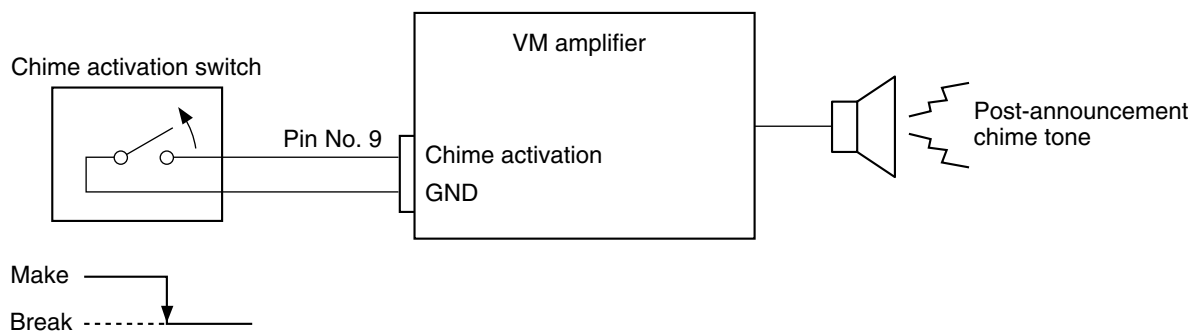

**Step 4.** Press the selected zone selector key (Zone 1 – 5) again to terminate the broadcast.

#### 12.2.4. Westminster chime

- It is possible to set the group of zones over which Westminster chime is sounded. (See p. 51 "Control input/Telephone paging/Westminster chime-to-Group assignment.")
- A chime tone is remotely sent out to the set zone group by activating the unit's rear panel-mounted CONTROL I/O connector pin No. 11 "Westminster chime activation." (See p. 45 "CONTROL I/O CONNECTOR FUNCTIONS.")



## 13. CHOKE COIL INSTALLATION

**Caution:** Leave the following work to a qualified service technician.  
Be sure to switch off the power before the work.

If a checkbox for the indication of "The choke coil is installed." on the rear panel of the VM amplifier is marked with "X", this represents that the choke coil has been installed. Therefore, the following tasks are not necessary. When you installed the choke coil, mark the checkbox with "X".

To suppress harmonic component radiation from the power line of the unit, install the optional Chock Coil CT-200M.

**Note:** In the countries where use of the CE Marking conformity is obligated, the Choke Coil must be installed.

**Step 1.** Remove 4 screws on the amplifier rear panel and a total of 6 screws on the sides to remove the cover.

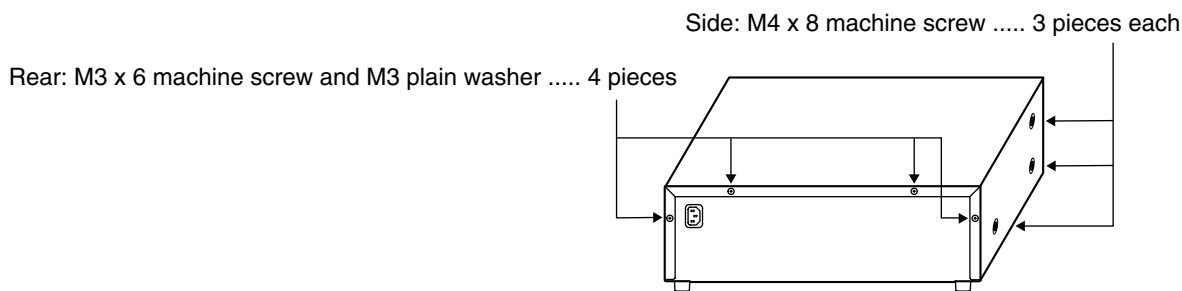

**Step 2.** Install the Chock Coil near the AC inlet inside the unit.  
Fix the Choke Coil with its accessory screws from the unit bottom side.

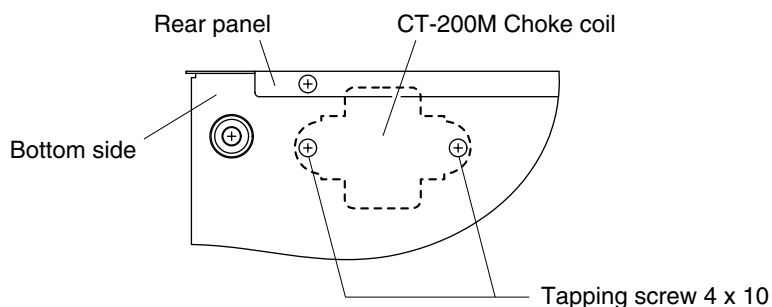

**Step 3.** Remove the jumper connector from the power input board connector (CN1202).

**Step 4.** Plug the Choke Coil connector into the power input board connector (CN1202).

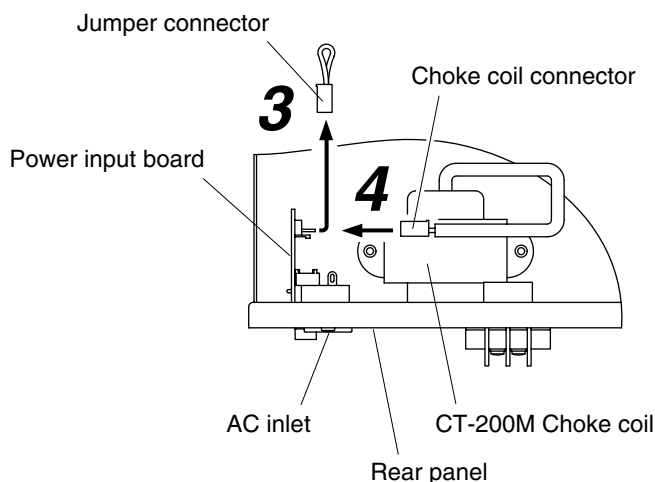

**Step 5.** Using the 4 rear panel screws and 6 side panel screws removed in Step 1, replace the amplifier cover.

## 14. INPUT TRANSFORMER INSTALLATION AND ITS BOARD MODIFICATION

**Caution:** Leave the following work to a qualified service technician.  
Be sure to switch off the power before the work.

### 14.1. Transformer Installation

You can convert the audio input section in Input 1 – 3 terminals, Remote Microphone (RM) terminal, and Telephone Paging (TEL) terminal on the unit from electronically-balanced input to transformer-balanced type. Solder the optional IT-450 input transformer to the required input section.

**Step 1.** Remove 4 screws on the amplifier rear panel and a total of 6 screws on the sides to remove the cover.

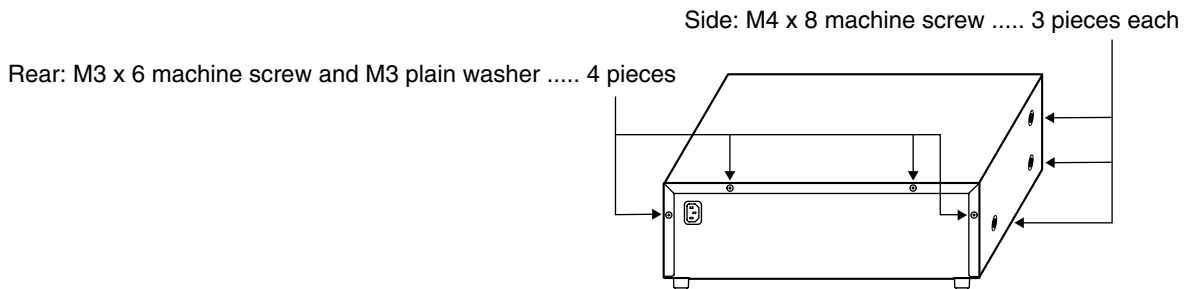

**Step 2.** Removing the input transformer board

#### [Inputs 1 – 3]

Remove the Inputs 1 – 3 input transformer board, which is installed on the rear upper circuit board in the unit.

#### [Remote Microphone (RM) or Telephone Paging (TEL)]

Remove the RM/TEL input transformer board, which is installed on the rear lower circuit board in the unit.

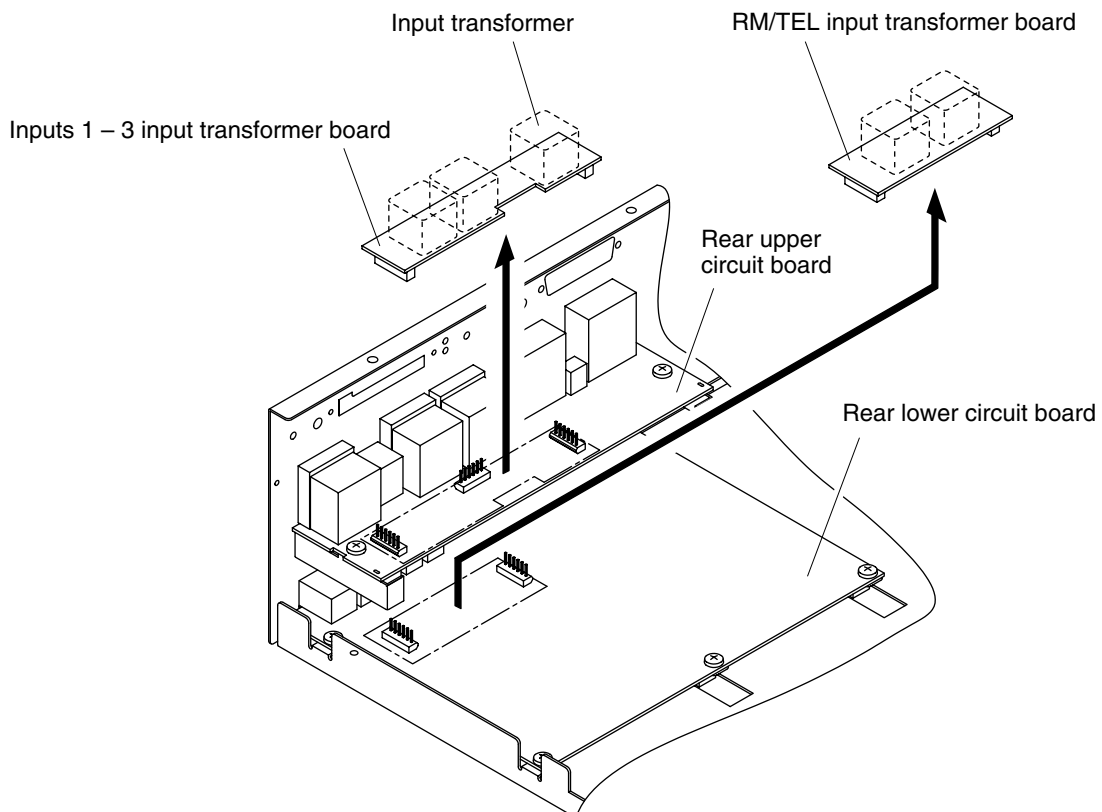

**Step 3.** Solder the input transformer to the removed input transformer board (5 places).

**Note:** Be sure not to mistake the solder side for the mounting side.

**Step 4.** Cut off jumper wires (2 places marked with X for each input).

**Note:** The jumpers are on the back of the circuit board in the figure below.

[Inputs 1 – 3 input transformer board]

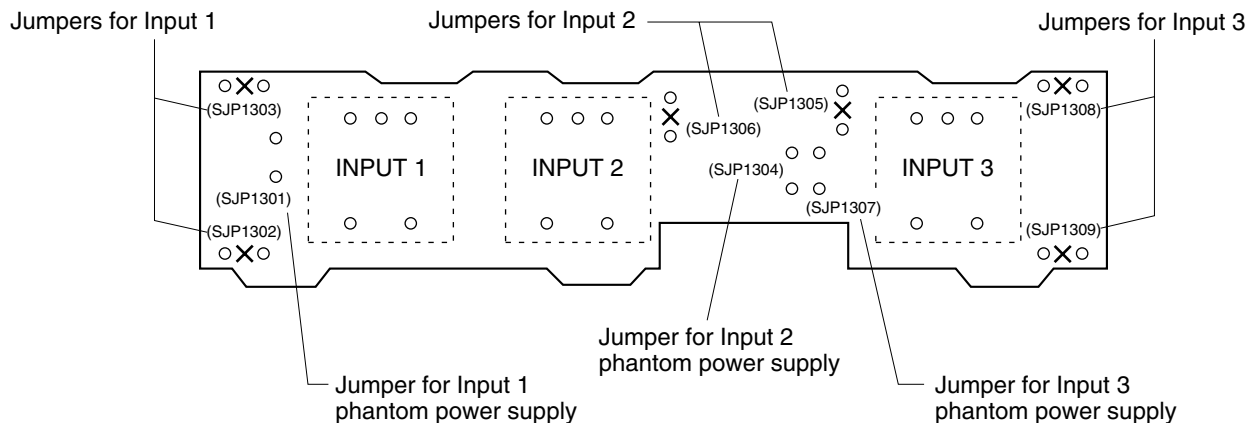

[RM/TEL input transformer board]

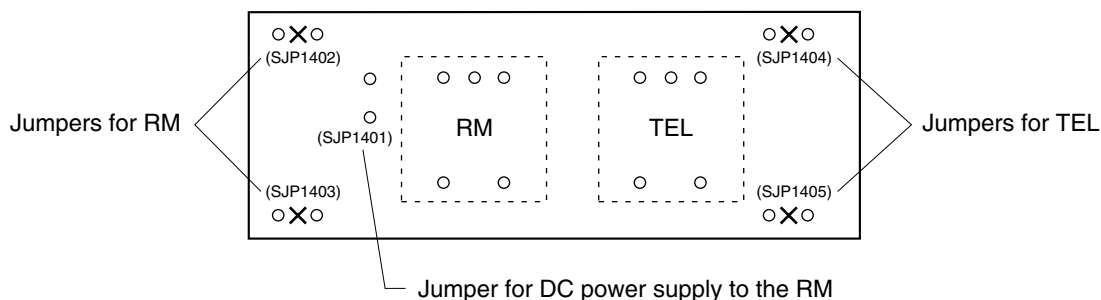

**Step 5.** Replace the input transformer board on the circuit board.

**Step 6.** Using the 4 rear panel screws and 6 side panel screws removed in Step 1, replace the amplifier cover.

## 14.2. Switching Off the Phantom Power Supply

By cutting the following jumper wires on the Inputs 1 – 3 Input Transformer Board, the corresponding input's phantom power can be switched off. (See the figure above.)

- Input 1: SJP1301
- Input 2: SJP1304
- Input 3: SJP1307

## 14.3. Instructions When the Sub- and Master VM Amplifiers Are Connected

- Be sure to cut the jumper wires SJP1401, SJP1402, and SJP1403 on the RM/TEL input transformer board in the sub-VM amplifier.
- To make the Remote Microphone (RM) input transformer-isolated, be sure to install the input transformer on the RM/TEL input transformer board in the master VM amplifier. In addition, cut the jumper wires SJP1402 and SJP1403 while remaining SJP1401 intact.

# 15. MOUNTING AN OPTIONAL EV-200 VOICE ANNOUNCEMENT BOARD

**Caution:** Leave the following work to a qualified service technician.  
Be sure to switch off the power before the work.

**Step 1.** Set the DIP switch on the EV-200 Board as shown in the figure.

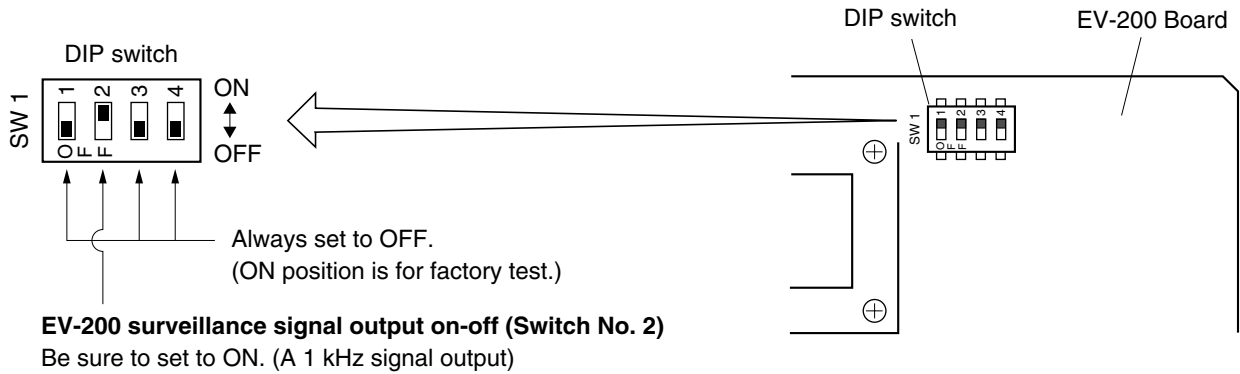

## EV-200 surveillance signal output (Switch No. 2)

The EV-200 board always transmits a 1 kHz sine wave signal to an amplifier when the EV-200 Board is not reproducing audio signals. The amplifier detects the existence of the 1 kHz signal. When the signal does not exist, the amplifier judges the board's failure and causes the FAULT indicator to light.\* (The signal indicating the EV-200's failure is transmitted from the CONTROL I/O connector.)

\* If Switch No. 2 is set to the OFF position, the FAULT indicator lights even when the board is operating correctly.

**Step 2.** Remove 4 screws on the amplifier rear panel and a total of 6 screws on the sides to remove the cover.

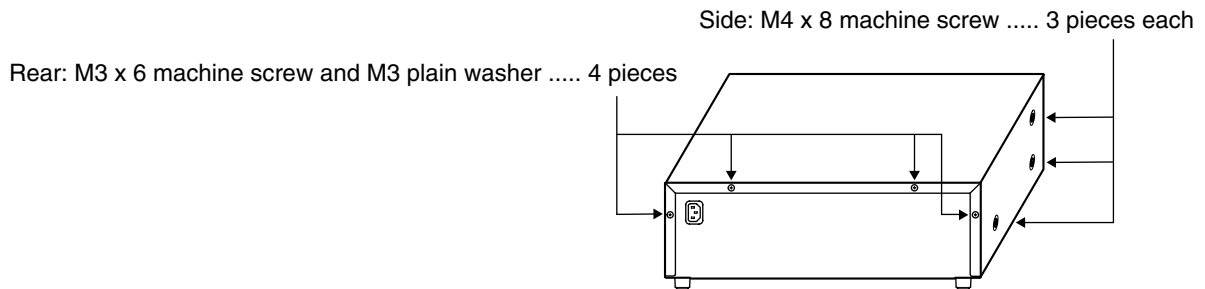

**Step 3.** Insert the EV-200 connection cable coming from the EV-200 Board into connector CN8 in the amplifier.

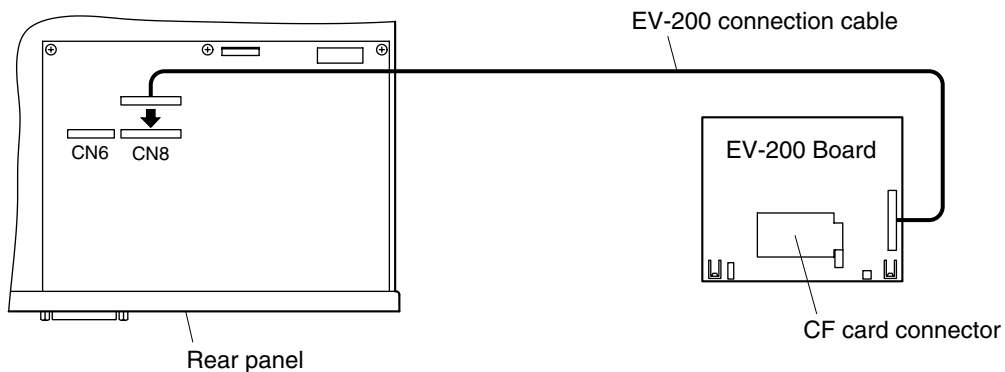

**Step 4.** Using 2 screws supplied with the EV-200, mount the EV-200 in the amplifier.

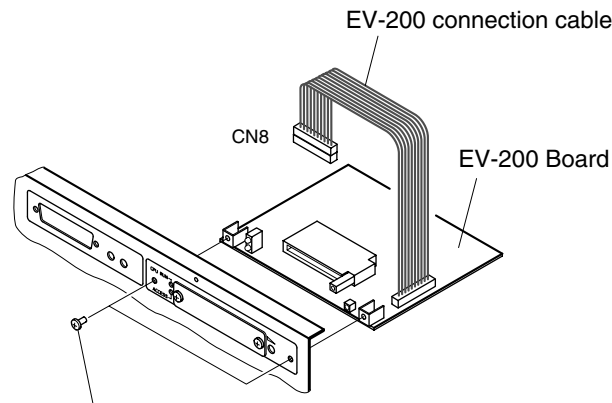

M3 x 6 machine screw ..... 2 pieces (supplied with the EV-200)

**Step 5.** Check the DIP switch on the EV-200 Board again for correct setting. (See Step 1.)

**Step 6.** Using the 4 rear panel screws and 6 side panel screws removed in Step 2, replace the amplifier cover.

#### **CF Card security cover**

Remove 2 screws to detach the security cover when inserting the CF Card into the card slot. Be sure to replace the cover after inserting the card.

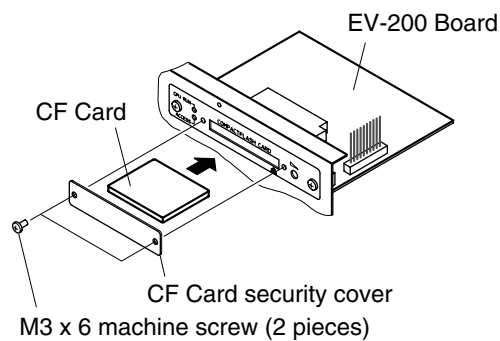

## 16. MOUNTING AN OPTIONAL SV-200M SURVEILLANCE BOARD

**Caution:** Leave the following work to a qualified service technician.  
Be sure to switch off the power before the work.

**Step 1.** Set the DIP switch on the SV-200M Board as shown in the figure.

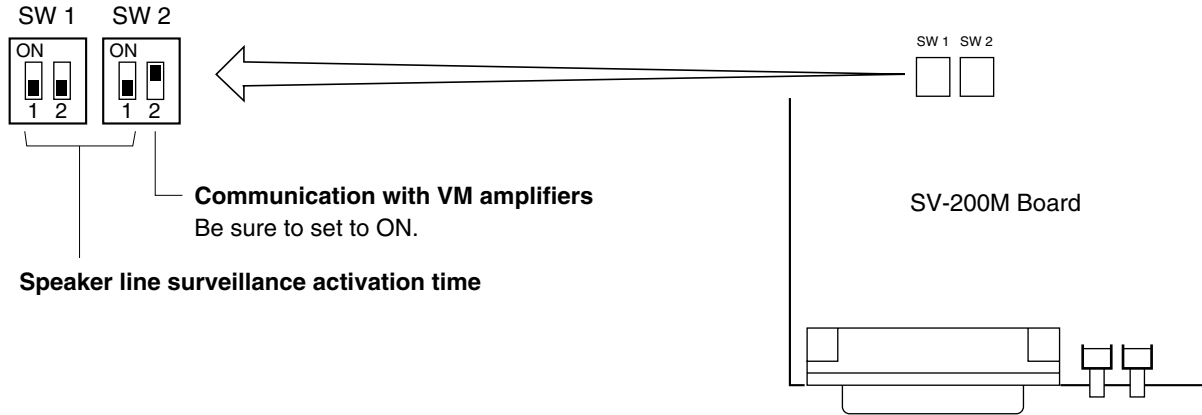

### Speaker line surveillance activation time

SW1-1	SW1-2	SW2-1	Setting contents
OFF	OFF	OFF	Automatic activation disabled
ON	OFF	OFF	10 minutes intervals
OFF	ON	OFF	20 minutes intervals
ON	ON	OFF	30 minutes intervals
OFF	OFF	ON	30 minutes intervals
ON	OFF	ON	40 minutes intervals
OFF	ON	ON	50 minutes intervals
ON	ON	ON	60 minutes intervals

This setting executes failure detection by means of the "speaker line surveillance activation" signal from the external control input (SURVEILLANCE I/O 25-pin D-sub connector).

Speaker lines are automatically monitored at set time intervals.

### Communications with VM (VM-2120 or VM-2240) amplifier

SW2-2	Setting contents
OFF	Disabled (communications impossible)
ON	Enabled (when SV-200M Board is installed in VM amplifier)

**Step 2.** Remove 4 screws on the amplifier rear panel and a total of 6 screws on the sides to remove the cover.

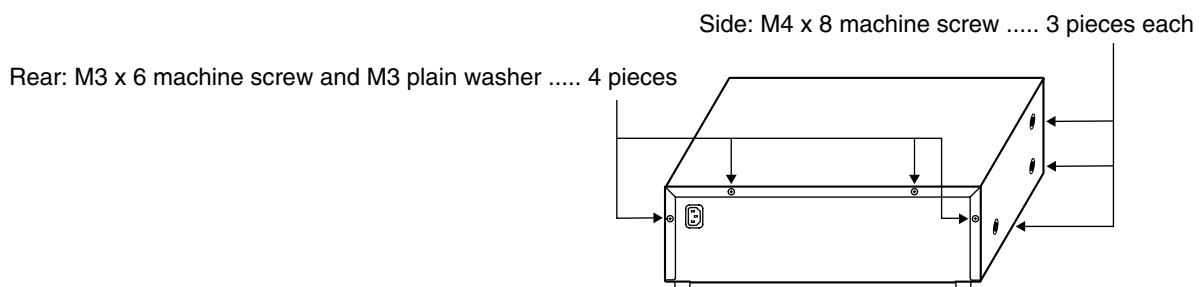

**Step 3.** Detach the surveillance I/O blank panel on the amplifier rear panel by removing 2 fixing snap rivets.

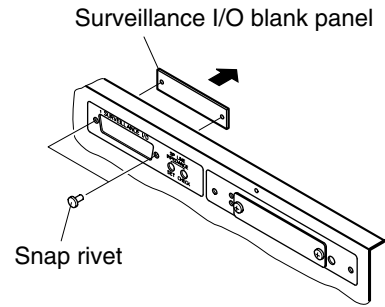

**Step 4.** Unscrew 2 hexagonal sleeves mounted on the 25-pin D-sub connector on the SV-200M Board.

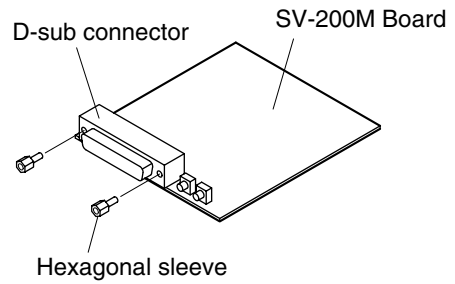

**Step 5.** Connect the SV-200M Board to the VM amplifier's boards with the connection cables.

**5-1.** Plug out the jumper connector from the relay board connector (CN1003) shown below.

**5-2.** Connect the 2 cables attached to the SV-200M to the connectors in the VM amplifier's boards shown below.

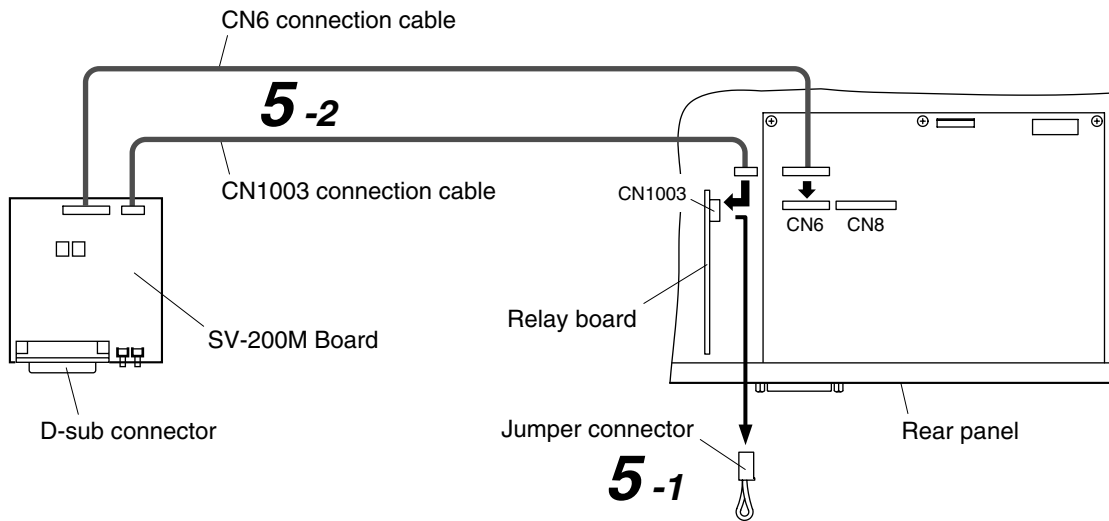

**Step 6.** Using the removed 2 hexagonal sleeves, mount the SV-200M in the amplifier.

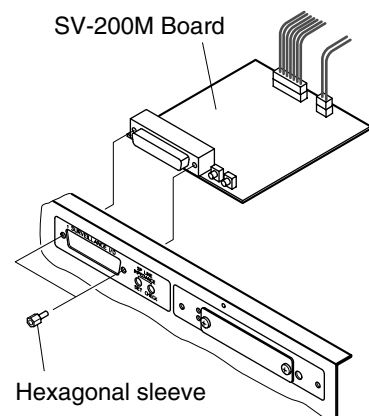

**Step 7.** Check the DIP switch on the SV-200M Board again for correct setting. (See Step 1.)

**Step 8.** Using the 4 rear panel screws and 6 side panel screws removed in Step 2, replace the amplifier cover.

## 17. RACK MOUNTING

**Step 1.** Remove 4 plastic feet from the unit's bottom side.

**Step 2.** Remove 2 screws on each side (located near the front).

**Step 3.** Fix the Rack Mounting Bracket MB-36 to the unit with its accessory screws and plain washers.

**Note:** Do not use the removed screws in the above step.

**Step 4.** Mount the unit on an equipment rack using the Bracket's accessory screws and fiber washers.

**Note:** When mounting the unit in an equipment rack not made by TOA, prepare separately the screws and washers appropriate for the rack.

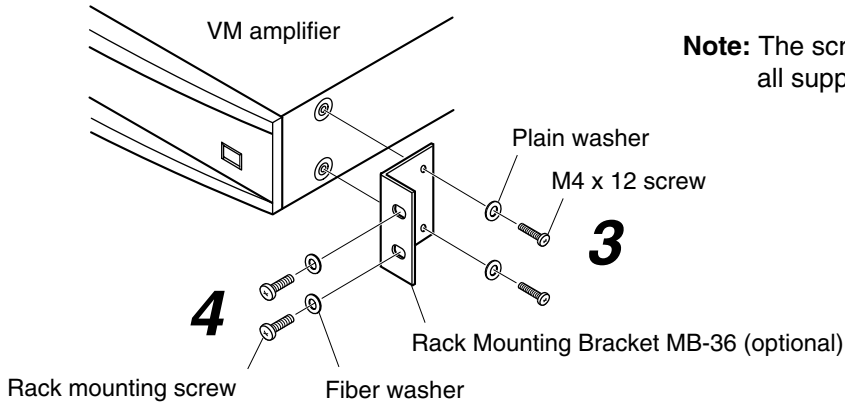

**Note:** The screws and washers as illustrated are all supplied with the MB-36.

## 18. AMPLIFIER INPUT CONNECTION

### 18.1. Two Amplifiers Stack-Connection

When 2 VM amplifiers are stack-connected, connect the master unit's "PRE OUT" to the sub-unit's "POWER AMP IN" as well as the LINK-to-LINK connection between both units.

### 18.2. Microphone Connection to the VM Amplifier

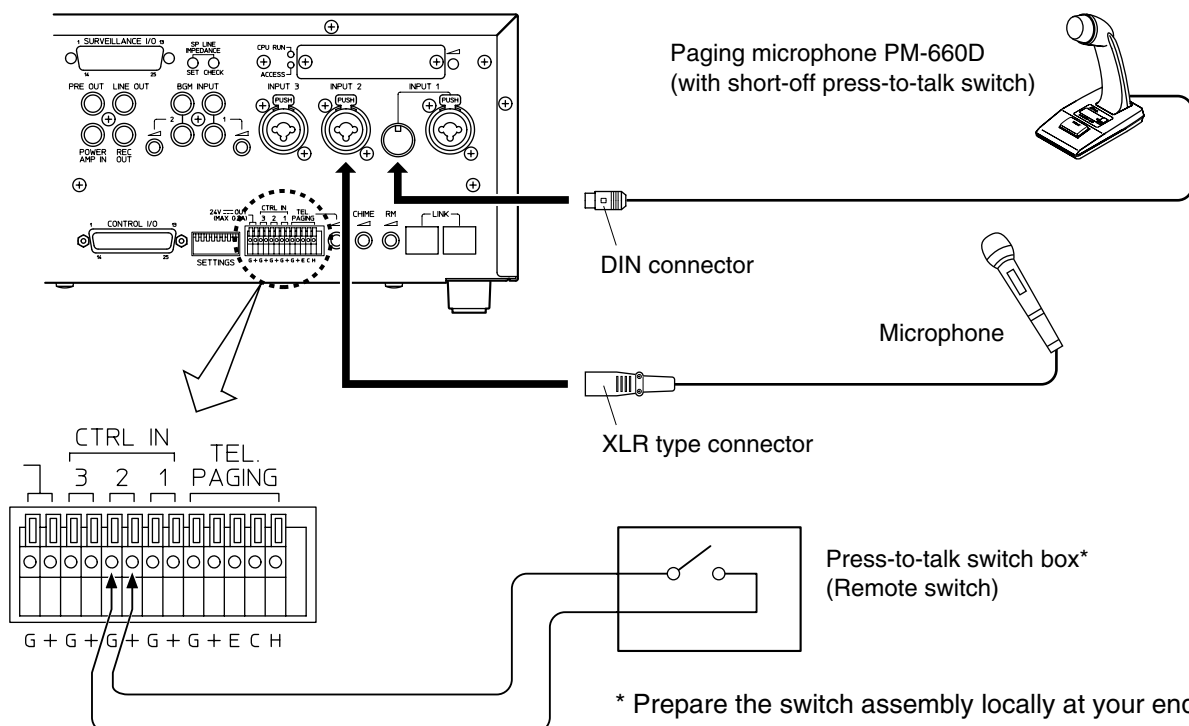

\* Prepare the switch assembly locally at your end.



### 18.3. Telephone Paging Input Connections

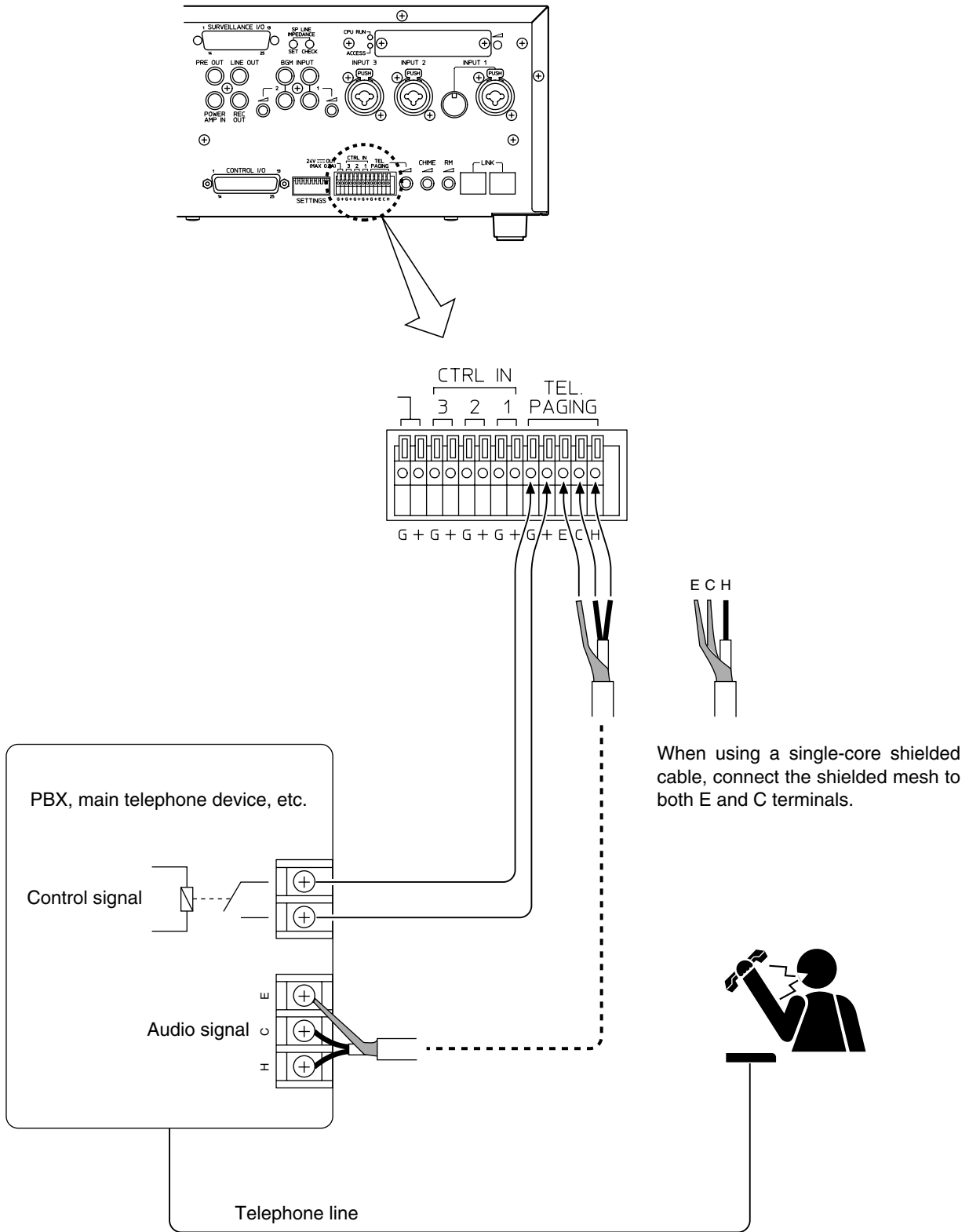

# 19. EXTERNAL ATTENUATOR CONTROL WIRING

## 19.1. 4-Wire System Connection

### ATTENUATOR CONTROL relay contact capacity

Withstand voltage: 30 V DC, 125 V AC

Contact current: Under 7 A (DC), under 7 A (AC)

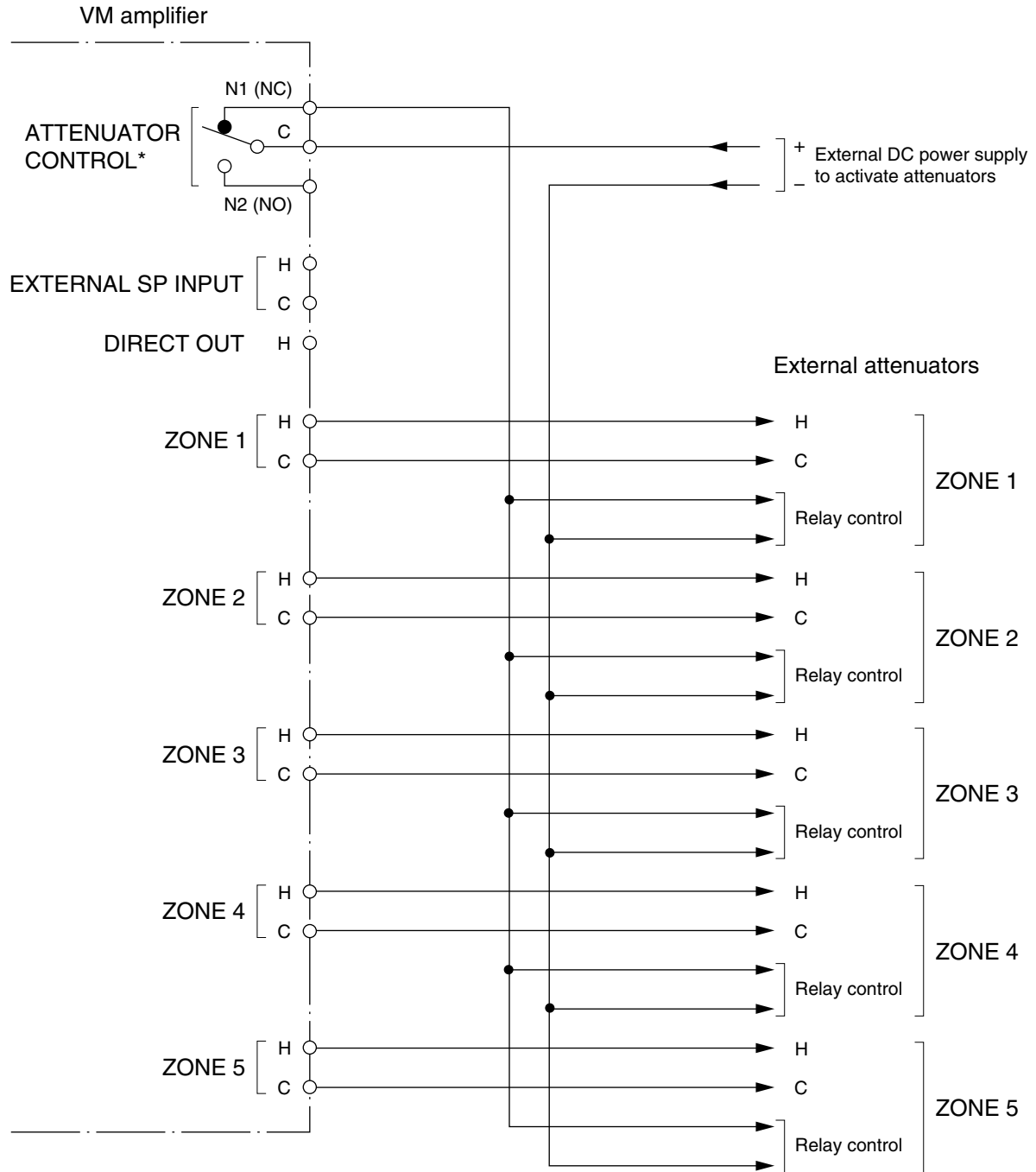

\* This figure shows the relay operation status when the VM amplifier's power is switched off, when it is making All-zone or emergency broadcast or when its broadcast is cut off due to control from external equipment in emergency broadcast mode.

## 19.2. 3-Wire System Connection

**Note:** 3-wire system cannot be used with the SV-200M board.

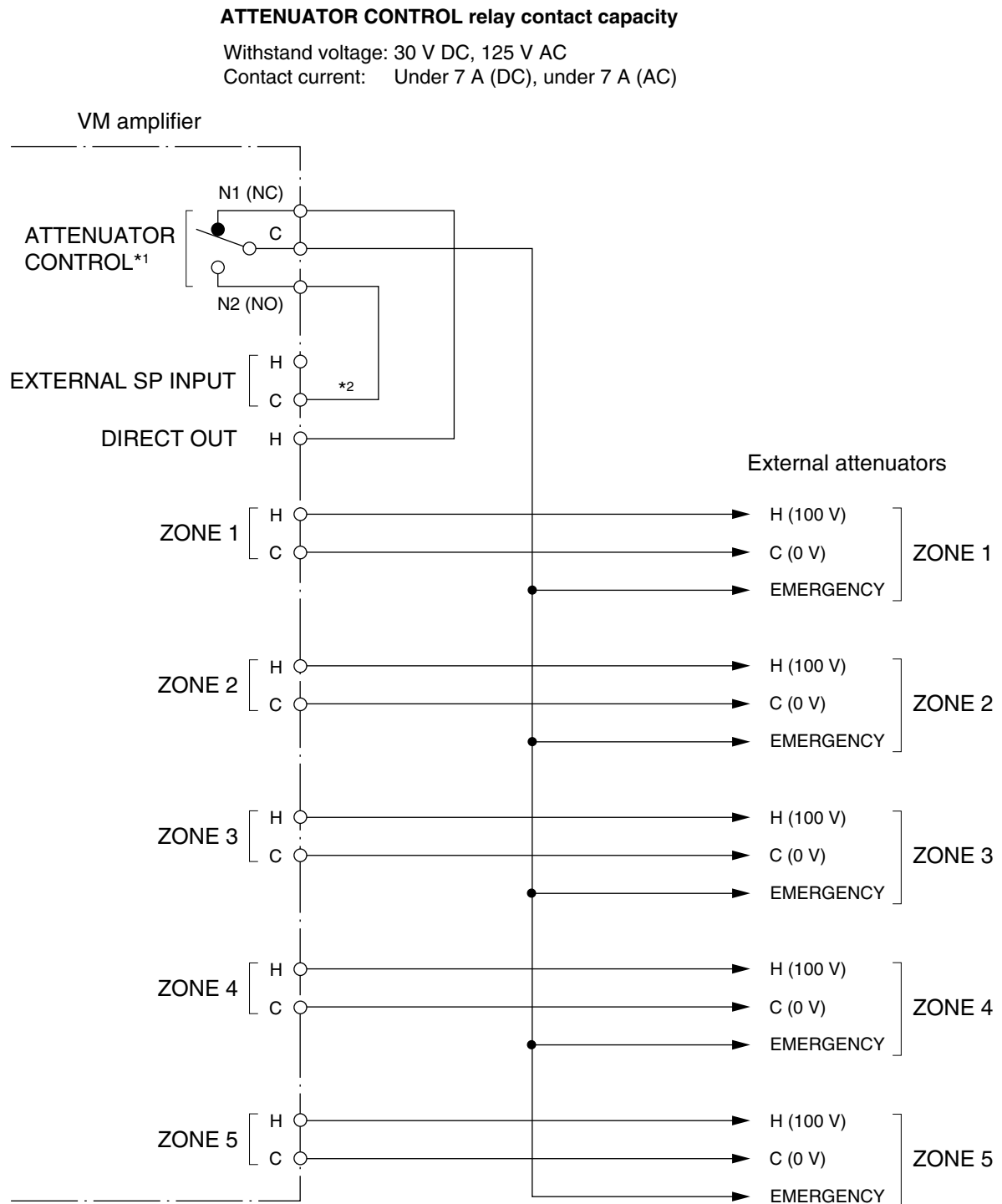

\*1 This figure shows the relay operation status when the VM amplifier's power is switched off, when it is making All-zone or emergency broadcast or when its broadcast is cut off due to control from external equipment in emergency broadcast mode.

\*2 May be connected to any C terminal. (This C terminal is located closest to N1 terminal.)

## 20. CHANGING THE SPEAKER LINE VOLTAGE

**Caution:** Leave the following work to a qualified service technician.  
Be sure to switch off the power before the work.

The VM amplifier's speaker line voltage is set for 100 V line output. For 50 V or 70 V line applications, change internal connector wiring as shown below.

**Step 1.** Remove 4 screws on the amplifier rear panel and a total of 6 screws on the sides to remove the cover.

**Step 2.** Pull the cable connector (9-pin) connected to CN1102 connector on the circuit board with the zone volume control (selector switch).

**Step 3.** Change wires inserted into the cable connector for different wires according to color-coding shown in the table below to switch to the desired line voltage.

**Step 4.** Connect the cable connector to the circuit board.

**Step 5.** Using the 4 rear panel screws and 6 side panel screws removed in Step 1, replace the amplifier cover.

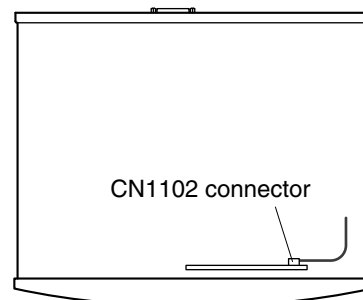

VM amplifier's front panel

### Connector pin assignment

Speaker line voltage	CN1102 Connector Pin Number								
	1	2	3	4	5	6	7	8	9
100 V	White	Violet	Blue	Green	Yellow	Orange	Red	Brown	Black
70 V	Violet	Blue	Green	Yellow	Orange	Red	Brown	White	Black
50 V	Blue	Green	Yellow	Orange	Red	Brown	White	Violet	Black

### Speaker line voltage/impedance

Speaker line voltage	VM-2120	VM-2240
100 V	83 $\Omega$	42 $\Omega$
70 V	42 $\Omega$	21 $\Omega$
50 V	21 $\Omega$	10 $\Omega$

### How to remove cables from connector

Pull out the cable pressing the lock spring with a pointed object like tweezers as shown below.

Pull out the cable.

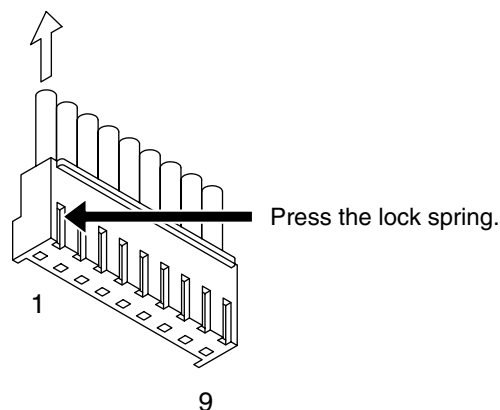

## 21. CONTROL I/O CONNECTOR FUNCTIONS

The rear panel-mounted Control I/O connector enables the VM amplifier to be controlled or monitored by connected external equipment. Referring to the pin arrangement and functions, prepare the matching D-sub male connector (screw-lock type) for connection to the external equipment. (See p. 9, 10 No. 30 CONTROL I/O connector.)

VM amplifier's D-sub female connector

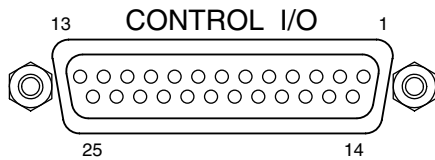

Locking nut: 4-40 UNC

### CONTROL I/O connector pin function table

Pin No.	Signal name	IN /OUT	Signal/logic	Function/status
1	AC power ON	OUT	Active Low	When AC power is on
2	DC power ON	OUT	Active Low	When DC power is on
3	Message 1 activation	IN	One-shot make	Activates EV-200 Board's Message 1.* <sup>1</sup>
4	Message 2 activation	IN	One-shot make	Activates EV-200 Board's Message 2.* <sup>1</sup>
5	Message 3 activation	IN	One-shot make	Activates EV-200 Board's Message 3.* <sup>1</sup>
6	Message 4 activation	IN	One-shot make	Activates EV-200 Board's Message 4.* <sup>1</sup>
7	Message 5 activation	IN	One-shot make	Activates EV-200 Board's Message 5.* <sup>1</sup>
8	VM amplifier's broadcast cutoff control	IN	At make	Cuts off the VM amplifier's power amplifier output.* <sup>1</sup> * <sup>2</sup> (External signals applied to EXTERNAL SP INPUT go through to the speakers.)
			At break	The VM amplifier's power amplifier output is resumed.
9	Chime activation (6 built-in chimes)	IN	Break-to-Make edge	Activates a start chime tone.
			Make-to-Break edge	Activates an end chime tone (4-tone Down).
10	Power ON/OFF control	IN	Break-to-Make edge	Turns power on.
			Make-to-Break edge	Turns power off.
11	Westminster chime activation	IN	One-shot make	Activates the internal Westminster chime unit.
12	Emergency alert activation	IN	One-shot make	Places the unit in "Emergency broadcast" mode, during which time an "Alert" announcement and an "Evacuation" announcement are broadcast.* <sup>1</sup>
13	Emergency stop activation	IN	One-shot make	Resets the unit from "Emergency broadcast" mode.
14	Emergency evacuation activation	IN	One-shot make	Places the unit in "Emergency broadcast" mode, during which time an "Evacuation" announcement is repeated.* <sup>1</sup>
15	Failure indicator control	IN	At make	The FAULT indicator lights to indicate external equipment failure.
16	GND			
17	GND			
18	GND			
19	GND			
20	GND			
21	Power switch on	OUT	Active Low	When the power switch is on by means of manual or external control

Pin No.	Signal name	IN /OUT	Signal/logic	Function/status
22	Communications error	OUT	Active Low	When communications cannot be achieved between the RM-200M and the VM amplifier or between VM amplifiers (High state when communications are restored.)
23	Failure indication	OUT	Active Low	When the FAULT indicator lamp is on
24	Emergency broadcast on	OUT	Active Low	When an Emergency broadcast is performed by the VM amplifier or the external equipment. (See the description of Pin 8 VM amplifier's broadcast cutoff.)
25	EV-200's failure	OUT	Active Low	When the EV-200 Voice Announcement Board fails.*1

\*1 Requires installation of the optional EV-200 Voice Announcement Board.

\*2 Use this pin to cut off the VM amplifier's power amplifier output to allow the "Emergency broadcast" initiated by connected external equipment to go through.

### [Electrical characteristics]

#### Input

Open voltage: 3.3 V DC

Short-circuit current: Under 1 mA

Activation: No-voltage make contact (one-shot signal is shown below.)

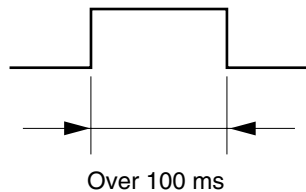

#### Output

Circuit: Open collector (See below.)

Withstand voltage: 30 V DC

Control current: Under 10 mA

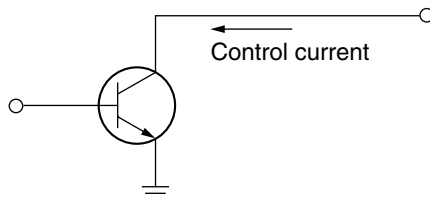

## 22. SURVEILLANCE I/O CONNECTOR FUNCTIONS

The rear panel Surveillance I/O connector\* permits "Speaker Line Reference Impedance Measurement (Initial Setting)" and "Speaker Line Check" to be enabled and monitored by connected external equipment. Referring to the pin arrangement and functions, prepare the matching D-sub male connector (screw-lock type) for connection to the external equipment. (See p. 11 No. 41 SURVEILLANCE I/O connector.)

\* Requires installation of the optional SV-200M Surveillance Board.

SV-200M's D-sub female connector

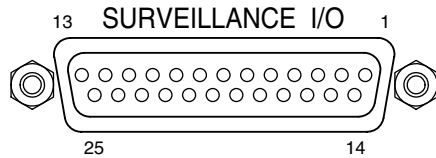

Locking nut: 4-40 UNC

### SURVEILLANCE I/O connector pin function table

Pin No.	Signal name	IN /OUT	Signal/logic	Function/status
1	Zone 1 short	OUT	Active Low	Zone 1 speaker line is shorted.
2	Zone 1 Disconnection	OUT	Active Low	Zone 1 speaker line is disconnected.
3	Zone 2 short	OUT	Active Low	Zone 2 speaker line is shorted.
4	Zone 2 Disconnection	OUT	Active Low	Zone 2 speaker line is disconnected.
5	Zone 3 short	OUT	Active Low	Zone 3 speaker line is shorted.
6	Zone 3 Disconnection	OUT	Active Low	Zone 3 speaker line is disconnected.
7	Zone 4 short	OUT	Active Low	Zone 4 speaker line is shorted.
8	Zone 4 Disconnection	OUT	Active Low	Zone 4 speaker line is disconnected.
9	Zone 5 short	OUT	Active Low	Zone 5 speaker line is shorted.
10	Zone 5 Disconnection	OUT	Active Low	Zone 5 speaker line is disconnected.
11	Ground fault	OUT	Active Low	Some of speaker lines are grounded.
12	Power amplifier failure	OUT	Active Low	Power amplifier is faulty.
13	Setting/checking busy	OUT	Active Low	During measurement of the speaker line reference impedance (Initial setting) or during check of the speaker lines.
14	Initial setting error	OUT	Active Low	The speaker line reference impedance couldn't be measured successfully. (The measured impedance exceeds the expected range or is unstable.)
15   22	_____			Not used.
23	Speaker line check activation	IN	One-shot make	Check of the speaker line impedance starts.
24	Speaker line initial setting activation	IN	One-shot make	Measurement of the speaker line reference impedance (Initial setting) starts.
25	_____			Not used.

**[Electrical characteristics]**

**Input**

Open voltage: 3.3 V DC  
 Short-circuit current: Under 1 mA  
 Activation: No-voltage make contact (one-shot signal is shown below.)

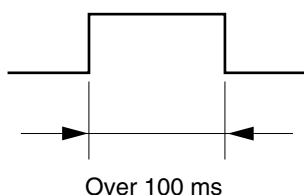

**Output**

Circuit: Open collector (See below.)  
 Withstand voltage: 30 V DC  
 Control current: Under 10 mA

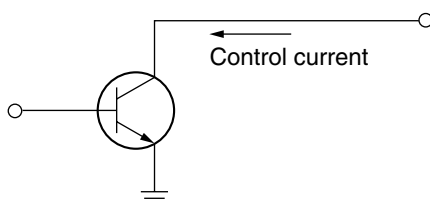

**23. FUNCTION SWITCH OPERATION**

**23.1. VM Amplifier's Rear Panel-Mounted Function Switches**

Set the rear panel-mounted SETTINGS switch (p. 9, 10 No. 29) as shown below.

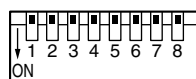

All switches No. 1 – 8 are factory-preset to the OFF position.

SETTINGS

Switch No.	1	2	3	4	5	6	7	8
Function	Phantom Power* <sup>4</sup>	Telephone Paging	Chime Selection			Input 3	Input 2	Input 1
OFF (Up position)	OFF	Chime ON	See the Chime Selection table			Mic	Mic	Mic
ON (Down position)	ON	Chime OFF				Line	Line	Line

**Chime Selection table**

Switch No.			Chime Tone
3	4	5	
OFF	OFF	OFF	2-Tone Chime
OFF	OFF	ON	2-Tone Chime (Fast Repeat)
OFF	ON	OFF	4-Tone Chime (Up) * <sup>1</sup>
OFF	ON	ON	Single-Tone Chime
ON	OFF	OFF	4-Tone Chime (Up & Down) * <sup>2</sup>
ON	OFF	ON	Gong
ON	ON	OFF	Pre-recorded Chime * <sup>3</sup>
ON	ON	ON	OFF

- \*<sup>1</sup> An ascending 4-tone chime is sounded when the broadcast begins.
- \*<sup>2</sup> An ascending 4-tone chime is sounded when the broadcast begins, and a descending 4-tone chime is sounded upon broadcast completion.
- \*<sup>3</sup> The chime sound source must be pre-recorded into a CF (CompactFlash) card to be inserted into the optional EV-200 Voice Announcement Board. (See p. 36.)
- \*<sup>4</sup> Simultaneously turns on or off the phantom power of Inputs 1 – 3. See p. 35 for the method to switch off the phantom power for the individual Inputs 1 to 3.



## 23.2. VM Amplifier's Internal Function Switches

**Caution:** Leave the following work to a qualified service technician.  
Be sure to switch off the power before the work.

**Step 1.** Remove 4 screws on the amplifier rear panel and a total of 6 screws on the sides to remove the cover.

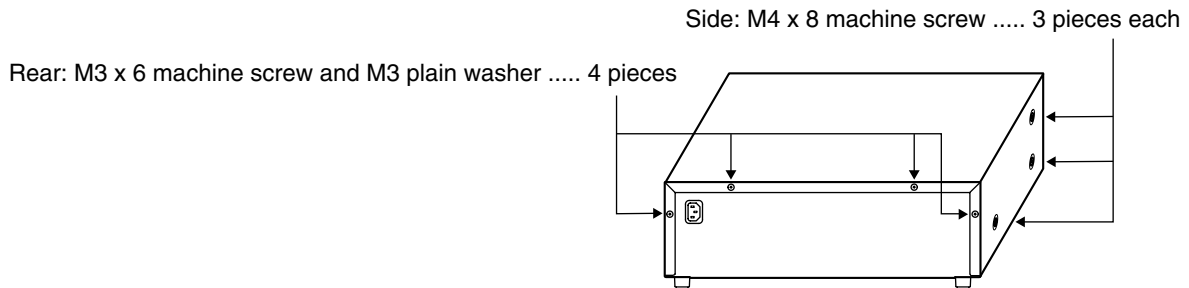

**Step 2.** Set the amplifier's internal DIP switches SW2, SW3, and SW4 according to the table below.

**Step 3.** Replace the amplifier cover using the screws removed in Step 1.

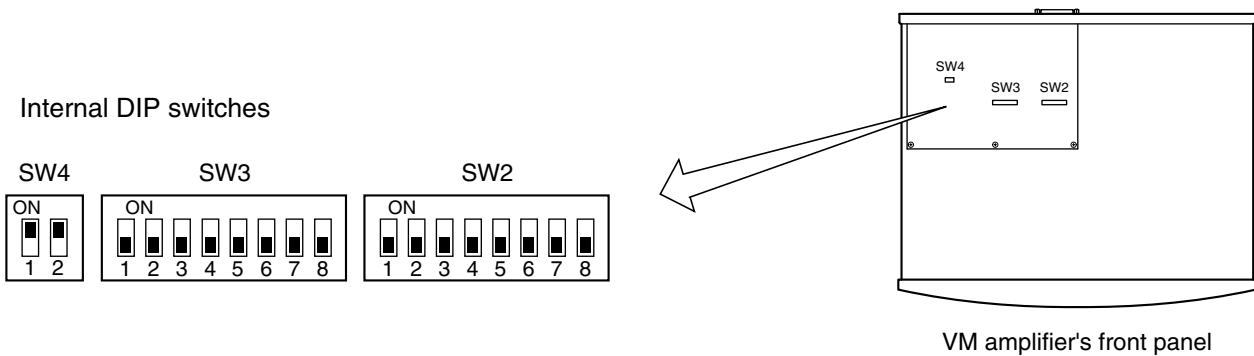

### SW2 switch setting (All switches are factory-preset to OFF position.)

Switch No.	1	2	3	4	5	6	7	8
Function	Inputs 1 – 3 Broadcast Priority Level			TEL Paging Priority Level	Voice Announcement Board's Message Priority Level			Priority Mode for Same Priority Unit
	Input 1	Input 2	Input 3		Message 3	Message 4	Message 5	
ON	1	1	1	1	3	3	3	Unit No. Priority (Numerical order)
OFF	2	2	2	2	1	1	1	First/Last Priority

### SW3 switch setting (All switches are factory-preset to OFF position.)

Switch No.	1	2	3	4	5	6	7	8
Function	First/Last Priority*	Priority 2 Mixing	Mode after Emergency Talk	Input 3/LINE (Input 3/MIC) Chime On/Off	Unit Type	No. of Connected Units		
ON	First-come first-served	Mixed	Silent	On (off)	Sub-unit	See the Connected unit No. table on the next page.		
OFF	Last-come first-served	Not mixed	Evacuation message	Off (on)	Master unit			

\* This function is set in relation to the SW2-8 switch. (See p. 27 "GENERAL-PURPOSE BROADCAST PRIORITY" for details.)

### Connected unit No. table (SW3)

Switch No.			No. of Connected Units*
6	7	8	
OFF	OFF	OFF	0
ON	OFF	OFF	1
OFF	ON	OFF	2
ON	ON	OFF	3
OFF	OFF	ON	4
ON	OFF	ON	5

\* The total number of one Sub-VM amplifier and up to 4 Remote Microphones (excluding the Master amplifier and Remote Microphone Extension)

### SW4 switch setting (Both switches are factory-preset to ON position.)

Switch No.		BGM broadcast volume attenuation*
1	2	
OFF	OFF	No attenuation
	ON	-28 dB (just audible)
ON	Don't care	-∞ dB (inaudible)

\* Determines the attenuation level when the broadcast of higher priority (level 2 or 3) overrides the BGM broadcast (priority level 4). (See p.27 "GENERAL-PURPOSE BROADCAST PRIORITY")

## 23.3. Remote Microphone's Function Switches

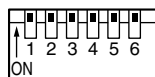

Function setting switch (No.23)

#### Note

The switch is actually installed upside down.

Switch No.	1	2	3	4	5	6
Function	RM Unit No. (See the RM Unit No. table below.)		Broadcast Priority*	Talk key operation	Emergency switch	Compressor
ON			2	Press-to-talk type	Enable	On
OFF			1	Talk lock type	Disable	Off

\* One of 2 priorities can be set for each Remote microphone. (See p.27 "GENERAL-PURPOSE BROADCAST PRIORITY.")

### RM (RM-200M) Unit No. table

Switch No.		RM Unit No.
1	2	
ON	ON	No. 1
OFF	ON	No. 2
ON	OFF	No. 3
OFF	OFF	No. 4

All switches No. 1 – 6 are factory-preset to the ON position.

## 24. BROADCAST GROUP/ZONE SETTING

### 24.1. Routing Assignment

#### 24.1.1. Zone-to-Group assignment

Desired broadcast zones (1 – 10) can be combined into one broadcast group (Groups 1 – 5). (See p. 53 "Zone-to-Group Assignment Operation.")

**Setting example** (✓ mark indicates "Set" state.)

Broadcast Group (Setting item)	Setting content										ALL zones (Marking a check bypasses the external attenuator on all-zone broadcast.)
	Broadcast Zone 1 – 10										
	1	2	3	4	5	6	7	8	9	10	
Group 1	✓	✓									
Group 2		✓	✓	✓							
Group 3			✓	✓							
Group 4	✓	✓	✓	✓	✓	✓	✓	✓	✓	✓	✓ *2
Group 5	✓	✓	✓	✓	✓	✓	✓	✓	✓	✓	

Master unit zone
Sub-unit zone
For Remote Microphone operation\*1

\*1 The Remote Microphone can select broadcast zones by pressing the GROUP 1 or GROUP 2 key instead of individual zone selector keys 1 – 10.

\*2 The broadcast zone settings (zones 1 – 10) cannot be changed unless the ALL zones setting is canceled (i.e. "Not Bypassed").

If the ALL zones (attenuator bypass) item is set to "Bypassed," as seen in Group 4 in the above example. Setting "Bypassed" shorts the "N1" terminal to "C" terminal on the rear-mounted ATTENUATOR CONTROL when an all-zone broadcast is made.

#### [Default setting]

Only the zone with the same number as the group number is assigned to each group. (Example: Zone 1 is assigned to Group 1, and Zone 5 to Group 5.)

#### 24.1.2. Control input/Telephone paging/Westminster chime-to-Group assignment

When control inputs 1 – 3, telephone paging, or Westminster chime is activated, broadcast is made to their respectively assigned groups 1 – 5. (See p. 56 "Control Input/Telephone Paging/Westminster Chime-to-Group Assignment Operation.")

**Setting example** (✓ mark indicates "Set" state.)

Control Input/Telephone Paging/Westminster Chime (Setting item)	Setting content					ALL zones (Marking a check bypasses the external attenuator on all-zone broadcast.)
	Broadcast Group					
	1	2	3	4	5	
Input 1	✓	✓	✓			
Input 2						
Input 3						
TEL paging						✓
Westminster chime	✓	✓	✓	✓	✓	

Broadcast is made to the zones selected in the above Zone-to-Group assignment.

#### [Default setting]

Only "All zones" is assigned to each setting item from Input 1 to Westminster chime. (Example: TEL paging setting in the above table)

### 24.1.3. Recorded Message-to-Group assignment

Activated messages (1 – 5) are broadcast to their respectively assigned groups 1 – 5. (See p. 58 "Recorded Message-to-Group Assignment Operation.")

Setting example (✓ mark indicates "Set" state.)

Setting content

Recorded Message (Setting item)	Broadcast Group					ALL zones (Marking a check bypasses the external attenuator on all-zone broadcast.)
	1	2	3	4	5	
Message 1	✓		✓	✓		
Message 2				✓		
Message 3						✓
Message 4						
Message 5						

Messages are broadcast to the zones selected in the above Zone-to-Group assignment.

#### [Default setting]

Only "All zones" is assigned to each of Messages 1 – 5. (Example: Message 3 setting in the above table)

## 24.2. Operating Keys

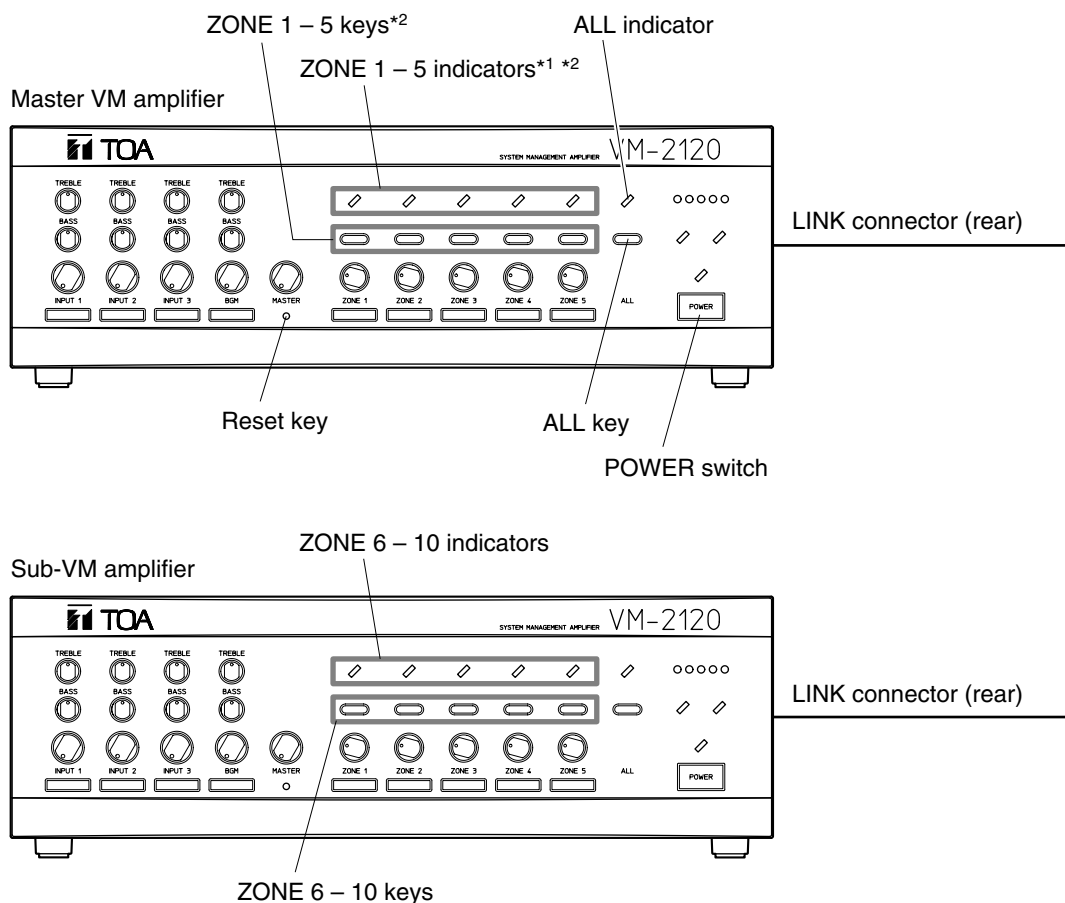

\*1 See p. 55 "Indicator status."

\*2 Function as the indicators or keys for the setting items (Group 1 – 5, Message 1 – 5, etc.) as well according to the setting steps.

- Note that the Sub-unit's zone selector keys function as the ZONE 6 through ZONE 10 keys.
- The figure above shows a 10-zone broadcast system where master unit and sub-unit are linked together. A 5-zone broadcast system requires the master unit only.

## 24.3. Zone-to-Group Assignment Operation

- Here, the operation example of assigning Broadcast Zones 2 – 4 to Group 2 will be explained for a 5-zone (Master unit only) configuration. (See p. 51 "Group 2 to zone" setting example.)
- In the case of 10 broadcast zones (i.e. connection of a master unit to a sub-unit), use the sub-unit's Zone selector keys 1 – 5 as Zone keys 6 – 10.

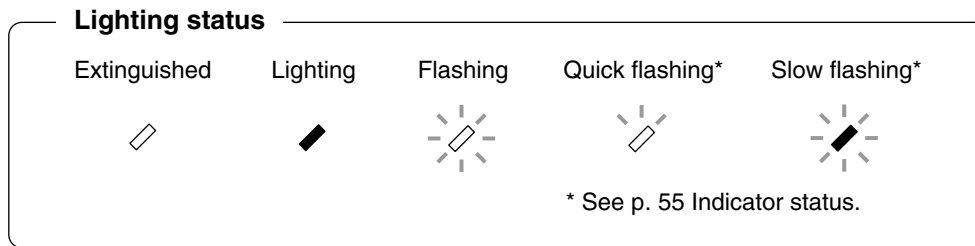

### Step 1. Entry to broadcast group setting mode

Press and release the Reset key while holding down the ZONE 1 and ZONE 2 keys. When all indicators for Zones 1 – 5 begin to flash (2 – 3 seconds after), release both the ZONE 1 and ZONE 2 keys.

Use a precision screwdriver or other long, pointed object (2.5 mm in diameter and over 30 mm in length) when pressing the Reset key.

**Note:** Even when a sub-amplifier is connected, perform this setting entry operation on the master amplifier only.

The unit will be placed in broadcast group setting mode.

The 5 indicators for ZONE 1 through ZONE 5 begin to flash. (They indicate Group 1 through Group 5.) Another 5 indicators for ZONE 6 through ZONE 10 will also flash if a Sub-amplifier is connected.

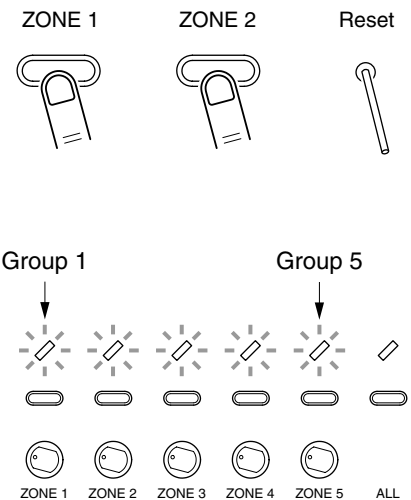

### Step 2. Group number selection (Example: Group 2)

Press the ZONE 2 key to select the Group 2.

The ZONE 2 indicator will slowly flash\* to indicate that Group 2 was selected.

Pressing other selector key will change the group number

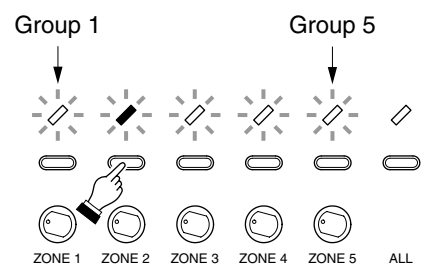

### Step 3. Group number programming

Press the POWER switch.

The Group 2 will be programmed and the unit will be placed in Zone Selection mode for Group 2.

- The ZONE 2 indicator changes from "quick flashing" to "slow flashing\*," indicating that Group 2 was selected and that Zone 2 was set (default setting).
- The remaining indicators, ZONE 1, ZONE 3, ZONE 4, ZONE 5, and ALL flash. (This indicates that Zones 2 was set as default.)

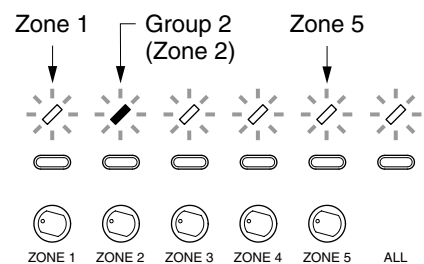

**Step 4.** Zone number setting (Example: Zones 2, 3, and 4)

Press the ZONE 3 and ZONE 4 keys to select the corresponding zones. (As a result, The Zones 2, 3, and 4 are selected.)

- Indicators for ZONE 3 and ZONE 4 will light. (This represents that Zones 3 and 4 were selected.)
- Indicators for ZONE 1 and ZONE 5 will flash. (This represents that Zones 1 and 5 are not selected.)
- The ZONE 2 indicator remains "slow flashing\*." (This represents that Group 2 has already been selected, and that Zone 2 is currently selected as default setting.)

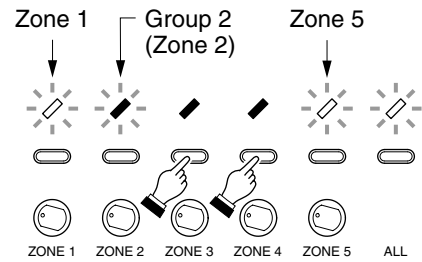

**Note:** For "All zones" settings in this step, refer to the section "All zones setting and its cancellation" below.

**Step 5.** Programming of the zone number setting

Press the POWER switch.

The Zones 2, 3, and 4 will then be programmed, automatically returning the procedure to Step 2. According to the instructions in Step 2, set the next zone group. (Repeat Steps 2 through 5.)

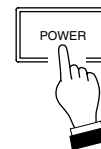

**Step 6.** Group setting completion

After completing all group settings, press the Reset key using a pointed object.

This completes the setting mode, returning the unit to broadcast standby mode.



\* See p. 55 Indicator status.

**[All zones setting and its cancellation]**

Pressing the ALL key selects all zones and places the unit in the external attenuator bypass mode. The ALL indicator and the indicators for ZONE 1 and ZONE 3 – ZONE 5 will light, while the ZONE 2 indicator will slowly flash.

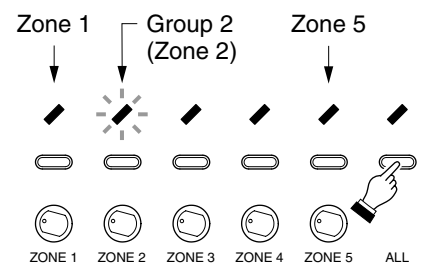

When the ALL indicator is steadily on, if the ALL key is pressed, the selection of all zones will be cancelled. Then, the setting returns to the situation before the "ALL zones" was set.

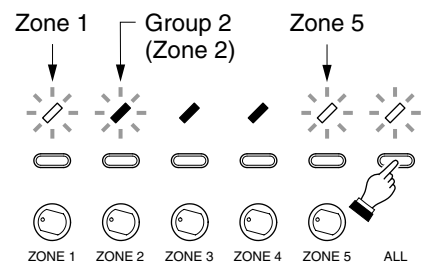

**[Group setting contents check]**

Complete Steps 1, 2, and 3, then jump to Steps 5 and 6 without executing Step 4 (zone number setting).

**[Indicator status]**

(1) Flashing

Equal duration "ON" and "OFF" indicator flashing.

Indicates that the corresponding setting contents (Example: Zone number) have not yet been selected (setting contents can be selected).

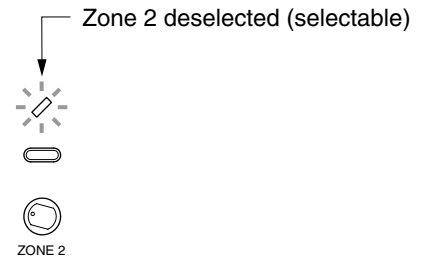
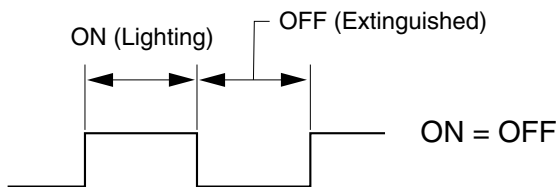

(2) Quick flashing

Indicator flashing with a shorter "ON" duration than "OFF" duration.

Indicates that the corresponding setting item (Example: Group No. 2) was already selected when in the state of (1) above.

Example: The indicator quickly flashes when Group 2 was selected, but Zone 2 has not yet been selected (Zone 2 selectable).

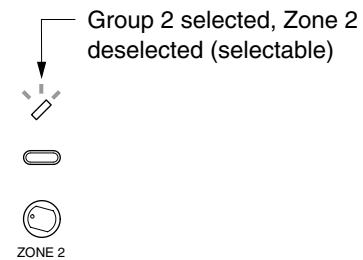
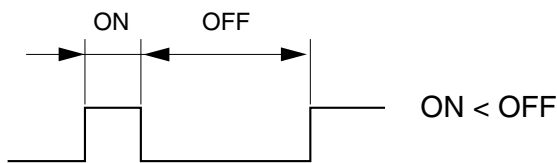

(3) Steady on

Indicates that the setting contents were selected.

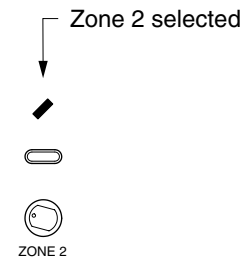

(4) Slow flashing

Indicator flashing with a longer "ON" duration than "OFF" duration.

Indicates that the corresponding setting item (Example: Group No. 2) was already selected when in the state of (3) above.

Example: The indicator slowly flashes when both Group 2 and Zone 2 were selected.

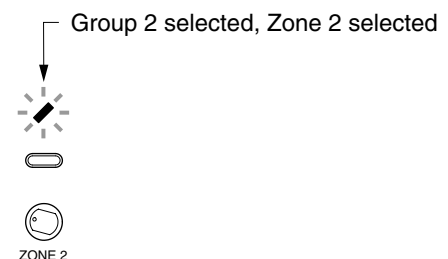
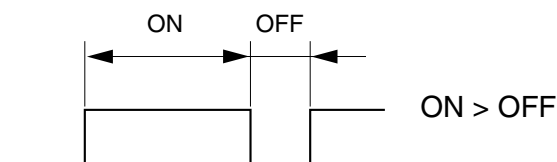

**[Operation for zone selection and its cancellation]**

- Pressing a currently flashing or quickly flashing zone key for any zone not selected will select that zone (the zone indicator then remains steadily lit or slowly flashes).
- Conversely, if a currently selected zone key is pressed, that zone will then be deselected. ("Selected" and "deselected" states are alternately changed with each press of the key.)

**[Dual indication of group and zone selections]**

The indicators for set zones remain steadily on, while those for unset zones flash. However, if a zone with the same number as the group number is selected, the corresponding indicator slowly flashes\*. (This provides a dual indication of Group and Zone selection.) When the same number zone is not selected, the indicator quickly flashes\*. (This provides a dual indication of Group selection and Zone deselection.)

\* See p. 55 Indicator status.

**24.4. Control Input/Telephone Paging /Westminster Chime-to-Group Assignment Operation**

Here, the operation example of assigning Input 1 to Broadcast Groups 1, 2, and 3 will be explained. (See p. 51 "Input 1 to group" setting example.)

**Step 1. Entry to setting mode**

Press and release the Reset key while holding down the ZONE 1 and ZONE 4 keys. When all indicators for Zones 1 – 5 begins to flash (2 – 3 seconds after), release both the ZONE 1 and ZONE 4 keys.

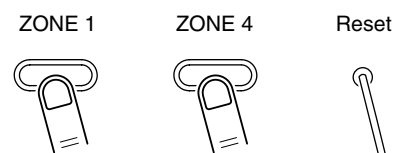

The unit will be placed in setting mode. The 5 indicators for ZONE 1 through ZONE 5 begin to flash. (They indicate Input 1 through Westminster chime.)

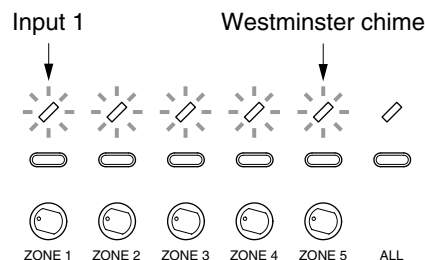

**Step 2. Setting item selection (Example: Input 1)**

Press the ZONE 1 key to select the Input 1. Note that the ZONE 1 key functions as the selector key for "Input 1."

The ZONE 1 indicator will slowly flash\* to indicate that Input 1 was selected.

Pressing other selector key will change the setting item assigned to each zone key as shown on the right.

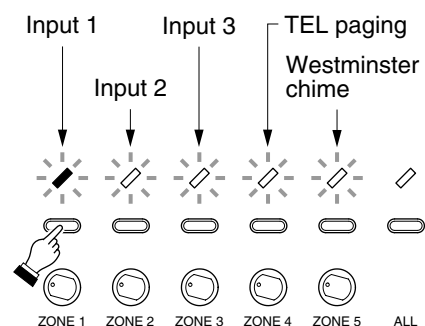

**Step 3. Setting item programming**

Press the POWER switch.

The Input 1 will be programmed and the unit will be placed in Group Selection mode for Input 1.

The ZONE 1 indicator changes from "quick flashing" to "slow flashing", while the remaining indicators for zones 2 – 5 and "ALL" (All zones) stay steadily on. This represents that Input 1 has been selected, and "ALL zones" (not "ALL groups") has been set. (Default setting)

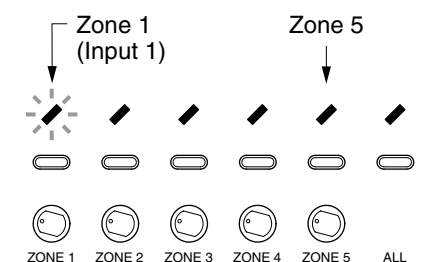



#### Step 4. Group number setting (Example: Groups 1, 2, and 3)

4-1. Pressing the ALL key will cancel the "ALL zones" setting, causing the ALL indicator and the indicators for ZONES 2 – 5 to flash. The ZONE 1 indicator changes from "slow flashing" to "quick flashing," indicating that Input 1 was selected but Group 1 was not.

**Note:** The setting returns to the situation before the "ALL zones" was set.

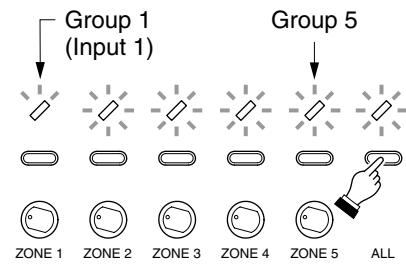

4-2. Press the ZONE 1, ZONE 2, and ZONE 3 keys to select the Groups 1 through 3.

- The ZONE 1 indicator changes from "quick flashing" to "slow flashing\*," indicating that Input 1 was selected and that Group 1 was set.
- Indicators for ZONE 2 and ZONE 3 become steadily on. (This represents that Groups 2 and 3 are selected.)
- Indicators for ZONE 4, ZONE 5, and ALL remain flashed. (This represents that Groups 4 and 5 were not selected.)

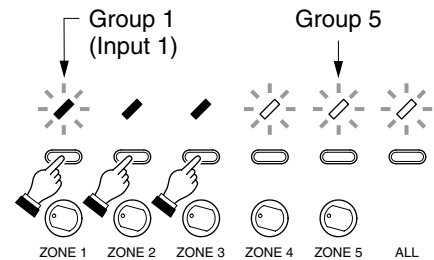

#### Step 5. Programming of the group number setting

Press the POWER switch.

The Groups 1, 2, and 3 will then be programmed, automatically returning the procedure to Step 2. According to the instructions in Step 2, set the next setting item. (Repeat Steps 2 through 5.)

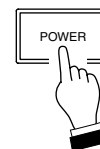

#### Step 6. Setting completion

After completing all item settings, press the Reset key using a pointed object.

This completes the setting mode, returning the unit to broadcast standby mode.



\* See p. 55 Indicator status.

#### [Message setting contents check]

Complete Steps 1, 2, and 3, then jump to Steps 5 and 6 without executing Step 4 (group number setting).

#### [Operation for group selection and its cancellation]

- Pressing a currently flashing or quickly flashing zone key for any group not selected will select that group (the zone indicator then remains steadily lit or slowly flashes).
- Conversely, if a currently selected zone key is pressed, that group will then be deselected. ("Selected" and "deselected" states are alternately changed with each press of the key.)

#### [Dual indication of setting item and group selections]

The indicators for set groups remain steadily on, while those for unset groups flash. However, if a group to which the setting item is assigned as in the figure of Step 2 is selected, the corresponding indicator slowly flashes\*. (This provides a dual indication of Setting item and Group selection.) When that group is not selected, the indicator quickly flashes\*. (This provides a dual indication of Setting item selection and Group deselection.)

\* See p. 55 Indicator status.

## 24.5. Recorded Message-to-Group Assignment Operation

Here, the operation example of assigning Recorded Message 1 to Broadcast Groups 1, 3, and 4 will be explained. (See p. 52 "Message 1 to group" setting example.)

### Step 1. Entry to recorded message setting mode

Press and release the Reset key while holding down the ZONE 1 and ZONE 3 keys. When all indicators for Zones 1 – 5 begins to flash (2 – 3 seconds after), release both the ZONE 1 and ZONE 3 keys.

The unit will be placed in recorded message setting mode.

The 5 indicators for ZONE 1 through ZONE 5 begin to flash. (They indicate Message 1 through Message 5.)

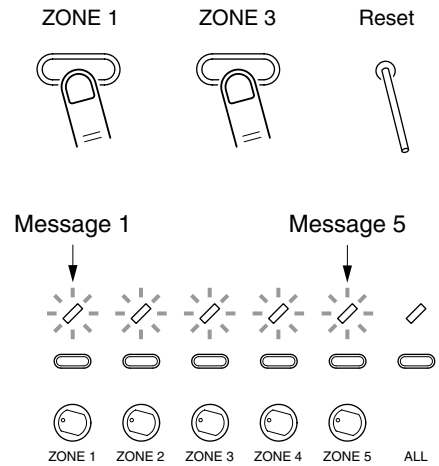

Operations of Steps 2 – 6 described hereafter are the same as those described in the previous section Control input/Telephone paging/Westminster chime-to-Group assignment. However, read 5 setting items of Inputs 1 – 3, TEL paging, and Westminster chime as Messages 1 – 5.

Shown on the right is the status of each indicator that results from the group number setting (Example. Groups 1, 3, and 4) performed in Step 4.

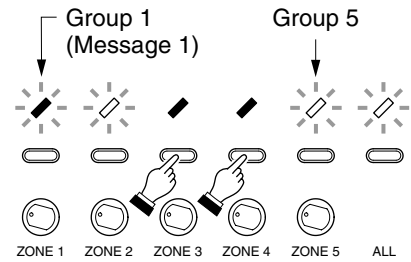

## 25. LINKAGE BETWEEN REMOTE MICROPHONE AND ITS EXTENSION

When adding the RM-210 Remote Microphone Extension, link it with the RM-200M Remote Microphone using the extension cable and mounting hardware supplied with the RM-210.

**Step 1.** Turn over both the RM-200M and the RM-210, and keep them in close contact with each other.

**Step 2.** Connect between both units using the extension cable.

**Step 3.** Using 4 supplied screws (marked with [➡] in the figure) and Linkage Bracket B, link both units together.

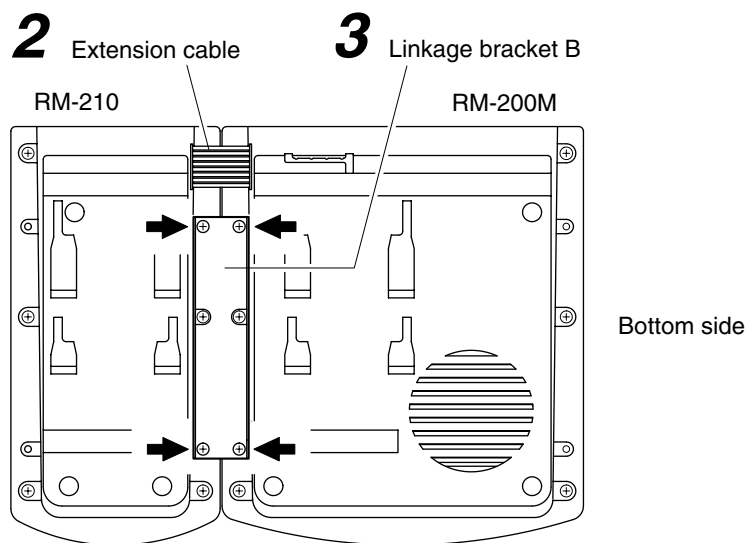

**Step 4.** Using 8 supplied screws ([➡] marking) and 2 pieces of Linkage Bracket A, fix both units securely.

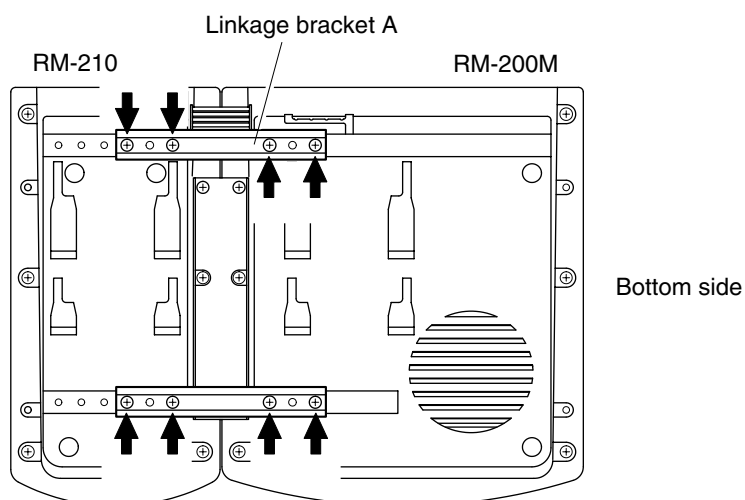

**Note:** If incorrect or loose connection is found between both units, loosen all the bracket fixing screws to disassemble the units and then link them again with the screws.

## 26. NAME LABEL PREPARATION

### 26.1. Amplifier's Label Preparation

- Use the supplied labels to indicate the names of each input and output on the front panel. Write the name in the label, and affix it under each input or output volume control. See p. 8 "NOMENCLATURE AND FUNCTIONS" for the place the label is affixed to. When making the label with a word processor, etc., be sure that its size is no larger than 24 mm x 6 mm.
- Use the supplied  $\Delta$  label to indicate the set position of each volume control.

### 26.2. Remote Microphone's Label Preparation

#### 26.2.1. Name label type and usable paper

Label type

Name label A: For setting on the RM-200M's left side

Name label B: For setting on the RM-200M's right side, and RM-210

Paper: Under 0.2 mm thick

#### 26.2.2. Preparing the name label

(1) Preparation by hand

Copy the "Pattern paper for hand writing" on the next page. After writing a name, cut out the pattern paper aligning it with the cutting guidelines.

(2) Preparation by using a PC or word processor

Prepare and print according to the instructions given in the "Dimensional diagram for printing devices" on p. 62. Then cut out to the instructed size.

#### 26.2.3. Inserting the name label

- Fully insert the name label cut out to the instructed size into the label entry slit.
- To remove the label, pull it out of the slit using the tip of knife blade.

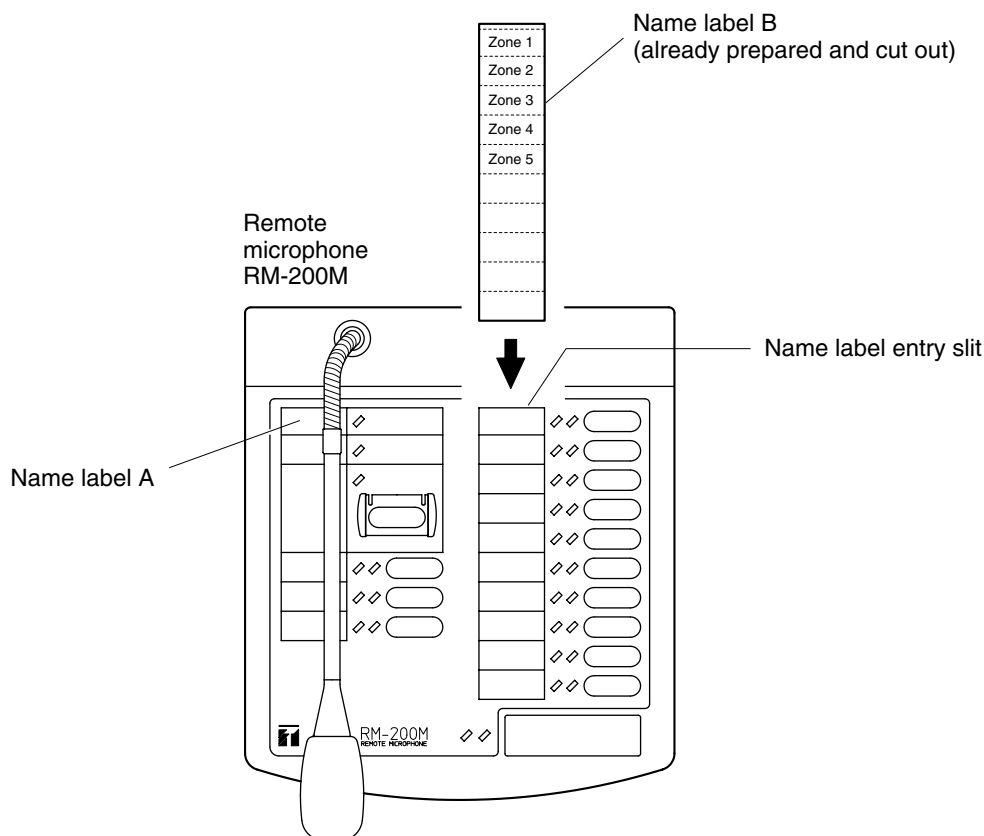

[Pattern paper for hand writing]

Name label A

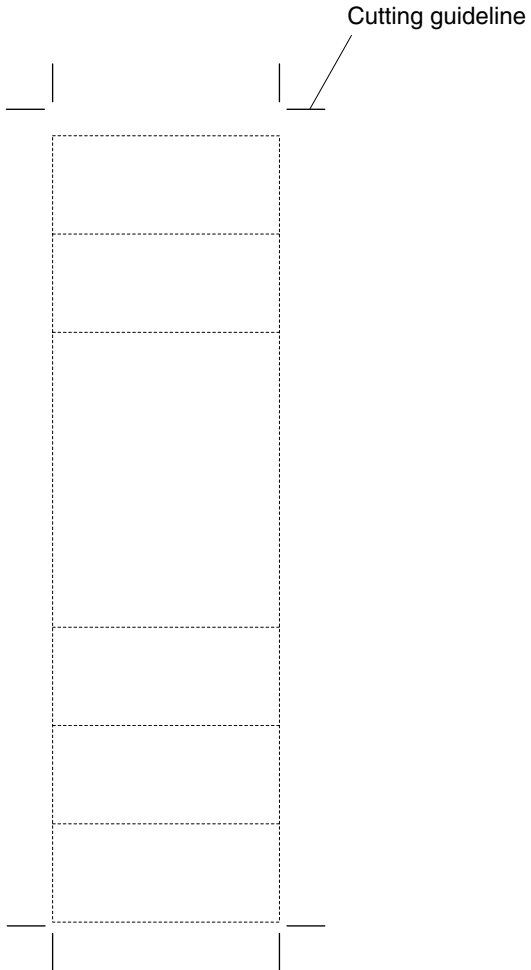

Name label B

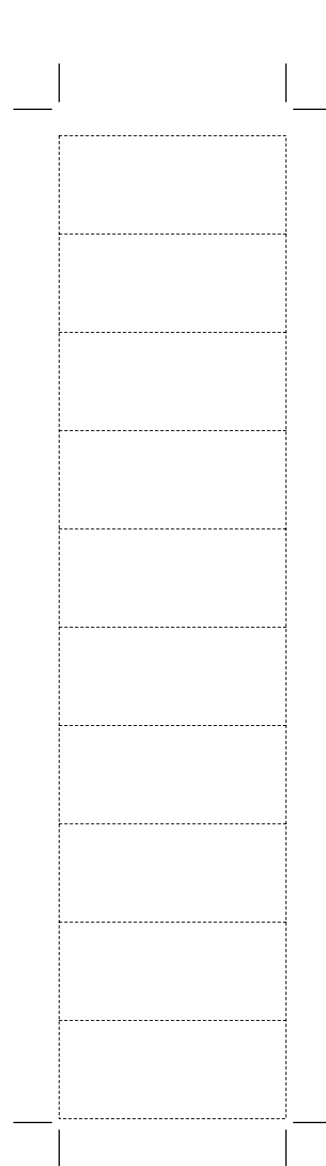

Shown in actual size

[Dimensional diagram for printing devices]

Name label A  
Cutting size: 30 x 108 mm

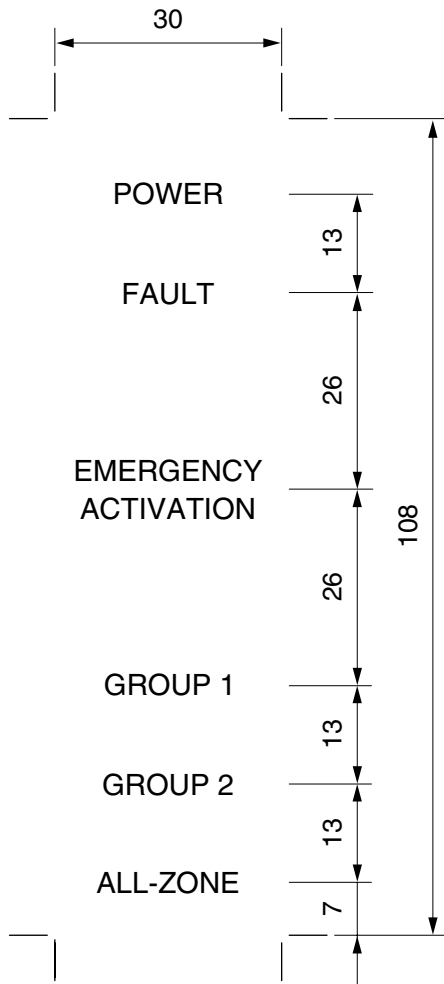

Name label B  
Cutting size: 30 x 134 mm

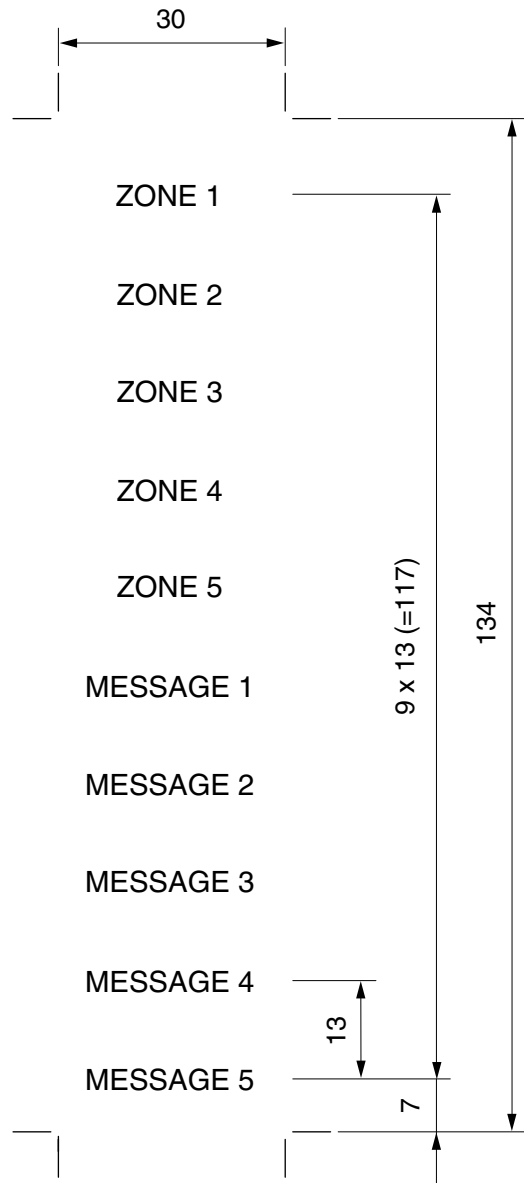

Names are assigned as an example.  
Unit: mm

## 27. COMPACTFLASH (CF) CARD RECORDING

### 27.1. Recording

- Use TOA's EV-350R Digital Announcer for CF card recording.
- The table below shows an example of Program/Sentence composition for Messages 1 – 8.

#### [Setting items and contents]

- (1) Set the items in "Program No." (P001 – P008) and "Playback method" columns as shown in the table. Besides, be sure to set the "Busy output (at repeat interval)" (omitted in the table) for ON (factory-preset).
- (2) The contents in "Number of repeats", "Repeat interval", and "Sentence No. (or Silent Section)" are given for an example.
- (3) Determine the optimum "Output level" for each Program by performing the operation. (Factory-preset level: Graduation 6)

**Note:** The VM amplifier ignores the following settings programmed by the EV-350R.

- (1) Program title, Sentence title
- (2) Output (1 and/or 2)
- (3) The setting contents to be registered in the EV-350R unit, not in the CF card. (See the item marked (\*2) in the "Summarized Operational Functions" on page 15 of the "EV-350R OPERATING INSTRUCTIONS.")

Refer to the "Digital Announcer EV-350R Operating Instructions" for terminologies and recording method.

#### [Usable CF Cards (their card adapter required)]

- Use the "SanDisk"\* CompactFlash\* (CF) card. Required card capacity (16 - 96 MB) depends on the recording time and sound quality. For reference, see the card capacity vs. recording time table on page 8 of the "EV-350R OPERATING INSTRUCTIONS." Be sure to keep 10-second or longer unrecorded portion on the card because it is used for controlling the EV-200 board's surveillance function.
- Place the CF card in the CompactFlash card adapter, then insert the adapter into the memory card slot on the EV-350R's front panel.

\* Trademark of SanDisk Corporation

#### Caution

- When the EV-200 is mounted, never move the unit from one place to another with the Flash Card inserted because the EV-200 or the CompactFlash card may fail.
- Avoid inserting or withdrawing the CompactFlash card while the unit is alive.

### 27.2. Message Program/Sentence Composition Example

VM unit's Message No.	Program No.	Playback method	Number of repeats	Repeat interval	Sentence No. (or Silent Section)	Remarks
Message 1	P001	Continuous	—	—	A001, A002, M003, A003	Activation from Remote Microphone or Message activation input (CONTROL I/O)
Message 2	P002	Program	—	—	A011, A012, M002, A013	
Message 3	P003	Playback	—	—	A021, A022, M002, A023	
Message 4	P004		—	—	A031	
Message 5	P005		—	—	A041	
Message 6	P006	Repeat	5 times	0 second	A051, M001, A052, M002	Alert message
Message 7	P007	Playback	Endless	0 second	A061, M001, A062, M002	Evacuation message
Message 8	P008	Continuous Program Playback	—	—	A071	Pre-recorded chime

### 27.3. Message Program Example

The programs shown in "Message Program/Sentence Composition Example" on the previous page operate as follows.

- (1) General-purpose broadcast message (Program No. 1)  
 [Continuous program playback method]

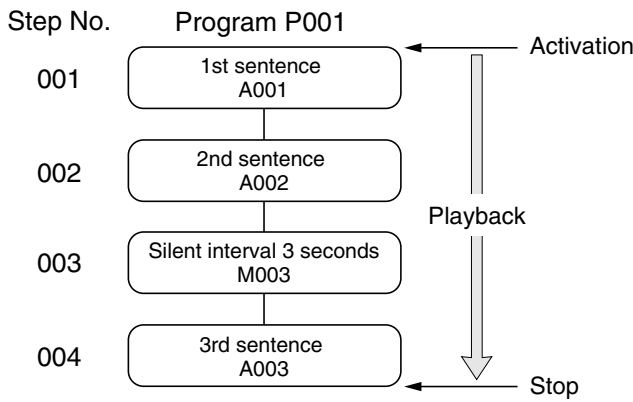

- (2) Alert announcement message (Program No. 6)  
 [Repeat playback method]

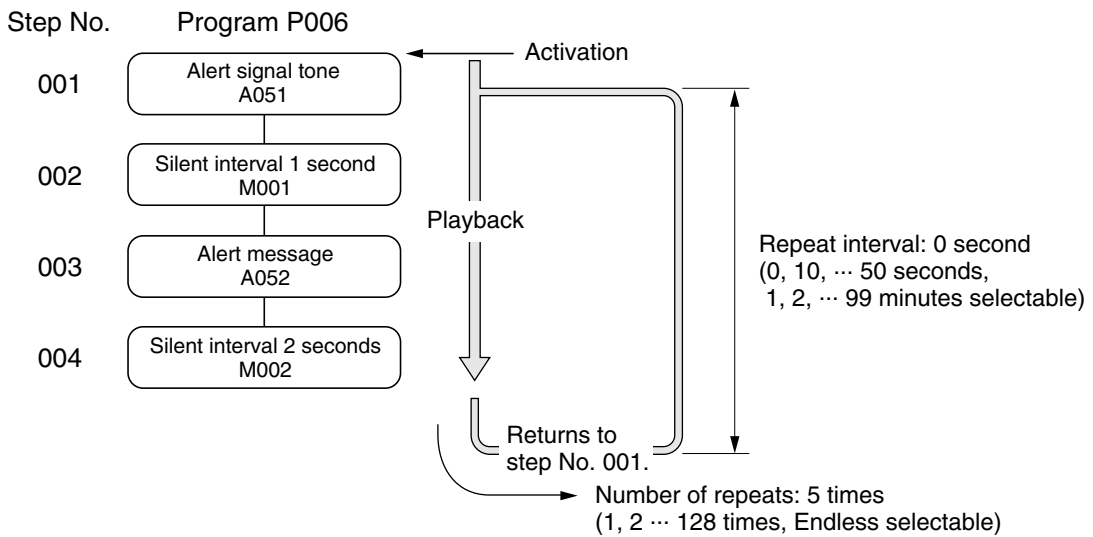

- (3) Evacuation announcement message (Program No. 7)  
 [Repeat playback method]

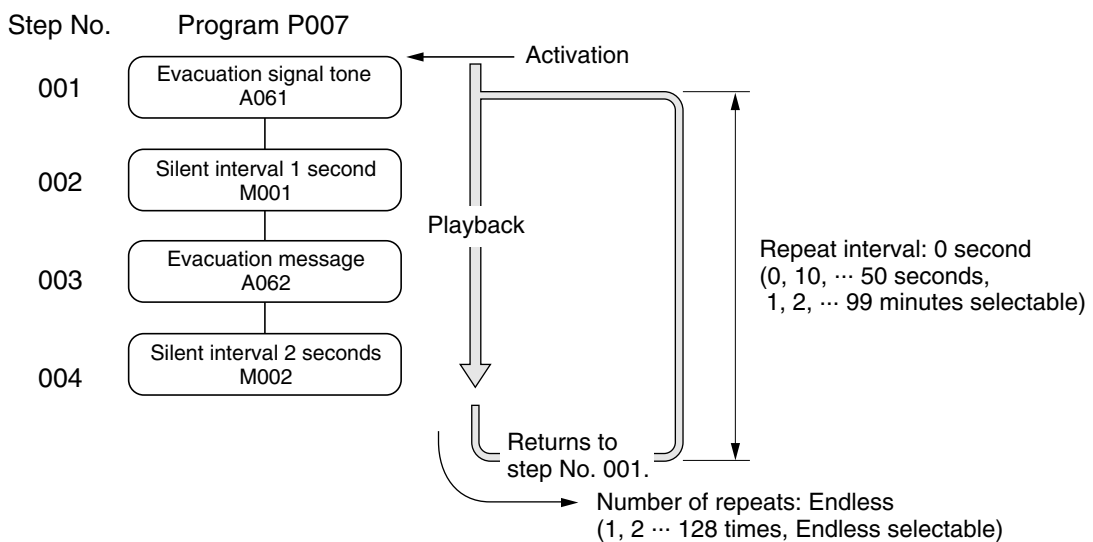



# 28. BLOCK DIAGRAM

[VM-2120/-2240]

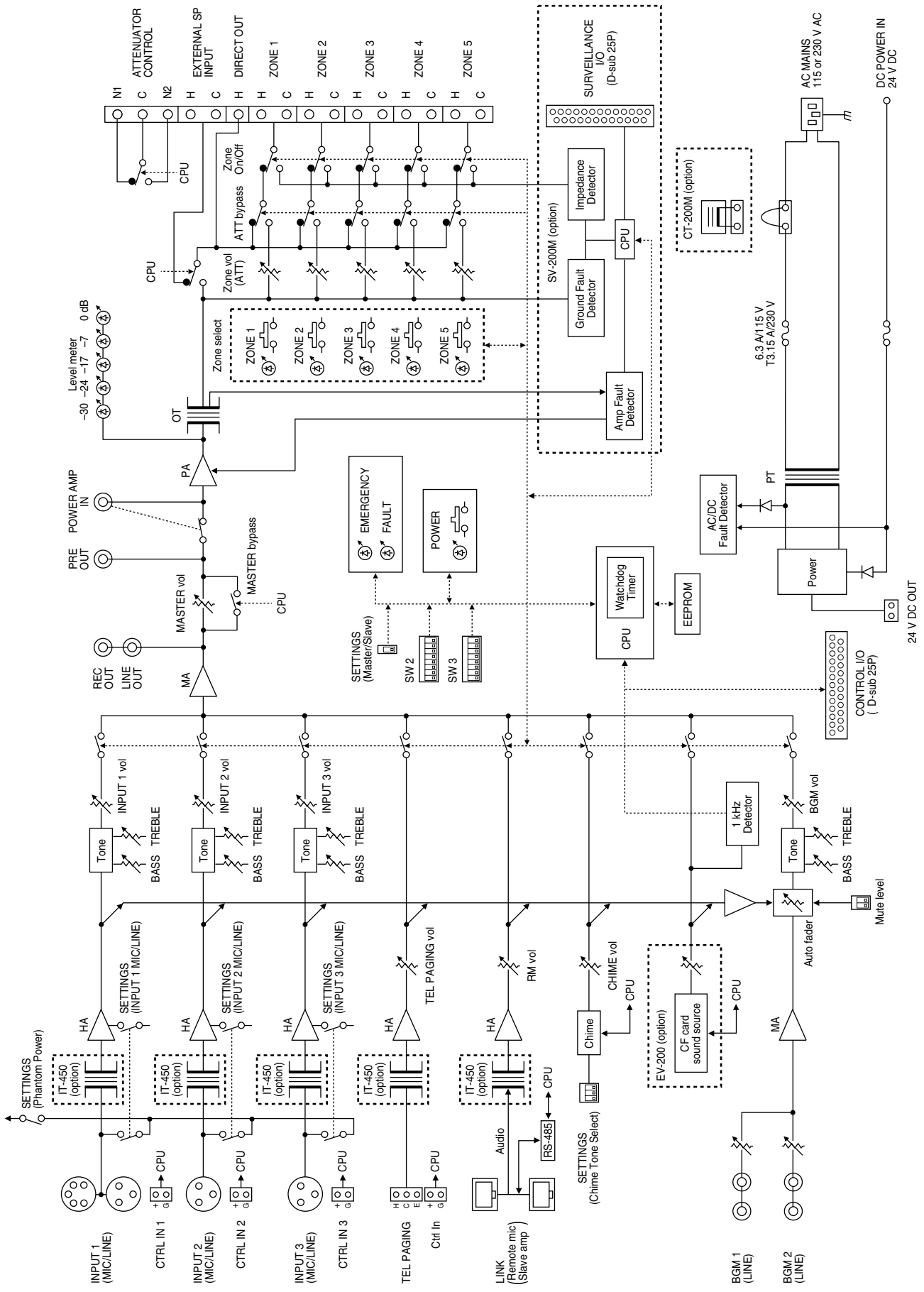

## 29. SPECIFICATIONS

### System Management Amplifier VM-2120/-2240

Model No.	VM-2120	VM-2240
Power Source	AC: 120 V or 230 V AC, 50/60 Hz DC: 24 V DC/7.5 A (VM-2120), 15 A (VM-2240), M3.5 screw terminal, Barrier distance: 8 mm, Applicable cable gauge: AWG22 – AWG14	
Power Consumption on AC Mains	With no signal present	
	37 W	54 W
	Under normal operating conditions according to EN60065: 1998 sec. 4.2	
	107 W	255 W
	With rated output signal	
	201 W	549 W
Current Consumption on 24 V DC Power Input	With no signal present	
	0.7 A	1 A
	Under normal operating conditions according to EN60065: 1998 sec. 4.2	
	2.1 A	5 A
	With rated output signal	
	5.2 A	14 A
Rated Output	120 W	240 W
Output Voltage/Impedance	100 V/83 Ω (changeable to 70 V/42 Ω or 50 V/21 Ω)	100 V/42 Ω (changeable to 70 V/21 Ω or 50 V/10 Ω)
Frequency Response	50 – 16,000 Hz	
Distortion	Under 1%	
Signal-to-Noise Ratio	Over 60 dB	
Tone Control	Bass: 100 Hz ±10 dB, Treble: 10 kHz ±10 dB (Inputs 1 – 3 and BGM individually adjustable.)	
Remote Microphone /Expansion Amplifier Connection	2 RJ45 female connectors for connecting the RM-200M Remote Microphone and the VM-2120 or VM-2240 unit used as an expansion amplifier. Maximum distance: 800 m, Usable cable: Category 5 Shielded Twisted-Pair straight cable (TIA/EIA-568A standard)	
Audio Input	Inputs 1 – 3	–60 dB* <sup>1</sup> (MIC)/–10 dB* <sup>1</sup> (LINE) (changeable), 600 Ω, electronically balanced* <sup>2</sup> , combined XLR connector (female)/phone jack (Only Input 1 is additionally equipped with DIN connector* <sup>3</sup> .)
	Telephone Paging Input	Push-in terminal block* <sup>6</sup> Voice sound: –10 dB* <sup>1</sup> , 10 kΩ, electronically-balanced input with shield terminal* <sup>2</sup> Control: No-voltage make contact input, open voltage: 30 V DC, short-circuit current: under 0.1 A
	BGM 1 – 2	–20 dB* <sup>1</sup> , 10 kΩ, RCA pin jack, monaural
	Power Amplifier Input	0 dB* <sup>1</sup> , 10 kΩ, RCA pin jack
	External Speaker Line Input	100 V line, for All-Zone Broadcast (This input is selected when the "Unit's broadcast cutoff" control is activated.)

To be continued

Model No.		VM-2120	VM-2240
Audio Output	Speaker Output	Rated output (volume control in maximum position), Plug-in screw connector*7	
	Speaker Selector	5-zone selector with attenuator (all zones simultaneously selectable)	
	Direct Speaker Line Output	Direct output from the power amplifier output transformer (attenuator bypassed), Plug-in screw connector*7	
	Line Output	0 dB*1, 10 kΩ, RCA pin jack	
	Recording Output	0 dB*1, 10 kΩ, RCA pin jack	
	Preamplifier Output	0 dB*1, 10 kΩ, RCA pin jack	
Control Inputs 1 – 3		For controlling Inputs 1 – 3, Push-in terminal block No-voltage make contact input, open voltage: 3.3 V DC, short-circuit current: under 1 mA	
Control Input and Output		<p>25-pin female D-sub connector</p> <p>Input: No-voltage make contact input, open voltage: 3.3 V DC, short-circuit current: under 1 mA</p> <p>Output: Open collector output, withstand voltage: 30 V DC, operating current: under 10 mA</p> <p>(1) External control input</p> <ul style="list-style-type: none"> <li>• Activation of messages*4</li> <li>• Activation of power</li> <li>• Activation and stop of Emergency Broadcast</li> <li>• Unit's broadcast cutoff (when activated by an external emergency equipment)</li> </ul> <p>(2) Status output</p> <ul style="list-style-type: none"> <li>• Irregularity of communications with the Remote Microphone and an expansion amplifier</li> <li>• AC power condition</li> <li>• DC power condition</li> <li>• Irregularity of the sound source of the Voice Announcement Board</li> <li>• Failure (FAULT) indication on</li> <li>• Power switch on</li> </ul>	
External Attenuator Control Output		Plug-in screw connector*7, relay, no-voltage make contact output, transfer type, withstand voltage: 30 V DC, 125V AC, contact current: under 7 A (DC), under 7 A (AC)	
Surveillance Input and Output*5		<p>25-pin female D-sub connector</p> <p>Input: No-voltage make contact input, open voltage: 3.3 V DC, short-circuit current: under 1 mA</p> <p>Output: Open collector output, withstand voltage: 30 V DC, operating current: under 10 mA</p>	
Power Supply		24 V DC/0.2 A, for supplying power to an optional Amplifier Control Unit RU-2001/-2002, push-in terminal block*6	
Chime Tone		<p>Built-in chime: 2-tone chime/2-tone chime (fast repeat)/4-tone chime (Up)/Single-tone chime/4-tone chime (Up &amp; Down)/Gong/off</p> <p>Voice Announcement Board sound source: Pre-recorded chime*4</p>	
Cooling Fan		<p>Operates as follows depending on heatsink temperature.</p> <p>Under 50°C: Stop</p> <p>50 – 85°C: Low to High speed (variable)</p> <p>Over 85°C: High speed</p>	

To be continued

Model No.	VM-2120	VM-2240
Function	Two units stacking (VM-2120 or VM-2240) Emergency broadcast (sequential control) Broadcast priority control Surveillance (failure detection) function Power supply to Remote Microphone	
Operating Temperature	0 – 40 °C	
Finish	Panel: ABS resin Case: Steel plate, paint	
Dimensions	419 (w) x 143.3 (h) x 355.7 (d) mm	
Weight	12.5 kg	14.5 kg

\*1 0 dB = 1 V

\*2 Can be transformer-balanced with the addition of an optional IT-450 input transformer.

\*3 For connection of the Paging Microphone PM-660D with a remote control switch

\*4 An optional EV-200 Voice Announcement Board is required.

The messages and chime sound source must be pre-recorded into a CF (CompactFlash) card to be inserted into the EV-200 Board.

\*5 An optional SV-200M Surveillance Board is required.

\*6 Usable cable gauge: AWG26 – AWG20

\*7 Usable cable gauge: AWG24 – AWG12

#### Specifications of the AWG cables

AWG	Diameter (Solid)	Cross-section (Stranded)
12	2.052 mm	3.309 mm <sup>2</sup>
14	1.628 mm	2.082 mm <sup>2</sup>
20	0.8128 mm	0.5189 mm <sup>2</sup>
22	0.6426 mm	0.3243 mm <sup>2</sup>
24	0.5105 mm	0.2047 mm <sup>2</sup>
26	0.4039 mm	0.1281 mm <sup>2</sup>

**Note:** The design and specifications are subject to change without notice for improvement.

## Remote Microphone RM-200M

Power Source	24 V DC (Operating range: 14 – 28 V DC) Power input jack: Non-polarity type Usable power input plug* <sup>3</sup> : Outer diameter ø5.5 mm, inner diameter ø2.1 mm, length 9.5 mm
Current Consumption	100 mA maximum
Distortion	Under 1%
Frequency Response	100 – 20,000 Hz
Signal-to-Noise Ratio	Over 60 dB
Audio Output	0 dB* <sup>1</sup> , 600 Ω, balanced
Microphone	Unidirectional electret condenser microphone
Speaker Control	Zones 1 – 5 or Zones 1 – 10 (2 stacked amplifiers connection* <sup>2</sup> ), Groups 1 – 2, and All-Zone Broadcast
Emergency Broadcast	Activation of Emergency Broadcast (pre-recorded announcement* <sup>2</sup> or live microphone announcement) by Emergency Switch
Voice Message Control	Activation of 5 messages* <sup>2</sup>
No. of Connectable Units	Up to 4
Communication System	RS-485 Control
Volume Control	Microphone volume control
Connection Cable and Connector	Category 5 STP cable, RJ45 connector
Communication Distance	800 m maximum in total
DC Power Supply from Amplifier	Only a single unit can be power-supplied from VM-2120 or VM-2240 amplifier. Line resistance: Under 40 Ω (one way)
Finish	ABS resin
Dimensions	190 (w) x 76.5 (h) x 215 (d) mm (Gooseneck microphone excluded)
Weight	750 g

\*<sup>1</sup> 0 dB = 1 V

\*<sup>2</sup> An optional EV-200 Board must be mounted in the VM-2120 or VM-2240 Amplifier.

The voice messages must be pre-recorded into a CF (CompactFlash) card to be inserted into the EV-200 Board.

\*<sup>3</sup> Suppliable AC adapters

Part name	Part code	Remarks
AD-4800 (US)	100-07-290-70	120 V AC version
AD-4800 (ER)	100-07-291-80	230 V AC version
AD-4800 (BS)	100-07-292-10	
AD-4800 (AS)	100-07-293-60	

**Note:** The design and specifications are subject to change without notice for improvement.

## Remote Microphone Extension RM-210

Current Consumption	20 mA maximum (in terms of RM-200M's DC power input)
Connection	Connection to RM-200M by dedicated cable
Function	Activation of Voice Announcement Board's voice messages when controlling speakers in 10 zones at RM-200M
Finish	ABS resin
Dimensions	110 (w) x 76.5 (h) x 215 (d) mm
Weight	350 g

**Note:** The design and specifications are subject to change without notice for improvement.

## Voice Announcement Board EV-200

Power Source	24 V DC, 0.1 A
Power Consumption	3 W
Output	0 dB*1
Frequency Response	20 – 20,000 Hz (44.1 kHz sampling, 1 kHz reference) 20 – 14,000 Hz (32 kHz sampling, 1 kHz reference)
Distortion	Under 0.3% (44.1 kHz, recording method: Extremely High)
Memory Card	SanDisk*2 CompactFlash*2 card is optionally required.*3 Number of mountable card: 1
Playback Mode	Single source playback
No. of Playback Program	8 programs
Operating Temperature	0 – 50°C
Operating Humidity	Less than 90% (must be free from dew condensation)
Dimensions	120 (w) x 18.6 (h) x 121 (d) mm
Weight	110 g

\*1 0 dB = 1 V

\*2 Trademark of SanDisk Corporation.

\*3 Use the CompactFlash card adapter on the market for recording by the EV-350R.

**Note:** The design and specifications are subject to change without notice for improvement.

### • Accessories

#### System Management amplifier VM-2120/-2240

[120 V AC version]

Miniature type fuse 6.3 A ..... 1

[230 V AC version]

Miniature type time-lag fuse T3.15 A ..... 1

#### Remote microphone RM-200M

RJ45 connection cable (3 m) ..... 1

#### Remote microphone extension RM-210

Extension cable ..... 1

Linkage bracket A ..... 2

Linkage bracket B ..... 1

Screw for linkage bracket ..... 12

#### Voice announcement board EV-200

Mounting screw ..... 2

### • Optional products

#### For both VM-2120 and VM-2240

Rack mounting bracket MB-36

Choke coil CT-200M

Input transformer IT-450

Voice Announcement Board EV-200

Surveillance Board SV-200M





**TOA Corporation**

Download from [www.somanuals.com](http://www.somanuals.com). All Manuals Search And Download.

Printed in Japan  
133-12-726-70



## Free Manuals Download Website

<http://myh66.com>

<http://usermanuals.us>

<http://www.somanuals.com>

<http://www.4manuals.cc>

<http://www.manual-lib.com>

<http://www.404manual.com>

<http://www.luxmanual.com>

<http://aubethermostatmanual.com>

Golf course search by state

<http://golfingnear.com>

Email search by domain

<http://emailbydomain.com>

Auto manuals search

<http://auto.somanuals.com>

TV manuals search

<http://tv.somanuals.com>