

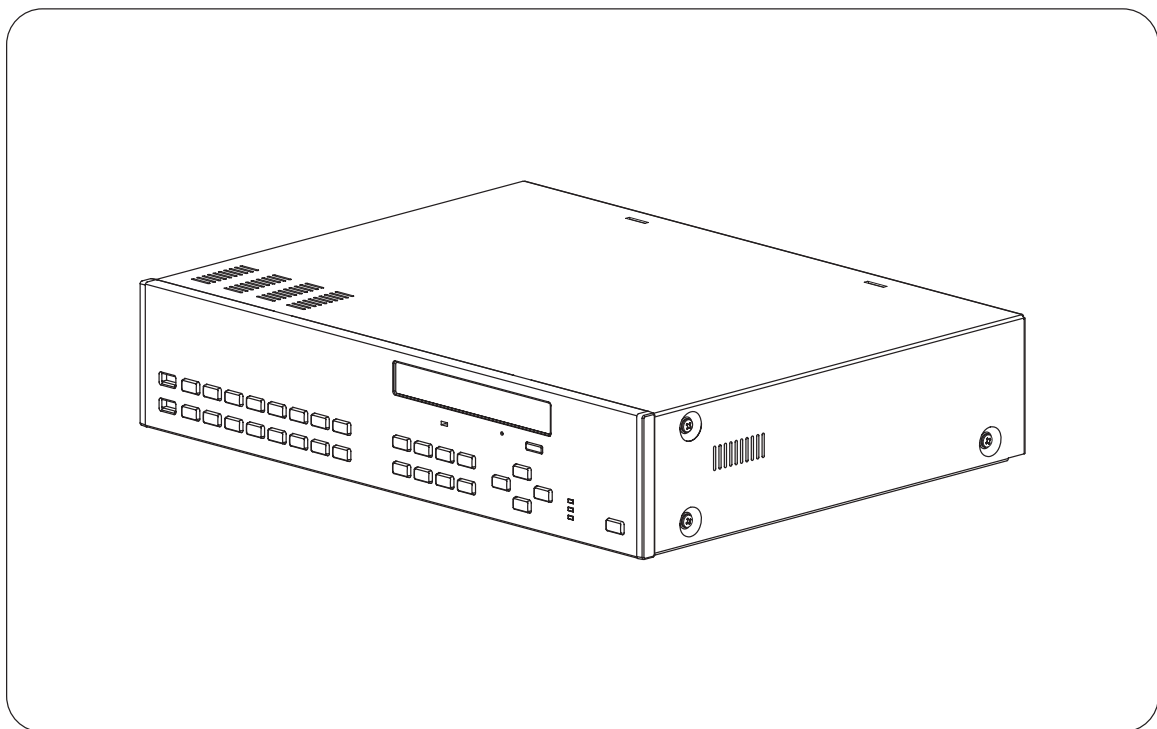

## OPERATING INSTRUCTIONS

### DIGITAL VIDEO RECORDER

### C-DR091 CU Series C-DR161 CU Series



Thank you for purchasing TOA Digital Video Recorder. Please carefully follow the instructions in this manual to ensure long, trouble-free use of your equipment.

TOA Corporation

## TABLE OF CONTENTS

<b>1. SAFETY PRECAUTIONS</b> .....	7
<b>2. HANDLING PRECAUTIONS</b> .....	10
<b>GENERAL DESCRIPTION</b>	
<b>3. GLOSSARY OF TERMS</b> .....	11
<b>4. GENERAL DESCRIPTION</b> .....	12
<b>5. MODEL NUMBER CONFIGURATION</b> .....	12
<b>6. FEATURES</b> .....	12
<b>7. NOMENCLATURE AND FUNCTIONS</b>	
[ Front ] .....	14
[ Rear ] .....	17

## CONNECTIONS

<b>8. RACK MOUNTING</b> .....	19
<b>9. CONNECTIONS</b>	
9.1. Basic System .....	20
9.2. About Star Wiring .....	20
9.3. Digital Video Recorder's Expansion System (Cascade connection) .....	21
<b>10. EXTERNAL TERMINAL CONNECTIONS</b>	
10.1. RS-232C Terminal Communications Specifications .....	23
10.1.1. Communications protocol .....	23
10.1.2. RS-232C Connector pin arrangement .....	23
10.2. Alarm Input Terminal Connections .....	24
10.2.1. Terminal connection .....	24
10.3. Control I/O Terminal Connections .....	25
10.3.1. Time synchronization input/output terminal connections .....	25
10.4. 10BASE-T/100BASE-TX Terminal Connections .....	25

## OPERATION

<b>11. DIGITAL VIDEO RECORDER ACTIVATION AND TERMINATION</b> .....	26
11.1. Recorder's Activation .....	26
11.2. Recorder's Power Off and Disconnect .....	26
<b>12. INITIAL SETTINGS</b>	
12.1. Setting the DVR-ID .....	27
12.2. Clock Settings .....	27
12.3. Hard Disk Initialization .....	28

12.4. Auto-Recording Settings .....	29
12.4.1. Schedule setting .....	29
12.4.2. Setting the group .....	30
12.4.3. Other settings .....	30
<b>13. MONITOR DISPLAY</b>	
13.1. Monitor Switch .....	31
13.2. About Live and Playback Modes .....	31
13.3. Display When In Live Mode .....	32
13.4. Display During Playback .....	33
13.5. Full- Screen Display .....	33
13.6. Multi-Segment Split- Screen Display .....	34
13.7. Sequence Display .....	35
13.8. Zoom Display .....	35
<b>14. OTHER FUNCTIONS</b>	
14.1. Triplex Display .....	36
14.2. Position Setting Display .....	37
<b>15. RECORDING</b>	
15.1. Before Recording .....	38
15.1.1. Disk mode .....	38
15.1.2. Recording order to hard disks .....	38
15.1.3. Disk recording mode .....	39
15.2. Recording Mode .....	39
15.3. Priority Recording .....	39
15.3.1. How to perform priority recording .....	39
15.4. Auto Recording (Alarm Event Recording and Normal Recording) .....	40
15.4.1. Alarm event recording .....	40
15.4.2. Normal recording .....	41
15.5. Pre-Recording .....	41
15.6. Recording State .....	41
15.7. Recording Operation When Edge/Level Settings Are Performed .....	43
15.8. Picture Quality .....	43
15.9. Recording Rate .....	44
15.10. Recording time .....	44
15.11. Available Disk Time and Operation .....	44
<b>16. PLAYBACK</b>	
16.1. Type of Playback .....	45
16.2. How to Perform Playback .....	45
16.2.1. Playback .....	45
16.2.2. Reverse playback .....	45
16.2.3. Playback stop .....	45
16.2.4. Earliest image display .....	46
16.2.5. Latest image reverse playback .....	46
16.2.6. Fast forward/reverse playback .....	46
16.2.7. Pause .....	46
16.2.8. Frame advance/frame reverse playback .....	46
16.3. Event .....	47
16.3.1. Instance event access .....	47

<b>17. SEARCH</b>	
17.1. Date/Time Search .....	48
17.2. Event Search .....	49
17.2.1. Event search list display .....	50
<b>18. ARCHIVE</b> .....	51
18.1. Archiving & Transfer Times .....	52
18.2. Archiving by Entering the Date and Time .....	53
18.3. Archiving from the Playback Screen .....	54
18.4. Display During Archiving .....	55
18.4.1. Display during archiving .....	55
18.4.2. Archiving stop .....	55
18.4.3. Archiving completion .....	55
18.4.4. About error messages .....	56
18.5. When Viewing Saved Data .....	57
18.5.1. PC Operating conditions and image data .....	57
18.5.2. Folder Configuration and File Name .....	57
18.5.3. Playback by way of viewer software .....	58
18.5.4. Tampering/alteration check .....	59
<b>19. ABOUT SECURITY SETTING</b>	
19.1. Securing the Digital Video Recorder's Operating Keys .....	60
19.1.1. Password and operation levels .....	61
19.2. Security Settings Using a USB Key .....	62
19.2.1. USB Key Level Settings and Operation Levels .....	62
19.2.2. USB Key registration .....	62
19.2.3. Resetting the USB Key registration .....	63
19.3. Login and Logout by Password .....	63
19.3.1. Password Entry .....	63
19.3.2. When USB key settings are invalid... ..	63
19.3.3. When USB key settings are valid... ..	64
19.4. Security Settings Against Remote External Access .....	65
19.5. Security Settings Against Web Access .....	65
<b>20. MALFUNCTION OPERATION</b>	
20.1. Stopping the Buzzer .....	66
20.2. Hard Disk Errors .....	66
20.2.1. "Playback stopped" warning display .....	66
20.2.2. "Restart" warning display .....	67
20.2.3. Checking hard disks when an error has occurred .....	67
20.2.4. If a hard disk error occurs .....	67
20.3. Video Loss .....	68
20.3.1. If video loss occurs... ..	68
20.4. Fan Malfunction .....	69
20.4.1. If a fan malfunction occurs... ..	69
20.5. "Hard Disk Full" Warning .....	69
20.5.1. If the hard disk becomes full... ..	69
20.6. Operation Following Restoration From a Power Outage .....	70
20.6.1. Monitor display .....	70
20.6.2. Recording .....	70

# SETTINGS

<b>21. SETTING PROCEDURES AND ITEM LIST</b>	
21.1. Basic Setting Procedures .....	71
21.2. Setting Item List .....	72
<b>22. MAIN MENU SETTING</b>	
22.1. About the Main Menu Setting .....	74
22.1.1. Saving setting .....	75
22.1.2. Implementing setting .....	75
<b>23. RECORDING SETTING</b> .....	76
23.1. Priority Recording Setting .....	77
23.1.1. Recording setting .....	78
23.2. Auto Recording Setting .....	79
23.2.1. Schedule .....	79
23.2.2. Setting of groups A-F .....	80
23.2.3. Special day setting .....	83
23.2.4. Motion detection settings .....	84
23.3. Pre-Recording Settings .....	85
<b>24. SCREEN DISPLAY SETTING</b> .....	86
24.1. Character Display Settings .....	87
24.2. Monitor Output Setting .....	88
24.3. Sequence Setting .....	88
24.4. Camera Name Setting .....	89
24.5. DVR Name Setting .....	89
<b>25. NETWORK SETTING</b> .....	90
<b>26. MAIL SETTING</b> .....	91
26.1. Transmission Condition Setting .....	92
<b>27. SYSTEM SETTING</b> .....	93
27.1. I/O Terminal Mode Setting .....	94
27.2. Control Output Terminal Setting .....	95
27.3. Security Setting .....	96
27.4. Camera Preset Pattern Setting .....	97
<b>28. LOG DISPLAY</b>	
28.1. Recording Log .....	98
28.2. Failure Log .....	99
28.3. System Log .....	99
<b>29. DATE/TIME SETTING</b> .....	100
<b>30. EQUIPMENT MAINTENANCE</b> .....	101
30.1. Hard Disk Drive Initialization .....	102

## WEB FUNCTIONS

### 31. WEB SERVER FUNCTIONS

31.1. About the Functions .....	103
31.2. System Requirements .....	103
31.3. How to Log In .....	104
31.3.1. Access inhibit .....	104
31.4. Top Page .....	105
31.4.1. For administrator account .....	105
31.4.2. For user account .....	105
31.5. Menu Screen .....	106
31.5.1. Menu screen setting .....	106
31.6. Live Image Transmission .....	107
31.6.1. For administrator account .....	107
31.6.2. For user account .....	107
31.6.3. Screen change button .....	108
31.6.4. Camera control section .....	108
31.7. Playback Transmission .....	110
31.7.1. Playback Operations .....	111
31.7.2. Searching .....	111
31.7.3. Download .....	112
31.7.4. Duplex display .....	113
31.8. Remote control .....	114
31.9. Web Indication setting .....	115

## ADDITIONAL INFORMATION

### 32. RECORDING TIME TABLE

32.1. About Picture Quality Settings During Recording .....	116
---	-----

### 33. TROUBLESHOOTING .....

### 34. INDEX .....

### 35. SPECIFICATIONS .....

# 1. SAFETY PRECAUTIONS

- Before installation or use, be sure to carefully read all the instructions in this section for correct and safe operation.
- Make sure to observe the instructions in this manual as the conventions of safety symbols and messages regarded as very important precautions are included.
- We also recommend you keep this instruction manual handy for future reference.

## Safety Symbol and Message Conventions

Safety symbols and messages described below are used in this manual to prevent bodily injury and property damage which could result from mishandling. Before operating your product, read this manual first and understand the safety symbols and messages so you are thoroughly aware of the potential safety hazards.



### **WARNING**

Do not expose the unit to rain or an environment where it may be splashed by water or other liquids, as doing so may result in fire or electric shock.



### **WARNING**

Indicates a potentially hazardous situation which, if mishandled, could result in death or serious personal injury.

### When Installing the Unit

- This is a class A product. In a domestic environment this product may cause radio interference in which case the user may be required to take adequate measures.
- Use the unit only with the voltage specified on the unit. Using a voltage higher than that which is specified may result in fire or electric shock.
- Do not cut, kink, otherwise damage nor modify the power supply cord. In addition, avoid using the power cord in close proximity to heaters, and never place heavy objects -- including the unit itself -- on the power cord, as doing so may result in fire or electric shock.
- Avoid installing or mounting the unit in unstable locations, such as on a rickety table or a slanted surface. Doing so may result in the unit falling down and causing personal injury and/or property damage.

### When the Unit is in Use

- If any of the following irregularities occurs, immediately switch off the power, disconnect the power supply plug from the AC outlet and inform the shop from where the unit was purchased. Further using the unit may result in fire or electric shock.
  - If you detect smoke or a strange smell coming from the unit
  - If water or any metallic object gets into the unit
  - If the unit falls, or the unit case breaks
  - If the power supply cord is damaged (exposure of the core, disconnection, etc.)
  - If no image appears
- To prevent a fire or electric shock, never open the unit case nor modify the unit as there are high voltage components inside the unit. Refer all servicing to your nearest TOA dealer.
- Do not place cups, bowls, or other containers of liquid or metallic objects on top of the unit. If they accidentally spill into the unit, this may cause a fire or electric shock.
- Do not insert nor drop metallic objects or flammable materials in the ventilation slots of the unit's cover, as this may result in fire or electric shock.
- Do not touch the power supply plug or control line during thunder and lightning, as this may result in electric shock.



## CAUTION

Indicates a potentially hazardous situation which, if mishandled, could result in moderate or minor personal injury, and/or property damage.

### When Installing the Unit

- Never plug in nor remove the power supply plug with wet hands, as doing so may cause electric shock.
- When unplugging the power supply cord, be sure to grasp the power supply plug; never pull on the cord itself. Operating the unit with a damaged power supply cord may cause a fire or electric shock. When removing the power cord, be sure to hold its plug to pull.
- When moving the unit, be sure to remove its power supply cord from the wall outlet. Moving the unit with the power supply cord connected to the outlet may cause damage to the power supply cord, resulting in fire or electric shock.
- Do not block the ventilation slots in the unit's cover. Doing so may cause heat to build up inside the unit and result in fire.
- Avoid installing the unit in humid or dusty locations, in locations exposed to the direct sunlight, near the heaters, or in locations generating sooty smoke or steam as doing otherwise may result in fire or electric shock.
- Do not connect a network terminal exposed to excessive voltage to the 100BASE-TX terminal, Hard disk expansion unit connection terminal or Remote control I/O terminal A, as doing so may result in fire or electric shock.

### When the Unit is in Use

- Do not place heavy objects on the unit as this may cause it to fall or break which may result in personal injury and/or property damage. In addition, the object itself may fall off and cause injury and/or damage.
- Clean the unit periodically. Contact your TOA dealer regarding the cleaning. If dust is allowed to accumulate in the unit over a long period of time, a fire may result.
- If dust accumulates on the power supply plug or in the wall AC outlet, a fire may result. Clean it periodically. In addition, insert the plug in the wall outlet securely.
- Switch off the power, and disconnect the power supply plug from the AC outlet when cleaning or leaving the unit unused for long periods of time. Doing otherwise may cause a fire or electric shock.

The equipment must be connected to an earthed mains socket-outlet.

-Finland

"Laitte on liitettävä suojamaadoituskoskettimilla varustettuun pistorasiaan"

-Norway

"Apparatet må tilkoples jordet stikkontakt"

-Sweden

"Apparaten skall anslutas till jordat uttag"



CU version complies with Part 15 of the FCC Rules.

**Note**

This equipment has been tested and found to comply with the limits for a Class A digital device, pursuant to Part 15 of the FCC Rules. These limits are designed to provide reasonable protection against harmful interference when the equipment is operated in a commercial environment. This equipment generates, uses, and can radiate radio frequency energy and, if not installed and used in accordance with the instruction manual, may cause harmful interference to radio communications. Operation of this equipment in a residential area is likely to cause harmful interference in which case the user will be required to correct the interference at his own expense.

**Modifications**

Any modifications made to this device that are not approved by TOA Corporation may void the authority granted to the user by the FCC to operate this equipment.

This equipment is classified as a LASER CLASS 1 PRODUCT. The following classification label is located on the drive.

CLASS 1 LASER PRODUCT  
CAUTION:  
INVISIBLE LASER RADIATION WHEN OPEN.  
AVOID EXPOSURE TO BEAM.

## 2. HANDLING PRECAUTIONS

- The supplied power supply cord is designed for exclusive use with the Digital Video Recorder. Never use it with other equipment.
- Do not connect the 10BASE-T/100BASE-TX terminal, Hard disk expansion unit connection terminal or Remote control I/O terminal A to networks that could be exposed to excessive electrical voltage. Failure to follow this instruction could result in electric shock or fire.
- It is recommended that the Recorder be always used in locations where the ambient temperature ranges from +5°C to +40°C (41°F to 104°F) and humidity levels of less than 80% to ensure that no condensation is formed.
- When moving the Recorder, first disconnect its power supply plug from the AC outlet and then wait at least 30 seconds before moving.
- Avoid moving the Recorder suddenly from a cold location to a warm location, or installing it in close proximity to an air-conditioner outlet, as internal condensation could result. When condensation occurs, do not switch on the power until the Recorder has sufficiently dried. Also, when brought into a warm room from the cold outdoors, be sure to leave it unused for at least half a day before using it.
- Avoid installing the Recorder in humid or dusty locations, or in locations exposed to direct sunlight, sooty smoke or steam. Note that even in locations which are not particularly dusty, dust may accumulate at the Recorder's ventilation slots. Because this could cause an extreme rise in temperature inside the Recorder, be sure to clean the ventilation slots periodically after switching off the power and disconnecting the power supply plug from the AC outlet. It is highly recommended that the ventilation slots be cleaned once a year.
- When cleaning the Recorder, be sure to switch off the power. Wipe with a soft dry cloth. If it gets very dirty, use the soft cloth slightly moistened in neutral cleanser. Never use volatile spirits like thinner, benzine, or alcohol. Such chemicals may damage its plastic surface.
- Do not block the ventilation slots or cooling fan, which could cause the temperature inside the Recorder to rise, possibly resulting in unit failure. Install the Recorder at least 100 mm (3.9 inch) away from the nearest wall surface.
- Since the Recorder is equipped with a cooling fan, a motor sound is generated. Avoid installing the Digital Video Recorder in locations which resonate electrical motor noise.
- Do not install the Recorder in locations influenced by strong electrical or magnetic fields, as monitor screen pictures may become distorted or the Recorder could fail.
- The Recorder can be used only in a commercial and industrial area. Operation of this equipment in a residential area is likely to cause radio disturbance and TV interference.
- Avoid jarring or striking the Recorder. The Recorder is a piece of precision equipment and accidentally dropping it or subjecting it to strong impacts could cause its failure. When transporting the Recorder, carefully pack it in the supplied carton to protect it from shock.
- Avoid using the Recorder in locations exposed to vibration. The Recorder is a piece of precision equipment, as this may cause the unit malfunction.
- Avoid installing the Recorder vertically or tilting it at extreme angles, since it is designed to be used in a horizontal position only.
- About the hard disks
  - If the hard disk fails, recorded data cannot be restored.
  - Save important recordings to DVD-R/RW disks.
  - Recordings copied from video images or video recordings with registered copyrights may not be used for commercial purposes other than for private use without express permission from the copyright holder.

- TOA takes no responsibility for any incidental damage, such as loss of sales opportunities, that may result.
- Avoid using the camera in line-locked mode. Failure to do so may cause the displayed camera images to flicker. Also, video may be lost if power frequency fluctuates significantly.

### 3. GLOSSARY OF TERMS

#### **Triplex**

This function permits recording while viewing live and recorded images in multi-screen display. In Triplex setting, individual live or recorded images can be set to be displayed on individual split-screen segments.

#### **Pre-Recording**

Retroactive recordings can be made for up to 5 minutes before the occurrence of an alarm event (alarm signal input or motion movement) or priority recording, even if no recording is currently in progress.

#### **Mirror Recording**

Recording can be simultaneously made on 2 hard disks. Even if one hard disk should fail, the other hard disk continues to record or play back.

#### **Master and Slave Units**

When synchronizing the Digital Video Recorders, one can be designated as a master unit, which can be used to control the other slave units.

#### **Normal Mode**

When the first hard disk finishes recording, the second hard disk automatically begins to record. When the settings (recording rate and picture quality) of both normal and mirror modes are set to be identical, the recording time for normal mode is twice that of mirror mode.

#### **Alarm Event Recording**

Refers to both alarm recording and motion detected recording. Alarm recording is performed when the alarm input terminal of the Digital Video Recorder or Combination Camera receives a signal. Motion detected recording begins when movement is detected in the camera image.

#### **Recording Rate (IPS)**

Refers to the number of image frames to be recorded per second. The unit is IPS. The larger IPS value is, the shorter recording intervals can become.

#### **Event**

Recording data from the start to the end of recording mode (Priority recording, Alarm Event recording and Normal recording) is expressed as one event.

#### **Post time**

Set the time until the hard disk finished recording.

#### **Schedule**

The Digital Video Recorder's auto-recording mode allows recording to be made according to a preset schedule.

#### **Live mode**

Mode displaying current live camera images.

#### **Playback mode**

Mode displaying recorded camera images.

## 4. GENERAL DESCRIPTION

TOA's C-DR Series Digital Video Recorders feature a digital compression method that permits camera images to be recorded on an internal hard disk. The C-DR091 Series is designed for 9 channels, while the C-DR161 Series can be used for up to 16 channels.

It can simultaneously play back recorded camera images while continuing to record images onto the hard disk.

Mounting in EIA-Standard equipment racks can also be easily performed with the addition of optional rack mounting brackets.

## 5. MODEL NUMBER CONFIGURATION

A total of 16 type variations are available depending on the combination of hard disk capacity and DVD drive availability.

For model numbers and hard disk capacity, please refer to the following table.

C - DR 1 6 1 D 0 8		9 channels	16 channels	Hard disk capacity
08 : 80 GB 1 : 160 GB 3 : 320 GB 6 : 600 GB	D : With DVD - : Without DVD	C-DR091D08	C-DR161D08	80 GB × 1
		C-DR091-08	C-DR161-08	80 GB × 1
09 : for 9 channels 16 : for 16 channels		C-DR091D1	C-DR161D1	160 GB × 1
		C-DR091-1	C-DR161-1	160 GB × 1
		C-DR091D3	C-DR161D3	160 GB × 2
		C-DR091-3	C-DR161-3	160 GB × 2
		C-DR091D6	C-DR161D6	300 GB × 2
		C-DR091-6	C-DR161-6	300 GB × 2

## 6. FEATURES

- **Simultaneous Recording/Playback Function**

Recorded images can be played back without interrupting recording.

- **Triplex (Recording + Playback + Live Image) Function**

Live and recorded images can be simultaneously viewed during recording in multi-screen display.

- **Pre-Recording**

Retroactive recordings can be made for up to 5 minutes before the occurrence of an alarm event (alarm signal input or motion movement) or priority recording, even if no recording is currently in progress.

- **Speed Search Function**

Date/time Search and Event Search functions permit desired scenes to be quickly found and viewed.

- **Mirroring Recording**

Mirroring Recording function performs the simultaneous recording of data onto the two hard disks. Even if one of the disks fails, recording and playback can still be performed using the other disk. For models with a single hard disk (versions with model number suffix -08, -1, D08 or D1), the mirror mode is available only when the hard disk expansion unit is connected.

The possibility of data loss due to hard disk failure is greatly reduced, increasing reliability.

- **High Picture Quality and High Frame Rate**

Recording and playback can be simultaneously performed at a maximum of 120 IPS. (Image compression method: Motion-JPEG.) Picture quality can be adjusted in five levels, allowing high quality recording or extended recording according to the intended purpose of use. Picture quality and recording intervals can be freely set for individual cameras and recording system.

- **Auto-recording**

The Digital Video Recorder starts recording shortly after power on and makes recordings by preset schedule. The auto-recording function permits Normal recording and Alarm event recording, for each of which different setting can be performed. (Refer to [p. 79](#); Auto-recording setting.)

- **Network Function**

Use this function to remotely monitor or control cameras connected to the Digital Video Recorder, or search or play back their recorded images on a PC web browser.

- **Email Function**

Email can be transmitted when an alarm event or failure occurs. Up to 4 destination addresses can be programmed.

- **Cascade Connections**

Cascade-connecting 8 Digital Video Recorders permits camera images of up to 128 cameras to be viewed on a single monitor display. Up to 4 C-RM1000 Remote Controllers can be connected in a system, allowing each controller to control all Digital Video Recorders and Combination Cameras. (Refer to [p. 20](#); Connections.)

- **Archive Function**

Recorded images can be copied onto the DVD-R/RW (available to model with DVD) or to the USB memory. Viewer software is also downloaded at the same time. (Refer to [p. 51](#); Archive.)

- **Security Function**

Two security settings, using a password and USB key lock, are made available. The use of both methods ensures the highest security. (Refer to [p. 60](#); About security setting.)

- **Hard disk expansion**

Up to 2 Hard Disk Expansion units of C-DA1000-1 (1.2 TB) and/or C-DA1000-2 (2.4 TB) can be connected per Digital Video Recorder. UP to 4.8 TB can be added to the Digital Video Recorder's hard disk capacity.

## 7. NOMENCLATURE AND FUNCTIONS

### [ C-DR161 Series Front ]

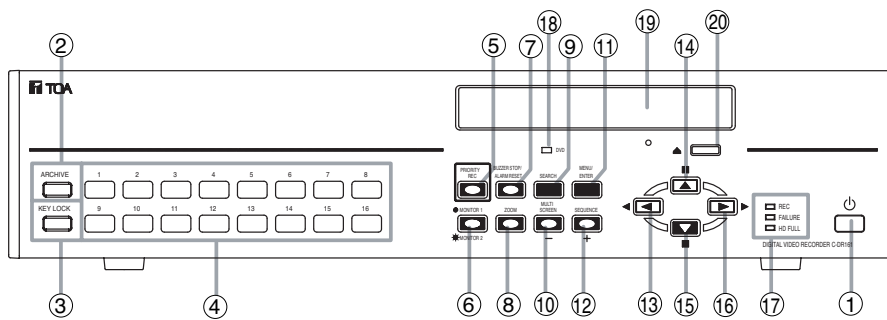

### [ C-DR091 Series Front ]

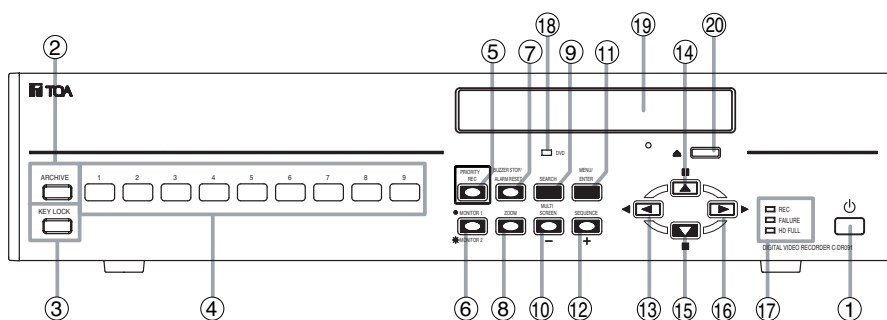

#### (1) Power key [⏻]

Pressing the Power key changes the Digital Video Recorder's mode from standby to operation mode. To switch from operation mode to standby mode, hold down the Power key for 2 seconds or more. (Refer to p. 26; Digital Video Recorder Activation and Termination.)

#### (2) Archive Terminal

Use this terminal when copying video data recorded on a hard disk to a USB memory. (Refer to p. 51; Archive.)

#### (3) Key lock terminal

Insert the preprogrammed USB key into this terminal to cancel the security lock setting. (Refer to p. 60; Securing the Digital Video Recorder's Operating Keys.)

#### (4) Camera selector key

Selects cameras displayed on the live or playback screens. Pressing the Camera selector key displays the corresponding camera image on the full screen.

#### (5) Priority recording key

Used to start priority recording. To stop priority recording, hold down the Priority recording key for 2 seconds or more. The Priority recording key flashes red during priority recording. (Refer to p. 39; Priority Recording.)

#### (6) Monitor key

Use this key when switching operation between Monitor 1 and Monitor 2 outputs.

This key lights when pressed, and extinguishes when pressed again. Monitor 1 output is enabled when the key is unlit, and Monitor 2 output is enabled when the key is lit. Monitor 2 output can be operated with the Camera selector keys, Multi-screen key, and Sequence key. (Refer to p. 31; Monitor display.)

#### (7) Buzzer stop key (Alarm reset key)

When priority recording, equipment failure, or alarm event recording takes place, a buzzer sounds. Pressing this key disables the buzzer. Use this key to reset alarm event recording. Hold down this key for 2 seconds or more to reset alarm event recording.

#### (8) Zoom key

Use the Zoom key to zoom in on the live and playback screens (2x zoom). If this key is pressed during full-screen display, the cursor for determining the zoom position is displayed. If the zoom position is confirmed and the Menu key is pressed, the 2X zoomed screen is displayed. Pressing this key again cancels the zoom mode. (Refer to p. 35; Zoom Display.)

### (9) Search key

Use this key to search for recorded images. If the Search key is pressed when the live or playback screen is displayed, the search screen is displayed. To exit the search screen, press the [◀] key. (Refer to p. 48; Search.)

### (10) Multi-Screen / [-] Key

#### • Multi-screen display

Displays live or recorded camera images on the multi-segment split screen. The screen switches to 4-segment, 9-segment and 16-segment split screen displays with each depression of this key. (Refer to p. 34; Multi-Segment Split-Screen Display.)

#### • Reverse setting value selection [-]

Pressing this key while setting values are selected on the menu screen varies setting values in the reverse direction.

#### • Triplex setting screen activation

If the Multi-Screen key is continuously pressed for 2 seconds or more while the multi-segment split screen is displayed, the Triplex setting screen is displayed. To exit the Setting screen, hold down the Menu key for 2 seconds or more. (Refer to p. 36; Triplex display.)

#### • Position setting screen activation

If the Multi-screen key is continuously pressed for 2 seconds or more while multi-split screen is displayed in the Live mode, the Position setting screen is displayed. To exit the Setting screen, hold down the Menu key for 2 seconds or more. (Refer to p. 37; Position setting display.)

### (11) Menu key

#### • Activating the Menu screen

Holding down the Menu key for 2 seconds or more when the Monitor key remains unlit displays the menu screen on the Monitor 1 screen. To return to live mode, press the [◀] key. (Refer to p. 74; Main menu setting.)

#### • Menu item confirmation

Use this key when confirming selected setting items on the menu screen, such as "Yes," "No" or "Execute." (Refer to p. 74; Main menu setting.)

#### • Advancing to the next menu setting screen

Press this key when advancing from the position indicated by the ▶ mark on the menu setting screen to the next menu setting screen. (Refer to p. 74; Main menu setting.)

#### • Exiting the motion setting screen

Hold down the Menu key for 2 seconds or more to exit the motion detection setting on the menu screen. (Refer to p. 84; Motion detection settings.)

#### • Activating the Password entry screen

Holding down the Menu key for 2 seconds or more when the Security setting is activated displays the Password entry screen. (Refer to p. 96; Security setting.)

### (12) Sequence/ [ + ] Key

#### • Sequence

Pressing the Sequence key in live mode causes the camera outputs to be displayed in preprogrammed sequential order. (Refer to p. 35; Sequence Display.)

#### • Forwarding [+] the setting value

Pressing the setting value on the Menu screen during selection changes the setting value in forward direction.

### (13) Reverse playback [◀] key

#### • Reverse playback

Images are played back in reverse if the Reverse playback key is pressed. (Refer to p. 45; Playback.)

#### • Moving the cursor to the left on the menu screen

Use this key to move the cursor to the left on the menu screen.

#### • Returning the Menu screen to the previous screen

Pressing the [◀] key when the cursor positions to the left on the Menu screen returns the display to the previous screen.

#### • Returning to the live mode

Pressing the [◀] key on the Menu screen returns the display to the live mode.

### (14) Pause [■ , ▲] key

#### • Pause of playback/reverse playback screens

Use this key to temporarily stop the playback display. Operation can be performed for the archive menu display, frame advance/reverse playback, and instant event access playback while the display is temporarily stopped. (Refer to p. 51; Archive.) (Refer to p. 45; Playback.)

#### • Moving the cursor upward on the Menu screen

Used this key to move the cursor upward on the Menu screen.

### (15) Stop [■ , ▼] key

#### • Stop of playback/reverse playback

Use this key to stop playback or reverse playback. (Refer to p. 45; Playback.)

#### Note

Recording does not stop even if the Stop key is pressed.

- **Moving the cursor downward on the Menu screen**

Use this key to move the cursor downward on the Menu screen.

**(16) Playback [  ] key**

Pressing the Playback key plays back recorded images. (Refer to [p. 45](#); Playback.)

- **Moving the cursor to the right on the Menu screen**

Use this key to move the cursor to the right on the Menu screen.

**(17) Informational Indicator**

- **Recording indicator**

Lights during recording (Priority recording, Normal recording, Alarm Event recording)

- **Failure indicator**

Flashes when video is lost or when a fan or hard disk failure occurs. Refer to the failure log on the menu screen for the cause of each equipment failure. The LED flashes until the Recorder returns to normal state.

- **Available hard disk space indicator**

Flashes when the available disk space falls below the specified warning level while in write protect mode and when the available disk spaces runs out of time. This indicator does not light (flash) while in overwrite mode. (Refer to [p. 93](#); System setting.)

**(18) DVD indicator**

Flashes when the DVD-R/RW is inserted and while the inserted disk is being recognized, and continuously lights while the disk is being written.

**(19) DVD receptacle**

Place a DVD-R/RW here when copying data recorded on the Digital Video Recorder.

**(20) DVD eject Key**

Use this key to insert or eject a DVD-R/RW.



## [C-DR161 series Rear]

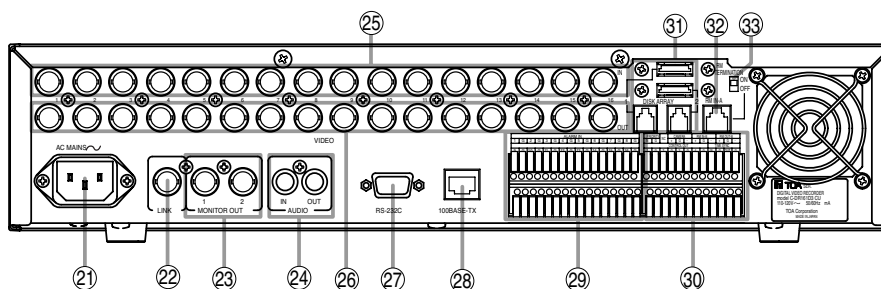

## [C-DR091 series Rear]

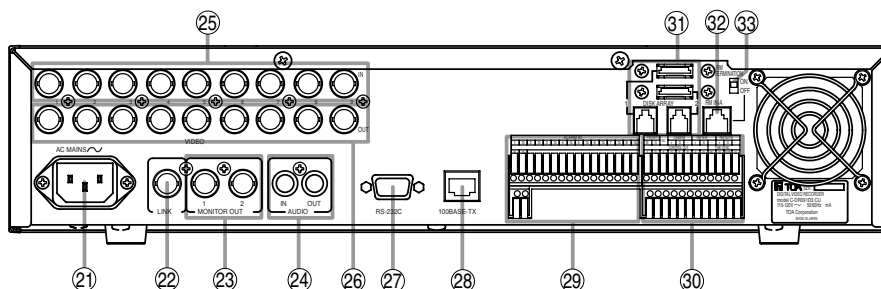

### (21) AC inlet

Connect the supplied power cord to this socket.

### (22) Link input terminal

Use this terminal to cascade-connect two or more Digital Video Recorders. (Refer to p. 21; Digital Video Recorder's Expansion system.)

### (23) Monitor output terminal

#### • Monitor 1 output terminal

Outputs the Monitor 1's camera images.

#### • Monitor 2 output terminal

Outputs Monitor 2's camera images. Live images can be displayed in full-screen or 4-segment split-screen display. Reproduced images cannot be output.

### (24) Audio input/output terminal

#### • Audio input terminal

This terminal is used for audio recording.

#### • Audio output terminal

Outputs audio input terminal signals during live screen display, and outputs the recorded audio during playback display.

### (25) Video input terminal

Connect the camera to this terminal. Connecting the camera automatically terminates the Digital Video Recorder at 75 Ω.

### (26) Video output terminal

A loop through output for the Video input terminal. Connecting the BNC plug to the Video output terminal automatically cancels the 75Ω termination.

### (27) RS-232C terminal

Connect this terminal to a computer's RS-232C terminal when performing control from a personal computer. Connect this terminal to the PC's RS-232C terminal using a nullmodem cable. (Refer to p. 23; RS-232C Terminal communications specifications.)

### (28) 10BASE-T/100BASE-TX terminal

Use this terminal to remotely monitor or control cameras connected to the Digital Video Recorder, or search or play back their recorded images on a PC web browser.

### (29) Alarm input terminal

Use this terminal to make Alarm event recording. Connect no-voltage contact signals of sensors, etc. to this terminal.

(Refer to p. 24; Alarm Input Terminal Connections.) (Refer to p. 94; I/O Terminal mode setting.)

### **(30) Control input/output terminal**

#### **• Control output terminal**

Outputs a signal during priority recording, alarm recording or motion detected recording or when video is lost, the hard disk is full or equipment failure occurs. (Refer to [p. 95](#); Control output terminal setting.)

#### **• Priority recording input terminal**

Use this terminal to begin Priority recording using signals from connected external equipment. Connect no-voltage contact signals of switches, etc. to this terminal.

#### **• Time sync input & output terminal**

Use this terminal to synchronize the clocks of multiple Digital Video Recorders used in the system. Connect the master Recorder's Time sync output to the slave Recorder's Time sync input. Time sync settings must be performed on the menu screen. (Refer to [p. 23](#); External terminal connections.)

#### **• Remote Control Input/Output Terminal B**

Use this terminal for connection of the C-RM1000 Remote Controller. Note the correct polarity (positive and negative orientation). Use the Remote control input & output terminal B if the cable distance is longer than 3 meters (9.8 ft). (Refer to [p. 20](#); Connections)

Also use this terminal to cascade-connect the Digital Video Recorder. Connect the first Digital Video Recorder's Remote control output terminal to the second Recorder's Remote control input terminal. Note the correct polarity. (Refer to [p. 21](#); Digital Video Recorder's Expansion system.)

#### **• Camera control terminal**

Use this terminal to control the Combination Camera. Connect this terminal to the camera's control terminal (RS-485). Note the correct polarity. (Refer to [p. 20](#); Connections)

#### **Note**

The C-RM1000 Remote Controller must be connected to the Digital Video Recorder in order to control the Combination Camera.

### **(31) Hard disk expansion unit connection terminal**

This terminal is used for hard disk expansion unit connection. Up to 2 hard disk expansion units can be connected to this terminal.

### **(32) Remote controller input terminal A ( Power can be supplied.)**

Use this terminal to connect the C-RM1000 Remote Controller. Use the supplied cable for connection if the distance to the controller is shorter than 3 meters (9.8 ft). Power is supplied to the Remote Controller from the Digital Video Recorder if this terminal is used.

### **(33) Termination switch**

Terminal switch for Remote Control input & output terminals A and B.

The ON position terminates the connection at 220Ω. The 220Ω termination is not available when this switch is set to the OFF position.

## 8. RACK MOUNTING

Use the optional MB-23B Rack Mounting Bracket when mounting the Digital Video Recorder in an equipment rack. Remove 4 rubber feet on the bottom surface by loosening their respective fixing screws with a standard screwdriver.

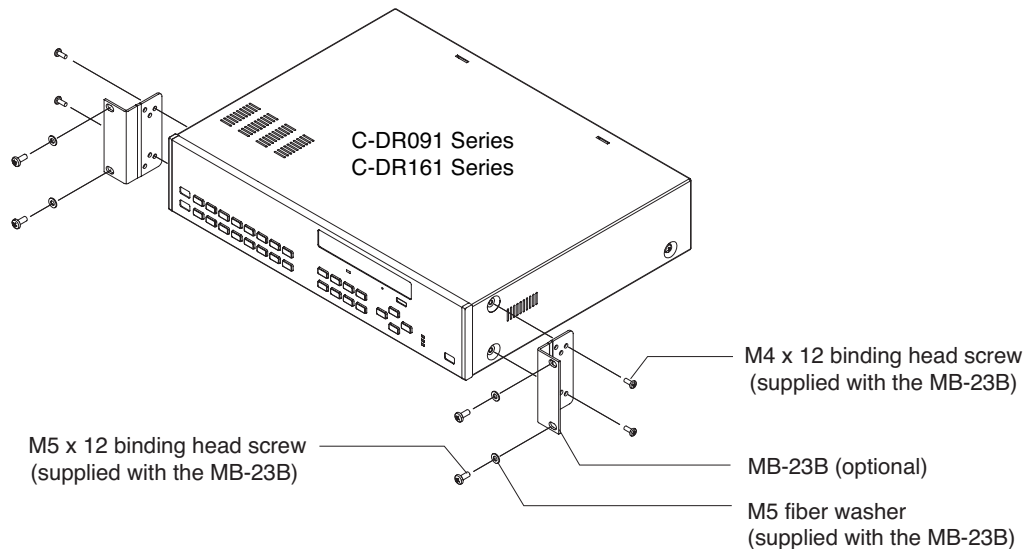

### Note

- Use the Digital Video Recorder in locations with ambient temperature of between +5°C and +40°C (41°F and 104°F). When rack-mounting the Digital Video Recorder, the ambient temperature must be kept 35°C (95°F) or below.
- Be sure to mount the Digital Video Recorder below the heat generating components, and mount the perforated panel between the Recorder and such a heat generating component as required.
- The Digital Video Recorder has a built-in cooling fan. Never block the Recorder's ventilation slot.
- Avoid installing the Digital Video Recorder in locations exposed to vibration.

- a) Elevated Operating Ambient Temperature - If installed in a closed or multi-unit rack assembly, the operating ambient temperature of the rack environment may be greater than room ambient. Therefore, consideration should be given to installing the equipment in an environment compatible with the manufacturer's maximum rated ambient temperature (T<sub>mra</sub>).
- b) Reduced Air Flow - Installation of the equipment in a rack should be such that the amount of air flow required for safe operation of the equipment is not compromised.
- c) Mechanical Loading - Mounting of the equipment in the rack should be such that a hazardous condition is not achieved due to uneven mechanical loading.
- d) Circuit Overloading - Consideration should be given to the connection of the equipment to the supply circuit and the effect that overloading of circuits might have on overcurrent protection and supply wiring. Appropriate consideration of equipment nameplate ratings should be used when addressing this concern.
- e) Reliable Earthing - Reliable earthing of rack-mounted equipment should be maintained. Particular attention should be given to supply connections other than direct connections to the branch circuit (e.g., use of power strips).

## 9. CONNECTIONS

### 9.1. Basic System

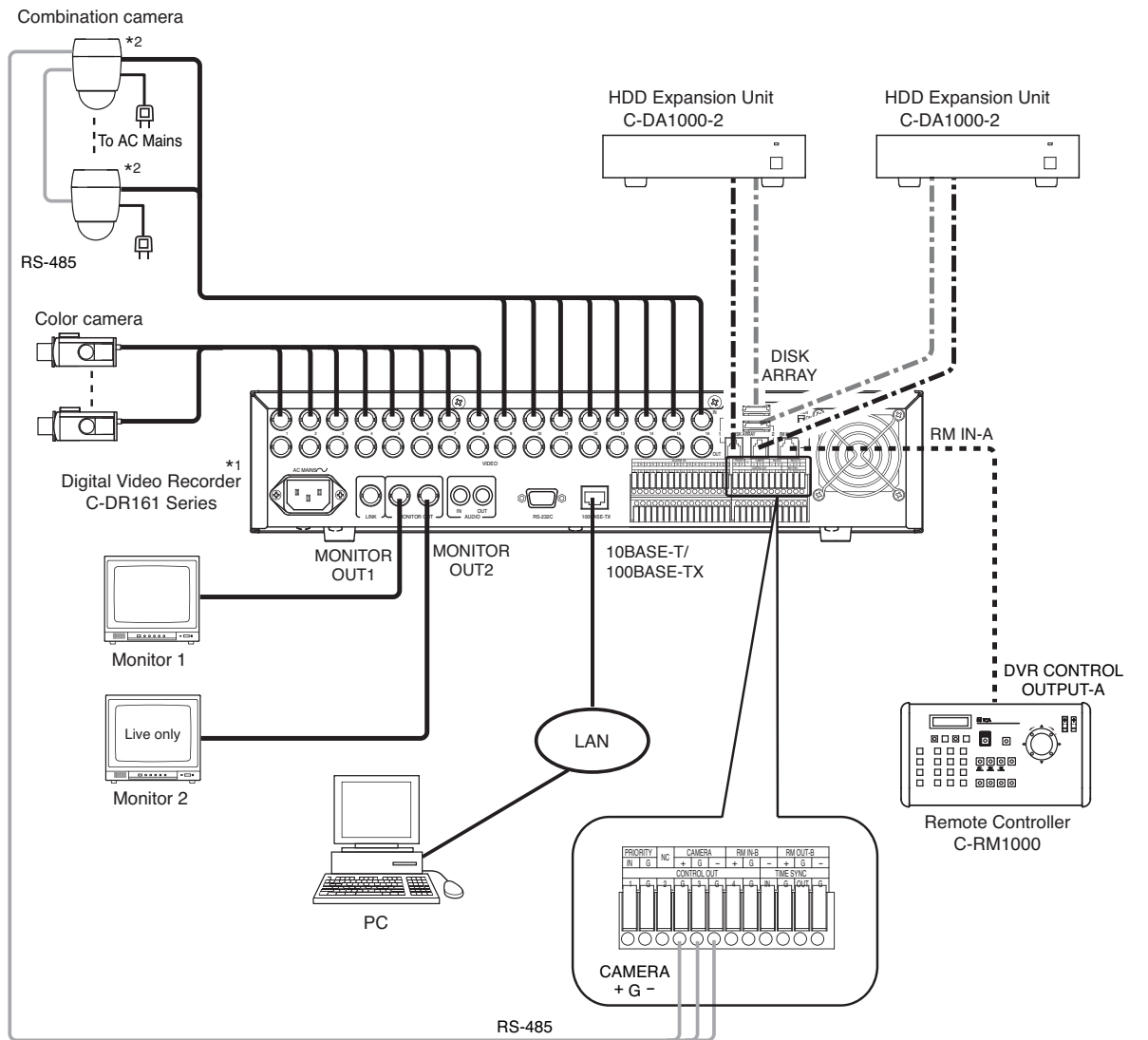

\*1 C-DR091 and C-DR161 Series  
 C-DR091: 9 I/O Terminals  
 C-DR161: 16 I/O Terminals

\*2 Match the Combination Camera's address to the Digital Video Recorder's video input number.

- : Coaxial cable (Video signal)
- : CPEV-S 0.65-3C (RS-485 Control line)  
Twisted pair with shield 22AWG or larger
- - - : Modular cable, 3 m (9.8 ft).  
(supplied with the C-RM1000)
- · - · : Modular cable, 1 m (3.3 ft)  
(supplied with HDD expansion unit)
- · - · : S-ATA cable, 1 m (3.3 ft)  
(supplied with HDD expansion unit)

### 9.2. About Star Wiring

A C-IF500 Interface Unit is required when using star wiring for a Combination Camera's control lines (RS-485). Refer to the Interface Unit's instruction manual for specific details on control line connections.

### 9.3. Digital Video Recorder's Expansion System (Cascade connection)

#### Notes

- A cascade-connected system generally requires the Remote Controller(s).
- It is necessary to set DVR-ID in the cascade-connected system. (Refer to p. 27; Setting the DVR -ID.)

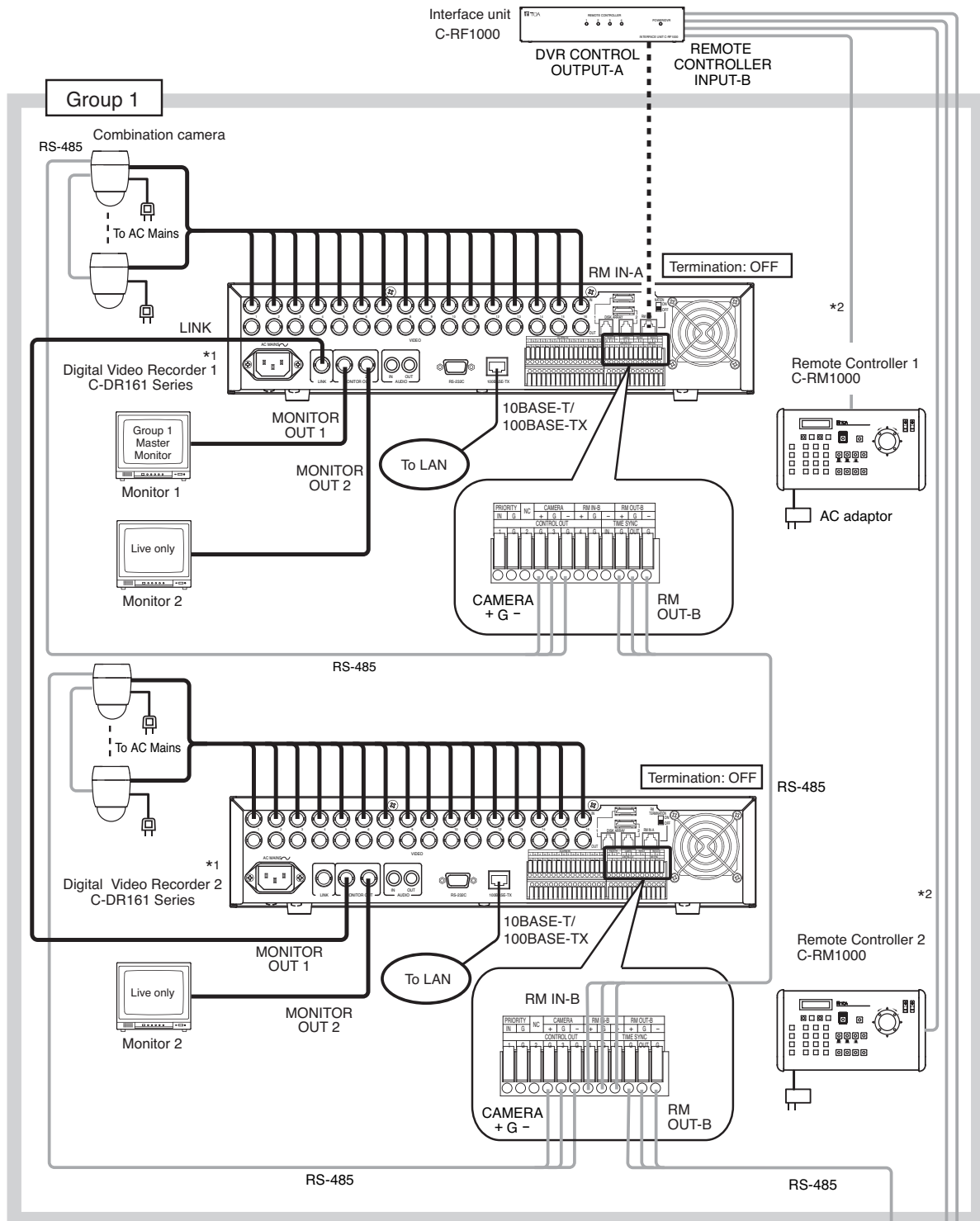

\*1 C-DR091 and C-DR161 Series  
 C-DR091: 9 I/O Terminals  
 C-DR161: 16 I/O Terminals

\*2 For the maximum cable length between the C-RF1000 Interface Unit and the C-RM1000 Remote Controller, refer to C-RM1000 operation manual.

- : Coaxial cable (Video signal)
- : CPEV-S 0.65-3C (RS-485 Control line)  
Twisted pair with shield 22AWG or larger
- - - : Modular cable, 3 m (9.8 ft)  
(supplied with the C-RF1000)

To next page

From previous page

— : Coaxial cable (Video signal)  
 — : CPEV-S 0.65-3C (RS-485 Control line)  
 Twisted pair with shield 22AWG or larger

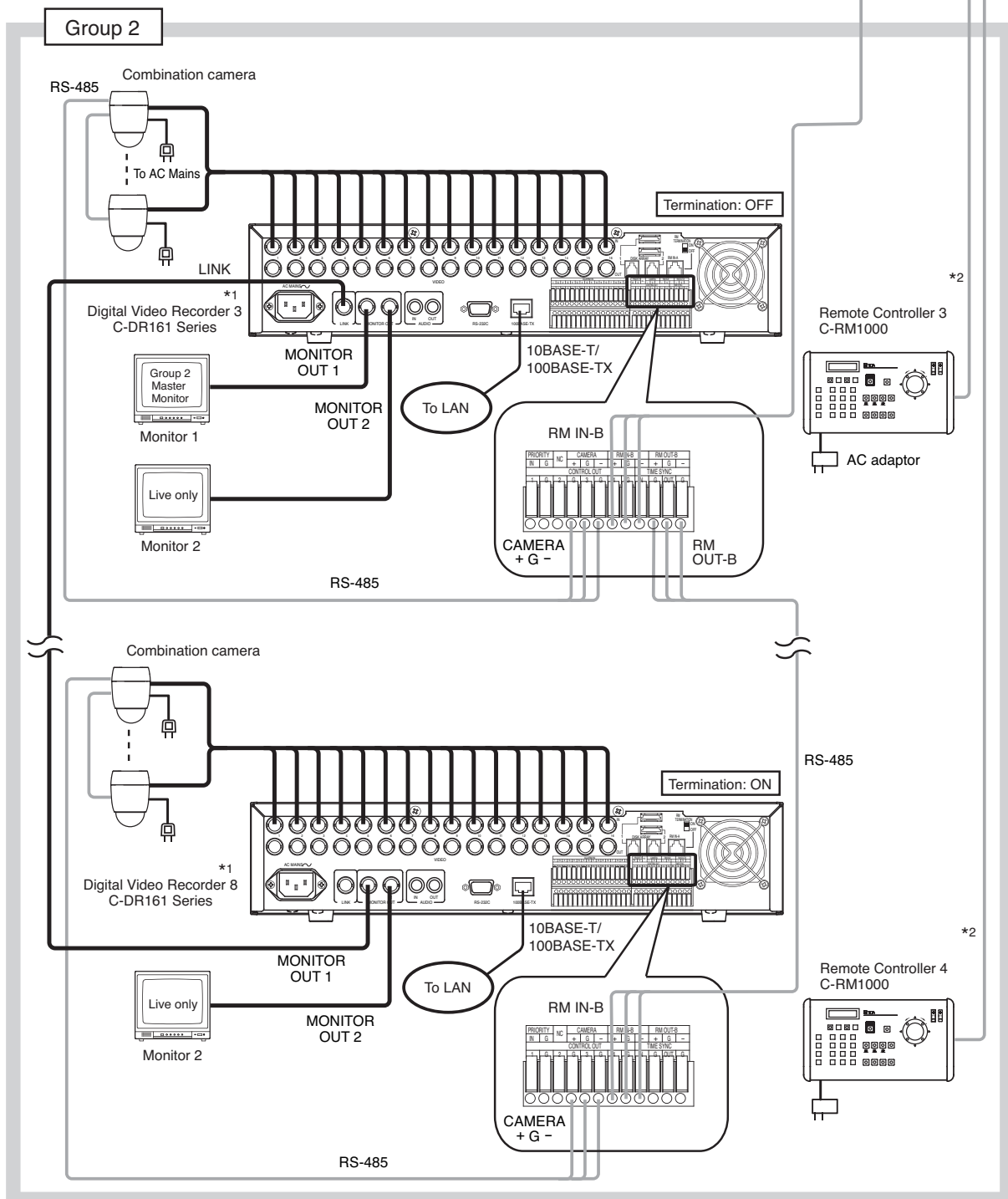

\*1 C-DR091 and C-DR161 Series  
 C-DR091: 9 I/O Terminals  
 C-DR161: 16 I/O Terminals

\*2 For the maximum cable length between the C-RF1000 Interface Unit and the C-RM1000 Remote Controller, refer to C-RM1000 operation manual.

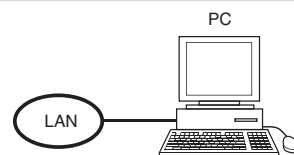

## 10. EXTERNAL TERMINAL CONNECTIONS

### 10.1. RS-232C Terminal Communications Specifications

The Digital Video Recorder can be controlled by a PC or other equipment via a connection through the RS-232C port. However:

#### Notes

- Control software is not available as standard accessory.
- TOA takes no responsibility for hardware or software failures or damages resulting from the use of third-party control software.

#### 10.1.1. Communications protocol

Transfer System: Start/stop system

Parity Bit: Even number

Transfer Speed: 9,600 bps, 19,200 bps, and 38,400 bps

Code: Binary code

Bit Length: 8 bits

Flow Control: CTS/RTS handshake or none

Stop Bit: 1

Error Control: None

#### 10.1.2. RS-232C Connector pin arrangement

The following signal names are assigned to each pin of the RS-232C D-sub 9P male connector:

Terminal No.	Symbol	Name
1	NC	Not connected
2	RD	Receiving data
3	SD	Sending data
4	NC	Not connected
5	SG	Signal ground
6	NC	Not connected
7	RS	Request to send
8	CS	Clear to send
9	NC	Not connected

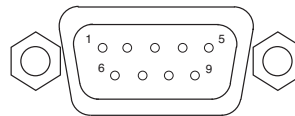

#### Note

RS-232C connector plug is supplied with the Digital Video Recorder.

For RS-232C connection to PC, use null modem cable.

## 10.2. Alarm Input Terminal Connections

The number of terminals available differs depending on whether the Digital Video Recorder is a 9-channel or a 16-channel version. Refer to the table below when making alarm input terminal connections. (Refer to p. 14; Nomenclature and Functions)

For 16 channel

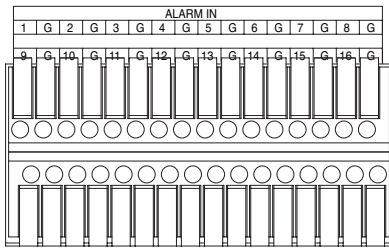

For 9 channel

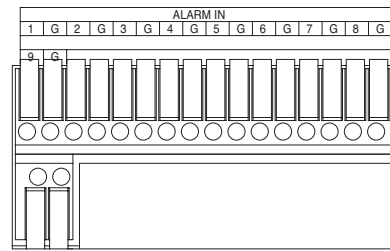

Terminal name	Symbol	Name	Terminal name	Symbol	Name
1	ALARM 1	Alarm input 1	9	ALARM 9	Alarm input 9
G	GND	Signal ground	G	GND	Signal ground
2	ALARM 2	Alarm input 2	10	ALARM 10	Alarm input 10
G	GND	Signal ground	G	GND	Signal ground
3	ALARM 3	Alarm input 3	11	ALARM 11	Alarm input 11
G	GND	Signal ground	G	GND	Signal ground
4	ALARM 4	Alarm input 4	12	ALARM 12	Alarm input 12
G	GND	Signal ground	G	GND	Signal ground
5	ALARM 5	Alarm input 5	13	ALARM 13	Alarm input 13
G	GND	Signal ground	G	GND	Signal ground
6	ALARM 6	Alarm input 6	14	ALARM 14	Alarm input 14
G	GND	Signal ground	G	GND	Signal ground
7	ALARM 7	Alarm input 7	15	ALARM 15	Alarm input 15
G	GND	Signal ground	G	GND	Signal ground
8	ALARM 8	Alarm input 8	16	ALARM 16	Alarm input 16
G	GND	Signal ground	G	GND	Signal ground

### 10.2.1. Terminal connection

The terminal connector is unlocked by pressing down on its release button. To connect the cable, press down on the release button first, insert the cable, then push the release button up again to lock the cable in place. However, for solid cables with diameters from 0.8 mm (AWG20) to 1.2 mm (AWG16), there is no need to press down on the release button. Cable can be connected simply by inserting it in place until it will not go any further.

#### Note

Ensure that the cable is securely locked into the terminal after connection.

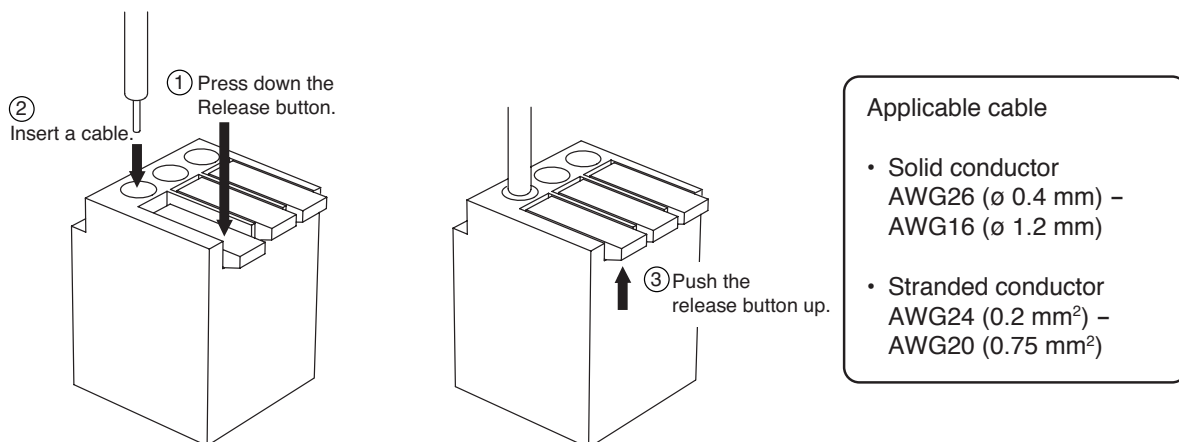



### 10.3. Control I/O Terminal Connections

The control input and output terminals include: priority recording terminal, camera control terminal, remote controller input/output terminals, control output terminal, and time synchronization input/output terminals. (Refer to p. 14; Nomenclature and Functions.)

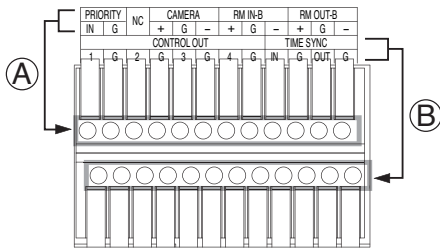

Terminal name (A)	Name	Terminal name (B)	Name
PRIORITY IN	Priority Recording Input	CONTROL OUT 1	Control Output 1
PRIORITY G	Priority Recording Ground	CONTROL OUT G	Control Output Ground
NC	Not connected	CONTROL OUT 2	Control Output 2
CAMERA +	Camera Control (RS-485) +	CONTROL OUT G	Control Output Ground
CAMERA G	Camera Control (RS-485) Ground	CONTROL OUT 3	Control Output 3
CAMERA -	Camera Control (RS-485) -	CONTROL OUT G	Control Output Ground
RM IN-B +	Remote Control Input B + (RS-485)	CONTROL OUT 4	Control Output 4
RM IN-B G	Remote Control Input B Ground	CONTROL OUT G	Control Output Ground
RM IN-B -	Remote Control Input B - (RS-485)	TIME SYNC IN	Date/Time Adjustment Input
RM OUT-B +	Remote Control Output B + (RS-485)	TIME SYNC G	Date/Time Adjustment Input Ground
RM OUT-B G	Remote Control Output B Ground	TIME SYNC OUT	Date/Time Adjustment Output
RM OUT-B -	Remote Control Output B - (RS-485)	TIME SYNC G	Date/Time Adjustment Output Ground

**Note**

Ensure that the cable is securely locked into the terminal after connection. (Refer to p. 24; Alarm input terminal connections.)

#### 10.3.1. Time synchronization input/output terminal connections

Two different methods are available to synchronize the time, one using both master and slave units, the other using NTP. (Refer to p. 100; Date/time setting.)

**Note**

When synchronizing a single-channel Digital Video Recorder, set the synchronization interval to “5 seconds.” (Refer to p. 100; Date/time setting.)



To synchronize the times of slave units with the time of the master unit, connect the slave units to the master unit in a series via their input and output terminals. In other words, connect the input of slave number 1 to the master unit's output and the input of slave number 2 to slave number 1's output, and so on.

### 10.4. 10BASE-T/100BASE-TX Terminal Connections

Use this terminal to remotely monitor or control cameras connected to the Digital Video Recorder, or search or play back their recorded images on a PC web browser. When connecting a PC directly to the Digital Video Recorder, use a network crossover cable. Use the straight-through cable for connection between them via a switching hub.

# 11. DIGITAL VIDEO RECORDER ACTIVATION AND TERMINATION

## 11.1. Recorder's Activation

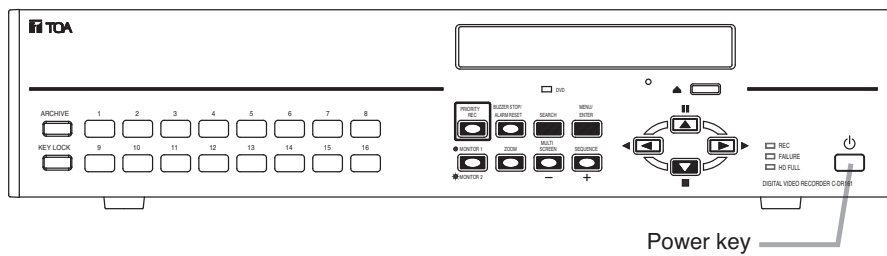

1. Connect each component correctly. (Refer to p. 20; Connections.)

2. Insert the power supply plug.

The Recorder is placed in standby mode. The power key flashes at about 5-second intervals while in standby mode.

### Note

Do not pull out the power supply plug while the Power key is light green. Ensure that the Recorder is in the standby mode when pulling out the power supply plug. Logged data could be damaged or lost if the power supply plug is pulled out during initialization (while accessing the hard disk).

Power key	LED indicator	Mode
	Distinguishes	Main power OFF
	Flashes (5sec)	Standby mode
	Flashes (1sec)	During a system check (during activation)
	Lights	Power ON (during operation)

3. Press the Power key while the Recorder is in standby mode.

The screen automatically changes as shown below. The Power key flashes green during a system check. The Power key changes from flashing to steady ON after system check completion, allowing camera images to be displayed.

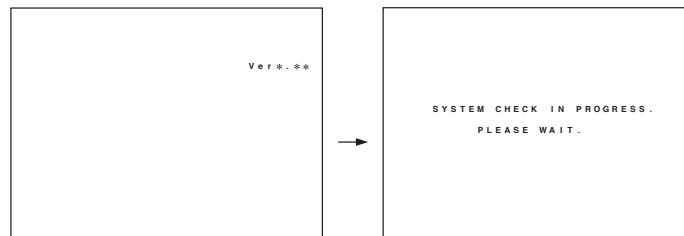

### Notes

- When the Recorder is used for the first time, the date and time could not be correctly displayed. Perform the clock setting before use. (Refer to p. 100; Date/time setting.)
- When the Digital Video Recorder is switched to standby mode, it cannot be switched on for about 10 seconds.
- Priority recording and auto-recording cannot be made in standby mode. Be sure to press the Power key when making recording.

## 11.2. Recorder's Power Off and Disconnect

Hold down the Power key for 2 seconds or more. All operations stop, placing the Recorder in standby mode. When moving the Recorder, be sure to place it in standby mode, then remove the power supply plug from the wall outlet.

## 12. INITIAL SETTINGS

Be sure to perform the following settings before using the Digital Video Recorder. Failure to do so may lead to incorrect operation of each function.

- DVR-ID setting (When cascade-connecting)  
**Note:** When cascade-connecting the Digital Video Recorders, set the DVR-ID first. Otherwise, the Menu screen is not displayed.
- Clock settings
- Hard disk initialization
- Auto-Recording settings

### 12.1. Setting the DVR-ID

When cascade-connecting the Digital Video Recorders, set different DVR-ID for all individual Digital Video Recorders. DVR-ID are all factory-preset to "1." Follow the procedure below to set DVR number.  
(Refer to p. 21; Digital Video Recorder's Expansion system.)

1. Press the Digital Video Recorder's Power key while holding down the Sequence key in standby mode.  
Camera Selection keys 1 – 8 flashes for about 1minute.

2. Press the desired DVR-ID to set.

The selected number flashes three times, then the number is programmed as DVR-ID.

**Note:** It is impossible to operate the Digital Video Recorder when the main power is set to OFF. Operate the Digital Video Recorder after placing it in standby mode.

### 12.2. Clock Settings

Perform clock settings of the Digital Video Recorder. Adjust the date and time in Clock Settings on the menu screen. (Refer to p. 100; Date/time setting.)

#### Notes

- If the clock setting is not performed, video recordings are not made according to the schedule set in the auto-recording setting.
- In some cases, changing the current time may make it impossible to play back the recorded images correctly when duplicated time data exists in the recording data.

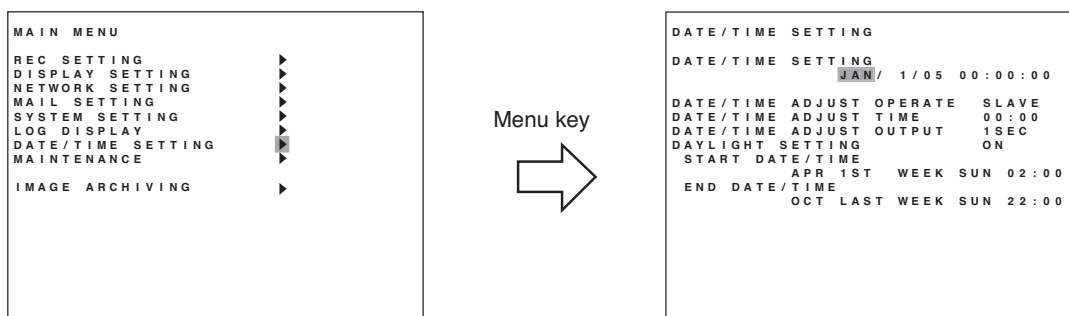

1. Hold down the Menu key for 2 seconds or more.  
The main menu screen is displayed.
2. Move the cursor with the [▲] and [▼] keys to select "DATE/TIME SETTING," then press the Menu key.  
The clock setting screen is displayed.
3. Move the cursor with the [◀] and [▶] keys and perform clock settings using the [+] and [-] keys.  
Set year, month, date, hour, minute, and second.

4. Press the [◀] key while the cursor is set to the leftmost selection item on the screen.  
The indication will appear to ask whether or not to save the setting.
5. Move the cursor with the [◀] and [▶] keys, select "YES," then press the Menu key.  
The display reverts to the main menu screen.

### 12.3. Hard Disk Initialization

Set disk mode (normal mode and mirror mode) used for recording to the hard disk to initialize the hard disk. (Refer to p. 101; Equipment Maintenance.)

#### Notes

- Since initializing the hard disk erases all recorded images, be sure to copy the necessary data to DVD-R/RW disks or USB memory before initialization.
- Disk mode is factory-preset to "NORMAL." Leave the disk mode as it is when using the Digital Video Recorder in normal mode. However, it is recommended that the hard disk be initialized since recording starts automatically when the Digital Video Recorder's power is switched on.

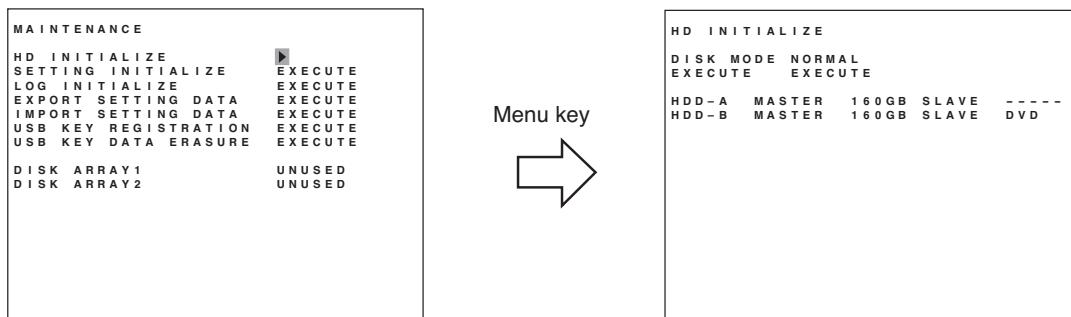

1. Hold down the Menu key for 2 seconds or more.  
The main menu screen is displayed.
2. Move the cursor with the [▲] and [▼] keys to select "MAINTENANCE," then press the Menu key.  
The Equipment Maintenance screen is displayed.
3. Select "HD INITIALIZE," then press the Menu key.  
The Hard Disk Initialization screen is displayed.
4. Select the disk mode using the [+] and [-] keys.  
Select "NORMAL," or "MIRROR." (Refer to p. 38; Before Recording.)
5. Move the cursor with the [▲] and [▼] keys to select "EXECUTE," then press the Menu key.  
"Yes" and "Cancel" are displayed.
6. Move the cursor with the [◀] and [▶] keys to select "YES," then press the Menu key.  
Confirmation message is displayed after executing the hard disk initialization.
7. Select "OK," then press the Menu key.  
The display returns to the hard disk initialization screen.

## 12.4. Auto-Recording Settings

Recordings are normally performed according to the preprogrammed schedule. Therefore, perform schedule or group settings when making auto-recording. (Refer to p. 79; Auto recording setting.)

### 12.4.1. Schedule setting

Set the schedule (Day, Start time, and End time) for each group to operate.

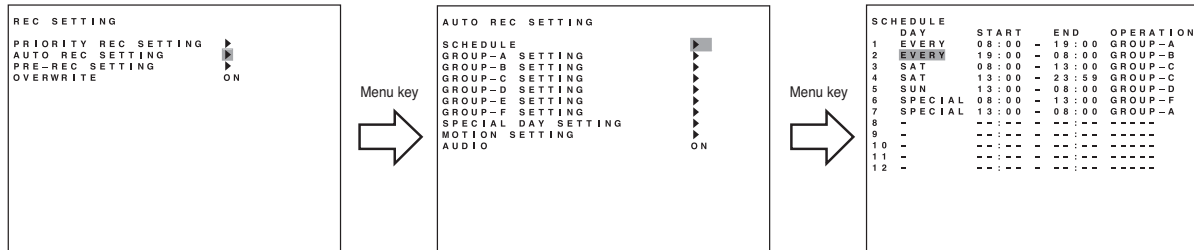

1. Hold down the Menu key for 2 seconds or more.  
The main menu screen is displayed.
2. Select "REC SETTING," then press the Menu key. The Recording setting screen is displayed.
3. Move the cursor with the [▲] and [▼] keys to select "AUTO REC SETTING," then press the Menu key.  
The Auto-recording setting screen is displayed.
4. Select "SCHEDULE," then press the Menu key.
5. Move the cursor with the [▲], [▼], [◀], and [▶] keys and perform schedule setting using the [+] and [-] keys.  
Set a day of the week, Start time, End time and manner of operation (group setting). (Refer to p. 79; Auto recording setting.)
6. Press the [◀] key while the cursor is set to the leftmost selection item on the screen.  
The indication will appear to ask whether or not to save the setting.
7. Move the cursor with the [◀] and [▶] keys to select Yes, then press the Menu key.  
The display reverts to the auto-recording setting screen.

### 12.4.2. Setting the group

Perform individual settings such as Normal recording and Alarm Event recording for Group A - F.

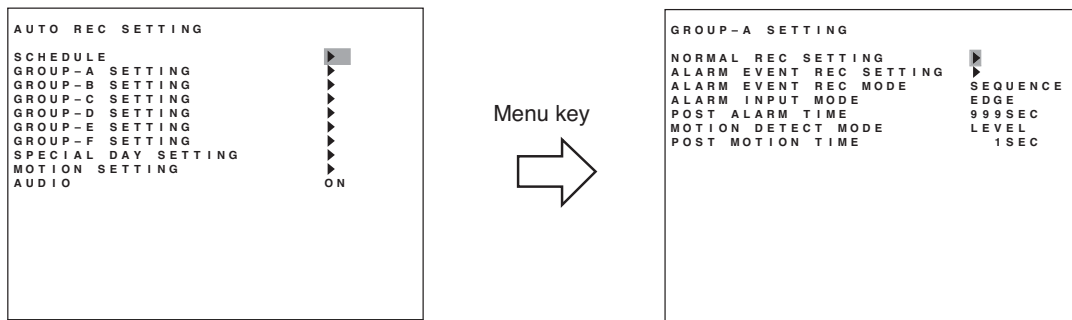

1. Choose "Group A-F" from the Auto-recording Settings and press the Menu key.  
The Group setting screen is displayed.
2. Move the cursor with the [▲], [▼], [◀], and [▶] keys and perform Group setting using the [+] and [-] keys.  
For a detailed information, refer to "Group A-F settings." (Refer to [p. 80](#); Setting of groups A – F.)
3. Press the [◀] key while the cursor is set to the leftmost selection item on the screen.  
The indication will appear to ask whether or not to save the setting.
4. Move the cursor with the [◀] and [▶] keys to select "YES," then press the Menu key.  
The display reverts to the auto-recording setting screen.

### 12.4.3. Other settings

In Auto-Recording Settings, "special day," "motion detection," and "audio (ON/OFF)" settings can be performed in addition to both schedule and group settings. (Refer to [p. 79](#); Auto-recording setting.)

## 13. MONITOR DISPLAY

Functions that can be displayed differ between Monitor Outputs 1 and 2.

Function	Live mode					Playback mode				Electronic Zoom	Cascade output
	Full	4 Seg	9 Seg	16 Seg*	Sequence	Full	4 Seg	9 Seg	16 Seg*		
Monitor output 1	○	○	○	○	○	○	○	○	○	○	○
Monitor output 2	○	○	×	×	○	×	×	×	×	×	×

Function	Digital Recorder menu	Search menu	Display position setting screen	Triplex setting screen	Archive menu
Monitor output 1	○	○	○	○	○
Monitor output 2	×	×	×	×	×

\* Only the C-DR161 Series (16-channel versions) can display.

### 13.1. Monitor Switch

Operations of Monitor 1 and Monitor 2 outputs switch with each depression of the Monitor key.

Monitor 1 output is enabled when the Monitor key is unlit, and Monitor 2 output is enabled when the Monitor key is lit.

### 13.2. About Live and Playback Modes

Display can be switched between live and playback modes

Pressing the Play key when in live mode switches the screen to playback mode, while pressing the Stop key when in playback mode switches the screen to live mode. The multi-segment split screen display is maintained even if the mode is switched.

**Live mode:** Displays current camera images. The camera number is displayed following the “L” indication.

**Playback mode:** Displays recorded camera images. The camera number is displayed following the “PB” indication.

### 13.3. Display when in live mode

The following indications appear when in live mode.

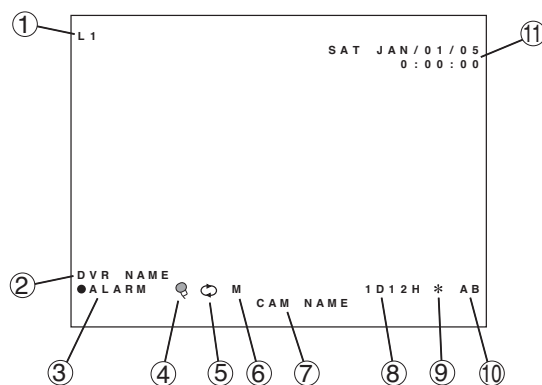

**(1) Camera number**

“L” represents the live pictures. The number indicates the input number of the camera images.

**(2) DVR name**

(Refer to p. 89; DVR Name setting.)

**(3) Recording status**

- : Indicates that normal recording is in progress.
- **ALARM**: Indicates that alarm recording is in progress. The number is an alarm input terminal number.
- **MOTION**: Indicates that motion detected recording is in progress. The number is a camera number that detects motions.
- **PRIOR**: Indicates that priority recording is in progress.

**(4) Audio recording ON/OFF**

- 🔊 : Audio recording enabled.  
(Refer to p. 77; Priority recording setting.)  
(Refer to p. 79; Auto recording setting.)  
(Refer to p. 85; Pre-recording settings.)

**[No indication]**: Audio recording disabled.

**(5) Overwrite settings**

(Refer to p. 76; Recording setting.)

- ➡ : Write Protect
- ↺ : Overwrite

**(6) Disk mode**

(Refer to p. 102; Hard disk drive initialization.)

- M**: Mirror mode
- [No Indication]**: Normal mode

**(7) Camera name**

(Refer to p. 89; Camera name setting.)

**(8) Available hard disk time**

Displayed when in Write Protect mode.

**(9) Fan failure**

The “\*” indication lights when the fan fails. This indication cannot be set to “Hide” in screen display settings.

**(10) Hard disk in use**

Indicates the hard disk currently making recording.

- A, B** \*: Built-in hard disk
- C, D**: Hard disk expansion unit 1
- E, F**: Hard disk expansion unit 2

\*1 “B” is not displayed for single-hard disk models (versions with model number suffix -8, 1, D08 or D1).  
One of “A”-“F” is displayed during normal mode. Two characters from “A”-“F” are displayed during mirror mode.

**(11) Current date and time**

(Refer to p. 100; Date/Time setting.)  
This position can be moved by settings.

**Notes**

- Either (1) or (7) can be displayed.
- All indications but (9) can be set to Display/Hide by menu.



## 13.4. Display during Playback

The following indications appear while the playback screen is displayed:

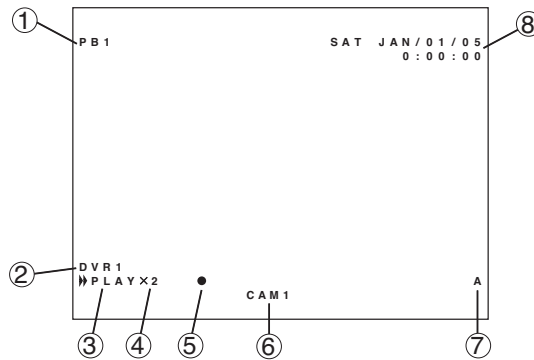

### (1) Camera number being played back

"PB1" represents playback image. The number represents the input number of the camera images.

### (2) DVR name

(Refer to p. 89; DVR name setting.)

### (3) Playback mode

- ▶ **PLAY:** Playback in progress.
- ▶▶ **PLAY:** Fast forward quick playback in progress.
- ◀ **REV:** Reverse playback in progress.
- ◀◀ **REV:** Fast reverse playback in progress.
- **PAUSE:** Playback temporarily stops.

### (4) Fast forward/reverse playback speed

X2, X4, X8: Quickly plays back forward or in reverse at the indicated speed.

1M, 10M: Quickly plays back forward or in reverse skipping images in 1-minute/10-minute segments.

### (5) Recording state

●: Priority recording or Auto recording in progress

[No indication]: Recording stop state

### (6) Camera name

(Refer to p. 89; Camera name setting.)

### (7) Hard disk being played back

- A:** Plays back the first built-in hard disk
- B:** Plays back the second built-in hard disk (versions with a model number suffix -3, -6, D3, or D6 only).
- C -:** Plays back the hard disk expansion unit's hard disk.

### (8) Recording date and time

This display position can be changed by settings.

### Notes

- Either (1) or (6) can be displayed.
- All indications but (7) can be set to Display/Hide by menu.

## 13.5. Full-Screen Display

Pressing the Camera Selector key while in live or playback mode displays the selected camera output on the full screen.

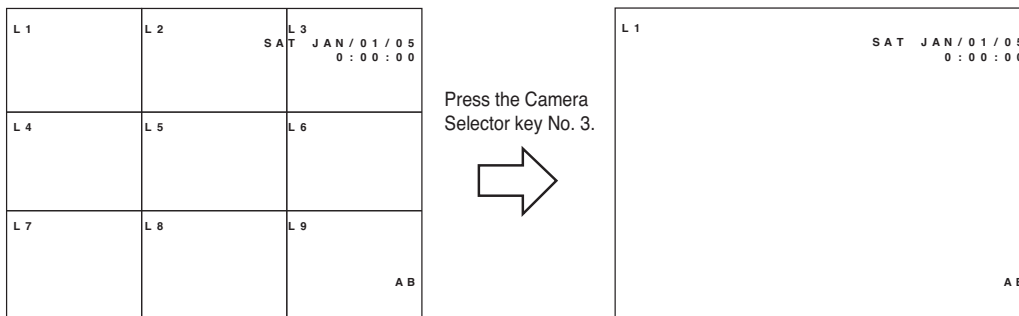

### 13.6. Multi-Segment Split-Screen Display

When the live or playback screen is displayed, the multi-segment split-screen display changes as shown below each time the Multi-Screen key is pressed. Multi-Screen key lights continuously during multi-Segment Split-Screen display.

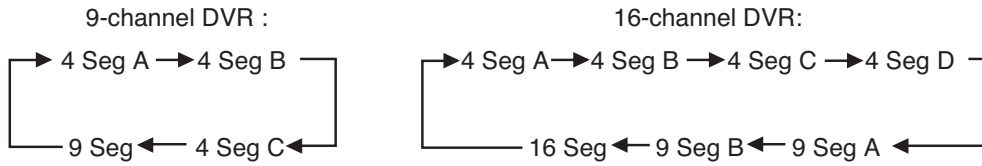

(Example) Screen display in live mode (9-channel DVR)

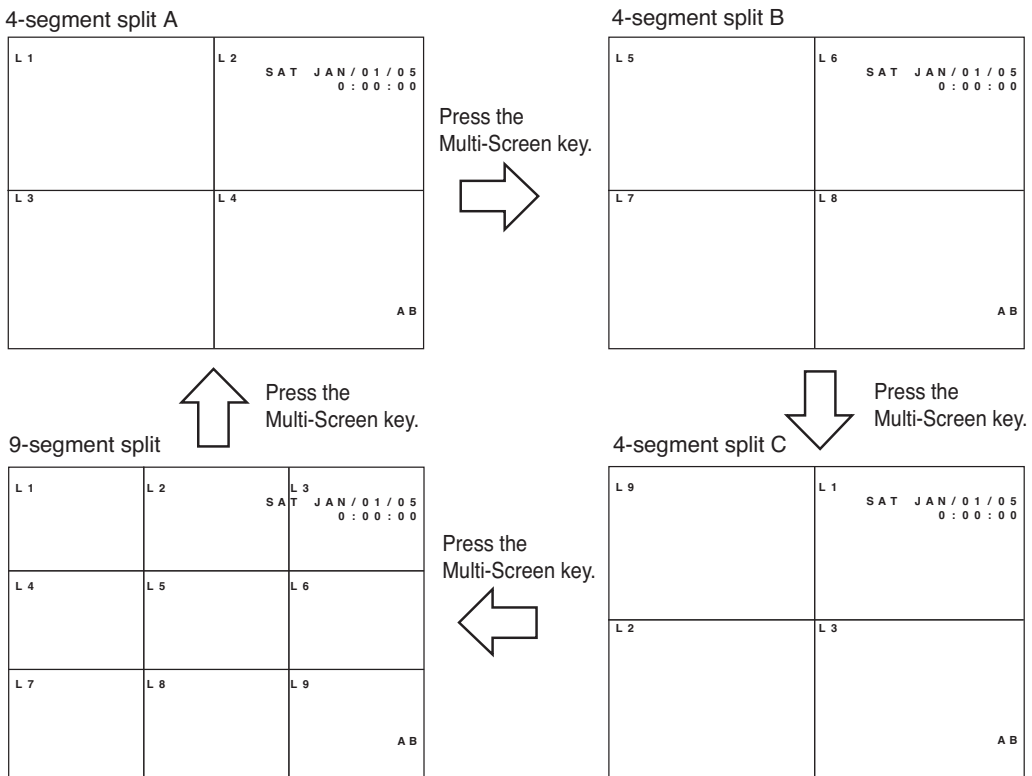

## 13.7. Sequence Display

Camera live images are displayed in sequential order when the Sequence key is pressed while in live mode. Viewing intervals and cameras to be displayed can be set on the menu screen. Sequence key lights continuously during Sequence display. (Refer to p. 88; Sequence Setting.)

(Setting Example)

Step 1 : Camera 1 3 seconds  
 Step 2 : Camera 2 3 seconds  
 Step 3 : Camera 3 3 seconds  
 Step 4 : 4-split A 3 seconds

### Note

That when the screen is switched, the picture may be distorted momentarily.

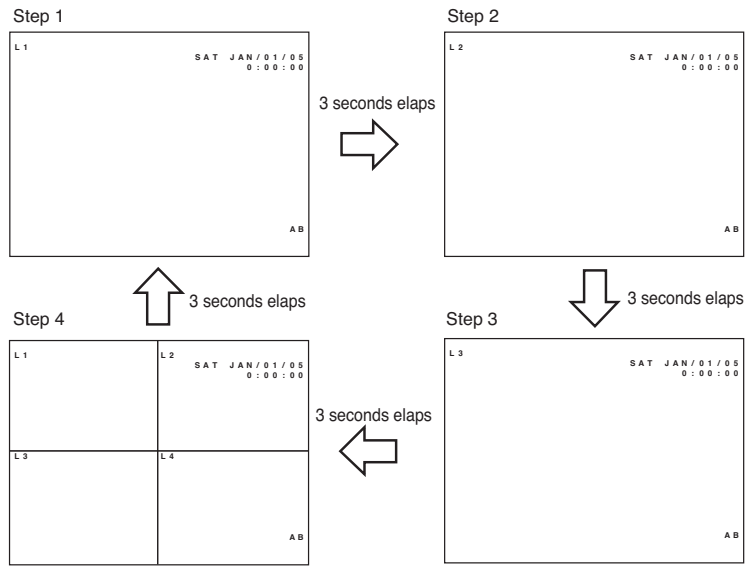

## 13.8. Zoom Display

Live or recorded full-screen images can be viewed in 2 x zoom display. Zoom key lights continuously while the Zoom selection screen or Zoom screen is displayed.

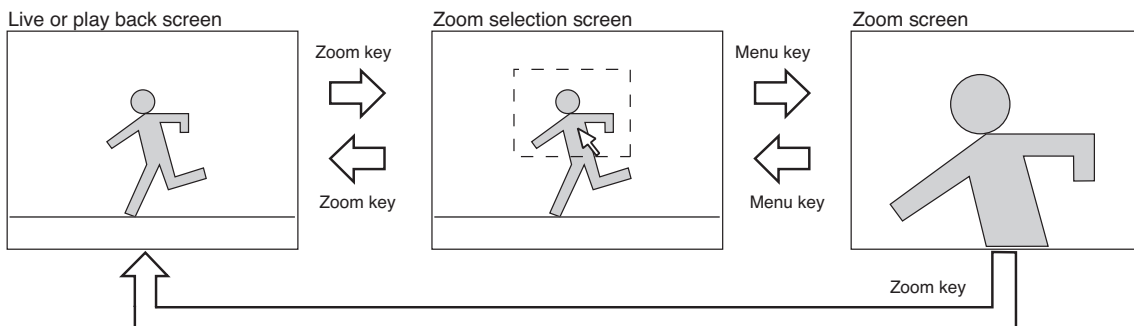

1. Press the zoom key  
 The zoom selection screen is displayed. The pointer is displayed on the screen.
2. Move the central point of the subject to be zoomed using the [▲], [▼], [◀], and [▶] keys, then press the Menu key.  
 The subject can be zoomed with the designated point at the center. Zoomed areas can be moved using the [▲], [▼], [◀], and [▶] keys even while zoomed.
3. Press the Menu key when the zoom screen is displayed.  
 The display reverts to the zoom selection screen. Pressing the Zoom key again when the zoom screen is displayed resets the zoom display.

### Note





When channels are changed, multi-segment split-screen display is selected, or a search function is operated during zoom display, the zoom mode is reset.

## 14. OTHER FUNCTIONS

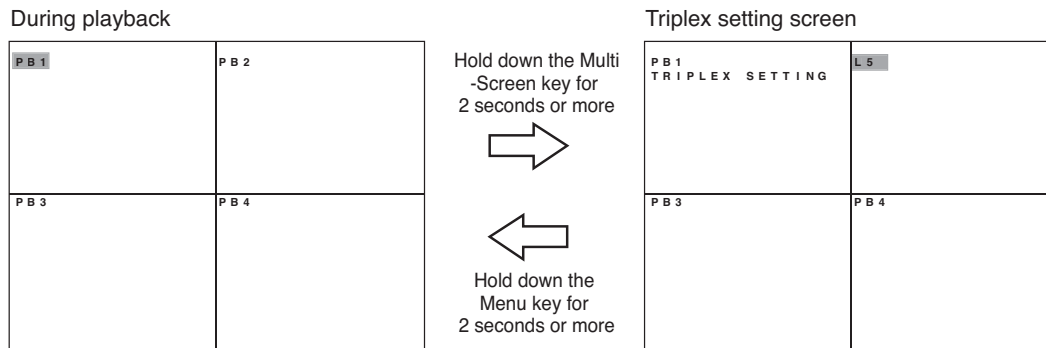
### 14.1. Triplex Display

Holding down the Multi-Screen key for 2 seconds or more during playback, including fast forwarding, rewinding, and pause, on the multi-segment split screen switches the display to Triplex setting screen. The Triplex setting permits live camera images to be viewed among recorded images displayed on the multi-segment split screen. The Triplex setting is maintained even when the power is switched OFF.



1. Hold down the Multi-Screen key for 2 seconds or more.  
The triplex setting screen is displayed.
2. Press the [, [, [, and [] keys to move the cursor.
3. Press the Camera selector key.  
When the Camera selector key is pressed, the live screen corresponding to the selected camera output is displayed in the position indicated by the cursor. A dark screen is displayed if the selected camera is not connected.
4. To revert the set live images to the playback images, press the Sequence key.  
Pressing the Sequence key resets the selected position's live display and switches it to the playback image.
5. Hold down the Menu key for 2 seconds or more.  
The triplex setting screen is terminated.





#### Notes

- It is impossible to set all screens to the live display.
- Two or more live image screens cannot be set for the same camera.

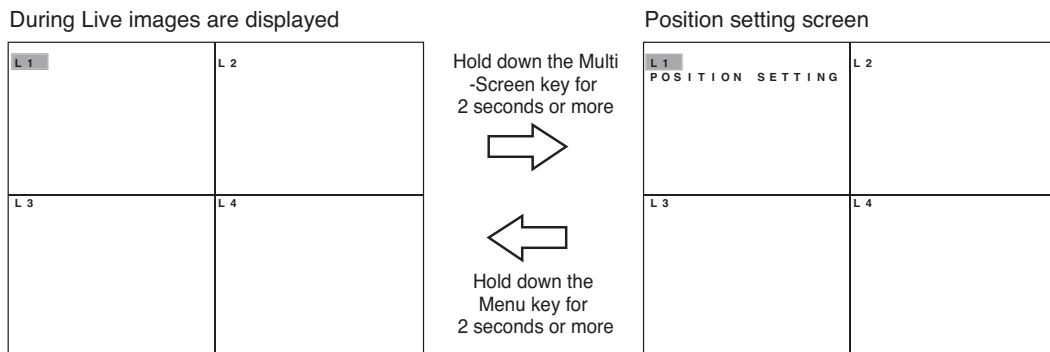
## 14.2. Position Setting Display

Holding down the Multi-Screen key for 2 seconds or more when the live multi-segment split screen is displayed displays the position setting screen. Camera images can be displayed at arbitrary positions on the multi-segment split screen. The position setting for each multi-segment split screen is saved.



1. Hold down the Multi-Screen key for 2 seconds or more.  
The position setting screen is displayed.
2. Press the [, [, [, and [] keys to move the cursor.
3. Press the Camera selector key.  
When the Camera selector key is pressed, the live screen corresponding to the selected camera output is displayed in the position indicated by the cursor. A dark screen is displayed if the selected camera is not connected.
4. Hold down the Menu key for 2 seconds or more.  
When the Menu key is pressed, the setting screen is terminated in the current state, returning the display to the live screen.

### Notes

- If live picture of selected camera number is already displayed on the position setting screen, it is switched with the live screen of the camera during selection.
- Position of camera images through Monitor 2 cannot be changed.
- When an alarm event occurs during display position setting, the alarm-activated camera image is recorded but not displayed on the full screen.

# 15. RECORDING

## 15.1. Before Recording

Auto-recordings are normally performed according to the preprogrammed schedule. Operations to start recording such as pressing the key are not required. You can also make recording by pressing the Priority Recording key outside the scheduled time period. Perform disk mode and overwrite settings before recording.

### 15.1.1. Disk mode

Normal and mirror modes are available to this mode. For models with a single hard disk (versions with a model number suffix -08, -1, D08 or D1), Mirror settings are available only when the hard disk expansion unit is connected. (Refer to p. 101; Equipment maintenance.)

#### Notes

- When the disk mode is changed, the hard disk is initialized, causing the recorded images to be erased. Be sure to determine the disk mode before use.
- Unless the disk mode setting is performed, mirror recording cannot be performed as the hard disk is factory-preset to normal mode.

**Normal mode:** When the first hard disk finishes recording, the second hard disk automatically begins to record. When the settings (recording rate and picture quality) of both normal and mirror modes are set to be identical, the recording time for normal mode is about twice that of mirror mode. The total recording rate is 120 IPS maximum.

**Mirror mode:** The same image is simultaneously recorded on both hard disks. Even if one of the two hard disks fails, the other hard disk continues to record, allowing all recorded images to be played back. The total recording rate is 60 IPS maximum. Set the disk mode to Mirror when performing mirroring by the two built-in hard disks or when performing mirroring by the built-in hard disk and the hard disk expansion unit.

### 15.1.2. Recording order to hard disks

Recordings to the built-in hard disks are performed in the following order.

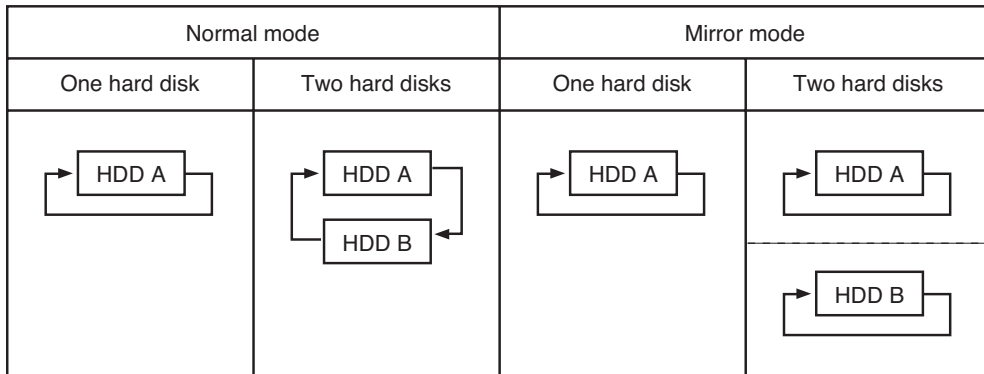

#### Note

For the recording operation when the expansion unit is connected, refer to the instruction manual enclosed with the expansion unit.

### 15.1.3. Disk recording mode

Overwriting of hard disk recordings can be set to Overwrite or Write Protect. (Refer to p. 76; Recording Settings.)

**Overwrite:** When all hard disks become full, previous recorded older data is automatically deleted and replaced with newer data.

**Write Protect:** When all hard disks become full, recording is stopped. To begin recording again, initialize the hard disk and reactivate the Digital Video Recorder, or set the disk-recording mode to "Overwrite."

## 15.2. Recording Mode

The following recording modes are available to the Digital Video Recorder. Priorities are 1, 2 and 3 in that order.

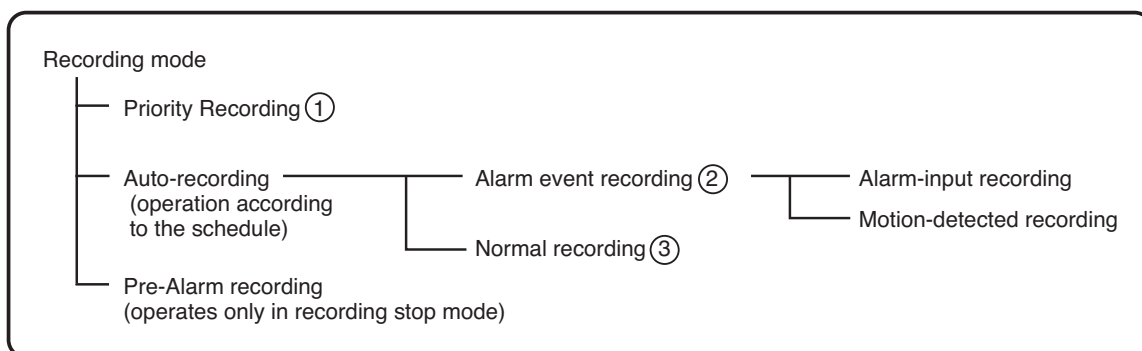

## 15.3. Priority Recording

Priority recording is given higher priority over Auto-recording. Use this recording mode to check recording details when, for example, a suspicious person intrudes or when making recording outside the scheduled time period. In the Priority Recording settings, the following settings can be made for individual cameras: recording ON/OFF, recording rate, picture quality and audio ON/OFF. (Refer to p. 77; Priority Recording setting.)

### 15.3.1. How to perform priority recording

1. Press the Priority Recording key to start the priority recording. To stop a buzzer sound, press the Buzzer Stop key.
2. Hold down the Priority Recording key for 2 seconds or more to terminate the priority recording.

#### Notes

Priority recording can be started by any of the following ways.

- Input the signal to the Priority recording input terminal on the rear panel.
- Press the Remote Controller's Priority Recording key.

## 15.4. Auto Recording (Alarm Event Recording and Normal Recording)

With auto-recording, recordings are made according to a preset schedule, which can include up to twelve different programs. If one or more programs have duplicate execution times, the program with a largest number takes precedence. Settable items for each program include: Day of the Week; Start/End Times; and Operation. Up to six settings groups, named A through F, can be made for "Operation," and recording settings for Normal and Alarm recording can also be registered. Further, up to sixty "special day" operational settings can also be made, with operation controlled by different programs, motion detection areas for individual cameras, and audio recording during auto- recording. (Refer to [p. 79](#); Auto-Recording Settings.)

### Notes

- If the Alarm display interval is set to "0" second, no full-screen display is performed and the current display status is maintained.
- If an alarm event occurs outside the scheduled time period, Alarm Event recording is not performed.

### 15.4.1. Alarm event recording

Alarm Event recording includes both "Alarm Input" and "Motion Detection" recording. For Alarm Event recording, settable items for each individual camera include: Recording ON/OFF; Recording Rate; and Picture Quality. It is also possible to set, for each recording mode, the type of events that will cause recording to begin. (Refer to [p. 82](#); Alarm Event Recording Setting.)

For Alarm Event recording mode, it is possible to set the type of recording operation to be performed when multiple events have occurred simultaneously. Setting the mode to "Sequence" allows two or more events to be set for individual cameras. For Alarm Input recording time, set both alarm input mode and post alarm time intervals. For Motion Detection, set both motion detection mode and post-motion alarm time. (Refer to [p. 80](#); Setting of groups A-F.)

When an alarm event occurs, the corresponding camera's image is switched to full-screen display until the preset alarm time interval has elapsed, after which the display reverts to the original screen display. (Refer to [p. 86](#); Screen Display Setting.)

**Alarm input recording:** Alarm Input recording begins when signals are received at the alarm input terminal on the rear panel. Use Event settings to link cameras that are to have their images recorded and alarm input terminal. If "Sequence" is selected, up to four alarm input terminals can be set optionally per camera. If "Last" is selected, the "Alarm ON/OFF" can be set only for the alarm input terminal with a number corresponding to that of the camera.

**Motion detected recording:** Motion Detection recording begins when motion is detected in a camera image. Use Motion Settings to set the motion detection area, sensitivity, and activation. Use Event settings to link cameras that are to have their images recorded and cameras that are to use motion detection. If "Sequence" is selected as the alarm event recording mode, then up to four alarm input terminals can be set optionally per camera. If "Last" is selected, the "Alarm ON/OFF" can be set only for the alarm input terminal with a number corresponding to that of the camera.



### 15.4.2. Normal recording

This function automatically records camera images set by schedule. For Normal recording, settable items for each individual camera include: Recording ON/OFF; Recording Rate; and Picture Quality. (Refer to p. 81; Normal Recording setting.) Recordings can be made on scheduled patterns like "day and night," and "weekdays and holidays" by combining two or more programs.

### 15.5. Pre-Recording

This function records images immediately before Priority recording or Alarm Event recording is initiated. Setting the Pre-Recording interval to 1 second or more allows Pre-Recording to be performed. In Pre-Recording, the recording rate and picture quality cannot be individually set for each camera. Instead, recording rate, picture quality, and audio ON/OFF settings are common to all connected cameras. The maximum recording rate per camera is 4 IPS. (Refer to p. 85; Pre-Recording setting.)

Pre-Recording can be performed under the following conditions.

- When Priority recording begins while recording is stopped.
- When an alarm event occurs and alarm even recording begins while a schedule in which Normal Recording is not available but Alarm Event Recording is available is in operation.

**Note:** Pre-Recording cannot be performed during Normal Recording.

### 15.6. Recording State

The Digital Video Recorder permits recordings to be set to best meet user requirements.

#### Recording within a scheduled time period

##### [ Auto recording (Normal recording) ]

Recording is performed as shown in the following figure when set to always automatically record (Normal recording):

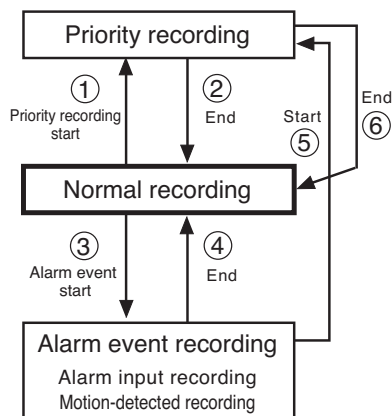

- (1) Priority recording is initiated if Priority recording's event occurs.
- (2) When the Priority recording ends, recording reverts to Normal recording mode.
- (3) Alarm Event recording is initiated if the alarm input terminal receives a signal or if motion movement is detected.
- (4) When the preset Alarm Event recording interval elapses, recording reverts to Normal recording mode.
- (5) Priority recording is initiated if a Priority signal is received or if manually started during Alarm Event recording.
- (6) When the Priority recording ends, recording reverts to Normal recording.

#### Notes

- Perform Normal recording settings in auto recording settings.
- Normal recordings are factory-preset to "recordings ON" for all cameras.

## Recording within a scheduled time period

### [ Recording only when Priority recording is initiated or alarm event occurs ]

To stop recording within the scheduled time period, set all cameras to "Recording OFF" in normal recording settings. To perform recording only when Priority recording or Alarm Event recording is initiated, recording is performed as shown in the following figure.

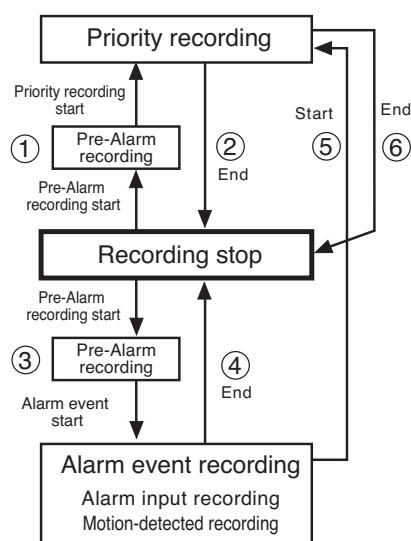

- (1) If the Priority recording's event occurs, Pre-Recording is first made, then Priority recording begins.
- (2) When the Priority recording ends, recording reverts to recording stop mode.
- (3) If Alarm Event recording is initiated, Pre-Recording is first made, then Alarm Event recording begins.
- (4) When the preset Alarm Event recording interval elapses, recording reverts to recording stop mode.
- (5) Priority recording is initiated if a Priority signal is received or if manually started during Alarm Event recording.
- (6) When the Priority recording ends, recording reverts to Normal recording.

#### Notes

- Even if Priority recording or Alarm recording is initiated, it is made following Pre-Recording.
- Pre-Recording is initiated when the Pre-Alarm interval is set to 1 second or more.

## Recording outside scheduled time periods

### [ Recording only when Priority recording is initiated ]

Recording is performed as follows outside the scheduled time period.

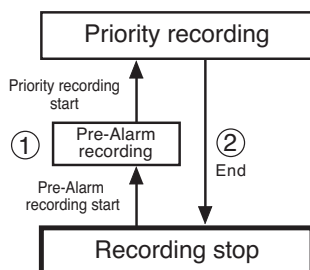

- (1) When the Priority recording's event occurs, Pre-Recording is first made, then Priority recording begins.
- (2) When the preset Priority recording interval elapses, recording reverts to recording stop mode.

#### Notes

- Normal recording and Alarm event recording cannot be performed.
- If Priority recording is initiated, Pre-Recording is first made, then Priority recording begins.
- Pre-Recording is initiated when the Pre-Alarm interval is set to 1 second or more.

## 15.7. Recording Operation When Edge/Level Settings Are Performed

When Priority Recording Input mode, Alarm Input mode, or Motion Detection mode are set to either "Edge" or "Level," recording will be performed as follows.

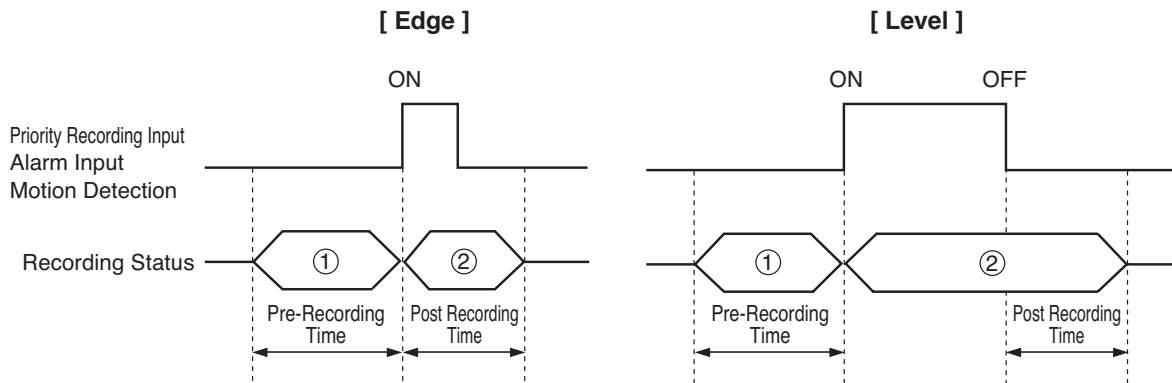

- ① Pre-Recording
- ② Priority Recording, Alarm Input Recording, or Motion Detection Recording

### Notes

- Pre-recording only functions when recording is stopped. It cannot be used when recording is in progress.
- If the Priority Recording Key on the Digital Video Recorder or remote controller is used to start recording when Priority Recording Input mode is set to "Level," then priority recording continues until it is manually stopped.

## 15.8. Picture Quality

Picture quality can be set at any of five different levels for each recording mode and camera. File sizes for each picture quality are shown below.

**Note:** File size may differ depending on the images.

Picture Quality	File Size
1 (Highest)	64 KB
2	40 KB
3	32 KB
4	24 KB
5 (Lowest)	16 KB

## 15.9. Recording Rate

The recording rate indicates the number of images to be recorded per second and is expressed by the unit IPS (Image Per Second). In the Digital Video Recorder, the total recording rate is the sum of each camera's recording rate and recordings can be made for up to 120 IPS in normal mode and for up to 60 IPS in mirror recording mode. The maximum recording rate that can be set per camera is 60 IPS.

The recording rate to be set on the menu screen is displayed, rounded up. The following table shows the relationship of menu screen display vs. actual recording rate.

Menu screen display	Actual recording rate	Menu screen display	Actual recording rate
60	60.000000	1/2	0.468750
30	30.000000	1/3	0.312500
15	15.000000	1/5	0.187500
8	7.500000	1/10	0.093750
4	3.750000	1/20	0.049342
2	1.875000	1/30	0.033482
1	0.937500	1/60	0.016741

The total recording rate is calculated by the actual recording rate in the above table. If, for example, each of 16 cameras is set to a menu screen display value of 8 IPS, the total recording rate is 120 IPS since the actual per-unit recording rate is 7.5 IPS.

Also, if a recording rate of 1/2 IPS or less (1/2 - 1/60) is designated, the total rate is calculated using the rate of 0.937500.

## 15.10. Recording time

Recording time varies depending on the settings described below.

For recording time, refer to [p. 116](#), "Recording timetable" as a guide.

- HDD Capacity (80 GB - 600 GB)
- Recording rate (60 - 1/60)
- Picture quality (1 - 5)
- Audio (ON/OFF)

## 15.11. Available Disk Time and Operation

When disk recording mode is set to "Overwrite," the available time indication is not displayed and the disk space indicator does not light. In "Write Protect" mode, when the remaining time is shorter than the preset remaining warning time, the disk space indicator lights and recording is stopped.

## 16. PLAYBACK

### 16.1. Type of Playback

The Digital Video Recorder is equipped with the simultaneous recording/playback function that permits recorded images to be played back without stopping recording. Playback is performed only through Monitor 1. The following playback methods are available.

Type	Description
Playback	Plays back recorded images.
Reverse playback	Plays back recorded images in reverse chronological order.
Earliest image playback	Plays back from the earliest recorded image.
Latest image reverse playback	Plays back in reverse from the most recent recorded image.
Fast forward/reverse playback	Plays back recorded images forward or in reverse at 2x, 4x or 8x speed. Playback speed can be increased using the 1-minute/ 10-minute skip playback function.
Pause	Temporarily stops playback and displays still pictures.
Frame advance/reverse playback	Plays back images in pause on a frame by frame basis.
Instant event access playback	Moves to the event start time (Priority recording, Alarm Event recording and Normal recording) to begin playback.

### 16.2. How to Perform Playback

Performing playback operation during live mode switches the display to the playback mode.

#### Notes

- If power is turned off, the playback starts from the earliest image.
- Playback performance could be degraded during live transmission, playback transmission or downloading using the PC's Web browser.

#### 16.2.1. Playback

Press the Play [] key.

Recorded images are played back. The Playback key lights green, displaying the playback screen. When playback is performed again, playback begins from the time at which it last stopped.

#### 16.2.2. Reverse playback

Press the Reverse Play [] key.

Plays back recorded images in reverse chronological order. The Reverse Play key lights green, displaying the reverse playback screen.

When reverse playback is performed again, it begins from the time at which it last stopped.

#### 16.2.3. Playback stop

Press the Stop [] () key.

Stops pictures being played back. Stopping the playback switches the display to the live mode.

#### 16.2.4. Earliest image display

Press the Play [▶] key while holding down the Playback Stop [⏏] (■) key.  
Playback begins from the time at which the earliest image was recorded.

#### 16.2.5. Latest image reverse playback

Press the Reverse Play [◀] key while holding down the Playback Stop [⏏] (■) key.  
Reverse playback begins from the time at which the latest image was recorded.

#### 16.2.6. Fast forward/reverse playback

Press the Play [▶] key (Reverse Play [◀] key when in reverse playback mode) during playback.  
Fast forward playback (fast reverse playback when in reverse playback mode) is initiated. Playback speed cycles through 2X, 4X and 8X whenever the key is pressed. The speed can be increased using the 1-minute or 10-minute time skip function.

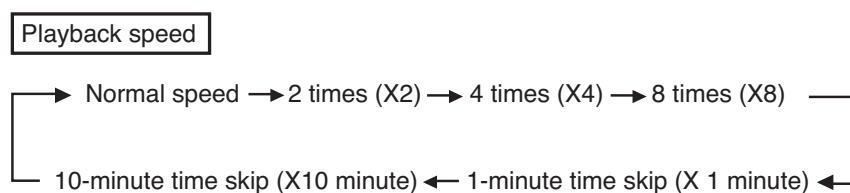

#### Notes

- The 1-minute/10-minute skip function may not operate correctly if recordings are made with the clock turned back.
- Recorded images may not be played back at the indicated speed depending on the hard disk access time, etc.
- For the pre-recorded recording data, it cannot playback skips forward in 1-minute/10-minute segments.

#### 16.2.7. Pause

1. Press the Pause [⏏] (■) key during forward or reverse playback.  
Playback is temporarily stopped and the key lights green.
2. To perform playback or reverse playback again, press the Play [▶] key or Reverse Play [◀] key.  
Pause mode is cancelled and forward or reverse playback begins again.

#### 16.2.8. Frame advance/frame reverse playback

Press the Play [▶] key or Reverse Play [◀] key with the Pause [⏏] (■) key pressed, while recording is temporarily stopped.  
Frame advance or reverse playback is performed per screen whenever the key is pressed.

## 16.3. Event

Events that can start recording include Priority recording, Normal recording, Alarm input recording, and Motion detection recording. Each event can be confirmed using the recording log. (Refer to p. 98; Recording Log.)

### 16.3.1. Instance event access

Recording moves to the event start time (Priority recording, Alarm Event recording or Normal recording) and temporarily stops. Playback images can be moved from event to event and required images can be quickly searched.

#### [Instant access to the next event]

Hold down the Play [▶] key for 2 seconds or more while recording is temporarily stopped. Recording advances to the beginning of the next event and temporarily stops.

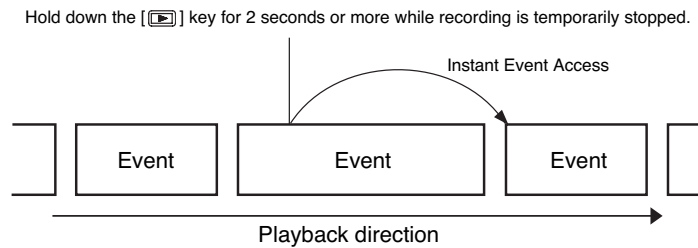

#### [Instant access to the previous event]

Hold down the Reverse Play [◀] key for 2 seconds or more while recording is temporarily stopped. Recording advances to the beginning of the previous event and temporarily stops.

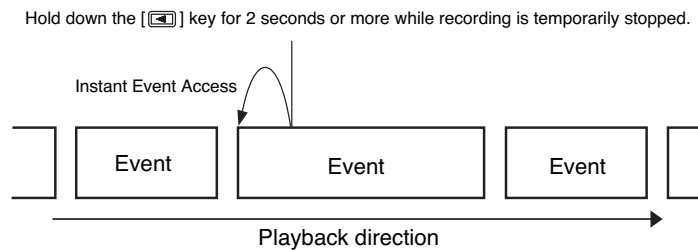

## 17. SEARCH

Pressing the Search key in the live mode or in the playback mode displays the search screen. Two search methods are available: Date/time search by designating the specific time, and event search by designating the event.

### Note

It may take a relatively long time to search (During recording, Web playback distribution, Web download or Expansion unit connection). It also takes time to search if a lot of event numbers exist.

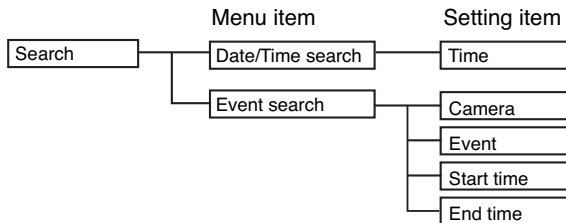

### 17.1. Date/Time Search

Entering the date and time to perform a search displays all camera images recorded closest to the designated time in freeze-frame on the 16-segment (or 9-segment) split screen display. If no recording is made on the designated date and time, the date and time closest after the designated date and time is displayed. The oldest and newest times for recorded data are displayed, so please enter dates and times occurring between these.

1. Press the Search key.  
The Search screen is displayed.
2. Select "DATE/TIME SEARCH," press the Menu key.  
Date/Time search screen is displayed.
3. Move the cursor with the [▶] and [◀] keys and perform clock settings using the [+] and [-] keys. Set year, month, date, hour, minute, and second.
4. Move the cursor to "EXECUTE" and press the Menu key.  
Images recorded at the time closest to the designated time are displayed.

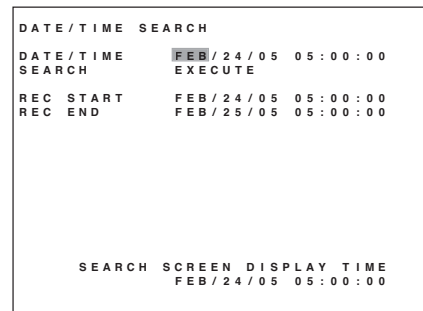

Item	Selection	Description
DATE / TIME	JAN / 01 / 00 00:00:00 – DEC / 31 / 99 23:59:59	Designate the date and time to research.
SEARCH	EXECUTE	Search begins if "Execute" is selected.
REC START	—	Displays the time for the oldest video recording.
REC END	—	Displays the time for the newest video recording.
SEARCH SCREEN DISPLAY TIME	—	Displays the time at which the search screen was displayed.



An error message is displayed at upper right of the screen if images does not exist after the designated time. Pressing the Menu key moves the cursor to the previous position.



### Notes

- In some cases, changing the current time may make it impossible to search by time when duplicate time data exists in the hard disk.
- When recording with overwrite permission, recorded images are overwritten three minutes after the time search screen has been displayed, making it impossible to search or display data in the vicinity of the oldest time. Refer to Search Screen Display Time.

## 17.2. Event Search

The event search begins under the designated conditions.

1. Press the Search key.  
The search screen is displayed.
2. Select “EVENT SEARCH,” then press the Menu key.  
Event search screen is displayed.
3. Move the cursor with the [▲], [▼], [◀], and [▶] keys, and perform camera, event, start time and end time settings using the [+] and [-] keys.
4. Move the cursor to “EXECUTE,” then press the Menu key.  
Event search list is displayed.
5. Move the cursor using the [▲] and [▼] keys, select the desired event from the event search list, and then press the Menu key. The image at the event start time is displayed in freeze-frame on the 16-segment (or 9-segment) split screen display.

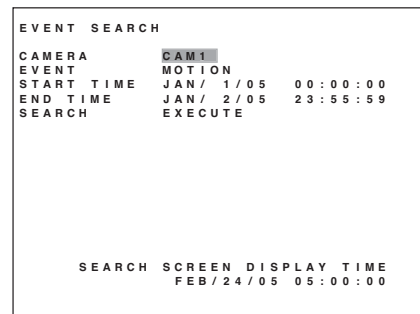

An error message is displayed if an event corresponding to the designated conditions does not exist. Pressing the Menu key moves the cursor to the previous position.



Item	Selection	Description
CAMERA	CAM 1-16 / ALL	Select the camera number to search.
EVENT	PRIORITY / NORMAL / ALARM / MOTION / ALL	Select the event type to search.
START TIME	JAN / 01 / 00 00:00:00 - DEC / 31 / 99 23:59:59	Designate the search start time. It is not possible to enter a start time value that is greater than that of the end time.
END TIME	JAN / 01 / 00 00:00:00 - DEC / 31 / 99 23:59:59	Designate the search end time. It is not possible to enter an end time value that is smaller than that of the start time.
SEARCH	EXECUTE	Search begins if Execute is selected.
SEARCH SCREEN DISPLAY TIME	—	Indicates the time when the search screen is displayed.



## 18. ARCHIVE

The Digital Video Recorder is equipped with an archive function that transfers image data recorded on the hard disk to DVD-R/RW disk (available only to models with DVD drives) or USB memory. Camera image data designated between start position and end position can be archived. Since dedicated viewer software is also downloaded at the same time, archived images can be easily played back on a PC.

### Note

Archive operation can be performed only at the operation level 1. When the security has been set, perform archive operation after login to the Operation Level 1.

Two methods can be used to designate the archiving range.

- Designate the archiving range after entering date and time.
- Designate the archiving range while viewing the playback image.

### [ Archiving to USB memory devices ]

#### Notes

- Connect the USB memory device to the copy terminal of the Digital Video Recorder.
- Only mass storage class devices (those recognized as "USB mass storage memory devices" under Windows 2000/XP) can be used.
- Compatible with USB 1.1 devices only. Not compatible with USB 2.0 devices.
- USB memory devices formatted with FAT12/FAT16 can only be used.
- It is not possible to play back video files copied to the USB memory device on the Digital Video Recorder. Connect the USB device to a PC and use viewer software to play back files.
- If USB memory is removed when USB archive is in progress, the Digital Video Recorder will then be unable to recognize USB memory. Be sure to remove it after finishing archiving or after archive operation is stopped.

### [ Archiving to DVD media (models with DVD drives only) ]

#### Notes

- Usable media: DVD-R, DVD-RW  
Unusable media: DVD-R DL, DVD+R/RW, DVD+R DL, and DVD-RAM
- Data cannot be added to DVD media after the initial copying. If using a DVD-RW, first erase any existing data on the disc before using it. (This must be done on a PC and cannot be done on the Digital Video Recorder.)
- It is not possible to play back video files copied to a DVD on the main unit. Insert the DVD in the drive of a compatible computer and use viewer software to play back files.
- Do not play DVDs copied on the Digital Video Recorder in a standard DVD player as doing so risks damaging the DVD player.
- Playback cannot be performed on a PC if the power is turned off during DVD archiving, as archiving is not complete, making it impossible to recognize DVD media.

## 18.1. Archiving & Transfer Times

Refer to the table below for time required to archive or transfer files to USB memory devices or DVD media. Times are shown for the files of the set maximum size.

When archive begins, viewer software (capacity: about 300 KB) is also downloaded at the same time.

### USB Memory Devices (USB 1.1)

Capacity	64 MB	128 MB	256MB	512MB	1GB
Archiving Time *1	7 seconds	15 seconds	30 seconds	1 minute	2 minutes
Number of Files *2	900	1,800	3,600	7,200	14,400

### DVD Media (4.7 GB)

Transfer Speed	X 2	X 4	X 8	X 16
Archiving Time *1	9 minutes			
Number of Files *2	Approximately 66,000			

\*1 Archiving times available in the below state are shown. Archiving time will be longer if the total recording rate is made smaller or the picture quality level is lowered.

[Recording conditions] Picture quality level: 1 (Max. 64 KB)

Total recording rate: 120 IPS (Disk mode: Normal)



\*2 Lowering the picture quality level increases the number of files.

#### Note

Transfer time will be longer if the Digital Video Recorder is accessing the hard disk drive (during recording, playback, and Web connection).







## 18.2. Archiving by Entering the Date and Time

Use this method for archiving when the date and time are known. Insert the DVD to be archived into the Digital Video Recorder or connect the USB flash memory to the Digital Video Recorder.

1. Hold down the Menu key for 2 seconds or more.  
Menu screen is displayed.
2. Move the cursor with the [] and [] keys, select "IMAGE ARCHIVING," and press the Menu key.  
Image archive screen is displayed.
3. Using the [+] and [-] keys, enter the time and date for Start 1 and End 1.
4. To continue to archive other data, repeat Step 3.  
Up to 5 start and end "dates and times" can be set.

### Note

Divide folders before archiving. Dividing folders results in fewer files in each folder, thereby making searching and display faster.

5. Move the cursor with the [] and [] keys and perform camera setting using the [+] and [-] keys.  
Select the camera to be archived from "CAMERA 1-9" and "ALL." (For 16 channels, up to camera 16 can be selected.)
6. Move the cursor using the [] and [] keys, select "EXECUTE," and then press the Menu key.  
A message box for selection of either USB or DVD is displayed at the upper right of the screen. (model with DVD drive only)  
For the model without DVD drive, Selection message "Yes" or "Cancel" is displayed.
7. Move the cursor using the [] and [] keys, select "USB" or "DVD," and then press the Menu key.  
For the model without DVD drive, select "Yes," then press the Menu key.

```
IMAGE ARCHIVING
START POS1  FEB/07/05 12:01:00
END POS1    FEB/07/05 13:02:00
START POS2  FEB/07/05 12:03:00
END POS2    FEB/07/05 13:04:00
START POS3  FEB/07/05 12:05:00
END POS3    FEB/07/05 13:06:00
START POS4  FEB/07/05 12:07:00
END POS4    FEB/07/05 13:08:00
START POS5  FEB/07/05 12:09:00
END POS5    FEB/07/05 13:10:00
CAMERA      CAMERA3
TRANSFER    EXECUTE
REC START   FEB/01/05 8:00:00
REC END     FEB/20/05 17:30:00
```

```
EXECUTE?
USB DVD  CANCEL
```

USB: Archive to the USB memory.  
DVD: Archive to the DVD-R/RW.  
Cancel: Reverts to the previous cursor position without executing.

### 18.3. Archiving from the Playback Screen

Use this method to archive while viewing the playback screen. Insert the DVD to be archived into the Digital Video Recorder or connect the USB flash memory to the Digital Video Recorder.

1. While playing back recorded images, press the Pause key at the point where archiving is to begin. Then press the Menu key.  
The image archiving screen is displayed.
2. Press the Menu key.  
The time at which recording was temporarily stopped is entered into the start position.
3. Press the [◀] key to terminate the image archiving screen.  
The screen reverts to the screen in pause mode.
4. While playing back recorded images, press the Pause key at the point where archiving is to end, and press the Menu key.  
The image archiving screen is displayed.
5. Move the cursor to the end position using the [▼] key and press the Menu key.  
Time during pause mode is entered at the end position.
6. To continue to archive other data, repeat Steps 1 – 5.  
Up to 5 separate start and end times can be set.  
Date and time can be changed with (+) and (-) keys.

#### Note

Divide folders before archiving. Dividing folders results in fewer files in each folder, thereby making searching and display faster.

7. Move the cursor with the [▲] and [▼] keys and perform camera setting using the [+] and [-] keys.  
Select the camera to be archived from "CAMERA 1– 9" and "ALL." (For 16 channels, up to camera 16 can be selected.)
8. Move the cursor using the [▲] and [▼] keys, select "EXECUTE," and then press the Menu key.  
A message box for selection of either USB or DVD is displayed at the upper right of the screen. (model with DVD drive only)  
For the model without DVD drive, Selection message "Yes" or "Cancel" is displayed.
9. Move the cursor using the [◀] and [▶] keys, select "USB" or "DVD," and press the Menu key.  
For the model without DVD drive, select "Yes," then press the Menu key.

```
IMAGE ARCHIVING
START POS1 FEB/07/05 12:01:00
END POS1 FEB/07/05 13:02:00
START POS2 FEB/07/05 12:03:00
END POS2 FEB/07/05 13:04:00
START POS3 FEB/07/05 12:05:00
END POS3 FEB/07/05 13:06:00
START POS4 FEB/07/05 12:07:00
END POS4 FEB/07/05 13:08:00
START POS5 FEB/07/05 12:09:00
END POS5 FEB/07/05 13:10:00
CAMERA CAMERA3
TRANSFER EXECUTE
REC START FEB/01/05 8:00:00
REC END FEB/20/05 17:30:00
```

```
EXECUTE?
USB DVD CANCEL
```

USB: Archive to the USB memory.  
DVD: Archive to the DVD-R/RW.  
Cancel: Reverts to the previous cursor position without executing.

## 18.4. Display During Archiving

### 18.4.1. Display during archiving

The screen below is displayed when archive begins. (\* represents the block No.1 - 5 during archiving.)  
Live screen is displayed during archiving, enabling full screen displays, multi-segment split-screen displays, sequence displays and zoom displays operations.

#### Note

Playback, triplex setting, position setting, search and menu display cannot be performed during archiving. Logout does not work even if logout time elapses.

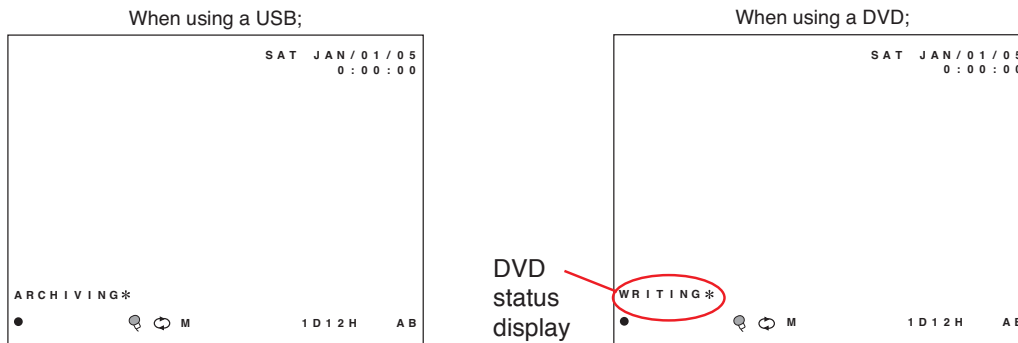

#### [ DVD status display ]

Display changes "CALCULATING THE FILE" → "PREPARING AN IMAGE" → "WRITING" → "FINISHING."

### 18.4.2. Archiving stop

Data transfer can be aborted with the Stop key. A confirmation message is displayed. Move the cursor to the desired selection using the [◀], and [▶] keys and press the Menu key.

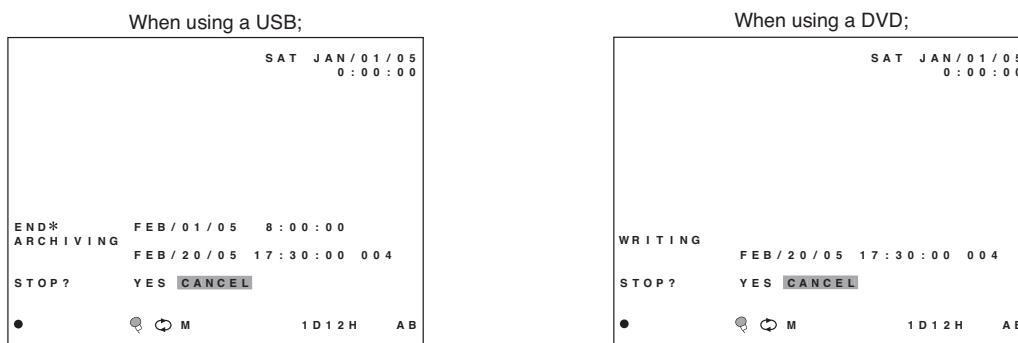

YES: Stops.

CANCEL: Continues archiving.

#### Notes

- There may be cases when it takes some minutes until archiving actually stops even if you stop DVD archiving.
- The PC will be unable to recognize DVD media when you stop DVD archiving in the middle of archiving.

### 18.4.3. Archiving completion

When using a USB, the indication "ARCHIVING" disappears after data transfer completion and the screen reverts to the live mode.

When using a DVD, the indication "FINISHING" disappears after data transfer completion and the screen reverts to the live mode. The DVD is automatically ejected from the DVD receptacle tray.

#### 18.4.4. About error messages

The following error messages are displayed if an error should occur during archiving:

- **Terminated for lack of available media space.**  
This message is displayed when the data size to be archived exceeds the destination media capacity and shows that the archiving is aborted, as the media is full with data already written. To continue archiving, insert a new media and perform archiving again.
- **Transfer error has been detected.**  
This message is displayed if archiving media is not inserted or connected. Ensure that the media is correctly inserted or connected.  
If the inserted disk already has included data, the transfer error message is displayed. In such cases, replace it with a new disk.
- **Start and end positions not correctly set.**  
This message is displayed when the times of start and end positions are entered in reverse order. Reset correctly.
- **Nothing found.**  
Displayed when the time that no recording data exists is designated or when no existing camera is designated.

### 18.5. When Viewing Saved Data

#### 18.5.1. PC Operating conditions and image data

OS: Windows 2000/XP

CPU: Pentium II, 400 MHz or faster

Memory: At least 64 MB

Hard Disk Capacity: 10 MB or more

Image data is saved as JPEG files at a resolution of 720 X 240. Playing files using the special viewer software downloaded at the time of archiving will change the resolution to 720 X 480.



## 18.5.2. Folder Configuration and File Name

### Notes

- Folder name or file name at the time of DVD archiving is referenced in Time zone setting (Refer to p.90, Network Setting.). Folder name or file name is displayed correctly only when time zone setting has been performed correctly.
- Folder name or file name is to be created at standard time when recording data during summer time period is archived. To replace it with summer time indication, advance 1 hour.
- The name of the viewer software will differ depending on which type of media is being archived to.
  - For USB memory devices the name will be "VIEWER.EXE".
  - For DVD media the name will be "ResizeViewer.exe".

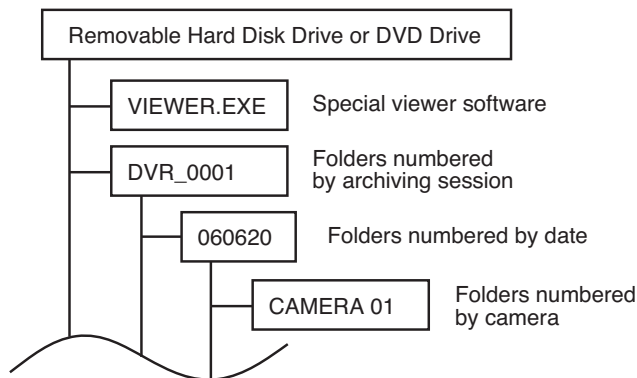

### Special Viewer Software:

This software is downloaded to the target media during archiving. Its functions include resizing copied videos, continuous or frame advance playback, and tampering/alteration check.

### Folders Numbered by Archiving Session:

It is possible to divide archived data into folders by designating multiple start and end times when archiving. When adding new files to USB memory devices, the new folders are numbered starting by automatically adding 1 to the largest existing folder number. Folder numbers are from 0001 to 9999.

### Folders Numbered by Date:

A separate folder is created for each copy session with a different date, with each folder name shown as a set of numbers indicating "YEAR MONTH DAY". For example, a folder named "06 07 20" refers to a folder created on July 20th, 2006.

### Folders Numbered by Camera:

A separate folder can be created for each camera number. If there are nine cameras, for example, then these folders will be numbered 01 through 09 (or 01 through 16 if there are 16 cameras), with JPEG files stored therein.

### File Names:

File names are comprised of "HOUR MINUTE SECOND, SCREEN NUMBER". HOUR is from 00–23. MINUTE is from 0–59. SECOND is from 0–59. SCREEN NUMBER, from 01–60, differentiates frames taken at the same time. (The number of frames will vary depending on the recording rate set for each camera.) The extension on all file names is .jpg.

For example, a file named "13 05 49 08.jpg" refers to file created as the 8th frame taken at the time 13:05:49.

### 18.5.3. Playback by way of viewer software

Follow the procedure below to view the archived images on a PC.

1. Insert a recorded medium into the PC.  
Insert a USB memory or DVD medium into the PC.
2. Select the medium from the PC's drive and double-click on it.
3. Select View Software in the medium and double-click on it.  
A Viewer software is activated.
4. Click on the  button located at the lower right of the screen.  
The data folder boots up.  
File selection screen is displayed.
5. Select the folders numbered by camera or image file, and click on "OK."  
Images are displayed followed by folder name and file name.
6. View images using the button located at the lower left of the screen.

 : **Reverse Playback button**  
Plays back recorded images in the reverse direction.

 : **Frame Reverse button**  
Performs a frame-by-frame playback in the reverse direction. Pressing this button while the Recorder is in Playback or in Reverse Playback stops playback temporarily.

 : **Frame advance button**  
Performs a frame-by-frame playback in the forward direction. Pressing this button while the Recorder is in Playback or in Reverse Playback stops playback temporarily.

 : **Playback button**  
Plays back recorded images in the forward direction.

 : **Print button**  
By pressing the print button, an image will be printed.

 : **Tamper Check button**  
By pressing this button, data tampering or alteration will be checked.

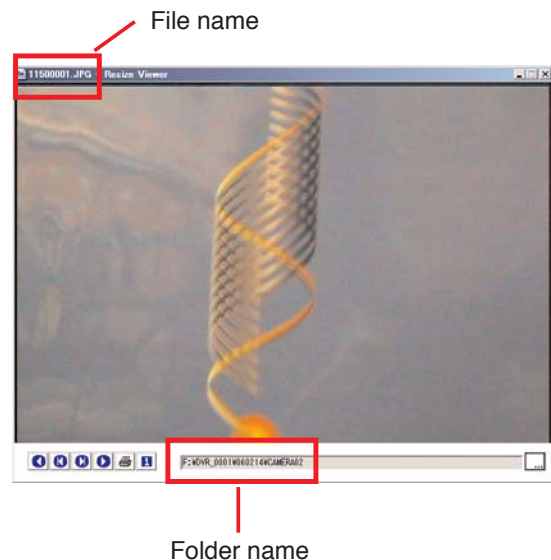

#### Notes

- If playback (reverse playback) is selected, playback (reverse playback) repeats endlessly.
- Playback (or reverse playback) will be at 10 frames per second regardless of recording time.

#### 18.5.4. Tampering/Alteration Check

The viewer software includes a function to check for data tampering or alteration. If altered data is found, an error message is displayed. The Tamper Check key is only available when playback is paused.

1. While playback is paused, press the Tamper Check key.  
This activates the Tamper/Alteration Check function.

2. Press the Play or Reverse Play button.

##### **For USB memory devices:**

Checks the video file frame by frame to discern whether there has been tampering or alteration. Nothing is displayed if no abnormalities are found. If abnormalities are found, then an error message appears and the altered video is paused.

##### **For DVD media:**

Confirms whether the DVD is in fact the one copied from the digital video recorder. Nothing is displayed if no abnormalities are found. If the DVD is found to be one other than that copied from the main unit, then an error message appears and the video is paused.

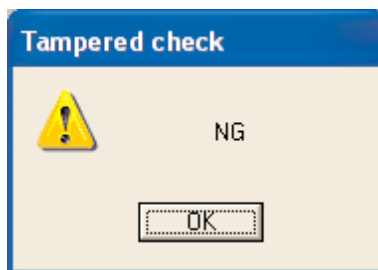

##### **Note**

Deactivate "Drive Letter Access (DLA)" when packet writing software is installed in a PC. Otherwise tampering/alteration check does not function correctly. Uncheck the box "Activate drive's DLA" tab in the property of DVD drive.

## 19. ABOUT SECURITY SETTING

Each level of security settings can be made for each operation or setting of the Digital Video Recorder. The following three types of security methods are available.

1. Secure the Digital Video Recorder's operating keys.
2. Secure against external remote access.
3. Secure against web access

Using the above security methods in combination allows a higher level of security than using any one method alone. The following describes the various available security functions.

### 19.1. Securing the Digital Video Recorder's Operating Keys

Security can be set at any of four operating levels (1, 2, 3 or Full-lock) using a six-digit password and USB key. Permissions can be allowed or disallowed for each operating level, as shown in the table below.

Operation item	Operation Level			
	High			Low
	Operation Level 1	Operation Level 2	Operation Level 3	Full-Lock
Menu Setting	○	×	×	×
Archive	○	×	×	×
Recording/ Playback	○	○	×	×
Priority Recording	○	○	△ (*1)	×
Triplex	○	○	×	×
Camera Operation	○	○	○	○ (*2)
Live Screen Operation	○	○	○	×
Alarm Reset	○	○	×	×
Buzzer Reset	○	○	○	○

Operation Level 1	All functions available, including setting changes and archiving. Entering the corresponding password gives access to Operation Level 1 from any other operation level.
Operation Level 2	Live and recorded images can be monitored, however setting changes and archiving cannot be operated. Entering the corresponding password gives access to Operation Level 2.
Operation Level 3	Only recorded images can be monitored. The Priority Recording key can be used if settings are performed(*1). Entering the corresponding password gives access to Operation Level 3.
Full-Lock	No operation possible. If Operation Level 3 is valid (Password 3 has been set), the system automatically switches to "Full-Lock" mode when the user logs out of Operation Level 3 or when the log-out interval elapses.

Log-Out Time	Can be set to 1, 5, 10, 30 or 60 minutes or OFF. If no operations are performed for a pre-set period of time after log-in, the system automatically logs out, moving to the lowest set operation level. [Example] When Operation Levels 1 and 2 are valid (Passwords 1 and 2 have been set), the operation level after log-out is Level 3.
Priority recording operator Level 3	Selecting ON permits the Priority Recording key to be used even when Operation Level 3 is valid. If OFF is selected, the Priority Recording key cannot be used when Operation Level 3 is valid. Regardless of this ON/ OFF setting, the Priority Recording key can always be used at Operation Levels 1 and 2, and cannot be used when in Full-Lock mode.

(Factory-preset to OFF.)

(\*1) Whether or not to make the Priority Recording key usable at Operation Level 3 can be set in the "Priority Recording Operation Level 3" settings.

(\*2) The camera menu cannot be displayed on the full screen.

### 19.1.1. Passwords and operation levels

If no passwords have been set, Operation Level is "1."  
Refer to the table below if a password has been set.

Pattern	Operation level				
	Set Password	Operation Level 1	Operation Level 2	Operation Level 3	Full-Lock
1	Password 1	○	<b>█</b> △		
2	Password 2	○	← <b>█</b> △		
3	Password 3	○	←	← <b>█</b> △	
4	Password 1, 2	○	<b>█</b> ○	△	
5	Password 2, 3	○	← <b>█</b>	○ <b>█</b> △	
6	Password 1, 3	○	<b>█</b> ○	← <b>█</b> △	
7	Password 1, 2, 3	○	<b>█</b> ○	○ <b>█</b> △	

△ : Level after log-out.

← : No operation level exists since no password has been set.

Enter the password corresponding to the desired operation level.  
Operation levels after log-out are shown enclosed in a bold rectangle.

#### • Pattern 1

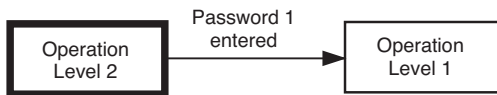

#### • Pattern 3

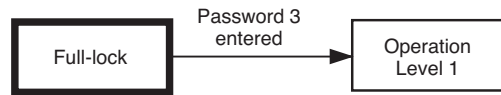

#### • Pattern 4

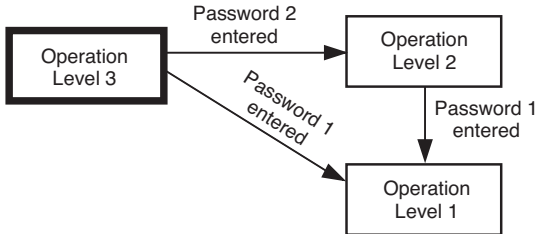

#### • Pattern 6

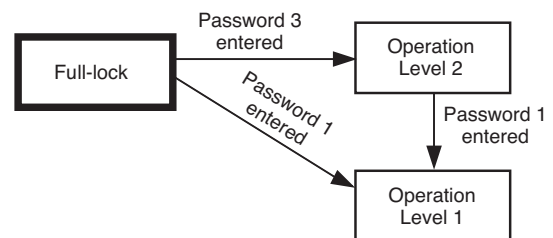

#### • Pattern 7

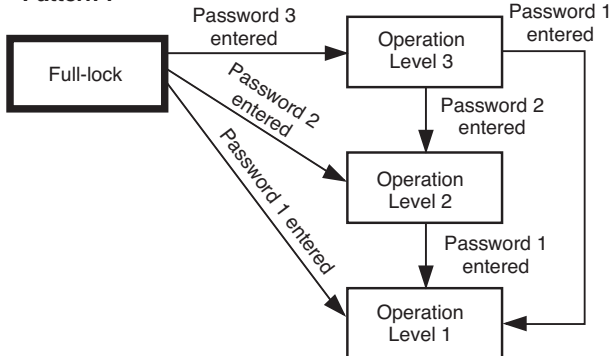

## 19.2. Security Settings Using a USB Key

Operation access can be limited by registering the USB memory device as a USB key with the Digital Video Recorder. Security settings can be activated and deactivated by inserting or removing the registered USB key in a USB port equipped with key-lock functions. (Refer to p. 96; Security Setting.)

### 19.2.1. USB Key Level Settings and Operation Levels

Login and logout among operation levels by USB key level settings are as follows. Inserting the USB key logs the user in at the [ ] operation level. Removing the USB key logs the user out of the [ ] operation level. (Refer to p. 96; Security Setting.)

#### [ USB Key Level – For Operation Level 1 ]

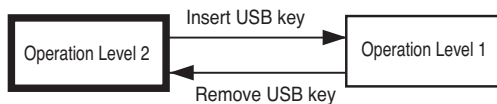

#### [ USB Key Level – For Operation Level 2 ]

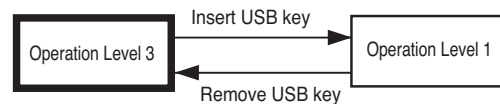

#### [ USB Key Level – For Operation Level 3 ]

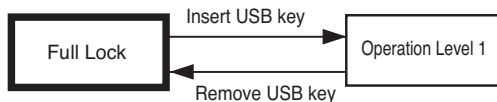

#### [ USB Key Level – Deactivated ]

No USB key-activated key lock. Always at operation level 1.

### 19.2.2. USB Key registration

#### Notes

- Multiple USB key registrations are available.
- Neither USB key registration nor reset can be performed via a network.

1. Insert the USB memory into the [KEY LOCK] terminal.
2. Hold down the Menu key for 2 seconds and more.  
Menu screen is displayed.
3. Move the cursor with the [▲] and [▼] keys, select "MAINTENANCE," and then press the Menu key.  
Equipment Maintenance screen is displayed.
4. Move the cursor with the [▲] and [▼] keys, select "EXECUTE" in USB key registration, and press the Menu key. The USB key registration is available.
5. Select the USB key level of the Security settings from "Level 1," "Level 2," "Level 3," or "Invalid." (Refer to p. 96; Security setting.)
6. Remove the USB memory from the [KEY LOCK] terminal after saving the settings.  
The operation level set in the Key level settings becomes available.

### 19.2.3. Resetting the USB Key registration

#### Note

If multiple USB keys are registered, use the following method to erase the registration for all at once. It is not necessary to insert the USB key(s) when erasing all registrations.

1. Hold down the Menu key for 2 seconds and more.  
Menu screen is displayed.
2. Move the cursor with the [▲] and [▼] keys, select "MAINTENANCE," and press the Menu key.  
Equipment Maintenance screen is displayed.
3. Move the cursor with the [▲] and [▼] keys, select "EXECUTE" in USB key data erasure and press the Menu key.  
The USB key registrations are erased, and the "USB Key Level" security setting is deactivated.

### 19.3. Login and Logout by Password

Hold down the Menu key for 2 seconds or more to login to the system by entering a password. The display screen and operation procedure differ depending on the operation level.

#### 19.3.1. Password Entry

While in the password entry screen (screen A), password entry is as follows.

1. Use the [◀] key to move the cursor to select "=====".
2. Use the camera selection keys to enter the six-digit password.  
" \* " will be displayed for each character entry.
3. Press the Menu key.  
If the password is correct, login is completed. If the password is incorrect, the message "unrecognized Password" is displayed on the upper right of the screen.

#### 19.3.2. When USB key settings are invalid...

##### [ When operation level is Full-Lock... ]

1. Hold down the Menu key for 2 seconds or more.  
Password entry screen (Screen A) is displayed.
2. Select "PASSWORD," "CLEAR," or "CANCEL" and press the Menu key.  
PASSWORD: Logs in to the operation level corresponding to the entered password.  
CLEAR: Deletes the entered password.  
CANCEL: Switches the display to live mode without changing the operation level.

Screen A

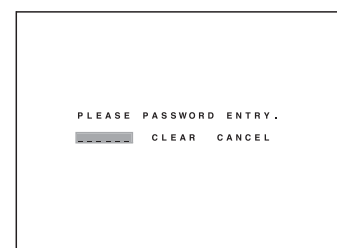

**[ When operation level is “Level 2” or “Level 3”... ]**

1. Hold down the Menu key for 2 seconds or more.  
Login or Logout selection screen (Screen B) is displayed.
2. Select “LOGOUT,” “LOGIN,” or “CANCEL” and press the Menu key.  
LOGOUT: Logs out of the system and switches the display to live mode.  
LOGIN: Displays the password entry screen (Screen A). (Advance to Step 3.)  
CANCEL: Switches the display to live mode without changing the operation level.
3. Select “PASSWORD,” “CLEAR,” or “CANCEL” and press the Menu key.  
PASSWORD: Logs in to the operation level corresponding to the entered password.  
CLEAR: Deletes the entered password.  
CANCEL: Switches the display to live mode without changing the operation level.

Screen B

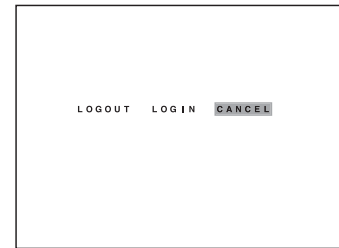

**[ When operation level is set to “Level 1”... ]**

1. Hold down the Menu key for 2 seconds or more.  
Menu setting or Logout selection screen (Screen C) is displayed.
2. Select “LOGOUT,” “MENU,” or “CANCEL” and press the Menu key.  
LOGOUT: Logs out of the system and switches the display to live mode.  
MENU: Displays the Main Menu screen.  
CANCEL: Switches the display to live mode without changing the operation level.

Screen C

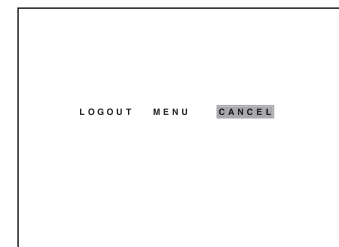

**19.3.3. When USB key settings are valid...**

Login and logout operations performed using passwords are the same as those described in “When USB key settings are invalid...” However, the USB key is required when logging in by entering the set password on the password entry screen. (Refer to p. 63; When USB key settings are invalid.)

**[ When the USB key is inserted... ]**

Logs in to the system and switches the display to live mode.

**[ When the USB key is not inserted... ]**

The screen (Screen D) requesting the USB key be inserted is displayed.

If “CANCEL” is selected, the display switches to live mode without changing the operation level.

Inserting the USB key gives access to the set operation level and switches the display to live mode.

Screen D





## 19.4. Security Settings Against Remote External Access

Settings that restrict remote access limit external access via remote controller or RS-232C terminal. Remote access restrictions allow security levels to be set for operation keys on the Digital Video Recorder. Setting remote access to "Restrict" allows restriction to the same operation level as on the Digital Video Recorder. (Password access and USB key access are activated.) Setting remote access to "Don't Restrict" removes all restrictions, allowing all operations. (Refer to p. 96; Security Setting.)

## 19.5. Security Settings Against Web Access

It is possible to set a login password that must be entered in order to operate the Digital Video Recorder using a web browser over a network. (Refer to p. 90; Network Setting.) Operation restrictions to administrator and user accounts are as follows.

	Live Transmission	Playback Transmission	Remote Control	Menu Access
Administrator Account (Root)	○	○	○	○
User Account (User)	○ <sup>*1</sup>	×	×	×

\*1 Users with User accounts can access combination camera manual operation, preset transfer, and auto operation, but not preset memory or camera menu operation.





### Note

Be sure to set the security for the Digital Video Recorder's operation keys. The password to be used for web access may be confirmed and changed in the network settings.

## 20. MALFUNCTION OPERATION

Causes of malfunctions and related operations are shown below. Activating the Buzzer setting will cause the buzzer to sound when a malfunction occurs. Activating the Control Output Terminal setting and Device Malfunction setting will cause the terminal to output a signal when a malfunction occurs.



	LED	Malfunction Log Display	Buzzer
Hard Disk Error	 FAILURE	HD ERROR	○
Video Loss	 FAILURE	VD DETECTED	○
Fan Malfunction	 FAILURE	FAN FAILURE	○
Remaining Capacity Warning	 HD FULL	HD REM ST	×
Hard Disk Full	 HD FULL	HD FULL	×

### 20.1. Stopping the Buzzer

Press the Cancel Alarm key to stop the buzzer.

### 20.2. Hard Disk Errors

An LED illuminates to indicate that an error has occurred with a connected hard disk drive. If the error has occurred during video recording, the recording is continued on another hard drive, regardless of disk mode. However, if the Digital Video Recorder is a single-drive unit (product number ending in -08, -1, D08, or D1), then recording is stopped.

#### Note

If a hard disk error has occurred, the Digital Video Recorder may not recognize not only the hard disk that an error has occurred but also the DVD drive connected to the slave.

#### 20.2.1. "Playback Stopped" Warning Display

If a hard disk error prevents playback in progress from continuing, then the warning message shown at right is displayed.

Press the Stop key to return to Live mode.



### 20.2.2. "Restart" Warning Display

If all of the connected hard disk drives (including expansion units) experience an error, then the warning message shown at right is displayed.

Press the power key continuously for two seconds or more to cut the power, then press the key again to restart.

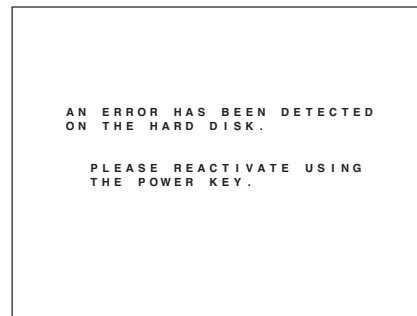

### 20.2.3. Checking Hard Disks When an Error Has Occurred

The menu can be used to check hard disk drive initialization. If a hard disk error occurs when hard disk drives are connected, "-----" is displayed.

(Refer to p. 102; Hard Disk Drive Initialization.)

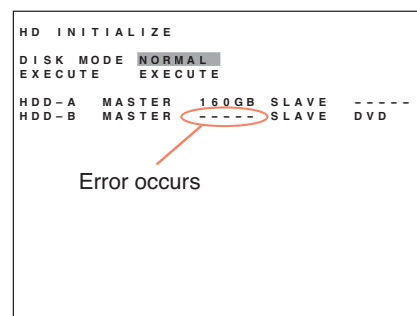

### 20.2.4. If a Hard Disk Error Occurs

If the disk drive is the Digital Video Recorder's:

- Restart the power.

#### Note

If the drive is restored by restarting the power, then some of the recorded data may be lost. Copy any necessary data to another location and initialize the disk.

- If the error persists even after restarting the power, then initialize the disk.

#### Note

Initializing the disk will cause all video and other data stored on it to be erased. Copy any necessary data to another location and initialize the disk.

- If the error persists even after the disk has been initialized, then it is necessary to replace the hard disk drive. Consult your TOA dealer for more information.

If the expansion unit's disk drive malfunctions:

- Check the connection cables, pulling them out and re-inserting them into their sockets.
- Restart the expansion unit, then restart the Digital Video Recorder's power supply.

**Note**

If the drive is restored by restarting the power, then some of the recorded data may be lost. Copy any necessary data to another location and initialize the disk.

- If the error persists even after restarting the power, then initialize the disk.

**Note**

Initializing the disk will cause all video and other data stored on it to be erased. If any of the data on the disk is needed, be sure to copy it to another location before initializing the disk.

- If the error persists even after the disk has been initialized, then it is necessary to replace the hard disk drive. Consult your TOA dealer for more information.

## 20.3. Video Loss

Video loss occurs when the camera has become disconnected from the camera input terminal. The camera input number and the date and time at which the video loss has occurred can be confirmed in the error log.

**Note**

Video loss will not occur for cameras for which Priority recording and Auto-Recoding has been set to "No," even if they are disconnected.

### 20.3.1. If video loss occurs...

- Restore the camera picture to stop the video loss error.
- Restart the power supply to stop the video loss error.
- For the camera for which video loss is occurring, change the recording settings to "No" to stop the video loss error. Set both Priority recording and Auto-Recoding to "No."

## 20.4. Fan Malfunction

A Fan Malfunction error occurs if the cooling fan is broken or has been interrupted by some foreign object. The time at which the fan malfunctioned can be confirmed by looking at the error log. If the fan is malfunctioning, a "\*" mark is also displayed at the bottom right of the screen.

### Note

A fan malfunction on an expansion unit will not be displayed by the Digital Video Recorder. Confirm fan malfunctions via the LED display on the front of the expansion unit.

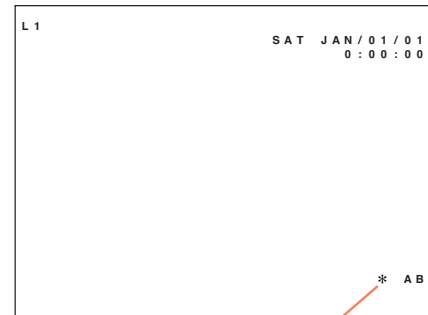

Fan Malfunction occurs

### 20.4.1. If a fan malfunction occurs....

First turn the power off. Operating the Digital Video Recorder without a functioning fan can cause heat buildup, potentially leading to burns or malfunction. Therefore, it is important to pull out the power supply plug immediately.

- If the malfunction has been caused by the presence of a foreign object in the fan, remove the object.
- If the fan is simply broken, it will need to be replaced. Consult your TOA dealer for more information.

## 20.5. "Hard Disk Full" Warning

If the overwrite setting is set to "Overwrite Protect" and the hard disk drive begins to run out of free space, a Remaining Capacity Warning begins. If no recording time remains, a Hard Disk Full error occurs. The time at which the Remaining Capacity Warning started or at which the hard disk became too full to record further, can be confirmed by looking at the error log.

### 20.5.1. If the hard disk becomes full....

- This will cancel the Hard Disk Full status. To set the overwrite setting to "Overwrite Protect" again, set the overwrite setting to "Overwrite Protect."
- Hard Disk Full status can be cancelled by initializing the hard disk and restart the power.

### Note

Initializing the disk will cause all video and other data stored on it to be erased. If any of the data on the disk is needed, be sure to copy it to another location before initializing the disk.

## **20.6. Operation Following Restoration From a Power Outage**

### **20.6.1. Monitor Display**

After a power outage, check the system, then display the live screen according to screen display settings when Monitors 1 and 2 are started in the menu.

### **20.6.2. Recording**

#### **[If the power outage occurred during Normal video recording....]**

Normal recording is made according to the set schedule.

#### **[If the power outage occurred during an Alarm Event video recording....]**

Alarm Event recording is reset. If the Alarm Event continues after the power is restored, then Alarm Event recording resumes.

#### **[If the power outage occurred during a Priority recording....]**

Priority recording resumes after the power is restored. If the Priority Recording Input mode is set to "Edge," then Priority recording resumes for a set post-alarm recording interval after the power is restored. If the Priority Recording Input mode is set to "Level," then Priority recording resumes after the power has been restored and continues until it is canceled at the Digital Video Recorder or remote controller.

## 21. SETTING PROCEDURES AND ITEM LIST

### 21.1. Basic Setting Procedures

[  ] in the figure represents the cursor. The examples following are for procedures for performing alphanumerical display settings.

1. Enter the Main menu screen.

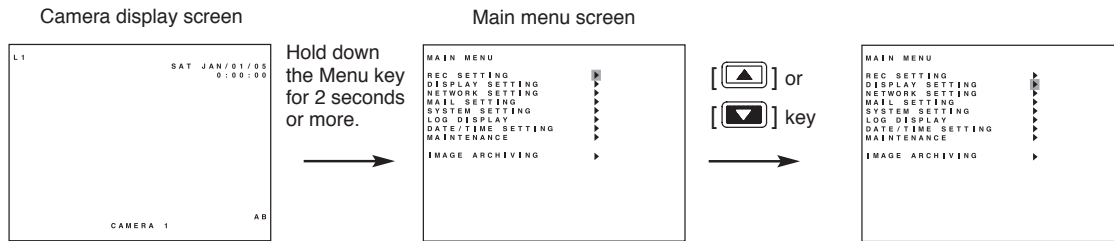

2. Enter the Setting screen.

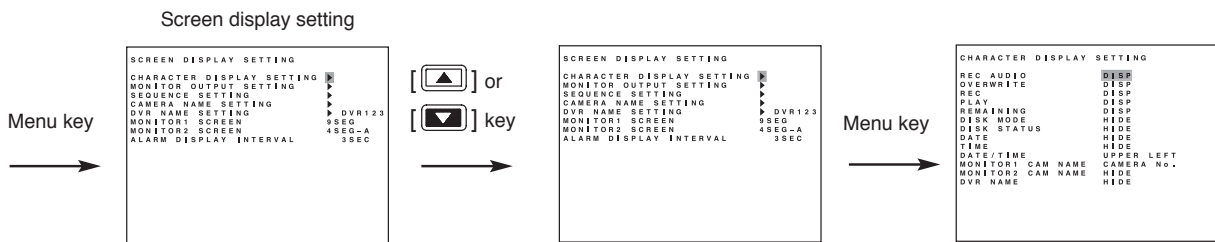

3. Select the setting contents.

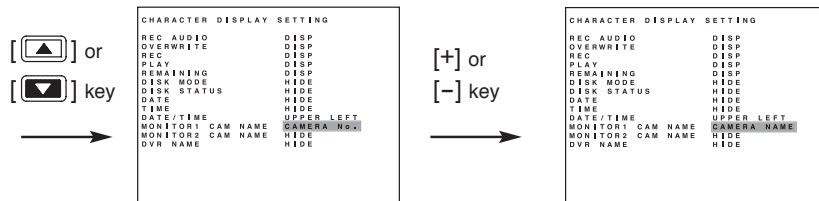

4. Save the setting contents.

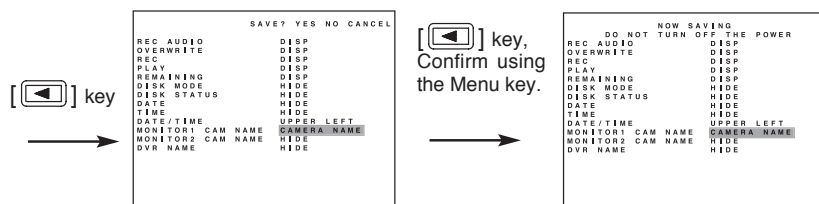

5. Return the display from the Menu screen to the Camera display screen.

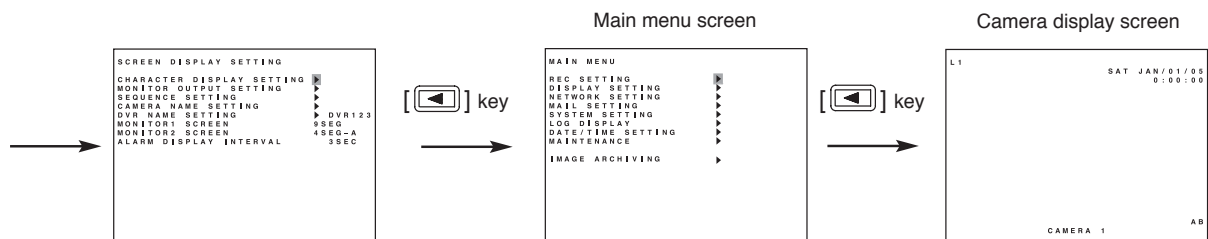

## 21.2. Setting Item List

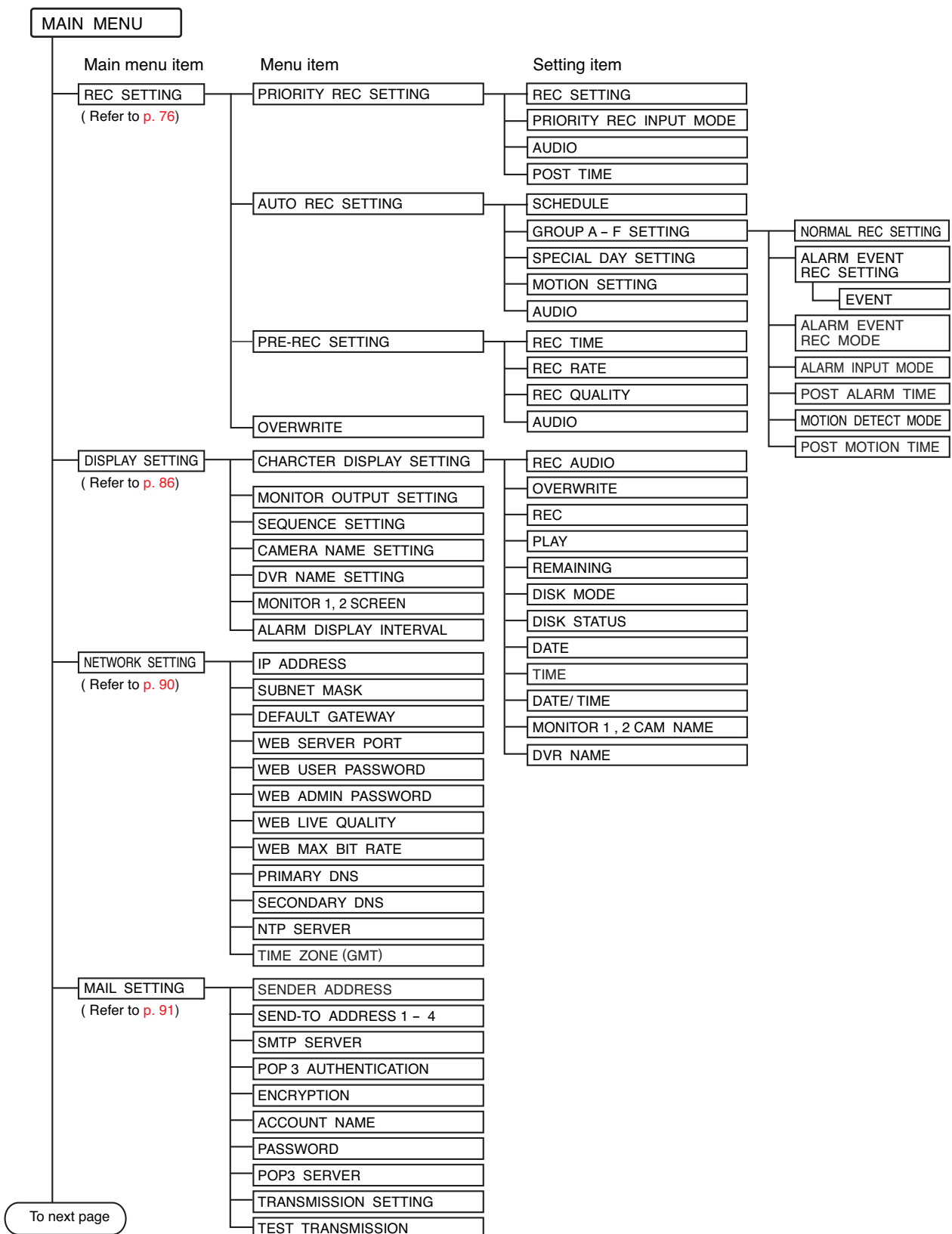

To next page



To previous page

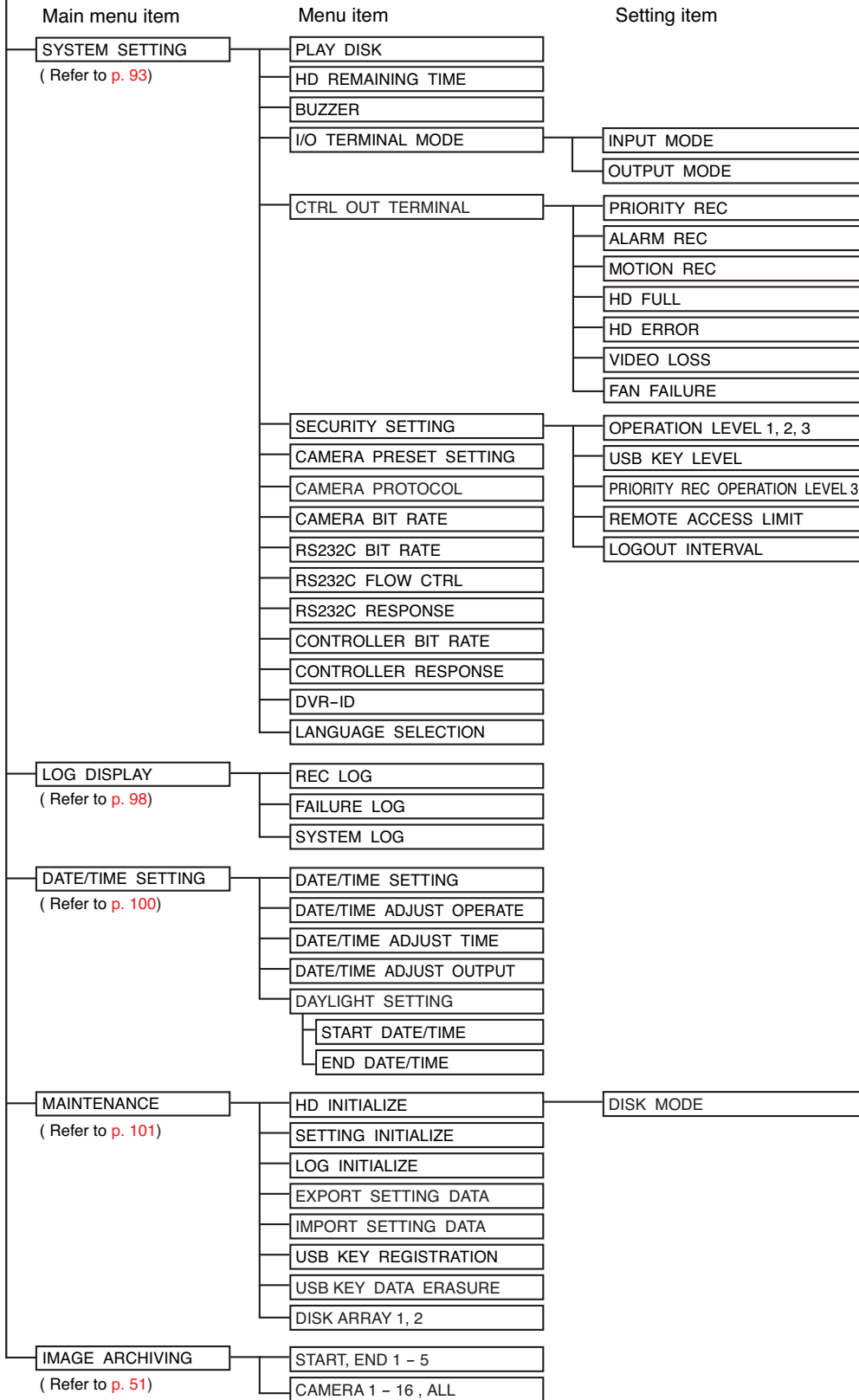

## 22. MAIN MENU SETTING

### 22.1. About the Main Menu Settings

To perform each setting, display the Menu screen when in live mode.

Recording setting .....	p. 76
Screen display setting .....	p. 86
Network setting .....	p. 90
Mail setting .....	p. 91
System setting .....	p. 94
Log display .....	p. 98
Date/time setting .....	p. 100
Maintenance .....	p. 101
Image archiving .....	p. 51

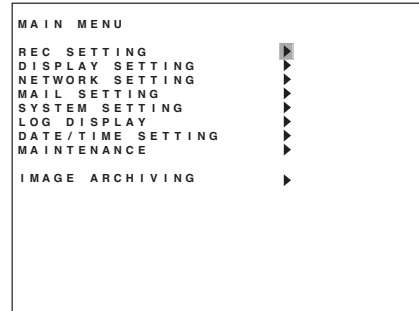

1. Holding down the Menu key for 2 seconds or more.  
Displays the Menu screen.

#### Notes

- Menu screen is not displayed while the Monitor Output 2 is selected. (while the Monitor key is lit).
- Display the Menu screen after returning to the live mode when in playback mode.
- Menu screen is not displayed while in zoom mode and during zoom display (while zoom key is lit)

2. To move the cursor, use the [▲] and [▼] keys.  
The [◀] and [▶] keys can be used to move the cursor only when there are setting parameters.

3. To select or change parameters, use the [+] and [-] keys.

4. Press the Menu key at the ▶ mark at the desired setting item.

#### If no change has been made to the current parameter:

The screen moves to the next screen.

#### If changes have been made:

Save setting confirmation message is displayed. (Refer to the next page.)

5. To exit the setting and return to the previous screen, press the [◀] key at the leftmost parameter position of the screen.

A Save Setting confirmation dialog is displayed if changes have been made. (Refer to the next page.)

If set value has not been changed, the screen moves to the previous screen, Exits the Menu screen when the Main Menu screen is displayed.

### 22.1.1. Saving settings

If setting change has been made on the screen, message is displayed at upper right of the screen when the screen moves. Move the cursor to the desired selection using the [◀] and [▶] keys, then press the Menu key.

- YES: Saves the settings, and the display moves to the previous or next screen.
- NO: Cancels the setting and moves to the previous screen.
- CANCEL: Returns to the original cursor position without moving to the previous screen.



Selecting "Yes" displays the message "NOW SAVING..." and the display moves to the previous or next screen after saving is complete.



**Note:** Do not turn off the power while the message "NOW SAVING..." is displayed.

### 22.1.2. Implementing Settings

Implementing a setting displays a message at the upper right of the screen. Move the cursor using the [◀] and [▶] keys and select [Yes] or [Cancel].

- YES: Executes the setting.
- CANCEL: Returns to the original cursor position without implementing the setting.



Selecting "Yes" displays the message "EXECUTE..."



Once the setting has been implemented, a message is displayed. Pressing the Menu key returns to the original cursor position.



## 23. RECORDING SETTING

Priority recording and Auto-recording (Normal recording and Alarm Event recording) modes are available. In each recording mode, “Recording ON/OFF,” “Recording rate,” and “Picture quality” can be set for each camera. For the Digital Video Recorder, data from the start to the end of a recording is regarded as an event. (Refer to [p. 38](#); Recording.)

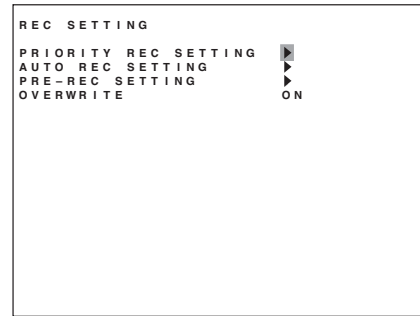

Item	Selection	Description
PRIORITY REC SETTING	—	For setting, refer to <a href="#">p. 77</a> ; Priority recording setting.
AUTO REC SETTING	—	For setting, refer to <a href="#">p. 79</a> ; Auto-recording setting.
PRE-REC SETTING	—	For setting, refer to <a href="#">p. 85</a> ; Pre-recording settings.
OVERWRITE	<u>ON</u> / OFF	Select whether or not to allow the overwriting of hard disk recordings. OFF: When all hard disks become full, recording is stopped to prevent older data from being replaced with new data. If the usable recording time is less than the Remaining Capacity Warning, the Disk Full LED will flash. (Refer to <a href="#">p. 93</a> ; System Settings) To begin recording again, initialize the hard disk. (Refer to <a href="#">p. 102</a> ; Hard Disk Drive Initialization.) ON: When all hard disks become full, previous recorded older images is automatically deleted and replaced with newer images.

**Note:** Underlined settings represent factory-preset settings.

## 23.1. Priority recording setting

Priority recording is given higher priority over Auto-recording. Use this recording mode to check recording details when, for example, a suspicious person intrudes or when making recording outside the scheduled time period. (Refer to [p. 39](#); Priority recording.)

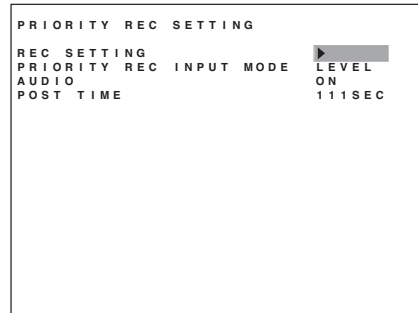

Item	Selection	Description
REC SETTING	—	Refer to <a href="#">p. 78</a> ; Recording Setting for setting selections.
PRIORITY REC INPUT MODE	LEVEL / <u>EDGE</u>	Set either "Level" or "Edge" depending on the type of signal input to the Priority Recording Input Terminal. For information on recording operation when the Level or Edge mode is selected, see "Recording Operation When Edge/Level Settings Are Performed" on <a href="#">page 43</a> .
AUDIO	ON / <u>OFF</u>	ON: Audio is also simultaneously recorded for the duration of Priority Recording. OFF: No audio is recorded.
POST TIME	0 - ( <u>60</u> ) - 999 SEC / NO LIMIT	Set the length of time after which Priority Recording will finish. 0-999 SEC : Records for a set period of post-alarm time. This must be 1 second or more if the Priority Recording mode is set to "Edge," but can be set to 0 or more if this mode is set to "Level." NO LIMIT : Priority recording continues until stopped manually.

**Note:** Underlined settings represent factory-preset settings.

\*1 If the Priority Recording mode is set to "Level," recording initiated by the Digital Video Recorder or remote controller Priority Rec key will continue until stopped manually.

### 23.1.1. Recording Setting

In the Priority Recording settings, the following settings can be made for individual cameras: recording ON/OFF, recording rate, and picture quality.

The total recording rate and the estimated recording time available are displayed near the bottom of the screen.

REC SETTING	REC	REC RATE	QUALITY
CAM1	<u>ON</u>	8 IPS	4
CAM2	ON	2 IPS	3 (MID)
CAM3	ON	15 IPS	2
CAM4	ON	15 IPS	1 (HIGH)
CAM5	OFF	1 / 60 IPS	2
CAM6	OFF	-	-
CAM7	OFF	-	-
CAM8	OFF	-	-
CAM9	OFF	-	-
CAM10	OFF	-	-
CAM11	OFF	-	-
CAM12	OFF	-	-
CAM13	OFF	-	-
CAM14	OFF	-	-
CAM15	OFF	-	-
CAM16	OFF	-	-
TOTAL REC RATE			39.3750 IPS
ESTIMATED REC TIME			12D13H

#### Total Recording Rate:

Displays the total recording rate set for all cameras.

#### Estimated Recording Time:

Displays the time available for recording the output of all cameras to a hard disk drive.

#### Note

If the disk mode is set to "Normal," then set Total Recording Rate to 120 IPS or less. If the disk mode is set to "Mirror," then set Total Recording Rate to 60 IPS or less. Settings above these are not possible.

Item	Selection	Description
REC	<u>ON</u> / OFF	ON: Recording is performed during Priority recording. *1 OFF: Recording is not performed during Priority recording. *1
REC RATE	<u>60</u> IPS / 30 IPS / 15 IPS / <u>8</u> IPS / 4 IPS / 2 IPS / 1 IPS / 1/2 IPS / 1/3 IPS / 1/5 IPS / 1/10 IPS / 1/20 IPS / 1/30 IPS / 1/60 IPS	Sets the recording rate during recording. *1, *2
QUALITY	<u>1</u> (HIGH) 2 3 (MID) 4 5 (LOW)	Sets the picture quality level for the recording. *1 1: 64 KB (High picture quality) 2: 40 KB 3: 32 KB 4: 24 KB 5: 16 KB (Low picture quality)

**Note:** Underlined settings represent factory-preset settings.

\*1 Can be set for each camera.

\*2 For recording rate, refer to p. 44; Recording Rate and p. 116; Recording timetable.

## 23.2. Auto-Recording Setting

Auto-Recording performs recording according to preset schedules. Be sure to perform schedule or group settings when making auto recording. (Refer to p. 40; Auto recording.)

AUTO REC SETTING	
SCHEDULE	▶
GROUP-A SETTING	▶
GROUP-B SETTING	▶
GROUP-C SETTING	▶
GROUP-D SETTING	▶
GROUP-E SETTING	▶
GROUP-F SETTING	▶
SPECIAL DAY SETTING	▶
MOTION SETTING	▶
AUDIO	ON

Item	Selection	Description
SCHEDULE	—	For setting, refer to p. 79; Schedule.
GROUP A – F SETTING	—	For setting, refer to p. 80; Setting of groups A – F .
SPECIAL DAY SETTING	—	For setting, refer to p. 83; Special day setting.
MOTION SETTING	—	For setting, refer to p. 84; Motion detection settings.
AUDIO	ON / <u>OFF</u>	ON: Audio is recorded simultaneously during auto recording. OFF: No audio is recorded simultaneously during auto recording.

**Note:** Underlined settings represent factory-preset settings.

### 23.2.1. Schedule

To program schedules, set the day of the week, start and end times, and service individually for each program. Up to 12 programs can be scheduled. Each schedule service is operated according to group settings.

#### Notes

- When the same time is duplicated in the schedule settings, the program setting of the largest number takes precedence.
- The auto recording function cannot be used if schedules are not programmed.
- Setting the end time earlier than the start time will allow recording to continue until the following day.

SCHEDULE				
	DAY	START	END	OPERATION
1	<u>EVERY</u>	08:00	- 19:00	GROUP-A
2	EVERY	19:00	- 08:00	GROUP-B
3	SAT	08:00	- 13:00	GROUP-C
4	SAT	13:00	- 23:59	GROUP-C
5	SUN	13:00	- 08:00	GROUP-D
6	SPECIAL	08:00	- 13:00	GROUP-F
7	SPECIAL	13:00	- 08:00	GROUP-A
8	-	-:-:-	-:-:-	-:-:-
9	-	-:-:-	-:-:-	-:-:-
10	-	-:-:-	-:-:-	-:-:-
11	-	-:-:-	-:-:-	-:-:-
12	-	-:-:-	-:-:-	-:-:-

Item	Selection	Description
DAY	<u>EVERY</u> / SUN / MON / TUE / WED / THU / FRI / SAT/ SPECIAL	Set the day of the week and special days for auto recording. EVERY : Regularly performs recordings every day. SUN – SAT : Performs recordings on the designated day of the week. SPECIAL : Performs recordings on specified days.
START	<u>00:00</u> – 23:59	Set the start time.
END	<u>00:00</u> – 23:59	Set the end time.
OPERATION	<u>GROUP A</u> – GROUP F	Select groups. Groups can be set in the auto recording settings. (Next page: setting of groups A - F)

**Note:** Underlined settings represent factory-preset settings.

### 23.2.2. Settings of Groups A - F

Service operation methods of Groups A–F are set for each schedule. Set the camera alarm input and motion-detected modes and post time set in the Alarm Event Recording settings.

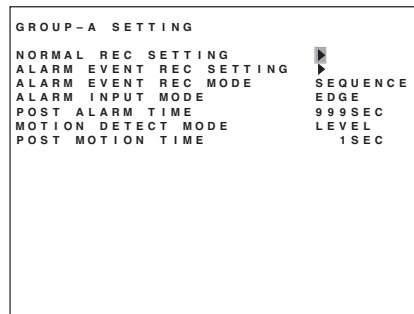

Item	Selection	Description
NOMAL REC SETTING	—	For setting, refer to p. 81; Normal recording setting.
ALARM EVENT REC SETTING	—	For setting, refer to p. 82; Alarm event recording setting.
ALARM EVENT REC MODE	<u>SEQUENCE</u> / LAST	Sets the operation of alarm event recording when multiple alarm events have occurred. SEQUENCE: Records all cameras set for alarm event. It is possible to set multiple alarm events for each camera, including up to four alarm inputs and four motion detection settings. *1 *2 LAST: Records only the camera that triggers alarm last. It is possible to set one alarm input and one motion detection setting for each camera. *1
ALARM INPUT MODE	LEVEL / <u>EDGE</u>	Select either "Level" or "Edge" depending on the type of signal input to the Priority Recording Terminal. For information on recording operation when the Level or Edge mode is selected, see "Recording Operation When Edge/Level Settings Are Performed" on page 43.
POST ALARM TIME	0 - <u>60</u> - 999 SEC / NO LIMIT	Set the length of time an Alarm Event recording is to continue after being triggered by an alarm input. 0 - 999 SEC: Recordings are performed during the set post alarm time. If the alarm input mode is set to "Edge," the post alarm time can be set to 1 second or more. If it is set to "Level," it can be set to 0 second or more. *4 NO LIMIT: Recordings continue alarm recording completion until manually stopped.
MOTION DETECT MODE	<u>LEVEL</u> / EDGE	Set the Motion Detection mode to either "Level" or "Edge." For information on recording operation when the Level or Edge mode is selected, see "Recording Operation When Edge/Level Settings Are Performed" on page 43.
POST MOTION TIME	1 - <u>60</u> - 999 SEC / NO LIMIT	Set the length of time an Alarm Event recording is to continue after being triggered by motion detection. 1 - 999 SEC: Recordings are performed during the set post motion time. *4 NO LIMIT: Recordings continue motion-detected recording completion until manually stopped.

#### Notes

- Underlined settings represent factory-preset settings.
- Default settings for Groups A - F are all identical.

\*1 Even with the Sequence setting, if alarms are input in order, the last input screen is displayed.

\*2 If multiple events are set, the camera with the lowest number is displayed on the full screen on the monitor.

\*3 When multiple alarm-activated cameras are displayed on the full screen, the camera that triggered alarm last takes precedence.

\*4 If post time is less than the recording rate, the image may not be played back correctly.



## [ Normal Recording Setting ]

This function automatically records camera images set by schedule. In each program, recording ON/OFF, recording rate and picture quality can be individually set for each camera. The total recording rate and the estimated recording time available are displayed near the bottom of the screen.

### Total Recording Rate:

Displays the total recording rate set for all cameras.

### Estimated Recording Time:

Displays the time available for recording the output of all cameras to a hard disk drive.

NORMAL	REC	SETTING A	REC RATE	QUALITY
CAM1	ON		8 IPS	4
CAM2	<u>ON</u>		2 IPS	3 (MID)
CAM3	ON		15 IPS	2
CAM4	ON		15 IPS	1 (HIGH)
CAM5	OFF		1 / 60 IPS	2
CAM6	OFF		-	-
CAM7	OFF		-	-
CAM8	OFF		-	-
CAM9	OFF		-	-
CAM10	OFF		-	-
CAM11	OFF		-	-
CAM12	OFF		-	-
CAM13	OFF		-	-
CAM14	OFF		-	-
CAM15	OFF		-	-
CAM16	OFF		-	-
TOTAL REC RATE			39.3750 IPS	
ESTIMATED REC TIME				12D13H

### Note

If the disk mode is set to "Normal," then set Total Recording Rate to 120 IPS or less. If the disk mode is set to "Mirror," then set Total Recording Rate to 60 IPS or less. Settings above these are not possible.

Item	Selection	Description
REC	<u>ON</u> / OFF	ON: Recording is performed during Normal recording *1 OFF: Recording is not performed during Normal recording *1
REC RATE	60 IPS / 30 IPS / 15 IPS / 8 IPS / <u>4</u> IPS / 2 IPS / 1 IPS / 1/2 IPS / 1/3 IPS / 1/5 IPS / 1/10 IPS / 1/20 IPS / 1/30 IPS / 1/60 IPS	Sets the recording rate during recording. *1 *2
QUALITY	1 HIGH 2 <u>3</u> MID 4 5 LOW	Sets the picture quality level for the recording *1 1: 64 KB (High picture quality) 2: 40 KB 3: 32 KB 4: 24 KB 5: 16 KB (Low picture quality)

**Note:** Underlined settings represent factory-preset settings.

\*1 Can be set for each camera.

\*2 For recording rate, refer to p. 44; Recording Rate and p. 116; Recording timetable.

## [ Alarm Event Recording Setting ]

Preset camera images are automatically recorded when an alarm event occurs. Recording "Enable" (ON) or "Disable" (OFF), recording rate, picture quality and event settings can be performed for each camera. The recording rate for cameras other than alarm event-activated cameras and the total recording rate are both displayed near the bottom of the screen.

ALARM	EVENT	REC	REC RATE	SETTING	A	QUALITY	EVENT
CAM1	ON	ON	8 IPS	4			▶
CAM2	ON	ON	2 IPS	3 (MID)			▶
CAM3	ON	ON	15 IPS	2			▶
CAM4	ON	ON	15 IPS	1 (HIGH)			▶
CAM5	OFF	OFF	1 / 60 IPS	2			▶
CAM6	OFF	OFF	-	-			▶
CAM7	OFF	OFF	-	-			▶
CAM8	OFF	OFF	-	-			▶
CAM9	OFF	OFF	-	-			▶
CAM10	OFF	OFF	-	-			▶
CAM11	OFF	OFF	-	-			▶
CAM12	OFF	OFF	-	-			▶
CAM13	OFF	OFF	-	-			▶
CAM14	OFF	OFF	-	-			▶
CAM15	OFF	OFF	-	-			▶
CAM16	OFF	OFF	-	-			▶
REC RATE EXCEPT EVENT CAM							4 IPS
TOTAL REC RATE							39.3750 IPS

### Total rec rate:

When Alarm Event Recording mode is set to "Sequence" :

The total recording rate for each of the cameras is displayed. If the recording rate for one camera is a smaller value than "Recording Rate Other Than Event Cameras," then its recording rate is regarded as the "Recording Rate Other Than Event Cameras" when calculating.

When Alarm Event Recording mode is set to "Last" :

Displays the total of the largest recording rate of one camera out of those to be recorded and the sum of "Recording Rate Other Than Event Cameras" of other cameras (other cameras' recording rate is all regarded as the "Recording Rate Other Than Event Cameras" even if each of their rates is smaller than that).

### Note

If the disk mode is set to "Normal," then set Total Recording Rate to 120 IPS or less. If the disk mode is set to "Mirror," then set Total Recording Rate to 60 IPS or less. Settings above these are not possible.

Item	Selection	Description
REC	<u>ON</u> / OFF	ON: Recording is performed during Alarm event recording *1 OFF: Recording is not performed during Alarm event recording *1
REC RATE	60 IPS / 30 IPS / 15 IPS / 8 IPS / <u>4 IPS</u> / 2 IPS / 1 IPS / 1/2 IPS / 1/3 IPS / 1/5 IPS / 1/10 IPS / 1/20 IPS / 1/30 IPS / 1/60 IPS	Sets the recording rate during recording. *1 *2
QUALITY	<u>1</u> HIGH 2 3 MID 4 5 LOW	Sets the picture quality level for the recording *1 1: 64 KB (High picture quality) 2: 40 KB 3: 32 KB 4: 24 KB 5: 16 KB (Low picture quality)
EVENT	—	For setting, refer to p. 83; Event setting.
REC RATE EXCEPT EVENT CAM	4 IPS / 2 IPS / <u>1 IPS</u> / 1/2 IPS / 1/3 IPS / 1/5 IPS / 1/10 IPS / 1/20 IPS / 1/30 IPS / 1/60 IPS / INVALID	Set the recording rate for recording "Disable" cameras during alarm event recording.

**Note:** Underlined settings represent factory-preset settings.

\*1 Can be set for each camera.

\*2 For recording rate, refer to p. 44; Recording Rate and p. 116; Recording timetable.

**[ Event Setting ]**

Alarm Event Recording begins with the events set in the Alarm Input and Motion Detection Camera settings for each camera.

**Note**

If the Alarm Event Recording mode is set to "Last," then the alarm input and motion detection camera can be set under the selected camera number.

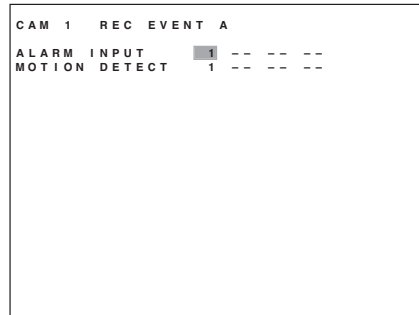

Item	Description
ALARM INPUT	Select the alarm input terminal number from 1 to 16 (or 1 to 9 for 9-channel units). Alarm Event Recording can be initiated by up to four different alarm events.
MOTION DETECT	Select the motion detection camera number from 1 to 16 (or 1 to 9 for 9-channel units). Up to four different motion detection cameras can be set, and Alarm Event Recording is initiated whenever motion is detected by any of these.

Factory preset: The same number as the selected camera number is indicated.

**23.2.3. Special Day Setting**

Special schedules can be programmed for commemorative days or holidays. Up to 60 special days can be set. Setting the Day of the Week in the Schedule settings to "Special day" causes a special schedule to be implemented for specifically registered days only.

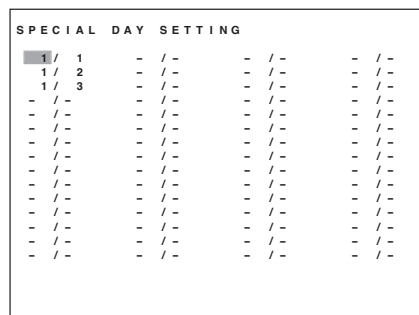

Item	Selection	Description
SPECIAL DAY	1 / 1 - 12 / 31	Set the date of special days. (Maximum 60 days)

Factory preset: The date is not set.

### 23.2.4. Motion Detection Settings

Motion detection settings can be individually performed for each camera. By setting the area range to be detected, movement within the camera image can be automatically detected. Alarm Event Recordings begin whenever image movement is detected. (Refer to p. 83; Event setting)

#### Notes

- Motion is detected by sensing changes in brightness and contour movement. For dark images, since the brightness change is minute, set an appropriate sensitivity relative to camera's brightness level. Also, motion is hard to detect for out-of-focus images. Be sure to adjust the focus so that the image does not blur even when the ambient light level becomes low.
- In some cases, motion cannot be detected or false motion is detected depending on the motion sensitivity or brightness level of the images.  
This function is not a dedicated device for prevention of burglar, fire and etc. TOA takes no responsibility for any incidental loss or accidents.

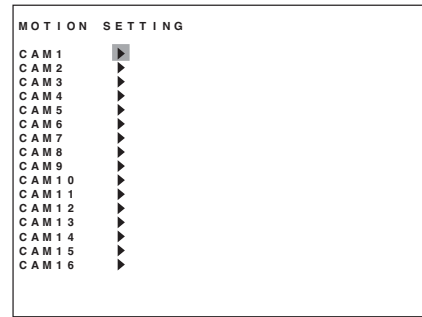

Item	Selection		Description
MOTION SETTING	16-channel	9-channel	Set the motion detection for each camera.
	Camera 1 - 16	Camera 1 - 9	

1. Move the cursor to the position to set motion detection with the [▲], [▼], [◀], and [▶] keys and press the Menu key. (Motion detection ON: Green, Motion detection OFF: No indication)  
The area indicator alternates between ON and OFF with each depression of the Menu key. When movement is detected in the set area, the color of the block turns red.  
To set a wider motion detection area, move the cursor diagonally from the position set in Step 1, then press the Search key. Similarly, the wider area setting can be reset.
2. Press the (+) key.  
Sensitivity settings change each time the key is pressed.
3. Press the (-) key.  
The motion settings change each time the key is pressed.
4. Hold down the Menu key for 2 seconds or more.  
The "Save Settings" dialog is displayed and the display returns to the previous screen.

#### [ Example ] Camera1

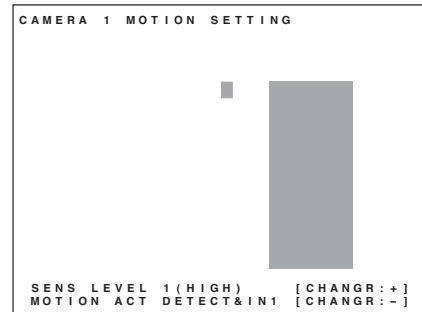

Live images are displayed in the background.

Item	Selection		Description
SENS LEVEL	1 (HIGH) - <u>3</u> - 5 (LOW)		Set the motion detection sensitivity for the entire area. The sensitivity can be set in 5 steps, 1 indicating the highest sensitivity.
MOTION ACT	16-channel	9-channel	Set the method to activate the motion detection function. Detection: Alarm Event Recording begins when the motion is detected. Detection & Inputs 1-16 (1-9): Alarm Event Recording begins by detecting the motion only when Alarm inputs terminals receive a signal.
	<u>DETECT</u> / DETECT & IN 1-16	<u>DETECT</u> / DETECT & IN 1-9	

**Note:** Underlined settings represent factory-preset settings.

### 23.3. Pre-Recording settings

This function records images immediately before Priority recording or Alarm Event recording is initiated. Retroactive recordings covering intervals up to 5 minutes can be made. (Refer to p. 41; Pre-Recording.)

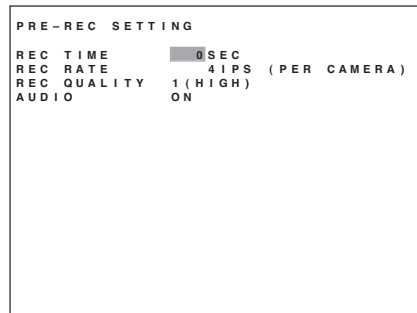

#### Notes

- Pre-Recording does not function if the recording interval has been set to 0 second.
- Activated only when recording is stopped. If recording is in a stopped state, pre-recording is conducted even if it falls within the time allotted to an Auto-Recording schedule.

Item	Selection	Description
REC TIME	<u>0</u> - 300 seconds	Set the duration of time during which recording is made prior to the start of alarm recording.
REC RATE	<u>4</u> IPS / 2 IPS / 1 IPS / 1/2 IPS / 1/3 IPS / 1/5 IPS / 1/10 IPS / 1/20 IPS / 1/30 IPS / 1/60 IPS	Sets the recording rate during recording. *1
REC QUALITY	<u>1</u> HIGH 2 3 MID 4 5 LOW	Sets the picture quality level for the recording. 1: 64 KB (High picture quality) 2: 40 KB 3: 32 KB 4: 24 KB 5: 16 KB (Low picture quality)
AUDIO	ON / <u>OFF</u>	ON: Audio is recorded simultaneously during pre-recording. OFF: Audio is not recorded simultaneously during pre-recording.

**Note:** Underlined settings represent factory-preset settings.

\*1 For recording rate, refer to p. 44; Recording Rate and p. 116; Recording timetable.

## 24. SCREEN DISPLAY SETTING

It is possible to set specific screens to display or switch among specific live or recorded images or playback. It is also possible to set camera or DVR names and to set the display mode when monitor output is activated.

SCREEN DISPLAY SETTING	
CHARACTER DISPLAY SETTING	▶
MONITOR OUTPUT SETTING	▶
SEQUENCE SETTING	▶
CAMERA NAME SETTING	▶
DVR NAME SETTING	▶
MONITOR1 SCREEN	▶ DVR 1 2 3 9 SEG
MONITOR2 SCREEN	▶ 4 SEG - A
ALARM DISPLAY INTERVAL	▶ 3 SEC

Item	Selection		Description
CHARACTER DISPLAY SETTING	_____		For setting, refer to p. 87; Character display setting.
MONITOR OUTPUT SETTING	_____		For setting, refer to p. 88; Monitor output setting.
SEQUENCE SETTING	_____		For setting, refer to p. 88; Sequence setting.
CAMERA NAME SETTING	_____		For setting, refer to p. 89; Camera name setting.
DVR NAME SETTING	_____		For setting, refer to p. 89; DVR name setting.
MONITOR 1 SCREEN	16 CH	9 CH	Set the screen to be displayed when Monitor 1 is activated.
	CAM 1-16 / 4SEG-A - D / 9SEG-A and B / <u>16SEG</u> / SEQ	CAM 1-9 / 4SEG-A - C / <u>9SEG</u> / SEQ	
MONITOR 2 SCREEN	CAM 1-16 / <u>4 SEG-A</u> -D / SEQ	CAM 1-9 / <u>4SEG-A</u> -C / SEQ	Set the screen to be displayed when Monitor 2 is activated.
	ALARM DISPLAY INTERVAL		
	0 SEC - 120 SEC / <u>REC IN</u> / NO LIMIT		Set the full-screen display interval to be used by the corresponding camera whenever recording has been initiated by an alarm event. *1 *2 0 second: No full-screen display. 1-120 seconds: Full-screen display occurs for the preset period of time. Rec In: Full-screen display occurs for the duration of recording. No Limit: Full-screen display continues to occur until display is switched manually.

**Note:** Underlined settings represent factory-preset settings.

\*1 If multiple alarm events have been input simultaneously, the event that occurred last is given priority and displayed on the full screen.

\*2 If the Alarm Event Recording mode is set to Sequence and multiple events are set, the camera with the lowest number is displayed on the full screen on the monitor.

## 24.1. Character Display Settings

Set names and numbers to “Display” or “Hide.” For display positions, refer to the sections “Display During Recording” and “Display During Playback.”

(Refer to p. 32; Display when in live mode.) (Refer to p. 33; Display during playback.)

CHARACTER DISPLAY SETTING		
REC AUDIO		<u>DISP</u>
OVERWRITE		DISP
REC		DISP
PLAY		DISP
REMAINING		DISP
DISK MODE		HIDE
DISK STATUS		HIDE
DATE		HIDE
TIME		HIDE
DATE / TIME		UPPER LEFT
MONITOR1 CAM NAME		CAMERA No.
MONITOR2 CAM NAME		HIDE
DVR NAME		HIDE

Item	Selection	Description
REC AUDIO	<u>DISP</u> / HIDE	Display: Displays the recording status for the duration of recording. Hide: No recording status indication for the duration of recording.
OVERWRITE	<u>DISP</u> / HIDE	Display: Displays the overwrite setting (write protect, overwrite). Hide: No overwrite setting (write protect, overwrite) indication.
REC	<u>DISP</u> / HIDE	Display: Displays the recording status. Hide: No recording status indication.
PLAY	<u>DISP</u> / HIDE	Display: Displays the playback status indication for the duration of playback. Hide: No playback status indication.
REMAINING	<u>DISP</u> / HIDE	Display: Displays the hard disk remaining time. Hide: No hard disk remaining time indication.
DISK MODE	<u>DISP</u> / HIDE	Display: Displays the disk mode. Hide: No disk mode indication.
DISK STATUS	<u>DISP</u> / HIDE	Display: Displays the hard disk during recording or play back. Hide: No hard disk during recording or play back indication.
DATE	<u>DISP</u> / HIDE	Display: Displays the current date while live images are displayed, and the recorded date while recorded images are played back. Hide: No date is displayed when in live or playback modes.
TIME	<u>DISP</u> / HIDE	Display: Displays the current time while live images are displayed, and the recorded time while recorded images are played back. Hide: No time is displayed when in live or playback modes.
DATE / TIME	UPPER LEFT / UPPER CENTER / <u>UPPER RIGHT</u> / LOWER LEFT / LOWER CENTER / LOWER RIGHT	Set the Date/ time indication position.
MONITOR 1 CAM NAME	CAMERA NAME / <u>CAMERA No.</u> / HIDE	Camera name: Indicates the camera name through monitor 1 output. Camera number: Indicates the camera number through Monitor output 1. Hide: No indication through Monitor output 1.
MONITOR 2 CAM NAME	CAMERA NAME / <u>CAMERA No.</u> / HIDE	Camera name: Indicates the camera name through Monitor output 2 Camera number: Indicates the camera number through Monitor output 2. Hide: No indication through Monitor output 2.
DVR NAME	DISP / <u>HIDE</u>	Display: Indicates the DVR name. Hide: No DVR name is displayed.

**Note:** Underlined settings represent factory-preset settings.

## 24.2. Monitor Output Setting

Set Monitor outputs 1 and 2 to “Display” or “Hide” for each camera.

### Note

Set Display/Hide for the Live mode. Images are displayed in Playback and Triplex modes even if "Hide" is selected.

MONITOR OUTPUT SETTING		
	MONITOR 1	MONITOR 2
CAM 1	<u>DISP</u>	HIDE
CAM 2	DISP	HIDE
CAM 3	DISP	HIDE
CAM 4	DISP	HIDE
CAM 5	DISP	HIDE
CAM 6	DISP	HIDE
CAM 7	DISP	HIDE
CAM 8	DISP	HIDE
CAM 9	DISP	HIDE
CAM 10	DISP	HIDE
CAM 11	DISP	HIDE
CAM 12	DISP	HIDE
CAM 13	DISP	HIDE
CAM 14	DISP	HIDE
CAM 15	DISP	HIDE
CAM 16	DISP	HIDE

Item	Selection	Description
MONITOR 1	<u>DISP</u> / HIDE	Display: Displays live images through Monitor output 1. Hide: No live image display through Monitor output 1.
MONITOR 2	<u>DISP</u> / HIDE	Display: Displays live images through Monitor output 2. Hide: No live image display through Monitor output 2.

**Note:** Underlined settings represent factory-preset settings.

## 24.3. Sequence Setting

Screens are sequentially switched at display intervals set for each step. Set the screen to be sequenced to the monitor and the switching interval. (Refer to p. 35; Sequence Display.)

### Note

The display interval of Step 1 cannot be set to 0 second.

SEQUENCE SETTING			
	MONITOR 1		MONITOR 2
STEP 1	<u>4SEG-A</u>	1 SEC	CAM 1 3 SEC
STEP 2	CAM 6	3 SEC	CAM 2 3 SEC
STEP 3	CAM 7	10 SEC	CAM 3 3 SEC
STEP 4	9 SEG	0 SEC	4SEG-A 0 SEC
STEP 5	CAM 1	0 SEC	CAM 1 0 SEC
STEP 6	CAM 1	0 SEC	CAM 1 0 SEC
STEP 7	CAM 1	0 SEC	CAM 1 0 SEC
STEP 8	CAM 1	0 SEC	CAM 1 0 SEC
STEP 9	CAM 1	0 SEC	CAM 1 0 SEC
STEP 10	CAM 1	0 SEC	CAM 1 0 SEC
STEP 11	CAM 1	0 SEC	CAM 1 0 SEC
STEP 12	CAM 1	0 SEC	CAM 1 0 SEC
STEP 13	CAM 1	0 SEC	CAM 1 0 SEC
STEP 14	CAM 1	0 SEC	CAM 1 0 SEC
STEP 15	CAM 1	0 SEC	CAM 1 0 SEC
STEP 16	CAM 1	0 SEC	CAM 1 0 SEC

Item	Selection		Description
MONITOR 1 (Display screen)	16-channel <u>CAM 1-16</u> / 4SEG-A -D / 9SEG-A and B / 16SEG	9-channel <u>CAM 1-9</u> / 4SEG-A -C / 9SEG	Set the display screen mode of each step.
MONITOR 1 (Sequence interval)	0 - <u>3</u> - 60 SEC		Set the display interval of each step.
MONITOR 2 (Display screen)	CAM 1-16 / <u>4SEG-A -D</u>	CAM 1-9 / <u>4SEG-A -C</u>	Set the display screen of each step.
MONITOR 2 (Sequence interval)	0 - <u>3</u> - 60 SEC		Set the display interval of each step.

**Note:** Underlined settings represent factory-preset settings.



## 24.4. Camera Name Setting

Camera names can be individually assigned to each camera. Up to 15 characters can be used for camera name. However the number of characters that can be displayed are limited in 9-segment and 16-segment split screen displays.

### 9-segment split display:

First 10 characters of the camera name are displayed.

### 16-segment split display:

First 7 characters of the camera name are displayed.

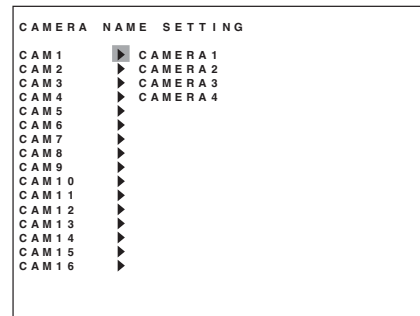

Item	Selection	Description
Camera name	15 alphanumeric characters	Set each camera name.

- Set the cursor at the ► mark of the desired camera number and press the Menu key.  
The character entry screen is displayed.
- Select characters and press the Menu key.  
To delete entered characters, select "Clear" and press the Menu key.
- Select "End" after character entry completion, then press the Menu key.  
Save setting confirmation message is displayed, and the display reverts to the previous screen.

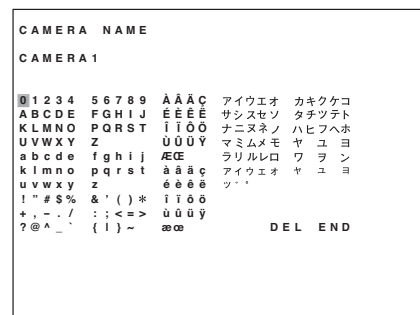

## 24.5. DVR Name Setting

Up to 15 characters can be used for DVR name. Follow the instructions in the Camera Name Settings to set DVR names.

## 25. NETWORK SETTING

The Digital Video Recorder permits remote monitoring, recorded image search, and playback settings via a network. Set the network address and password.

```

NETWORK SETTING
IP ADDRESS      192.168.0.1
SUBNET MASK     255.255.255.0
DEFAULT GATEWAY 192.168.0.2
WEB
SERVER PORT     DEFAULT
USER PASSWORD  > *****
ADMIN PASSWORD > *****
LIVE QUALITY   1(HIGH)
MAX BIT RATE   MAX
PRIMARY DNS     192.168.0.2
SECONDARY DNS  192.168.0.2
NTP SERVER     > ntp.ne.jp
TIME ZONE (GMT) +09:00
    
```

Item	Selection	Description
IP ADDRESS	( <u>192.168.0.100</u> ) 0-255	Set IP address.
SUBNET MASK	( <u>255.255.255.0</u> ) 0-255	Set Subnet mask.
DEFAULT GATEWAY	( <u>0. 0. 0. 0</u> ) 0-255	Set Default gateway.
WEB SERVER PORT	<u>Standard</u> / 1024 – 65535	Set the web server port number. Standard: No. 80
WEB USER PASSWORD *1	Up to 10 alphanumeric characters	Set the password to be used when logging in using a user account.
WEB ADMIN PASSWORD *1	Up to 10 alphanumeric characters	Set the password to be used when logging in using an administrator account.
WEB LIVE QUALITY	1 HIGH 2 <u>3</u> 4 5 LOW	Set the live distribution picture quality. 1: 32 KB (High picture quality) 2: 28 KB 3: 24 KB 4: 20 KB 5: 16 KB (Low picture quality)
WEB MAX BIT RATE	32 kbps / 64 kbps / 128 kbps / 256 kbps / 512 kbps / 1 Mbps / 2 Mbps / 4 Mbps / <u>MAX</u>	Set the maximum transfer speed.
PRIMARY DNS	( <u>0. 0. 0. 0</u> ) 0-255	Set the primary DNS server's IP address.
SECONDARY DNS	( <u>0. 0. 0. 0</u> ) 0-255	Set the secondary DNS server's IP address.
NTP SERVER	Up to 46 alphanumeric characters	Set the NTP server's domain.
TIME ZONE (GMT)	-12:00 – <u>+0:00</u> – +13:00	The time obtained using NTP is the UTC time (Universal Time Coordinated), which is the error time to be used to adjust to local time. It can be set in 15 minutes units. This correlates to NTP server's time synchronization, folder name and file names at the time of DVD archiving. Perform settings correctly.

**Note:** Underlined settings represent factory-preset settings.

\*1 Setting a password is recommended. If no password is set, then settings can be changed simply by accessing using a web browser.

Follow the procedures in the Camera Name Settings to set web user password, web admin password, and NTP servers. (Refer to p. 89; Camera name setting)

```

WEB SERVER USER PASSWORD
password
1 2 3 4 5 6 7 8 9
A B C D E F G H I J
K L M N O P Q R S T
U V W X Y Z
a b c d e f g h i j
k l m n o p q r s t
u v w x y z
! " # $ % & ' ( ) *
+ , - . / : ; < = >
? @ ^ _ ` { | } ~ DEL END
    
```

## 26. MAIL SETTING

Emails can be transmitted to receiving address when an alarm event or failure occurs. Up to 4 receiving addresses can be set.

### Note

It is not possible to attach screen shots to sent mail.

```
MAIL SETTING
SENDER ADDRESS      test
SEND-TO ADDRESS1   test1
SEND-TO ADDRESS2   test2
SEND-TO ADDRESS3   test3
SEND-TO ADDRESS4   test4
SMTP SERVER        smtp.ne.jp
POP3 AUTHENTICATION ON
ENCRYPTION         OFF
ACCOUNT NAME       user555
PASSWORD           pass555
POP3 SERVER        pop3.ne.jp
TRANSMISSION SETTING
TEST TRANSMISSION EXECUTE
```

Item	Selection	Description
SENDER ADDRESS	Up to 46 alphanumeric characters	Set the Digital Video Recorder's email address.
SEND-TO ADDRESS 1 - 4	Up to 46 alphanumeric characters	Set destination Email address.
SMTP SERVER	Up to 46 alphanumeric characters	Set the SMTP server's IP address
POP3 AUTHENTICATION	ON / <u>OFF</u>	ON: Authentication by POP3 when transmitting emails. OFF: No POP3 authentication when transmitting emails.
ENCRYPTION	ON / <u>OFF</u>	ON: Encrypts user names and passwords during POP3 authentication. OFF: User names and passwords not encrypted during POP3 authentication.
ACCOUNT NAME	Up to 23 alphanumeric characters	Set account names for POP3 authentication.
PASSWORD	Up to 23 alphanumeric characters	Set password for POP3 authentication.
POP3 SERVER	Up to 46 alphanumeric characters	Set POP 3 server's IP address.
TRANSMISSION SETTING	—	For setting, refer to <a href="#">p. 92</a> ; Transmission condition setting.
TEST TRANSMISSION	<u>EXECUTE</u>	Performs test transmission using the current settings.

**Note:** Underlined settings represent factory-preset settings.

Follow the procedures in the Camera Name Settings to set sender address, send-to address, SMTP server, account name, password and POP3 servers.

```
FROM ADDRESS
test

01234 56789
ABCDE FGHIJ
KLMNO PQRST
UVWXY Z
abcde fg hij
klmno pqrst
uvwxy z
!*#$% &'()*
+,-./ :;<=>
?@^_` { }~ DEL END
```

## 26.1. Transmission Condition Setting

Set conditions for transmitting emails when alarm is triggered, motion is detected, Priority Recording begins, equipment fails, or power is switched on.

TRANSMISSION SETTING			
CAM 1	<u>YES</u>	PRIORITY REC	NO
CAM 2	YES	FAILURE	NO
CAM 3	YES	SYSTEM OPERATE	YES
CAM 4	YES		
CAM 5	YES		
CAM 6	YES		
CAM 7	YES		
CAM 8	YES		
CAM 9	YES		
CAM 10	YES		
CAM 11	YES		
CAM 12	NO		
CAM 13	NO		
CAM 14	NO		
CAM 15	NO		
CAM 16	NO		

Item	Selection	Description
CAM 1 – 16 (1 – 9)	ON / <u>OFF</u>	ON: Transmits emails when the Alarm Event recording begins. OFF: Does not transmit emails even if the Alarm Event recording begins.
PRIORITY REC	ON / <u>OFF</u>	ON: Transmits emails when Priority recording begins. OFF: Does not transmit emails even if Priority recording begins.
FAILURE	ON / <u>OFF</u>	ON: Transmits emails when Failure log is added. OFF: Does not transmit emails even if Failure log is added.  When set to ON, following logs are transmitted. Video Lost occur, Video Lost reset (image return/ setting invalid/ release operation), Remaining Capacity Warning start, Remaining Capacity Warning reset, Hard Disk error, Hard Disk full, Hard Disk full reset, Fan failure
SYSTEM OPERATE	ON / <u>OFF</u>	ON: Transmits emails when System log is added. OFF: Does not transmit emails even if System log is added.  When set to ON, following logs are transmitted. Power ON, Hard disk initialization, Login (Operation Level 1, 2 and 3), and Logout

**Note:** Underlined settings represent factory-preset settings.

### [ Sent Mail Content ]

Subject: C-DR161 Callout Mail (For 16-channel units)  
C-DR091 Callout Mail (For 9-channel units)

Content: REPORT ALARM CAM ○ ○ (For an Alarm Event Recording; ○ ○ is the camera number)  
REPORT PRIORITY (For a Priority recording)  
REPORT FAILURE (For an Equipment Malfunction)  
REPORT SYSTEM OPERATION (For System Operation)

DVR ID ; ○ (DVR ID; ○ is the set DVR number)  
DVR NAME : ○ ○ ○ ○ (DVR name; ○ is the set DVR name)

### Notes

- It is not possible to attach screen shots to sent mail.
- If katakana is used for DVR name, ○ will be displayed for the DVR name to be transmitted.

## 27. SYSTEM SETTING

Settings can be performed for hard disks to be played back by the Digital Video Recorder, hard disk remaining time, and buzzer ON/OFF. It is also possible to set cameras, PCs (RS232C) and remote controller communications specifications, etc.

SYSTEM SETTING	
PLAY DISK	<u>ALL</u>
HD REMAINING TIME	0 0 H
BUZZER	ON
I/O TERMINAL MODE	▶
CTRL OUT TERMINAL	▶
SECURITY SETTING	▶
CAMERA PRESET SETTING	▶
CAMERA MODEL	TOA-A
CAMERA BIT RATE	38400bps
RS232C BIT RATE	38400bps
RS232C FLOW CTRL	OFF
RS232C RESPONSE	ON
CONTROLLER BIT RATE	38400bps
CONTROLLER RESPONSE	ON
DVR-ID	1
LANGUAGE SELECTION	ENGLISH

Item	Selection	Description
PLAY DISK	EXTENDED <u>ALL</u>	Plays back the images stored on the connected hard disks in order.
	MIRROR <u>HDD1 / HDD2</u>	Set hard disks to be played back. HDD1: Playback can be performed in order starting from HDD-A, -C, -E, and -A .... HDD2: Playback can be performed in order starting from HDD-B, -D, -F, and -B....
HD REMAINING TIME	0 - <u>1</u> - 999 hours	In "Overwrite Protection" mode, when the remaining recording time is shorter than the preset remaining time, the disk space indicator flashes.
BUZZER	<u>ON</u> / OFF	ON: Buzzer sounds when Priority or Alarm Event Recording begins, or when the failure is detected. OFF: Buzzer does not sound.
I/O TERMINAL MODE	——	For settings, refer to p. 94; I/O terminal mode setting.
CTRL OUT TERMINAL	——	For settings, refer to p. 95; Control output terminal setting.
SECURITY SETTING	——	For settings, refer to p. 96; Security setting.
CAMERA PRESET SETTING	——	For settings, refer to p. 97; Camera preset pattern setting.
CAMERA PROTOCOL	<u>TOA-A</u> / TOA-B / BOSCH / PELCO-D	Set the camera protocol to be controlled by the RS-485. TOA-A: Set to this position when connecting the cameras that operates using protocol type A. TOA-B: TOA-A: Set to this position when connecting the cameras that operates using protocol type B. BOSCH: TOA-A: Set to this position when connecting the cameras that operates using BOSCH TC8560/TC700 series protocol. PELCO-D: Set to this position when connecting the cameras that operates using Pelco protocol type D.
CAMERA BIT RATE	2400 bps / 4800 bps / 9600 bps / 19200 bps / <u>38400 bps</u>	Set the control camera's bit rate. *1 TOA-A: 9600bps / 19200 bps / 38400 bps TOA-B: 9600bps / 19200 bps / 38400 bps BOSCH: 2400 bps / 9600 bps PELCO-D: 2400 bps
RS232C BIT RATE	9600 bps / 19200 bps / <u>38400 bps</u>	Set the RS-232C's bit rate.
RS232C FLOW CTRL	ON / <u>OFF</u>	ON: Performs RS-232C flow control. OFF: RS-232C flow control not performed.
RS232C RESPONSE	<u>ON</u> / OFF	ON: Makes RS-232C communications responses. OFF: Does not make RS-232C communications responses.

Item	Selection	Description
CONTROLLER BIT RATE	9600 bps / 19200 bps / <u>38400 bps</u>	Set the Remote controller's bit rate.
CONTROLLER RESPONSE	<u>ON</u> / OFF	ON: Makes remote controller's communications responses. *2 OFF: Does not make remote controller's communications responses.
DVR-ID	<u>1</u> - 8	Set the Digital Recorder's ID. *3
LANGUAGE SELECTION	JAPANESE / <u>ENGLISH</u> / FRANCAIS	Select the display language.

**Note:** Underlined settings represent factory-preset settings.

\*1 Changing camera protocols causes the camera transmission speed to change as well. Be sure to match camera settings.

\*2 If the C-RM1000 remote controller is connected, be sure to set "Controller Response" to "ON." Leaving this set to "OFF" will prevent the remote controller from being used.

\*3 If a cascading connection is used, be sure that none of the ID numbers are duplicated. It is also possible to use the operation of the Digital Video Recorder to set the DVR-ID. (Refer to p. 27; Setting the DVR-ID)

## 27.1. I/O Terminal Mode Setting

Set the input and output terminals located on the rear panel.

I / O TERMINAL MODE SETTING			
INPUT	MODE	OUTPUT	MODE
ALARM1	<u>NC</u>	CTRL1	NO
ALARM2	NC	CTRL2	NO
ALARM3	NC	CTRL3	NO
ALARM4	NC	CTRL4	NO
ALARM5	NO		
ALARM6	NO		
ALARM7	NO		
ALARM8	NO		
ALARM9	NO		
ALARM10	NO		
ALARM11	NO		
ALARM12	NO		
ALARM13	NO		
ALARM14	NO		
ALARM15	NO		
ALARM16	NO		
PRIOR REC	NO		

Item	Selection	Description
ALARM 1 - 16 (1 - 9)	<u>NO</u> / NC	NO: Signals are input when the alarm terminal is shorted with the GND terminal. NC: Signals are input when the alarm terminal is released from the GND terminal.
PRIOR REC	<u>NO</u> / NC	NO: Signals are input when the alarm terminal is shorted with the GND terminal. NC: Signals are input when the alarm terminal is released from the GND terminal.
CTRL 1 - 4	<u>NO</u> / NC	NO: The control terminal is shorted with the GND terminal when unit is operated. NC: The control terminal is released from the GND terminal when unit is operated.

**Note:** Underlined settings represent factory-preset settings.

## 27.2. Control Output Terminal Setting

The Digital Video Recorder can output a control signal at the time of occurrence of Priority Recording, Alarm Event Recording or equipment failure. There are 4 control output terminals. Set the terminals that output the control signal.

CTRL OUTPUT SETTING		
	OUT	TIME
PRIORITY REC	<u>INVALID</u>	-
ALARM REC	CTRL1	REC IN
MOTION REC	CTRL3	REC IN
HD FULL	CTRL2	
HD ERROR	CTRL3	
VIDEO LOSS	CTRL4	
FAN FAILURE	CTRL4	

Item		Selection	Description
PRIORITY REC	OUT	<u>CTRL 1</u> / CTRL 2 / CTRL 3 / CTRL 4 / INVALID *1	Set the terminal that outputs a control signal when Priority Recording occurs.
	TIME	<u>REC IN</u> / 1 SEC	REC IN: Outputs a control signal for the duration of Priority Recording. 1 SEC: Outputs a control signal for 1 second when Priority Recording begins.
ALARM REC	OUT	CTRL 1 / <u>CTRL 2</u> / CTRL 3 / CTRL 4 / INVALID *1	Set the terminal that outputs a control signal when Alarm Recording occurs.
	TIME	<u>REC IN</u> / 1 SEC	REC IN: Outputs a control signal for the duration of Alarm Recording. 1 SEC: Outputs a control signal for 1 second when Alarm Recording begins.
MOTION REC	OUT	CTRL 1 / <u>CTRL 2</u> / CTRL 3 / CTRL 4 / INVALID *1	Set the terminal that outputs a control signal when Motion detection Recording occurs.
	TIME	<u>REC IN</u> / 1 SEC	REC IN: Outputs a control signal for the duration of Motion Detection Recording. 1 SEC: Outputs a control signal for 1 second when Motion Detection Recording begins.
HD FULL		CTRL 1 / CTRL 2 / <u>CTRL 3</u> / CTRL 4 / INVALID	Set the output terminal that outputs signals when the remaining hard disk capacity falls lower than the available recording time.
HD ERROR		CTRL 1 / CTRL 2 / CTRL 3 / <u>CTRL 4</u> / INVALID	Set the terminal that outputs a control signal when a hard error occurs.
VIDEO LOSS		CTRL 1 / CTRL 2 / CTRL 3 / <u>CTRL 4</u> / INVALID	Set the terminal that outputs a control signal when Video Loss occurs.
FAN FAILURE		CTRL 1 / CTRL 2 / CTRL 3 / <u>CTRL 4</u> / INVALID	Set the terminal that outputs a control signal when Fan failure occurs.

**Note:** Underlined settings represent factory-preset settings.

\*1 Time cannot be selected if the output terminal setting has been set to "Invalid."

## 27.3. Security Setting

Access to the Digital Video Recorder's operations and settings can be restricted using different security levels. It is also possible to control security level settings using the Remote Controller (RS-485 control) or a PC (RS-232C control). (Refer to [p. 60](#); About security setting.)

SECURITY SETTING		
OPERATION LEVEL1	PASSWORD VALID	USB KEY (VALID)
LEVEL2	***** INVALID	(INVALID)
LEVEL3	***** INVALID	(INVALID)
USB KEY LEVEL	LEVEL1	INVALID
PRIORITY REC	OPERATION LEVEL3	OFF
REMOTE ACCESS LIMIT	LOGOUT INTERVAL	10MINUTE

Item	Selection	Description
OPERATION LEVEL1-3	PASSWORD VALID (6-digit number) / <u>INVALID</u>	A password can be set to require login to each operation level. For an explanation of operating levels and their relationship to login and logout procedures, see <a href="#">page 60</a> , About Security Setting.
	USB KEY (VALID / INVALID)	Displays the content set for the USB key level.
USB KEY LEVEL	<u>LEVEL 1</u> / LEVEL 2 / LEVEL 3 / <u>INVALID</u>	Inserting a registered USB key in a key lock terminal allows settings to be changed. (Refer to <a href="#">p. 62</a> ; Security settings Using a USB Key.) LEVEL 1: Select in order to log in to operation level 1. LEVEL 2: Select in order to log in to operation levels 1 and 2. LEVEL 3: Select in order to log in to operation levels 1, 2, and 3. INVALID: USB key security not used.
PRIORITY REC OPERATION LEVEL 3	VALID / <u>INVALID</u>	VALID: Possible to operate the Priority Recording key at operation level 3.*1 INVALID: Not possible to operate the Priority Recording key at operation level 3. *1
REMOTE ACCESS LIMIT	ON / <u>OFF</u>	Restrict remote operation via remote controller or RS-232C. ON: Restricts access at the level set by the Digital Video Recorder. OFF: Allows access at operation level 1 (full access).
LOGOUT INTERVAL	<u>INVALID</u> / 1 MINUTE / 5 MINUTE / 10 MINUTE / 30 MINUTE / 60 MINUTE	Set the length of time after which automatic logout will occur after no operation has been conducted after a password login. INVALID: No automatic logout. 1-60 MINUTE: Logout will occur after the specified amount of time.

**Note:** Underlined settings represent factory-preset settings.

\*1 It is not possible to restrict recording started from a Priority recording terminal.



## 27.4. Camera Preset Pattern Setting

Up to 4 Cameras and 4 preset positions can be set for each alarm input.

### Note

Only the number of the camera connected to the combination camera is available for this function. Preset camera positions must have been set in advance.

CAMERA	PRESET	SETTING
ALARM	IN	CAMERA POSITION
	IN1	1
		-
		-
	IN2	2
		-
		-
	IN3	3
		-
		-
	IN4	16
		255
		-
		-
NEXT		▶

Item	Selection		Description
CAMERA	16-channel	9-channel	Up to 4 Cameras can be set per alarm.
	Camera 1-16	Camera 1-9	
POSITION	1-255		Up to 4 Preset positions can be set per alarm.

## 28. LOG DISPLAY

The content and times associated with recorded events can be reviewed and confirmed using activity logs. The following three activity logs are available:

- Recording Log: Refer to p. 98; Recording log
- Failure Log: Refer to p. 99; Failure log
- System Log: Refer to p. 99; System log

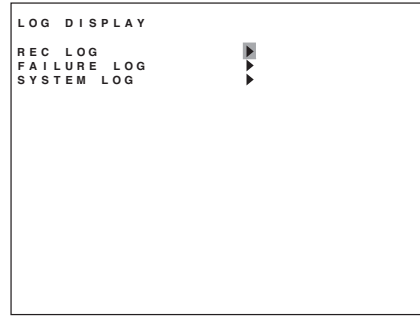

### 28.1. Recording Log

Records the start and end times of recordings that have been made, and displays these, starting from the most recent. The recording log stores up to 1,000 such records in chronological order and deletes the oldest records as needed to free up log storage space.

1. Using the [▲] and [▼] keys, select the log to be viewed. The log scrolls in page units (1 screen units).
2. Press the [◀] key. The screen reverts to the Log display screen.

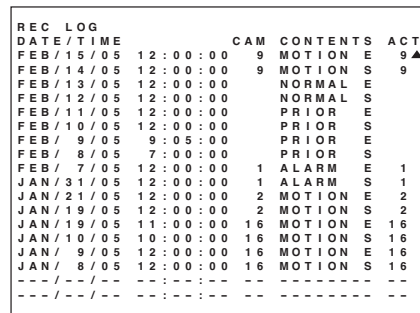

Item	Selection		Description
DATE / TIME	Month / Date / Year / Hour		Displays the date and time when the recording has started and ended.
CAM	16-channel	9-channel	Displays the Camera number for which recording has started and ended. Camera numbers are not displayed at Priority Recording start/end, and Normal Recording start/end.
	1-16	1-9	
CONTENTS	PRIOR S / PRIOR E / NORMAL S / NORMAL E / ALARM S / ALARM E / MOTION S / MOTION E		Displays the contents on which the recording has started and ended.
ACT	16-channel	9-channel	Displays the camera number for which Motion-detected Recording has been activated, or the alarm input terminal number that has activated Alarm Recording.
	1-16	1-9	

## 28.2. Failure Log

Records the time and content of any Digital Video Recorder failures that have occurred, and displays these, starting from the most recent. The Failure Log stores up to 100 such records chronologically, and deletes the oldest records as needed to free up log storage space.

The Failure Log is operated and used in the same manner as the "Recording Log," described in another section.

```

FAILURE LOG
DATE/TIME          CAM CONTENTS ▲
FEB/15/05 11:31:00 9 VL RECOVERY
FEB/14/05 5:43:00 9 VL DETECTED
FEB/13/05 12:00:00 5 VL INVALID
FEB/12/05 9:30:00 HD ERROR
FEB/11/05 12:00:00 5 VL DETECTED
FEB/10/05 7:02:00 1 VL RECOVERY
FEB/ 9/05 12:00:00 1 VL DETECTED
FEB/ 8/05 12:00:00 -- HD REM RST
FEB/ 8/05 11:00:00 -- HD REM ST
FEB/ 8/05 10:00:00 -- HD FULL RST
FEB/ 8/05 9:00:00 -- HD FULL
FEB/ 8/05 9:00:00 -- FAN FAILURE
-----
-----
-----
-----
-----
-----
-----
-----
-----
-----

```

Item	Selection	Description
DATE / TIME	Month / Date / Year / Hour	Displays the date and time when failure has occurred.
CAMERA	16-channel	Displays camera number on which failure has occurred. Camera number is not displayed except for video lost.
	9-channel	
	1-16	1-9
CONTENTS	VL DETECTED / VL RECOVERY / VL INVALID / HD ERROR / VL RESET / HD REM RST / HD REM ST / HD FULL RST / HD FULL / FAN FAILURE	Displays the content of failure that have occurred.

## 28.3. System Log

Records the starting times of equipment-related activities such as power-on, log-in, log-out, hard disk initialization, and others, and displays these, starting from the most recent. Up to 100 records are stored and these are deleted in chronological order.

The System Log is operated and used in the same manner as the "Recording Log," described in another section.

```

SYSTEM LOG
DATE/TIME          CONTENTS
FEB/15/05 12:00:00 MAIN POWER ON ▲
FEB/14/05 11:00:00 POWER KEY ON
FEB/13/05 12:00:00 HDD INITIALIZ
FEB/12/05 12:00:00 LOGOUT
FEB/11/05 12:00:00 LOGIN(OPELV1)
FEB/10/05 9:00:00 POWER KEY ON
FEB/ 9/05 12:00:00 MAIN POWER ON
-----
-----
-----
-----
-----
-----
-----
-----
-----
-----

```

Item	Selection	Description
DATE / TIME	Month / Date / Year / Hour	Displays the date and time when the system has been operated.
CONTENTS	MAIN POWER ON / POWER KEY ON / HDD INITIALIZ / LOGOUT / LOGIN (OPELV1 / OPELV2 / OPELV3)	Displays the contents of system operation that has been occurred.

## 29. DATE/TIME SETTING

This function allows current time settings, time synchronization, and daylight savings time settings.

### Note

When duplicate time data exists in the recording data if current time is changed, operation such as playback, date/time search, archiving or download may not be performed correctly in some cases.

```

DATE/TIME SETTING
DATE/TIME SETTING
  JAN / 1 / 05 00:00:00
DATE/TIME ADJUST OPERATE SLAVE
DATE/TIME ADJUST TIME 00:00
DATE/TIME ADJUST OUTPUT 1SEC
DAYLIGHT SETTING ON
START DATE/TIME
  APR 1ST WEEK SUN 02:00
END DATE/TIME
  OCT LAST WEEK SUN 22:00
    
```

Item	Selection	Description
DATE / TIME SETTING	JAN / 01 / 00 / 00:00:00 – DEC / 31 / 99 / 23:59:59	The Clock Setting function adjusts the Digital Video Recorder' s clock to the current time. It can also perform Time Synchronization and Daylight Saving Time adjustments.
DATE / TIME ADJUST OPERATE	MASTER / <u>SLAVE</u> / NTP	Master : When the synchronized time arrives, a time sync signal is output from the time sync output terminal. At the same time, the master performs time synchronization for Type B (TOA-B) protocol cameras.  Slave : The synchronized time arrives when a signal enters the time sync input terminal. Also, the slave performs time synchronization for Type B (TOA-B) protocol cameras one minute after a time sync signal has been input.  NTP: Makes a connection to the NTT server for time synchronization. *2
DATE / TIME ADJUST TIME	<u>00:00</u> – 23:00	Set time synchronization. *1
DATE / TIME ADJUST OUTPUT	<u>1 SEC</u> / 5 SEC	Set the time used for time synchronization. When using a one-channel Digital Video Recorder, set the time to 5 seconds.
DAYLIGHT SETTING	ON / <u>OFF</u>	ON: Activates the Daylight Saving Time adjustment function. OFF: Disables the Daylight Saving Time adjustment function.
START DATE / TIME	Month / Week / Day of the week / Hour ( <u>APRIL, 1ST WEEK, SUN 02:00</u> )	Set the Daylight Saving Time starting date and time. Month: Jan – Dec Week: the 1st week – 4th week, Last week Day of the week: Sun – Sat Hour: 00:00 – 23:00
END DATE / TIME	Month / Week / Day of the week / Hour ( <u>OCT, LAST WEEK, SUN 22:00</u> )	Set the Daylight Saving Time ending date and time. Month: Jan – Dec Week: the 1st week – 4th week, Last week Day of the week: Sun – Sat Hour: 00:00 – 23:00

**Note:** Underlined settings represent factory-preset settings.

\*1 Avoid time sync settings one hour before and after the start and end date/time for daylight savings time. Failure to do so could lead to incorrect time synchronization.

\*2 In some cases set time is not synchronized immediately after the setting has been saved when synchronized using the NTP server. In such case, synchronization can be complete by restarting the power or wait for a while.

Weeks for daylight savings time are as follows:

- First week : First to seventh
- Second week : Eighth to fourteenth
- Third week : Fifteenth to twenty-first
- Fourth week : Twenty-second to twenty-eighth
- Last week : Previous 7 calendar days including the last day

### 30. EQUIPMENT MAINTENANCE

Equipment maintenance includes: initialization of the Digital Video Recorder itself (including hard disk drives, settings, and log files); writing and reading settings data for external equipment; and USB key registration and data deletion. Equipment maintenance settings can be performed even while recording is in progress.

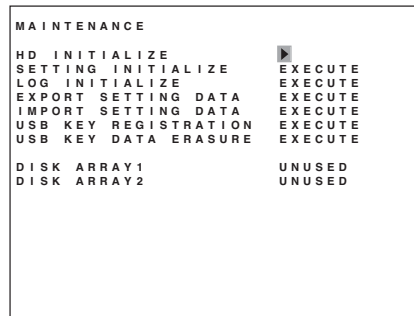

Item	Selection	Description
HD INITIALIZE	—	For setting, refer to p. 102; Hard disk drive initialization.
SETTING INITIALIZE	—	Initializes setting content. However, security settings, current time, log, disk mode and play disk settings do not change.
LOG INITIALIZE	—	Erases and initializes the log.
EXPORT SETTING DATA	—	Writes digital recorder settings data into the USB memory device connected to the archive terminal. However, security settings, current time, log, disk mode and play disk settings do not change.
IMPORT SETTING DATA	—	Reads Digital Video Recorder settings data from the USB memory device connected to the archive terminal. However, security settings, current time, log, disk mode and play disk settings do not change.
USB KEY REGISTRATION	—	Registers a USB memory devices connected to the key lock terminal as a USB key. For details on this setting, see page 62, Security settings Using a USB Key.
USB KEY DATA ERASURE	—	Erases the USB key data registered on the Digital Video Recorder.
DISK ARRAY 1	UNUSED / DA1 / DA2	UNUSED: When not connected to a hard disk drive expansion unit. DA1: When a C-DA1000-1 is connected. DA2: When a C-DA1000-2 is connected.
DISK ARRAY 2	UNUSED / DA1 / DA2	UNUSED: When not connected to a hard disk drive expansion unit. DA1: When a C-DA1000-1 is connected. DA2: When a C-DA1000-2 is connected.

**Note**

File names are as follows when writing settings data to the USB memory device.  
 16 channels: PARM16.DAT  
 9 channels: PARM09.DAT

### 30.1. Hard Disk Drive Initialization

When initializing hard disk drives, it is possible to select recording modes including "NORMAL" or "MIRROR." (Refer to p. 28, Hard disk Initialization.)

#### Notes

- Initializing a hard disk drive erases all images and other data recorded on it. Therefore, before initializing, be sure to first copy any needed data to a DVD-R/RW disc or USB memory device.
- The disk mode is initially set to "NORMAL." If operating the Digital Video Recorder in the normal mode, then there is no need to change the disk mode. However, recording will begin automatically when the Digital Video Recorder's power is turned on, so it is recommended to initialize the hard disk.

```

HD INITIALIZE
DISK MODE NORMAL
EXECUTE EXECUTE

HDD-A MASTER 160GB SLAVE ----
HDD-B MASTER 160GB SLAVE DVD
HDD-C MASTER0 320GB MASTER1 320GB
      MASTER2 ---- MASTER3 ----
HDD-D MASTER4 320GB MASTER5 320GB
      MASTER6 ---- MASTER7 ----
HDD-E MASTER0 320GB MASTER1 320GB
      MASTER2 320GB MASTER3 320GB
HDD-F MASTER4 320GB MASTER5 320GB
      MASTER6 320GB MASTER7 320GB
  
```

Item	Selection	Description
DISK MODE	<u>NORMAL</u> / MIRROR	Performs settings using the selected disk mode. NORMAL: When the first hard disk finishes recording, the second hard disk automatically begins to record. MIRROR: The same image is simultaneously recorded on both hard disks. Mirroring is performed by the built-in hard disk and the hard disk expansion unit.

**Note:** Underlined settings represent factory-preset settings.

## **31. WEB SERVER FUNCTIONS**

### **31.1. About the Functions**

The Digital Video Recorder is equipped with a variety of web-accessible functions. Connecting the Digital Video Recorder and PC with a LAN cable allows the Digital Video Recorder to remotely monitor camera outputs, or to search and/or play back recorded images using a web browser. The following specific functions can be accessed on a connected PC using the web server:

- Simultaneous operation of up to 3 client PCs
- Monitoring of live images
- Control of Combination Cameras
- Search and/or playback of recorded images
- Operation duplicating that of Digital Video Recorder's front-mounted keys
- Reference to and changing of menu settings
- Downloading of recorded images

### **31.2. System Requirements**

#### **PC**

OS: Windows 2000 Service Pack4, XP Service Pack1/2

CPU: Pentium4, 1 GHz or more

Memory: 256 MB or more

Available HDD space: 16 MB or more

#### **Browser**

Internet Explorer 5.5 or later

#### **Java**

Sun JRE 1.4 or later

#### **Notes**

- Depending on the operating environment and other conditions, there may be some delay in displaying the picture.
- When using Web server functions, be sure to first install browser (Internet Explorer) and Java (Sun JRE) on your PC.

### 31.3. How to Log In

There are two types of accounts: "Administrator" accounts and "User" accounts. Administrator account can access to all operations, while User account can access to the limited operations: live image monitoring; notification by LED indicator and camera control.

1. Open a web browser on a PC.

**Note**

Open a web browser using a single PC. It may not operate properly if multiple PCs have accessed.

2. Enter the Digital Video Recorder's network IP address into the web browser address. (Refer to p. 90; Network setting.) The authentication screen is displayed.

3. Enter an account name and a password.

Administrator account name: root

User account name: user

**Note**

It is recommended that WEB User password and WEB Administrator password be set. The PC user could change the settings if the password is not set. (Refer to p. 90; Network settings.)

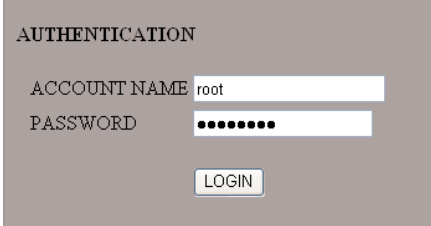

AUTHENTICATION

ACCOUNT NAME

PASSWORD

4. Click on "Login" to display the top page.

**Note**

If an incorrect account name or password has been entered, the display reverts to the authentication screen.

#### 31.3.1. Access inhibit

Up to 3 PCs are connectable. Up to 3 user accounts are accessible. Only one administrator account is accessible. If an administrator account is registered into 1 PC, then up to 2 more PCs can be connected with user accounts.

If the number of connected persons reaches the maximum limit, further operation is prohibited and the following screen is displayed. Also, if 1 PC is connected with the administrator account, then logging in to the second PC with the administrator account will cause the same screen to be displayed.

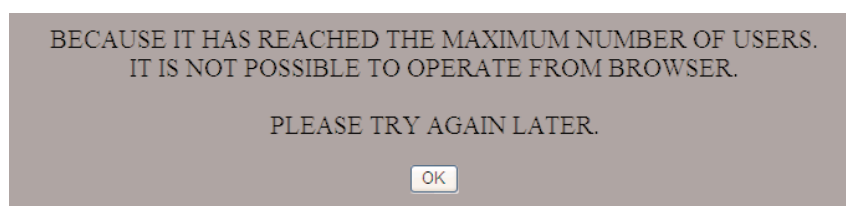

The maximum number of users are connected please try again later. Pressing the "OK" button returns the display to the authentication screen.



## 31.4. Top Page

If authentication is successful, the top page is displayed.

Clicking on the items shown on the top page switches the display to the relevant screen. Clicking "Logout" reverts the display to the authentication screen. Be sure to log out when you are finished with operation. An automatic logout function is also available. For a top page or menu screen, the server keeps a watch on access from the client, automatically logs out 10 minutes after last access if no other action has occurred.

When live screens, playback screens or remote control screens are being displayed, automatic logout does not function even if 10 minutes have elapsed.

### 31.4.1. For Administrator Account

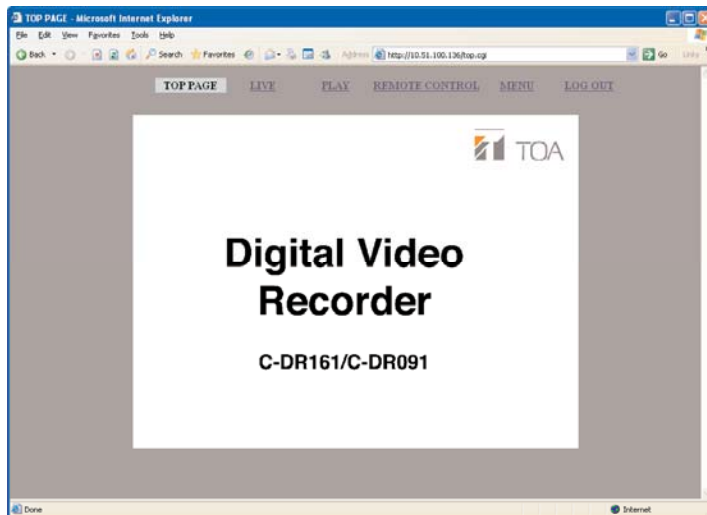

- Top page
- Live image transmission (p. 107)
- Playback transmission (p. 110)
- Remote control (p. 114)
- Menu screen (p. 106)
- Logout

### 31.4.2. For User Accounts

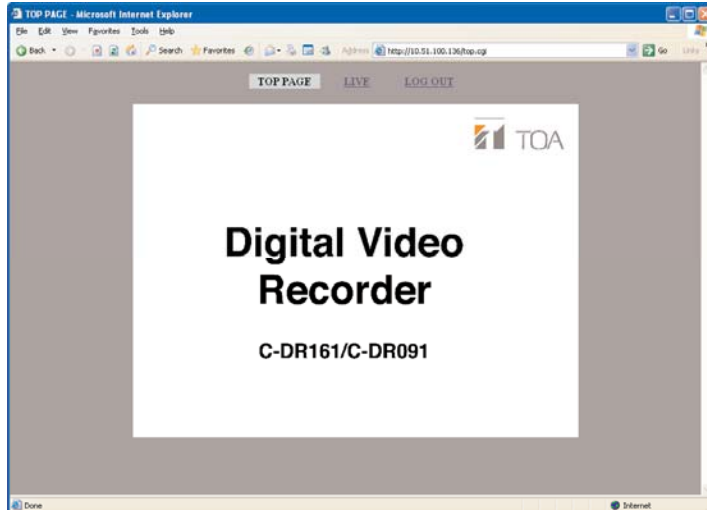

- Top page
- Live Image transmission (p. 107)
- Logout

### Notes

- To logout, be sure to terminate the operation by clicking "Logout."
- The automatic logout function uses the Digital Video Recorder's clock. Therefore, changing time settings during login using the Digital Video Recorder menu or web menu could automatically cause you to log out of the system. If this happens and you do not wish to log out, simply log in again.
- If the message "Pages not displayed" is displayed when switched to other page, wait for a several seconds to press the Update key of the browser.

## 31.5. Menu Screen

The menu screen is used to view or change the Digital Video Recorder's setting contents. Selecting "Menu" on the top page of Administrator account page gives access to the menu screen. Clicking a setting item in the main menu displays its content on the right side of the screen. (Refer to p. 74; Main Menu setting.)

### 31.5.1. Menu screen setting

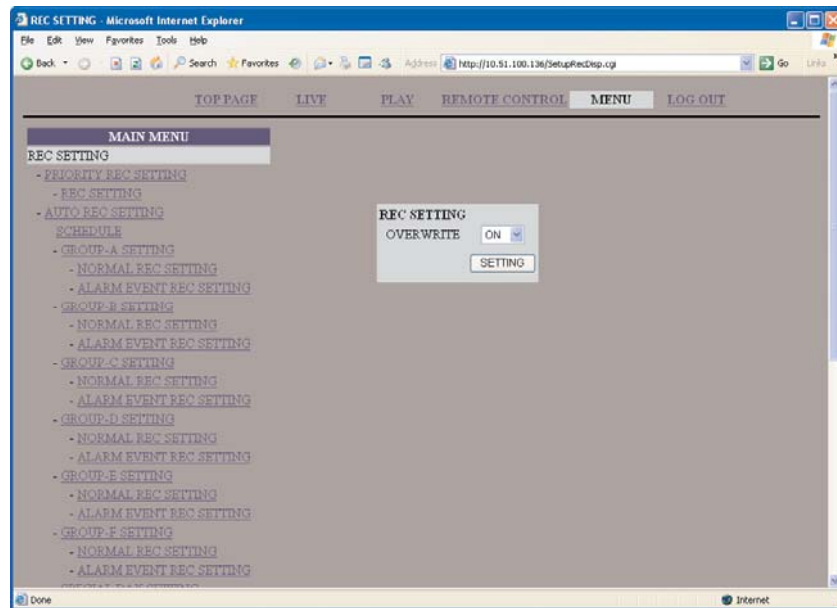

#### Note

The following setting items cannot be viewed or changed from the web server function menu. These must be set using the Digital Video Recorder itself.

- USB key registration
- USB key data erasure
- Disk mode
- Hard disk initialization
- Setting initialization
- Log initialization
- Setting external output
- Setting external input

#### Notes

- Setting cannot be changed on the PC's web screen when the screen other than the Digital Video Recorder's live screen is being displayed using the Digital Video Recorder or Remote Controller.
- Changing the settings related to the Digital Video Recorder's displays causes the screen not to be updated without operating the Digital Video Recorder.
- Camera name and DVR names in French set at the Digital Video Recorder cannot be displayed on the web screen. French cannot be input on the web screen.

## 31.6. Live Image Transmission

Live images can be monitored and the combination camera controlled.

### 31.6.1. For administrator account

Live images and the camera number are displayed on the images display section of the screen. By default the screen is split into 16 segments or 9 segments. When a multiple-segment split screen is displayed, right-clicking on the picture display portion will bring up a pop-up menu that allows selection of cameras 1 through 16, and the selected camera's image is displayed. (This selection is not available for full-screen display.) Camera images to be displayed can be switched using the screen change button located at the bottom of image display section. Camera menu can be set and the Combination Camera controlled at the camera control section located on the right of the screen.

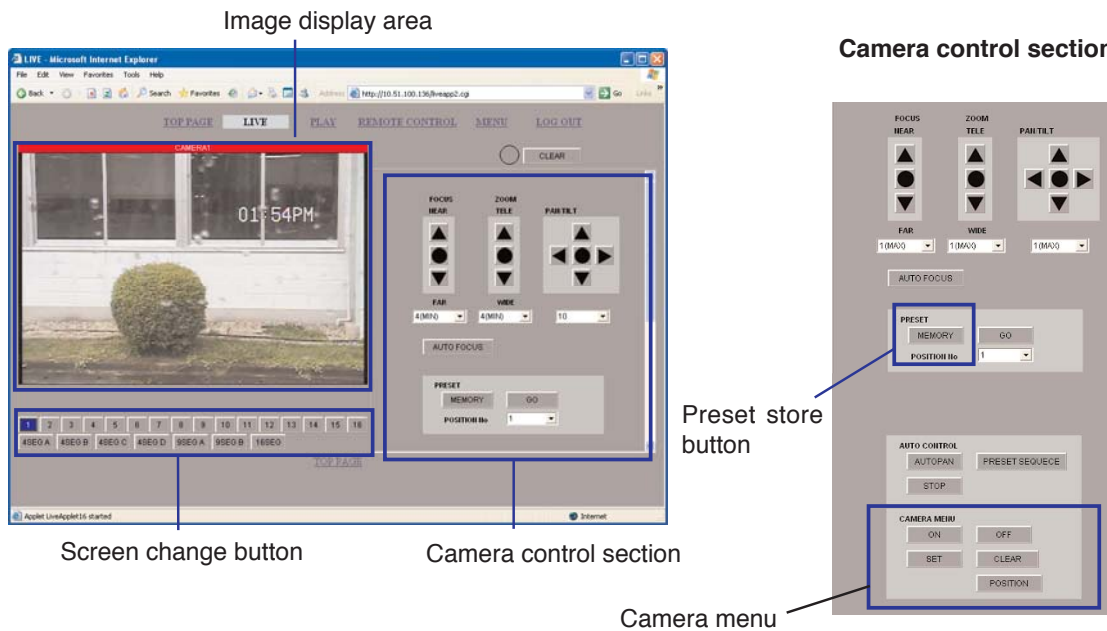

**Note:** It is not possible to simultaneously select two or more live screens for the same camera.

### 31.6.2. For user account

For user account, the camera menu buttons nor preset store button is displayed.

### 31.6.3. Screen change button



The screen change button switches camera images to be displayed on the screen. Clicking the button displays live images of the corresponding camera or multi-split screens.

**Note:** When it takes time to update the images, the screen will be dark while screen change is in progress.

### 31.6.4. Camera control section

Controls Combination Cameras connected to the Digital Video Recorder, Only the camera of which image is displayed in full-screen can be controlled. In multi-split screen displays, the camera control operation section of the screen turns gray, making it impossible to control the camera.

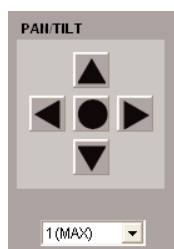

#### [ Pan & Tilt ]

Controls the camera's pan/tilt operations.

Use buttons to move the camera in the indicated direction, then stop the movement by pressing the central button. The speed of the movement can be adjusted by choosing the desired speed from 1 (MAX) to 16 (MIN) in the dropdown list box located under the button. Default value: 10



#### [ Zoom ]

Controls camera zooming.

Press the upper button to display images in telephoto mode. Press the lower button to display images in wide-angle view mode. Press the central button to stop the movement. The speed of the movement can be adjusted by choosing the desired speed from 1 (MAX) to 4 (MIN) in the dropdown list box located under the button.

Default value: 4 (MIN)

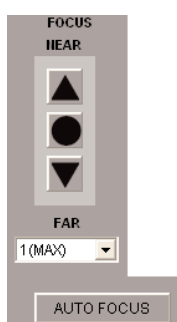

#### [ Focus ]

Controls camera focus.

Pressing the upper button focuses on nearer objects, while pressing the lower button focuses on farther objects. Press the central button to stop movement. The speed of the movement can be adjusted by choosing the desired speed from 1 (MAX) to 4 (MIN) in the dropdown list box located under the button. Default value: 4 (MIN)

#### [ Auto Focus ]

Pressing the Auto Focus button enables auto focus function.



### [ Preset ]

Choose position numbers from the dropdown list box.

Store: Programs the current camera position into the position number.

Move: Moves the camera to the programmed position.

#### Notes

- The camera will not move if a number with no preset position number is selected, even if the "Move" button is pressed. Up to 255 preset positions can be stored.
- Preset number storing can be performed only using the administrator account.



### [ Auto Control ]

Auto Pan: Automatically pans Combination Cameras.

Preset Sequence: Operates Combination Cameras in preset sequential order.

Stop: Stops auto pan or preset sequence operations.

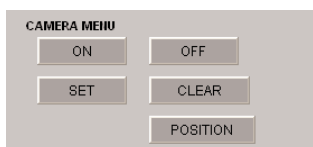

### [ Camera Menu ]

Used to operate the Combination Camera menu. (For more detailed information, refer to the Combination Camera instruction manual.)

ON: Enters the camera menu.

OFF: Exits the camera menu.

Set: Sets camera menu selection.

Clear: Clears the camera menu item.

Position Selection: Selects camera positions.

#### Notes

- Only an administrator account can use the camera menu.
- The Camera menu may not function correctly if different maker's Combination Cameras are included in the system.

## 31.7. Playback Transmission

Click on the "Playback Transmission" button to display the security screen below. Click on "Execute" button to display the Playback screen. Clicking the check box of "I always rely on the contents from this issuer" hides the security screen display from the next time.



Recorded image can be played back, searched, and downloaded. Administrator account can perform these operations.

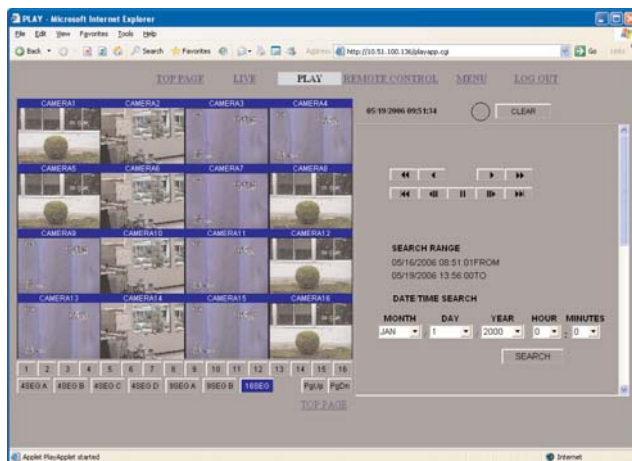

### Playback/Search operation section

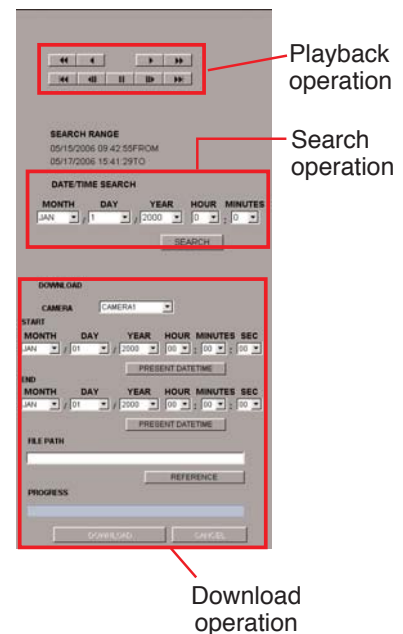

Playback images are displayed in the image display section. When power has just been switched on or when there is no recording data, playback images are not displayed and the screen will be dark. Perform playback and search operations using the playback and search operation sections to the right of the screen. The recording time for images being played back is displayed in the clock display section during playback.

### 31.7.1. Playback Operations

The playback operation section has a variety of buttons that allow the following types of playback and control:

- ▶▶ :Fast playback (at speed X2, X4 or X8)
- ◀ : Reverse playback
- ▶ : Forward playback
- ◀◀ : Fast reverse playback (at speed X2, X4 or X8)
- ◀|| : Frame reverse during temporary playback stop
- || : Pause
- ||▶ : Frame advance during temporary playback stop
- ◀◀◀ : Displays the earliest image in a pause mode.
- ▶▶▶ : Displays the latest image in a pause mode.

#### Playback operation section



#### Notes

- When forward or reverse playback reaches the oldest or newest recorded data, playback is temporarily stopped at the last image.
- Playback cannot be made during download.
- Playback speed of fast playback or fast reverse playback does not show an accurate speed. It may be played back slower than the indications.
- Playback or reverse playback cannot be made if set to "overwrite." In such case, perform playback by designating the date/time or after displaying the oldest or newest recorded images.

### 31.7.2. Searching

The search section allows image data recorded to the Digital Video Recorder to be searched by date/time. Entering the date and time for which you wish to search and pressing "Search" displays the image recorded nearest after the specified time. If there is no data newer than the specified date, the display will remain unchanged.

SEARCH RANGE  
05/15/2006 09:42:55FROM  
05/17/2006 15:41:29TO

DATE/TIME SEARCH

MONTH	DAY	YEAR	HOUR	MINUTES
JAN	1	2000	0	0

SEARCH

Playback can be controlled at the Playback Operation section.

#### Note

The start and end times of the search operation portion will not be updated. To update times, press the browser's update button or display the TOP screen, then display the playback transmission screen.

### 31.7.3. Download

Download the past images recorded by the Digital Video Recorder to a client PC's hard disk drive. This operation can be accessed only by an Administrator account. Downloading begins once the start and end times, camera, and destination to save have been selected and the "Download" button is pressed. Pressing the "Cancel" button stops downloading. Downloaded images are saved to the destination folder to save under a filename, like the one shown below, as multiple JPEG files.

(Example) 0 4 0 2 1 3 0 0 0 0 0 0 0 1 .JPG  
          └┘ └┘ └┘ └┘ └┘ └┘ └┘ └┘  
          year month hour second   Picture  
  image No.

DOWNLOAD

CAMERA: CAMERA1

START

MONTH: JAN DAY: 01 YEAR: 2000 HOUR: 00 MINUTES: 00 SEC: 00

PRESENT DATETIME

END

MONTH: JAN DAY: 01 YEAR: 2000 HOUR: 00 MINUTES: 00 SEC: 00

PRESENT DATETIME

FILE PATH

REFERENCE

PROGRESS

DOWNLOAD CANCEL

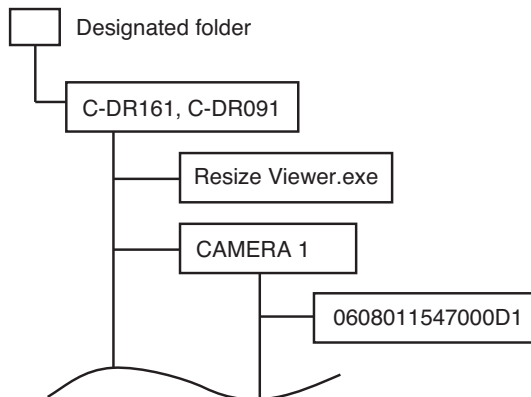

#### Notes

- Images will not be downloaded if the entered end time is older than the start time.
- Be sure to designate the destination to save. Otherwise, downloading cannot be initiated.
- Images may not be downloaded if they have not been recorded consecutively from start time to end time.
- If there is no recording date to download at the designated day and time, create a new folder, then download the special viewer software only.



### 31.7.4. Duplex Display

While recorded images are being played back on the multi-segment split screens, live images can also be displayed simultaneously by replacing some of the display segments with live images. Right-clicking on any display segment causes the popup menu to appear.

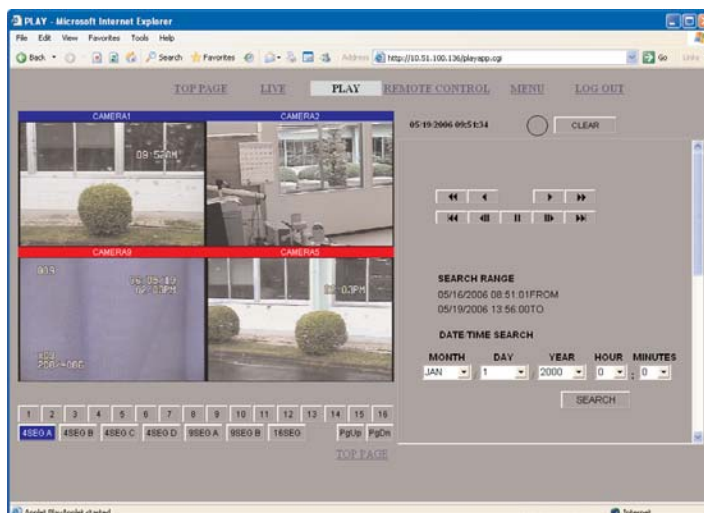

Selecting “Cameras 1-9 (1-16) Live” in the popup menu and one of the cameras causes the image display area that has displayed the popup menu to switch to the selected camera’s live images or recorded image playback. Live image positions are saved on the PC for each multi-segment split screen. Duplex setting data is saved to a client PC and the multi-segment split screen is displayed in saved duplex setting format the next time the PC logs in.

#### Notes

- It is impossible to replace all screen segments with live image displays, and the popup menu used to switch to live instead of recorded image display is disabled when only one screen segment remains displaying recorded images.
- It is not possible to simultaneously select two or more live screens for the same camera.

## 31.8. Remote Control

Remote control provides the same operations available on the front panel of the Digital Video Recorder, and can be accessed only by an administrator account. To achieve the same result as holding down the key for 2 seconds on the Digital Video Recorder, press the “LONG” button first and then the desired key.



The front-mounted indicators indicate the status concerning such events as screen display, recording, equipment failures, and activation of the Digital video Recorder.

The status display is updated every 10 seconds.

Event	LED	Contents
Display	Cameras 1–16	The number of camera currently displayed lights.
	Priority recording	Lights during Priority Recording.
	Monitor	Lights when the Monitor 2 is operated.
	Alarm reset	Lights when the Alarm Event occurs.
	Zoom	Lights while the Zoom screen is displayed.
	Multi-segment split screen	Lights while the Multi-segment split screen is displayed.
	Sequence	Lights while the sequence screen is displayed.
	◀, ▶	Lights during playback or reverse playback.
	▲	Lights during Pause.
Recording	Recording	Lights during recording.
Failure	Equipment failure	Lights when video loss, fan failure, or hard disk failure has occurred.
	Available disk space	Lights when the preset hard disk remaining time reaches or at the hard disk full status.
Activation	Power	Lights at the standby status or during DVR activation.

### 31.9. Web Indication Setting

The LED indicator on the PC connected to the Digital Video Recorder lights when Alarm Input is received, Priority Recording is activated or the system is operated. The indicator on the client PC illuminates if the following conditions (1) - (3) are met.

- (1) The Web Indication setting is selected on the menu setting, and one of the conditions set to "ON" in the transmission condition settings occurs.
- (2) The client PC is connected.
- (3) The client PC is displaying a live image or recorded images playback screen.

The LED indicator on the live or playback screen lights when Priority Recording is activated or when equipment failure occurs. If the indicator remains lit, check the log to see the contents. Extinguish the indicator by pressing the "Clear" button beside indicator.

#### Note

This setting is only available using the web menu, and cannot be performed via the Digital Video Recorder's menu.

#### [ Live image screen ]



The LED indicator (brights red)

## 32. RECORDING TIME TABLE

### 32.1. About Picture Quality Settings During Recording

The Digital Video Recorder offers five levels of picture quality, allowing desired picture quality to be balanced with desired recording time. To set the appropriate picture quality, first determine parameters for desired recording times, recording intervals, and recording types based on monitoring conditions. It is advisable to conduct test recordings to ensure that the resulting recordings balance picture quality against needed recording time correctly as desired. (Note: The recording times specified in the accompanying tables are guidelines only, and actual values may vary.) (Refer to [p. 44](#); Recording Rate.)

#### Notes

- The following tables show estimated recording times based on identical recording rates for all cameras.
- The maximum total recording rate is 120 IPS for the normal mode and 60 IPS for the Mirror mode.
- The following table shows the recording time of the normal mode. The recording time of mirror recording mode is half that of normal mode.
- Mirror recording mode cannot be used with models having hard disk drive capacities of 80 GB or 160 GB alone.
- The numbers shown in the tables indicate hours of recording time.

#### [ For the C-DR091-08 and C-DR091D08 Digital Video Recorders ]

Camera: x 9, Hard Disk: 80 GB, Audio recording: OFF

Picture quality	File size	Recording rate per camera (IPS) and recording time (hour)										
		8	4	2	1	1/2	1/3	1/5	1/10	1/20	1/30	1/60
1 (High)	64 KB	4	9	18	37	75	113	189	378	719	1060	2121
2	40 KB	7	15	30	60	120	180	300	600	1141	1681	3363
3	32 KB	9	18	37	74	149	223	373	746	1417	2089	4178
4	24 KB	12	24	49	98	197	295	492	985	1871	2758	5516
5 (Low)	16 KB	18	36	72	144	289	434	724	1448	2752	4055	8111

Camera: x 9, Hard Disk: 80 GB, Audio recording: ON

Picture quality	File size	Recording rate per camera (IPS) and recording time (hour)										
		8	4	2	1	1/2	1/3	1/5	1/10	1/20	1/30	1/60
1 (High)	64 KB	4	9	18	36	71	104	165	294	467	590	817
2	40 KB	7	14	29	57	110	158	244	413	614	742	953
3	32 KB	9	18	36	70	134	191	291	477	686	812	1008
4	24 KB	12	24	47	91	171	241	359	565	777	897	1071
5 (Low)	16 KB	17	35	68	130	237	327	468	693	896	1001	1142

#### [ For the C-DR091-1 and C-DR091D1 Digital Video Recorders ]

Camera: x 9, Hard Disk: 160 GB, Audio recording: OFF

Picture quality	File size	Recording rate per camera (IPS) and recording time (hour)										
		8	4	2	1	1/2	1/3	1/5	1/10	1/20	1/30	1/60
1 (High)	64 KB	9	19	39	78	156	235	392	784	1490	2195	4391
2	40 KB	15	31	62	124	248	373	621	1243	2362	3481	6962
3	32 KB	19	38	77	154	308	463	772	1544	2935	4325	8650
4	24 KB	25	50	101	203	407	611	1019	2039	3874	5709	11418
5 (Low)	16 KB	37	74	149	299	599	899	1499	2998	5697	8396	16792

Camera: x 9, Hard Disk: 160 GB, Audio recording: ON

Picture quality	File size	Recording rate per camera (IPS) and recording time (hour)										
		8	4	2	1	1/2	1/3	1/5	1/10	1/20	1/30	1/60
1 (High)	64 KB	9	19	38	76	148	216	343	610	966	1221	1692
2	40 KB	15	30	60	118	228	328	507	856	1271	1537	1972
3	32 KB	19	38	75	146	277	396	603	989	1420	1682	2088
4	24 KB	25	50	98	189	355	500	743	1171	1609	1857	2218
5 (Low)	16 KB	36	72	142	270	492	678	970	1435	1856	2073	2365

**[ For the C-DR091-3 and C-DR091D3 Digital Video Recorders ]**

Camera: x 9, Hard Disk: 320 GB, Audio recording: OFF

Picture quality	File size	Recording rate per camera (IPS) and recording time (hour)										
		8	4	2	1	1/2	1/3	1/5	1/10	1/20	1/30	1/60
1 (High)	64 KB	19	39	78	156	313	470	784	1568	2980	4391	8783
2	40 KB	31	62	124	248	497	746	1243	2486	4724	6962	13925
3	32 KB	38	77	154	308	617	926	1544	3089	5870	8650	17301
4	24 KB	50	101	203	407	815	1223	2039	4078	7748	11418	22837
5 (Low)	16 KB	74	149	299	599	1199	1799	2998	5997	11394	16792	33585

Camera: x 9, Hard Disk: 320 GB, Audio recording: ON

Picture quality	File size	Recording rate per camera (IPS) and recording time (hour)										
		8	4	2	1	1/2	1/3	1/5	1/10	1/20	1/30	1/60
1 (High)	64 KB	19	38	77	152	296	433	686	1220	1933	2443	3384
2	40 KB	30	61	121	237	456	656	1014	1712	2542	3074	3945
3	32 KB	38	76	150	292	555	793	1206	1978	2840	3364	4176
4	24 KB	50	100	196	379	710	1001	1487	2342	3218	3714	4436
5 (Low)	16 KB	73	145	284	540	984	1356	1941	2870	3712	4146	4730

**[ For the C-DR091-6 and C-DR091D6 Digital Video Recorder ]**

Camera: x 9, Hard Disk: 600 GB, Audio recording: OFF

Picture quality	File size	Recording rate per camera (IPS) and recording time (hour)										
		8	4	2	1	1/2	1/3	1/5	1/10	1/20	1/30	1/60
1 (High)	64 KB	36	72	145	291	583	874	1457	2915	5539	8163	16326
2	40 KB	57	115	231	462	924	1386	2311	4622	8782	12941	25883
3	32 KB	71	143	287	574	1148	1722	2871	5742	10911	16079	32158
4	24 KB	94	189	379	758	1516	2274	3790	7580	14402	21224	42449
5 (Low)	16 KB	139	278	557	1114	2229	3344	5573	11147	21180	31212	62425

Camera: x 9, Hard Disk: 600 GB, Audio recording: ON

Picture quality	File size	Recording rate per camera (IPS) and recording time (hour)										
		8	4	2	1	1/2	1/3	1/5	1/10	1/20	1/30	1/60
1 (High)	64 KB	36	72	143	283	551	805	1275	2269	3593	4540	6290
2	40 KB	57	114	226	442	847	1221	1885	3184	4726	5714	7333
3	32 KB	71	141	279	543	1032	1474	2242	3678	5280	6253	7763
4	24 KB	93	186	365	705	1320	1860	2765	4354	5982	6904	8245
5 (Low)	16 KB	137	271	528	1005	1830	2520	3608	5335	6899	7706	8792

**[ For the C-DR161-08 and C-DR161D08 Digital Video Recorders ]**

Camera: x 16, Hard Disk: 80 GB, Audio recording: OFF

Picture quality	File size	Recording rate per camera (IPS) and recording time (hour)										
		8	4	2	1	1/2	1/3	1/5	1/10	1/20	1/30	1/60
1 (High)	64 KB	2	5	10	21	42	63	106	213	404	596	1193
2	40 KB	4	8	16	33	67	101	168	337	641	945	1891
3	32 KB	5	10	20	41	83	125	209	419	797	1175	2350
4	24 KB	6	13	27	55	110	166	277	554	1052	1551	3102
5 (Low)	16 KB	10	20	40	81	162	244	407	814	1548	2281	4562

Camera: x 16, Hard Disk: 80 GB, Audio recording: ON

Picture quality	File size	Recording rate per camera (IPS) and recording time (hour)										
		8	4	2	1	1/2	1/3	1/5	1/10	1/20	1/30	1/60
1 (High)	64 KB	2	5	10	20	41	60	98	183	310	411	628
2	40 KB	4	8	16	32	64	94	149	269	432	552	780
3	32 KB	5	10	20	40	78	115	181	319	498	623	849
4	24 KB	6	13	27	53	102	147	229	391	587	716	930
5 (Low)	16 KB	10	20	39	76	145	206	311	505	715	840	1029

**[ For the C-DR161-1 and C-DR161D1 Digital Video Recorders ]**

Camera: x 16, Hard Disk: 160 GB, Audio recording: OFF

Picture quality	File size	Recording rate per camera (IPS) and recording time (hour)										
		8	4	2	1	1/2	1/3	1/5	1/10	1/20	1/30	1/60
1 (High)	64 KB	5	11	22	44	88	132	220	441	838	1235	2470
2	40 KB	8	17	34	69	139	209	349	699	1328	1958	3916
3	32 KB	10	21	43	86	173	260	434	868	1650	2433	4866
4	24 KB	14	28	57	114	229	344	573	1146	2179	3211	6423
5 (Low)	16 KB	21	42	84	168	337	506	843	1686	3204	4722	9445

Camera: x 16, Hard Disk: 160 GB, Audio recording: ON

Picture quality	File size	Recording rate per camera (IPS) and recording time (hour)										
		8	4	2	1	1/2	1/3	1/5	1/10	1/20	1/30	1/60
1 (High)	64 KB	5	10	21	43	85	126	204	380	642	852	1301
2	40 KB	8	17	34	68	133	194	310	557	896	1144	1616
3	32 KB	10	21	42	84	163	238	375	660	1032	1291	1758
4	24 KB	14	28	56	110	211	305	474	809	1216	1482	1926
5 (Low)	16 KB	20	41	81	158	300	427	645	1045	1480	1739	2131

**[ For the C-DR161-3 and C-DR161D3 Digital Video Recorders ]**

Camera: x 16, Hard Disk: 320 GB, Audio recording: OFF

Picture quality	File size	Recording rate per camera (IPS) and recording time (hour)										
		8	4	2	1	1/2	1/3	1/5	1/10	1/20	1/30	1/60
1 (High)	64 KB	11	22	44	88	176	264	441	882	1676	2470	4940
2	40 KB	17	34	69	139	279	419	699	1398	2657	3916	7833
3	32 KB	21	43	86	173	347	521	868	1737	3301	4866	9732
4	24 KB	28	57	114	229	458	688	1146	2293	4358	6423	12846
5 (Low)	16 KB	42	84	168	337	674	1012	1686	3373	6409	9445	18891

Camera: x 16, Hard Disk: 320 GB, Audio recording: ON

Picture quality	File size	Recording rate per camera (IPS) and recording time (hour)										
		8	4	2	1	1/2	1/3	1/5	1/10	1/20	1/30	1/60
1 (High)	64 KB	11	21	43	86	170	252	408	760	1285	1705	2603
2	40 KB	17	34	69	136	266	389	620	1115	1792	2288	3233
3	32 KB	21	43	85	168	326	476	750	1320	2064	2583	3516
4	24 KB	28	56	112	220	423	611	949	1619	2432	2964	3853
5 (Low)	16 KB	41	83	163	317	601	854	1291	2091	2961	3478	4263

**[ For the C-DR161-6 and C-DR161D6 Digital Video Recorders ]**

Camera: x 16, Hard Disk: 600 GB, Audio recording: OFF

Picture quality	File size	Recording rate per camera (IPS) and recording time (hour)										
		8	4	2	1	1/2	1/3	1/5	1/10	1/20	1/30	1/60
1 (High)	64 KB	20	40	81	163	327	491	819	1639	3115	4591	9183
2	40 KB	32	64	129	259	519	779	1299	2599	4939	7279	14559
3	32 KB	40	80	161	323	646	969	1615	3230	6137	9044	18089
4	24 KB	53	106	213	426	852	1279	2131	4263	8101	11938	23877
5 (Low)	16 KB	78	156	313	627	1254	1881	3135	6270	11913	17557	35114

Camera: x 16, Hard Disk: 600 GB, Audio recording: ON

Picture quality	File size	Recording rate per camera (IPS) and recording time (hour)										
		8	4	2	1	1/2	1/3	1/5	1/10	1/20	1/30	1/60
1 (High)	64 KB	20	40	81	161	317	469	759	1413	2388	3169	4840
2	40 KB	32	64	128	253	494	724	1153	2073	3331	4253	6009
3	32 KB	40	80	159	313	607	885	1394	2455	3836	4801	6535
4	24 KB	53	105	208	409	787	1137	1764	3009	4521	5510	7163
5 (Low)	16 KB	77	154	304	590	1117	1589	2399	3888	5504	6465	7924

### 33. TROUBLESHOOTING

Symptom	Possible Cause	Remedy
Power does not turn on. (Unit not activated even if the power key is pressed.)	Supplied power cord not correctly connected to the unit's power receptacle and wall AC outlet.	Connect the power cord correctly.
Cannot operate front panel keys.	Security settings in effect.	Operation level has been set in security setting. Check the security setting contents. (Refer to <a href="#">p. 60</a> ; About Security Setting.)
No picture.	<ul style="list-style-type: none"> <li>• Power not switched on.</li> <li>• Cables not correctly connected.</li> </ul>	<ul style="list-style-type: none"> <li>• Switch on the power.</li> <li>• Connect cables correctly.</li> </ul>
Cannot shut off the unit using the power switch.	Power key not continuously pressed.	Hold down the power key for 2 seconds or more.
Cannot stop auto recording.	Within the scheduled recording time	Try to stop outside the scheduled recording time.
Cannot make auto (Normal) recording.	<ul style="list-style-type: none"> <li>• Outside the scheduled recording time.</li> <li>• Camera recording set to OFF in Normal recording settings.</li> </ul>	<ul style="list-style-type: none"> <li>• Set to perform recording within the scheduled recording time.</li> <li>• Set camera recording to ON in Normal recording settings.</li> </ul>
Cannot make auto (Alarm Event) recording.	<ul style="list-style-type: none"> <li>• Outside the scheduled recording time.</li> <li>• Camera recording set to OFF in Alarm Event recording settings.</li> </ul>	<ul style="list-style-type: none"> <li>• Set to perform recording within the scheduled recording time.</li> <li>• Set camera recording to ON in Alarm Event recording settings.</li> </ul>
Sound not recorded.	Setting set to OFF.	Set setting to ON.
Cannot perform playback or reverse playback.	No recorded data.	Playback recorded data.
Cannot search.	No recorded data.	Search recorded data.
Cannot archive	<ul style="list-style-type: none"> <li>• No recorded data.</li> <li>• DVD-R/RW disk or USB memory not inserted.</li> </ul>	<ul style="list-style-type: none"> <li>• Archive recorded data.</li> <li>• Insert DVD-R/RW disk or USB memory.</li> </ul>
Failure indicator flashes.	Check the content of failure log file.	Remove the cause of the failure.
Cannot eject DVD.	DVD cannot ejected by pressing DVD eject key.	Press the hole (forced eject hole) located below the DVD insert tray. In this case, be sure to reactivate the power.

## Error Message List

Screen Display (Message)	Status	Action	Remarks
<b>• During Playback or Recording</b>			
*	Displayed when a fan fails.	Replace the fan.	
<b>• During Archiving Images</b>			
TERMINATED FOR LACK OF AVAILABLE MEDIA SPACE	Displayed during archiving or transfer.	Insert a new media and retry archiving.	
TRANSFER ERROR HAS BEEN DETECTED	Displayed during archiving or transfer.	Retry.	
START AND END POSITIONS NOT CORRECTLY SET	Displayed during archiving or transfer.	Set start and end positions correctly.	
<b>• During Equipment Maintenance</b>			
FAILED	Displayed when a maintenance procedure has failed.	Retry maintenance procedure.	
REGISTERED	Displayed when performing USB key registration.	Cancel the USB key and attempt registration again.	
<b>• During Event Search</b>			
NOTHING FOUND	Displayed when no relevant search data exists.	Change search conditions and retry.	
<b>• Hard Disk Error</b>			
AN ERROR HAS BEEN DETECTED ON THE HARD DISK. PLEASE REACTIVATE USING THE POWER KEY.	Displayed when a hard disk error occurs.	Reactivate.	
AN ERROR HAS BEEN DETECTED ON THE HARD DISK CURRENTLY BEING USED FOR PLAYBACK. PLAYBACK WILL STOP.	Displayed when a hard disk error occurs.	Press the Play-Stop key.	
AN ERROR HAS BEEN DETECTED ON THE HARD DISK. PLEASE REACTIVATE USING THE POWER KEY. EXECUTE?	Displayed when a hard disk error occurs.	Select recording mode (Normal or Mirror) and then reactivate.	
<b>• When entering a password</b>			
UNRECOGNIZED PASSWORD	Displayed when an incorrect password has been entered.	Enter a correct password.	
<b>• Priority Recording and Auto Recording</b>			
MAX REC RATE EXCEEDED	Displayed if the balance of number of cameras and recording rate has been set inappropriately.	Change the recording rate so as not to exceed the maximum recording rate (120 IPS).	
<b>• After Setting Completion</b>			
UNIT MUST BE REACTIVATED TO MAKE SETTINGS VALID. REACTIVATE RIGHT NOW?	Displayed after setting completion.	Reactivate.	
<b>• During Playback</b>			
PLAYBACK IMAGE NOT FOUND. STOP PLAYBACK.	Displayed during playback.	Press the Play-Stop key.	



## 34. INDEX

Operation Item	Display Status	Reference Page
• Mounting Equipment in Racks		
Rack mounting	How to rack-mount equipment	P. 19
• Connecting Equipment		
Connecting cameras	Nomenclature and functions, No. 25 and No. 30 (camera control terminals)	P. 17, 18
	How to make connections	P. 20
	Control input/output terminal connections	P. 25
	System settings (camera protocol and camera transmission rate)	P. 93
Remote Controller Connections	Nomenclature and functions, No. 30 (remote control input/output terminal B), No. 32 and No. 33	P. 18
	How to make connections	P. 20
	Control input/output terminal connections	P. 25
	System settings (remote control transmission rate and remote control communication response)	P. 93
	Security settings (remote access restriction)	P. 65
Expansion Unit Connections	Nomenclature and functions, No. 31	P. 18
	Equipment maintenance (expansion units 1 and 2)	P. 101
Cascade Connections	Nomenclature and functions, No. 22, No. 23, No. 30 (remote control input/output terminal B) and No. 33	P. 17, 18
	Control input/output terminal connections	P. 25
	DVR unit number settings	P. 27
	System settings (DVR-ID)	P. 93
	Sequence settings (for use in group sequences)	P. 30, 88
LAN Connections	Nomenclature and functions, No. 28	P. 17
	10BASE-T/100BASE-TX terminal connections	P. 25
	Network settings	P. 90
• Monitor Display		
Monitor Connections	Nomenclature and functions, No. 23	P. 17
	How to make connections	P. 20
Monitor Display Settings	Screen display settings (character display, monitor output, sequence, camera name, DVR name, screen display shown when monitors 1 and 2 are activated, and alarm camera display time)	P. 86
	Other functions	P. 36
Switching Monitor Displays	Displaying indications on the monitor	P. 31
Performing Playback and Reverse Playback	How to perform playback	P. 45
• Turning the Power Supply On and Off		
Turning the Power Supply On and Off	Unit activation and termination	P. 26
Setting Screen Displays Shown When Unit Is Activated	Screen display settings (screen displays shown when monitors 1 & 2 are activated)	P. 86
Confirming Logs for Power Activation	System log	P. 99
About Operation after Recovery from a Power Failure	About operation after recovery from a power failure	P. 70

Operation Item	Display Status	Reference Page
<b>• Adjusting the Time</b>		
Current Time Settings	Time adjustment	P. 27
	Clock settings	P. 100
Time Synchronization	Nomenclature and functions, No. 30 (time sync input/time sync output terminals)	P. 18
	Control input/output terminal connections (time sync input and output terminal connections)	P. 25
	Clock settings (time sync operation, synchronized time, and time sync output)	P. 100
	Network settings (NTP server and time zone)	P. 90
Daylight Savings Time Settings	Clock settings (daylight savings time)	P. 100
<b>• Hard Disk Settings</b>		
Initializing Hard Disks	Initial settings (initializing hard disks)	P. 28
	Hard disk initialization	P. 102
	Before recording (disk mode)	P. 38
	System log	P. 99
Allowing (Disallowing) Overwriting	Recording settings (overwrite)	P. 76
	System settings (remaining disk space-time indicator)	P. 93
	Before recording (disk recording mode)	P. 38
	Nomenclature and functions, No. 17 (available hard disk space indicator)	P. 16
	About the remaining disk space time indication and operation	P. 44
	Failure log	P. 99
	"Disk Full" indication	P. 69
Changing playback disks (mirror mode only)	System settings (playback disks)	P. 93
<b>• Performing Normal Recording (auto-recording based on schedules)</b>		
Understanding Normal Recording	About recording modes	P. 39
	Auto-recording	P. 40
	How to make a recording	P. 41
	Live mode indication	P. 32
	About recording rates	P. 44
	Recording time tables	P. 116
Settings for Normal Recording	Auto-recording settings	P. 29
	Auto-recording settings (audio)	P. 79
	Groups A-F settings (Normal recording settings)	P. 80
Setting Schedules	Auto-recording settings (setting schedules)	P. 29
	Auto-recording settings (scheduling)	P. 79
Setting Groups	Auto-recording settings (setting groups)	P. 30
	Auto-recording settings (groups A-F settings)	P. 80
<b>• Alarm Event Recording (alarm-activated auto-recording)</b>		
Understanding Alarm Event Recording	About recording modes	P. 39
	Auto-recording	P. 40
	How to make a recording	P. 41
	Live mode indication	P. 32
	About recording rates	P. 44
	Recording time tables	P. 116

Operation Item	Display Status	Reference Page
<b>• Alarm Event Recording (alarm-activated auto-recording)</b>		
Recording by Alarm Signal Input	Nomenclature and functions, No. 29	P. 17
	Alarm input/output terminal connections	P. 24
	Input/output terminal mode settings (Alarms 1-16)	P. 94
	Auto-recording settings (scheduling, Groups A-F settings)	P. 79
	Groups A-F settings (alarm event recording settings, alarm event recording mode, alarm input mode, and post-alarm interval)	P. 80
	Alarm event recording settings (recording, recording rates, display quality, event, recording rates for cameras other than event cameras)	P. 82
	Event settings (alarm input)	P. 83
Setting Operation by Alarm Input	Screen display settings (alarm camera display time)	P. 86
	System settings (preset camera settings)	P. 93
	Preset camera settings (camera and position)	P. 97
	Control output terminal settings (alarm recording)	P. 95
	Email settings (setting transmission conditions for cameras 1-16)	P. 92
Motion-Detected Alarm Recording	Auto-recording settings (scheduling, Groups A-F settings, motion settings)	P. 79
	Groups A-F settings (alarm event recording settings, alarm event recording mode, motion detection mode, and post-motion alarm period)	P. 80
	Alarm event recording settings (recording, recording rates, display quality, event, recording rates for cameras other than event cameras)	P. 82
	Event settings (motion detection camera)	P. 83
	Motion settings (cameras 1-16, sensitivity and motion activation)	P. 84
Setting Motion-Detected Operation	Screen display settings (alarm camera display time)	P. 86
	Control output terminal settings (motion-detected recording)	P. 95
	Email settings (setting transmission conditions for cameras 1-16)	P. 92
<b>• Priority recording</b>		
Understanding Priority recording	About recording modes	P. 39
	Priority recording	P. 39
	How to make a recording	P. 41
	Live mode display	P. 32
	About recording rates	P. 44
	Recording time tables	P. 116
Making Recordings Using the Priority recording key	Nomenclature and functions, No. 5	P. 14
	Priority recording settings (rec setting, audio, and post time)	P. 77
	Recording settings (rec, rec rates, and picture quality)	P. 78
Making Recordings Using the Priority recording input terminal	Nomenclature and functions, No. 30 (Priority recording input terminal)	P. 18
	I/O Terminal Mode Setting (Priority recording)	P. 94
	Priority recording setting (rec setting, priority rec input mode, audio, and post time)	P. 77
	Recording Setting (rec, rec rate, and picture quality)	P. 78
Setting operation by priority recording.	Control output terminal settings (priority recording)	P. 95
	Email settings (transmission control settings/priority recording)	P. 92

Operation Item	Display Status	Reference Page
<b>• Making Pre-Recordings</b>		
Understanding Pre-Recordings	Pre-recording	P. 41
	How to make a recording	P. 41
	About recording rates	P. 44
Setting Pre-Recordings	Recording settings (pre-recording settings)	P. 76
	Pre-recording settings (recording time, recording rate, recording picture quality, and audio)	P. 85
<b>• Security Settings</b>		
Understanding Security Settings	About security settings (passwords and operation levels)	P. 60
	Security settings using a USB key	P. 62
	Security settings for web access	P. 65
Security Settings Using a USB Key	Nomenclature and functions, No. 3	P. 14
	Equipment maintenance (registering and erasing USB keys)	P. 101
	Security settings using USB keys	P. 62
	Security settings (USB key level)	P. 62
	Logging in and logging out using a password (with valid USB setting)	P. 64
Security Using a Password	Security settings (operation levels 1–3)	P. 96
	Logging in and logging out using a password	P. 63
	Security settings (log-out time)	P. 96
Restricting Operation Access Via the Remote Controller	Security settings (remote access restriction)	P. 96
	See the remote controller's instruction manual for information on remote controller login and logout.	—
Security for Web Access	Network settings (web user password, web administrator password)	P. 90
	How to log in	P. 104
If you have forgotten the unit password... If you have lost the USB key...	Deactivate security using Menu → Securing Setting by web access.	P. 96
If you have forgotten the web password...	Confirm Network setting → User or Administrator password in the unit's menu.	P. 90
If you have forgotten both...	Contact your nearest TOA dealer.	—
<b>• Playing Recorded Images</b>		
Playing Recordings or Putting Recordings in Playback Mode.	How to play recordings (playback or reverse playback)	P. 45
Fast Forwarding (Reversing) Playback	How to play recordings (fast forward/fast reverse playback)	P. 46
Playing the Oldest Recordings	How to play recordings (earliest images)	P. 46
Playing the Latest Recordings	How to play recordings (latest images)	P. 46
Pausing	How to play recordings (pausing)	P. 46
Frame Advance (Reverse) Playback	How to play recordings (frame advance and frame reverse playback)	P. 46
Instant Event Access	About events	P. 47
	Recording log	P. 98
	Performing instant event access	P. 47
Putting Recordings in the Playback stop or Live Modes	How to play recordings (playing recordings)	P. 45
<b>• Searching Recorded Images</b>		
Searching by date and time	Searching (date and time)	P. 48
Searching by Event	About events	P. 47
	Recording log	P. 98
	Searching (events)	P. 49

Operation Item	Display Status	Reference Page
• Archiving Recorded Images and Pre-Archive PC Viewing		
Prior to Archiving	Archiving	P. 51
	Indications during Archiving (indications during archive transfer and error messages)	P. 55, 56
	Archiving & transfer times	P. 52
	Recommended DVD-R/RW media	P. 51
	Nomenclature and functions, No. 2, No. 18, No. 19, and No. 20	P. 14 -16
Selecting Archive Range by Date and Time	Archiving (by date and time)	P. 53
Selecting Archive Range from the Playback Screen	Archiving (from the playback screen)	P. 54
Viewing Archived Images on a PC	Viewing saved data	P. 56
• When the Failure Indicator Is Displayed...		
Confirming the Causes of Failures	Stopping the buzzer	P. 66
	Nomenclature and functions, No. 17 (equipment failure LED and remaining hard disk space LED)	P. 16
	Log display (failure log)	P. 99
	Error message table	P. 120
	Display During Archiving (error messages)	P. 56
	Troubleshooting	P. 119
	About the remaining disk space indicator and operation when hard disk is full	P. 44
When the Indication "Hard Disk Is Full" Appears...	"Hard Disk Is Full" indicator	P. 69
	Hard disk initialization	P. 102
	Recording settings (overwrite)	P. 76
When the Hard Disk Error Indicator Appears...	Operation when there is a hard disk error failure	P. 66
	Hard disk initialization	P. 102
When the Fan Error Failure Indicator Appears...	Fan failure	P. 69
When the Video Loss Indicator Appears...	Operation when there is a video loss failure	P. 68
Power Failures	Operation after a recovery from a power failure	P. 70
	Screen display settings (screen display when monitors 1 and 2 are activated)	P. 86
• Viewing on a PC from Remote Locations via Web Access		
Network Connections	Nomenclature and functions, No. 28	P. 17
	10BASE-T/100BASE-TX terminal connections	P. 25
	Network Settings	P. 90
	Web server function	P. 103
	How to log in to a network	P. 104
	Top page	P. 105
Switching Web Screen Indicators	Live image transmission (screen selection button)	P. 108
	Playback image transmission	P. 110
	Duplex display	P. 113
Controlling Cameras Via the Web	Live image transmission (screen selection button and camera control button)	P. 108
Playing Recorded Images Via the Web	Playback image transmission (playback operation and search operation)	P. 111

Operation Item	Display Status	Reference Page
• Viewing Images on a PC from Remote Locations Via Web Access		
Downloading Recorded Images Via the Web	Playback image transmission (download)	P. 112
Operating Unit Via the Web	Remote control	P. 114
Changing Unit Settings Via the Web	Menu screen	P. 106
	Web transmission settings	P. 115
• Email Transmission		
Email Transmission Settings	Nomenclature and functions, No. 28	P. 17
	10BASE-T/100BASE-TX terminal connections	P. 25
	Network settings	P. 90
	Email settings	P. 91
Setting Email Transmission Conditions	Transmission condition settings	P. 92
• Changing settings		
Logging in to operation level 1	How to log in to the system	P. 104
Menu Display and Menu Screen Operation	Nomenclature and functions, No. 6, No. 11, No. 13, No. 14, No. 15 and No. 16.	P. 14,15
	Displaying the menu on the monitor (switching monitors)	P. 31
	Setting procedures and table	P. 71
	Main menu settings	P. 74
	Menu screen (web)	P. 106
	Other functions (performing triplex and arrangement settings)	P. 36
Storing Settings Data	Equipment maintenance (setting external output)	P. 101
Reading Setting Data	Equipment maintenance (setting external input)	P. 101
Initialization	Hard disk initialization	P. 28,101
	Setting Initialization	P. 101
	Log initialization	P. 101
• Confirming Logs		
Confirming Recording Logs	Recording logs	P. 98
Confirming Failure Logs	Failure logs	P. 99
Confirming System Logs	System logs	P. 99

## 35. SPECIFICATIONS

\* 0 dB = 1V

Model	C-DR091-08	C-DR091-1	C-DR091-3	C-DR091-6
Power Source	110 – 120 V AC 50/60 Hz			
Power Consumption	400 mA	410 mA	480 mA	530 mA
Image Compression System	Motion-JPEG			
Video Format	NTSC			
Recording Medium	E-IDE Hard Disk 80 GB (80 GB x 1)	E-IDE Hard Disk 160 GB (160 GB x 1)	E-IDE Hard Disk 320 GB (160 GB x 2)	E-IDE Hard Disk 600 GB (300 GB x 2)
Video Input	9 channels, VBS1.0 V(p-p), 75 Ω, BNC			
Video Output	9 channels, VBS1.0V(p-p), 75 Ω, BNC, loop-through			
Monitor Output	2 channels, VBS1.0V(p-p), 75 Ω, BNC, 1 channel is dedicated to real-time image (Full-screen and 4-segment split screen display only. Nothing is displayed other than camera names and camera numbers.)			
Link Input	1 channel, VBS1.0V(p-p), 75 Ω, BNC, Connect the monitor output of other digital video recorder (C-DR091/161 series) to this terminal. Multiple digital video recorders can be operated and monitored with a single monitor by using the C-RM1000 Remote Controller (option).			
Audio Recording System	8 bits, Linear PCM, sampling frequency: 16 kHz			
Audio Input	1 channel, –10 dB*, 10 kΩ, unbalanced, RCA pin jack			
Audio Output	1 channel, –10 dB*, 600 Ω, unbalanced, RCA pin jack			
Screen Display	1-, 4-, 9-, segment screen sequence, electronic 2 x zoom			
Picture Quality	Changeable in 5 steps, (File size: 16 - 64KB) 64 KB (Quality 1), 40 KB (Quality 2), 32 KB (Quality 3), 24 KB (Quality 4), 16 KB (Quality 5)			
Pixels	720 x 240 pixels			
Recording Rate	Total recording rate 120 IPS (each camera can be individually set for the following rate) 120, 60, 30, 15, 8, 4, 2, 1, 1/2, 1/3, 1/5, 1/10, 1/20, 1/30, 1/60 IPS			
Pre-Recording	Max. 5 min (0 - 300 s)			
Post Alarm Recording	Max. 999 s (0 - 999 s), non-limit			
Date/Time	Year/ month/ date/ hour/ minute/ second, 24-hours format display, monthly deviation of within ±30 s (25°C (77°F)), can be operated until the year 2099			
Motion Detect	5 Sensitivity levels, can be turned on/off for individual areas			
Search Function	Date/Time search, Event search (Priority recording, Alarm-input recording, Normal recording, Motion detect recording, all)			
Alarm Input	9 channels (EDGE, LEVEL), no-voltage make contact input, open voltage: 2 V DC, short-circuit current: 1.5 mA, minimum short-circuit time: over 100 ms, loop resistance: under 100 Ω, screwless connector			
Control Output	4 channels (can be set for Priority recording, Alarm-input recording, Motion detect recording, Video loss, HD Full, Fan Failure, and HD Error) open collector output, withstand voltage: 30 V DC, control current : 20 mA, screwless connector			
Priority Recording Input	1 channel, no-voltage make contact input, open voltage: 2 V DC, short-circuit current: 1.5 mA, minimum short-circuit time: over 100 ms, loop resistance: under 100 Ω, screwless connector			
Time Synchronization Input	1 channel, no-voltage make contact input, open voltage: 2 V DC, short-circuit current: 1.5 mA, minimum short-circuit time: over 100 ms, loop resistance: under 100 Ω, screwless connector			
Time Synchronization Output	1 channel, open collector output, withstand voltage: 30 V DC, control current: 20 mA, screwless connector			
Camera Control	1 channel, RS-485, screwless connector			
Remote Control	1 channels, RS-485, screwless connector or RJ11			
Disk Array	2 channels, e-SATA (and dedicated control signal), e-SATA connector and modular connector			
Communication Function	RS-232C : D-sub connector (9 pin, male), 10 BASE-T/100 BASE-TX ethernet : RJ45			
Other Function	mail transmission capability, USB terminals (ARCHIVE, KEY LOCK), Web function (Real-time image, play-back, remote, menu), Language choice (English/ French/ Japanese)			
Altitude	Under 3,000 m (9,843 ft) (relative to sea level)			
Operating Temperature	+5°C to +40°C (41°F to 104°F) (+5°C to +35°C (41°F to 95°F) when mounted on a rack)			
Operating Humidity	Under 80% RH (no condensation)			
Finish	Panel: Surface-treated steel plate, black, paint, 30% gloss Case: Pre-coated steel plate, black			
Dimensions	420 (W) x 93.9 (H) x 332.8 (D) mm (16.5 (W) x 3.7 (H) x 13.1 (D) inch)			
Weight	5.7 kg (12.6 lb)	5.7 kg (12.6 lb)	6.5 kg (14.3 lb)	6.5 kg (14.3 lb)
Accessory	Power supply cord (2 m (6.6 ft)) ... 1			
Option	Rack mounting bracket: MB-23B			

Model	C-DR161-08	C-DR161-1	C-DR161-3	C-DR161-6
Power Source	110 – 120 V AC 50/60 Hz			
Power Consumption	430 mA	440 mA	540 mA	560 mA
Image Compression System	Motion-JPEG			
Video Format	NTSC			
Recording Medium	E-IDE Hard Disk 80 GB (80 GB x 1)	E-IDE Hard Disk 160 GB (160 GB x 1)	E-IDE Hard Disk 320 GB (160 GB x 2)	E-IDE Hard Disk 600 GB (300 GB x 2)
Video Input	16 channels, VBS1.0 V(p-p), 75 Ω, BNC			
Video Output	16 channels, VBS1.0V(p-p), 75 Ω, BNC, loop-through			
Monitor Output	2 channels, VBS1.0V(p-p), 75 Ω, BNC, 1 channel is dedicated to real-time image (Full-screen and 4-segment split screen display only. Nothing is displayed other than camera names and camera numbers.)			
Link Input	1 channel, VBS1.0V(p-p), 75Ω, BNC, Connect the monitor output of other digital video recorder (C-DR091/161 series) to this terminal. Multiple digital video recorders can be operated and monitored with a single monitor by using the C-RM1000 Remote Controller (option).			
Audio Recording System	8 bits, Linear PCM, sampling frequency: 16 kHz			
Audio Input	1 channel, –10 dB*, 10 kΩ, unbalanced, RCA pin jack			
Audio Output	1 channel, –10 dB*, 600 Ω, unbalanced, RCA pin jack			
Screen Display	1-, 4-, 9-, 16-, segment screen sequence, electronic 2 x zoom			
Picture Quality	Changeable in 5 steps, (File size: 16 - 64KB) 64 KB (Quality 1), 40 KB (Quality 2), 32 KB (Quality 3), 24 KB (Quality 4), 16 KB (Quality 5)			
Pixels	720 x 240 pixels			
Recording Rate	Total recording rate 120 IPS (each camera can be individually set for the following rate) 120, 60, 30, 15, 8, 4, 2, 1, 1/2, 1/3, 1/5, 1/10, 1/20, 1/30, 1/60 IPS			
Pre-Recording	Max. 5 min (0 - 300 s)			
Post Alarm Recording	Max. 999 s (0 - 999 s), non-limit			
Date/Time	Year/ month/ date/ hour/ minute/ second, 24-hours format display, monthly deviation of within ±30 s (25°C (77°F)), can be operated until the year 2099			
Motion Detect	5 Sensitivity levels, can be turned on/off for individual areas			
Search Function	Date/Time search, Event search (Priority recording, Alarm-input recording, Normal recording, Motion detect recording, all)			
Alarm Input	16 channels (EDGE, LEVEL), no-voltage make contact input, open voltage: 2 V DC, short-circuit current: 1.5 mA, minimum short-circuit time: over 100 ms, loop resistance: under 100 Ω, screwless connector			
Control Output	4 channels (can be set for Priority recording, Alarm-input recording, Motion detect recording Video loss, HD Full, Fan Failure, and HD Error) open collector output, withstand voltage: 30 V DC, control current : 20 mA, screwless connector			
Priority Recording Input	1 channel, no-voltage make contact input, open voltage: 2 V DC, short-circuit current: 1.5 mA, minimum short-circuit time: over 100 ms, loop resistance: under 100 Ω, screwless connector			
Time Synchronization Input	1 channel, no-voltage make contact input, open voltage: 2 V DC, short-circuit current: 1.5 mA, minimum short-circuit time: over 100 ms, loop resistance: under 100 Ω, screwless connector			
Time Synchronization Output	1 channel, open collector output, withstand voltage: 30 V DC, control current: 20 mA, screwless connector			
Camera Control	1 channel, RS-485, screwless connector			
Remote Control	1 channels, RS-485, screwless connector or RJ11			
Disk Array	2 channels, e-SATA (and dedicated control signal), e-SATA connector and modular connector			
Communication Function	RS-232C : D-sub connector (9 pin, male), 10 BASE-T/100 BASE-TX ethernet : RJ45			
Other Function	mail transmission capability, USB terminals (ARCHIVE, KEY LOCK), Web function (Real-time image, play-back, remote, menu), Language choice (English/ French/ Japanese)			
Altitude	Under 3,000 m (9,843 ft) (relative to sea level)			
Operating Temperature	+5°C to +40°C (41°F to 104°F) (+5°C to +35°C (41°F to 95°F) when mounted on a rack)			
Operating Humidity	Under 80% RH (no condensation)			
Finish	Panel: Surface-treated steel plate, black, paint, 30% gloss Case: Pre-coated steel plate, black			
Dimensions	420 (W) x 93.9 (H) x 332.8 (D) mm (16.5 (W) x 3.7 (H) x 13.1 (D) inch)			
Weight	5.8 kg (12.8 lb)	5.8 kg (12.8 lb)	6.6 kg (14.6 lb)	6.6 kg (14.6 lb)
Accessory	Power supply cord (2 m (6.6 ft)) ... 1			
Option	Rack mounting bracket: MB-23B			



Model	C-DR091D08	C-DR091D1	C-DR091D3	C-DR091D6
Power Source	110 – 120 V AC 50/60 Hz			
Power Consumption	490 mA	500 mA	570 mA	590 mA
Image Compression System	Motion-JPEG			
Video Format	NTSC			
Recording Medium	E-IDE Hard Disk 80 GB (80 GB x 1)	E-IDE Hard Disk 160 GB (160 GB x 1)	E-IDE Hard Disk 320 GB (160 GB x 2)	E-IDE Hard Disk 600 GB (300 GB x 2)
Video Input	9 channels, VBS1.0 V(p-p), 75 Ω, BNC			
Video Output	9 channels, VBS1.0V(p-p), 75 Ω, BNC, loop-through			
Monitor Output	2 channels, VBS1.0V(p-p), 75 Ω, BNC, 1 channel is dedicated to real-time image (Full-screen and 4-segment split screen display only. Nothing is displayed other than camera names and camera numbers.)			
Link Input	1 channel, VBS1.0V(p-p), 75 Ω, BNC, Connect the monitor output of other digital video recorder (C-DR091/161 series) to this terminal. Multiple digital video recorders can be operated and monitored with a single monitor by using the C-RM1000 Remote Controller (option).			
Audio Recording System	8 bits, Linear PCM, sampling frequency: 16 kHz			
Audio Input	1 channel, –10 dB*, 10 kΩ, unbalanced, RCA pin jack			
Audio Output	1 channel, –10 dB*, 600 Ω, unbalanced, RCA pin jack			
Screen Display	1-, 4-, 9-, segment screen sequence, electronic 2 x zoom			
Picture Quality	Changeable in 5 steps, (File size: 16 - 64KB) 64 KB (Quality 1), 40 KB (Quality 2), 32 KB (Quality 3), 24 KB (Quality 4), 16 KB (Quality 5)			
Pixels	720 x 240 pixels			
Recording Rate	Total recording rate 120 IPS (each camera can be individually set for the following rate) 120, 60, 30, 15, 8, 4, 2, 1, 1/2, 1/3, 1/5, 1/10, 1/20, 1/30, 1/60 IPS			
Pre-Recording	Max. 5 min (0 - 300 s)			
Post Alarm Recording	Max. 999 s (0 - 999 s), non-limit			
Date/Time	Year/ month/ date/ hour/ minute/ second, 24-hours format display, monthly deviation of within ±30 s (25°C (77°F)), can be operated until the year 2099			
Motion Detect	5 Sensitivity levels, can be turned on/off for individual areas			
Search Function	Date/Time search, Event search (Priority recording, Alarm-input recording, Normal recording, Motion detect recording, all)			
Alarm Input	9 channels (EDGE, LEVEL), no-voltage make contact input, open voltage: 2 V DC, short-circuit current: 1.5 mA, minimum short-circuit time: over 100 ms, loop resistance: under 100 Ω, screwless connector			
Control Output	4 channels (can be set for Priority recording, Alarm-input recording, Motion detect recording, Video loss, HD Full, Fan Failure, and HD Error) open collector output, withstand voltage: 30 V DC, control current : 20 mA, screwless connector			
Priority Recording Input	1 channel, no-voltage make contact input, open voltage: 2 V DC, short-circuit current: 1.5 mA, minimum short-circuit time: over 100 ms, loop resistance: under 100 Ω, screwless connector			
Time Synchronization Input	1 channel, no-voltage make contact input, open voltage: 2 V DC, short-circuit current: 1.5 mA, minimum short-circuit time: over 100 ms, loop resistance: under 100 Ω, screwless connector			
Time Synchronization Output	1 channel, open collector output, withstand voltage: 30 V DC, control current: 20 mA, screwless connector			
Camera Control	1 channel, RS-485, screwless connector			
Remote Control	1 channels, RS-485, screwless connector or RJ11			
Disk Array	2 channels, e-SATA (and dedicated control signal), e-SATA connector and modular connector			
Communication Function	RS-232C : D-sub connector (9 pin, male), 10 BASE-T/100 BASE-TX ethernet : RJ45			
Other Function	mail transmission capability, USB terminals (ARCHIVE, KEY LOCK), Web function (Real-time image, play-back, remote, menu) ,Language choice (English/ French/ Japanese)			
Applicable DVD Medium	DVD-R			
Altitude	Under 3,000 m (9,843 ft) (relative to sea level)			
Operating Temperature	+5°C to +40°C (41°F to 104°F) (+5°C to +35°C (41°F to 95°F) when mounted on a rack)			
Operating Humidity	Under 80% RH (no condensation)			
Finish	Panel: Surface-treated steel plate, black, paint, 30% gloss Case: Pre-coated steel plate, black			
Dimensions	420 (W) x 93.9 (H) x 332.8 (D) mm (16.5 (W) x 3.7 (H) x 13.1 (D) inch)			
Weight	6.8 kg (15.0 lb)	6.8 kg (15.0 lb)	7.6 kg (16.8 lb)	7.6 kg (16.8 lb)
Accessory	Power supply cord (2 m (6.6 ft)) ... 1			
Option	Rack mounting bracket: MB-23B			

Model	C-DR161D08	C-DR161D1	C-DR161D3	C-DR161D6
Power Source	110 – 120 V AC 50/60 Hz			
Power Consumption	530 mA	530 mA	610 mA	630 mA
Image Compression System	Motion-JPEG			
Video Format	NTSC			
Recording Medium	E-IDE Hard Disk 80 GB (80 GB x 1)	E-IDE Hard Disk 160 GB (160 GB x 1)	E-IDE Hard Disk 320 GB (160 GB x 2)	E-IDE Hard Disk 600 GB (300 GB x 2)
Video Input	16 channels, VBS1.0 V(p-p), 75 Ω, BNC			
Video Output	16 channels, VBS1.0V(p-p), 75 Ω, BNC, loop-through			
Monitor Output	2 channels, VBS1.0V(p-p), 75 Ω, BNC, 1 channel is dedicated to real-time image (Full-screen and 4-segment split screen display only. Nothing is displayed other than camera names and camera numbers.)			
Link Input	1 channel, VBS1.0V(p-p), 75 Ω, BNC, Connect the monitor output of other digital video recorder (C-DR091/161 series) to this terminal. Multiple digital video recorders can be operated and monitored with a single monitor by using the C-RM1000 Remote Controller (option).			
Audio Recording System	8 bits, Linear PCM, sampling frequency: 16 kHz			
Audio Input	1 channel, –10 dB*, 10 kΩ, unbalanced, RCA pin jack			
Audio Output	1 channel, –10 dB*, 600 Ω, unbalanced, RCA pin jack			
Screen Display	1-, 4-, 9-, 16-, segment screen sequence, electronic 2 x zoom			
Picture Quality	Changeable in 5 steps, (File size: 16 - 64KB) 64 KB (Quality 1), 40 KB (Quality 2), 32 KB (Quality 3), 24 KB (Quality 4), 16 KB (Quality 5)			
Pixels	720 x 240 pixels			
Recording Rate	Total recording rate 120 IPS (each camera can be individually set for the following rate) 120, 60, 30, 15, 8, 4, 2, 1, 1/2, 1/3, 1/5, 1/10, 1/20, 1/30, 1/60 IPS			
Pre-Recording	Max. 5 min (0 - 300 s)			
Post Alarm Recording	Max. 999 s (0 - 999 s), non-limit			
Date/Time	Year/ month/ date/ hour/ minute/ second, 24-hours format display, monthly deviation of within ±30 s (25°C (77°F)), can be operated until the year 2099			
Motion Detect	5 Sensitivity levels, can be turned on/off for individual areas			
Search Function	Date/Time search, Event search (Priority recording, Alarm-input recording, Normal recording, Motion detect recording, all)			
Alarm Input	16 channels (EDGE, LEVEL), no-voltage make contact input, open voltage: 2 V DC, short-circuit current: 1.5 mA, minimum short-circuit time: over 100 ms, loop resistance: under 100 Ω, screwless connector			
Control Output	4 channels (can be set for Priority recording, Alarm-input recording, Motion detect recording, Video loss, HD Full, Fan Failure, and HD Error) open collector output, withstand voltage: 30 V DC, control current : 20 mA, screwless connector			
Priority Recording Input	1 channel, no-voltage make contact input, open voltage: 2 V DC, short-circuit current: 1.5 mA, minimum short-circuit time: over 100 ms, loop resistance: under 100 Ω, screwless connector			
Time Synchronization Input	1 channel, no-voltage make contact input, open voltage: 2 V DC, short-circuit current: 1.5 mA, minimum short-circuit time: over 100 ms, loop resistance: under 100 Ω, screwless connector			
Time Synchronization Output	1 channel, open collector output, withstand voltage: 30 V DC, control current: 20 mA, screwless connector			
Camera Control	1 channel, RS-485, screwless connector			
Remote Control	1 channels, RS-485, screwless connector or RJ11			
Disk Array	2 channels, e-SATA (and dedicated control signal), e-SATA connector and modular connector			
Communication Function	RS-232C : D-sub connector (9 pin, male), 10 BASE-T/100 BASE-TX ethernet : RJ45			
Other Function	mail transmission capability, USB terminals (ARCHIVE, KEY LOCK), Web function (Real-time image, play-back, remote, menu), Language choice (English/ French/ Japanese)			
Applicable DVD Medium	DVD-R			
Altitude	Under 3,000 m (9,843 ft) (relative to sea level)			
Operating Temperature	+5°C to +40°C (41°F to 104°F) (+5°C to +35°C (41°F to 95°F) when mounted on a rack)			
Operating Humidity	Under 80% RH (no condensation)			
Finish	Panel: Surface-treated steel plate, black, paint, 30% gloss Case: Pre-coated steel plate, black			
Dimensions	420 (W) x 93.9 (H) x 332.8 (D) mm (16.5 (W) x 3.7 (H) x 13.1 (D) inch)			
Weight	6.9 kg (15.2 lb)	6.9 kg (15.2 lb)	7.7 kg (17.0 lb)	7.7 kg (17.0 lb)
Accessory	Power supply cord (2 m (6.6 ft)) ... 1			
Option	Rack mounting bracket: MB-23B			

## Free Manuals Download Website

<http://myh66.com>

<http://usermanuals.us>

<http://www.somanuals.com>

<http://www.4manuals.cc>

<http://www.manual-lib.com>

<http://www.404manual.com>

<http://www.luxmanual.com>

<http://aubethermostatmanual.com>

Golf course search by state

<http://golfingnear.com>

Email search by domain

<http://emailbydomain.com>

Auto manuals search

<http://auto.somanuals.com>

TV manuals search

<http://tv.somanuals.com>