

READ AND SAVE THESE INSTRUCTIONS

WARNING: A risk of fire and electrical shock exists in all electrical appliances and may cause personal injury or death. Please follow all safety instructions.



Bread Box™ Plus Bread Maker

Use and Care Guide - Model TBR2

- FAST BAKE™ PROGRAM FOR FRESH BREAD IN UNDER 1 HOUR
- 41 BREAD PROGRAMS INCLUDING WHOLE WHEAT AND DOUGH
- HORIZONTAL NON-STICK LOAF PAN
- WAKE UP TO FRESH BREAD - 13 HOUR DELAY TIMER

TABLE OF CONTENTS

IMPORTANT SAFEGUARDS	3
BEFORE YOUR FIRST USE	4
■ POWER OUTAGE	4
BREAD MAKER INTRODUCTION	5
■ PARTS	5
■ CONTROL PANEL	6
■ FEATURES	7
■ PROGRAM SPECIFICATIONS CHART	8
HELPFUL HINTS FOR BREAD AND DOUGH	9
■ MEASURING	9
■ DOUGH BALL	9
■ INGREDIENTS	10
■ SUBSTITUTES	12
■ BREAD MIXES AND OTHER COOK BOOKS	12
■ HIGH ALTITUDE.	12
■ FREEZING BAKED BREAD	13
■ FREEZING DOUGH	13
PROGRAMMING	14
■ PROGRAMMING BREAD MAKER PROGRAMS	14
■ PROGRAMMING DELAY TIMER.	16
RECIPES	17
■ BREADS	18
■ FAST BAKE™ BREADS AND INSTRUCTIONS	27
■ DAY OLD BREAD RECIPES	30
■ CAKES AND BAKE	31
■ DOUGHS.	33
CLEANING AND STORING	49
BEFORE CALLING FOR SERVICE	50
■ QUESTIONS AND ANSWERS	50
■ CHECK LIST	51
■ SUGGESTIONS.	52
■ SERVICE INFORMATION	53
SPECIFICATIONS	53
RECIPE INDEX	54

IMPORTANT SAFEGUARDS

When using electrical appliances, basic safety precautions should always be followed to reduce the risk of fire, electric shock and injury to persons, including the following:

- **Read all instructions before using this appliance.**
- Do not immerse cord, plug, or appliance in water or other liquid (see instructions for cleaning).
- Do not touch hot surfaces. Always use oven mitts when handling the hot bread pan or bread.
- Close supervision is necessary when this appliance is used near children.
- This appliance is not for use by children. Keep out of reach of children.
- Unplug from outlet when not in use and before cleaning. Allow to cool before attaching or removing parts.
- Avoid touching moving parts. Do not remove the bread pan during operation. Stop pad must be pressed if bread pan is to be removed before completion.
- Do not operate the appliance with a damaged cord or plug, or after the appliance malfunctions, or has been dropped or damaged in any manner. Return appliance to the nearest authorized service facility for examination, repair, electrical or mechanical adjustment.
- Do not use outdoors or while standing in damp area.
- Do not let cord hang over edge of table or counter or touch hot surfaces.
- Do not place on or near a hot gas or electric burner or in a heated oven.
- To unplug, grip the plug and pull out from the wall outlet. Never pull on the cord.
- Do not unplug while unit is in operation.
- Do not use appliance except as indicated in these instructions.
- Use accessory attachments only if recommended by Toastmaster Inc.
- Do not clean with metal scouring pads. Pieces can break off the pad and touch electrical parts.
- Bread maker must be placed at least 4 inches (10.2 cm) from walls and edge of counter.
- Do not cover bread maker with anything which would prevent the steam from escaping. This may cause warpage, discoloration, malfunction or even fire.

SAVE THESE INSTRUCTIONS

CAUTION: A short power supply cord is provided to reduce the risk of personal injury resulting from becoming entangled in or tripping over a longer cord. Extension cords are available from local hardware stores and may be used if care is exercised in their use. If an extension cord is required, special care and caution is necessary. Also the cord must be: (1) marked with an electrical rating of 125 V, and at least 13 A., 1625 W., and (2) the cord must be arranged so that it will not drape over the countertop or tabletop where it can be pulled on by children or tripped over accidentally.

ELECTRIC POWER: If electric circuit is overloaded with other appliances, your bread maker may not operate properly. The bread maker should be operated on a separate electrical circuit from other operating appliances.

POLARIZED PLUG: This appliance has a polarized plug (one blade is wider than the other). As a safety feature to reduce the risk of electrical shock, this plug is intended to fit in a polarized outlet only one way. If the plug does not fit fully in the outlet, reverse the plug. If it still does not fit, contact a qualified electrician. Do not attempt to defeat this safety feature.

BEFORE YOUR FIRST USE

Please fill out information that follows warranty.

Unpack and clean bread maker; see CLEANING AND STORING.

Place bread maker on a dry, stable surface away from burners and away from areas where cooking grease or water may splatter onto it. Avoid placing it where it may tip over during use. Place on back of counter top.

The bread maker will bake up to a 2 pound loaf of bread. Do not put a larger quantity of ingredients into the bread pan than recommended. If you do so, the bread may not mix or bake correctly and the bread maker may be damaged. The maximum amount of ingredients to be used is as follows.

Bread programs — approximately 4 cups

Dough program — 4 2/3 cups

During first use, this product may smoke and/or emit an odor from mineral oils used in manufacturing. This is normal for a newly manufactured appliance. Before first use, operate empty on the fast bake program to burn off the manufacturing oils.

■ POWER OUTAGE

Your Bread Box™ bread maker has a 7-minute power interrupt feature. If the electricity goes off, the memory will store the course in process for up to 7 minutes. If the power comes back on within this time, the course will resume where it left off. If the bread maker loses power for more than this time and you are using any dairy products, perishables or meat in your bread, you should discard the contents of the recipe and start again with new fresh ingredients due to health and sanitary considerations.

For non-perishable recipes you may try starting the bread maker at the beginning of the course again for all courses except fast bake. This may not always produce an acceptable loaf. If you are not sure when the outage occurred, remove the dough ball from the bread pan and place in an oven-safe baking container. Allow to double in size and place in a preheated 350°F/177°C oven for 30-45 minutes or until done. The bread will sound hollow when tapped on top of the loaf if it is done.

If you are using the fast bake course or if the bread has already begun to bake when the outage occurs, you must begin with new ingredients.

The power interrupt will not cover power surges. If you experience frequent power surges, use a surge protector.

BREAD MAKER INTRODUCTION

■ PARTS

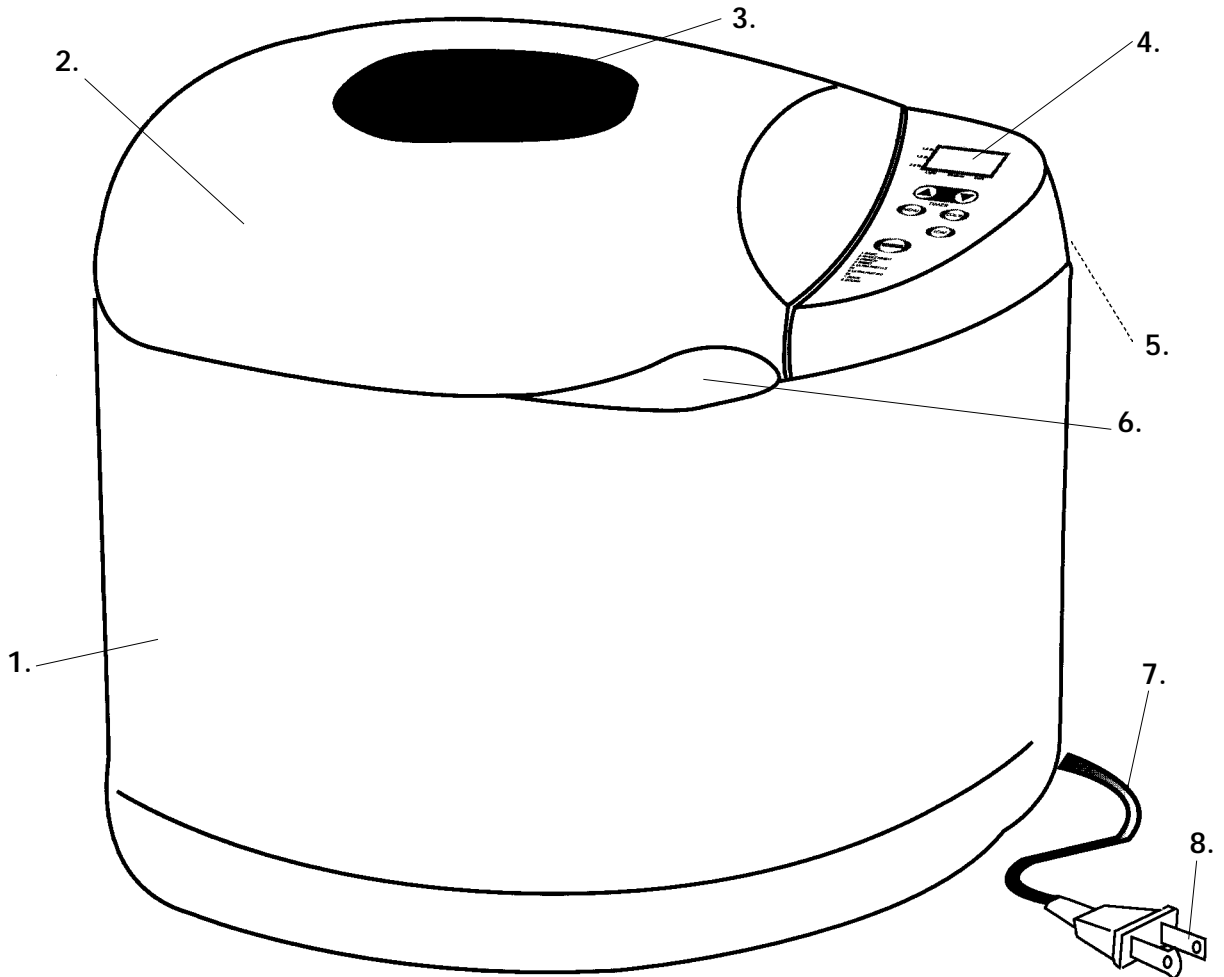

- 1.) Baking Chamber (not shown)
- 2.) Lid
- 3.) Viewing Window
- 4.) Control Panel
- 5.) Air Exhaust (not shown)
- 6.) Handle
- 7.) Power Cord
- 8.) Power Plug
- 9.) Kneading Blade
- 10.) Bread Pan Handle
- 11.) Bread Pan
- 12.) Slice (Dial, Kneading Blade)

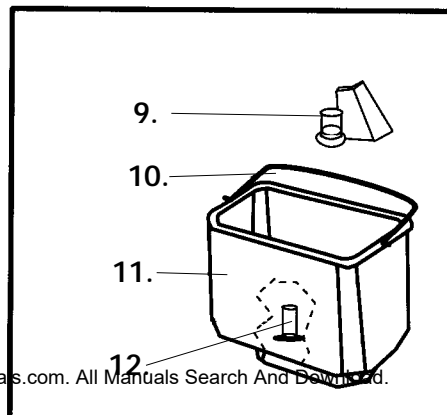

■ CONTROL PANEL

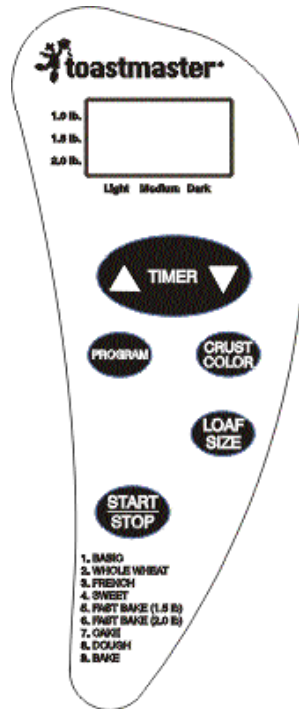

NOTE: When using the touchpad controls, be sure to press the pad until you hear a beep.

NOTE: When a bread maker is packaged for shipment, a clear plastic film is placed over the control panel; carefully peel it off.

<p>DISPLAY WINDOW</p>	<ul style="list-style-type: none"> • Indicates the Program number selected. • Indicates the LOAF SIZE selected. The indicator arrow is on the left side. • Indicates the CRUST COLOR selected. • Indicates minute-by-minute baking time countdown. • Indicates delay, baking time selected.
<p>TIMER</p>	<ul style="list-style-type: none"> • Use when setting the TIMER to delay baking. • Press ▲ and ▼ arrows to set timer for delayed completion up to 13 hours later. • Arrows will move time up or down in 10-minute increments. Press and hold button for faster movement. TIMER is not available on some cycles, please check the Total Time in the PROGRAM SPECIFICATION CHART.
<p>PROGRAM</p>	<ul style="list-style-type: none"> • Press to select the baking cycle of your choice. The selected cycle automatically assigns the time needed to complete the process.
<p>CRUST COLOR</p>	<ul style="list-style-type: none"> • Press to select the CRUST COLOR. • Light "L", Medium "P", Dark "H".
<p>LOAF SIZE</p>	<ul style="list-style-type: none"> • Press to select the LOAF SIZE. 1.0 lb., 1.5 lb., 2.0 lb.
<p>START/STOP</p>	<ul style="list-style-type: none"> • Press to start operation or begin TIMER countdown for delayed completion. • Press and hold until you hear a beep to stop operation or to cancel a

■ FEATURES

PROGRAM SELECT

The control panel will let you choose different programs, crust color and loaf size for some programs.

All programs except CAKE and BAKE contain a beep to check the dough ball, to add additional ingredients (i.e., raisins, nuts, and spices) or to stir ingredients.

BASIC Use these programs for basic bread recipes and most prepackaged bread mixes. You may choose light, medium or dark crust color.



WHOLE WHEAT If a recipe contains more than 50% whole wheat flour or when instructed in the recipe, use this program.



FRENCH This program is best suited for breads low in fat and sugar, which results in a crisp crust and coarse, chewy interior.



SWEET This program works best if a recipe is high in fat, sugar, eggs or cheese.



FAST BAKE™ 1.5 lb. Make a 1.5 lb. loaf of bread in less than one hour by using this program. Simply use the special instructions and recipes found in the fast bake bread sections of this recipe book.



FAST BAKE™ 2.0 lb. Make a 2.0 lb. loaf of bread in less than one hour by using this program. Simply use the special instructions and recipes found in the fast bake bread sections of this recipe book.



CAKE This program is used for recipes that contain baking powder or baking soda rather than yeast to make bread or cake rise. Cake recipes must be specially designed for this setting.



DOUGH This program is used to prepare dough for making bread or rolls which are shaped before baking in a conventional oven.



BAKE This program is used for baking breads or cakes for longer times.



PROGRAM SPECIFICATIONS CHART (approximate times)

Program	Process	Loaf Size lb.	Total Time	Delay Timer	Rest Min.	1st Knead Min.	1st Rise Min.	Display time for beep**	2nd Knead Min.	2nd Rise Min.	Rest Sec.	Final Rise Min.	Bake Min.	Keep Warm Min.
BASIC		1.0	2:50	13:00		10	20	2:15	15	20	30	55	50	60
		1.5	3:00	13:00		10	20	2:25	15	20	30	55	60	60
		2.0	3:10	13:00		10	20	2:35	15	20	30	55	70	60
WHOLE WHEAT		1.0	4:00	13:00	30	10	25	2:50	20	30	30	70	55	60
		1.5	4:10	13:00	30	10	25	3:00	20	30	30	70	65	60
		2.0	4:20	13:00	30	10	25	3:10	20	30	30	70	75	60
FRENCH		1.0	3:40	13:00		18	40	2:37	22	20	30	60	60	60
		1.5	3:50	13:00		18	40	2:47	22	20	30	60	70	60
		2.0	4:00	13:00		18	40	2:57	22	20	30	60	80	60
SWEET		1.0	2:40	13:00		10	5	2:20	20	30	30	55	40	60
		1.5	2:50	13:00		10	5	2:30	20	30	30	55	50	60
		2.0	3:00	13:00		10	5	2:40	20	30	30	55	60	60
FAST BAKE		1.5	:58	N/A		13		:57		10			35	60
FAST BAKE		2.0	:58	N/A		9		:57		9			40	60
CAKE		1.5	1:43	N/A		3	5	N/A	5				90	60
		2.0	1:43	N/A		3	5	N/A	5				90	60
DOUGH		1.5	1:30	13:00		5	5	1:12	20			60		
		2.0	1:30	13:00		5	5	1:12	20			60		
BAKE			:60	N/A									60	60

**Display time for beep tells you when to add additional ingredients, i.e. raisins or nuts, during all programs except CAKE and BAKE. Use this time to check dough ball and scrape ingredients from sides of pan.

The beeper sounds when baking is complete. If you want to serve bread that has just been baked, press STOP pad and remove. You may remove the bread or leave it in the bread maker. If left, it will automatically be kept warm for up to 1 hour during the keep warm process on all bake cycles except fast bake. The display window will show 0:00, and the colon will flash. At the end of keep warm, the display window will indicate last program selected.

HELPFUL HINTS FOR BREAD AND DOUGH

We recommend that you read the following information before you shop for your ingredients. Your bread maker will bake up to a 2 pound loaf of fresh bread containing approximately 4 cups of flour. All ingredients except liquids must be at room temperature and liquids should be approximately 80°F/27°C (baby bottle temperature). When preparing bread for the Fast Bake program, all liquid temperatures must be 110°-115°F/43°-46°C. Always place the ingredients in the bread pan in the order listed in the recipe: liquids, dry ingredients and then yeast. Some ingredient amounts are the same for different size loaves.

■ MEASURING: THE CORRECT WAY

Be sure to measure accurately for success. Mis-measuring, even slightly, can make a big difference in your results.

When you are measuring liquids, use a clear glass or plastic liquid measuring cup. To ensure accuracy, set the measuring cup on the counter top and read the measurement at eye level.

To measure your flour, spoon it lightly into a standard dry ingredient measuring cup and level it with a straight edge. Also, do not shake the cup or tap it on the counter top. Do not scoop the flour with the measuring cup as this tends to pack more flour than the recipes call for.

Use standard measuring spoons and level with a straight edge.

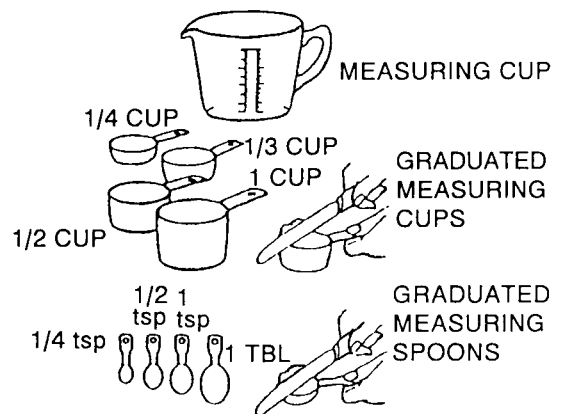

Measurement/Conversion Chart

1 1/2 tsp = 1/2 TBL	8 TBL = 1/2 cup
3 tsp = 1 TBL	12 TBL = 3/4 cup
1/2 TBL = 1 1/2 tsp	16 TBL = 1 cup
2 TBL = 1/8 cup	3/8 cup = 1/4 cup + 2 TBL
4 TBL = 1/4 cup	5/8 cup = 1/2 cup + 2 TBL
5 TBL + 1 tsp = 1/3 cup	7/8 cup = 3/4 cup + 2 TBL

■ DOUGH BALL: NECESSARY FOR A SUCCESSFUL LOAF OF BREAD

We have found that liquid amounts called for in a recipe may need to be adjusted slightly because different climates and seasons result in a wide variety of humidity levels. You should check the dough ball at the beep during the kneading process, see program specifications. At this point, the ball should be round, smooth-textured, soft and slightly tacky to the touch. When touched it will leave a little dough on your finger. Push down any dough or flour that may be on the sides of the pan. If it does not form a ball and is more like a batter, add 1 tablespoon of bread flour at a time until it reaches the appropriate consistency. On the other hand, if the mixture is too dry to form a

ball, forms more than one ball, or is a ball but not soft and slightly tacky, add 1 teaspoon of water and allow it to absorb. Add more water if necessary. Provided you have used all of the ingredients specified in the recipe, measured the ingredients properly, and have a "good" dough ball, you should achieve a successful load of bread.

When preparing bread in the Fast Bake program, the dough ball will be a very soft, loose ball with a smooth texture and will be sticky to the touch. When touched it will leave dough on your finger.

■ INGREDIENTS: READ BEFORE SHOPPING

Yeast: The Number One Ingredient

For all programs except Fast Bake we used RED STAR® Active Dry Yeast when we developed the bread recipes. However, RED STAR® QUICK RISE™ Yeast may also be used. We found that we did not have to vary the amount used when we substituted one for the other. When using bread machine yeast, follow the package instructions.

When developing the fast bake program, we found that Quick•Rise or Bread Machine must be used. They may be substituted in equal amounts. You will find that this program requires more yeast than other programs.

A 1/4 ounce package of RED STAR yeast contains approximately 2 1/4 level teaspoons of yeast. When the yeast is exposed to oxygen, moisture or warmth, the activity of it deteriorates. Therefore, we recommend storing yeast in an airtight container and refrigerating for up to 6 weeks or freezing it for up to 6 months. Measure out the amount you need and allow it to come to room temperature before using it — this takes about 15 minutes.

If you have any doubt regarding the activity of the yeast, you may use one of the following tests to determine its strength. Each test calls for a different amount of yeast as a base ingredient. This gives you more bread choices once the test is complete. The yeast mixture should not be used for the fast bake program.

To test for one package (2 1/4 teaspoons) of RED STAR Active Dry or QUICK•RISE Yeast, use a liquid measuring cup and fill to the 1/2 cup level with 110°-115°F/43°-46°C water. Stir in 1 teaspoon granulated sugar and 1 package (2 1/4 teaspoons) RED STAR Active Dry or QUICK•RISE Yeast. Leave your stirring spoon in the cup. Set a timer for 10 minutes. As the yeast absorbs liquid, it will begin to activate and rise to the surface. If at the end of the 10 minutes the yeast has multiplied to the 1 cup mark, it is very active. The yeast mixture may be used in your Toastmaster Bread Maker in a recipe that calls for 2 1/4 teaspoons of yeast. Remember to adjust your recipe for the 1/2 cup of water and 2 1/4 teaspoons of yeast used in the test. The sugar does not need to be adjusted. To test for 1 1/2 teaspoons of RED STAR Active Dry or QUICK•RISE Yeast, use a liquid measuring cup and fill to the 1/4 cup level with 110°-115°F/43°-46°C water. Stir in 1 teaspoon granulated sugar and 1 1/2 teaspoons RED STAR Active Dry or QUICK•RISE Yeast. Leave your stirring spoon in the cup. Set a timer for 10 minutes. As the yeast absorbs liquid, it will begin to activate and rise to the surface. If at the end of the 10 minutes the yeast has multiplied to the 1/2 cup mark, it is very active. The yeast mixture may be used in your Toastmaster Bread Maker in a recipe that calls for 1 1/2 teaspoons or more of yeast. Remember to adjust your recipe for the 1/4 cup of water and 1 1/2 teaspoons of yeast used in the test. The sugar does not need to be adjusted.

Flour: Bread Flour is Essential for Bread

All types of flour are affected by many factors, such as milling grades, moisture content, length of storage and manufacturing processes. Adjustments to the recipes may need to be made to compensate for climactic changes in different regions to ensure an excellent loaf.

Bread flour is a definite necessity. Milled from hard winter or spring wheat, it has a higher protein content that makes it more durable than all-purpose flour. The protein, when mixed with liquid, becomes gluten. When kneaded, gluten becomes elastic and gives the bread better structure. In contrast, all-purpose flour, milled from a combination of soft and hard wheat, becomes elastic too easily for use in a bread maker and quickly loses its ability to stretch well. As a result, bread made from all-purpose flour will be smaller and more dense. Several well-known mills now market bread flour. It is labeled bread flour on the package and is available at grocery stores.

Wheat is the only grain that contains the type of protein that becomes elastic when kneaded. Other flours, such as rye, barley, oats, soy, rice and buckwheat add flavor and fiber to breads but do not add structure to the dough. Therefore, wheat flour is essential as a base when making bread.

Vital Wheat Gluten is produced by processing white flour one more step. White flour contains both protein and starch, and mills now can remove most of the starch leaving only the protein (gluten). When gluten is added to recipes containing whole grain flours, it improves the volume and shape of the loaf significantly. Many grocery stores stock gluten in the flour section. Health food and nutrition centers also carry this item.

Flour is best kept in an airtight container. If you are storing the flour for a long period of time, you may want to keep it in the freezer as the refrigerator tends to dry it out. Whole grain wheat flours, which have a higher oil content, will become rancid much more quickly than white flour and should always be kept in the freezer. Be sure, however, to allow all flours to return to room temperature before placing in the bread maker.

Fat: Dough Enhancer and Conditioner

Our recipes were developed using vegetable oil. You may use any type of oil or substitute in equal proportions solid shortening or real butter (divide them into small pieces). We have found no noticeable difference in flavor but the crust may be more crisp with real butter. We do not recommend the use of margarine as it tends to make the crust tough.

Liquids: Activate the Yeast and Bind the Dough

When we use the term liquid, we are referring to all wet ingredients used in the recipe. For all programs except fast bake, it is very important that the liquid temperature is 80°F/27°C. With this water temperature, the yeast activates gradually to accommodate these programs.

When preparing bread using the fast bake program, all liquid temperatures must be 110°-115°F/43°-46°C. The warmer temperature is necessary for the yeast to activate quickly to accommodate this specially designed program.

Eggs are also considered part of the total liquid amount. Eggs should be at room temperature. When removing them from the refrigerator, place whole uncracked eggs in a bowl of warm water for 15 minutes to bring to room temperature.

Cinnamon and Garlic: Not True Friends of Yeast

Previously, cinnamon and sugar were sprinkled on dough before it was rolled up jelly-roll fashion. Adding cinnamon and garlic to the dough in a bread maker, however, presents a problem. Cinnamon reacts with bread dough just as a meat tenderizer reacts with meat. It breaks down the structure. Although it smells wonderful as it is baking, the flavor is dissipated in the baking process. **DO NOT ADD MORE THAN LISTED IN THE RECIPE.** For more flavor, use cinnamon and garlic as spread for the bread rather than adding to the dough.

Fruits and Vegetables: Add Flavor and Nutrition

When adding fruits or vegetables to recipes, do not exceed the amount listed. These products, if used in excessive amounts, may inhibit the rising of the bread.

Salt: Regulates Yeast Activity

Salt is necessary to control the activity of yeast, causing it to work slowly and steadily. Without salt, yeast acts too rapidly. Salt also strengthens the structure of the dough. If too little or no salt is used, the bread will rise rapidly and then fall. The texture will also be more coarse and/or uneven.

Sugar: Food for Yeast

Sugar is the favorite food of yeast, but too much sugar will cause the yeast to over-react. The loaf of bread will be small and dense. Dried fruits also contribute sugar to the bread dough. We do not recommend adding any more than is specified in each recipe. In addition, we do not recommend the use of artificial sweeteners because the yeast cannot react with them.

■ SUBSTITUTES

In our test kitchen, we experimented with these ingredient substitutions. We do want to mention that your results may vary from ours. If you would like to try other substitutions, there are several helpful hint books available from retail stores to assist you. Of course, we cannot guarantee their results.

Eggs

Liquid egg substitutes may be used as directed on the carton.

Two egg whites may be substituted for one whole egg.

REMEMBER, all egg products must be at room temperature.

Milk

Coffee creamer, non-dairy creamer or dry buttermilk may be substituted for dry milk in equal proportions. Liquid milk 80°F/27°C may be substituted for water in equal proportions for all bread programs except fast bake. The dry milk may then be eliminated all together. The loaf will be slightly smaller.

Salt

Salt-free recipes are not successful. Dietetically sodium free (less than 5 mg sodium per serving) or low salt (less than 1/2 the sodium of table salt) may be used in equal amounts. The bread will be more coarse.

Sugar

Honey may be substituted for sugar in equal proportions; reduce the liquid by the same amount. Brown sugar may be substituted for white sugar in equal proportions. Yeast needs sugar — no artificial sweetener should be used.

Wheat Flour

For gluten-free bread recipes refer to gluten-free bread section.

Yeast

We used RED STAR Yeast to develop our recipes. However, any brand may be used.

Refer to yeast ingredient section for other yeast substitutes.

■ BREAD MIXES AND OTHER COOK BOOKS

Use mixes labeled for up to 2 pound loaves. For best results, use the basic program. Even though we offer a wide variety of recipes for bread and dough, you may be looking for one that we have not included in our recipe book. Bread maker helpful hints and recipe books are available at book and retail stores. They offer a wide variety of recipes. Refer to the features section of this book for the best bread program to use for other recipes. Minor adjustments may be necessary for best results.

■ HIGH ALTITUDE

High elevations may make dough rise faster. We recommend that you try the recipe as it is printed first. The dough ball should be round, smooth-textured, soft and slightly tacky to the touch. If you find the results are unsuccessful, decrease your yeast 1/4 teaspoon at a time. You may also have to increase the liquid because of the drier air; start with 1 tablespoon and increase it if necessary. The addition of gluten will help the structure of the bread. The recommended amount is 1 teaspoon per cup of flour unless specified otherwise in the recipe.

■ FREEZING BAKED BREAD

When freezing bread and rolls, cool them before wrapping in plastic wrap. Place them in a plastic bag and seal it. Bread may be frozen for up to six weeks. When you thaw, partially open the wrapping to allow the moisture to escape gradually for best results.

■ FREEZING DOUGH

At the end of the dough program, you may remove the dough and freeze it for baking at a later time. Form the dough into the desired shape and immediately freeze for one hour to harden. Remove from the freezer and wrap in plastic wrap. Next, place it in a plastic bag and seal. Dough can be kept in the freezer for up to four weeks. Thaw the dough in plastic bag in the refrigerator overnight or for several hours. Unwrap and place on baking container. Cover and let stand in warm, draft free place until double the original size. Because the dough is not room temperature, you will find it takes longer than usual to rise. Bake according to recipe instructions.

If additional assistance is needed, expert help is available from Toastmaster[®] (1-800-947-3744) or from RED STAR[®] YEAST & PRODUCTS (1-800-445-4746).

PROGRAMMING

■ PROGRAMMING BREAD MAKER PROGRAMS

The following are the general steps for using the bread maker. Depending on the program or recipe that you choose, some steps may not apply or there may be additional steps. Refer to the Breads, Fast Bake Breads, Cakes and Doughs sections.

Add all ingredients to the pan in the order listed in the recipe.

The illustrations in this use and care guide are for information purposes only. You may find your bread maker looks different, however, the steps for operation are the same.

- 1 Open the lid and remove the bread pan by pulling straight up, using the handle.

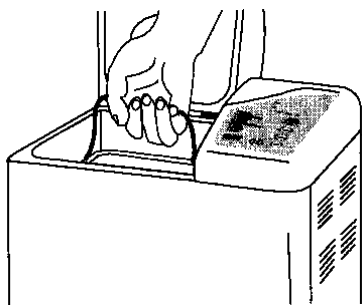

- 2 Mount the kneading blade on the shaft, flat side down.

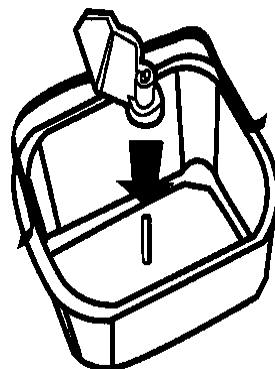

- 3 Place all ingredients, except yeast, in bread pan in the order listed. Use a rubber spatula to smooth the dry ingredients in the bread pan; be sure to spread into all corners. Lightly tap the pan 3 times on the counter top to settle the ingredients. Add yeast on top.



- 4 Insert bread pan and push down on rim until it snaps securely into place. Fold handle down.

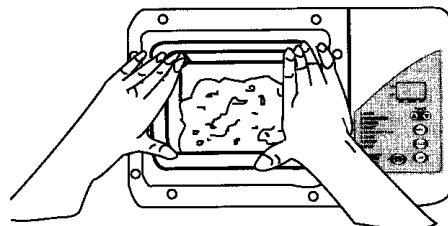

If the pan does not snap securely into place, remove bread pan. Wearing oven mitts, place fingers behind bread pan clips and gently pull away from oven wall. Insert bread pan again.

5 Close the lid. Plug into 120 V ~ 60 Hz outlet. The bread maker display indicator will default to 1P and then 3:00.

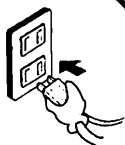

6 Press the PROGRAM button to choose the desired program. Each time the PROGRAM button is pressed, you will hear a beep and the number in the display window will advance to the next program.

Press the CRUST COLOR button to choose crust color desired. When you press the button, you will hear a beep and the display window will show the color selected.

- L = Light color
- P = Medium color
- H = Dark color

Press the LOAF SIZE button to choose the desired loaf size. When you press the button, you will hear a beep and the display window will show the size of the loaf selected.

8 The beeper will sound when the bread is done. Press the START/STOP button and hold it until you hear a beep. Remove the bread pan using oven mitts. If you do not stop the unit and remove the bread, it will automatically go into the keep warm process on all programs except for Dough. Your bread will be kept warm for 1 hour. The bread machine will beep every 5 minutes. You may remove the bread pan at any time during the keep warm cycle. To turn off the keep warm feature before the 1 hour is up, press the START/STOP button and hold it until you hear a beep.

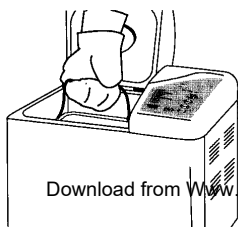

7 Press the START/STOP button. The time left for the program to be finished is displayed. The timer will count down in one minute increments. All programs except CAKE and BAKE will beep to add additional ingredients during the second knead. Opening the lid will not stop the kneading. Add ingredients quickly and evenly over dough. Quickly close the lid to prevent heat loss. At this time also check the dough ball and use a rubber spatula to scrape ingredients from the sides of the pan.



9 Turn the bread pan upside down and shake to release the bread.

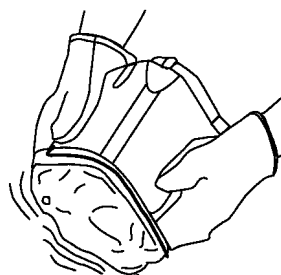

Place the bread upright on a wire rack to cool 20-30 minutes before cutting. This allows the steam to escape. Be sure to remove the kneading blade from the bread.

CAUTION:

- The bread pan, kneading blade and bread will be very hot.
- Always unplug after use



■ PROGRAMMING DELAY TIMER

The delay timer can be set to delay bread making up to 13 hours. At the selected time, delicious bread will be ready. The delay works for all programs except FAST BAKE, CAKE and BAKE.

Add all ingredients to the bread pan in the order listed. It is critical to add the yeast last on top of the flour, and away from liquid. This will keep the yeast from activating until the bread maker starts to mix.

Select the PROGRAM, CRUST COLOR and LOAF SIZE. Before pressing START, set the TIMER for the amount of time you want to wait before the bread is done.

EXAMPLE: It is 9:00 p.m. now. The bread is to be ready at 6:30 a.m. the next morning. Set the timer for 9:30, because there are 9 hours and 30 minutes between 9:00 p.m. and 6:30 a.m.

	<ol style="list-style-type: none"> 1. When pressed, the time will advance in 10 minute increments. 2. When constant pressure is applied to the pad, the time will advance quickly. Once you count up to 13:00 hours, the timer starts over again at 4:00 hours. 	<p>NOTE: The bread maker will start when the timer has counted down to the start time for the program selected to begin.</p>
	<ol style="list-style-type: none"> 3. Press the Start pad. The time is set, and the colon blinks. After one minute, 9:29 is displayed, and the timer continues to count down in 1 minute increments. 	

RECIPES

BREAD . . . AS EASY AS 1 - 2 - 3

1. Add ingredients to the bread pan in the order listed. Refer to the Helpful Hints for Bread and Dough for measuring information. Place the bread pan in the bread maker.
2. Close the lid. Select the bread program, choose the Loaf Size and press Start.
3. When finished baking, remove bread pan from the bread maker. Invert and shake to remove the loaf. Allow loaf to cool standing upright on a wire rack before slicing.

FOOD GUIDE PYRAMID

A Guide To Daily Food Choices

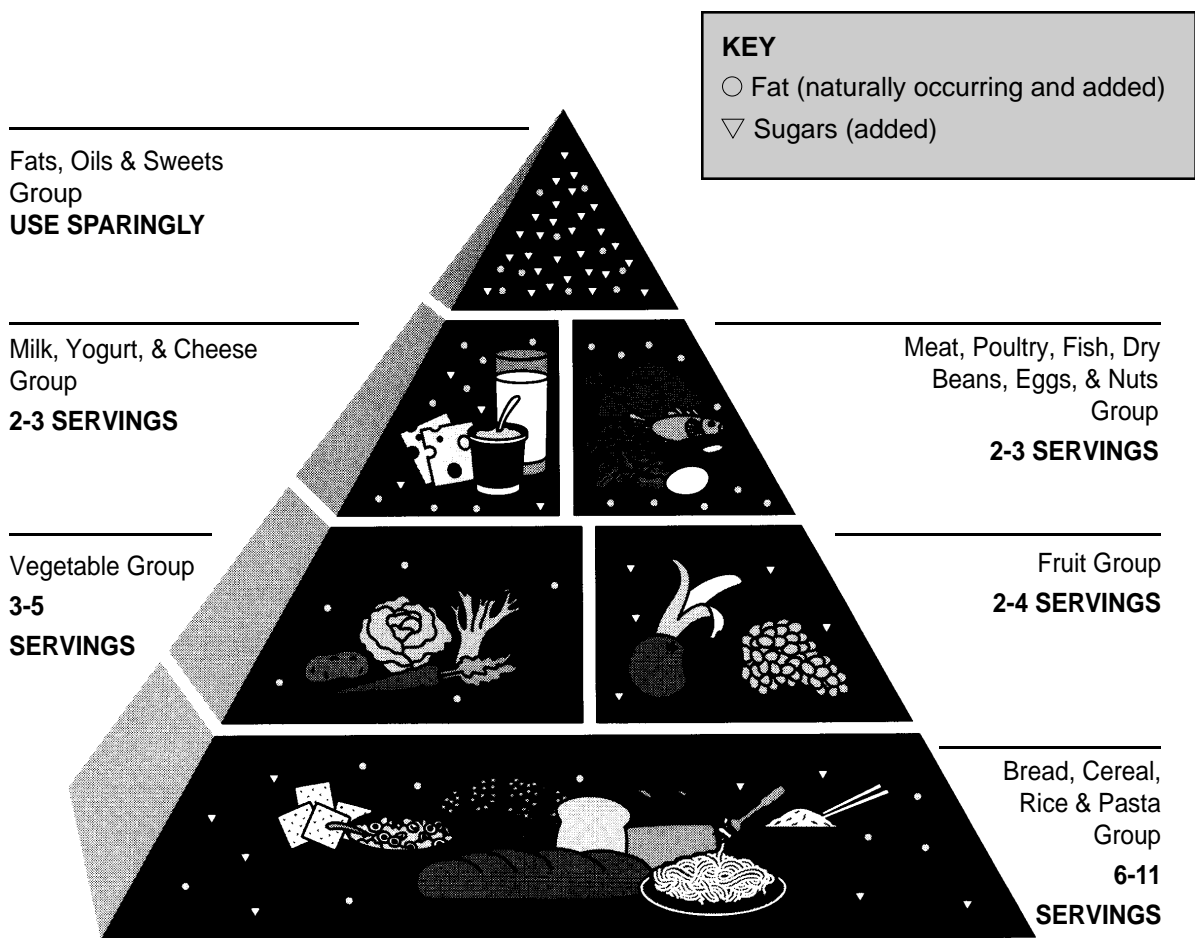

BREADS

We suggest starting your bread baking with this White Bread recipe. Follow each step carefully. These steps have been written to eliminate the most common errors in bread maker baking and may be helpful for any recipe.

WHITE BREAD

	1 lb. loaf	1.5 lb. loaf	2 lb. loaf
Water 80°F/27°C	3/4 cup	1 cup	1 1/4 cups
Oil	4 tsp	2 TBL	3 TBL
Sugar	4 tsp	2 TBL	3 TBL
Salt	1 tsp	1 1/2 tsp	2 tsp
Bread Flour	2 1/4 cups	3 cups	4 cups
RED STAR® Active Dry Yeast	1 1/2 tsp	2 1/4 tsp	1 TBL
or RED STAR® QUICK RISE™ Yeast	1 tsp	1 1/2 tsp	2 tsp
or Bread Machine Yeast	1 tsp	1 1/2 tsp	2 tsp
Program: BASIC			

1. Remove the bread pan from the bread maker. Attach the kneading blade onto the shaft. Make sure all ingredients, except water, are at room temperature.
2. Use a liquid measuring cup to measure the water (80°F/27°C/baby bottle temperature) and pour into the bread pan.
3. Use a measuring spoon to measure the oil and add to the bread pan.
4. Use a measuring spoon to measure the sugar and salt; level off with the straight edge of a knife and add to the bread pan.
5. Lightly spoon bread flour into a dry measuring cup; level off with the straight edge of a knife and add to the bread pan. Smooth into all corners. Lightly tap pan on counter 3 times to settle all dry ingredients.
6. Carefully measure yeast with a measuring spoon; level off with the straight edge of a knife and add to the bread pan. If using delay timer, make sure yeast is on top of bread flour, away from liquids.
7. Place the bread pan into the bread maker. Push down on rim until it snaps into place. Close the lid.
8. Select PROGRAM, LOAF SIZE, CRUST COLOR and set TIMER to delay, or press START for immediate start.
9. At the beep during the kneading process, check the dough ball. It should be slightly tacky to the touch. Add more water or flour if necessary; see Dough Ball. At this time, push down any dough or flour that may be on the sides of the pan.
10. When the beeper sounds, the bread has finished baking and the keep warm cycle will start. The display window will show 0:00, and the colon will flash.
11. Press Stop and use oven mitts to carefully remove the bread pan at any time during the keep warm process.
CAUTION: THE OVEN CAVITY, BREAD PAN, KNEADING BLADE AND BREAD WILL BE VERY HOT. USE OVEN MITTS.
12. Turn bread pan upside down and shake several times to release the bread. Do not use metal utensils inside the bread pan or machine. Remove the kneading blade and allow loaf to cool standing upright on wire rack approximately 20 minutes before cutting.
13. If bread loaf does not easily release from pan, allow it to sit on a heat resistant surface 5 minutes, then remove. When the bread has completely cooled, approximately 1 hour, store in an air tight container.
14. UNPLUG UNIT BEFORE CLEANING. DO NOT IMMERSER THE BREAD PAN IN WATER, see CLEANING AND STORING.

EGG BREAD

	1 lb. loaf	1.5 lb. loaf	2 lb. loaf
Egg(s), room temperature plus	1	2	3
enough Water 80°F/27°C to equal	3/4 cup	1 cup	1 cup + 7 TBL
Oil	1 TBL	2 TBL	3 TBL
Sugar	1 TBL	2 TBL	3 TBL
Salt	1 tsp	1 1/2 tsp	2 tsp
Bread Flour	2 1/4 cups	3 cups	4 cups
RED STAR® Active Dry Yeast	1 1/2 tsp	2 1/4 tsp	1 TBL
or RED STAR® QUICK RISE™ Yeast	1 tsp	1 1/2 tsp	2 tsp
or Bread Machine Yeast	1 tsp	1 1/2 tsp	2 tsp
Program: BASIC			

HONEY OATS BREAD

	1 lb. loaf	1.5 lb. loaf	2 lb. loaf
Water 80°F/27°C	3/4 cup	1 cup	1 1/3 cups
Oil	4 tsp	2 TBL	3 TBL
Honey	2 TBL	3 TBL	1/4 cup
Salt	1/2 tsp	1 tsp	1 1/2 tsp
Oatmeal	1/3 cup	1/2 cup	2/3 cup
Oat Bran	3 TBL	1/4 cup	1/3 cup
Whole Wheat Flour	1 1/2 cups	2 cups	2 2/3 cups
RED STAR® Active Dry Yeast	1 1/2 tsp	2 1/4 tsp	1 TBL
or RED STAR® QUICK RISE™ Yeast	1 tsp	1 1/2 tsp	2 tsp
or Bread Machine Yeast	1 tsp	1 1/2 tsp	2 tsp
Program: BASIC			

RYE BREAD

	1 lb. loaf	1.5 lb. loaf	2 lb. loaf
Water 80°F/27°C	3/4 cup	1 cup	1 1/3 cups
Oil	4 tsp	2 TBL	3 TBL
Caraway Seeds	2 tsp	1 TBL	4 tsp
Brown Sugar	4 tsp	2 TBL	3 TBL
Salt	1 tsp	1 1/2 tsp	2 tsp
Bread Flour	1 1/2 cups	2 cups	2 1/2 cups
Medium Rye Flour	3/4 cup	1 cup	1 1/2 cups
RED STAR® Active Dry Yeast	1 1/2 tsp	2 1/4 tsp	1 TBL
or RED STAR® QUICK RISE™ Yeast	1 tsp	1 1/2 tsp	2 tsp
or Bread Machine Yeast	1 tsp	1 1/2 tsp	2 tsp
Program: BASIC			

ONION BREAD

	1 lb. loaf	1.5 lb. loaf	2 lb. loaf
Water 80°F/27°C	3/4 cup	1 cup	1 1/3 cups
Oil	4 tsp	2 TBL	3 TBL
Dry Onion Soup Mix	4 tsp	2 TBL	3 TBL
Sugar	2 tsp	1 TBL	4 tsp
Bread Flour	2 1/4 cups	3 cups	4 cups
RED STAR® Active Dry Yeast	1 1/2 tsp	2 1/4 tsp	1 TBL
or RED STAR® QUICK RISE™ Yeast	1 tsp	1 1/2 tsp	2 tsp
or Bread Machine Yeast	1 tsp	1 1/2 tsp	2 tsp
Program: BASIC			

PESTO BREAD

	1 lb. loaf	1.5 lb. loaf	2 lb. loaf
Water 80°F/27°C	2/3 cup	1 cup	1 1/3 cups
Pesto, room temperature	2 TBL	3 TBL	1/4 cup
Dry Milk	1 TBL	4 tsp	2 TBL
Sugar	1 TBL	4 tsp	2 TBL
Salt	1/2 tsp	3/4 tsp	1 tsp
Bread Flour	2 cups	3 cups	4 cups
RED STAR® Active Dry Yeast	1 1/2 tsp	2 1/4 tsp	1 TBL
or RED STAR® QUICK RISE™ Yeast	1 tsp	1 1/2 tsp	2 tsp
or Bread Machine Yeast	1 tsp	1 1/2 tsp	2 tsp
Program: BASIC			

CHEVRE-CRACKED PEPPER BREAD

	1 lb. loaf	1.5 lb. loaf	2 lb. loaf
Water 80°F/27°C	2/3 cup	3/4 cup + 2 TBL	1 cup + 2 TBL
Feta Cheese, room temperature	1 1/2 oz	2 1/4 oz	3 oz
Dry Milk	4 tsp	2 TBL	3 TBL
Salt	3/4 tsp	1 tsp	1 1/2 tsp
Sugar	1 TBL	2 TBL	3 TBL
Cracked Black Pepper	2 tsp	1 TBL	4 tsp
Bread Flour	2 1/4 cups	3 cups	4 cups
RED STAR® Active Dry Yeast	1 1/2 tsp	2 1/4 tsp	1 TBL
or RED STAR® QUICK RISE™ Yeast	1 tsp	1 1/2 tsp	2 tsp
or Bread Machine Yeast	1 tsp	1 1/2 tsp	2 tsp
Program: BASIC			

SHREDDED WHEAT BREAD

	1 lb. loaf	1.5 lb. loaf	2 lb. loaf
Water 80°F/27°C	3/4 cup + 1 TBL	1 cup + 1 TBL	1 1/3 cups
Oil	2 TBL	3 TBL	1/4 cup
Molasses	2 TBL	3 TBL	1/4 cup
Salt	1/2 tsp	1 tsp	1 1/2 tsp
Bread Flour	3/4 cup	1 cup	1 1/4 cups
Whole Wheat Flour	1 1/2 cups	2 cups	2 1/2 cups
Mini-Shredded Wheat	3/4 cup	1 cup	1 1/4 cup
RED STAR® Active Dry Yeast	2 1/4 tsp	1 TBL	4 tsp
or RED STAR® QUICK RISE™ Yeast	1 1/2 tsp	2 tsp	2 1/2 tsp
or Bread Machine Yeast	1 1/2 tsp	2 tsp	2 1/2 tsp
Program: WHOLE WHEAT			

100% WHOLE WHEAT BREAD

	1 lb. loaf	1.5 lb. loaf	2 lb. loaf
Water 80°F/27°C	3/4 cup	1 cup	1 1/3 cups
Oil	2 TBL	3 TBL	1/4 cup
Brown Sugar	2 TBL	3 TBL	1/4 cup
Salt	1 tsp	1 1/2 tsp	2 tsp
Whole Wheat Flour	2 1/4 cups	3 cups	4 cups
RED STAR® Active Dry Yeast	2 1/4 tsp	1 TBL	4 tsp
or RED STAR® QUICK RISE™ Yeast	1 1/2 tsp	2 1/4 tsp	1 TBL
or Bread Machine Yeast	1 1/2 tsp	2 1/4 tsp	1 TBL
Program: WHOLE WHEAT			

PUMPERNICKEL BREAD

	1 lb. loaf	1.5 lb. loaf	2 lb. loaf
Water 80°F/27°C	3/4 cup	1 cup	1 1/3 cups
Oil	1 TBL	4 tsp	2 TBL
Molasses	1 TBL	4 tsp	2 TBL
Sugar	1 TBL	4 tsp	2 TBL
Salt	1 tsp	1 1/2 tsp	2 tsp
Medium Rye Flour	1/4 cup	1/3 cup	1/2 cup
Whole Wheat Flour	3/4 cup	1 cup	1 1/3 cups
Bread Flour	1 1/3 cups	1 3/4 cups	2 1/3 cups
Unsweetened Cocoa	1 TBL	4 tsp	2 TBL
Instant Coffee	1 tsp	1 1/2 tsp	2 tsp
RED STAR® Active Dry Yeast	1 1/2 tsp	2 1/4 tsp	1 TBL
or RED STAR® QUICK RISE™ Yeast	1 tsp	1 1/2 tsp	2 tsp
or Bread Machine Yeast	1 tsp	1 1/2 tsp	2 tsp
Program: WHOLE WHEAT			

TRIPLE WHEAT BREAD

	1 lb. loaf	1.5 lb. loaf	2 lb. loaf
Water 80°F/27°C	1 cup	1 1/3 cups	1 3/4 cups
Oil	1 TBL	2 TBL	3 TBL
Dark Molasses	2 TBL	3 TBL	1/4 cup
Salt	3/4 tsp	1 tsp	1 1/2 tsp
Bread Flour	1 cup	1 1/2 cups	2 cups
Cracked Wheat	3 TBL	1/4 cup	1/3 cup
Wheat Bran	6 TBL	1/2 cup	2/3 cup
Wheat Germ	6 TBL	1/2 cup	2/3 cup
Whole Wheat Flour	1 cup	1 1/2 cups	2 cups
RED STAR® Active Dry Yeast	2 1/4 tsp	1 TBL	4 1/2 tsp
or RED STAR® QUICK RISE™ Yeast	1 1/2 tsp	2 1/4 tsp	1 TBL
or Bread Machine Yeast	1 1/2 tsp	2 1/4 tsp	1 TBL
Program: WHOLE WHEAT			

FRENCH BREAD

	1 lb. loaf	1.5 lb. loaf	2 lb. loaf
Water 80°F/27°C	1 cup	1 1/3 cups	1 2/3 cups
Sugar	2 tsp	2 1/4 tsp	2 1/2 tsp
Salt	1 tsp	1 1/4 tsp	1 1/2 tsp
Bread Flour	3 cups	4 cups	5 cups
RED STAR® Active Dry Yeast	2 1/4 tsp	2 1/4 tsp	1 TBL
or RED STAR® QUICK RISE™ Yeast	1 1/2 tsp	2 tsp	2 1/2 tsp
or Bread Machine Yeast	1 1/2 tsp	2 tsp	2 1/2 tsp
Program: FRENCH			

CRANBERRY WALNUT BREAD

	1 lb. loaf	1.5 lb. loaf	2 lb. loaf
Egg(s), room temperature plus	1	2	2
enough Milk 80°F/27°C to equal	3/4 cup	1 cup	1 1/4 cups
Butter, room temperature	3 TBL	1/4 cup	1/3 cup
Sugar	3 TBL	1/4 cup	1/3 cup
Salt	1 tsp	1 1/2 tsp	2 tsp
Lemon Peel	1/2 tsp	3/4 tsp	1 tsp
Bread Flour	2 1/4 cups	3 cups	4 cups
RED STAR® Active Dry Yeast	1 1/2 tsp	2 1/4 tsp	1 TBL
or RED STAR® QUICK RISE™ Yeast	1 tsp	1 1/2 tsp	2 tsp
or Bread Machine Yeast	1 tsp	1 1/2 tsp	2 tsp
Add at the beep			
Dried Cranberries OR Dried Cherries	1/4 cup	1/3 cup	1/2 cup
Walnuts, chopped	1/4 cup	1/3 cup	1/2 cup
Program: SWEET			

RICH SWEET BREAD

	1 lb. loaf	1.5 lb. loaf	2 lb. loaf
Egg(s), room temperature plus	1	2	2
enough Water 80°F/27°C to equal	3/4 cup	1 cup	1 1/4 cups + 1 TBL
Oil	4 tsp	2 TBL	3 TBL
Sugar	4 tsp	2 TBL	3 TBL
Salt	1 tsp	1 1/2 tsp	2 tsp
Bread Flour	2 1/4 cups	3 cups	4 cups
Raisins	1/3 cup	1/2 cup	2/3 cup
RED STAR® Active Dry Yeast	1 1/2 tsp	2 1/4 tsp	1 TBL
or RED STAR® QUICK RISE™ Yeast	1 tsp	1 1/2 tsp	2 tsp
or Bread Machine Yeast	1 tsp	1 1/2 tsp	2 tsp
Add at the beep			
Dried Cranberries OR Dried Cherries	1/4 cup	1/3 cup	1/2 cup
Walnuts, chopped	1/4 cup	1/3 cup	1/2 cup
Program: SWEET			

CINNAMON RAISIN NUT BREAD

	1 lb. loaf	1.5 lb. loaf	2 lb. loaf
Water 80°F/27°C	3/4 cup	1 cup	1 1/3 cups
Oil	4 tsp	2 TBL	3 TBL
Cinnamon	1/2 tsp	3/4 tsp	1 tsp
Dark Brown Sugar	2 tsp	1 TBL	4 tsp
Salt	1 tsp	1 1/2 tsp	2 tsp
Bread Flour	2 1/4 cups	3 cups	4 cups
Raisins*	1/3 cup	1/2 cup	2/3 cup
Nuts*	1/3 cup	1/2 cup	2/3 cup
RED STAR® Active Dry Yeast	1 1/2 tsp	2 1/4 tsp	1 TBL
or RED STAR® QUICK RISE™ Yeast	1 tsp	1 1/2 tsp	2 tsp
or Bread Machine Yeast	1 tsp	1 1/2 tsp	2 tsp
* Add raisins and nuts at the beep			
Program: SWEET			

HOLIDAY BREAD

	1 lb. loaf	1.5 lb. loaf	2 lb. loaf
Water 80°F/27°C	1/4 cup	1/2 cup	1/3 cup
Milk 80°F/27°C	1/2 cup	2/3 cup	1 cup
Oil	1 TBL	2 TBL	3 TBL
Salt	1 1/2 tsp	2 tsp	2 1/2 tsp
Sugar	3 TBL	1/4 cup	1/3 cup
Bread Flour	2 1/4 cups	3 1/3 cups	4 cups
Walnuts, chopped*	1/3 cup	1/2 cup	2/3 cup
Candied Fruit*	1/3 cup	1/2 cup	2/3 cup
RED STAR® Active Dry Yeast	1 1/2 tsp	2 1/4 tsp	1 TBL
or RED STAR® QUICK RISE™ Yeast	1 tsp	1 1/2 tsp	2 tsp
or Bread Machine Yeast	1 tsp	1 1/2 tsp	2 tsp
* Add at the beep			
Program: SWEET			

■ FAST BAKE BREADS . . . AS EASY AS 1 - 2 - 3

The Fast Bake program, with hotter rise and bake temperatures, is convenient for baking a hot fresh loaf of bread in under an hour. The longer bread programs, with lower rise and bake temperatures, will bake a taller more developed loaf of bread. And remember, you can always use the delay feature for the longer programs.

1. Add ingredients to the bread pan in the order listed. Refer to Helpful Hints for Bread and Dough for measuring information. Place the bread pan in the bread maker.
2. Close the lid. Select the Fast Bake program, CRUST COLOR and press START.
3. When finished baking, remove bread pan from the bread maker. Invert and shake to remove the loaf. Allow loaf to cool standing upright on a wire rack before slicing.

FAST BAKE PROGRAM HINTS

- Water temperatures must be 110°-115°F/43°-46°C.
- Larger amounts of Quick•Rise™, RapidRise™ or Bread Machine yeast must be used. They may be substituted in equal amounts.
- The dough ball for the fast bake program should be a very soft, sticky to the touch, loose ball with a smooth texture. Do not add extra flour.
- Check the dough ball at the beep, and if necessary, use a rubber spatula to push any flour or dough from the sides of the bread pan down into the dough ball.
- As a result of the increased temperatures during the rise and bake process, the loaf of bread produced from this program may have a dark crisp crust with a split on the top side of the loaf.



toastmaster® Fast Bake™ Bread Recipe

Hand Quick Start Hints Models TBR2

Fast Bake is convenient for baking a hot fresh loaf of bread in under an hour.

WHITE BREAD

	1.5 lb	2 lbs. pounds
Water (110°-115°F/43°-46°C)	1 cup + 2 TBL	1 ¼ cup + 2 TBL
Oil	2 TBL	3 TBL
Sugar	2 TBL	3 TBL
Salt	1 tsp	1 ½ tsp
Dry milk	1 ½ TBL	2 TBL
Bread flour	3 cups	4 cups
Red Star Quick-Rise™ Yeast	1 TBL	4 tsp
or Bread Machine Yeast	1 TBL	4 tsp

Place ingredients in bread pan in the order listed. Select Fast Bake and press start.

Fast Bake Bread Hints

- Water temperature must be 110°-115°F/43°-46°C. Use the enclosed yeast thermometer to check the water temperature.
- When developing Fast bake breads, we found that Quick-Rise™, Rapid Rise™ or Bread Machine Yeast must be used to accommodate this exclusive bread cycle. You will find Fast bake breads also require more yeast than the other recipes found in the recipe/cook book included with your bread maker.
- Check the dough ball at the beep or half-way through the second knead. The dough ball for Fast Bake breads should be a very soft, sticky to the touch, loose ball with a smooth texture. Do not add extra flour. If necessary, use a rubber spatula to push any flour or dough from the sides of the bread pan down into the dough ball.
- The increased temperature during the rise and bake process required for this bread cycle may cause the loaf of bread produced to have a dark crisp crust with a split on the top side of the loaf.

The use and care Guide and Cook/Recipe contains more Fast Bake recipes and important informations; please read it carefully.

FAST BAKE™ BREADS

We suggest starting your fast bake bread baking with this White Bread Recipe. Refer to Helpful Hints for Bread and Dough for measuring information. Follow each step carefully, noticing the water temperatures must be 110°-115°F/43°-46°C and that QUICK•RISE™, RapidRise or Bread Machine yeast must be used.

WHITE BREAD

	1.5 lb. loaf	2 lb. loaf
Water 110°-115°F/43°-46°C	1 cup + 2 TBL	1 1/4 cups + 2 TBL
Oil	2 TBL	3 TBL
Sugar	2 TBL	3 TBL
Salt	1 tsp	1 1/2 tsp
Bread Flour	3 cups	4 cups
RED STAR® QUICK RISE™ Yeast	1 TBL	4 tsp
or Bread Machine Yeast	1 TBL	4 tsp
Program: FAST BAKE		

Method

1. Remove the bread pan from the bread maker. Attach the kneading blade onto the shaft. Have all ingredients ready. Make sure all ingredients, except water, are at room temperature.
2. Use a liquid measuring cup to measure the water (110°-115°F/43°-46°C) and pour into the bread pan.
3. Use a measuring spoon to measure the oil and add to the bread pan.
4. Use a measuring spoon to measure the sugar and salt; level off with the straight edge of a knife and add to the bread pan.
5. Lightly spoon bread flour into a dry measuring cup; level off with the straight edge of a knife and add to the bread pan. Smooth into all corners. Lightly tap pan on counter 3 times to settle dry ingredients.
6. Carefully measure Quick•Rise yeast with a measuring spoon; level off with the straight edge of a knife and add to the bread pan.
7. Place the bread pan into the bread maker. Push down on rim until it snaps into place. Close the lid.
8. Select desired Fast Bake program, either 1.5 lb. or 2.0 lb. depending on the size of the recipe, CRUST COLOR and press START.
9. About five minutes into the kneading process, check the dough ball. It should be sticky to the touch. At this time, push down any dough or flour that may be on the sides of the pan.
10. When the beeper sounds the bread has finished baking.
11. Use oven mitts to carefully remove the bread pan.
CAUTION: THE OVEN CAVITY, BREAD PAN, KNEADING BLADE AND BREAD WILL BE VERY HOT. USE OVEN MITTS.
12. Turn bread pan upside down and shake several times to release the bread. Do not use metal utensils inside the bread pan or bread maker. Remove the kneading blade and allow loaf to cool standing upright on wire rack approximately 20 minutes before cutting.
13. When the bread has completely cooled, approximately 1 hour, store in an air tight container.
14. UNPLUG UNIT BEFORE CLEANING. DO NOT IMMERSE THE BREAD PAN IN WATER, see CLEANING AND STORING.

EGG BREAD

	1.5 lb. loaf	2 lb. loaf
Egg(s), room temperature plus	2	3
enough Water 110°-115°F/43°-46°C to equal	1 cup + 3 TBL	1 1/2 cups
Oil	2 TBL	3 TBL
Sugar	2 TBL	3 TBL
Salt	1 tsp	1 1/2 tsp
Bread Flour	3 cups	4 cups
RED STAR® QUICK RISE™ Yeast	1 TBL	4 tsp
or Bread Machine Yeast	1 TBL	4 tsp
Program: FAST BAKE		

PESTO BREAD

	1.5 lb. loaf	2 lb. loaf
Water 110°-115°F/43°-46°C	1 cup + 2 TBL	1 1/2 cups
Pesto, room temperature	3 TBL	1/4 cup
Dry milk	4 tsp	6 tsp
Sugar	4 tsp	6 tsp
Salt	1/4 tsp	1/2 tsp
Bread Flour	3 cups	4 cups
RED STAR® QUICK RISE™ Yeast	1 TBL	4 tsp
or Bread Machine Yeast	1 TBL	4 tsp
Program: FAST BAKE		

CHEVRE-CRACKED PEPPER BREAD

	1.5 lb. loaf	2 lb. loaf
Water 110°-115°F/43°-46°C	1 cup	1 1/4 cups
Feta Cheese, room temperature	2 1/4 oz	3 oz
Dry Milk	2 TBL	3 TBL
Salt	1/2 tsp	1 tsp
Sugar	2 TBL	3 TBL
Cracked Black Pepper	1 TBL	4 tsp
Bread Flour	3 cups	4 cups
RED STAR® QUICK RISE™ Yeast	1 TBL	4 tsp
or Bread Machine Yeast	1 TBL	4 tsp
Program: FAST BAKE		

■ DAY OLD BREAD RECIPES

BREADED PINEAPPLE

Chunked Pineapple	1 15-oz can
Cornstarch	2 TBL
Sugar	1/2 cup
Butter	1/4 cup
White Bread, 1 inch cubes	2 cups

Drain pineapple, reserve juice. Add enough water to juice to equal 1 cup. Mix cornstarch and sugar, add juice and butter and heat until thick. Pour over pineapple and bread, toss lightly to mix. Bake at 350°F/177°C for 30 minutes.

BREAD PUDDING

White Bread, 1 inch cubes	1 1/2 cups
Vanilla Cook & Serve Pudding & Pie Filling	1 3-oz box
Cinnamon	1 tsp
Milk, liquid	2 cups

Mix all ingredients in a microwave-safe one quart casserole. Cook uncovered in microwave on high for 7 minutes or until boiling — stir occasionally during the last half of cooking. Or, bake in oven at 350°F/177°C for 30 minutes — stir halfway through cooking time. Serve warm or cold.

CRUNCHY BREAD SNACKS

Bread, sliced 1/2 inch thick	8 slices
Butter, melted	1/4 cup
Dry Seasoning Mix*	4 tsp

*Use any **one** of the following: dried spaghetti sauce seasoning, any ranch dressing, Italian herb seasoning, garlic powder or garlic salt. Amounts may be adjusted to your taste.

Melt butter and add seasoning. Place bread on baking container and lightly brush with butter mixture. Bake at 350°F/177°C for 10-15 minutes or until brown. Allow to cool. Break into bite size pieces.

■ CAKES AND BAKE

Cakes are made with baking powder and baking soda that are activated by moisture and heat. The batter is mixed only long enough to blend all the ingredients, then baked immediately.

It is suggested that all liquids (water, milk, eggs, oil, butter) be placed in the bottom of the bread pan, dry ingredients on top. After loading the bread pan in the machine, select the CAKE cycle.

During the initial mixing of batter, dry ingredients may collect in the corners of the pan. It may be necessary to help the machine mix by using a rubber spatula along corners to avoid flour clumps.

When the cycle is complete, the machine will beep. Before removing pan from bread machine, test cake for doneness by inserting a toothpick or cake tester into the top center. Remove the toothpick. If the cake is done, the toothpick will come out clean. However, if there is batter on the toothpick, set the machine on the BAKE setting to continue to bake additional time as needed. Check cake after 10 minute increments. Depending on size of cake and moistness of the batter, 10-30 additional minutes may be necessary.

Note that the complete BAKE cycle is 60 minutes and the machine will indicate 1:00.

When baking is complete, remove the pan from the machine and allow the cake to remain in the pan for 10 minutes to "set." Cakes are more fragile than yeast breads. They must set in the pan before unmolding to allow the steam to subside and the interior of the loaf to become more firm.

Remove the cake from the pan and cool on a rack before slicing.

APPLE WALNUT

	Regular	Large
Egg(s), room temperature	1	2
Milk 80°F/27°C	1 TBL	2 TBL
Oil	2 TBL	1/4 cup
Sugar	1/2 cup	1 cup
Granny Smith Apples, peeled and grated	1 cup	2 cups
Walnuts, chopped	1/2 cup	1 cup
All-Purpose Flour	1 1/2 cups	3 cups
Baking Soda	1/2 tsp	1 tsp
Baking Powder	1/4 tsp	1/2 tsp
Salt	1/4 tsp	1/2 tsp
Nutmeg	1/4 tsp	1/2 tsp
Cinnamon	1/4 tsp	1/2 tsp
Program: CAKE		

BANANA NUT

	Regular	Large
Milk 80°F/27°C	1/2 cup	1 cup
Oil	2 TBL	1/4 cup
Bananas, ripe and mashed	1 cup	2 cups
Eggs, room temperature	2	4
Sugar	1/4 cup	1/2 cup
Dark Brown Sugar, packed	1/4 cup	1/2 cup
Walnuts, chopped	1/2 cup	1 cup
All-Purpose Flour	1 1/2 cups	3 cups
Baking Soda	1 tsp	2 tsp
Salt	1 tsp	2 tsp
Program: CAKE		

IRISH SODA

	Large
Buttermilk 80°F/27°C	1 1/2 cups
Eggs, room temperature	2
Caraway Seeds	1 TBL
All-Purpose Flour	4 cups
Sugar	1/2 cup
Baking Soda	1 TBL
Salt	1/2 tsp
Raisins	1 cup
Program: CAKE	

CORN

	Large
Milk 80°F/27°C	1 cup
Eggs, room temperature	4
Oil	1/3 cup
Sugar	1/4 cup
Salt	1 tsp
All-Purpose Flour	2 2/3 cups
Cornmeal	1 cup
Baking Powder	5 tsp
Program: CAKE	

■ DOUGHS . . . AS EASY AS 1 - 2 - 3

1. Add ingredients to the bread pan in the order listed. Refer to Helpful Hints for Bread and Dough for measuring information. Place the bread pan in the bread maker.
2. Close the lid. Select DOUGH PROGRAM and LOAF SIZE. Press START.
3. Remove the dough from the bread pan when the beeper sounds. Follow shaping and baking instructions.
 - If you allow the dough to remain in the bread maker after the cycle is complete, it may over rise and damage the machine.
 - Rising times for dough after it is shaped and placed in a baking pan will vary due to recipe, temperature and humidity level of your kitchen. The optimum temperature of the room for rising is 80°-85°F/27°-29°C. Rising is the most essential feature in bread making. After the dough comes out of the bread maker, the dough ferments and rises before punching and resting. The gluten becomes pliable and elastic with a soft, smooth quality. Fermentation conditions gluten, develops flavor and leavens the product.

Dough has doubled in bulk when an indentation remains after the tip of a finger is pressed lightly and quickly into the dough. If the indentation springs back, cover and let rise a few more minutes and check again. After punching down and dividing dough, cover and let rest 10 minutes. Resting allows the gluten to relax and makes handling easier. Then shape the dough as desired.

Sometimes a double rising is beneficial especially for whole grain or 100% whole wheat bread. Let the dough rise once, punch down, let rise again, punch down, let rest 10 minutes and shape.

Crust Treatments (use only with dough program)

Always allow optimum rising of shaped dough. Use a pastry brush to apply glaze. Bake as directed.

Egg Yolk Glaze — For a shiny golden crust, mix 1 slightly beaten egg or egg yolk with 1 tablespoon water or milk.

Egg White Glaze — For a shiny, chewy crust, mix 1 slightly beaten egg white with 1 tablespoon water.

Lightly Flour ed

Sprinkle enough flour onto work area so that the dough can be handled without sticking.

Shaping Rolls

Cloverleaf Rolls — Shape into 1/2 inch balls. Place 3 balls in each greased muffin tin and let rise until double in size.

Crisscross Rolls — Shape into balls. Combine two of the balls and roll into a 1/8 inch thick square. Cut strips 1/8 inch wide and place one strip across the top of each ball. Repeat this process, placing the second strip in the opposite direction across the top of each ball.

Traditional Rolls — Shape into balls. For “pull apart” rolls, place dough balls with sides touching in a baking pan. For “individual” rolls place dough balls 2 inches apart on a baking sheet.

Pan Sizes For Pull-Apart Rolls —

For a 1 lb. (9 rolls) recipe, use an 8 x 8 inch baking pan.

For a 1.5 lb. (18 rolls) recipe, use two 8 x 8 inch baking pans.

For a 2 lb. (24 rolls) recipe, use a 9 x 13 inch baking pan.

DINNER ROLL DOUGH

	1 lb. - 9 rolls	2 lb. - 24 rolls
Egg, room temperature plus enough Water 80°F/27°C to equal	1	1
Oil	3/4 cup + 3 TBL	1 1/2 cups + 2 TBL
Sugar	2 TBL	1/4 cup
Salt	1/4 cup	1/2 cup
Bread Flour	1/4 tsp	1/2 tsp
Active Dry Yeast	2 1/4 cups	4 1/4 cups
	2 1/4 tsp	3 1/2 tsp
Program: DOUGH		

Method

1. Remove the bread pan from the bread maker. Attach the kneading blade onto the shaft. Make sure all ingredients, except water, are at room temperature.
2. Place whole uncracked eggs in a bowl of warm water for 15 minutes to bring to room temperature. To measure egg plus enough liquid to equal — after warming eggs, remove from shell and place in a liquid measuring cup. Slowly add warm (80°F/27°C/baby bottle temperature) liquid to measuring cup until it reaches the desired measurement.
3. Use a measuring spoon to measure the oil and add to the bread pan.
4. Use a measuring spoon to measure the sugar and salt; level off with the straight edge of a knife and add to the bread pan.
5. Lightly spoon bread flour into a dry measuring cup, level off with the straight edge of a knife and add to the bread pan.
6. Smooth into all corners. Lightly tap pan on counter 3 times to settle all dry ingredients.
7. Carefully measure yeast with a measuring spoon; level off with the straight edge of a knife and add to the bread pan.
8. Place the bread pan into the bread maker. Press down on rim until it snaps into place. Close lid.
9. Select DOUGH PROGRAM, LOAF SIZE and press START.
10. At the beep during the kneading process, check the dough ball. It should be slightly tacky to the touch. At this time push down any dough or flour that may be on the sides of the pan.
11. When the beeper sounds, the dough is finished. Use oven mitts to carefully remove the bread pan.

CAUTION: THE OVEN CAVITY, BREAD PAN, KNEADING BLADE AND BREAD WILL BE VERY HOT. USE OVEN MITTS.

12. Turn bread pan upside down and shake several times to remove the dough. Do not use metal utensils inside the bread pan or bread maker.
13. Place on a lightly floured surface. Divide into pieces and shape.
14. Place in a greased baking pan. Cover and let rise in a warm place for 1 hour or until double in size.
15. Bake at 350°F/177°C for 20-30 minutes, or until done.
16. UNPLUG UNIT BEFORE CLEANING. DO NOT IMMERSE THE BREAD PAN IN WATER, see CLEANING & STORING.

FOCACCIA BREAD DOUGH

1.5 lb. - 1 loaf	
Water 80°F/27°C	1 cup
Olive Oil	1/3 cup
Sugar	2 tsp
Salt	1 tsp
Bread Flour	3 cups
Active Dry Yeast	1 1/2 tsp
Program: DOUGH	
Add at the beep:	
Dried Italian Seasoning	1 tsp
Garlic-Cheese Topping	
Olive Oil	1/4 cup
Dried Oregano	1 1/2 tsp
Garlic, coarsely chopped	1/3 cup
Parmesan Cheese, grated	1/3 cup
Salt	1/4 tsp
Greek Style Topping	
Olive Oil	1/4 cup
Onion, thin sliced	1 cup
Dried Oregano	1 1/2 tsp
Feta Cheese, crumbled	1/3 cup
Black Olives, sliced and drained	1/4 cup
Salt	1/4 tsp

Method

1. With oiled hands, evenly press dough into a greased 9 x 13 inch pan. Using your fingertips, make indentations in the dough.
2. Cover and let rise in a warm place for 30 minutes or until almost double in size. While the dough is rising, select the topping and prepare.
3. In a skillet, heat olive oil.
 - For garlic-cheese topping — stir in oregano and garlic then immediately remove from heat.
 - For Greek topping — add onions and cook until onions are soft but not brown, approximately 5 minutes.
4. Use fingers to press dimples into dough again. Spoon topping mixture evenly over dough. Sprinkle with remaining ingredients.
5. Bake at 400°F/205°C for 20 minutes or until done.

WHEAT DINNER ROLL DOUGH

	1 lb. - 9 rolls	2 lb. - 24 rolls
Water 80°F/27°C	3/4 cup	1 1/2 cups
Oil	1 TBL	2 TBL
Brown Sugar	2 TBL	1/4 cup
Salt	1/2 tsp	1 tsp
Dry Milk	1 TBL	2 TBL
Bread Flour	1 1/4 cups	2 1/2 cups
Whole Wheat Flour	1 cup	2 cups
Active Dry Yeast	1 1/2 tsp	2 tsp
Program: DOUGH		

Method

1. Place on a lightly floured surface. Divide into pieces and shape.
2. Place in a greased baking pan. Cover and let rise in a warm place for 1 hour or until double in size.
3. Bake at 350°F/177°C for 25-30 minutes, or until done.

BUTTERMILK ROLL DOUGH

	1 lb. - 9 rolls	1.5 lb. - 18 rolls
Cultured Buttermilk, liquid 80°F/27°C	1 cup	1 1/2 cups
Oil	3 TBL	1/4 cup
Honey	1 1/2 TBL	2 TBL
Salt	1 tsp	1 1/2 tsp
Bread Flour	3/4 cup	1 1/4 cups
Whole Wheat Flour	1 1/3 cups	2 cups
Wheat Germ	1/3 cup	1/2 cup
Baking Soda	1/4 tsp	1/4 tsp
Active Dry Yeast	1 3/4 tsp	2 tsp
Program: DOUGH		
Topping		
Butter, melted	2 TBL	3 TBL

Method

1. Place on a lightly floured surface. Divide into pieces and shape.
2. Place in a greased baking pan. Cover and let rise in a warm place for 1 hour or until double in size. Brush with melted butter.
3. Bake at 350°F/177°C for 15-20 minutes, or until done.

FRENCH BREAD DOUGH

(Italian Loaf, French Rolls and French Twists)

	1 lb. - 9 rolls
Water 80°F/27°C	1 1/4 cups
Sugar	1 TBL
Salt	1 tsp
Bread Flour	3 1/2 cups
Active Dry Yeast	1 TBL
Program: DOUGH	
Glaze	
Water	2 TBL
Salt	1/2 tsp

Method

1. Place on a lightly floured surface. Roll into a 12 x 18 rectangle. Starting with the longest side, roll up tightly, pressing the seams to seal and tapering each end.
2. Place the loaf on a greased baking sheet, cover and let rise in a warm place for 40 minutes or until double in size.
3. With a knife, cut three diagonal slashes across top of the loaf. Combine the glaze ingredients; brush the loaf.
4. Bake at 400°F/205°C for 20 to 25 minutes, or until done.

Variations

ITALIAN LOAF

Method

1. Use recipe above. Place on a lightly floured surface and shape the dough into one large round ball.
2. Place the loaf on a greased baking sheet, cover and let rise in a warm place for 40 minutes or until double in size.
3. With a knife, cut three diagonal slashes across top of the loaf. Combine the glaze ingredients; brush over loaf. Sprinkle loaf with sesame seeds, poppy seeds, caraway seeds or cracked wheat.
4. Bake at 400°F/205°C for 20 to 25 minutes or until done.

FRENCH ROLLS

Method

1. Use recipe above. Place on a lightly floured surface and divide dough into 12 pieces. Pinch the ends of each roll and taper slightly.
2. Place the loaves on a greased baking sheet, cover and let rise in a warm place for 40 minutes or until double in size.
3. With a knife, cut diagonal slashes across top of the loaf. Combine the glaze ingredients and brush over loaves.
4. Bake at 400°F/205°C for 15 to 20 minutes or until done.

FRENCH TWISTS

Method

1. Use recipe above. Place on a lightly floured surface and divide into 18 pieces. Roll into 14 inch ropes.
2. Fold each rope in half and twist, starting at fold.
3. Place on greased baking sheet and brush with 1/3 cup of melted butter. Cover and let rise in a warm place until double in size.
4. Brush with glaze.
5. Bake at 400°F/205°C for 12 to 15 minutes or until done.

CHEEZY GARLIC ROLL DOUGH

	1 lb. - 9 rolls	2 lb. - 24 rolls
Egg, room temperature plus enough Water 80°F/27°C to equal	1	1
Oil	1 cup	1 1/3 cups
Sugar	2 TBL	3 TBL
Salt	1/3 cup	1/2 cup
Bread Flour	1 tsp	1 1/2 tsp
Active Dry Yeast	3 1/2 cups	4 1/2 cups
Program: DOUGH		
Topping		
Parmesan Cheese	1 1/4 tsp	2 tsp
Garlic, minced	3 TBL	1/4 cup
Butter, melted	1/3 cup	2/3 cup

Method

1. Place on a lightly floured surface. Divide into pieces and shape.
2. Combine cheese and garlic. Dip pieces in melted butter and then in cheese-garlic mixture. Place coated side up in a greased baking pan, drizzle any remaining topping over rolls.
3. Cover and let rise in a warm place 1 hour or until double in size.
4. Bake at 325°F/163°C for 35-40 minutes, or until done.

PITA POCKET DOUGH

	1 lb. - 20 pita pockets
Water 80°F/27°C	1 1/3 cups
Olive Oil	8 tsp
Sugar	4 tsp
Salt	1 1/4 tsp
Bread Flour	2 cups
Whole Wheat Flour	1 1/3 cups
Active Dry Yeast	2 1/2 tsp
Program: DOUGH	

Method

1. Place on a lightly floured surface. Divide into 10 pieces and shape each piece into a smooth ball.
2. Place 5 balls on a large baking sheet. Place the remaining five balls on another baking sheet. Let rise about 20 minutes. With fingertips flatten each ball into a 6 inch circle.
3. Bake at 500°F/260°C for 5 minutes until puffed and tops begin to brown.
4. Cut each half to form 2 pockets.

REFRESHING ROLL DOUGH

	1.5 lb. - 18 rolls	2 lb. - 24 rolls
Water 80°F/27°C	1 cup	1 1/2 cups
Oil	1/4 cup	1/3 cup
Brown Sugar	1/3 cup	1/2 cup
Salt	1 tsp	1 1/2 tsp
Bread Flour	3 1/2 cups	4 1/2 cups
Active Dry Yeast	1 1/2 tsp	2 tsp
Program: DOUGH		
Topping		
Orange Peel, grated	2 TBL	1/4 cup
Sugar	1/2 cup	3/4 cup
Butter, melted	1/2 cup	3/4 cup

Method

1. Place on a lightly floured surface. Divide into pieces and shape.
2. Combine orange peel and sugar. Dip pieces in melted butter and then in orange peel-sugar mixture.
3. Place coated side up in greased baking pan. Drizzle any remaining topping over rolls. Cover and let rise in a warm place 1 hour or until double in size.
4. Bake at 350°F/177°C for 20-30 minutes, or until done. Serve warm.

CHALLAH BREAD DOUGH

	1 lb. - regular	2 lb. - large
Egg(s), room temperature plus	1	2
enough Water 80°F/27°C to equal	3/4 cup	1 1/2 cups
Oil	2 TBL	1/4 cup
Sugar	1 1/2 TBL	2 TBL
Salt	1 tsp	2 tsp
Bread Flour	2 cups	4 1/2 cups
Active Dry Yeast	1 tsp	2 tsp
Program: DOUGH		
Glaze		
Egg Yolk(s), beaten	1	2
Water	1 TBL	1 TBL
Topping		
Poppy Seeds	1 tsp	1 1/2 TBL

Method

1. Place on a lightly floured surface. Divide into thirds, making 3 (10 inch long for regular, 13 inch long for large) ropes with tapered ends. Pinch ropes together at one end, braid together. Pinch together at other end and secure braid.
2. Transfer braided dough to greased baking sheet; cover and let rise in a warm place for 1 hour or until double in size.
3. Combine glaze ingredients and brush onto braid. Sprinkle with poppy seeds and bake at 350°F/177°C for 25 minutes, or until done.

WHOLE WHEAT PIZZA CRUST DOUGH

1 lb. 1 thick or 2 thin crusts	
Water 80°F/27°C	1 cup
Oil	2 TBL
Sugar	1 TBL
Salt	1 tsp
Whole Wheat Flour	1 cup
Bread Flour	1 1/2 cups
Active Dry Yeast	2 1/4 tsp
Program: DOUGH	

Method

1. Place on a lightly floured surface. Divide in half and press onto a 12 inch pizza pan, raising edges. Sprinkle each pan with 1 tablespoon of cornmeal if desired. Generously prick dough with a fork. For one 12 inch thick crust do not divide.
2. Bake 400°F/205°C for 10-12 minutes or until edges of crust begin to turn a light golden brown. Remove, add toppings and return to oven to bake an additional 15-20 minutes.

PIZZA CRUST DOUGH

	1 lb. 1 thick or 2 thin crusts	2 lb. 2 thick or 4 thin crusts
Water 80°F/27°C	3/4 cup	1 1/2 cups + 3 TBL
Oil	1 TBL	2 TBL
Sugar	1 TBL	2 TBL
Salt	1/2 tsp	1 tsp
Dry Milk	1 TBL	2 TBL
Bread Flour	2 1/4 cups	4 1/2 cups
Active Dry Yeast	1 tsp	2 tsp
Program: DOUGH		

Method

1. Place on a lightly floured surface. Divide and press onto a 12 inch pizza pan, raising edges.
2. Spread pizza sauce over the dough and sprinkle with toppings.
3. Bake 425°F/218°C for 20 minutes or until crust is golden brown around edges.

BAGEL DOUGH

1.5 lb. - 8 bagels	
Water 80°F/27°C	1 cup
Sugar	1 1/2 TBL
Salt	1 tsp
Bread Flour	3 cups
Active Dry Yeast	2 1/4 tsp
Program: DOUGH	
Glaze	
Egg, beaten	1
Toppings (optional)	
Sesame Seeds, Poppy Seeds, Cracked Wheat, Wheat Flakes or Dried Onion Flakes	

BANANA WHEAT BAGEL DOUGH

1.5 lb. - 12 bagels	
Egg, room temperature plus enough Water 80°F/27°C to equal	1 1 cup
Oil	2 TBL
Honey	1 TBL
Salt	1 1/2 tsp
Banana, mashed	1/2 cup
Whole Wheat Flour	2 1/2 cups
Bread Flour	1 cup
Active Dry Yeast	2 1/4 tsp
Program: DOUGH	
Glaze	
Egg White, beaten	1
Water	1 TBL
Toppings (optional)	
Poppy Seeds, Sesame Seeds	

Bagel Recipes Method

1. Place on a lightly floured surface. Divide into pieces. Roll each in a smooth ball, making a hole in the center of each with thumbs. Gently pull to make a one-inch hole.
2. Place on a greased baking sheet. Cover and let rise in a warm place for 30 minutes or until double in size.
3. In a 3-quart saucepan, bring to a boil 2 quarts water and 2 tablespoons sugar. Place a few bagels at a time in boiling water. Simmer 3 minutes turning once. Remove with slotted spoon and put back on greased baking sheet.
4. Brush with egg and sprinkle with choice of toppings. Bake at 400°F/205°C for 20-25 minutes or until done; cool on a wire rack.

ALMOND-CHERRY COFFEE CAKE DOUGH

1.5 lb. - 1 coffee cake

Water 80°F/27°C	1 cup
Oil	1 TBL
Sugar	1 1/2 TBL
Salt	3/4 tsp
Dry Milk	1 TBL
Bread Flour	3 1/4 cups
Active Dry Yeast	1 1/2 tsp

Program: DOUGH

Filling

Cream Cheese, room temperature	8 oz
Sugar	2 TBL
Maraschino Cherries, chopped	1/2 cup
Milk, liquid	1 TBL
Almond Extract	1/2 tsp

Glaze

Powdered Sugar	1/2 cup
Sour Cream	1 TBL
Milk, liquid	1-2 TBL
Sliced Almonds, to decorate	2 TBL
Maraschino Cherries, quartered, to decorate	2 TBL

Method

1. Place on a lightly floured surface. Roll into a 15 x 10 inch rectangle. Combine filling ingredients and spread over dough within 1/2 inch of edges. Starting with longest side, roll dough up tightly, pressing edges to seal.
2. Place roll, seam-side down, on a greased baking sheet and join the ends to form a ring; pinch to seal. With a knife, make cuts 1 1/2 inches apart from the outside edge to within one inch of the inside edge. Turn each section on its side so filling shows.
3. Cover and let rise in a warm place 1 hour or until almost double in size.
4. Uncover and bake at 375°F/190°C for 20-25 minutes or until done.
5. Combine the first three glaze ingredients, adding only enough milk for drizzling consistency. Drizzle over the warm coffee cake. Decorate with almonds and cherries. Serve warm.

CINNAMON ROLL DOUGH

	1.5 lb. - 18 rolls	2 lb. - 24 rolls
Egg, room temperature plus	1	1
enough water 80°F/27°C to equal	1 cup	1 1/2 cups
Oil	1/4 cup	1/3 cup
Sugar	1/3 cup	1/2 cup
Salt	1 tsp	1 1/2 tsp
Bread Flour	3 1/2 cups	4 1/2 cups
Active Dry Yeast	1 1/2 tsp	2 tsp
Program: DOUGH		
Add at the beep:		
Walnuts, chopped (optional)	1/2 cup	2/3 cup
Raisins (optional)	1/2 cup	2/3 cup
Filling		
Butter, softened	1/3 cup	1/2 cup
Sugar	1/3 cup	1/2 cup
Cinnamon	2 TBL	3 TBL
Glaze		
Powdered Sugar	1/2 cup	2/3 cup
Milk, liquid	3 TBL	1/4 cup
Vanilla	1/4 tsp	1/2 tsp

Method

1. Place on a lightly floured surface, roll dough into a 12 x 18 inch rectangle for 18 rolls, (12 x 24 inch rectangle for 24 rolls) and spread with butter. Combine remaining filling ingredients and sprinkle over butter. Roll up tightly, jelly-roll style, starting with the longest side and cut into one inch slices.
2. Place in greased baking pans and let stand in a warm place for 1 hour or until double in size.
3. Bake at 350°F/177°C for 25-30 minutes or until done.
4. Mix glaze ingredients until smooth and drizzle over top.

STICKY BREAKFAST ROLL DOUGH

	1.5 lb. - 18 rolls	2 lb. - 24 rolls
Egg(s), room temperature plus	1	2
enough Water 80°F/27°C to equal	1 cup + 2 TBL	1 1/2 cups
Oil	1/4 cup	1/3 cup
Sugar	1/3 cup	1/2 cup
Salt	1 tsp	1 1/2 tsp
Bread Flour	3 1/2 cups	4 1/2 cups
Active Dry Yeast	1 1/2 tsp	2 tsp
Program: DOUGH		
Add at the beep:		
Walnuts or Pecans, chopped	1/2 cup	2/3 cup
Filling		
Butter, softened	1/2 cup	2/3 cup
Sugar	1/3 cup	1/2 cup
Cinnamon	1 TBL	1 1/2 TBL
Topping		
Butter, melted	3/4 cup	1 cup
Brown Sugar	3/4 cup	1 cup

Method

1. Place on a lightly floured surface, roll dough into a 12 x 18 inch rectangle for 18 rolls (12 x 24 inch rectangle for 24 rolls) and spread with butter. Combine remaining filling ingredients and sprinkle over dough. Roll up tightly, jelly-roll style, starting with the longest side and cut into one inch slices.
2. Combine topping mixture and spread into baking pan. Place slices on mixture and let rise in a warm place for 1 hour or until double in size.
3. Bake at 350°F/177°C for 35 minutes or until done. Invert onto a heat-proof tray.

SOFT PRETZEL DOUGH

1.5 lb. - 16 pretzels	
Water 80°F/27°C	1 1/4 cups
Egg Yolk, room temperature	1
Oil	1 TBL
Sugar	2 TBL
Salt	1 tsp
White Pepper	1/8 tsp
Bread Flour	3 1/2 cups
Active Dry Yeast	1 TBL
Program: DOUGH	
Glaze	
Egg White	1
Water	1 TBL
Toppings (optional)	
Kosher Salt	1 TBL
Sesame Seeds	1 TBL

Method

1. Place dough on a lightly floured surface and cut into pieces. Roll each piece into a 16 inch rope. Cross the ends of the rope to make a loop; twist the crossed ends once and fold across the loop.
2. Place on a greased baking sheet 1 1/2 inches apart. Brush with glaze and sprinkle with topping. Let rise until double in size, about 30 minutes. Bake at 375°F/190°C for 15-20 minutes or until done.

Variation

PEPPERONI PRETZEL DOUGH

Method

1. Add 1 cup thin sliced pepperoni and 2 tablespoons Parmesan cheese to dough ingredients.
2. Follow method above for completion.

CREAMED SOUP BREAD BOWL DOUGH

	4 bowls
Eggs, room temperature plus	2
enough Water 80°F/27°C to equal	1 cup + 5 TBL
Oil	2 TBL
Honey	1/4 cup
Dry Milk	3 TBL
Salt	2 tsp
Bread Flour	2 1/4 cups
Whole Wheat Flour	1 cup
Rye Flour	1 cup
Caraway Seeds	3 TBL
Dehydrated Onions	1/4 cup
Active Dry Yeast	2 3/4 tsp
Program: DOUGH	

Note: Any 2 pound bread or dough recipe may be used; mix on dough program.

Method

1. Place dough on a lightly floured surface and divide into 4 equal pieces. Shape into 4 smooth round balls and place on a greased baking sheet.
2. Cover and let rise in a warm place for 1 hour or until double in size.
3. Bake at 350°F/177°C for 25-30 minutes or until done. Allow to cool completely on a wire rack.
4. With a serrated knife, remove the top 1 inch of each bread bowl. Remove the center, leaving a shell of 1/2 inch on sides and bottom.
5. Fill with approximately 1 cup of creamed soup (non-creamed soup will soak through the bread bowl too easily.) Cut removed bread into 1 inch pieces and serve with soup.

PARTY DIP BREAD BOWL DOUGH

1 bowl

Water 80°F/27°C	1 1/4 cups
Sugar	1 TBL
Salt	1 tsp
Bread Flour	3 1/2 cups
Active Dry Yeast	1 TBL

Program: DOUGH

Note: Any 1.5 pound dough or bread recipe may be used; mix on dough program.

Method

1. Place dough on a lightly floured surface. Shape into a large smooth round ball and place on a greased baking sheet.
2. Cover and let rise in a warm place for 1 hour or until double in size.
3. Bake at 350°F/177°C for 30-40 minutes or until done. Allow to cool completely on a wire rack.
4. With a serrated knife, remove the top 1-2 inches of the bowl. Remove the center, leaving a shell of 1/2 inch on sides and bottom.
5. Fill with 3 cups of dip. Cut removed bread into 1 inch pieces and serve with dip.

Shredded Beef Dip

Dried Beef, chopped	5 oz
Cream Cheese, softened	2-8 oz pkg
Sour Cream	1/2 cup
Green Onions, chopped	6
Accent® Seasoning	2 1/2 tsp
Worcestershire® Sauce	to taste

Mix and chill before serving.

Makes 3 cups.

Shrimp Dip

Canned Shrimp, drained and mashed	2 small cans
Cream Cheese, softened	8 oz pkg
Mayonnaise	1 cup
Green Onions, chopped	3

Mix and chill before serving.

Makes 3 cups.

CLEANING & STORING

ALWAYS UNPLUG THE UNIT AND ALLOW TO COOL COMPLETELY BEFORE CLEANING.

CAREFULLY UNPACK THE BREAD MAKER AND REMOVE ALL PACKAGING MATERIALS.

Any service requiring disassembly, other than the cleaning described below, must be performed by an authorized service center. Unauthorized service will void your warranty .

CLEANING

CLEAN-UP OF BREAD MAKER

1. Unplug and allow to cool before cleaning.
2. Remove bread pan from inside the bread maker.
3. Clean exterior of bread maker with a damp cloth and plastic scouring pad if necessary. Do not rub too hard as the surface may be scratched.
4. Remove any flour, bread crumbs or other food from the inside of the oven cavity using a damp sponge, cloth or a small portable vacuum cleaner. A plastic scouring pad may be used if necessary. Do not rub too hard as the surface may be scratched.
5. To clean the glass in the lid, use a glass cleaner or mild detergent and a damp cloth or plastic scouring pad. Do not use an abrasive cleaner or pad as they might scratch the glass.
6. Rinse with a damp cloth and dry thoroughly.

CLEAN-UP OF BREAD PAN AND KNEADING BLADE

DO NOT IMMEDIATELY BREAD PAN OR WASH IN DISHWASHER

1. Allow to cool before cleaning.
2. Fill with hot soapy water and remove kneading blade. If necessary to remove the kneading blade from the bread pan, allow the soapy water to remain in the pan for up to 30 minutes (longer times may damage the non-stick surface). It is not necessary to remove the kneading blade for cleaning. However, if you wish to, it is necessary to do so after each use or it will become increasingly difficult to release.
3. Wash bread pan and kneading blade with a nylon bristle brush. Do not use steel wool, abrasive cleaners, or metal utensils on the bread pan or kneading blade as they will damage the non-stick surface. Normal wear is to be expected. The non-stick may discolor over time and in no way affects performance.

STORING

- All removable parts should be thoroughly cleaned and dried.
- Store with lid closed and kneading blade inside bread pan.

BEFORE CALLING FOR SERVICE

■ Questions and Answers

Questions	Answers
1 Why does the height and shape of bread differ in each loaf?	The height and shape of bread may differ depending on the ingredients, room temperature and length of the timer cycle. Also accurate measurement of ingredients is essential to make delicious bread.
2 The bread has an unusual aroma. Why?	Stale ingredients or too much yeast may have been used. Always use fresh ingredients. Accurate measurements are essential to make delicious bread.
3 The kneading blade comes out with the bread.	This may happen as the kneading blade is detachable. Use a non-metal utensil to remove it. Caution: The kneading blade will be hot.
4 The baked loaf of bread has a floured corner.	Sometimes flour in the corner of the pan may not have been completely kneaded into the dough. Scrape the flour off the loaf with a spatula.
5 Why can the timer not be set for more than 13 hours?	Longer delay times could alter the baking results.
6 Can ingredients be halved or doubled?	No. If there is too little in the pan, the kneading blade cannot knead well enough. If there is too much, bread swells out of the pan.
7 Can fresh milk be used in place of dry milk?	Yes, for all programs except fast bake. Be sure to deduct the same measurement of water to equal liquid substitution (warm to 80°F/27°C.) Fresh milk is not recommended when using the timer, because it may spoil while setting in the pan.
8 Why is the display flashing E00 or E01?	The bread machine cavity needs to cool down before making the next loaf of bread.

■ Check List

BAKING RESULTS:			Bread maker does not operate/ ingredients not mixing	Smoke emitted from steam vent/ burning smell	Sides of bread collapse/ bottom is damp	Bread rises too much/ coarse texture	Bread falls/ coarse texture	Short & dense texture	Slices uneven & sticky
Please check the following:									
OPERATIONAL ERRORS	1. Unplugged/power outage		<input type="radio"/>						
	2. Display signal reads E00 or E01		<input type="radio"/>						
	3. Ingredients spilled on heating element			<input type="radio"/>					
	4. Top lid was open during baking							<input type="radio"/>	
	5. Bread left in bread pan too long after program				<input type="radio"/>				
	6. Bread sliced just after baking (steam was not allowed to escape)								<input type="radio"/>
	7. Kneading blade not installed		<input type="radio"/>						
MEASUREMENT ERRORS	Water	8. Not enough						<input type="radio"/>	
		9. Too much			<input type="radio"/>	<input type="radio"/>	<input type="radio"/>		
	Flour	10. Not enough					<input type="radio"/>		
		11. Too much						<input type="radio"/>	
	Yeast	12. No yeast						<input type="radio"/>	
		13. Not enough						<input type="radio"/>	
		14. Too much				<input type="radio"/>	<input type="radio"/>		
15. No sugar, molasses or honey							<input type="radio"/>		
16. Ingredients used other than recommended					<input type="radio"/>	<input type="radio"/>	<input type="radio"/>		
Flour	17. Wrong type of flour used						<input type="radio"/>		
Yeast	18. Yeast touched water before kneading						<input type="radio"/>		
	19. Old yeast used						<input type="radio"/>		
20. Temperature of water either too hot or too cold							<input type="radio"/>		

■ Suggestions

The following suggestions have a corresponding number found on the check list. Be sure to read both.

1. Plug into 120 V ~ 60 Hz outlet. Refer to power outage instructions.
2. Open lid, remove bread pan and allow to cool.
3. Wait until course is complete; unplug, allow to cool and clean.
4. Only open lid during kneading process to check dough ball or to add ingredients.
5. Remove bread as soon as program is done and place on wire rack.
6. Allow to cool approximately 20 minutes.
7. Put kneading blade on the shaft of bread pan.
8.-11. Check the dough ball at the beep. Dough should be round, smooth-textured, soft and slightly tacky to the touch. (Fast Bake dough ball will be sticky to the touch.) If more like a batter, add 1 TBL flour. Allow to mix; add more if necessary. If too dry, add 1 tsp water. Allow to absorb; add more if necessary.
12. Follow recipe.
13. Increase by 1/4 tsp.
14. Decrease by 1/4 tsp.
15. Artificial sugar substitutes not recommended.
16. Follow recipe or substitution recommendations.
17. Flours cannot be substituted.
18. Place yeast on top of flour away from liquids.
19. Make sure yeast is fresh and room temperature.
20. Water should be 80°F/27°C for all courses except Fast Bake which should be 110°-115°F/43°-46°C.

■ Service Information

SERVICE INFORMATION

Please refer to warranty statement to determine if in-warranty service applies. This appliance must be serviced by a Toastmaster authorized service center. Unauthorized service will void warranty. Consult your phone directory under "Appliances-Household-Small-Service and Repair," or call 1-800-947-3744 in the U.S. and Canada, 52-5-397-2848 in Mexico.

If an authorized service center is not available locally, your appliance may be returned postage prepaid to our National Service Center at the address shown on the back of this book.

Products must be adequately protected to avoid shipping damage. Surround your appliance with three inches of protective padding and include a copy of your dated sales receipt and a note explaining the problem you have experienced. We recommend insuring your package. No CODs accepted.

SPECIFICATIONS

Power Supply		120 V ~ 60 Hz
Power Consumption	Heater	400W
	Kneading Motor	50W
Dimension (WxDxH)		Approx. 14" x 10" x 12 ¹ / ₄ "
Weight		Approx. 9 LB

KEEP DATED SALES RECEIPT FOR WARRANTY SERVICE.

Keep this booklet. Record the following for reference:

Date purchased _____

Model number _____

Date code (stamped on bottom) _____

RECIPE INDEX

BREADS

Chevre Cracked Pepper	21
Cinnamon Raisin Nut	25
Cranberry Walnut	24
Egg	19
French	24
Holiday	26
Honey Oats	19
Onion	20
Pesto	21
Pumpnickel	23
Rich Sweet	25
Rye	20
Shredded Wheat	22
Triple Wheat	23
White	18
100% Whole Wheat	22

CAKES AND BAKE

Apple Walnut	31
Banana Nut	32
Corn	32
Irish Soda	32

DAY OLD BREAD USES

Bread Pudding	30
Breaded Pineapple	30
Crunchy Bread Snacks	30

DOUGHS

Almond-Cherry Coffee Cake	43
Bagel	42
Banana Wheat Bagel	42
Buttermilk Roll	36
Challah Bread	40
Cheezy Garlic Roll	38
Cinnamon Roll	44
Creamed Soup Bread Bowl	47
Dinner Roll	34
Focaccia Bread	35
French Bread	37
Party Dip Bread Bowl	48
Pita Pocket	38
Pizza Crust	41
Refreshing Roll	39
Soft Pretzel	46
Sticky Breakfast Roll	45
Wheat Dinner Roll	36
Whole Wheat Pizza Crust	41

FAST BAKE BREADS

Chevre-Cracked Pepper	29
Egg	29
Pesto	29
White	28

LIMITED ONE-YEAR GUARANTEE

Toastmaster Inc. warrants this product, to original purchaser, for one year from purchase date to be free of defects in material and workmanship.

This warranty is the only written or express warranty given by Toastmaster Inc. This warranty gives you specific legal rights. You may have other rights which vary from state to state. ANY OTHER RIGHT WHICH YOU MAY HAVE, INCLUDING ANY IMPLIED WARRANTY OF MERCHANTABILITY OR FITNESS FOR A PARTICULAR PURPOSE IS LIMITED IN DURATION TO THE DURATION OF THIS WARRANTY.

Defective product may be brought or sent (freight prepaid) to an authorized service center listed in the phone book, or to Service Department, Toastmaster Inc., 708 South Missouri St., Macon, MO 63552, for free repair or replacement at our option.

Your remedy does not include: cost of inconvenience, damage due to product failure, transportation damages, misuse, abuse, accident or the like, or commercial use. IN NO EVENT SHALL TOASTMASTER INC. BE LIABLE FOR INCIDENTAL OR CONSEQUENTIAL DAMAGES.

Some states do not allow limitations on how long an implied warranty lasts, or allow the exclusion or limitation of incidental or consequential damages, so the above limitations or exclusions may not apply to you.

For information, write Consumer Claims Manager, at the Macon address. Send name, address, zip, telephone area code and daytime number, model, serial number, and purchase date.

EVERYBODY EATS. It's a fact of life.

**But sometimes preparing
meals can become a chore.**

That's why TOASTMASTER has been invited

into millions of kitchens just like yours

so we can HELP YOU MASTER your

mixing, baking, grilling, toasting,

brewing, heating and serving

tasks WITH EASE AND STYLE.

The TOASTMASTER name stands for a

CELEBRATION of INNOVATION designed

to serve your life and keep you

COOKIN' IN STYLE.

Toastmaster Inc.

National Service Center
708 South Missouri St., Macon, MO 63552

In USA and Canada call:
Consumer Service 1-800-947-3744
Consumer Parts 1-800-947-3745
Hours: 8:00 a.m. - 5:30 p.m. CST

CONTACT US/APPELEZ



1-800-947-3744



www.toastmaster.com



consumer_relations@toastmaster.com

Free Manuals Download Website

<http://myh66.com>

<http://usermanuals.us>

<http://www.somanuals.com>

<http://www.4manuals.cc>

<http://www.manual-lib.com>

<http://www.404manual.com>

<http://www.luxmanual.com>

<http://aubethermostatmanual.com>

Golf course search by state

<http://golfingnear.com>

Email search by domain

<http://emailbydomain.com>

Auto manuals search

<http://auto.somanuals.com>

TV manuals search

<http://tv.somanuals.com>