

READ AND SAVE THESE INSTRUCTIONS

WARNING: A risk of fire and electrical shock exists in all electrical appliances and may cause personal injury or death. Please follow all safety instructions.



Toastmaster®

GLOBAL DESIGN

Deep Fryer

Use and Care Guide

Model 815U

IMPORTANT SAFEGUARDS

When using electrical appliances, basic safety precautions should always be followed to reduce the risk of fire, electric shock and injury to persons, including the following:

- Read all instructions before using fryer.
- Do not touch hot surfaces. Use handles and buttons.
- This fryer is not for use by children.
- Close supervision is necessary when any appliance is used near children.
- Do not operate unattended.
- Unplug from outlet when not in use and before cleaning. Allow to cool before putting on or taking off parts, and before cleaning the fryer.
- To disconnect, push off button, then remove plug from power supply.
- Do not operate a damaged fryer. Do not operate with a damaged cord or plug or after the fryer malfunctions, or has been dropped or damaged in any manner. Return fryer to the nearest authorized service facility for examination, repair or mechanical adjustment.
- Do not put cord, plug, or body of fryer in or under water or other liquid. See instructions for cleaning.
- Use attachments only if recommended by Toastmaster Inc.
- Do not use outdoors or when standing in damp area.
- Do not use fryer for other than intended use.
- Do not let cord hang over edge of table or counter or touch hot surfaces.
- Do not place on or near a hot gas or electric burner, or in a heated oven.
- Extreme caution must be used when moving fryer containing hot oil or other hot liquids. Allow to cool before removing.
- Be sure handle is fully extended and handle lock is securely in place before lifting basket. See detailed operating instructions.

SAVE THESE INSTRUCTIONS

THIS PRODUCT FOR HOUSEHOLD USE ONLY

CAUTION: A short power supply cord is provided to reduce the risk of personal injury

resulting from becoming entangled in or tripping over a longer cord.

POLARIZED PLUG: This appliance has a polarized plug, (one blade is wider than the other), as a safety feature to reduce the risk of electric shock. This plug is intended to fit in a polarized outlet only one way. If the plug does not fit fully in the outlet, reverse the plug. If it still does not fit, contact a qualified electrician to replace the obsolete outlet. Do not attempt to defeat this safety feature.

ELECTRIC POWER: If the electric circuit is overloaded with other appliances, your appliance may not operate properly. It should be operated on a separate electrical circuit from other appliances.

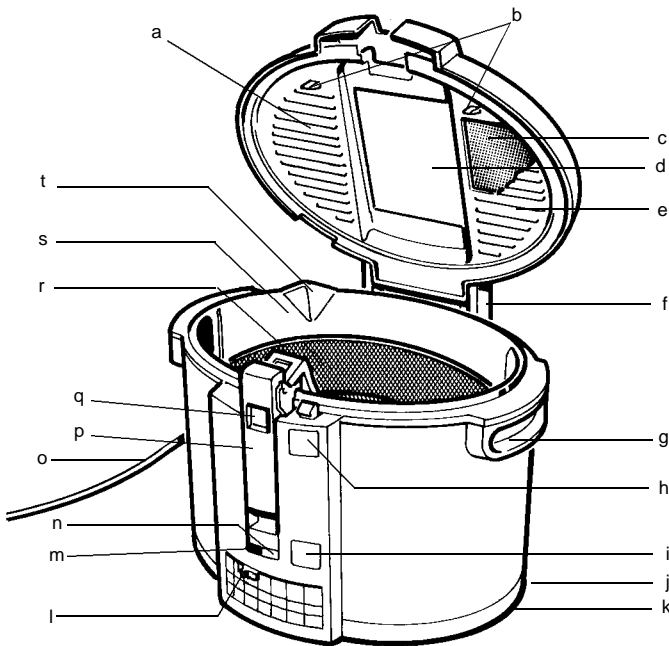

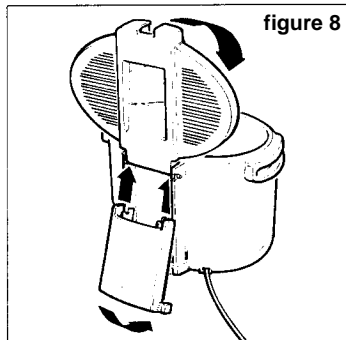
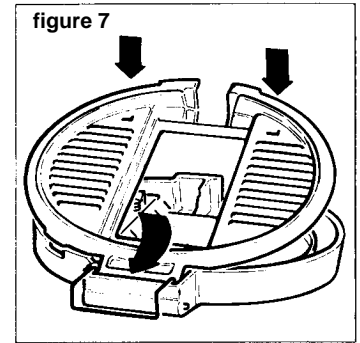
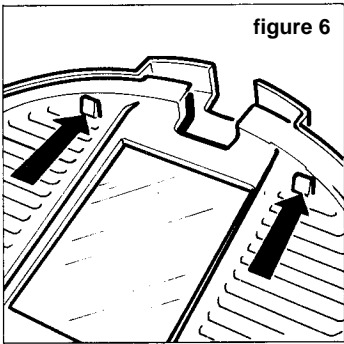
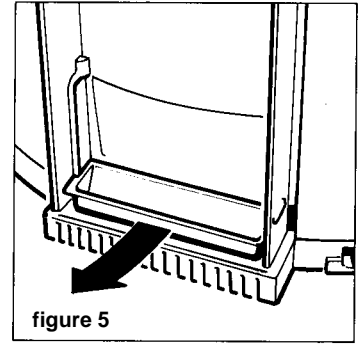
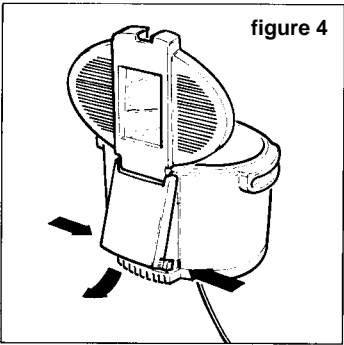
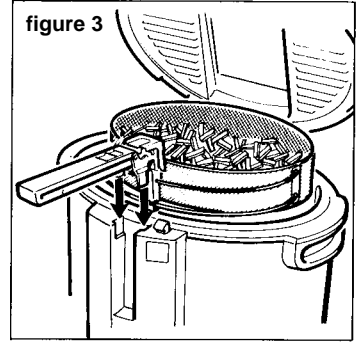
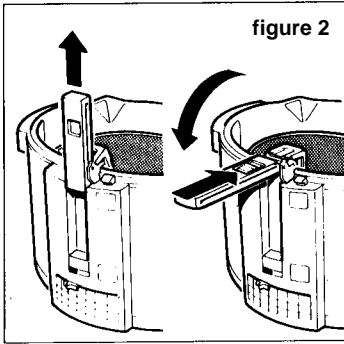

Figure 1

- | | |
|--|-----------------------------------|
| a. Lid assembly | k. Condensation cup (figure 5) |
| b. Black tabs (figure 6) | l. Adjustable temperature control |
| c. Removable washable filter | m. Green ready light |
| d. Viewing window | n. Red power light |
| e. Louvered filter cover | o. Cord |
| f. Detachable rear wall (figure 4) | p. Retractable handle (figure 2) |
| g. Recessed handle | q. Handle lock (figure 2) |
| h. OPEN button  | r. Fryer basket |
| i. ON/OFF button  | s. Cooking reservoir |
| j. Cord storage compartment | t. Pouring spout |



Thank You for purchasing this Toastmaster appliance.





Featuring superior technology and craftsmanship, the Global Design Collection is an exceptional line of kitchen appliances. The deep fryer's state-of-the art design is matched only by its excellent performance. Enjoy!



BEFORE USING YOUR DEEP FRYER

1. Read all sections of the booklet carefully. Become familiar with this appliance and its parts (see figure 1).
2. Be sure to fill out the warranty service information on the back of this manual.
3. Clean the fryer basket and non-stick reservoir (see CARE AND CLEANING).

NOTE: When emptying the cold oil from the deep fryer, the unit is easier to handle without the lid assembly. We suggest that you become familiar with removing the lid assembly before your first use.

USING YOUR DEEP FRYER

1. Place fryer on large secure surface.
2. Pull the cord from the cord storage compartment to the desired length.
3. Press OPEN button  to open lid. The lid will open automatically.
4. Remove the fryer basket by sliding the retractable handle of the fryer basket up. Pull handle down away from fryer; the fryer basket will raise during this action. Slide handle lock toward deep fryer to lock handle into place (see figure 2).
5. Lift the fryer basket out of the fryer.
6. Fill reservoir with vegetable oil. Use the MIN (8 cups) and MAX (10 cups) fill indicator lines in reservoir. Never add oil once the unit has been plugged in and allowed to heat up.
7. Close lid until it latches into place. Slide adjustable thermostat control to lowest setting (320°F). Plug into 120 V ~ 60 Hz outlet.
8. Push in the ON/OFF button  to turn the unit on. The red power light will come on.
9. Slide the thermostat to the appropriate setting. Allow the fryer to preheat for 15 minutes for the initial use each time. The green light will come on when the desired temperature has been reached. For repeat cycles, wait until the green ready light comes on before putting more food into the fryer.
10. Fill fryer basket with food, never filling more than 1/2 full. When fryer basket is lowered into hot oil, all food should be immersed.
11. Carefully open lid of fryer by pressing the OPEN button . Place fryer basket securely onto fryer by placing the tab under the fryer basket handle into the opening on the rim of the fryer (see figure 3). Carefully close lid. Unlock the handle by sliding the handle lock away from the basket. Slowly lower the basket into the oil by letting the handle rise to a vertical position. Slide handle down into original position.
12. At the end of the desired cooking time, remove the fryer basket from the hot oil by sliding the retractable handle of the fryer basket up. Pull handle down away from fryer; the fryer basket will raise during this action. Slide handle lock toward deep fryer to lock handle into place (see figure 2). Allow oil to drain from food for 30 seconds. Carefully open lid by pressing OPEN button  and lift basket out. Empty food on to a plate covered with an absorbent paper towel.
13. Carefully close lid and allow fryer to re-heat. When green ready light comes on,

- fill fryer basket with food and place into fryer. Repeat steps 10-13 as necessary.
14. When finished, close lid, slide adjustable thermostat control to lowest position (320°F) and push ON/OFF button  to turn off the unit. The red operating light will go out and ON/OFF button  will be flush with unit. If on, the green ready light will go off also.
 15. Unplug. Allow fryer and oil to cool completely before moving, cleaning or storing. Do not store electric fryer in refrigerator. If oil can be used again, strain food particles from oil and store in a covered container in refrigerator for future use. See CARE AND CLEANING.

HELPFUL HINTS FOR FRYING

- Fry more batches of smaller amounts of food. Best results are obtained when the hot oil can freely circulate all around the food thus allowing the fryer to maintain hotter cooking temperatures.
- In general, pre-cooked foods require higher temperatures and less cooking time.
- Cut or sort the food into uniform sizes. Cook same size pieces together so that they will be done in the same amount of time.
- Be sure foods are free from ice crystals and excess moisture before frying. Water on the surface can cause the oil to splatter and foam.
- When using a breading, evenly coat the food to be fried. Uniform and fine crumbs stick better than coarse and uneven ones. Shake off all extra breading to help keep oil clean.
- Foods with a coating should be spaced in fryer basket so as not to touch while cooking.
- For best results when frying doughs or foods dipped in a liquid batter, either remove the fryer basket or lower it into the hot oil before using a heat resistant metal spoon to carefully place the food into the oil. If the fryer basket is immersed in oil, use the basket to remove the cooked food.

HELPFUL HINTS ON OIL

- Never over fill or under fill the fryer with oil. Minimum and maximum oil amounts are marked on the inside of the cooking reservoir.
- Clean or strained oil may be stored in fryer temporarily, but should be transferred to a covered container for storing once cooled. Store the container in the refrigerator.
- If you fry fish or seafood, the oil will absorb a fishy taste. We suggest you change your oil before frying other foods.

FOOD TIME & TEMPERATURE COOKING CHART

The times listed below should only be used as a guideline. The quantity of food fried at one time may alter the total cooking time necessary.

REMEMBER, FRYING SMALLER BATCHES WILL RESULT IN BETTER COOKING TIMES AND QUALITY OF FOOD.

Food	Temperature	Approximate Cooking Time
chicken pieces	340°F	11-17 minutes
chicken tenders	340°F	7-10 minutes
fish fillets	340°F	5-7 minutes
shrimp - regular or jumbo	370°F	3-5 minutes
French fries-thin	370°F	3-5 minutes
French fries-thick	370°F	7-9 minutes
onion rings	370°F	3-5 minutes



NOTE: Frozen foods may require different cooking times and temperatures; follow package directions. If recommended temperature is above 365°F use the frozen foods setting  and allow to cook until done. Remember, never fill your fryer basket more than half full and remove ice crystals from frozen foods before placing in the hot oil.

DEEP FRYING TROUBLE SHOOTING GUIDE

Problem	Cause	Solution
oil smokes	failure to strain oil after use	Strain oil through a paper towel, or cheesecloth after oil cools and before storing.
oil bubbles over	too much oil in fryer	Do not fill above MAX fill line.
	too much food added to fryer at one time	Fry smaller quantities at a time.
	food too wet	Pat dry with paper towels before placing in basket.
food tastes greasy	using wrong type of oil	Use a high-quality oil such as vegetable, canola or corn.
	too much food cooked at same time	Cook smaller amounts of food.
	frying temperature too low	Allow unit to preheat or reheat prior to use.
omitting unpleasant odors	both filters are saturated	Filters need to be cleaned.
	oil is deteriorated	Change oil as needed.
steam escaping from under edge of lid	lid is not closed	The lid needs to be securely closed.
food is not crisp	too much has been fried at same time	Fry food in small batches, especially frozen foods.

CARE AND CLEANING

CAUTION: UNPLUG FROM OUTLET

- Slide adjustable thermostat control to lowest setting, 320°F. Make sure the ON/OFF button  has been pressed and button is flush with unit. The red operating light and the green ready light will go out.
- Unplug and allow fryer and oil to cool completely before cleaning.
- Do not immerse the appliance in water.
- Press the OPEN button  and remove the fryer basket by sliding the retractable handle of the filter basket up. Pull handle down away from fryer; the fryer basket will raise during this action. Slide handle lock toward deep fryer to lock handle into place. Remove the basket.
- To remove the lid assembly, grasp the detachable rear wall of the fryer at the bottom end, press both sides together, and pull out to remove the detachable rear wall (see figure 4). Remove the condensation drip cup (see figure 5); empty and wash in warm soapy water.

6. The lid assembly can now be lifted out of the hinge. To remove the filters, place the lid assembly on the countertop with the louvered filter cover face up. Press both black tabs forward as indicated by the direction of the arrows. The louvered filter cover will pop up and can be removed from lid assembly (see figure 6). Lift up on both black tabs and remove the washable filters for cleaning.
7. To clean the remainder of the lid assembly, wipe inside and outside with a damp cloth and dry.
8. Carefully pour cold oil out of reservoir using the pouring spout. Wash interior of reservoir with mild dish detergent and warm water. A plastic scouring pad may be used if necessary. **DO NOT IMMERSE.**
9. The washable filters and fryer basket may be placed on the top shelf of the dishwasher or they may be washed in warm soapy water with a non-abrasive pad or brush and dried thoroughly. Wash the filters often to reduce cooking odors.
10. The oil can be reused several times. If re-using oil, strain food particles from cold oil after each use. Place basket back into fryer with handle in its locked position.
11. Line the fryer basket with a large clean paper towel or cheese cloth. The liner must cover the bottom of the fryer basket and approximately one inch up the sides.
12. Slowly pour cold oil through basket liner back into the clean fryer for short term storing. When storing oil for longer periods of time, place oil in covered container and put in refrigerator.
13. Discard basket liner. Wash and dry fryer basket thoroughly before putting into fryer for storage.
14. Once the filters have been washed and dried thoroughly, insert into lid assembly with the grooved edges face up. Push both black tabs down to hold filters in place.
15. Place louvered cover onto lid assembly and lock into place with black tabs (see figure 7).
16. Replace condensation drip cup to its original position (see figure 5). Place the lid assembly onto the appliance by inserting hinges into notches (see figure 8). While holding the lid assembly straight up, line up the notches of the detachable rear wall on the hinges until it snaps into place (see figure 8). Close lid assembly.
17. Clean the outside of the deep fryer with a damp cloth and dry thoroughly.

CAUTION: DO NOT IMMERSE CORD, PLUG OR DEEP FRYER UNIT IN WATER OR OTHER LIQUID.

RECIPES

BEER BATTER

A light batter good on fish and chicken.

1 cup all-purpose flour	3/4 cup flat beer
1/4 cup cornstarch	2 eggs, lightly beaten
1/4 tsp cayenne pepper	2 TBL vegetable oil
1 tsp garlic salt	

Remove fryer basket before preheating. Combine all dry ingredients. Add liquid ingredients and mix well. Allow batter to chill in refrigerator for at least 1 hour before coating fish or chicken. Dip food in batter and place into oil using a heat resistant metal spoon.

CRISPY BATTER

A thicker batter that is good on meats, fish, poultry and vegetables.

3/4 cup all-purpose flour	1 tsp salt
1/4 cup cornstarch	1 cup water
2 tsp baking powder	dry bread crumbs, fine-dry (plain or seasoned)

Combine all dry ingredients except bread crumbs. Add water and mix until smooth. Dip food in batter and then coat with bread crumbs. Place into fryer basket. Lower basket into oil.

FLOUR COATING

A plain coating that is good on meats, fish and poultry.

1/2 cup all-purpose flour	1 tsp salt
1/4 tsp pepper	

Combine all ingredients together. Coat food and place in basket. Lower fryer basket into oil. For flavor variation, add 1/2 tsp of dried thyme, tarragon, basil, poultry seasoning, or 1 teaspoon of curry powder to flour mixture.

APPLE FRITTERS

3 cups all-purpose flour	1 egg, lightly beaten
2 tsp baking powder	4 tsp butter, melted
1/2 cup sugar	1 tsp vanilla extract
1/2 tsp salt	1/3 cup orange juice
1 cup milk	1 cup apples, chopped
	powdered sugar

350°F	3-5 minutes	18 fritters
-------	-------------	-------------

Sift dry ingredients together. Using an electric mixer, add remaining ingredients except apples. Stir in apples. Lower fryer basket into oil. Using a heat resistant metal spoon place 1 teaspoon of batter at a time into oil. Turn halfway through cooking time. Dust with powdered sugar while still warm.

DOUGHNUTS

1 egg, lightly beaten	1/4 tsp salt
1/2 cup sugar	1/4 tsp nutmeg
1 TBL butter, melted	1/2 tsp cinnamon
1/2 cup milk	2 tsp baking powder
2½ cups all-purpose flour	powdered sugar

350°F	3-4 minutes	18 doughnuts
-------	-------------	--------------

Using an electric mixer, mix all ingredients forming a dough. Roll to 1/4 inch thick on a lightly floured surface. Cut with a floured 2 1/2 inch doughnut cutter. Lower fryer basket into oil. Using a heat resistant metal spoon place doughnuts into oil. Turn halfway through cooking time. Dust with powdered sugar or a cinnamon sugar mixture while still warm.

QUICK 'N' EASY DOUGHNUTS

1 can of 10 refrigerated biscuits
powdered sugar or cinnamon sugar mixture

350°F

2-4 minutes

10 doughnuts

Separate dough into 10 biscuits and cut hole in center of each. Lower fryer basket into oil. Using a heat resistant metal spoon place doughnuts into oil. Turn half way through cooking time. Dust with powdered sugar or sugar and cinnamon mixture while still warm.

SMOOCHIES

1 can of 10 refrigerated biscuits
20 pieces chocolate candy kiss
1/2 cup powdered sugar

350°F

2-3 minutes

20 pieces

Separate dough into 10 biscuits. Cut each biscuit in half and flatten. Place 1 chocolate kiss in the center of each and pull edges up around candy kiss to seal tightly. Roll between palms until all seams are sealed making a ball. Lower fryer basket into oil. Using a heat resistant metal spoon place smoochies into oil. Dust with powdered sugar while still warm.

HUSH PUPPIES

1 egg, lightly beaten
1 8 oz pkg corn muffin mix
1 cup all-purpose flour
2 tsp dehydrated onions
1/2 tsp garlic, minced
1/2 cup + 3 TBL milk

350°F

3-5 minutes

14 pieces

Mix all ingredients together until a batter is formed. Lower fryer basket into oil. Using a heat resistant metal spoon drop batter by tablespoons into oil.

VEGETABLE FRITTERS

3/4 cup bread crumbs, fine-dry
2 TBL Parmesan cheese
1 tsp onion salt
1/4 tsp garlic powder
2 egg whites, lightly beaten
2 TBL water
2 1/2 cups fresh vegetables
sliced into 1/4 inch thick pieces -
carrots, mushrooms,
green and red peppers,
zucchini

350°F

3-5 minutes

2 1/2 cups

Combine dry ingredients, set aside. Combine liquid ingredients. Dip vegetables into liquid mixture and then coat with dry mixture. Place into fryer basket. Lower fryer basket into oil. Serve with ranch flavored dressing.

ONION HAYSTACKS

1 cup all-purpose flour	1 tsp seasoning salt
1/4 cup cornstarch	3/4 cup flat beer
1/4 tsp cayenne pepper	2 eggs, lightly beaten
1/4 tsp garlic powder	1 large onion, cut into slivers

370°F 3-5 minutes 4-5 servings

Combine dry ingredients. Add remaining ingredients except for onions and mix well. Stir onions into batter. Lower fryer basket into oil. Use heat resistant metal tongs to place onion stacks into oil.

ONION RINGS

1 large onion, 1/2 inch thick slices	1/2 cup bread crumbs, fine-dry
1 egg, lightly beaten	1/2 cup flour
1 TBL water	salt and pepper to taste

370°F 3-4 minutes 3-4 servings

Separate onion slices into rings. Combine liquid ingredients. Combine dry ingredients. Dip each onion ring into liquid then dry mixture. Lower fryer basket into oil. Using a heat resistant metal spoon place onions into oil.

FRENCH FRIES

10 potatoes, peeled - 3/8 inch wide strips
salt to taste

370°F 12-15 minutes 4 servings

Pat dry potatoes. Place in basket. Lower fryer basket into oil. Season with salt while still warm.

COTTAGE FRIES

10 potatoes, thinly sliced (1/16 - 1/8 inch)
seasoned salt to taste

370°F 5-7 minutes 4 servings

Pat dry potatoes. Place in basket. Lower fryer basket into oil. Season with salt while still warm.

SOUTHERN FRIED CHICKEN

2 tsp seasoned salt	2 - 3 lbs chicken pieces
1 cup all-purpose flour	1/4 cup milk
1/4 tsp pepper	

340°F 11-17 minutes 8-10 pieces

Combine dry ingredients. Dip chicken in milk then coat with dry mixture and place in fryer basket. Lower fryer basket into oil. Fry similar size pieces together.

CHICKEN CROQUETTES

16-18 oz can cooked chicken*, drained	1/4 tsp salt
1 cup onion, finely chopped	1/4 tsp pepper
3 TBL butter	1/8 tsp of paprika
1/4 cup all-purpose flour	1/8 tsp of nutmeg
1/2 cup chicken broth	
1/3 cup milk	1 cup bread crumbs, dry-fine
1 TBL dried parsley	2 eggs, lightly beaten
1 tsp lemon juice	2 TBL water

Combine chicken and onion, set aside. In a sauce pan, melt butter, add flour and blend until smooth. Add chicken broth and milk. Cook until thick. Remove from heat. Stir in parsley, lemon juice, salt, pepper, nutmeg and paprika. Add chicken mixture and mix well. Chill at least 1 hour.

350°F 2-3 minutes 24 balls

Roll into 1-1½ inch balls. Mix egg and water. Dip each ball into egg mixture and roll in bread crumbs. Place in fryer basket. Lower fryer basket into oil.

*Or substitute any other pre-cooked meat or seafood.

CHICKEN FRIED CHICKEN

1½ cups all-purpose flour	2 eggs, lightly beaten	
2 tsp salt	1/4 cup milk	
1/2 tsp pepper	4 chicken breast, boneless-skinless	
370°F	8-12 minutes	4 servings

Remove fryer basket from fryer before preheating. Combine all dry ingredients together. Combine all liquid ingredients together. Dip chicken breast into liquid mixture and then flour mixture. Repeat. Using a heat resistant metal spoon place chicken into oil. Serve with milk gravy.

PORK CHOPS

3/4 cup all-purpose flour	1 cup water	
1/4 cup cornstarch	6 pork chops	
2 tsp baking powder	2 cups bread crumbs, dry-fine	
1 tsp salt		
340°F	8-10 minutes	6 servings

Remove fryer basket from fryer before preheating. Combine first 5 ingredients until smooth. Dip pork chops into batter coating thoroughly, then coat with bread crumbs. Place pork chops into oil using a heat resistant metal spoon.

ROLLING EGG ROLL OR WON TON WRAPPERS

1. Place wrapper on counter in a diamond shape.
2. Moisten all corners with water.
3. Spoon filling onto the center of the wrapper.
4. Fold top of diamond over just enough to cover filling.
5. Fold side corners toward center over top corner.
6. Moisten bottom corner with water; roll top down until sealed.

MINI EGG ROLLS

1/2 lb. ground lean pork	2 tsp soy sauce
1/4 lb shrimp, fresh or frozen chopped	1/4 tsp salt
1/4 cup water chestnuts, finely chopped	12 oz pkg won ton wrappers
1/4 cup green onions, finely chopped	

340°F 4-5 minutes 30 egg rolls

Combine pork and shrimp. Add remaining ingredients and mix well. Place 2 teaspoons of mixture in the middle of egg roll wrapper. Follow instructions for rolling won ton wrappers. Place in fryer basket. Lower fryer basket into oil.

SAMOSAS

2 TBL vegetable oil	1 medium tomato, chopped
1/2 cup onion, chopped	1 tsp salt
1 tsp ginger, grated	1/2 cup peas, cooked
1 tsp garlic powder	16 oz pkg egg roll wrappers
1 tsp curry powder	
1/2 lb ground beef	

340°F 5-6 minutes 18 egg rolls

Sauté onion in oil until browned, add ginger, garlic and curry powder. Cook for 2 minutes. Add ground beef, tomato and salt, cook until beef is done. Stir in peas and allow to cool. Place 2 teaspoons of mixture in the middle of egg roll wrapper. Follow instructions for rolling egg roll wrappers. Place in fryer basket. Lower fryer basket into oil.

FRENCH FRIED JUMBO SHRIMP

2 lbs jumbo shrimp in shells, fresh or frozen	1 egg, lightly beaten
2 cups all-purpose flour, divided	1 cup cold water
1/2 tsp sugar	2 TBL cooking oil
1/2 tsp salt	1 cup bread crumbs, dry-fine (optional)

370°F 4-8 minutes 6-8 servings

Peel shrimp leaving last section and tail in tact. With a sharp knife, remove the sandy, black vein. Cut the shrimp down the middle to butterfly and pat dry with a paper towel. Remove fryer basket from fryer before preheating oil. Stir together 1 cup flour, sugar and salt. Add liquid ingredients using an electric mixer to blend until smooth. Dip shrimp in remaining 1 cup of flour and then into batter. Coat with bread crumbs for darker browning. Lower fryer basket into oil. Using a heat resistant metal spoon place shrimp into oil.

FRENCH FRIED SEAFOOD

1 lb shrimp, 3/4 lb scallops,
or 1 lb fish filets
1/2 cup all-purpose flour
1 tsp salt

1/4 tsp pepper
2 eggs, lightly beaten
1 cup bread crumbs, dry-fine

370°F

2-8 minutes

4 servings

Combine flour, salt, and pepper. Dip seafood in flour mixture then into eggs. Coat with bread crumbs. Lower fryer basket into oil. Using a heat resistant metal spoon, place fish into oil.

CRISPY FISH STICKS

1 lb fish filets, skinless-fresh or
frozen-thawed
1/2 cup all-purpose flour
1 tsp salt

1/4 tsp pepper
2 eggs, lightly beaten
1 cup bread crumbs, dry-fine

330°F

3-5 minutes

4 servings

Cut fish into 1 inch strips. Combine flour, salt and pepper. Dip fish sticks into flour mixture and then into eggs. Coat with bread crumbs. Place fish in fryer basket and lower into oil.

FRIED FISH

1 lb skinless fish filets,
fresh or frozen-thawed
1 cup all-purpose flour
1/2 tsp sugar

1/2 tsp salt
1 egg, slightly beaten
3/4 cup cold water
2 TBL vegetable oil

370°F

4-9 minutes

4 servings

Remove fryer basket before preheating oil. Cut fish 4 inch x 4 inch pieces. Combine dry ingredients. Combine liquid ingredients. Using an electric mixer, blend liquids and dry ingredients together until smooth. Dip fish into batter. Using a heat resistant metal spoon place fish into oil.

RECIPE INDEX

Batters and Coatings

Beer Batter	8
Crispy Batter	9
Flour Coating	9

Doughs

Apple Fritters	9
Doughnuts	9
Hush Puppies	10
Smoochies	10
Quick 'N' Easy Doughnuts	10

Meats

Chicken Croquettes	12
Chicken Fried Chicken	12
Crispy Fish Sticks	14
French Fried Seafood	14
French Fried Jumbo Shrimp	13
Fried Fish	14
Mini Egg Rolls	13
Pork Chops	12
Samosas	13
Southern Fried Chicken	11

Vegetables

Cottage Fries	11
French Fries	11
Onion Haystacks	11
Onion Rings	11
Vegetable Fritters	10

SERVICE INFORMATION

Please refer to warranty statement to determine if in-warranty service applies.

This appliance must be serviced by a Toastmaster authorized service center. Consult your phone directory under "Appliances-Household-Small-Service and Repair," or call 1-800-947-3744 in the U.S. and Canada, 52-5-397-2848 in Mexico.

If an authorized service center is not available locally, your appliance may be returned postage prepaid to our National Service Center at the address shown in the warranty statement. Products must be adequately protected to avoid shipping damage. Surround your appliance with three inches of protective padding and include a note explaining the problem you have experienced. We recommend insuring your package. No C.O.D. shipments accepted.

ONE YEAR LIMITED WARRANTY

Toastmaster Inc. warrants this product, to original purchaser, for one years from purchase date to be free of defects in material and workmanship.

This warranty is the only written or express warranty given by Toastmaster Inc. This warranty gives you specific legal rights. You may have other rights which vary from state to state. ANY OTHER RIGHT WHICH YOU MAY HAVE, INCLUDING ANY IMPLIED WARRANTY OF MERCHANTABILITY OR FITNESS FOR A PARTICULAR PURPOSE IS LIMITED IN DURATION TO THE DURATION OF THIS WARRANTY.

Defective product may be brought or sent (freight prepaid) to an authorized service center listed in the phone book, or to Service Department, Toastmaster Inc., 708 South Missouri St., Macon, MO 63552, for free repair or replacement at our option.

Your remedy does not include: cost of inconvenience, damage due to product failure, transportation damages, misuse, abuse, accident or the like, or commercial use. IN NO EVENT SHALL TOASTMASTER INC. BE LIABLE FOR INCIDENTAL OR CONSEQUENTIAL DAMAGES.

Some states do not allow limitations on how long an implied warranty lasts, or allow the exclusion or limitation of incidental or consequential damages, so the above limitations or exclusions may not apply to you.

For information, write Consumer Claims Manager, at the Macon address. Send name, address, zip, telephone area code and day-time number, model, serial number, and purchase date.

KEEP DATED SALES RECEIPT FOR WARRANTY SERVICE.

Keep this booklet. Record the following for reference:

Date purchased _____

Model number _____

Date code (stamped on bottom) _____

Toastmaster Inc.

National Service Center

708 South Missouri St.

Macon, MO 63552

In USA and Canada call:

Consumer Service 1-800-947-3744

Consumer Parts 1-800-947-3745

Hours: 8:00 a.m. - 4:30 p.m. CST

Aux E.-U. et au Canada, veuillez appeler

Service consommateur : 1-800-947-3744

Pièces détachées consommateur : 1-800-947-3745

Heures ouvrables : 8 h - 16 h 30 Heure Centrale

En México - 52-5-397-2848

Horario: 8:00 a.m. hasta 4:30 p.m., hora del Centro

Toastmaster de México, SA de CV

Cerrada de Recursos

Hidráulicos Numero 6

La Loma Industrial

Tlalnepantla de Baz, C.P. 54060

Estado de México

CONTACT US/APPELEZ



1-800-947-3744



www.toastmaster.com



consumer_relations@toastmaster.com

PART NO. 32685P01

FOR SPANISH SECTION ONLY

ESPECIFICACIONES TECNICAS

Potencia Nominal (Watts)

2000 W

Tension de Alimentacion o Tension Nominal (Volts)

127 V ~

Frecuencia de Operacion o Frecuencia Nominal (Hertz)

60 Hz

Free Manuals Download Website

<http://myh66.com>

<http://usermanuals.us>

<http://www.somanuals.com>

<http://www.4manuals.cc>

<http://www.manual-lib.com>

<http://www.404manual.com>

<http://www.luxmanual.com>

<http://aubethermostatmanual.com>

Golf course search by state

<http://golfingnear.com>

Email search by domain

<http://emailbydomain.com>

Auto manuals search

<http://auto.somanuals.com>

TV manuals search

<http://tv.somanuals.com>