



BATCH TOASTER Models MBT208/MBT240



Place this chapter in the Toaster
Section of your **Equipment Manual**.

MANUFACTURED
EXCLUSIVELY FOR
McDONALD'S®
BY
TOASTMASTER®

A Middleby Company

1400 Toastmaster Drive

Elgin, IL 60120

PHONE: 1 (847) 741-3300

FAX: 1 (847) 741-4406

24-hour Service Hotline: 1 (800) 238-8444

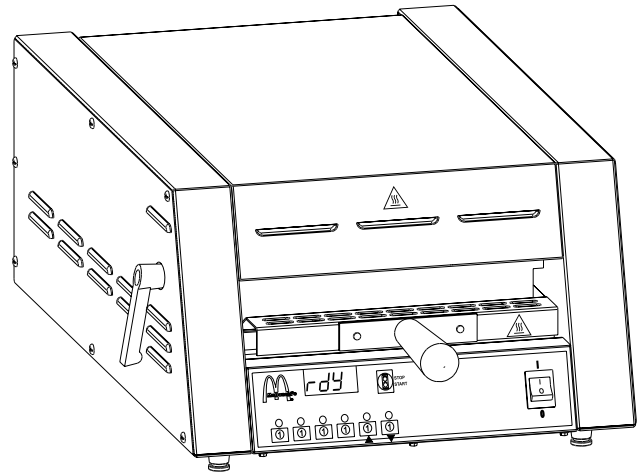

TABLE OF CONTENTS

WARRANTY STATEMENT	1
INTRODUCTION	2
SAFETY	2
SPECIFICATIONS	3
INSTALLATION	4
SET-UP, OPERATION, AND CLOSE PROCEDURES	6
TROUBLESHOOTING	9
PARTS IDENTIFICATION AND FUNCTION	10
ORDERING AND SERVICE INFORMATION	12
ELECTRICAL WIRING DIAGRAM	14
ELECTRICAL SCHEMATIC	15

McDONALD'S LIMITED WARRANTY

This warranty is effective on all Toastmaster equipment manufactured for McDonald's sold on or after 4/1/2000, and supersedes all previous warranties. Toastmaster warrants equipment that it manufactures to be free from defects in material and workmanship. Toastmaster's obligation is limited to repairing or replacing, at Toastmaster's option, without cost to the customer, any part found to be defective, as well as any labor or material expense required to replace the part. All Toastmaster products will be serviced on-site during the warranty period. This warranty is valid worldwide.

Length of Warranty

This warranty is effective for a period of 18 months from the date of shipment from Toastmaster, or 12 months from the date of purchase by the Buyer, whichever is earlier.

Exceptions

- This warranty is valid only for the original owner/operator of the equipment.
- This warranty does not apply to normal maintenance functions, including (but not limited to) cleaning and lubrication.
- This warranty does not apply to service required due to customer abuse, including (but not limited to) improper operation, installation, or the use of an improper utility supply.
- This warranty is valid only if the equipment is used in a commercial setting. The equipment is designed and constructed for commercial use by trained professionals only. Any use of the equipment in private or domestic applications immediately voids this warranty.
- This warranty does not apply to any parts, labor, and material expenses for service that is NOT performed by a Toastmaster Authorized Service Agent. Any such service immediately voids this warranty.
- This warranty does not apply to any parts, labor, and material expenses associated with the installation of parts that are not factory-approved for use in the equipment. Any use of such parts immediately voids this warranty.
- This warranty is not valid if terms of payment have not been met.

Toastmaster reserves the right to change the design and specifications of this equipment at any time. The Buyer is not entitled to upgrades resulting from these changes.

This warranty is exclusive and supersedes all other warranties for the equipment, both expressed and implied. There are no implied warranties of merchantability or of fitness for a particular purpose.

The foregoing is Toastmaster's sole and exclusive obligation and the Buyer's sole and exclusive remedy for any action including breach of contract or negligence. In no event shall Toastmaster be liable for a sum in excess of the purchase price of the equipment, or for any prospective or lost profits of the Buyer.

This manual is for the exclusive use of licensees and employees of McDonald's Systems, Inc.

INTRODUCTION

Batch Toaster Information

The Model MBT208/MBT240 Batch Toaster is a commercial batch toaster designed to uniformly toast English muffins, bagels, and other bakery products in large quantities. Up to six individual program settings can be selected and programmed to toast a wide variety of bakery products.

About This Manual

Retain this Manual for future reference. It is an important tool for the operator of the toaster, and should be kept readily available.

This Manual provides detailed information on:

- Toaster safety
- Toaster installation
- Toaster operation
- Toaster troubleshooting
- Toaster servicing

IMPORTANT

Using any parts other than genuine Toastmaster factory-supplied parts relieves the manufacturer of all liability.

IMPORTANT

Your Batch Toaster comes with a warranty from Toastmaster. Terms and conditions of this warranty are described on the front cover of this Manual. During this warranty period, all parts replacement and servicing should be performed by your Toastmaster Authorized Service Agent. A service agency listing is supplied with your toaster. Service that is performed by parties other than your Toastmaster Authorized Service Agent will void your toaster's warranty.

NOTE

Toastmaster (the manufacturer) reserves the right to change specifications and product design for this toaster without notice. These revisions do not entitle the buyer to corresponding changes, improvements, additions, or replacements for previously purchased equipment.

NOTE

This equipment is manufactured in the United States of America and uses American sizes of hardware. All metric hardware sizes that are listed in this manual are conversions that may be approximations.



SAFETY



WARNING: IN CASE OF FIRE

In case of fire, IMMEDIATELY disconnect the toaster from its electrical power supply.

Use only fire extinguishers which are suitable for use on electric equipment, such as CO₂.

For your safety, do not use or store any flammable liquids or vapors in the vicinity of this or any other appliance.

WARNING: Hazard Communication Standard (HCS)

Some procedures in this Manual specify the use of chemical products. These chemical products will be highlighted with **boldface letters** followed by the abbreviation (**HCS**). See the **Hazard Communication Standard (HCS) Manual** for the appropriate **Material Safety Data Sheet(s) (MSDS)**.

WARNING: General

- Never attempt to move the toaster by inserting the hands into the entrance/exit opening. Severe injury may result.
- Never attempt to move the toaster while it is plugged into a power socket.
- The toaster should always be unplugged for servicing. Electrical tests which require power to the unit should only be performed by authorized service personnel.

WARNING: Electrical Utility Connections

The toaster should be grounded according to local electrical codes to prevent the possibility of electric shock. The toaster requires a grounded receptacle with separate electric lines, protected by fuses or circuit breakers of the proper rating.

WARNING: Electric Component Servicing

Inspection, testing, and repair of any electrical components of the toaster should only be performed by authorized service personnel. Extreme care should be taken during electrical circuit tests, as live circuits may be exposed.

SPECIFICATIONS

Overall Dimensions

Width	17-1/2" (445mm)
Depth (inc. rear cord clearance, peel removed)	28" (711mm)
Depth (inc. rear cord clearance, peel in toaster)	32" (813mm)
Height (inc. legs)	10-1/2" (267mm)

Toasting Area Dimensions

Width, Loading Area of Peel	11-1/4" (286mm)
Length, Loading Area of Peel	16-1/2" (419mm)
Vertical Clearance Above Peel in Toasting Chamber	1-3/4" (44mm)

Toaster Information

Approximate Net Wt.	58.0 lbs. (26.3kg)
Approximate Shipping Wt.	69.4 lbs. (31.5kg)
Construction	Formed and welded sheet steel
Finish	Stainless steel
Pre-Heat Time	15 minutes
Normal Product Load	12 muffin halves or 6 bagel halves
Capacity	720 muffin halves per hour

Electrical Specifications

Operating Voltage	Model MBT208: 208V Model MBT240: 230V or 240V
Frequency	50/60Hz
Phase	1 Ph
kW Rating	Model MBT208: 2.45kW at 208V Model MBT240: 2.45kW at 230V 2.67kW at 240V
Current Draw	Model MBT208: 11.8A at 208V Model MBT240: 10.7A at 230V 11.1A at 240V
Cord and Plug Information	<p><i>USA & standard export:</i></p> <p>3-wire cord (2 hot, 1 gnd), #12 AWG, with 30A pin-and-sleeve plug OR 3-wire cord (2 hot, 1 gnd), #12 AWG, with 30A twist-lock plug OR HO7RN-F harmonized cord with 3x4,0mm conductors and 30A twist-lock plug</p> <hr style="border-top: 1px dashed black;"/> <p><i>Europe:</i></p> <p>HO7RN-F harmonized cord with 3x4,0mm conductors and 32A pin-and-sleeve plug OR HO7RN-F harmonized cord with 3x4,0mm conductors and 16A pin-and-sleeve plug (Germany MBT240 only)</p>

INSTALLATION

IMPORTANT

It is the customer's responsibility to report any concealed or non-concealed damage to the freight company.

IMPORTANT

The Batch Toaster may only be installed in a single-unit, countertop configuration.

Assembly

1. Pull the door handle up and forward to open the door. Then, remove all components from inside the toaster.
2. Remove and discard all packing material from the toaster and components.
3. Position the toaster in place. Adjust the bottom section of each leg as necessary to level the toaster.
4. Adjust the heat curtain at the rear of the toaster so that it sits on the countertop. Tighten the screws that hold the curtain in place. See Figure 2.
5. The door handle is pre-installed on the left side of the toaster. If it is necessary to move the door

handle to the right side of the toaster, perform the following procedure:

- Rotate the door handle in a COUNTER-CLOCKWISE direction until it is free of its mounting shaft. See Figure 1.
 - Remove the round metal plug that covers the handle mounting hole on the right side of the toaster.
 - Reinstall the round metal plug into the left handle mounting hole.
 - Install the handle in place on its shaft on the right side of the toaster. Rotate it in a CLOCKWISE direction until it is firmly in place.
 - Check that the door handle points DOWN while the door is in the closed position, as shown in Figure 1. If it is necessary to reposition the handle, loosen its 5/32"/4mm Allen set screw. Reposition the handle, then tighten the screw to fasten the handle in place.
6. Slide the lower deck into the toaster as shown in Figure 2.
 7. Store the peel in a clean, dry location underneath the toaster.

Figure 1 - Moving the Door Handle to the Right Side of the Toaster (if so desired)

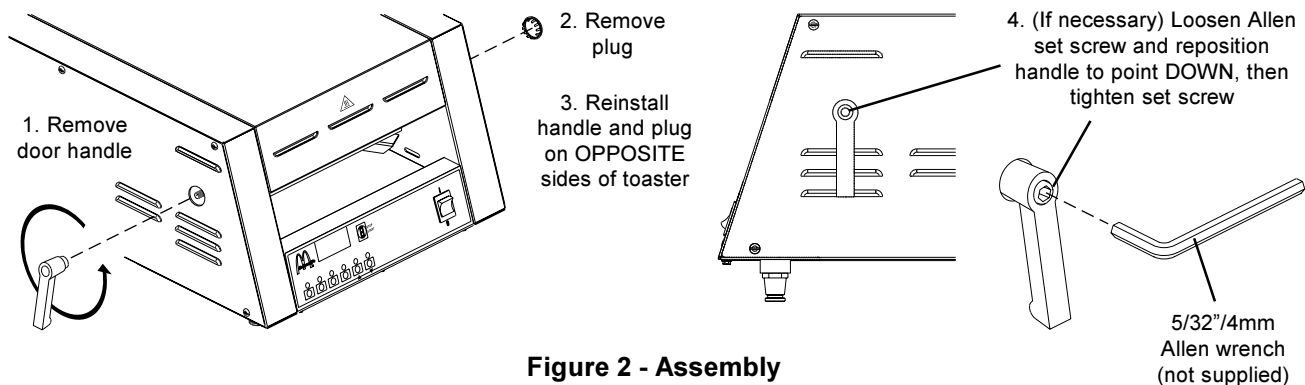
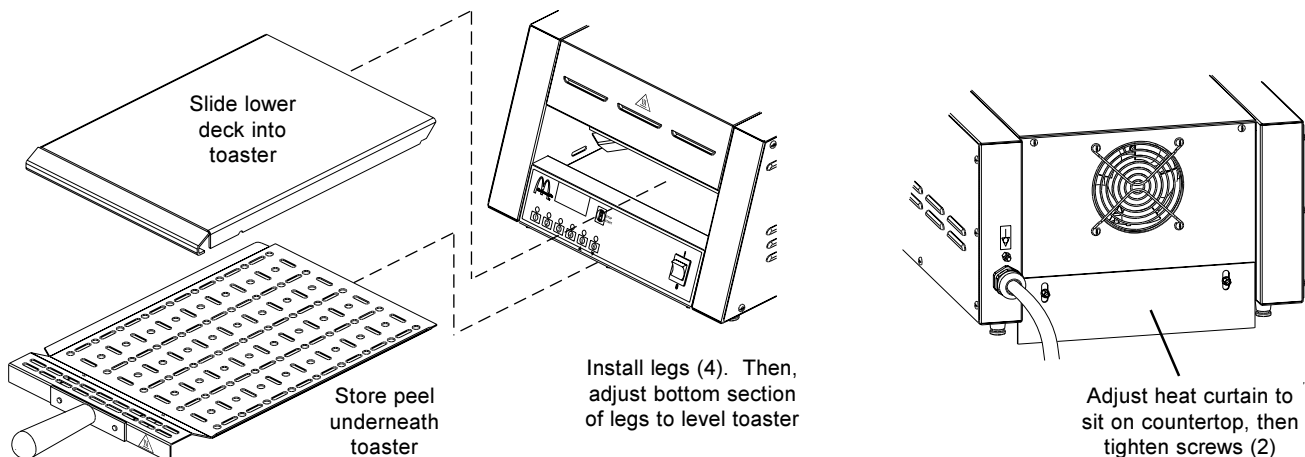



Figure 2 - Assembly



Electrical Connection

IMPORTANT

- An electrical schematic for the toaster is provided at the back of this Manual.
 - The electrical connection to the toaster requires a circuit breaker/fused disconnect. Consult applicable national and local code requirements to determine the rating of the breaker/disconnect. Electrical specifications are listed on the toaster's serial plate and in the Specifications section of this Manual.
 - The toaster's power cord and plug provide an electrical ground connection. A separate equipotential ground connection must also be made if required by national or local codes. The location of the equipotential ground lug is shown in Figure 3.
 - Consult all applicable national and local codes for further electrical connection requirements.
1. Before proceeding with the electrical connection, check that the electrical supply matches the toaster's requirements. Refer to the serial plate and to the Specifications section of this Manual.

 **WARNING**
ENSURE THAT BOTH THE CIRCUIT BREAKER/FUSED DISCONNECT AND THE  SWITCH ARE IN THE "O" (OFF) POSITION BEFORE PROCEEDING.



 **WARNING**
ENSURE THAT ANY PACKING MATERIAL RESIDUE HAS BEEN REMOVED FROM INSIDE THE TOASTING CHAMBER.

Figure 3 - Equipotential Ground Connection





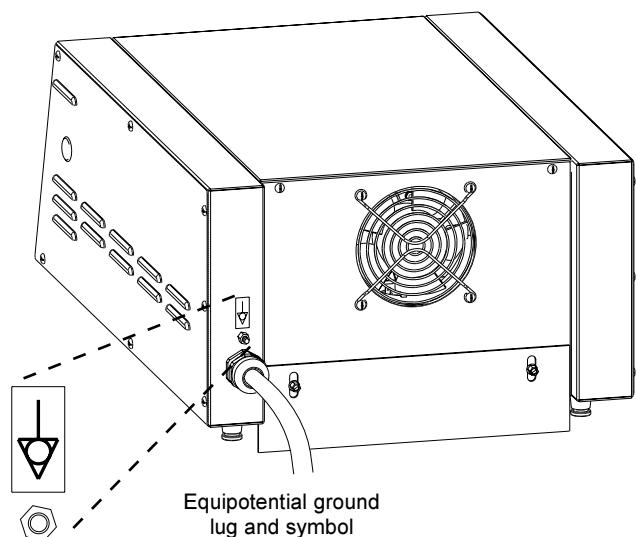

2. Check that the appropriate receptacle is available for the power cord plug.
3. Insert the power cord plug into its receptacle.
4. If required by national or local codes, connect an equipotential ground wire to the lug next to the  symbol (shown in Figure 3). The equipotential ground connection must meet all applicable national and local code requirements.

Checking the Installation

1. Check that the toaster is properly connected to the electrical power supply.
2. Switch the circuit breaker/fused disconnect to the ON ("I") position.
3. Switch the  switch to the ON ("I") position. The display will flash **Lo** as the toaster pre-heats.
4. Allow the toaster to pre-heat for 15 minutes, until **rdy** appears in the display.

 **CAUTION - HOT SURFACES**
USE CAUTION TO AVOID INJURY.

5. Look inside the toasting chamber and visually check that the heating elements are heating and glowing red.
6. Push and hold the  key for 2 seconds.
7. Push the  key.
8. Check that the digital timer begins counting down.
9. Wait for the preset time to elapse. The control should sound an alarm as follows:
 - The control will beep 5 times at 1-second intervals.
 - Next, the control will beep very rapidly for another 5 seconds.
 - Next, the control will sound a steady tone.
10. Press the  key. The timer will reset, and the steady tone will shut off.
11. Switch the  switch to the OFF ("O") position. The fan will remain in operation to allow the toaster to cool.
12. After the fan stops, switch the circuit breaker/fused disconnect to the OFF ("O") position.



SET-UP, OPERATION, AND CLOSE PROCEDURES





CAUTION - HOT SURFACES

DURING OPERATION, THE PEEL AND TOASTER ARE HOT. USE CAUTION AS YOU HANDLE THE PEEL AND OPERATE THE TOASTER TO AVOID INJURY.

Setup



1. Replace the lower deck inside the toaster.
2. Switch the circuit breaker/fused disconnect to the ON ("I") position.
3. Switch the  switch to the ON ("I") position. The display will flash  as the toaster pre-heats.

IMPORTANT

If electrical power to the toaster is briefly interrupted, hold down the  and  keys while switching the  switch to the ON ("I") position. This bypasses the normal 15 minute pre-heat period. If the pre-heat period is bypassed while the toaster is cool, toasting will be inconsistent.

4. Allow the toaster to pre-heat for 15 minutes. When the toaster has finished pre-heating,  (ready) will appear in the display. The toaster is now ready for normal operation.

Operation

1. Push and hold the appropriate  key (Program Key) for 2 seconds, until the control beeps once. The green light above the  key will illuminate to show that the program has been selected.
2. Load the bakery product onto the peel, with the cut side facing UP.
3. Pull the door handle forward to open the door.
4. Slide the peel into the toaster to load the product.
5. Release the door handle to allow the door to close.
6. During toasting, the peel can either be left inside the toaster, or removed, as you prefer. If you wish to remove the peel, slide it out of the toaster while holding the door handle in the closed position. The closed door will hold the bakery product inside the toasting chamber.

7. Push the  key. The digital timer will begin counting down.

8. Wait for the preset time to elapse. The control will beep 5 times at 1-second intervals when the preset time reaches , and the display will flash to show that the end of the preset time has been reached.

9. Push the  key.

10. Pull the door handle forward to open the door.

11. If you removed the peel in Step 6, insert it into the toaster and underneath the bakery product.

12. Remove the peel (now holding the bakery product) from the toaster.

CAUTION

*When the preset time elapses, the bakery product is correctly toasted. **Leaving the product inside the toaster after the first beep sounds will begin to burn the bakery product.** The following alerts will sound if the product is left inside the toaster:*

- *The control will beep 5 times as described above. The product is correctly toasted when the first beep sounds.*
- *Next, the control will beep very rapidly for another 5 seconds.*
- *Next, the control will sound a continuous tone until the  key is pressed and the product is removed.*

Always remove the product promptly when the first beep sounds!

13. Remove the bakery product from the peel.

14. Proceed as follows:

- If you will be toasting another batch of the same bakery product, go back to Step 2.
- If you will be toasting another type of bakery product, go back to Step 1.
- During idle periods, store the peel in a clean, dry location underneath the toaster.

Figure 4 - Control Panel Functions: Operating Mode

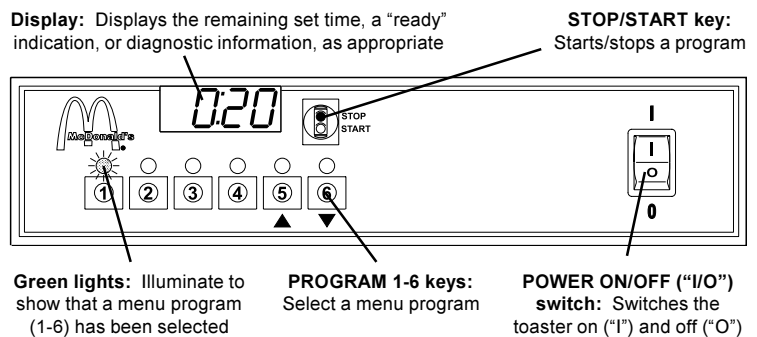

Programming





The Batch Toaster is pre-programmed with standard menu programs at the factory. Perform the following steps **ONLY** if you wish to change a program's settings.

IMPORTANT

*Programming a new menu program will **OVERWRITE** an existing program. Do not overwrite a program that you wish to keep!*

Refer to Figure 5 for an illustration of the controls used to program a menu selection.

1. Select a Program to Change

- Push and hold the appropriate  key. After 2 seconds, the control will beep once, showing that the program has been selected. **DO NOT RELEASE THE KEY AT THIS TIME.**
- Continue to hold the  key until the control beeps twice and the display shows . Release the key. The "P" shows that programming mode is now active, and "#:##" is the currently-programmed set time. The green light above the  key will also flash to inform you which program will be changed.

2. Adjust the Set Time and Relays

NOTE



The toaster regulates heat through three relays. Each relay controls four of the twelve heating elements. Switching the relay on or off will also switch the four heating elements on or off. This allows the operator to adjust the toasting temperature.



Setting the relays to different on/off combinations for different menu programs allows the toaster to accommodate a variety of toasting temperatures.

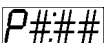

Refer to the electrical wiring diagram at the back of this Manual for a listing of the heating elements that are controlled by each relay.

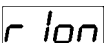
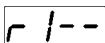

When programming mode is active, push the  key to toggle the display between the following settings:

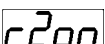
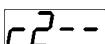
- 

"#:##" is the currently-programmed set time. When this display is shown, the set time can be adjusted using the  and  keys.
-  or 

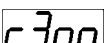
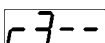
Shows whether Relay 1 (and the heating elements that it controls) is currently on ("on") or off ("--"). When this display is shown, Relay 1 can be toggled on or off as desired with the  or  keys.
-  or 

Displays the current setting for Relay 2 (and the heating elements that it controls). This setting can be changed as desired with the  or  keys.
-  or 

Displays the current setting for Relay 3 (and the heating elements that it controls). This setting can be changed as desired with the  or  keys.

If necessary, you can continue to press the  key to repeat the cycle.

3. Save Changes and Return to Operating Mode





When your changes are complete, press the  key to save the changes. The toaster will return to normal operating mode. Access the new program by pressing the appropriate  key.

Figure 5 - Control Panel Functions: Programming Mode

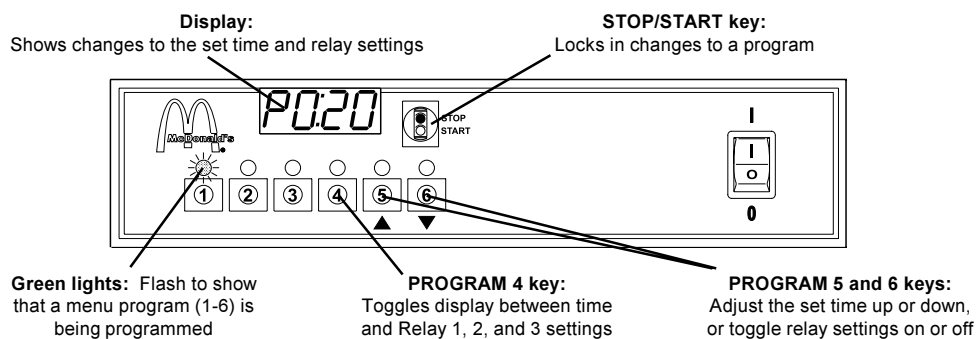

Close

1. Switch the  switch to the OFF ("O") position. The fan will remain in operation to allow the toaster to cool.
2. After the fan stops, switch the circuit breaker/fused disconnect to the OFF ("O") position.
3. *Cleaning the Peel and Lower Deck*



CAUTION - HOT SURFACES

DO NOT TOUCH HOT SURFACES ON THE TOASTER. DO NOT REACH INTO THE TOASTING CHAMBER UNTIL THE UNIT HAS COOLED THOROUGHLY.

- a. Remove the lower deck from inside the toaster. To remove the lower deck:
 - Pull the door handle forward to open the door.
 - Lift the front edge of the lower deck, and then pull it forward and out of the toaster. See Figure 6.
 - Release the door handle.
- b. Wash the peel and the lower deck using a hot solution of **McD All Purpose Concentrate (APC) (HCS)**. If necessary, scrub these components using a McD No Scratch Pad to remove discolorations.
- c. Rinse the peel and lower deck thoroughly.
- d. Immerse the peel and lower deck in **McD Sink Sanitizer Solution (HCS)**. Use 1 pack of solution for 10 gallons of water.
- e. Remove the parts from the sanitizer solution, and allow them to air dry.

Figure 6 - Removing the Lower Deck

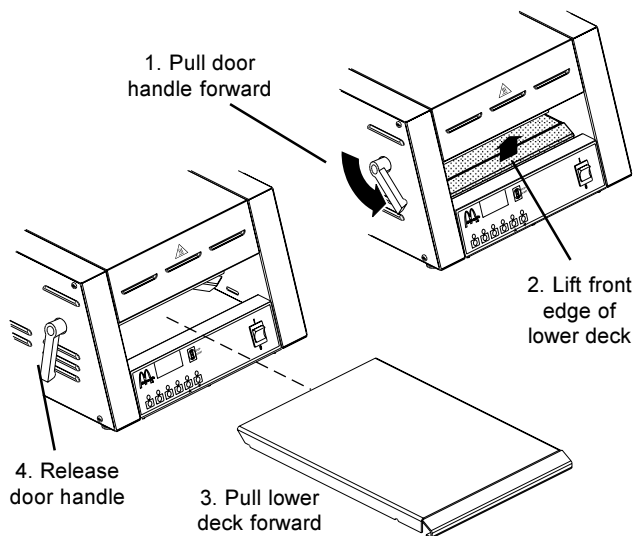

4. Cleaning the Toaster



WARNING

WHEN CLEANING THE TOASTER, NEVER APPLY ENOUGH LIQUID TO STAND IN PLACE ON THE UNIT. DO NOT SPRAY, RINSE, OR SUBMERGE THE TOASTER. EXCESSIVE MOISTURE IN THE UNIT WILL CAUSE A SEVERE ELECTRICAL HAZARD AND MAY OTHERWISE DAMAGE THE TOASTER.

CAUTION

DO NOT clean your toaster using abrasive cleaners or pads. Both will scratch and dull the finish.

- a. Thoroughly clean the fan (on the back wall of the toaster) using a stiff nylon brush. See Figure 7.

CAUTION





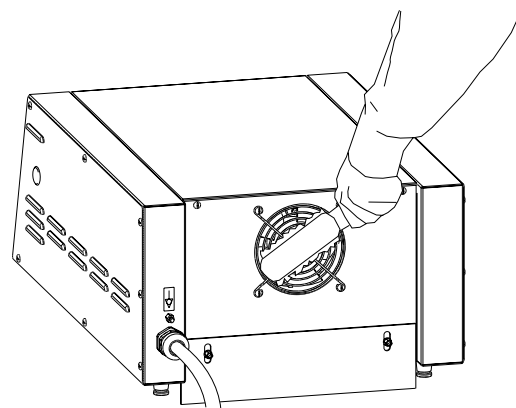

The fan must be cleaned regularly. If the fan is blocked or plugged, bakery products will not be properly toasted and the toaster's interior components may be damaged.

- b. Wipe the exterior of the toaster with a clean, sanitized towel dampened with a hot solution of **McD All Purpose Concentrate (APC) (HCS)**, as drawn from the sink proportioner.
 - c. Wipe the exterior of the toaster with a clean, sanitized towel dampened in water to remove any residual foreign material or cleaning solution. Ensure that all visible moisture has been removed from the unit.
 - d. Allow the exterior of the toaster to air dry.
5. Replace the lower deck inside the toaster.
 6. Store the peel in a clean, dry location underneath the toaster.
 7. Pull the door handle forward to open the door. Check that the back side of the door is slippery to the touch. If necessary, apply a thin coating of **McD Bun Toaster Release Agent (HCS)** to the back side of the door using a paper towel.

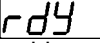
Figure 7 - Cleaning the Fan



TROUBLESHOOTING

PROBLEM	PROBABLE CAUSE	CORRECTIVE ACTION
<i>Product is toasted too dark or too light.</i>	Toaster was not adequately preheated.	Allow toaster to preheat until  (ready) appears in the display. This should occur about 15 minutes after electrical power is restored to the toaster.
	Preset toasting time is incorrect.	Enter Programming Mode to increase or decrease the toasting time as necessary. Refer to the <u>Programming</u> section of this Manual.
	Using refrigerated or frozen bakery products.	Bakery products must be at room temperature BEFORE toasting for consistent results. Allow a 2-day-old rotation when using fresh bakery products.
<i>Bakery product is jammed in toaster.</i>	Loading is excessive. OR Product is loaded incorrectly. OR Carbonized deposits on lower deck are sticking to the bakery product.	Switch the  switch to the OFF ("O") position. Wait for the fan to stop operating. Then, switch the circuit breaker/fused disconnect to the OFF ("O") position and allow the toaster to cool. Next, carefully clear the jam using a long object as a probe. The probe should preferably be made of wood, which is less likely to damage the heating elements. <div style="margin-top: 10px;">  WARNING <i>NEVER USE A PLASTIC OR METAL OBJECT AS A PROBE TO CLEAR A JAM.</i> </div> <div style="margin-top: 10px;">  WARNING <i>DO NOT INSERT THE HANDS INTO THE TOASTING CHAMBER TO CLEAR A JAM. IF THE UNIT HAS NOT COMPLETELY COOLED, SEVERE INJURY MAY RESULT.</i> </div> After clearing a jam, thoroughly clean the peel and the lower deck before resuming operation. Refer to <u>Cleaning the Peel and Lower Deck</u> in this Manual.
<i>Toaster overheats and shuts down.</i>	Cooling fan is dirty or inoperative.	Switch the  switch to the OFF ("O") position. Wait for the fan to stop operating. Then, switch the circuit breaker/fused disconnect to the OFF ("O") position and allow the toaster to cool. Thoroughly clean the fan before resuming operation. Refer to <u>Cleaning the Toaster</u> in this Manual.
	High Limit system has activated, shutting down the toaster.	Switch the  switch to the OFF ("O") position. Wait for the fan to stop operating. Then, switch the circuit breaker/fused disconnect to the OFF ("O") position and allow the toaster to cool. Restart the toaster, following the procedure in the <u>Set-up, Operation, and Close Procedures</u> section.

If the problem persists, or is not described above, contact your Authorized Service Agent.

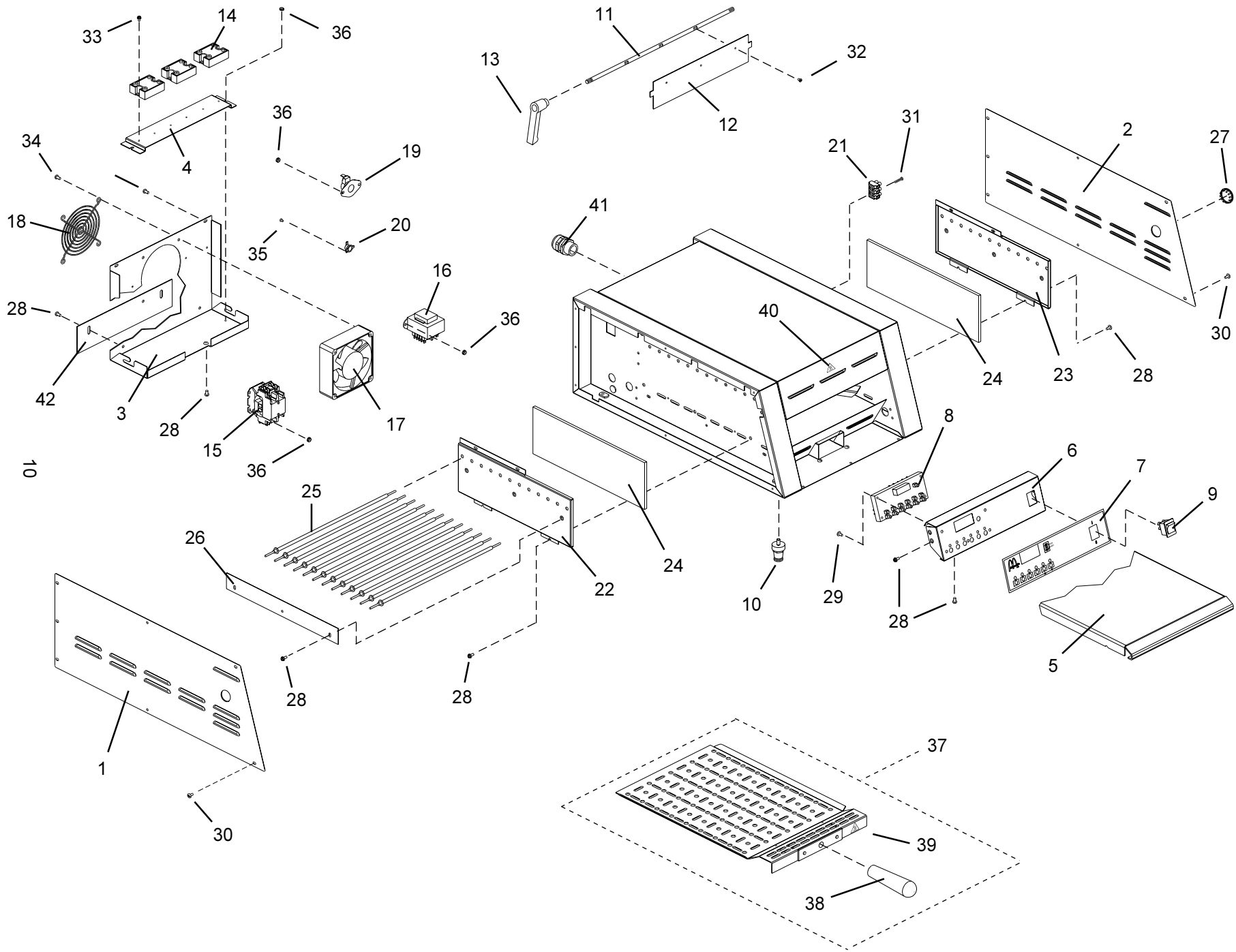

PARTS IDENTIFICATION AND FUNCTION

Parts List

AS SHOWN ON THE PREVIOUS PAGE:

<i>Item</i>	<i>Part No.</i>	<i>Qty.</i>	<i>Description</i>
1	41706	1	PANEL, LEFT SIDE
2	39806	1	PANEL, RIGHT SIDE
3	32458	1	PANEL, REAR
4	41902	1	PANEL, SSR MOUNTING
5	39804	1	LOWER DECK
6	42482	1	CONTROL PANEL
7	41837	1	DECAL, CONTROL PANEL
8	41733	1	TIMER BOARD
9	35824	1	SWITCH, POWER ON/OFF 2-POLE
10	43161	4	LEG, 1-1/2" (38mm)
11	41805	1	HINGE, DOOR
12	41806	1	DOOR
13	41807	1	HANDLE, DOOR, WITH 5/32"/4mm ALLEN SET SCREW
14a	42902	3	RELAY, TELEDYNE, SOLID STATE 240V 25A
14b	38469	3	RELAY, CROUZET, SOLID STATE 240V 25A
15	3000639	1	CONTACTOR
16	41872	1	TRANSFORMER, 230Vp : 24Vs
17	97525	1	FAN, 230V
18	27470-0004	1	FAN GRILLE
19	30519	1	HIGH LIMIT THERMOSTAT, NORMAL CLOSED - 250°F/121°C
20	38079	1	COOLDOWN THERMOSTAT, NORMAL OPEN - 120°F/49°C
21	33406	1	TERMINAL BLOCK, 3-POLE
22	41879	1	PANEL, INSULATION COVER, LEFT

<i>Item</i>	<i>Part No.</i>	<i>Qty.</i>	<i>Description</i>
23	41840	1	PANEL, INSULATION COVER, RIGHT
24	41921	2	INSULATION, PRE-CUT
25a	41771	12	HEATING ELEMENT, 208V TOASTERS - 104V/204W
25b	41842	12	HEATING ELEMENT, 230V TOASTERS - 115V/204W
26	41841	1	RETAINER PANEL, HEATERS
27	34753	1	PLUG, METAL, 1"/25mm DIA.
28	3B20A8801	A/R	SCR, HWH #8-32 X 3/8"
29	B301A8827	A/R	SCR, PANHD #6-32 X 1/4"
30	2000105	A/R	SCR, SLT TRSHD #8-32 X 3/8"
31	1411D8805	A/R	SCR, PANHD #6-32 X 3/4"
32	220210	A/R	SCR, SLT PANHD #6-32 X 1/4" BLACK
33	2000023	A/R	SCR, SLT HWH #6-32 X 1/4"
34	4005A8801	A/R	SCR, PHIL PANHD #10-32 X 3/8"
35	K1DS195	A/R	SCR, SLT PANHD #5-40 X 1/4"
36	2001327	A/R	HEX NUT, KEPS #6-32
37	42456	1	ASSEMBLY, PEEL (inc. Items 38-39)
38	41698	1	HANDLE, PEEL
39a	42950	1	LABEL, INTERNATIONAL CAUTION-HOT SYMBOL
39b	1112B8303	1	LABEL, ENGLISH "CAUTION-HOT"
40a	42950	1	LABEL, INTERNATIONAL CAUTION-HOT SYMBOL
40b	1112B8303	1	LABEL, ENGLISH "CAUTION-HOT"
41	36440	1	STRAIN RELIEF, CORD/PLUG SET
42	43339	1	REAR HEAT CURTAIN

NOT SHOWN:

<i>Item</i>	<i>Part No.</i>	<i>Qty.</i>	<i>Description</i>
43a	30640	1	CORD/PLUG SET, USA & STD. EXPORT, WITH 30A PIN-AND-SLEEVE PLUG
43b	31974	1	CORD/PLUG SET, USA & STD. EXPORT, WITH 30A TWIST-LOCK PLUG
43c	30641	1	CORD/PLUG SET, EUROPE, WITH 32A PIN-AND-SLEEVE PLUG
43d	31998	1	CORD/PLUG SET, EUROPE (Germany only), WITH 16A PIN-AND-SLEEVE PLUG
43e	31973	1	CORD/PLUG SET, EUROPE, WITH 30A TWIST-LOCK PLUG
44	42997	1	ALLEN KEY, 5/32" (4mm)
45	43005	1	CAPACITOR, 250VAC, 1µF (European MBT240 only)

<i>Item</i>	<i>Part No.</i>	<i>Qty.</i>	<i>Description</i>
46	43006	1	RESISTOR, 470k OHMS, 0.5W (European MBT240 only)
47	39205	1	FUSE, 0.25A
48	27159-0003	1	CORDSET, COOLING FAN
49	42497	1	WIRESET, MBT TOASTER
50a	43084	1	MANUAL ASSEMBLY, ENGLISH (includes Equipment Manual, PM Card and Quick Reference Sheet)
50b	43162	1	MANUAL ASSEMBLY, GERMAN
50c	43238	1	MANUAL ASSEMBLY, FRENCH
50d	43239	1	MANUAL ASSEMBLY, SPANISH
50e	43240	1	MANUAL ASSEMBLY, MANDARIN
51	1002040	1	TOASTMASTER AUTHORIZED SERVICE AGENCY LISTING

ORDERING AND SERVICE INFORMATION

IMPORTANT

You Batch Toaster comes with a warranty from Toastmaster. Terms and conditions of this warranty are described on the front cover of this Manual. During this warranty period, all parts replacement and servicing should be performed by your Toastmaster Authorized Service Agent. A service agency listing is supplied with your toaster. Service that is performed by parties other than your Toastmaster Authorized Service Agent will void your toaster's warranty.

Toaster Information

IMPORTANT

Record the following toaster information for easy access when ordering parts and service for your toaster. The serial number of your toaster is stamped on the serial plate, located on the back panel.

Manufacturer: **Toastmaster®** Authorized Service Agent: _____
Model Number: MBT_____ Batch Toaster Address: _____
Serial Number: _____
Delivery Date: _____ / _____ / _____ Phone: _____

Ordering Parts

Use only genuine Toastmaster (manufacturer) replacement parts in your toaster. Use of parts other than those supplied or approved by Toastmaster will void the toaster's warranty and agency approval.

If your toaster requires a replacement part, locate the part in the drawing in the Parts Identification and Function section of this Manual. Then, find the part number and description in the parts list.

Parts orders should be placed with your Toastmaster Authorized Service Agency. The agency has a current parts price list, and can inform you of the cost of your order. Please have the following information ready when you call:

- Toaster information (above)
- Number and description of part(s) required (list below for easy reference)

Return Policy

An RGA number (Return Goods Authorization) must be obtained from Toastmaster before returning a product. All shipping charges must be prepaid by the buyer. Returned goods are subject to Toastmaster's inspection and acceptance.

Requesting Service

If technical help is needed, or if your toaster requires professional servicing, contact your Toastmaster Authorized Service Agency. Please have the following information ready when you call:

- Toaster information (above)
- List of problems experienced with toaster (list below for easy reference)

P/N	DESCRIPTION
_____	_____
_____	_____
_____	_____
_____	_____
_____	_____
_____	_____

P/N	DESCRIPTION
_____	_____
_____	_____
_____	_____
_____	_____
_____	_____
_____	_____

NOTES

ELECTRICAL WIRING DIAGRAM

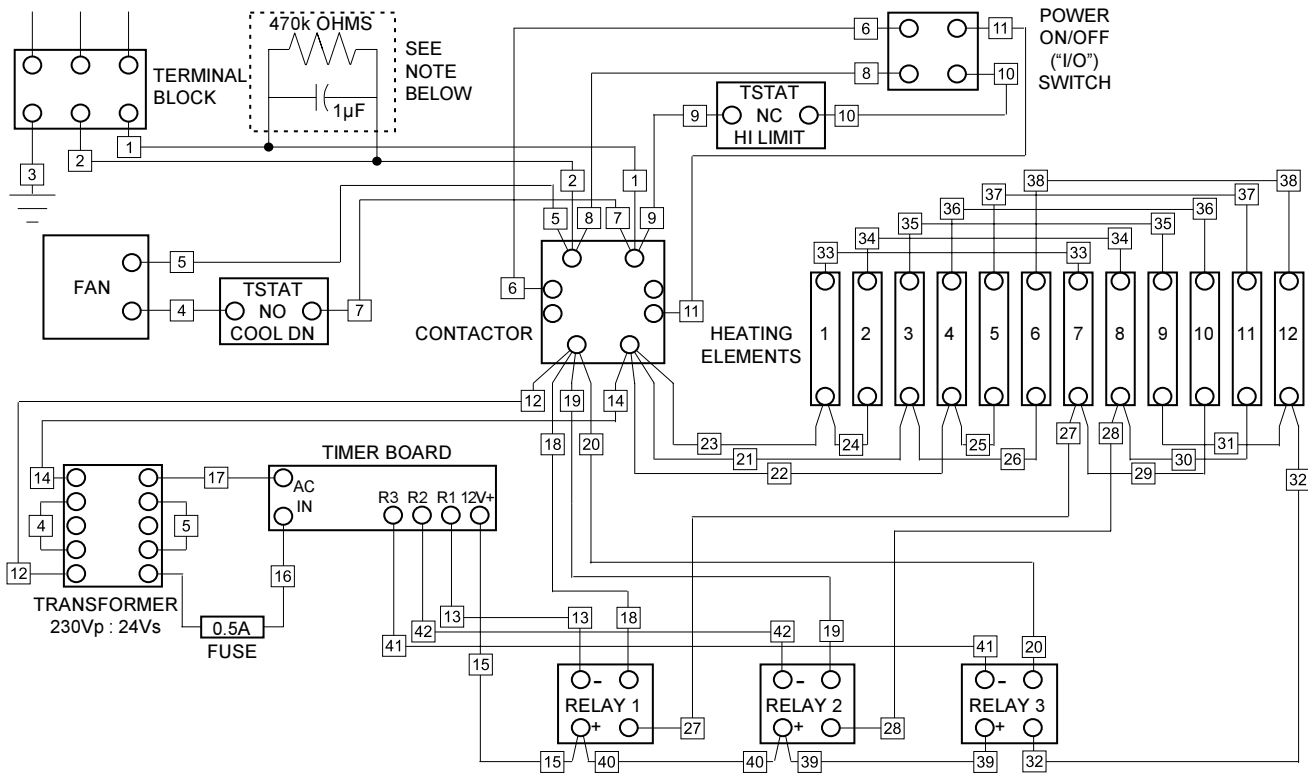

Wiring Diagram Notes:

- Capacitor and resistor inside dashed box are used ONLY on European MBT240
- Heating elements are numbered back-to-front
- Relay 1 powers elements 1, 4, 7, and 10
- Relay 2 controls elements 2, 5, 8, and 11
- Relay 3 controls elements 3, 6, 9, and 12

ELECTRICAL SCHEMATIC

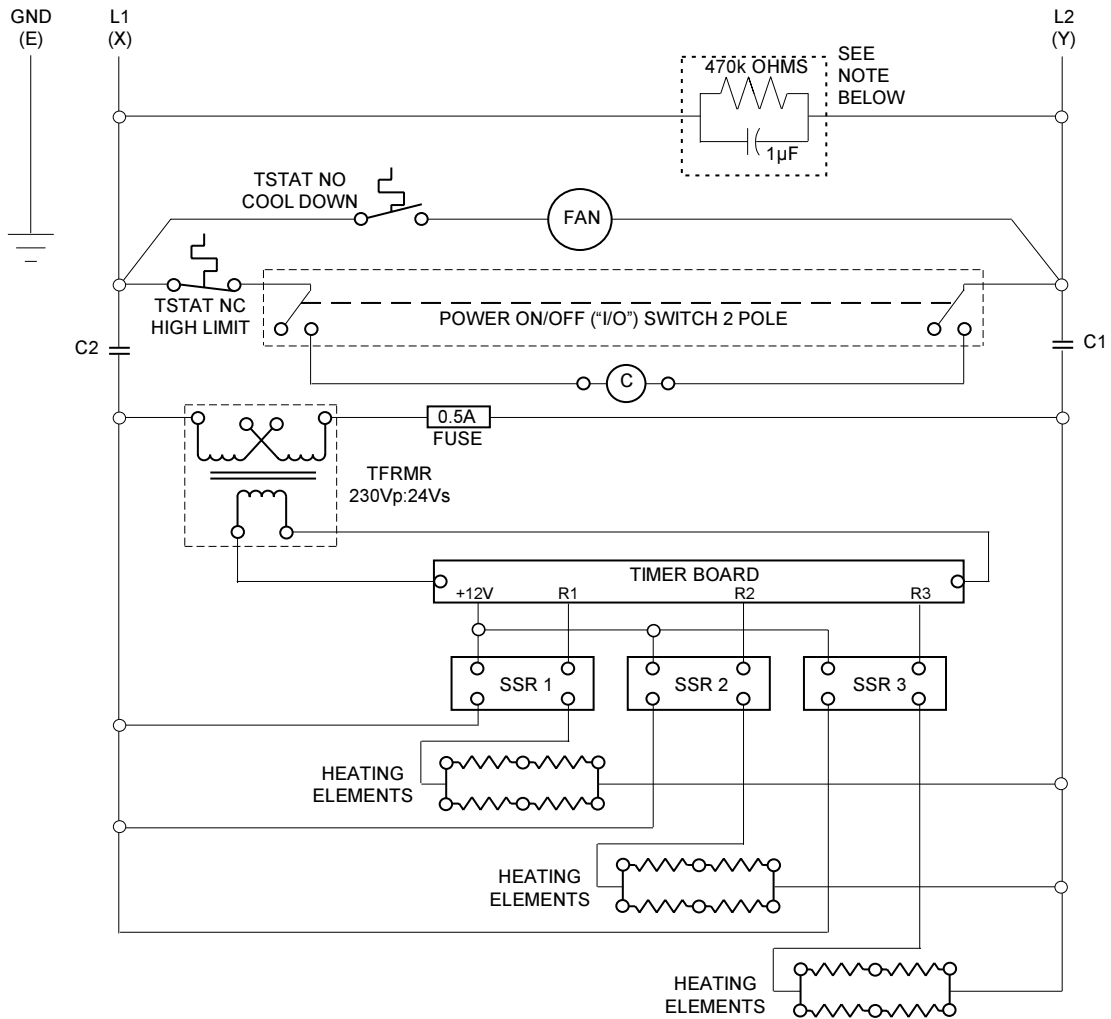

Schematic Notes:

- Capacitor and resistor inside dashed box are used ONLY on European MBT240



Toastmaster • 1400 Toastmaster Drive • Elgin, IL 60120 • USA • (847)741-3300 • FAX (847)741-4406
Middleby Corp 24-Hour Service Hotline 1-800-238-8444

www.middleby.com



Free Manuals Download Website

<http://myh66.com>

<http://usermanuals.us>

<http://www.somanuals.com>

<http://www.4manuals.cc>

<http://www.manual-lib.com>

<http://www.404manual.com>

<http://www.luxmanual.com>

<http://aubethermostatmanual.com>

Golf course search by state

<http://golfingnear.com>

Email search by domain

<http://emailbydomain.com>

Auto manuals search

<http://auto.somanuals.com>

TV manuals search

<http://tv.somanuals.com>