

# TOPCOM<sup>®</sup>

## BUTLER 5710



**User guide / Handleiding / Manuel d'utilisateur / Bedienungsanleitung /  
Manual de usuario / Bruksanvisning / Brugervejledning /  
Användarhandbok / Käyttöohje / Οδηγίες Χρήσης**

**v 1.2**



### **Important**

To use 'Caller ID' (display caller), this service has to be activated on your phone line. Normally you need a separate subscription from your telephone company to activate this function. If you don't have the Caller ID function on your phone line, the incoming telephone numbers will NOT be shown on the display of your telephone.

### **Belangrijk**

Om de 'Nummerweergave' te kunnen gebruiken, moet deze dienst geactiveerd zijn op uw telefoonlijn. Om deze dienst te activeren, hebt U hiervoor meestal een apart abonnement van uw telefoonmaatschappij nodig.

Indien U geen nummerweergavefunctie hebt op uw telefoonlijn, zullen de inkomende telefoonnummers NIET op de display van uw toestel verschijnen.

### **Important**

Pour utiliser la fonction 'Caller ID/Clip' (affichage de l'appelant), ce service doit être activé sur votre ligne téléphonique. Généralement, vous avez besoin d'un abonnement séparé de votre compagnie de téléphone pour activer cette fonction. Si vous n'avez pas la fonction 'Caller ID - Affichage Appelant' sur votre ligne téléphonique, les numéros de téléphone entrants n'apparaîtront PAS sur l'écran de votre téléphone.

### **Wichtig**

Zur Verwendung der 'Rufnummernanzeige' muss dieser Dienst erst für Ihre Telefonleitung freigegeben werden. Zur Aktivierung dieser Dienstleistung benötigen Sie meistens ein separates Abonnement Ihrer Telefongesellschaft. Wenn Sie für Ihre Telefonleitung keine Rufnummernanzeigefunktion haben, erscheinen die eingehenden Telefonnummern NICHT im Display Ihres Gerätes.

### **Importante**

Para poder usar la función "Identificación de llamadas, este servicio tiene que estar dado de alta en su línea telefónica. Normalmente es necesario abonarse a dicho servicio para que la compañía telefónica active esta función. Si su línea telefónica no dispone de la función Identificación de llamadas, la pantalla del aparato no mostrará los números de teléfono de las llamadas entrantes.

### **Viktigt**

För att använda funktionen "nummervisning" måste tjänsten vara aktiverad för din telefonlinje. Normalt behöver du ett separat abonnemang från ditt telefonbolag för att kunna aktivera funktionen. Om nummervisningsfunktionen inte finns för din telefonlinje kommer inkommande telefonnummer INTE visas på din telefons display.

### **Vigtigt**

For at kunne anvende "Caller ID" (gengivelse af opkalderens nummer) skal denne tjeneste først aktiveres på Deres telefonlinie. For at aktivere denne tjeneste har De normalt brug for et separat abonnementet fra Deres telefonselskab. Hvis De ikke råder over en Caller ID-anordning på Deres telefonlinie, vises opkalderens telefonnummer IKKE på displayet på Deres apparat.

### **Viktig**

Før du kan bruke funksjonen "Hvem ringer" må denne service aktiveres på din telefonlinje. Kontakt din teleoperatør for å abonnere på "Hvem ringer". Dersom du ikke har funksjonen "Hvem ringer" på di n telefonlinje, vil IKKE telefonnummeret til anropet som kommer inn vises på skjermen.

### **Tärkeää**

Voidaksesi käyttää soittajan numeron näyttötoimintoa (Caller ID), tämä palvelu on aktivoitava puhelinlinjaasi. Yleensä se on tilattava erikseen puhelinyhtiöltä ennen kuin toimintoa voidaan käyttää. Ellei sinulla ole soittajan numeron näyttötoimintoa puhelinlinjassasi, soittajan numero ei näy puhelimen näytössä.

### **Σημαντικό**

Για να χρησιμοποιήσετε την υπηρεσία αναγνώρισης κλήσεων, πρέπει η υπηρεσία αυτή να έχει ενεργοποιηθεί στην τηλεφωνική γραμμή σας. Για να ενεργοποιήσετε αυτή τη λειτουργία πρέπει κανονικά να εγγραφείτε ξεχωριστά στην εταιρία παροχής τηλεφωνικών υπηρεσιών σας. Εάν δεν έχετε ενεργοποιήσει στη γραμμή σας την υπηρεσία αναγνώρισης κλήσεων, ΔΕ θα εμφανίζονται οι αριθμοί των εισερχόμενων κλήσεων στην οθόνη του τηλεφώνου σας.

- UK To be connected to the public analogue telephone network.
- NL Geschikt voor aansluiting op het openbare analoog geschakelde telefoonnetwerk.
- FR Il est destiné à être raccordé au réseau de télécommunication public.
- DE Kompatibel für den analogen telefonanschluss.
- ES Conexión a la red telefónica analógica.
- SE För anslutning til det analoga nätverket.
- DK Tilsluttes til det analoge telefonfastnet.
- NO Tilkoples analog telefon nettverk.
- FI Liitetään yleiseen analogiseen puhelinverkkoon.
- GR Πρέπει να συνδεθεί σε ένα δημόσιο αναλογικό τηλεφωνικό δίκτυο.

- UK The features described in this manual are published with reservation to modifications.
- NL De in deze handleiding beschreven mogelijkheden worden gepubliceerd onder voorbehoud van wijzigingen.
- FR Les possibilités décrites dans ce manuel sont publiées sous réserve de modifications.
- DE Die in dieser Bedienungsanleitung umschriebenen Möglichkeiten, werden vorbehaltlich Änderungen publiziert.
- ES Las características descritas en este manual pueden ser objeto de futuras modificaciones.
- SE Funktionerna i denna bruksanvisning publiceras med reservation för ändringar.
- DK Vi forbeholder os retten til ændringer af de specifikationer, der er beskrevet i denne brugsanvisning.
- NO Funksjoner beskrevet i denne manualen kan endres uten nærmere informasjon.
- FI Tässä ohjekirjassa julkaissut tiedot voivat muuttua ilman ennakoilmoitusta.
- GR Οι λειτουργίες που περιγράφονται στο παρόν εγχειρίδιο, δημοσιεύονται με επιφύλαξη τυχόν τροποποιήσεων.

This product is in compliance with the essential requirements and other relevant provisions of the R&TTE directive 1999/5/EC.

The Declaration of conformity can be found on:

**<http://www.topcom.net/support/cedeclarations.php>**

- UK The CE symbol indicates that the unit complies with the essential requirements of the R&TTE directive.
- NL Het toestel voldoet aan de basiseisen van de R&TTE-richtlijn. Dit wordt bevestigd door de CE-markering.
- FR La conformité de l'appareil avec les exigences fondamentales de la directive européenne R&TTE relative aux terminaux, est confirmée par le label CE.
- DE Die Übereinstimmung des Gerätes mit den grundlegenden Anforderungen der R&TTE-Directive ist durch das CE-Kennzeichen bestätigt.
- ES El sello CE corrobora la conformidad del equipo con los requerimientos básicos de la directiva R&TTE.
- SE CE-märket bekräftar att apparaten uppfyller de grundläggande kraven i R&TTE direktivet.
- DK CE-mærkningen bekræfter, at produktet er i overensstemmelse med kravene i Rådets teleterminaldirektiv.
- NO CE-merkingen dokumenterer at apparatet er i samsvar med de grunnleggende kravene til EU-direktivet for aktivt telekommunikasjonsutstyr.
- FI Laite noudattaa R&TTE-direktiivin vaatimuksia, mikä on vahvistettu CE-merkillä.
- GR Οι λειτουργίες που περιγράφονται στο παρόν εγχειρίδιο, δημοσιεύονται με επιφύλαξη τυχόν τροποποιήσεων.

# English ..... 1

<b>1</b>	<b>Safety instructions</b> .....	<b>1</b>
<b>2</b>	<b>Getting started</b> .....	<b>1</b>
2.1	How to use this user guide.....	1
2.2	Installing the base .....	1
2.3	Installing the handset.....	2
2.4	Keys/Led.....	3
2.5	Symbols .....	3
2.6	Display keys .....	4
2.7	Base LED.....	4
2.8	Navigating the menu.....	4
2.9	Menu overview.....	5
<b>3</b>	<b>Using the telephone</b> .....	<b>5</b>
3.1	Switching the handset ON/OFF.....	5
3.2	Changing the menu language .....	5
3.3	Making a normal telephone call .....	6
3.4	Receiving a telephone call.....	6
3.5	Handsfree mode.....	7
3.6	Adjust earpiece/handsfree volume .....	7
3.7	Secrecy function (Mute function).....	7
3.8	Locating a handset (Paging function).....	7
3.9	Keypad Lock .....	7
3.10	Using the alphanumerical keypad .....	7
<b>4</b>	<b>Phonebook</b> .....	<b>8</b>
4.1	To add an entry .....	8
4.2	To dial an entry.....	8
4.3	Show Details.....	8
4.4	Delete an entry or all entries.....	9
4.5	Edit name and number .....	9
4.6	Copy a phonebook entry to another handset .....	9
4.7	Copy all phonebook entries to another handset.....	10
<b>5</b>	<b>Caller Identification</b> .....	<b>10</b>
5.1	Normal incoming PSTN calls.....	10
<b>6</b>	<b>Personalise the handset</b> .....	<b>11</b>
6.1	Ringtone and volume.....	11
6.2	Handset name .....	12
6.3	Keypad beeps.....	12
6.4	Setting the contrast .....	12
6.5	Autotalk .....	12
6.6	Prefix code.....	12
6.7	Using the alarm feature .....	13
6.8	Setting the date and time .....	13
6.9	Setting the time format .....	13
<b>7</b>	<b>Base settings</b> .....	<b>14</b>
7.1	Ringtone .....	14
7.2	Ringer Volume .....	14
7.3	Dial Mode.....	14
7.4	Recall (Flash).....	14
7.5	System PIN.....	15
<b>8</b>	<b>Tools</b> .....	<b>15</b>
8.1	Appointment.....	15

8.2	Stopwatch .....	15
<b>9</b>	<b>Additional handsets and base stations .....</b>	<b>16</b>
9.1	Adding a new handset .....	16
9.2	Removing a handset .....	16
9.3	Select a base .....	17
9.4	Using the intercom feature .....	17
<b>10</b>	<b>Troubleshooting .....</b>	<b>18</b>
<b>11</b>	<b>Technical data/Technical characteristics .....</b>	<b>18</b>
<b>12</b>	<b>Warranty .....</b>	<b>19</b>
12.1	Warranty period .....	19
12.2	Warranty handling .....	19
12.3	Warranty exclusions .....	19
<b>13</b>	<b>Disposal of the device (environment) .....</b>	<b>20</b>
<b>14</b>	<b>Cleaning .....</b>	<b>20</b>
<b>15</b>	<b>ECO (low-radiation) mode .....</b>	<b>20</b>

## **Nederlands .....**

<b>1</b>	<b>Veiligheidsinstructies .....</b>	<b>21</b>
<b>2</b>	<b>Beginnen .....</b>	<b>21</b>
2.1	Deze gebruikshandleiding gebruiken .....	21
2.2	De basis installeren .....	21
2.3	De handset installeren .....	22
2.4	Toetsen/LED .....	23
2.5	Symbolen .....	23
2.6	Displaytoetsen .....	24
2.7	Basis-LED .....	24
2.8	Door het menu bladeren .....	24
2.9	Menuoverzicht .....	25
<b>3</b>	<b>De telefoon gebruiken .....</b>	<b>25</b>
3.1	De handset in- en uitschakelen .....	25
3.2	De menutaal veranderen .....	25
3.3	Een normaal telefoongesprek voeren .....	26
3.4	Een telefoontje ontvangen .....	26
3.5	Handenvrij-modus .....	27
3.6	Oorstuk/handenvrij-volume afstellen .....	27
3.7	Geheimhoudingsfunctie (Microfoon uit-functie) .....	27
3.8	Een handset vinden (Paging-functie) .....	27
3.9	Toetsenbordvergrendeling .....	27
3.10	Het alfanumerieke toetsenbord gebruiken .....	27
<b>4</b>	<b>Telefoonboek .....</b>	<b>28</b>
4.1	Een invoer toevoegen .....	28
4.2	Een invoer kiezen .....	28
4.3	Details tonen .....	28
4.4	Een invoer of alle invoeren wissen .....	29
4.5	Naam en nummer bewerken .....	29
4.6	Een telefoonboekinvoer naar een andere handset kopiëren .....	29
4.7	Alle telefoonboekinvoeren naar een andere handset kopiëren .....	30
<b>5</b>	<b>Nummerherkenning van oproeper .....</b>	<b>30</b>
5.1	Normale inkomende PSTN-oproepen .....	30
<b>6</b>	<b>De handset naar eigen wens instellen .....</b>	<b>31</b>

6.1	Beltoon en belvolume.....	31
6.2	Handset naam .....	32
6.3	Toetstoon .....	32
6.4	Het contrast instellen .....	32
6.5	Automatisch aannemen .....	32
6.6	Prefixcode.....	32
6.7	De alarmfunctie gebruiken .....	33
6.8	Dag en tijd instellen.....	33
6.9	Het tijdformaat instellen .....	33
<b>7</b>	<b>Basis instellingen .....</b>	<b>34</b>
7.1	Beltoon .....	34
7.2	Belvolume.....	34
7.3	Kiesmodus .....	34
7.4	Recall (Flash).....	34
7.5	Systeem PIN .....	35
<b>8</b>	<b>Hulpmiddelen.....</b>	<b>35</b>
8.1	Afspraak .....	35
8.2	Chronometer.....	35
<b>9</b>	<b>Extra handsets en basisstations .....</b>	<b>36</b>
9.1	Een nieuwe handset toevoegen.....	36
9.2	Een handset verwijderen.....	36
9.3	Een basis selecteren.....	37
9.4	De intercomfunctie gebruiken .....	37
<b>10</b>	<b>Probleemoplossing .....</b>	<b>38</b>
<b>11</b>	<b>Technische gegevens Technische eigenschappen .....</b>	<b>39</b>
<b>12</b>	<b>Garantie .....</b>	<b>39</b>
12.1	Garantieperiode .....	39
12.2	Afwikkeling van garantieclaims.....	39
12.3	Garantiebeperkingen.....	40
<b>13</b>	<b>Afvoeren van het toestel (milieu).....</b>	<b>40</b>
<b>14</b>	<b>Reinigen .....</b>	<b>40</b>
<b>15</b>	<b>ECO-modus (lage straling) .....</b>	<b>40</b>

## **Français .....** **41**

<b>1</b>	<b>Instructions de sécurité .....</b>	<b>41</b>
<b>2</b>	<b>Pour commencer .....</b>	<b>41</b>
2.1	Comment utiliser ce mode d'emploi ? .....	41
2.2	Installation de la base .....	41
2.3	Installation du combiné .....	42
2.4	Touches/LED.....	43
2.5	Symboles .....	43
2.6	Touches d'écran .....	44
2.7	LED de la base.....	44
2.8	Navigation dans les menus .....	44
2.9	Organisation des menus.....	45
<b>3</b>	<b>Utilisation du téléphone.....</b>	<b>45</b>
3.1	Mise en/hors service du combiné .....	45
3.2	Modification de la langue des menus .....	45
3.3	Passer un appel ordinaire.....	46
3.4	Recevoir un appel.....	46

3.5	Mode mains-libres .....	47
3.6	Réglage du volume de l'écouteur/haut-parleur mains-libres .....	47
3.7	Fonction silence (Mute).....	47
3.8	Localisation d'un combiné (fonction paging).....	47
3.9	Verrouillage du clavier .....	47
3.10	Utilisation du clavier alphanumérique.....	47
<b>4</b>	<b>Répertoire .....</b>	<b>48</b>
4.1	Pour ajouter une entrée .....	48
4.2	Pour composer un numéro.....	48
4.3	Montre Détail.....	48
4.4	Suppression d'une entrée ou de toutes les entrées .....	49
4.5	Modification d'un nom ou d'un numéro .....	49
4.6	Copie d'une entrée du répertoire vers un autre combiné .....	49
4.7	Copie de toutes les entrées du répertoire vers un autre combiné .....	50
<b>5</b>	<b>Identification de l'appelant .....</b>	<b>50</b>
5.1	Appels entrants RTC ordinaires .....	50
<b>6</b>	<b>Personnalisation du combiné .....</b>	<b>51</b>
6.1	Sonnerie et volume .....	51
6.2	Nom du combiné .....	52
6.3	Bip Touche .....	52
6.4	Réglage du contraste.....	52
6.5	Autotalk .....	52
6.6	Code de préfixe.....	52
6.7	Fonction d'alarme .....	53
6.8	Réglage de la date et de l'heure .....	53
6.9	Réglage du format horaire .....	53
<b>7</b>	<b>Réglage Base.....</b>	<b>54</b>
7.1	Sonnerie.....	54
7.2	Vol. Sonnerie .....	54
7.3	Mode de numérotation.....	54
7.4	Rappel (Flash) .....	54
7.5	PIN Système .....	55
<b>8</b>	<b>Outils.....</b>	<b>55</b>
8.1	Rendez-Vous .....	55
8.2	Chronomètre.....	55
<b>9</b>	<b>Combinés et stations de base supplémentaires .....</b>	<b>56</b>
9.1	Ajout d'un nouveau combiné.....	56
9.2	Suppression d'un combiné .....	56
9.3	Sélection d'une base.....	57
9.4	Fonction d'intercom .....	57
<b>10</b>	<b>Problèmes et solutions .....</b>	<b>58</b>
<b>11</b>	<b>Données et caractéristiques techniques .....</b>	<b>59</b>
<b>12</b>	<b>Garantie .....</b>	<b>59</b>
12.1	Période de garantie .....	59
12.2	Traitement de la garantie .....	59
12.3	Exclusions de garantie.....	60
<b>13</b>	<b>Mise au rebut de l'appareil (environnement).....</b>	<b>60</b>
<b>14</b>	<b>Nettoyage .....</b>	<b>60</b>
<b>15</b>	<b>Mode ECO (faible rayonnement) .....</b>	<b>60</b>

# Deutsch ..... 61

<b>1</b>	<b>Sicherheitshinweise</b> .....	<b>61</b>
<b>2</b>	<b>Erste Schritte</b> .....	<b>61</b>
2.1	Zum Gebrauch dieser Bedienungsanleitung.....	61
2.2	Basisstation installieren .....	61
2.3	Mobilteil installieren .....	62
2.4	Tasten / Anzeigen .....	63
2.5	Symbole.....	63
2.6	Displaytasten .....	64
2.7	LED der Basisstation.....	64
2.8	Durch das Menü navigieren.....	64
2.9	Menü-Übersicht.....	65
<b>3</b>	<b>Telefon benutzen</b> .....	<b>65</b>
3.1	Mobilteil ein-/ausschalten .....	65
3.2	Menüsprache ändern.....	65
3.3	Telefonieren.....	66
3.4	Einen Anruf annehmen.....	66
3.5	Freisprechmodus.....	67
3.6	Lautstärke Hörmuschel / Freisprechmodus anpassen.....	67
3.7	Stummschaltung (Mute) .....	67
3.8	Mobilteil suchen (Paging) .....	67
3.9	Tastatursperre .....	67
3.10	Die alphanumerischen Tasten verwenden .....	67
<b>4</b>	<b>Telefonbuch</b> .....	<b>68</b>
4.1	Einen Eintrag hinzufügen .....	68
4.2	Eine Nummer aus dem Telefonbuch anrufen .....	68
4.3	Einen Telefonbucheintrag anzeigen .....	68
4.4	Einen Eintrag oder alle Einträge löschen .....	69
4.5	Einen Namen und Telefonnummer bearbeiten.....	69
4.6	Einen Telefonbucheintrag auf ein anderes Mobilteil kopieren .....	69
4.7	Alle Telefonbucheinträge auf ein anderes Mobilteil kopieren .....	70
<b>5</b>	<b>Anruferkennung</b> .....	<b>70</b>
5.1	Normale eingehende PSTN-Anrufe .....	70
<b>6</b>	<b>Mobilteil individuell anpassen</b> .....	<b>71</b>
6.1	Rufton und Lautstärke .....	71
6.2	Mobilteil-Name .....	72
6.3	Tastentöne.....	72
6.4	Kontrast einstellen.....	72
6.5	Automatische Anrufannahme.....	72
6.6	Automatische Vorwahl.....	72
6.7	Weckfunktion verwenden.....	73
6.8	Datum und Uhrzeit einstellen.....	73
6.9	Zeitformat einstellen.....	73
<b>7</b>	<b>Basis Einstellungen</b> .....	<b>74</b>
7.1	Rufton .....	74
7.2	Ruftonlautstärke .....	74
7.3	Wahlverfahren .....	74
7.4	Flash .....	74
7.5	PIN Nummer .....	75
<b>8</b>	<b>Extras</b> .....	<b>75</b>
8.1	Termin .....	75



8.2	Stoppuhr .....	75
<b>9</b>	<b>Zusätzliche Mobilteile und Basisstationen .....</b>	<b>76</b>
9.1	Ein neues Mobilteil hinzufügen.....	76
9.2	Ein Mobilteil abmelden .....	76
9.3	Eine Basisstation auswählen.....	77
9.4	Interner Anruf verwenden .....	77
<b>10</b>	<b>Problemlösung.....</b>	<b>79</b>
<b>11</b>	<b>Technische Daten .....</b>	<b>79</b>
<b>12</b>	<b>Garantie .....</b>	<b>80</b>
12.1	Garantiezeit.....	80
12.2	Abwicklung des Garantiefalls .....	80
12.3	Garantiausschlüsse.....	80
<b>13</b>	<b>Entsorgung des Geräts (Umweltschutz) .....</b>	<b>80</b>
<b>14</b>	<b>Reinigung.....</b>	<b>80</b>
<b>15</b>	<b>ECO mode (Strahlungsarme Betriebsweise).....</b>	<b>81</b>

## **Español .....** **82**

<b>1</b>	<b>Instrucciones de seguridad.....</b>	<b>82</b>
<b>2</b>	<b>Introducción .....</b>	<b>82</b>
2.1	Cómo utilizar este manual del usuario .....	82
2.2	Instalación de la base.....	82
2.3	Instalación del terminal .....	83
2.4	Teclas/LED.....	84
2.5	Símbolos .....	84
2.6	Teclas de pantalla .....	85
2.7	LED Base.....	85
2.8	Navegación por el menú.....	85
2.9	Vista general de los menús .....	86
<b>3</b>	<b>Uso del teléfono .....</b>	<b>86</b>
3.1	ACTIVAR/DESACTIVAR el terminal.....	86
3.2	Cambiar el idioma de los menús .....	86
3.3	Realizar una llamada telefónica normal .....	87
3.4	Recibir una llamada de teléfono .....	87
3.5	Modo manos libres .....	88
3.6	Ajustar el volumen del auricular/manos libres.....	88
3.7	Función Secreto (función Mute).....	88
3.8	Localizar un terminal (función de búsqueda).....	88
3.9	Bloqueo del teclado .....	88
3.10	Usar las teclas alfanuméricas.....	88
<b>4</b>	<b>Agenda .....</b>	<b>89</b>
4.1	Para añadir una entrada .....	89
4.2	Para marcar una entrada .....	89
4.3	Ver detalles.....	89
4.4	Eliminar una entrada o todas las entradas .....	90
4.5	Editar un nombre y un número.....	90
4.6	Copiar una entrada de la agenda en otro terminal .....	90
4.7	Copiar todas las entradas de la agenda en otro terminal .....	91
<b>5</b>	<b>Identificación de llamadas .....</b>	<b>91</b>
5.1	Llamadas RTPC entrantes normales .....	91
<b>6</b>	<b>Personalizar el terminal .....</b>	<b>92</b>

6.1	Timbre y volumen .....	92
6.2	Nombre del terminal.....	93
6.3	Tono de pulsación de teclas.....	93
6.4	Ajustar el contraste .....	93
6.5	Descolgar automáticamente.....	93
6.6	Código de prefijo .....	93
6.7	Usar la función de alarma.....	94
6.8	Ajustar la fecha y la hora.....	94
6.9	Ajustar el formato de hora .....	94
<b>7</b>	<b>Configurar la base .....</b>	<b>95</b>
7.1	Timbre .....	95
7.2	Volumen del timbre.....	95
7.3	Marcación .....	95
7.4	Rellamada (Flash).....	95
7.5	PIN del sistema.....	96
<b>8</b>	<b>Herramientas.....</b>	<b>96</b>
8.1	Cita .....	96
8.2	Cronómetro.....	96
<b>9</b>	<b>Terminales y bases adicionales .....</b>	<b>97</b>
9.1	Añadir un nuevo terminal .....	97
9.2	Eliminar un terminal.....	97
9.3	Seleccionar una base.....	98
9.4	Usar la función de intercomunicación.....	98
<b>10</b>	<b>Solucionar problemas .....</b>	<b>99</b>
<b>11</b>	<b>Datos técnicos Características técnicas.....</b>	<b>100</b>
<b>12</b>	<b>Garantía .....</b>	<b>100</b>
12.1	Periodo de garantía .....	100
12.2	Tratamiento de la garantía .....	100
12.3	Limitaciones de la garantía.....	101
<b>13</b>	<b>Eliminación del dispositivo (medio ambiente) .....</b>	<b>101</b>
<b>14</b>	<b>Limpieza .....</b>	<b>101</b>
<b>15</b>	<b>Modo ECO (radiación baja) .....</b>	<b>101</b>

## **Svenska .....** **102**

<b>1</b>	<b>Säkerhetsföreskrifter.....</b>	<b>102</b>
<b>2</b>	<b>Komma igång .....</b>	<b>102</b>
2.1	Så här används bruksanvisningen.....	102
2.2	Installera basenheten .....	102
2.3	Installera handenheten .....	103
2.4	Knappar/Lampor.....	104
2.5	Symboler.....	104
2.6	Displayknappar.....	105
2.7	Lysdiod på basenheten .....	105
2.8	Navigera i menyn .....	105
2.9	Meny-översikt.....	106
<b>3</b>	<b>Använda telefonen .....</b>	<b>106</b>
3.1	Sätta på och stänga av handenheten .....	106
3.2	Byta menyspråk.....	106
3.3	Ringa ett vanligt telefonsamtal.....	107
3.4	Ta emot ett telefonsamtal .....	107

3.5	Högtalar-läge .....	108
3.6	Justera volymen för öronsnäcka/högtalare .....	108
3.7	Sekretess-funktion (Ljud av-funktion) .....	108
3.8	Leta efter en handenhets (Sök-funktion).....	108
3.9	Knapplås .....	108
3.10	Använda den alfanumeriska knappsatsen.....	108
<b>4</b>	<b>Telefonbok .....</b>	<b>109</b>
4.1	För att lägga till en kontakt.....	109
4.2	För att ringa en kontakt.....	109
4.3	Visa detaljer.....	109
4.4	Ta bort en kontakt eller alla kontakter.....	110
4.5	Redigera namn och nummer.....	110
4.6	Kopiera en telefonbokskontakt till en annan handenhets.....	110
4.7	Kopiera alla telefonboks kontakter till en annan handenhets .....	111
<b>5</b>	<b>Nummerpresentation.....</b>	<b>111</b>
5.1	Vanliga inkommande PSTN-samtal .....	111
<b>6</b>	<b>Anpassa handenhets .....</b>	<b>112</b>
6.1	Ringsignal och volym.....	112
6.2	Handenhets namn.....	113
6.3	Knappljud .....	113
6.4	Ställ in kontrast.....	113
6.5	Autosamtal.....	113
6.6	Prefix-kod .....	113
6.7	Använd alarmfunktionen .....	114
6.8	Ställa in datum och tid .....	114
6.9	Ställa in tidformatet .....	114
<b>7</b>	<b>Grundinställningar .....</b>	<b>115</b>
7.1	Ringsignal.....	115
7.2	Uppringningsvolym.....	115
7.3	Uppringningsläge .....	115
7.4	Återuppringning (Paus) .....	115
7.5	System-PIN.....	116
<b>8</b>	<b>Verktyg .....</b>	<b>116</b>
8.1	Möte.....	116
8.2	Stoppur .....	116
<b>9</b>	<b>Ytterligare handenhets och basenhets. ....</b>	<b>117</b>
9.1	Lägga till en ny handenhets .....	117
9.2	Ta bort en handenhets .....	117
9.3	Välj en basenhets .....	118
9.4	Använda snabbtelefonsfunktion .....	118
<b>10</b>	<b>Felsökning.....</b>	<b>119</b>
<b>11</b>	<b>Tekniska data Tekniska kännetecken.....</b>	<b>120</b>
<b>12</b>	<b>Garanti.....</b>	<b>120</b>
12.1	Garantiperiod.....	120
12.2	Garantiregler.....	120
12.3	Garantiundantag .....	121
<b>13</b>	<b>Avyttring av apparaten (miljö).....</b>	<b>121</b>
<b>14</b>	<b>Rengöring .....</b>	<b>121</b>
<b>15</b>	<b>ECO-läge (lågstrålning).....</b>	<b>121</b>

# Dansk ..... 122

<b>1</b>	<b>Sikkerhedsanvisninger .....</b>	<b>122</b>
<b>2</b>	<b>Sådan kommer du i gang .....</b>	<b>122</b>
2.1	Sådan anvendes denne brugervejledning.....	122
2.2	Sådan installeres basen .....	122
2.3	Sådan installeres håndsettet .....	123
2.4	Taster/Led.....	124
2.5	Symboler.....	124
2.6	Display-taster.....	125
2.7	Basens LED .....	125
2.8	Navigation af menuen.....	125
2.9	Menuoversigt.....	126
<b>3</b>	<b>Sådan bruges telefonen.....</b>	<b>126</b>
3.1	Tænding/slukning af håndsettet.....	126
3.2	Sådan ændrer du sprog .....	126
3.3	Sådan foretages et normalt telefonopkald .....	127
3.4	Sådan modtages et telefonopkald .....	127
3.5	Tilstanden Håndfri.....	128
3.6	Juster ørestykke/håndfrivolumen.....	128
3.7	Hemmelighedsfunktion (funktionen Slå lyd fra).....	128
3.8	Lokalisering af håndsettet (funktionen Håndsætsøgning).....	128
3.9	Tastlås.....	128
3.10	Sådan bruges det alfanumeriske tastatur .....	128
<b>4</b>	<b>Telefonbog .....</b>	<b>129</b>
4.1	Sådan tilføjes et punkt .....	129
4.2	Sådan ringes der op til en kontakt .....	129
4.3	Vis detaljer.....	129
4.4	Slet en eller alle kontakter .....	130
4.5	Rediger navn og nummer .....	130
4.6	Kopier et telefonbogspunkt til et andet håndset .....	130
4.7	Kopier alle telefonbogskontakter til et andet håndset .....	131
<b>5</b>	<b>Nummerviser.....</b>	<b>131</b>
5.1	Normale, indgående PSTN-opkald.....	131
<b>6</b>	<b>Personaliser håndsettet .....</b>	<b>132</b>
6.1	Ringetone og volumen.....	132
6.2	Håndsetnavn .....	133
6.3	Tastaturlyd.....	133
6.4	Sådan indstilles kontrasten .....	133
6.5	Autotalk .....	133
6.6	Præfikskode .....	133
6.7	Sådan bruges alarmfunktionen .....	134
6.8	Indstilling af dato og tid .....	134
6.9	Indstilling af tidsformat .....	134
<b>7</b>	<b>Baseindstillinger.....</b>	<b>135</b>
7.1	Ringetone.....	135
7.2	Ringevolumen.....	135
7.3	Opkaldstilstand.....	135
7.4	Vælg (Flash) .....	135
7.5	System-PIN.....	136
<b>8</b>	<b>Værktøj.....</b>	<b>136</b>
8.1	Aftale .....	136

8.2	Stopur .....	136
<b>9</b>	<b>Yderligere håndsett og basestationer .....</b>	<b>137</b>
9.1	Sådan tilføjes et nyt håndsett .....	137
9.2	Sådan fjernes et håndsett .....	137
9.3	Vælg en basen.....	138
9.4	Sådan bruges samtaleanlægsfunktionen .....	138
<b>10</b>	<b>Fejlsøgning.....</b>	<b>139</b>
<b>11</b>	<b>Tekniske data Tekniske specifikationer .....</b>	<b>140</b>
<b>12</b>	<b>Garanti.....</b>	<b>140</b>
12.1	Garantiperiode .....	140
12.2	Håndtering af garantien .....	140
12.3	Undtagelser fra garantien .....	140
<b>13</b>	<b>Bortskaffelse af enheden (miljø).....</b>	<b>141</b>
<b>14</b>	<b>Rengøring .....</b>	<b>141</b>
<b>15</b>	<b>ECO-tilstand (lavstråling).....</b>	<b>141</b>

## **Norsk .....** **142**

<b>1</b>	<b>Sikkerhetsinstruksjoner .....</b>	<b>142</b>
<b>2</b>	<b>Komme i gang .....</b>	<b>142</b>
2.1	Slik bruker du denne veiledningen .....	142
2.2	Installere baseenheten.....	142
2.3	Installere håndsettet .....	143
2.4	Taster/led-indikator .....	144
2.5	Symboler.....	144
2.6	Displaytaster .....	145
2.7	LED-indikator på baseenhet .....	145
2.8	Navigere i menyen.....	145
2.9	Menyoversikt.....	146
<b>3</b>	<b>Bruke telefonen .....</b>	<b>146</b>
3.1	Slå håndsettet PÅ/AV .....	146
3.2	Endre menyspråket .....	146
3.3	Foreta et vanlig telefonanrop.....	147
3.4	Motta en telefonsamtale .....	147
3.5	Håndfrimodus.....	148
3.6	Justere høyttaler/håndfrivolum .....	148
3.7	Privat-funksjon (dempefunksjon).....	148
3.8	Finne et håndsett (søkefunksjon).....	148
3.9	Tastelås .....	148
3.10	Bruke det alfanumeriske tastaturet .....	148
<b>4</b>	<b>Telefonbok .....</b>	<b>149</b>
4.1	Slik legger du til en oppføring.....	149
4.2	Slik ringer du opp en oppføring.....	149
4.3	Vis detalj.....	149
4.4	Slette en oppføring eller alle oppføringer.....	150
4.5	Redigere navn og nummer.....	150
4.6	Kopiere en oppføring i telefonboken til et annet håndsett .....	150
4.7	Kopiere alle oppføringer i telefonboken til et annet håndsett .....	151
<b>5</b>	<b>Hvem ringer .....</b>	<b>151</b>
5.1	Normale innkommende PSTN-samtaler.....	151
<b>6</b>	<b>Tilpasse håndsettet.....</b>	<b>152</b>

6.1	Ringetone og volum .....	152
6.2	Navn på håndsett .....	153
6.3	Tastetoner .....	153
6.4	Stille inn kontrast.....	153
6.5	Autotalk .....	153
6.6	Prefikskode .....	153
6.7	Bruke alarmfunksjonen .....	154
6.8	Stille inn dato og klokkeslett.....	154
6.9	Stille inn klokkeslettformat .....	154
<b>7</b>	<b>Baseinnst.....</b>	<b>155</b>
7.1	Ringetone.....	155
7.2	Ringevolum .....	155
7.3	Ringemodus .....	155
7.4	Repetisjon (Flash).....	155
7.5	System-PIN.....	156
<b>8</b>	<b>Verktøy .....</b>	<b>156</b>
8.1	Avtale .....	156
8.2	Stoppeklokke .....	156
<b>9</b>	<b>Flere håndsett og basestasjoner .....</b>	<b>157</b>
9.1	Legge til et nytt håndsett .....	157
9.2	Fjerne et håndsett.....	157
9.3	Velge en baseenhet .....	158
9.4	Bruke internsamtalesfunksjonen .....	158
<b>10</b>	<b>Feilsøking.....</b>	<b>159</b>
<b>11</b>	<b>Tekniske karakteristikker.....</b>	<b>160</b>
<b>12</b>	<b>Garanti.....</b>	<b>160</b>
12.1	Garantiperiode .....	160
12.2	Garantihåndtering.....	160
12.3	Ikke inkludert i garantien.....	161
<b>13</b>	<b>Avhending av produktet (miljø).....</b>	<b>161</b>
<b>14</b>	<b>Rengjøring .....</b>	<b>161</b>
<b>15</b>	<b>ECO-modus (lav stråling) .....</b>	<b>161</b>

## **Suomi .....** **162**

<b>1</b>	<b>Turvaohjeet .....</b>	<b>162</b>
<b>2</b>	<b>Käytön aloittaminen .....</b>	<b>162</b>
2.1	Tämän käyttöohjeen käyttäminen.....	162
2.2	Tukiaseman asentaminen.....	162
2.3	Kuulokkeen asentaminen.....	163
2.4	Näppäimet/LED.....	164
2.5	Symbolit .....	164
2.6	Näytön näppäimet.....	165
2.7	Tukiaseman LED.....	165
2.8	Valikossa liikkuminen .....	165
2.9	Valikkonäkymä.....	166
<b>3</b>	<b>Puhelimen käyttö .....</b>	<b>166</b>
3.1	Käsiosan kytkeminen päälle/pois .....	166
3.2	Valikkokielen vaihtaminen.....	166
3.3	Normaalin puhelun soittaminen .....	167
3.4	Puhelun vastaanottaminen .....	167

3.5	Handsfree-tila .....	168
3.6	Käsiosan/handsfree-laitteen äänenvoimakkuuden säätäminen.....	168
3.7	Salaustoiminto (mykistys).....	168
3.8	Käsiosan paikallistaminen (hakutoiminto).....	168
3.9	Näppäinlukko .....	168
3.10	Aakkosnumeerisen näppäimistön käyttö.....	168
<b>4</b>	<b>Puhelinluettelo.....</b>	<b>169</b>
4.1	Merkinnän lisääminen .....	169
4.2	Merkinnän valitseminen .....	169
4.3	Näytä tiedot .....	169
4.4	Poista yksi merkintä tai kaikki merkinnät .....	170
4.5	Muokkaa nimeä ja numeroa .....	170
4.6	Kopioi puhelinluettelon merkintä toiseen käsiosaan.....	170
4.7	Kopioi kaikki puhelinluettelon merkinnät toiseen käsiosaan.....	171
<b>5</b>	<b>Soittajan tunnistus .....</b>	<b>171</b>
5.1	Normaalit saapuvat PSTN-puhelut.....	171
<b>6</b>	<b>Personoi käsiosa .....</b>	<b>172</b>
6.1	Soittoääni ja äänenvoimakkuus .....	172
6.2	Käsiosan nimi .....	173
6.3	Näppäinäänät .....	173
6.4	Kontrastin asettaminen .....	173
6.5	Autom.puh. ....	173
6.6	Prefiksikoodi.....	173
6.7	Hälytystoiminnon käyttö .....	174
6.8	Päivämäärän ja kellonajan asettaminen.....	174
6.9	Ajannäytön asettaminen .....	174
<b>7</b>	<b>Tukias.aset. ....</b>	<b>175</b>
7.1	Soittoääni .....	175
7.2	Soit.voimak.....	175
7.3	Valintatila .....	175
7.4	Toisto (Flash).....	175
7.5	Järjest. PIN .....	176
<b>8</b>	<b>Työkalut.....</b>	<b>176</b>
8.1	Tapaaminen .....	176
8.2	Sekuntikello.....	176
<b>9</b>	<b>Lisäkäsiosat ja -tukiasemat.....</b>	<b>177</b>
9.1	Uuden käsiosan lisääminen .....	177
9.2	Käsiosan poistaminen .....	177
9.3	Valitse tukiasema.....	178
9.4	Intercom-toiminnon käyttö.....	178
<b>10</b>	<b>Vianmääritys .....</b>	<b>179</b>
<b>11</b>	<b>Tekniset tiedot Tekniset ominaisuudet .....</b>	<b>180</b>
<b>12</b>	<b>Takuu .....</b>	<b>180</b>
12.1	Takuuaika .....	180
12.2	Takuutoimet.....	180
12.3	Takuuehdot .....	180
<b>13</b>	<b>Laitteen hävittäminen (ympäristöystävällisesti) .....</b>	<b>181</b>
<b>14</b>	<b>Puhdistus .....</b>	<b>181</b>
<b>15</b>	<b>ECO-tila (säteily vähäistä) .....</b>	<b>181</b>

# Ελληνικά ..... 182

<b>1</b>	<b>Οδηγίες ασφαλείας</b> .....	<b>182</b>
<b>2</b>	<b>Ξεκινώντας</b> .....	<b>182</b>
2.1	Τρόπος χρήσης του οδηγού χρήσης .....	182
2.2	Εγκατάσταση της βάσης.....	182
2.3	Εγκατάσταση του ακουστικού .....	183
2.4	Πλήκτρα/Φωτεινή ένδειξη.....	184
2.5	Σύμβολα.....	184
2.6	Πλήκτρα οθόνης.....	185
2.7	Ενδεικτική λυχνία βάσης.....	185
2.8	Περιήγηση στα μενού.....	185
2.9	Επισκόπηση των μενού .....	186
<b>3</b>	<b>Χρήση του τηλεφώνου</b> .....	<b>186</b>
3.1	Ενεργοποίηση/Απενεργοποίηση ακουστικού.....	186
3.2	Αλλαγή της γλώσσας μενού .....	186
3.3	Πραγματοποίηση κανονικής τηλεφωνικής κλήσης.....	187
3.4	Λήψη τηλεφωνικής κλήσης.....	187
3.5	Λειτουργία ανοιχτής συνομιλίας.....	188
3.6	Ρύθμιση έντασης ακουστικού/ανοιχτής συνομιλίας.....	188
3.7	Λειτουργία εμπιστευτικότητας (Λειτουργία σίγασης) .....	188
3.8	Εντοπισμός ακουστικού (Λειτουργία αναζήτησης) .....	188
3.9	Κλείδωμα πληκτρολογίου .....	188
3.10	Χρήση του αλφαριθμητικού πληκτρολογίου .....	188
<b>4</b>	<b>Ευρετήριο</b> .....	<b>189</b>
4.1	Για να προσθέσετε μια καταχώριση .....	189
4.2	Για να καλέσετε μια καταχώριση .....	189
4.3	Εμφάνιση λεπτομερειών.....	189
4.4	Διαγραφή μιας καταχώρισης ή όλων των καταχωρίσεων .....	190
4.5	Επεξεργασία ονόματος και αριθμού.....	190
4.6	Αντιγραφή καταχώρισης ευρετηρίου σε άλλο ακουστικό .....	190
4.7	Αντιγραφή όλων των καταχωρίσεων ευρετηρίου σε άλλο ακουστικό.....	191
<b>5</b>	<b>Αναγνώριση καλούντος</b> .....	<b>191</b>
5.1	Κανονικές εισερχόμενες κλήσεις PSTN.....	191
<b>6</b>	<b>Διαμόρφωση του ακουστικού</b> .....	<b>192</b>
6.1	Ήχος και ένταση κουδουνίσματος.....	192
6.2	Όνομα ακουστικού .....	193
6.3	Ήχος πληκτρολογίου .....	193
6.4	Ρύθμιση της αντίθεσης .....	193
6.5	Αυτόματα απάντηση.....	193
6.6	Πρόθεμα κωδικού.....	193
6.7	Χρήση της λειτουργίας ειδοποίησης .....	194
6.8	Ρύθμιση ημερομηνίας και ώρας .....	194
6.9	Ρύθμιση της μορφής ώρας.....	194
<b>7</b>	<b>Ρυθμίσεις βάσης</b> .....	<b>195</b>
7.1	Ήχος .....	195
7.2	Ένταση κουδουνιού.....	195
7.3	Λειτουργία κλήσης .....	195
7.4	Επανάκληση (Flash) .....	195
7.5	Κωδικός συστήματος.....	196
<b>8</b>	<b>Εργαλεία</b> .....	<b>196</b>
8.1	Συνάντηση .....	196



8.2	Χρονόμετρο .....	196
<b>9</b>	<b>Πρόσθετα ακουστικά και σταθμοί βάσης.....</b>	<b>197</b>
9.1	Προσθήκη νέου ακουστικού.....	197
9.2	Κατάργηση ακουστικού .....	197
9.3	Επιλογή βάσης.....	198
9.4	Χρήση της λειτουργίας ενδοεπικοινωνίας.....	198
<b>10</b>	<b>Επίλυση προβλημάτων .....</b>	<b>199</b>
<b>11</b>	<b>Τεχνικά δεδομένα Τεχνικά χαρακτηριστικά .....</b>	<b>200</b>
<b>12</b>	<b>Εγγύηση .....</b>	<b>200</b>
12.1	Περίοδος εγγύησης.....	200
12.2	Χρήση της εγγύησης .....	200
12.3	Εξαιρέσεις.....	200
<b>13</b>	<b>Απόρριψη της συσκευής (περιβάλλον).....</b>	<b>201</b>
<b>14</b>	<b>Καθαρισμός .....</b>	<b>201</b>
<b>15</b>	<b>Λειτουργία ECO (χαμηλής ακτινοβολίας).....</b>	<b>201</b>

## English

### 1 Safety instructions

- Only use the charger plug supplied. Do not use other chargers as this may damage the battery cells.
- Only insert rechargeable batteries of the same type. Never use ordinary, non-rechargeable batteries. Insert rechargeable batteries so they connect to the right poles (indicated in the battery compartment of the handset).
- Do not touch the charger and plug contacts with sharp or metal objects.
- The operations of some medical devices may be affected.
- The handset may cause an unpleasant buzzing sound in hearing aids.
- Do not place the basic unit in a damp room or at a distance of less than 1.5m away from a water source. Keep water away from the handset.
- Do not use the telephone in environments where there is a risk of explosions.
- Dispose of the batteries and maintain the telephone in an environment-friendly manner.
- As this telephone cannot be used in case of a power cut, you should use a mains-independent telephone for emergency calls, e.g. a mobile phone.

### 2 Getting started

#### 2.1 How to use this user guide

In this user guide, following method is used to clarify the instructions:

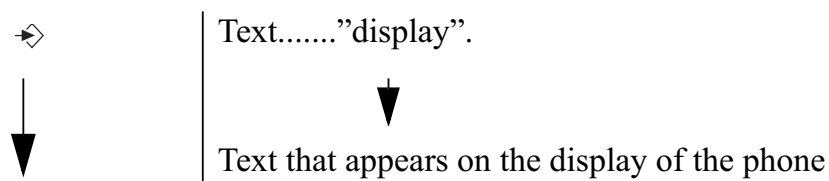

Key to press. This key can be a soft key (See "2.4 Keys/Led"). When the soft key is a symbol, it is shown in the left column. When the soft key is text, the left or right soft key is shown in the left column and the text is shown in the right column between quotation marks.

#### 2.2 Installing the base

For installation, do the following:

- 1** Plug one end of the adaptor into the outlet and the other end into the adaptor jack on the back of the base.
- 2** Connect one end of the telephone cord with the wall phone jack and the other end to the bottom of the base.
- 3** Put the telephone- and AC power line cord in the base guides as shown on picture 2A.

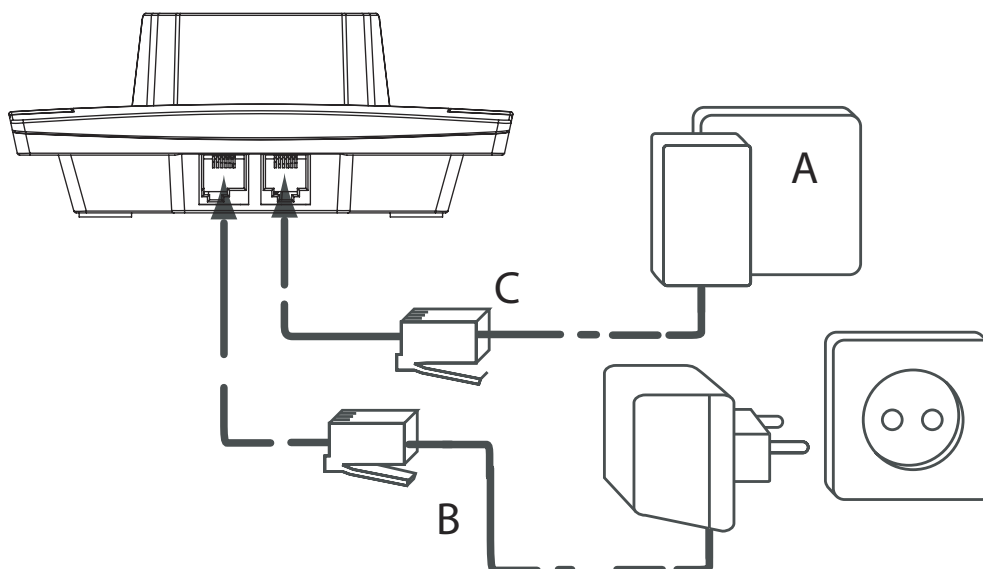

- 2A Back view of base -

A. Telephone wall outlet

B. Power cable

C. Telephone cord

### 2.3 Installing the handset

- 1** Open the battery compartment as shown on picture 2B.
- 2** Insert the batteries respecting the polarity (+ and -).
- 3** Close the battery compartment.
- 4** Leave the handset on the base unit for 20 hours. The Line/Charge indicator  on the base will light up.

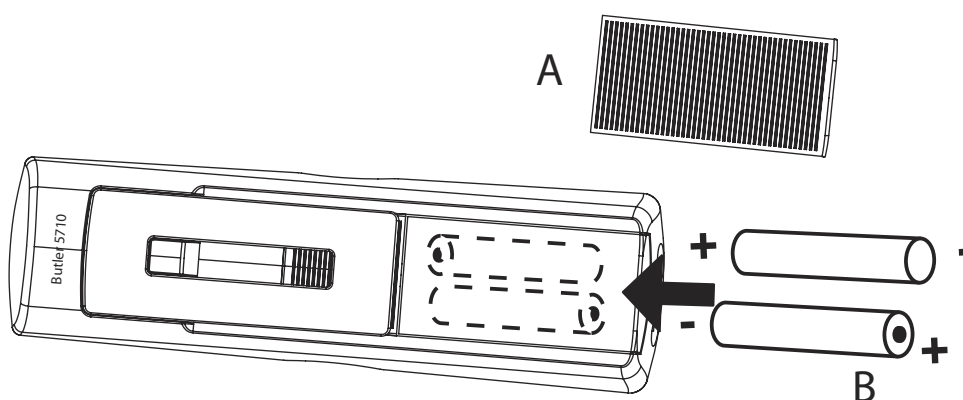

- 2B Back view of handset -

A. Cover

B. Rechargeable batteries



*Before you use the telephone for the first time, you must first make sure the battery is charged for 20 hours. If you do not do this, the telephone will not work optimally.*

## 2.4 Keys/Led

### Handset

1. Display
2. Up/Redial key
3. Right soft menu key
4. Right/Flash key
5. On-hook / OFF key
6. Alphanumeric keys
7. Keypad lock
8. Ringer Off-key
9. Down/call log key
10. Off-hook key/ Handsfree/ On-key
11. Left/INT key
12. OK key
13. Left soft menu key

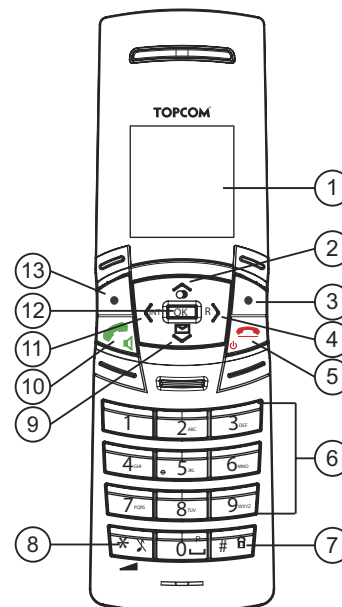

- 2C Handset -





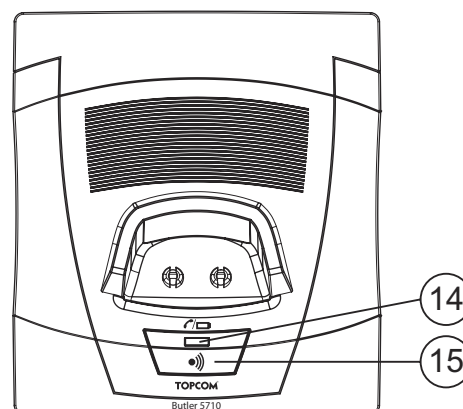









### Base

14. In use/Power/Handset on base LED
15. Paging key



- 2D Base -



## 2.5 Symbols

	Off hook		Keypad lock
	On hook		Alarm set
	Missed calls in call list*		Handset not registered or out of range
	Handset ringer volume OFF		Battery empty
	Handset within base range		Battery low
	Internall Call		Battery medium
	Handsfree		Battery full
	New voice mail		

\* If the Caller line identification service is available on the telephone line.

## 2.6 Display keys

Display-keys (softkeys) are located directly under the display. The function of these 2 keys changes depending on the operation mode. The actual function is displayed as icon or text directly above the 2 display keys.

	Phonebook		Mute
	OK/Confirm		Back
	Menu		No key
	Delete		





## 2.7 Base LED

The LED (14) indicates the following status:



- OFF: no base power connected or handset not in base for charging
- ON: handset charging
- Blinking slowly: Off hook or during ringing
- Blinking rapidly: during registration

## 2.8 Navigating the menu

The Butler 5710 has a menu system which is easy to use. Each menu leads to a list of options. The menu map is shown on the following paragraph.

- |   |  |
|---|--|
|  | <b>1</b> When the handset is switched on and in standby, press the left soft menu key  to open the main menu. |
|  | <b>2</b> Scroll to the desired menu option.  |
|  | <b>3</b> Press the soft menu key to view further options or to confirm the setting displayed.  |

### To exit or to go back one level in the menu

- |   |   |
|---|---|
|  | To go to the previous level in the menu, press the soft menu key.   |
|  | To cancel and return to standby at any time, press the on-hook key. |

## 2.9 Menu overview

Menu	Submenu items
Handset	Ringtone Ringer Volume Handset Name Keypad Beep Contrast Auto Talk Prefix Select Base Language Registration
Base settings	Ringtone Ringer volume Dial mode Recall System PIN
Alarm/Clock	Set Alarm Date & Time Time Format
Tools	Appointment Stopwatch
Power Off	

## 3 Using the telephone

### 3.1 Switching the handset ON/OFF



- 1 Press and hold the OFF key to switch the handset off.
- 2 Press the off-hook key or place the handset in the base to switch the handset back on.

### 3.2 Changing the menu language



- 1 Enter the menu.
- 2 Select “Handset” and confirm.
- 3 Select “Language” and confirm.
- 4 Select a language and confirm.  
The screen displays “Saved”.
- 5 Press the on-hook key to return to standby.



The ↗ arrows indicate that further options are available in the menu.

### 3.3 Making a normal telephone call

#### Direct dialling



- 1** Press the off-hook key to start the call.
- 2** Dial the telephone number.
- 3** Press the on-hook key to hang up or put the handset back on the base.

#### Pre-dialling

With the pre-dialling feature, you can enter and modify a number before making the call.



- 1** Dial a number of up to 24 digits.  
Press and hold the 0 key to insert a pause. The screen displays a "P".
- 2** Press the soft menu key to correct.
- 3** Press the off-hook key to start the call.
- 4** Press the on-hook key to hang up or put the handset back on the base.

#### Redial a number from the list

You can redial up to 10 of the last numbers called. If you have stored a name in the phonebook to go with the number, the name will be displayed instead.



- 1** Press the redial key.
- 2** Select a number. If the number is in the phonebook, the name will be shown.
- 3** Press the off-hook key to start the call or select "Option".
- 4** If you selected "Option", scroll and select:  
"Delete Call": to remove the number from the call list;  
"Save Number": to store the number into the phonebook;  
"Delete All": to erase the call list.
- 5** Confirm selection.
- 6** Press the on-hook key to return to standby.

### 3.4 Receiving a telephone call

When you receive an external call, the screen displays "External Call".

To take the call:



- 1** Press the off-hook key.  
OR  
Lift the handset off its base if you have activated "Auto Talk"  
(See "6.5 Autotalk")  
The call in progress icon  appears on the screen. The call duration is displayed after 15 seconds.
- 2** Press the on-hook key to hang up or put the handset back on the base.



*You can turn the ring volume off during incoming call by selecting "Quiet".*

### 3.5 Handsfree mode

Handsfree lets you talk to your caller without holding the handset. It also enables other people in the room to listen to both sides of your conversation.



- 1 To switch any call to handsfree, press the handsfree key during the call.

### 3.6 Adjust earpiece/handsfree volume



- 1 Press up or down to select volume 1-5 during a normal or handsfree call.

### 3.7 Secrecy function (Mute function)

To turn off the microphone so the person on the other side of the line will not hear you.



- 1 During a conversation, press the soft menu key to deactivate the microphone.

“Mute On” appears on the display.



- 2 Select “Off” to activate the microphone again.

### 3.8 Locating a handset (Paging function)



- 1 Press the paging key on the base.

All handsets registered with the base will ring for 30 seconds.



- 2 Press any key on the handset to stop the paging.

### 3.9 Keypad Lock

To lock the keypad to prevent accidental dialling while carrying the handset around.

In standby:



- 1 Press and hold the keypad locked key (key 7 - Picture 2C) until “Locked” and the keypad locked icon  appears on the display.



- 2 To unlock, select “Unlock”, followed by the keypad locked key.

### 3.10 Using the alphanumerical keypad

With your telephone, you can also enter alphanumeric characters. This is useful for entering a name into the phonebook, giving a name to the handset, ...

To select a letter, press the corresponding key as many times as necessary.





For example, to select an ‘A’, press ‘2’ once. To select a ‘B’, press ‘2’ twice and so on.

To select ‘A’ and then ‘B’ consecutively, press ‘2’ once, wait until the cursor moves on to the next character, then press ‘2’ twice.

During entering text, the available character under each key appears below on the display.













You can change the input character set from English (abc) to Latin (aàá), Greek (ΑΒΓ) or Russian (АБВ) by pressing and holding the #-key for 2 seconds.

	Press '0' to select a space.
	Press the *-key to switch between small letters and capitals.
	Press and hold the #-key for 2 seconds to change the input character set.
	Press the soft menu key to correct.





## 4 Phonebook

Each handset can store up to 200 names and numbers. Names can be up to 16 characters long and numbers up to 24 digits.







### 4.1 To add an entry

	<b>1</b> Press the soft menu key.
	If the phonebook is empty, "Phonebook Empty" appears on the display. If names have been stored, they are listed.
	<b>2</b> Select "Option".
	<b>3</b> Select "New Entry" and confirm.
 	<b>4</b> Use the keypad to enter the name, then select "Save".
 	<b>5</b> Use the keypad to enter the number, then select "Save".
 	<b>6</b> Select the desired ring melody and select "Save".
	<b>7</b> Return to standby.

### 4.2 To dial an entry

	<b>1</b> Press the soft menu key.
	<b>2</b> Select the desired name or use the keypad to enter the first letter of the name.
	<b>3</b> Press the off-hook key to start the call.
	<b>4</b> Return to standby.

### 4.3 Show Details

	<b>1</b> Press the soft menu key.
	<b>2</b> Select the desired name or use the keypad to enter the first letter of the name.
	<b>3</b> Select "Option".
 	<b>4</b> Select "Show Details" and confirm.
	The name, number and ring melody you have assigned to the entry appear on the display.
	<b>5</b> Return to standby.

#### 4.4 Delete an entry or all entries



- 1** Press the soft menu key.
- 2** Select the desired name or use the keypad to enter the first letter of the name.
- 3** Select “Option”.  
To delete one entry:
- 4** Select “Delete Entry” and confirm.  
To delete all entries:
- 4** Select “Delete All” and confirm.
- 5** Press the left menu key to cancel or the right menu key to confirm.
- 6** Return to standby.

#### 4.5 Edit name and number



- 1** Press the soft menu key.
- 2** Select the desired name or use the keypad to enter the first letter of the name.
- 3** Select “Option”.
- 4** Select “Edit Entry” and confirm.
- 5** Press the soft menu key to delete and use the keypad to change the name.
- 6** Select “Save”.
- 7** Edit the number and select “Save”.
- 8** Select the desired ring melody and select “Save”.
- 9** Return to standby.

#### 4.6 Copy a phonebook entry to another handset



- 1** Press the soft menu key.
- 2** Select the desired name or use the keypad to enter the first letter of the name.
- 3** Select “Option”.
- 4** Select “Copy Entry” and confirm.  
The available handsets (all the handsets that are registered on the base) are shown.
- 5** Select the desired handset and confirm.  
“Copying to handset x” appears on the display.  
“Receive phonebook record?” appears on the display of the destination handset.
- 6** On the destination handset, press the right menu key to confirm or the left menu key to cancel the transfer.
- 7** Return to standby.

## 4.7 Copy all phonebook entries to another handset



*By copying all entries from one handset to another, you will erase all existing records at the destination handset.*



**1** Press the soft menu key.



**2** Select the desired name or use the keypad to enter the first letter of the name.



**3** Select "Option".



**4** Select "Copy All" and confirm.

The available handsets (all the handsets that are registered on the base) are shown.



**5** Select the desired handset and confirm.

"Copying to handset x" appears on the display.

"Replace all phonebook records?" appears on the display of the destination handset.



**6** On the destination handset, press the right menu key to confirm or the left menu key to cancel the transfer.



**7** Return to standby.

## 5 Caller Identification

### 5.1 Normal incoming PSTN calls



*This service only works when you have a Caller ID/Clip subscription. Please contact your telephone company.*

When you receive a call from your fixed telephone line, the telephone number of the caller appears on the handset display. The telephone can receive calls in both FSK and DTMF. You can also see his or her name if it is transmitted by the network. If the name is programmed in the phonebook, the name in the phonebook is displayed!

The telephone can store 30 calls in a Call List (received and missed) that can be reviewed later. When the memory is full, the new calls automatically replace the oldest calls in the memory.



Missed calls are signalled by a blinking icon on the display. The handset name is replaced by this icon and the amount of missed calls.

#### To read the received calls



**1** Press the down button.

The Received calls list appears on the display. This is a combination of received and missed calls.



**2** Select the desired name or number.



















**3** Press the off-hook key to start the call.

OR



Select "Option".

To delete one entry:















- |   |   |   |   |
|---|---|---|---|
|  |  |  | <b>4</b> Select “Delete Call” and confirm.                      |
|  |   |   | <b>5</b> Return to standby.                                     |
|   |   |   | To delete all entries:  |
|  |  |  | <b>5</b> Select “Delete All” and confirm.                       |
|  |   |   | <b>6</b> Return to standby.                                     |
|   |   |   | To add the number to the phonebook:                             |
|  |  |  | <b>5</b> Select “Save Number” and confirm.                      |
|  |   |   | <b>6</b> Use the keypad to enter the name, then select “Save”.  |
|  |   |   | <b>7</b> Use the keypad to edit the number, then select “Save”. |
|  |  |  | <b>8</b> Select the desired ring melody end select “Save”.      |
|  |   |   | <b>9</b> Return to standby.                                     |

## 6 Personalise the handset

### 6.1 Ringtone and volume











#### Ringtone

You can choose from 18 different ringer melodies for internal and external calls.

- |   |   |   |   |
|---|---|---|---|
|    |   |   | <b>1</b> Enter the menu.  |
|  |  |  | <b>2</b> Select “Handset” and confirm.  |
|  |  |  | <b>3</b> Select “Ringtone” and confirm.   |
|  |  |  | <b>4</b> Select “External” for external calls or select “Internal for internal calls and confirm. |
|  |  |  | <b>5</b> Select the desired melody and confirm.   |
|   |   |   | During scrolling the melody is played.  |
|  |   |   | <b>6</b> Return to standby.   |









#### Ringer volume

You can choose from 5 handset ringer volume levels and off.









- |   |   |   |   |
|---|---|---|---|
|  |   |   | <b>1</b> Enter the menu.                            |
|  |  |  | <b>2</b> Select “Handset” and confirm.              |
|  |  |  | <b>3</b> Select “Ringer volume” and confirm.        |
|   |   |   | The current setting is displayed.                   |
|  |   |   | <b>4</b> Press the up key to increase the volume.   |
|  |   |   | <b>5</b> Press the down key to decrease the volume. |
|  |   |   | <b>6</b> Select “Save” to confirm.                  |
|  |   |   | <b>7</b> Return to standby.                         |

## 6.2 Handset name









You can change the name displayed on the handset during standby (max. 9 characters).

- |   |  |
|---|--|
|    | <b>1</b> Enter the menu.                     |
|   | <b>2</b> Select “Handset” and confirm.       |
|   | <b>3</b> Select “Handset name” and confirm.  |
|    | <b>4</b> Enter the name you want.            |
|    | <b>5</b> Press the soft menu key to correct. |
|    | <b>6</b> Select “Save” to confirm.           |
|    | <b>7</b> Return to standby.                  |

## 6.3 Keypad beeps









- |   |  |
|---|--|
|    | <b>1</b> Enter the menu.                   |
|   | <b>2</b> Select “Handset” and confirm.     |
|   | <b>3</b> Select “Keypad beep” and confirm. |
|   | <b>4</b> Select “On” or “Off” and confirm. |
|    | <b>5</b> Return to standby.                |

## 6.4 Setting the contrast

- |   |  |
|---|--|
|    | <b>1</b> Enter the menu.                                 |
|   | <b>2</b> Select “Handset” and confirm.                   |
|   | <b>3</b> Select “Contrast” and confirm.                  |
|   | <b>4</b> Select the contrast you want (1-8) and confirm. |
|    | <b>5</b> Return to standby.                              |







## 6.5 Autotalk







When there is an incoming call and the handset is on the base, the phone automatically takes the line when lifted from the base. This function can be turned on or off.

- |   |  |
|---|--|
|    | <b>1</b> Enter the menu.                   |
|   | <b>2</b> Select “Handset” and confirm.     |
|   | <b>3</b> Select “Autotalk” and confirm.    |
|   | <b>4</b> Select “On” or “Off” and confirm. |
|    | <b>5</b> Return to standby.                |

## 6.6 Prefix code

It is possible to use your telephone with a prefix number. When dialling telephone numbers, you can add automatically the prefix code before the number.















- |   |  |
|---|--|
|    | <b>1</b> Enter the menu.               |
|   | <b>2</b> Select “Handset” and confirm. |
|   | <b>3</b> Select “Prefix” and confirm.  |
|   | <b>4</b> Select “Edit” and confirm.    |

- |   |   |   |
|---|---|---|
|  |  | <b>5</b> Enter the prefix code, e.g. '0' and select "Save". |
|   |   | OR  |
|  |  | <b>4</b> Select "On/Off" and confirm.                       |
|  |  | <b>5</b> Select "On" or "Off" and confirm.                  |
|  |   | <b>6</b> Return to standby.                                 |









## 6.7 Using the alarm feature

You can have a different alarm setting for each handset registered to your base. The alarm rings only at the handset, not at the base or any other handset.









### Set the alarm

- |   |   |  |
|---|---|--|
|    |   | <b>1</b> Enter the menu.   |
|    |    | <b>2</b> Select "Alarm/Clock" and confirm.   |
|    |    | <b>3</b> Select "Set alarm" and confirm.   |
|    |    | <b>4</b> Select "Once", "On daily", "Mon to Fri" or "Off" and confirm.<br>If you have selected "Once", "On daily" or "Mon to Fri", the display will show:<br>Time (24Hr):<br>00:00 |
|  |  | <b>5</b> Enter the time you want the telephone to ring and confirm with "Save".  |
|  |  | <b>6</b> Select the desired ringtone and confirm with "Save".  |
|  |  | <b>7</b> To deactivate the alarm, select "Off" and confirm.  |
|  |   | <b>8</b> Return to the previous menu.  |

## 6.8 Setting the date and time

- |   |   |   |
|---|---|---|
|  |   | <b>1</b> Enter the menu.  |
|  |  | <b>2</b> Select "Alarm/Clock" and confirm.                                      |
|  |  | <b>3</b> Select "Date & Time" and confirm.                                      |
|  |  | <b>4</b> Enter year, month, day, time and minutes and select "Save" to confirm. |
|  |   | <b>5</b> Return to the previous menu.   |











## 6.9 Setting the time format

- |   |   |   |
|---|---|---|
|  |   | <b>1</b> Enter the menu.                        |
|  |  | <b>2</b> Select "Alarm/Clock" and confirm.      |
|  |  | <b>3</b> Select "Time format" and confirm.      |
|  |  | <b>4</b> Select "12Hrs" or "24Hrs" and confirm. |
|  |   | <b>5</b> Return to the previous menu.           |

## 7 Base settings











### 7.1 Ringtone

You can choose from 9 different ringer melodies.

- |   |   |
|---|---|
|    | <b>1</b> Enter the menu.  |
|    | <b>2</b> Select “Base Settings” and confirm.  |
|    | <b>3</b> Select “Ringtone” and confirm.   |
|    | <b>4</b> Select the desired melody and confirm.<br>During scrolling a sample is played. |
|    | <b>5</b> Return to standby.   |

### 7.2 Ringer Volume

You can choose from 5 base ringer volume levels.











- |   |   |
|---|---|
|    | <b>1</b> Enter the menu.  |
|    | <b>2</b> Select “Base Settings” and confirm.                                      |
|    | <b>3</b> Select “Ringer Volume” and confirm.<br>The current setting is displayed. |
|    | <b>4</b> Press the up key to increase the volume.                                 |
|    | <b>5</b> Press the down key to decrease the volume.                               |
|    | <b>6</b> Select “Save” to confirm.  |
|    | <b>7</b> Return to standby.   |

### 7.3 Dial Mode

There are 2 types of dialling mode:







- DTMF/Tone dialling (most common used)
- Pulse dialling (for older installations)

To change the dialling mode:

- |   |  |
|---|--|
|    | <b>1</b> Enter the menu.                             |
|    | <b>2</b> Select “Base Settings” and confirm.         |
|    | <b>3</b> Select “Dial mode” and confirm.             |
|    | <b>4</b> Select “Tone” or “Pulse” and select “Save”. |
|    | <b>5</b> Return to standby.                          |

### 7.4 Recall (Flash)

Press the Flash key “R” (Key 4 - Picture 2C) to use certain services on your external line such as “call waiting” (if your phone company offers this feature); or to transfer calls if you use a telephone exchange (PABX). The Flash key “R” is a brief interruption of the line. You can set the flash time to 100ms or 250ms.

- |   |  |
|---|--|
|    | <b>1</b> Enter the menu.                     |
|    | <b>2</b> Select “Base Settings” and confirm. |
|    | <b>3</b> Select “Recall” and confirm.        |



**4** Select short flash time (100ms) or long flash time (250ms) and select “Save”.



**5** Return to standby.

## 7.5 System PIN

The System PIN is used for registering and deregistering handsets and some other optional settings. The default System PIN is 0000.



**1** Enter the menu.



**2** Select “Base Settings” and confirm.



**3** Select “System PIN” and confirm.



**4** Enter the old PIN (0000 by default) and select “Save”.



**5** Enter the new PIN, select “Save” and repeat this.



**6** Return to standby.

## 8 Tools

### 8.1 Appointment

You can set 5 appointments or reminders which you can give a name and an alarm by date and time.



**1** Enter the menu.



**2** Select “Tools” and confirm.



**3** Select “Appointments” and confirm.



**4** Select one of the 5 appointments and select “Option”.

To edit the appointment:



**5** Select “Edit” and confirm.



**6** Edit the name of the appointment and select “Save”.



**7** Enter the date of the appointment and select “Save”.



**8** Enter the time and select “Save”.



**9** Select the desired alarm melody and select “Save”.



**10** Return to standby.

To delete the appointment:



**5** Select “Delete” and confirm.



**6** Press the right soft menu key to confirm.



**7** Press the left soft menu key to go back.



**8** Return to standby.

### 8.2 Stopwatch



**1** Enter the menu.







**2** Select “Tools” and confirm.



**3** Select “Stopwatch” and confirm.



- |   |   |
|---|---|
|  | <b>4</b> Select “Start” to start the stopwatch. |
|  | <b>5</b> Select “Stop” to stop the stopwatch.   |
|  | Select “Start” again to restart.                |
|  | Select “Reset” to reset the counter.            |
|  | <b>6</b> Return to standby.                     |

## 9 Additional handsets and base stations



You can subscribe up to 4 handsets on a base. Each handset can register up to 4 base stations and the user can select the base he wants to use.

### 9.1 Adding a new handset















*Only needed when you have deregistered a handset or when you bought a new one.*

To put the base into registration mode:













- |   |  |
|---|--|
|  | <b>1</b> Press and hold the paging key on the base.  |
|  | The LED on the base will start to blink on the base for 90 seconds. During that time, the base is ready to register. |

On the handset:

- |   |   |
|---|---|
|    | <b>1</b> Enter the menu.  |
|   | <b>2</b> Select “Handset” and confirm.  |
|   | <b>3</b> Select “Registration” and confirm.   |
|   | <b>4</b> Select “Register” and confirm.   |
|   | <b>5</b> Select the number of the base to be associated with the handset (1-4) and confirm. |
|   | <b>6</b> Enter the system PIN (0000 by default) and confirm.                                |
|    | <b>7</b> Return to standby.   |











### 9.2 Removing a handset

This procedure needs to be carried out on a different handset than the one you want to remove.

- |   |   |
|---|---|
|    | <b>1</b> Enter the menu.  |
|   | <b>2</b> Select “Handset” and confirm.                                  |
|   | <b>3</b> Select “Registration” and confirm.                             |
|   | <b>4</b> Select “De-Register” and confirm.                              |
|   | <b>5</b> Enter the system PIN (0000 by default) and confirm.            |
|   | <b>6</b> Enter the handset number that needs to be removed and confirm. |
|    | <b>7</b> Return to standby.   |

### 9.3 Select a base

You can switch your handset between bases. You can also set it to automatically base select with the strongest signal. The handset must first be registered with each base individually.



- |   |   |   |
|---|---|---|
| <br><br><br><br><br> | <br><br><br><br><br> | <p><b>1</b> Enter the menu.</p> <p><b>2</b> Select “Handset” and confirm.</p> <p><b>3</b> Select “Select Base” and confirm.</p> <p><b>4</b> Select “Manual” or “Auto” and confirm.</p> <p>If you have selected “Manual”:</p> <p><b>5</b> Select the base to be associated with the handset and confirm.</p> |
|---|---|---|



*When you have activated Automatic base selection and the handset is out of range on the current base, the handset will only search for the strongest base in standby (not during communication).*



### 9.4 Using the intercom feature

#### Calling an internal handset

- |  |  |
|--|--|
| <p>INT</p><br><br> | <p><b>1</b> Press the left key INT.</p> <p>The screen displays “Handset _”.</p> <p><b>2</b> Enter the internal number of the handset you want to call.</p> <p><b>3</b> Press the on-hook key to hang up or put the handset back on the base.</p> |
|--|--|

#### Transfer an external call to another handset

During an external call:



- |  |   |
|--|---|
| <p>INT</p><br><br> | <p><b>1</b> Press the left key INT.</p> <p>The screen displays “Handset _”.</p> <p><b>2</b> Enter the internal number of the handset you want to call.</p> <p>Your external correspondent is placed on hold.</p> <p><b>3</b> When the internal correspondent answers, press the on-hook key to transfer the call.</p> <p>OR</p> |
| <p>INT</p><br>  | <p><b>3</b> If the internal correspondent doesn't answer, press the left key INT to retrieve the external correspondent or to go from one to the other.</p> <p><b>4</b> Press the on-hook key to hang up or put the handset back on the base.</p>   |

#### Conference call

You can talk between 2 handsets and an external line at the same time.

During an external call:



- |   |  |
|---|--|
| <p>INT</p><br> | <p><b>1</b> Press the left key INT.</p> <p>The screen displays “Handset _”.</p> <p><b>2</b> Enter the internal number of the handset you want to call.</p> <p>Your external correspondent is placed on hold.</p> |
|---|--|

-  **3** When the internal correspondent answers, select “Conf.”.
- OR
- INT **3** If the inthernal correspondent doesn’t answer, press the left key INT to retrieve the external correspondent.
-  **4** Press the on-hook key to hang up or put the handset back on the base.

**Taking an external call during an internal communication**

When you are on intercom with another handset, you can still pick up outside calls.

To take an incoming call:

-  **1** Press the on-hook key. The internal communication is now interrupted.
-  **2** Press the off-hook key. You are now in communication with the outside caller.

## 10 Troubleshooting

Symptom	Possible cause	Solution
No display	Batteries uncharged	Check the position of the batteries
		Recharge the batteries
	Handset turned OFF	Turn ON the handset
No tone	Telephone cord badly connected	Check the telephone cord connection
	The line is occupied by another handset	Wait until the other handset hangs up
The icon $\gamma$ flashes	Handset out of range	Bring the handset closer to the base
	The base has no power supply	Check the mains connection to the base
	The handset is not registered on the base	Register the handset on the base
Base or handset do not ring	The ringing volume is off or low	Adjust the ringing volume
Not possible to transfer a call on PABX	The Flash Time is too short or too long	Change the Flash Time
Telephone does not react to pressing the keys	Manipulation error	Remove the batteries and put them back in place

## 11 Technical data Technical characteristics

Standard	<b>DECT(Digital Enhanced Cordless Telecommunications)</b> <b>GAP (Generic Access Profile)</b>
Frequency range	1880 MHz to 1900 MHz
Number of channels	120 duplex channels
Modulation	GFSK
Speech coding	32 kbit/s

Emission power	10 mW ( average power per channel )
Range	300m in open space /50m maximum inhouse
Number of handsets	Up to 4
Base powersupply	230V / 50 Hz / 6V DC 300mA
Handset Batteries:	2 rechargeable batteries AAA, NiMh 1,2V, 700mA
Handset autonomy	110 hours in standby
Handset talk time	11 hours
Normal conditions of use	+5 °C to +45 °C
Dialling mode	Pulse / Tone
Flash time	100 or 250 ms

## 12 Warranty

### 12.1 Warranty period

The Topcom units have a 24-month warranty period. The warranty period starts on the day the new unit is purchased. The warranty on batteries is limited to 6 months after purchase. Consumables or defects causing a negligible effect on operation or value of the equipment are not covered. The warranty has to be proven by presentation of the original purchase receipt, on which the date of purchase and the unit-model are indicated.

### 12.2 Warranty handling

A faulty unit needs to be returned to a Topcom service centre including a valid purchase note. If the unit develops a fault during the warranty period, Topcom or its officially appointed service centre will repair any defects caused by material or manufacturing faults free of charge. Topcom will at its discretion fulfil its warranty obligations by either repairing or exchanging the faulty units or parts of the faulty units. In case of replacement, colour and model can be different from the original purchased unit. The initial purchase date shall determine the start of the warranty period. The warranty period is not extended if the unit is exchanged or repaired by Topcom or its appointed service centres.

### 12.3 Warranty exclusions

Damage or defects caused by incorrect treatment or operation and damage resulting from use of non-original parts or accessories not recommended by Topcom are not covered by the warranty. Topcom cordless phones are designed to work with rechargeable batteries only. The damage caused by the use of non-rechargeable batteries is not covered under warranty. The warranty does not cover damage caused by outside factors, such as lightning, water and fire, nor any damage caused during transportation. No warranty can be claimed if the serial number on the units has been changed, removed or rendered illegible. Any warranty claims will be invalid if the unit has been repaired, altered or modified by the buyer or by unqualified, non-officially appointed Topcom service centres.

## 13 Disposal of the device (environment)



At the end of the product lifecycle, you should not throw this product into the normal household garbage but bring the product to a collection point for the recycling of electrical and electronic equipments. The symbol on the product, user guide and/or box indicate this.

Some of the product materials can be re-used if you bring them to a recycling point.

By re-using some parts or raw materials from used products you make an important contribution to the protection of the environment.

Please contact your local authorities in case you need more information on the collection points in your area.

## 14 Cleaning

Clean the telephone with a slightly damp cloth or with an anti-static cloth. Never use cleaning agents or abrasive solvents.

## 15 ECO (low-radiation) mode

- This cordless telephone (compliant with the DECT standard) facilitates low-radiation operation.
- The radiation intensity of the radio signal between the base station and handset is reduced to a minimum when the handset is on the base station.
- Only when the handset is removed from the base station or a call is received does the radiation intensity of the radio signal increase to the normal strength.
- This does not mean that normal DECT radiation is harmful to health.
- The low-radiation mode prevents unnecessary DECT radiation load when no communication is required between the base station and handset.
- For technical reasons, no additional handsets can be operated in low-radiation mode (an additional handset that is not located in the immediate vicinity of the base station would always be "searching for base station" due to the weak radio signal).
- Low-radiation mode is enabled in the factory settings.
- Low-radiation mode is automatically disabled if you log on an additional handset.
- Low-radiation mode is automatically enabled again when you log off all additional handsets (only one handset may be logged onto the base station).
- The procedure for logging handsets on and off is explained in the User Manual.

## 1 Veiligheidsinstructies

- Gebruik alleen de bijgeleverde stekker van de lader. Gebruik geen andere laders, omdat dit de batterijcellen kan beschadigen.
- Plaats alleen oplaadbare batterijen van hetzelfde type. Gebruik nooit gewone, niet-oplaadbare batterijen. Plaats de oplaadbare batterijen met de polen in de juiste richting (aangegeven in het batterijvak van de handset).
- Raak de contactpunten van de lader en de stekker niet aan met scherpe of metalen objecten.
- De werking van sommige medische instrumenten kan worden beïnvloed.
- De handset kan een onaangenaam zoemend geluid veroorzaken in gehoorapparaten.
- Plaats het basisstation niet in een vochtige ruimte of dichterbij dan 1,5 m in de buurt van een waterbron. De handset niet blootstellen aan water.
- Gebruik de telefoon niet in omgevingen met explosiegevaar.
- Recycleer de batterijen en onderhoud de telefoon op een milieuvriendelijke manier.
- Omdat deze telefoon niet kan worden gebruikt tijdens een stroomuitval, moet u een telefoon gebruiken die niet afhankelijk is van het elektriciteitsnet- bij noodgevallen, bijv. een mobiele telefoon.

## 2 Beginnen

### 2.1 Deze gebruikshandleiding gebruiken

In deze gebruikshandleiding is de volgende methode gebruikt om de instructies te verduidelijken:

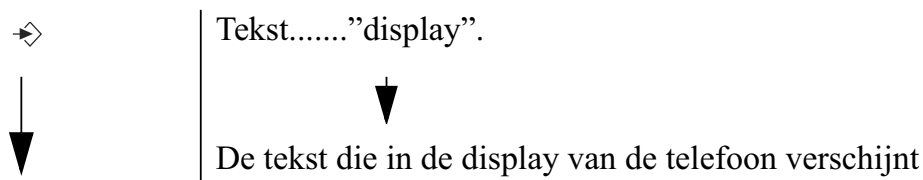

In te drukken toets. Deze toets kan een soft key zijn (Zie “2.4 Toetsen/LED”). Als de soft key een symbool is, staat de toets in de linkerkolom. Als de soft key tekst is, zal de linker of rechter soft key in de linkerkolom worden weergegeven en de tekst tussen aanhalingstekens in de rechterkolom.

### 2.2 De basis installeren

Voer het volgende uit voor de installatie:

- 1** Steek een uiteinde van de adapter in het stopcontact en het andere uiteinde in de aansluiting van de adapter achter op de basis.
- 2** Sluit een uiteinde van de telefoonkabel aan op de telefoonaansluiting aan de wand en het andere uiteinde op de onderzijde van de basis.
- 3** Plaats de telefoon- en wisselstroomkabel in de basisgeleiders, zoals weergegeven in afb. 2A.

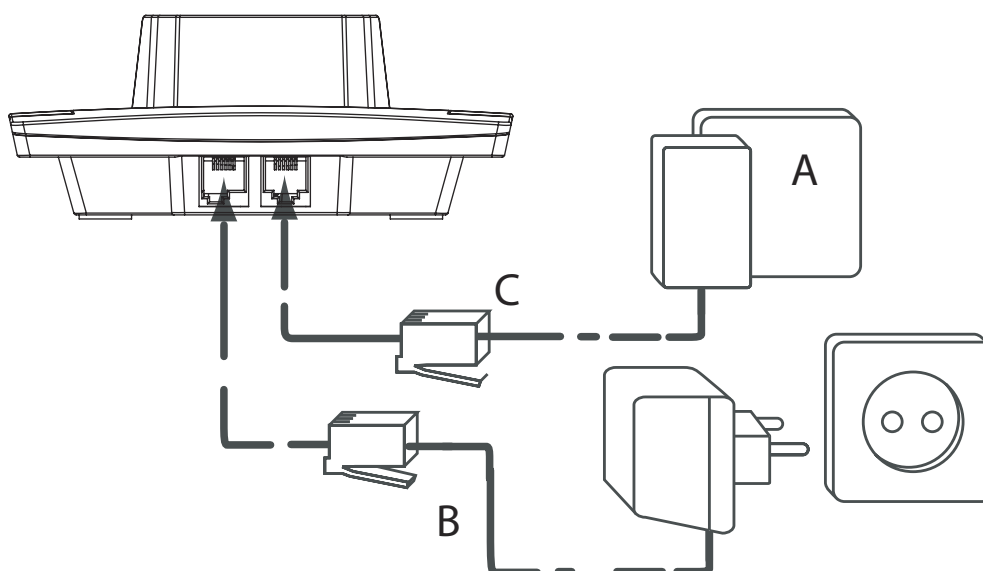

- 2A Achteraanzicht van basis -

A. Telefoonwandcontactdoos

B. Stroomkabel

C. Telefoonkabel

### 2.3 De handset installeren

- 1 Open het batterijgedeelte zoals weergegeven in afb. 2B.
- 2 Plaats de batterijen volgens de polariteit (+ en -).
- 3 Sluit het batterijgedeelte.
- 4 Laat de handset 20 uur op het basisstation staan. De lijn/laad-indicator  op de basis zal gaan branden.

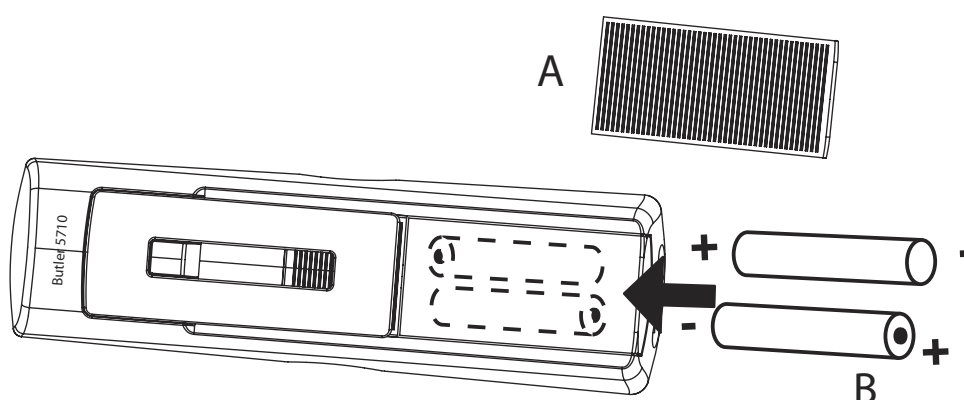

- 2B Achteraanzicht van handset -

A. Afdekplaatje

B. Oplaadbare batterijen



Voordat u de telefoon voor het eerst gebruikt, moet u controleren of de batterij 20 uur is opgeladen. De telefoon zal niet optimaal werken als u dit niet doet.

## 2.4 Toetsen/LED

### Handset

1. Display
2. Omhoog/Redial-toets
3. Rechter soft menu key
4. Rechts/Flash-toets
5. Opleggen/UIT-toets
6. Alfnumerieke toetsen
7. Toetsvergrendeling
8. Beltoon uit-toets
9. Omlaag/oproeplogbestand-toets
10. Opnemen-toets/handenvrij/Aan-toets
11. Links/INT-toets
12. OK-toets
13. Linker soft menu key

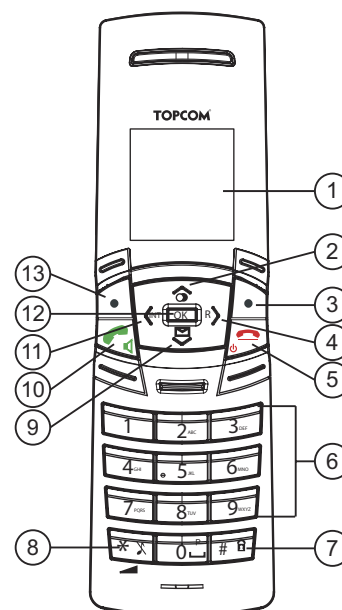

- 2C Handset -





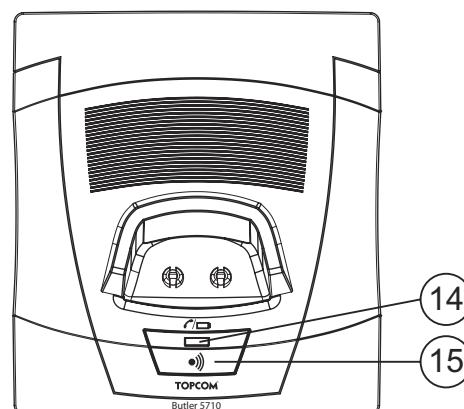









### Basis

14. In gebruik/Aan-Uit/handset op basis-LED
15. Paging-toets



- 2D Basis -

## 2.5 Symbolen

	Opnemen		Toetsvergrendeling
	Opleggen		Alarmset
	Gemiste oproepen in oproeplijst*		Handset niet geregistreerd of buiten bereik
	Belvolume van handset UIT		Batterij leeg
	Handset binnen bereik van basis		Batterij bijna leeg
	Internat. oproep		Batterij halfleeg
	Handenvrij		Batterij vol
	Nieuwe voicemail		

\* Als nummerweergave oproeper beschikbaar is op de telefoonlijn.



## 2.6 Displaytoetsen

Displaytoetsen (soft keys) bevinden zich direct onder de display. De functie van deze 2 toetsen verandert naargelang de gebruiksmodus. De werkelijke functie wordt weergegeven als pictogram of tekst direct boven de 2 toetsen.

	Telefoonboek		Dempen
	OK/Bevestigen		Terug
	Menu		Geen toets
	Wissen		





## 2.7 Basis-LED

De LED (14) geeft de volgende status weer:



- UIT: geen stroom op de basis aangesloten of handset staat niet in de basis om op te laden.
- AAN: handset is bezig met laden
- Langzaam knipperen: Opgenomen of tijdens het bellen
- Snel knipperen: tijdens de registratie

## 2.8 Door het menu bladeren

De Butler 5710 heeft een gebruiksvriendelijk menusysteem. Elk menu geeft een lijst met opties. De menukaart staat in de volgende paragraaf.

- |   |  |
|---|--|
|  | <b>1</b> Wanneer de handset wordt ingeschakeld en in standby staat, drukt u op de linker soft menu key  om het hoofdmenu te openen. |
|  | <b>2</b> Blader naar de gewenste menuoptie.  |
|  | <b>3</b> Druk op de soft menu key om de overige opties te bekijken of de weergegeven instelling te bevestigen.   |

### Afsluiten of een niveau in het menu teruggaan.

- |   |   |
|---|---|
|  | Druk op de soft menu key om naar het vorige niveau in het menu terug te gaan.                       |
|  | Druk op de opleggen-toets om op een willekeurig moment te annuleren en terug te keren naar standby. |

## 2.9 Menuoverzicht

Menu	Submenu-items
Handset	Beltoon Belvolume Handset naam Toetstoon Contrast Autom. Anne. Prefix Kies basis Taal Registratie
Basis instellingen	Beltoon Belvolume Kiesmodus Recall Systeem PIN
Alarm/Klok	Alarm instellen Dag & Tijd Tijdformaat
Hulpmiddelen	Afspraak Chronometer
Uitschakelen	

## 3 De telefoon gebruiken

### 3.1 De handset in- en uitschakelen



- 1 De UIT-toets ingedrukt houden om de handset uit te schakelen.
- 2 Druk op de opnemen-toets of plaats de handset op de basis om de handset weer in te schakelen.

### 3.2 De menutaal veranderen



- 1 Selecteer het menu.
- 2 Selecteer “Handset” en bevestig.
- 3 Selecteer “Taal” en bevestig.
- 4 Selecteer een taal en bevestig.  
Het scherm geeft “Opgeslagen” weer.
- 5 Druk op de opleggen-toets om terug te keren naar standby.



De  pijlen geven aan dat er nog meer opties mogelijk zijn in het menu.

### 3.3 Een normaal telefoongesprek voeren

#### Direct kiezen



- 1** Druk op de opnemen-toets om het nummer te bellen.
- 2** Voer het telefoonnummer in.
- 3** Druk op de opleggen-toets om op te hangen of zet de handset terug op de basis.

#### Voorkiezen

Met de voorkiesfunctie kunt u een telefoonnummer invoeren en aanpassen voordat u gaat bellen.



- 1** Kies een telefoonnummer van maximaal 24 cijfers.  
Houd de 0-toets ingedrukt om een pauze in te voegen. Het scherm geeft een "P" weer.
- 2** Druk op de soft menu key om te corrigeren.
- 3** Druk op de opnemen-toets om het nummer te bellen.
- 4** Druk op de opleggen-toets om op te hangen of zet de handset terug op de basis.

#### Een telefoonnummer bellen uit de lijst

U kunt maximaal 10 van de laatste oproepen terugbellen. Als u een naam in het telefoonboek hebt opgeslagen die bij het nummer hoort, zal de naam worden weergegeven.

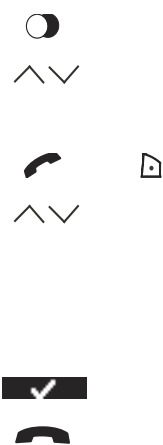

- 1** Druk op de redial-toets.
- 2** Selecteer een nummer. De naam wordt weergegeven als het nummer in het telefoonboek staat.
- 3** Druk op de opnemen-toets om het nummer te bellen of selecteer "Optie".
- 4** Blader na het selecteren van "Optie" en selecteer:  
"Wis oproep": om het nummer uit de oproeplijst te verwijderen;  
"Sla nr. op": om het nummer in het telefoonboek op te slaan;  
"Wis alles": om de oproeplijst te wissen.
- 5** Bevestig de selectie.
- 6** Druk op de opleggen-toets om terug te keren naar standby.

### 3.4 Een telefoontje ontvangen

Het scherm geeft "Externe oproep" weer als u een externe oproep ontvangt.

Om de oproep aan te nemen:



- 1** Druk op de opnemen-toets.  
OF  
Neem de handset van de basis als u "Autom. aanne." heeft geselecteerd (Zie "6.5 Automatisch aannemen")  
De oproep in het voortgangspictogram  verschijnt op het scherm. De oproepduur wordt na 15 seconden weergegeven.
- 2** Druk op de opleggen-toets om op te hangen of zet de handset terug op de basis.



*U kunt het belvolume uitzetten tijdens inkomende oproep door "Stil" te selecteren.*

### 3.5 Handenvrij-modus

Met handenvrij kunt u met uw oproeper praten zonder de handset vast te houden. Andere mensen in de kamer kunnen ook meeluisteren naar beide sprekers tijdens uw gesprek.



- 1 Druk op de handenvrij-toets tijdens een oproep om naar handenvrij over te schakelen.

### 3.6 Oorstuk/handenvrij-volume afstellen



- 1 Druk op omhoog of omlaag om volume 1 - 5 te selecteren tijdens een normale of handenvrije oproep.

### 3.7 Geheimhoudingsfunctie (Microfoon uit-functie)

Om de microfoon uit te schakelen zodat de persoon aan de andere kant van de lijn u niet kan verstaan.



- 1 Druk tijdens een gesprek op de soft menu key om de microfoon uit te schakelen.

“Mute Aan” verschijnt in de display.



- 2 Selecteer “Uit” om de microfoon weer te activeren.

### 3.8 Een handset vinden (Paging-functie)



- 1 Druk op de paging-toets op het basisstation.

Alle handsets die bij de basis staan geregistreerd zullen 30 seconden rinkelen.



- 2 Druk op een willekeurige toets op de handset om paging te stoppen.

### 3.9 Toetsenbordvergrendeling

Om het toetsenbord te vergrendelen zodat u niet per ongeluk een nummer kunt kiezen tijdens het rondlopen met de handset.

In standby:



- 1 Houd de toetsenbordvergrendeling-toets (toets 7 - afb. 2C) ingedrukt totdat “Geblokkeerd” en het toetsenbordvergrendelingspictogram  in de display verschijnen.



- 2 Selecteer “Vrijgeven” gevolgd door de toetsenbordvergrendelingstoets om het toetsenblok vrij te geven.

### 3.10 Het alfanumerieke toetsenbord gebruiken

Met uw telefoon kunt u ook alfanumerieke tekens invoeren. Dit is handig om een naam in het telefoonboek te plaatsen, een naam te geven aan de handset, enz.





Om een letter te selecteren: druk zo vaak als nodig is op de bijbehorende toets.

Bijvoorbeeld: druk eenmaal op ‘2’ om ‘A’ te selecteren. Druk tweemaal op ‘2’ om ‘B’ te selecteren, enz.

Druk eenmaal op ‘2’ en wacht totdat de aanwijzer naar het volgende teken gaat en druk tweemaal op ‘2’ om eerst ‘A’ en vervolgens ‘B’ te selecteren.

Tijdens het invoeren van tekst verschijnt het beschikbare teken onder elke toets onder in de display.











U kunt de tekenset voor het invoeren van tekst wijzigen van Engels (abc) naar Latijns (aàá), Grieks ( ABΓ) of Russisch ( ABB) door de #-toets in te drukken en ingedrukt te houden gedurende 2 seconden.

	Druk op '0' om een spatie te selecteren.
	Druk op de *-toets om tussen kleine letters en hoofdletters te wisselen.
	Houd de #-toets gedurende 2 seconden ingedrukt om de tekenset te veranderen.
	Druk op de soft menu key om te corrigeren.





## 4 Telefoonboek

Elke handset kan maximaal 200 namen en nummers opslaan. De namen kunnen 16 tekens lang zijn en de nummers maximaal 24 cijfers.







### 4.1 Een invoer toevoegen

	<b>1</b> Druk op de soft menu key.
	Als het telefoonboek leeg is, verschijnt “Telefoonboek leeg” in de display. De namen staan in de lijst als ze zijn opgeslagen.
	<b>2</b> Selecteer “Optie”.
 	<b>3</b> Selecteer “Nieuwe invoer” en bevestig.
 	<b>4</b> Gebruik het toetsenbord om de naam in te voeren en selecteer “Opslaan”.
 	<b>5</b> Gebruik het toetsenbord om het nummer in te voeren en selecteer “Opslaan”.
 	<b>6</b> Selecteer de gewenste belmelodie en selecteer “Opslaan”.
	<b>7</b> Terug naar standby.

### 4.2 Een invoer kiezen

	<b>1</b> Druk op de soft menu key.
	<b>2</b> Selecteer de gewenste naam of gebruik het toetsenbord om de eerste letter van de naam in te voeren.
	<b>3</b> Druk op de opnemen-toets om het nummer te bellen.
	<b>4</b> Terug naar standby.

### 4.3 Details tonen

	<b>1</b> Druk op de soft menu key.
	<b>2</b> Selecteer de gewenste naam of gebruik het toetsenbord om de eerste letter van de naam in te voeren.
	<b>3</b> Selecteer “Optie”.
 	<b>4</b> Selecteer “Details” en bevestig.
	De naam, het nummer en de toegewezen belmelodie verschijnen in de display.
	<b>5</b> Terug naar standby.

#### 4.4 Een invoer of alle invoeren wissen



- 1** Druk op de soft menu key.
- 2** Selecteer de gewenste naam of gebruik het toetsenbord om de eerste letter van de naam in te voeren.

- 3** Selecteer “Optie”.

Een invoer wissen:

- 4** Selecteer “Invoer wissen” en bevestig.

Alle invoeren wissen:

- 4** Selecteer “Wis alles” en bevestig.

- 5** Druk op de linker menu-toets om te annuleren of op de rechter menu-toets om te bevestigen.

- 6** Terug naar standby.

#### 4.5 Naam en nummer bewerken



- 1** Druk op de soft menu key.
- 2** Selecteer de gewenste naam of gebruik het toetsenbord om de eerste letter van de naam in te voeren.

- 3** Selecteer “Optie”.

- 4** Selecteer “Bewerk invoer” en bevestig.

- 5** Druk op de soft key om te wissen en gebruik het toetsenbord om de naam te veranderen.

- 6** Selecteer “Opslaan”.

- 7** Bewerk het nummer en selecteer “Opslaan”.

- 8** Selecteer de gewenste belmelodie en selecteer “Opslaan”.

- 9** Terug naar standby.

#### 4.6 Een telefoonboekinvoer naar een andere handset kopiëren



- 1** Druk op de soft menu key.
- 2** Selecteer de gewenste naam of gebruik het toetsenbord om de eerste letter van de naam in te voeren.

- 3** Selecteer “Optie”.

- 4** Selecteer “Kopie invoer” en bevestig.

De beschikbare handsets (alle handsets die op de basis staan geregistreerd) worden weergegeven.

- 5** Selecteer de gewenste handset en bevestig.

“Kopiëren naar handset x” verschijnt in de display.

“Ontvang record telefoonboek?” verschijnt in de display van de bestemmingshandset.

- 6** Druk op de bestemmingshandset op de rechter menu-toets om te bevestigen of op de linker menu-toets om de overdracht te annuleren.

- 7** Terug naar standby.

## 4.7 Alle telefoonboekinvoeren naar een andere handset kopiëren



*Door alle invoeren van een handset naar een andere te kopiëren, wist u alle bestaande records in de bestemmingshandset.*



**1** Druk op de soft menu key.



**2** Selecteer de gewenste naam of gebruik het toetsenbord om de eerste letter van de naam in te voeren.



**3** Selecteer "Optie".



**4** Selecteer "Kopie alles" en bevestig.

De beschikbare handsets (alle handsets die op de basis staan geregistreerd) worden weergegeven.



**5** Selecteer de gewenste handset en bevestig.

"Kopiëren naar handset x" verschijnt in de display.

"Vervang alle records?" verschijnt in de display van de bestemmingshandset.



**6** Druk op de bestemmingshandset op de rechter menu-toets om te bevestigen of op de linker menu-toets om de overdracht te annuleren.



**7** Terug naar standby.

## 5 Nummerherkenning van oproeper

### 5.1 Normale inkomende PSTN-oproepen



*Deze dienst werkt alleen als u bent geabonneerd op nummerherkenning van oproeper/clip. Neem hiervoor contact op met uw telefoonmaatschappij.*

Bij ontvangst van een oproep van uw vaste telefoonlijn, verschijnt het telefoonnummer van de oproeper op de display van de handset. De telefoon kan oproepen ontvangen in zowel FSK als DTMF. U kunt ook zijn of haar naam zien als deze wordt verzonden door het netwerk. Als de naam in het telefoonboek is geprogrammeerd, zal de naam uit het telefoonboek worden weergegeven! De telefoon kan 30 oproepen opslaan in de oproeplijst (ontvangen en gemist) die later bekeken kunnen worden. Als het geheugen vol is, zullen de nieuwe oproepen automatisch de oudste oproepen in het geheugen vervangen.



Gemiste oproepen worden aangegeven met een knipperend pictogram op de display. De naam van de handset wordt vervangen door dit pictogram en het aantal gemiste oproepen.

### De ontvangen oproepen lezen



**1** Druk op de omlaag-toets.

De lijst met ontvangen oproepen verschijnt op de display. Dit is een combinatie van ontvangen en gemiste oproepen.



**2** Selecteer de/het gewenste naam of nummer.



**3** Druk op de opnemen-toets om het nummer te bellen.  
OF



Selecteer "Optie".



Een invoer wissen:

**4** Selecteer “Wis oproep” en bevestig.

**5** Terug naar standby.

Alle invoeren wissen:



**5** Selecteer “Wis alles” en bevestig.

**6** Terug naar standby.

Het nummer aan het telefoonboek toevoegen:



**5** Selecteer “Sla nr. op” en bevestig.

**6** Gebruik het toetsenbord om de naam in te voeren en selecteer “Opslaan”.

**7** Gebruik het toetsenbord om het nummer te bewerken en selecteer “Opslaan”.



**8** Selecteer de gewenste belmelodie en selecteer “Opslaan”.

**9** Terug naar standby.

## 6 De handset naar eigen wens instellen

### 6.1 Beltoon en belvolume

#### Beltoon

U kunt kiezen uit 18 verschillende belmelodieën voor interne en externe oproepen.



**1** Selecteer het menu.

**2** Selecteer “Handset” en bevestig.

**3** Selecteer “Beltoon.” en bevestig.

**4** Selecteer “Extern” voor externe oproepen of selecteer “Intern” voor interne oproepen en bevestig.

**5** Selecteer de gewenste melodie en bevestig.

Tijdens het bladeren wordt de melodie afgespeeld.

**6** Terug naar standby.

#### Belvolume

U kunt kiezen uit 5 belvolumeniveaus en uit voor de handset.

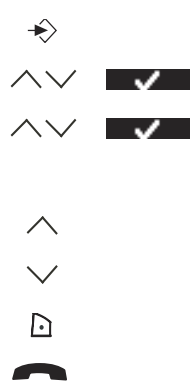

**1** Selecteer het menu.

**2** Selecteer “Handset” en bevestig.

**3** Selecteer “Belvolume” en bevestig.

De huidige instelling wordt weergegeven.

**4** Druk op de toets omhoog om het volume te verhogen.

**5** Druk op de toets omlaag om het volume te verlagen.









**6** Selecteer “Opslaan” om te bevestigen.

**7** Terug naar standby.











## 6.2 Handset naam









U kunt de weergegeven naam op de handset veranderen in standby (max. 9 tekens).

- |   |          |  |
|---|----------|--|
|    | <b>1</b> | Selecteer het menu.                        |
|   | <b>2</b> | Selecteer "Handset" en bevestig.           |
|   | <b>3</b> | Selecteer "Handset naam" en bevestig.      |
|    | <b>4</b> | Voer de gewenste naam in.                  |
|    | <b>5</b> | Druk op de soft menu key om te corrigeren. |
|    | <b>6</b> | Selecteer "Opslaan" om te bevestigen.      |
|    | <b>7</b> | Terug naar standby.                        |

## 6.3 Toetstoon









- |   |          |                                       |
|---|----------|---------------------------------------|
|    | <b>1</b> | Selecteer het menu.                   |
|   | <b>2</b> | Selecteer "Handset" en bevestig.      |
|   | <b>3</b> | Selecteer "Toetstoon" en bevestig.    |
|   | <b>4</b> | Selecteer "Aan" of "Uit" en bevestig. |
|    | <b>5</b> | Terug naar standby.                   |

## 6.4 Het contrast instellen

- |   |          |  |
|---|----------|--|
|    | <b>1</b> | Selecteer het menu.                                  |
|   | <b>2</b> | Selecteer "Handset" en bevestig.                     |
|   | <b>3</b> | Selecteer "Contrast" en bevestig.                    |
|   | <b>4</b> | Selecteer het gewenste contrast (1 - 8) en bevestig. |
|    | <b>5</b> | Terug naar standby.                                  |





## 6.5 Automatisch aannemen













Als er een inkomende oproep is en de handset op de basis staat, zal de telefoon automatisch de oproep aannemen als deze van de basis wordt gehaald. Deze functie kan in- of uitgeschakeld worden.

- |   |          |  |
|---|----------|--|
|    | <b>1</b> | Selecteer het menu.                    |
|   | <b>2</b> | Selecteer "Handset" en bevestig.       |
|   | <b>3</b> | Selecteer "Autom. aanne." en bevestig. |
|   | <b>4</b> | Selecteer "Aan" of "Uit" en bevestig.  |
|    | <b>5</b> | Terug naar standby.                    |

## 6.6 Prefixcode

Het is mogelijk om uw telefoon te gebruiken met een prefixnummer. Bij het kiezen van telefoonnummers, kunt u automatisch de prefixcode voor het nummer toevoegen.



















- |   |          |                                  |
|---|----------|----------------------------------|
|    | <b>1</b> | Selecteer het menu.              |
|   | <b>2</b> | Selecteer "Handset" en bevestig. |
|   | <b>3</b> | Selecteer "Prefix" en bevestig.  |

- |   |   |   |   |
|---|---|---|---|
|  |  |  | <b>4</b> Selecteer “Bewerken” en bevestig.                        |
|  |  |   | <b>5</b> Voer de prefixcode in, bijv. ‘0’ en selecteer “Opslaan”. |
|   |   |   | OF  |
|  |  |  | <b>4</b> Selecteer “Aan/Uit” en bevestig.                         |
|  |  |  | <b>5</b> Selecteer “Aan” of “Uit” en bevestig.                    |
|  |   |   | <b>6</b> Terug naar standby.                                      |











## 6.7 De alarmfunctie gebruiken

U kunt een andere alarminstelling hebben voor elke handset die op uw basis is geregistreerd. Het alarm gaat alleen af op de handset en niet op de basis of een andere handset.











### Het alarm instellen

- |   |   |   |  |
|---|---|---|--|
|    |   | <b>1</b> Selecteer het menu.  |  |
|    |    |    | <b>2</b> Selecteer “Alarm/Klok” en bevestig.   |
|    |    |    | <b>3</b> Selecteer “Zet Alarm” en bevestig.  |
|    |    |    | <b>4</b> Selecteer “Eén keer”, “Dagelijks aan”, “Ma tot Vr” of “Uit” en bevestig.<br>Na het selecteren van “Eén keer”, “Dagelijks aan” of “Ma tot Vr” verschijnt er in de display:<br>Tijd (24h):<br>00:00 |
|  |  |   | <b>5</b> Voer de tijd in waarop u wilt dat de telefoon rinkelt en bevestig met “Opslaan”.  |
|  |  |  | <b>6</b> Selecteer de gewenste beltoon en bevestig met “Opslaan”.  |
|  |  |  | <b>7</b> Selecteer “Uit” en bevestig om het alarm uit te zetten.   |
|  |   |   | <b>8</b> Terug naar het vorige menu.   |

## 6.8 Dag en tijd instellen

- |   |   |   |   |
|---|---|---|---|
|  |   | <b>1</b> Selecteer het menu.  |   |
|  |  |  | <b>2</b> Selecteer “Alarm/Klok” en bevestig.  |
|  |  |  | <b>3</b> Selecteer “Dag & Tijd” en bevestig.  |
|  |  |   | <b>4</b> Voer het jaar, maand, dag, tijd en minuten in en selecteer “Opslaan” om te bevestigen. |
|  |   |   | <b>5</b> Terug naar het vorige menu.  |









## 6.9 Het tijdformaat instellen

- |   |   |   |  |
|---|---|---|--|
|  |   | <b>1</b> Selecteer het menu.  |  |
|  |  |  | <b>2</b> Selecteer “Alarm/Klok” en bevestig.   |
|  |  |  | <b>3</b> Selecteer “Tijdformaat.” en bevestig. |
|  |  |  | <b>4</b> Selecteer “12h” of “24h” en bevestig. |
|  |   |   | <b>5</b> Terug naar het vorige menu.           |

## 7 Basis instellingen









### 7.1 Beltoon

U kunt kiezen uit 9 verschillende belmelodieën.

- |   |   |
|---|---|
|    | <b>1</b> Selecteer het menu.                          |
|   | <b>2</b> Selecteer “Basis inst.” en bevestig.         |
|   | <b>3</b> Selecteer “Beltoon.” en bevestig.            |
|   | <b>4</b> Selecteer de gewenste melodie en bevestig.   |
|   | Tijdens het bladeren wordt het voorbeeld weergegeven. |
|    | <b>5</b> Terug naar standby.                          |

### 7.2 Belvolume

U kunt kiezen uit 5 belvolumeniveaus voor het basisstation.









- |   |   |
|---|---|
|    | <b>1</b> Selecteer het menu.                                |
|   | <b>2</b> Selecteer “Basis inst.” en bevestig.               |
|   | <b>3</b> Selecteer “Belvolume” en bevestig.                 |
|   | De huidige instelling wordt weergegeven.                    |
|    | <b>4</b> Druk op de toets omhoog om het volume te verhogen. |
|    | <b>5</b> Druk op de toets omlaag om het volume te verlagen. |
|    | <b>6</b> Selecteer “Opslaan” om te bevestigen.              |
|    | <b>7</b> Terug naar standby.                                |

### 7.3 Kiesmodus

Er zijn twee belmodi:





- DTMF/Toonkiezen (het meeste gebruikt)
- Pulskiezen (voor oudere installaties)

De belmodus veranderen:

- |   |   |
|---|---|
|    | <b>1</b> Selecteer het menu.                                |
|   | <b>2</b> Selecteer “Basis inst.” en bevestig.               |
|   | <b>3</b> Selecteer “Kiesmodus.” en bevestig.                |
|   | <b>4</b> Selecteer “Toon” of “Puls” en selecteer “Opslaan”. |
|    | <b>5</b> Terug naar standby.                                |

### 7.4 Recall (Flash)

Druk op de flashtoets “R” (toets 4 - afb. 2C) om bepaalde diensten op uw externe lijn te gebruiken, zoals “oproep in de wacht” (als uw telefoonmaatschappij deze functie aanbiedt); of om oproepen door te schakelen als u een telefoonuitwisseling gebruikt (PABX). De flashtoets “R” is een korte onderbreking van de lijn. U kunt de flashtijd instellen tot 100 ms of 250 ms.

- |   |   |
|---|---|
|    | <b>1</b> Selecteer het menu.                  |
|   | <b>2</b> Selecteer “Basis inst.” en bevestig. |
|   | <b>3</b> Selecteer “Recall” en bevestig.      |



**4** Selecteer de korte flashtijd (100 ms) of de lange flashtijd (250 ms) en selecteer “Opslaan”.



**5** Terug naar standby.

## 7.5 Systeem PIN

De systeem PIN wordt gebruikt voor het registreren en het verwijderen van de registratie van de handset en sommige andere optionele instellingen. De standaard systeem PIN is 0000.



**1** Selecteer het menu.



**2** Selecteer “Basis inst.” en bevestig.



**3** Selecteer “Systeem PIN” en bevestig.



**4** Voer de oude PIN in (standaard 0000) en selecteer “Opslaan”.



**5** Voer de nieuwe PIN in, selecteer “Opslaan” en herhaal dit.



**6** Terug naar standby.

## 8 Hulpmiddelen

### 8.1 Afspraak

U kunt 5 afspraken of herinneringen instellen die u een naam en een alarm op dag en tijd kunt geven.



**1** Selecteer het menu.



**2** Selecteer “Hulpmiddelen” en bevestig.



**3** Selecteer “Afspraken” en bevestig.



**4** Selecteer één van de 5 afspraken en selecteer “Optie”.

De afspraak bewerken:



**5** Selecteer “Bewerken” en bevestig.



**6** Bewerk de naam van de afspraak en selecteer “Opslaan”.



**7** Bewerk de dag van de afspraak en selecteer “Opslaan”.



**8** Bewerk de tijd en selecteer “Opslaan”.



**9** Selecteer de gewenste alarmmelodie en selecteer “Opslaan”.



**10** Terug naar standby.

De afspraak wissen:



**5** Selecteer “Wissen” en bevestig.



**6** Druk op de rechter menu-toets om te bevestigen.



**7** Druk op de linker menu-toets om terug te gaan.



**8** Terug naar standby.

### 8.2 Chronometer



**1** Selecteer het menu.



**2** Selecteer “Hulpmiddelen” en bevestig.



**3** Selecteer “Chronometer” en bevestig.



**4** Selecteer “Start” om de chronometer te starten.



- 5** Selecteer “Stop” om de chronometer te stoppen.
- Selecteer nogmaals “Start” om opnieuw te starten.
- Selecteer “Reset” om de teller te resetten.
- 6** Terug naar standby.

## 9 Extra handsets en basisstations

U kunt 4 handsets aanmelden bij één basisstation. Elke handset kan max. 4 basisstations registreren en de gebruiker kan de gewenste basis selecteren.

### 9.1 Een nieuwe handset toevoegen



*Alleen nodig wanneer u de registratie van een handset hebt verwijderd of wanneer u een nieuwe hebt aangeschaft.*

De basis in de registratiemodus zetten:



- 1** Houd de paging-toets op het basisstation ingedrukt.
- De LED op de basis zal gaan knipperen gedurende 90 seconden. Op dat moment is de basis gereed om te registreren.

Op de handset:



- 1** Selecteer het menu.
- 2** Selecteer “Handset” en bevestig.
- 3** Selecteer “Aanmelden” en bevestig.
- 4** Selecteer “Handset aanm.” en bevestig.
- 5** Selecteer het nummer van de basis dat moet worden gekoppeld aan de handset (1 - 4) en bevestig.
- 6** Voer de systeem PIN in (standaard 0000) en bevestig.
- 7** Terug naar standby.

### 9.2 Een handset verwijderen



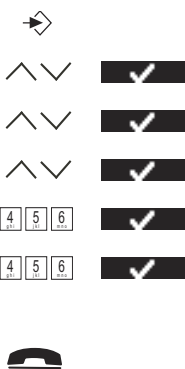

Deze procedure moet worden uitgevoerd op een andere handset dan die u wilt verwijderen.



- 1** Selecteer het menu.
- 2** Selecteer “Handset” en bevestig.
- 3** Selecteer “Aanmelden” en bevestig.
- 4** Selecteer “Handset afm.” en bevestig.
- 5** Voer de systeem PIN in (standaard 0000) en bevestig.
- 6** Voer het nummer van de handset in dat moet worden verwijderd en bevestig.
- 7** Terug naar standby.

### 9.3 Een basis selecteren

U kunt uw handset tussen basisstations wisselen. U kunt de handset ook instellen om automatisch de basis te selecteren met het sterkste signaal. De handset moet eerst apart worden geregistreerd bij elke basis.

- |   |  |
|---|--|
| <br><br><br><br><br> | <p><b>1</b> Selecteer het menu.</p> <p><b>2</b> Selecteer “Handset” en bevestig.</p> <p><b>3</b> Selecteer “Kies basis.” en bevestig.</p> <p><b>4</b> Selecteer “Manueel” of “Auto” en bevestig.</p> <p>Bij het selecteren van “Manueel”:</p> <p><b>5</b> Selecteer de basis die moet worden gekoppeld aan de handset en bevestig.</p> |
|---|--|



*Als u automatische basisselectie hebt geselecteerd en de handset buiten bereik is van de huidige basis, zal de handset alleen zoeken naar de sterkste basis in standby (niet tijdens communicatie).*



### 9.4 De intercomfunctie gebruiken

#### Een interne handset bellen

- |  |  |
|--|--|
| <p>INT</p><br><br> | <p><b>1</b> Druk op de linker INT-toets.</p> <p>Het scherm geeft “Handset _” weer.</p> <p><b>2</b> Voer het interne nummer van de handset in dat u wilt bellen.</p> <p><b>3</b> Druk op de opleggen-toets om op te hangen of zet de handset terug op de basis.</p> |
|--|--|

#### Een externe oproep naar een andere handset doorschakelen

Tijdens een externe oproep:

- |  |   |
|--|---|
| <p>INT</p><br><br> | <p><b>1</b> Druk op de linker INT-toets.</p> <p>Het scherm geeft “Handset _” weer.</p> <p><b>2</b> Voer het interne nummer van de handset in dat u wilt bellen.</p> <p>Uw externe correspondent wordt in de wacht geplaatst.</p> <p><b>3</b> Als de interne correspondent opneemt, drukt u op de opleggen-toets om de oproep door te schakelen.</p> <p>OF</p> |
| <p>INT</p><br>  | <p><b>3</b> Als de interne correspondent niet opneemt, drukt u op de linker INT-toets om de externe correspondent weer terug te halen of van de een naar de ander te gaan.</p> <p><b>4</b> Druk op de opleggen-toets om op te hangen of zet de handset terug op de basis.</p>   |

#### Conferentiegesprek

U kunt tegelijkertijd met 2 handsets en een externe lijn praten.

Tijdens een externe oproep:

- |   |   |
|---|---|
| <p>INT</p><br> | <p><b>1</b> Druk op de linker INT-toets.</p> <p>Het scherm geeft “Handset _” weer.</p> <p><b>2</b> Voer het interne nummer van de handset in dat u wilt bellen.</p> |
|---|---|

-  Uw externe correspondent wordt in de wacht geplaatst.
- 3** Selecteer “Conf.” als de interne correspondent opneemt.
- OF
- 3** Druk op de linker INT-toets om de externe correspondent weer terug te halen als de interne correspondent niet opneemt.
- 4** Druk op de opleggen-toets om op te hangen of zet de handset terug op de basis.

### Een externe oproep aannemen tijdens een interne communicatie

Als u met een andere handset op de intercom zit, kunt u nog altijd externe oproepen aannemen.

Een inkomende oproep aannemen:



- 1** Druk op de opleggen-toets. De interne communicatie wordt nu onderbroken.
- 2** Druk op de opnemen-toets. U staat nu in verbinding met de externe oproeper.

## 10 Probleemoplossing

Symptoom	Mogelijke oorzaak	Oplossing
Geen weergave	Batterijen zijn leeg	Controleer de positie van de batterijen
		Laad de batterijen op
	Handset <b>UITGESCHAKELD</b>	Schakel de handset <b>IN</b>
Geen toon	Telefoonkabel is slecht aangesloten	Controleer de aansluiting van de telefoonkabel
	De lijn is bezet door een andere handset	Wacht totdat de andere handset het gesprek heeft beëindigd
Het pictogram  knippert	Handset is buiten bereik	Breng de handset dichterbij de buurt van het basisstation
	Het basisstation heeft geen stroom	Controleer de aansluiting van de stroomkabel bij het basisstation
	De handset is niet aangemeld op het basisstation	Meld de handset aan bij het basisstation
Basisstation of handset laat geen beltoon horen	Het beltoonvolume staat uit of is te laag	Pas het volume van de beltoon aan
Niet mogelijk om een gesprek naar PABX door te schakelen	De flashtijd is te kort of te lang	De flashtijd veranderen
De telefoon reageert niet op het indrukken van de toetsen	Gebruikersfout	Verwijder de batterijen en plaats ze weer terug

## 11 Technische gegevens Technische eigenschappen

Standaard	<b>DECT (Digital Enhanced Cordless Telecommunications)</b> <b>GAP (Generic Access Profile)</b>
Frequentiebereik	1880 MHz tot 1900 MHz
Aantal kanalen	120 duplex kanalen
Modulatie	GFSK
Spraakcodering	32 kbit/s
Emissievermogen	10 mW (gemiddeld vermogen per kanaal)
Bereik	300 m in open ruimte / max. 50 m binnenshuis
Aantal handsets	Max. 4
Stroomvoorziening basisstation	230 V / 50 Hz / 6 V gelijkstroom 300 mA
Batterijen van handset:	2 oplaadbare batterijen AAA, NiMh 1,2 V, 700 mA
Autonomie van handset	110 uur in standby
Gesprekstijd van handset	11 uur
Normale gebruiksomstandigheden	+5 °C tot +45 °C
Belmodus	Puls / Toon
Flashtijd	100 of 250 ms

## 12 Garantie

### 12.1 Garantieperiode

De Topcom-eenheden hebben een garantieperiode van 24 maanden. De garantieperiode begint op de dag waarop het nieuwe toestel wordt gekocht. De garantie op de batterijen is beperkt tot 6 maanden na aankoop. Kleine onderdelen of defecten die een verwaarloosbaar effect hebben op de werking of waarde van het toestel worden niet gedekt door de garantie.

De garantie moet worden bewezen door het kunnen overleggen van de originele aankoopbon waarop de aankoopdatum en het eenheidmodel staan aangegeven.

### 12.2 Afwikkeling van garantieclaims

Een defecte eenheid moet worden geretourneerd aan het onderhoudscentrum van Topcom samen met de aankoopbon.

Als de eenheid defect raakt tijdens de garantieperiode, zal Topcom of een van haar bevoegde onderhoudscentra de defecten kosteloos repareren die zijn veroorzaakt door fouten in materiaal of vakmanschap.

Topcom zal naar eigen inzicht voldoen aan haar garantieverplichtingen door de defecte eenheden of onderdelen van de defecte eenheden te repareren of te vervangen. In het geval van vervanging kunnen de kleur en het model verschillend zijn van het oorspronkelijk gekochte toestel.

De oorspronkelijke aankoopdatum is bepalend voor het begin van de garantieperiode. De garantieperiode wordt niet verlengd als de eenheid is vervangen of gerepareerd door Topcom of een van haar bevoegde onderhoudscentra.



### 12.3 Garantiebeperkingen

Schade of defecten als gevolg van een onjuiste behandeling of onjuist gebruik en schade als gevolg van het gebruik van niet-originele onderdelen of accessoires die niet worden aanbevolen door Topcom vallen buiten de garantie.

De draadloze telefoons van Topcom zijn alleen geschikt voor gebruik met oplaadbare batterijen. De schade door het gebruik van normale, niet-oplaadbare batterijen valt buiten de garantie.

De garantie dekt geen schade te wijten aan externe factoren, zoals bliksem, water en brand, noch enige transportschade.

Er kan geen aanspraak worden gemaakt op garantie als het serienummer op de eenheden is veranderd, verwijderd of onleesbaar gemaakt.

Alle garantieclaims zullen ongeldig worden wanneer de eenheid is gerepareerd, veranderd of aangepast door de koper of onbevoegde, niet officieel door Topcom toegewezen onderhoudscentra.

## 13 Afvoeren van het toestel (milieu)



Op het einde van de levenscyclus van het product mag u dit product niet met het normale huishoudelijke afval weggooien, maar moet u het naar een inzamelpunt brengen voor de recyclage van elektrische en elektronische apparatuur. Dit wordt aangeduid door het symbool op het product, in de handleiding en/of op de verpakking.

Sommige materialen van het product kunnen worden hergebruikt als u ze naar een inzamelpunt brengt. Door onderdelen of grondstoffen van gebruikte producten te hergebruiken, levert u een belangrijke bijdrage aan de bescherming van het milieu.

Wend u tot uw plaatselijke overheid voor meer informatie over de inzamelpunten in uw buurt.

## 14 Reinigen

Reinig de telefoon met een vochtige doek of met een antistatische doek. Gebruik nooit reinigingsmiddelen of schuurmiddelen.

## 15 ECO-modus (lage straling)

- Deze draadloze telefoon (voldoet aan de DECT-norm) vergemakkelijkt de lage-stralingswerking.
- De stralingsintensiteit van het radiosignaal tussen het basisstation en de handset wordt verminderd tot een minimum wanneer de handset op het basisstation staat.
- De intensiteit van het radiosignaal wordt alleen naar de normale sterkte verhoogd wanneer de handset van het basisstation wordt gepakt of als er een oproep wordt ontvangen.
- Dit betekent niet dat de normale DECT-straling schadelijk is voor de gezondheid.
- De lage-stralingsmodus voorkomt een onnodige DECT stralingsbelasting wanneer er geen communicatie is vereist tussen het basisstation en de handset.
- Om technische redenen kunnen er geen extra handsets in de lage-stralingsmodus worden gebruikt (een extra handset die niet in de directe omgeving van het basisstation staat, zal altijd "zoeken naar het basisstation" als gevolg van het zwakke radiosignaal).
- De lage-stralingsmodus is actief in de fabrieksinstellingen.
- De lage-stralingsmodus wordt automatisch uitgeschakeld als u een extra handset aanmeldt.
- De lage-stralingsmodus wordt automatisch weer ingeschakeld als u alle extra handsets afmeldt (er mag slechts één handset zijn aangemeld op het basisstation).
- De procedure voor het aan- en afmelden van handsets wordt uitgelegd in de gebruikshandleiding.

## Français

### 1 Instructions de sécurité

- Utilisez uniquement la fiche du chargeur fournie. N'utilisez pas d'autres chargeurs, au risque d'abîmer les éléments de batterie.
- Insérez uniquement des batteries rechargeables du même type. N'utilisez jamais de batteries ordinaires non-rechargeables. Insérez des batteries rechargeables en respectant la polarité (indiquée dans le compartiment à batteries du combiné).
- Ne touchez pas les contacts du chargeur et de la fiche avec des objets pointus ou métalliques.
- Le fonctionnement de certains appareils médicaux pourrait être altéré.
- Le combiné peut provoquer un bourdonnement désagréable dans les prothèses auditives.
- N'installez pas la base dans une pièce humide ou à moins d'1,5 m d'une source d'eau. Veillez à ce que le combiné reste sec.
- N'utilisez pas le téléphone dans un environnement qui présente un risque d'explosion.
- Jetez les batteries et entretenez le téléphone dans le strict respect de l'environnement.
- Comme ce téléphone est indisponible en cas de coupure de courant, vous devez utiliser un téléphone autonome -pour les appels urgents, un téléphone mobile par exemple.

### 2 Pour commencer

#### 2.1 Comment utiliser ce mode d'emploi ?

Ce mode d'emploi adopte les règles suivantes pour clarifier les instructions :

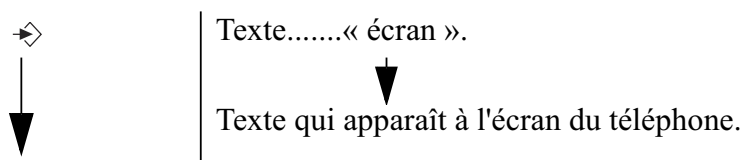

Touche à enfoncer. Cette touche peut être une touche contextuelle (Voir « 2.4 Touches/LED »). Lorsque la touche contextuelle est un symbole, elle est représentée dans la colonne de gauche. Quand la touche contextuelle correspond à un texte, la touche contextuelle gauche ou droite est représentée dans la colonne de gauche et le texte est représenté entre guillemets dans la colonne de droite.

#### 2.2 Installation de la base

Pour installer la base, procédez comme suit :

- 1** Branchez une extrémité de l'adaptateur dans la prise de courant et l'autre extrémité dans la prise d'adaptateur à l'arrière de la base.
- 2** Branchez une extrémité du câble téléphonique dans la prise téléphonique murale et l'autre extrémité en dessous de la base.
- 3** Placez le câble téléphonique et le câble d'alimentation dans les guides de la base comme indiqué sur la figure 2A.

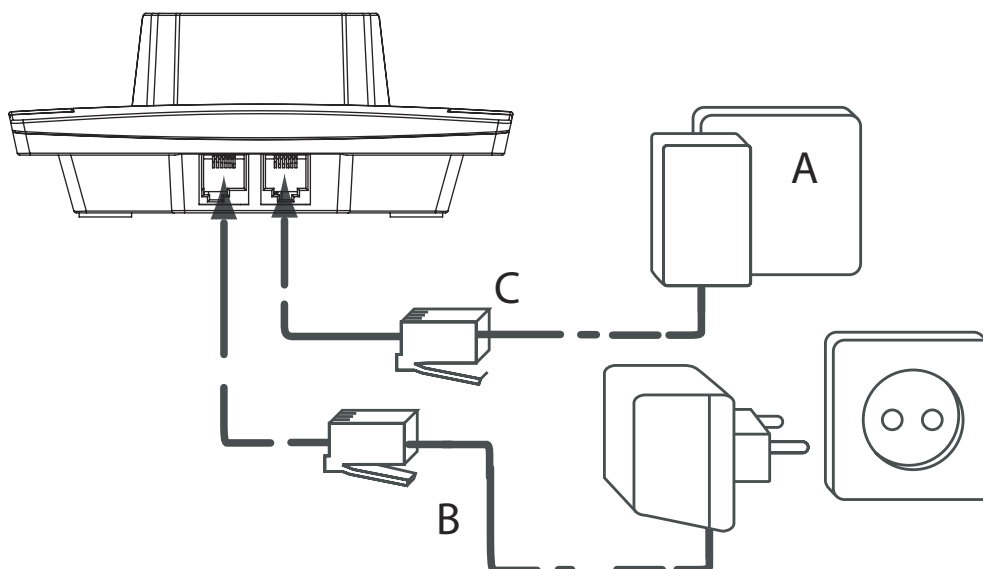

- 2A Vue arrière de la base -

A. Prise murale du téléphone

B. Câble d'alimentation

C. Câble téléphonique

### 2.3 Installation du combiné

- 1 Ouvrez le compartiment à batteries comme illustré sur la figure 2B.
- 2 Insérez les batteries en respectant les polarités (+ et -).
- 3 Fermez le compartiment à batteries.
- 4 Laissez le combiné sur la base pendant 20 heures. L'indicateur Ligne/Charge  sur la base s'allume.

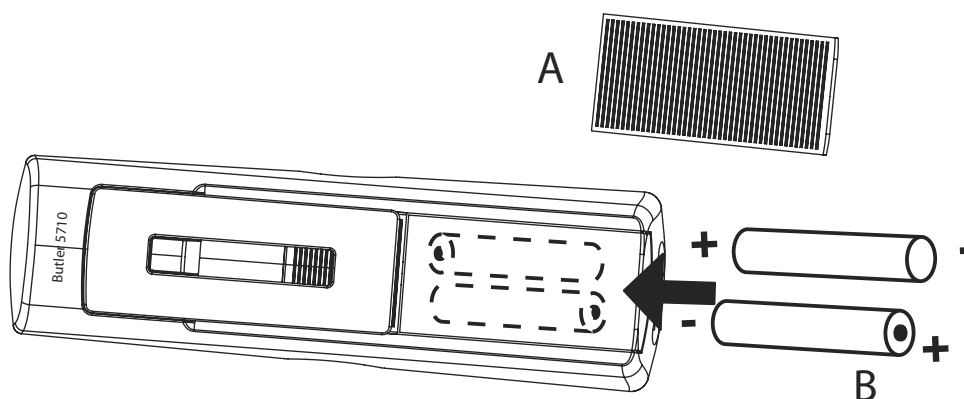

- 2B Vue arrière du combiné -

A. Couvercle

B. Batteries rechargeables



Avant la première utilisation du téléphone, assurez-vous au préalable que les batteries ont pu se charger pendant 20 heures. À défaut, le téléphone ne fonctionnera pas de manière optimale.

## 2.4 Touches/LED

### Combiné

1. Écran
2. Touche haut/recomposition
3. Touche de menu contextuel droite
4. Touche droite/flash
5. Touche fin d'appel/arrêt
6. Touches alphanumériques
7. Verrouillage du clavier
8. Touche désactivation sonnerie
9. Touche bas/journal des appels
10. Touche prise d'appel/mains-libres/marche
11. Touche gauche/INT
12. Touche OK
13. Touche de menu contextuel gauche

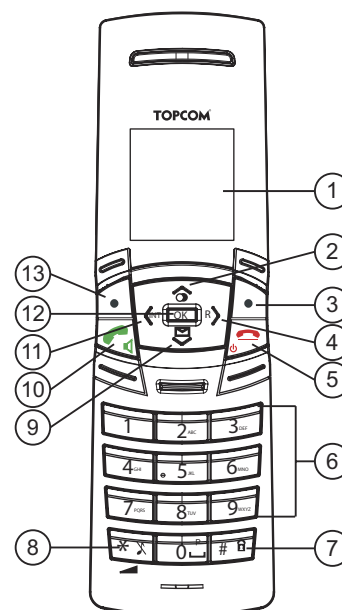

- 2C Combiné -

### Base

14. LED en service/sous tension/combiné sur la base
15. Touche paging

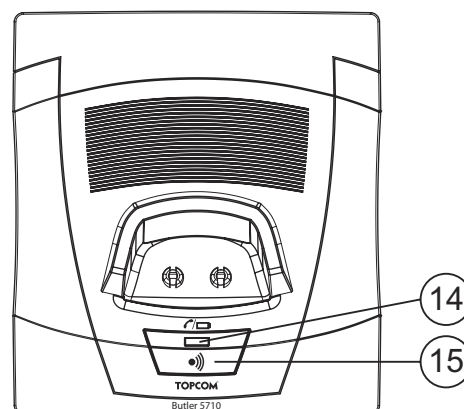

- 2D Base -

## 2.5 Symboles

	Prise d'appel		Verrouillage du clavier
	Fin d'appel		Réglage d'alarme
	Appels manqués dans la liste d'appels*		Combiné non associé à la base ou hors de portée
	Volume de la sonnerie du combiné éteint		Batterie vide
	Combiné à portée de la base		Batterie faible
	Appel interne		Batterie à moitié chargée
	Mains-libres		Batterie pleine
	Nouveau message vocal		

\* Si le service d'identification de l'appelant est activé sur votre ligne téléphonique.

## 2.6 Touches d'écran

Les touches d'écran (touches contextuelles) sont situées juste en dessous de l'écran. Le rôle de ces 2 touches varie suivant le mode de fonctionnement. La fonction en cours est affichée sous forme d'icône ou de texte juste au-dessus de chacune des 2 touches d'écran.

	Répertoire		Mute
	OK/valider		Retour
	Menu		Pas de touche
	Effacer		





## 2.7 LED de la base

La LED (14) indique l'état dans lequel se trouve la base :

- Éteint : la base n'est pas reliée à une prise de courant ou le combiné n'est pas sur la base pour être rechargé.
- Allumé : le combiné est en cours de chargement.
- Clignotement lent : prise d'appel ou sonnerie.
- Clignotement rapide : enregistrement en cours.

## 2.8 Navigation dans les menus

Le Butler 5710 intègre un système de menus très convivial. Chaque menu aboutit à une série d'options. L'arborescence des menus est illustrée au paragraphe suivant.

- |   |  |
|---|--|
|  | <b>1</b> Le combiné étant allumé et en mode de veille, appuyez sur la touche de menu contextuel gauche  pour accéder au menu principal. |
|  | <b>2</b> Faites défiler l'écran jusqu'à l'option de menu souhaitée.  |
|  | <b>3</b> Appuyez sur la touche contextuelle pour afficher d'autres options ou pour valider le réglage affiché.   |

### Pour quitter ou remonter d'un niveau dans le menu



Pour revenir au niveau précédent du menu, appuyez sur la touche contextuelle. Vous pouvez, à tout instant, annuler une action et revenir au mode veille en appuyant sur la touche fin d'appel.

## 2.9 Organisation des menus

Menu	Sous-menus
Combiné	Sonnerie
	Vol. Sonnerie
	Nom Combiné
	Bip Touche
	Contraste
	Autotalk
	Prefix
	Choix Base
	Langue
	Enregistrer
Réglage Base	Sonnerie
	Vol. Sonnerie
	Mode Compos.
	Rappel PIN Système
Alarme/Horl.	Régler Alarme
	Jour & Heure
	Format Temps
Outils	Rendez-Vous
	Chronomètre
Déclencher	

## 3 Utilisation du téléphone

### 3.1 Mise en/hors service du combiné



- 1 Appuyez sur la touche arrêt et maintenez-la enfoncée pour éteindre le combiné.
- 2 Appuyez sur la touche Prise d'appel ou placez le combiné sur la base pour le rallumer.

### 3.2 Modification de la langue des menus

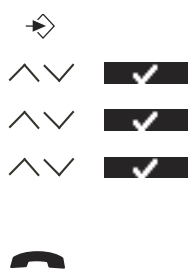

- 1 Accédez au menu.
- 2 Sélectionnez « Combiné » et validez.
- 3 Sélectionnez « Langue » et validez.
- 4 Sélectionnez la langue de votre choix et validez.  
L'écran affiche « Mémorisé ».
- 5 Appuyez sur la touche fin d'appel pour revenir au mode veille.



Les flèches  indiquent que d'autres options sont disponibles dans ce menu.

### 3.3 Passer un appel ordinaire

#### Composition directe



- 1** Appuyez sur la touche Prise d'appel pour lancer l'appel.
- 2** Composez le numéro de téléphone.
- 3** Appuyez sur la touche Fin d'appel pour raccrocher ou replacez le combiné sur sa base.

#### Précomposition

La fonction de précomposition vous permet de saisir et modifier un numéro avant de passer l'appel.



- 1** Composez un numéro de 24 chiffres maximum.  
Appuyez sur la touche 0 et maintenez-la enfoncée pour insérer une pause. L'écran affiche un P.
- 2** Appuyez sur la touche contextuelle pour corriger.
- 3** Appuyez sur la touche Prise d'appel pour lancer l'appel.
- 4** Appuyez sur la touche Fin d'appel pour raccrocher ou replacez le combiné sur sa base.

#### Recomposition d'un numéro de la liste

Vous pouvez recomposer un numéro quelconque parmi les 10 derniers numéros appelés. Si vous avez mémorisé un nom dans le répertoire pour l'associer au numéro, c'est le nom qui sera affiché à la place.

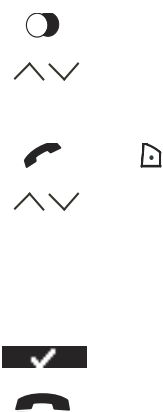

- 1** Appuyez sur la touche Recomposition.
- 2** Sélectionnez un numéro. Si le numéro est dans le répertoire, le nom associé s'affichera.
- 3** Appuyez sur la touche Prise d'appel pour lancer l'appel ou sélectionnez « Option ».
- 4** Si vous avez sélectionné « Option », faites défiler l'écran et sélectionnez :  
« Efface Appel » : pour supprimer le numéro de la liste d'appels ;  
« Mémo. Numéro » : pour mémoriser le numéro dans le répertoire ;  
« Efface Tout » : pour effacer la liste d'appels.
- 5** Confirmez la sélection.
- 6** Appuyez sur la touche fin d'appel pour revenir au mode veille.

### 3.4 Recevoir un appel

Lorsque vous recevez un appel externe, l'écran affiche « Appel externe ».

Pour prendre l'appel :



- 1** Appuyez sur la touche Prise d'appel.  
OU  
Retirez le combiné de sa base si vous avez activé la fonction « Autotalk »  
(Voir « 6.5 Autotalk »)  
L'icône appel en cours  apparaît sur l'écran. La durée de l'appel est affichée après 15 secondes.
- 2** Appuyez sur la touche Fin d'appel pour raccrocher ou replacez le combiné sur sa base.



*Vous pouvez désactiver le volume de la sonnerie lors d'un appel entrant en sélectionnant « Silence ».*

### 3.5 Mode mains-libres

Le mode mains-libres vous permet de parler à votre interlocuteur sans tenir le combiné. Il permet aussi à d'autres personnes dans la pièce d'écouter la conversation.



- 1 Pour basculer en mode mains-libres, appuyez sur la touche Mains-libres pendant l'appel.

### 3.6 Réglage du volume de l'écouteur/haut-parleur mains-libres



- 1 Appuyez sur les touches haut ou bas pour régler le volume de 1 à 5 pendant une conversation normale ou en mode mains-libres.

### 3.7 Fonction silence (Mute)

Cette fonction désactive le microphone de telle façon que la personne à l'autre bout de la ligne ne vous entende pas.



- 1 Au cours d'une conversation, appuyez sur la touche contextuelle pour désactiver le microphone.

« Muet Encl. » s'affiche à l'écran.



- 2 Sélectionnez « Arrêt » pour réactiver le microphone.

### 3.8 Localisation d'un combiné (fonction paging)



- 1 Appuyez sur la touche Paging de la base.

Tous les combinés enregistrés avec la base se mettent à sonner pendant 30 secondes.



- 2 Appuyez sur une touche quelconque du combiné pour interrompre la fonction paging.

### 3.9 Verrouillage du clavier

Cette fonction permet de verrouiller le clavier afin d'éviter de composer un numéro par inadvertance lorsque vous vous déplacez avec le combiné dans la main.

En mode veille :



- 1 Appuyez sur la touche verrouillage du clavier (touche 7 sur la figure 2C) et maintenez-la enfoncée jusqu'à ce que le message « verrouillé » et l'icône verrouillage du clavier  apparaissent sur l'écran.



- 2 Pour déverrouiller le clavier, sélectionnez « Déver. », puis appuyez sur la touche Verrouillage du clavier.

### 3.10 Utilisation du clavier alphanumérique





Avec votre téléphone, vous pouvez également saisir des caractères alphanumériques. Cette fonction peut vous servir pour saisir un nom dans le répertoire, attribuer un nom au combiné, etc. Pour sélectionner une lettre, appuyez sur la touche correspondante autant de fois que nécessaire. Par exemple, pour sélectionner « A », appuyez sur « 2 » une seule fois. Pour écrire un « B », appuyez sur « 2 » deux fois de suite, etc.

Pour écrire « A » puis « B » consécutivement, appuyez sur « 2 » une seule fois, attendez que le curseur avance d'une position, puis appuyez sur « 2 » deux fois.

Au cours de la saisie de texte, le caractère disponible sous chaque touche apparaît au bas de l'écran.









Vous pouvez modifier les caractères de saisie de l'anglais (abc) vers le latin (aàá), le grec (ABΓ) ou le russe (ABB) en maintenant la touche # enfoncée pendant 2 secondes.

	Appuyez sur « 0 » pour insérer un espace.
	Appuyez sur la touche * pour basculer entre les minuscules et les majuscules.
	Appuyez sur la touche # et maintenez-la enfoncée pendant 2 secondes pour changer le jeu de caractères de saisie.
	Appuyez sur la touche contextuelle pour corriger.





## 4 Répertoire

Chaque combiné peut mémoriser jusqu'à 200 noms et numéros. Les noms peuvent comprendre jusqu'à 16 caractères et les numéros peuvent compter jusqu'à 24 chiffres.





### 4.1 Pour ajouter une entrée

	<b>1</b> Appuyez sur la touche contextuelle.
	Si le répertoire est vide, le message « Annuaire vide » apparaît sur l'écran. Si des noms ont déjà été mémorisés, ceux-ci sont affichés.
	<b>2</b> Sélectionnez « Option ».
	<b>3</b> Sélectionnez « Ajoute entrée » et validez.
	<b>4</b> Utilisez le clavier pour saisir le nom, puis sélectionnez « Mémor. ».
	<b>5</b> Utilisez le clavier pour saisir le numéro, puis sélectionnez « Mémor. ».
	<b>6</b> Sélectionnez la mélodie de sonnerie souhaitée et sélectionnez « Mémor. ».
	<b>7</b> Revenez au mode veille.











### 4.2 Pour composer un numéro

	<b>1</b> Appuyez sur la touche contextuelle.
	<b>2</b> Sélectionnez le nom souhaité ou utilisez le clavier pour saisir la première lettre du nom.
	<b>3</b> Appuyez sur la touche Prise d'appel pour lancer l'appel.
	<b>4</b> Revenez au mode veille.











### 4.3 Montre Détail

	<b>1</b> Appuyez sur la touche contextuelle.
	<b>2</b> Sélectionnez le nom souhaité ou utilisez le clavier pour saisir la première lettre du nom.
	<b>3</b> Sélectionnez « Option ».
	<b>4</b> Sélectionnez « Montre Détail » et validez.
	Le nom, le numéro et la mélodie de sonnerie associée à l'entrée s'affichent sur l'écran.
	<b>5</b> Revenez au mode veille.











#### 4.4 Suppression d'une entrée ou de toutes les entrées

- |   |  |
|---|--|
|    | <b>1</b> Appuyez sur la touche contextuelle.   |
|    | <b>2</b> Sélectionnez le nom souhaité ou utilisez le clavier pour saisir la première lettre du nom.                |
|    | <b>3</b> Sélectionnez « Option ».  |
|   | Pour supprimer une seule entrée :  |
|   | <b>4</b> Sélectionnez « Efface Entrée » et validez.  |
|   | Pour supprimer toutes les entrées :  |
|   | <b>4</b> Sélectionnez « Efface Tout » et validez.  |
|   | <b>5</b> Appuyez sur la touche contextuelle gauche pour annuler ou sur la touche contextuelle droite pour valider. |
|    | <b>6</b> Revenez au mode veille.   |

#### 4.5 Modification d'un nom ou d'un numéro

- |   |  |
|---|--|
|    | <b>1</b> Appuyez sur la touche contextuelle.   |
|    | <b>2</b> Sélectionnez le nom souhaité ou utilisez le clavier pour saisir la première lettre du nom.        |
|    | <b>3</b> Sélectionnez « Option ».  |
|       | <b>4</b> Sélectionnez « Modif. Entr. » et validez.   |
|   | <b>5</b> Appuyez sur la touche contextuelle pour supprimer le nom ou utilisez le clavier pour le modifier. |
|    | <b>6</b> Sélectionnez « Mémor. ».  |
|    | <b>7</b> Modifiez le numéro et sélectionnez « Mémor. ».  |
|   | <b>8</b> Sélectionnez la mélodie de sonnerie souhaitée et sélectionnez « Mémor. ».                         |
|    | <b>9</b> Revenez au mode veille.   |

#### 4.6 Copie d'une entrée du répertoire vers un autre combiné

- |   |  |
|---|--|
|    | <b>1</b> Appuyez sur la touche contextuelle.   |
|    | <b>2</b> Sélectionnez le nom souhaité ou utilisez le clavier pour saisir la première lettre du nom.  |
|    | <b>3</b> Sélectionnez « Option ».  |
|   | <b>4</b> Sélectionnez « Copie Entrée » et validez.   |
|   | Les combinés disponibles (tous les combinés qui sont enregistrés sur la base) sont mentionnés.   |
|   | <b>5</b> Sélectionnez le combiné souhaité et validez.  |
|   | « Copie vers Combiné x » s'affiche à l'écran.  |
|   | « Recevoir Entrée Répertoire ? » apparaît sur l'écran du combiné de destination.   |
|   | <b>6</b> Sur le combiné de destination, appuyez sur la touche contextuelle droite pour confirmer ou sur la touche contextuelle gauche pour annuler le transfert. |
|    | <b>7</b> Revenez au mode veille.   |

## 4.7 Copie de toutes les entrées du répertoire vers un autre combiné



*En recopiant toutes les entrées d'un combiné vers un autre, vous effacez toutes les entrées existantes du combiné de destination.*



**1** Appuyez sur la touche contextuelle.



**2** Sélectionnez le nom souhaité ou utilisez le clavier pour saisir la première lettre du nom.



**3** Sélectionnez « Option ».



**4** Sélectionnez « Copie Tout » et validez.

Les combinés disponibles (tous les combinés qui sont enregistrés sur la base) sont mentionnés.



**5** Sélectionnez le combiné souhaité et validez.

« Copie vers Combiné x » s'affiche à l'écran.

« Remplacer Tous Entrées? » apparaît sur l'écran du combiné de destination.



**6** Sur le combiné de destination, appuyez sur la touche contextuelle droite pour confirmer ou sur la touche contextuelle gauche pour annuler le transfert.



**7** Revenez au mode veille.

## 5 Identification de l'appelant

### 5.1 Appels entrants RTC ordinaires



*Cette fonction n'est disponible que si vous avez souscrit au service de présentation du numéro. Au besoin, veuillez prendre contact avec votre compagnie de téléphone.*

Lorsque vous recevez un appel sur votre ligne téléphonique fixe, le numéro de téléphone de l'appelant s'affiche sur l'écran du combiné. Le téléphone peut recevoir des appels de type FSK et DTMF. Vous pouvez aussi voir le nom de l'appelant s'il est transmis par le réseau. Si le nom est programmé dans le répertoire, c'est le nom du répertoire qui est affiché.

Le téléphone peut mémoriser 30 appels dans la liste d'appels (reçus et manqués) que vous pouvez consulter ultérieurement. Quand la mémoire est pleine, les nouveaux appels remplacent automatiquement les plus anciens appels conservés en mémoire.



Les appels manqués sont signalés par une icône clignotante sur l'écran. Le nom du combiné est remplacé par cette icône et le nombre d'appels manqués.

#### Pour consulter les appels reçus



**1** Appuyez sur la touche bas.

La liste Appels reçus apparaît à l'écran. Elle regroupe les appels reçus et les appels manqués.



**2** Sélectionnez le nom ou le numéro souhaité.



**3** Appuyez sur la touche Prise d'appel pour lancer l'appel.



OU

Sélectionnez « Option ».













Pour supprimer une seule entrée :



**4** Sélectionnez « Efface Appel » et validez.



**5** Revenez au mode veille.















- |   |   |
|---|---|
|    | <p>Pour supprimer toutes les entrées :</p> <p><b>5</b> Sélectionnez « Efface Tout » et validez.</p> <p><b>6</b> Revenez au mode veille.</p> |
|    | <p>Pour ajouter le numéro au répertoire :</p> <p><b>5</b> Sélectionnez « Mémo. Numéro » et validez.</p>                                     |
|    | <p><b>6</b> Utilisez le clavier pour saisir le nom, puis sélectionnez « Mémor. ».</p>   |
|    | <p><b>7</b> Utilisez le clavier pour modifier le numéro, puis sélectionnez « Mémor. ».</p>  |
|    | <p><b>8</b> Sélectionnez la mélodie de sonnerie souhaitée et sélectionnez « Mémor. ».</p>   |
|    | <p><b>9</b> Revenez au mode veille.</p>   |

## 6 Personnalisation du combiné

### 6.1 Sonnerie et volume











#### Sonnerie

Vous pouvez choisir parmi 18 mélodies de sonnerie différentes pour différencier les appels internes et externes.

- |   |  |
|---|--|
|    | <p><b>1</b> Accédez au menu.</p>   |
|         | <p><b>2</b> Sélectionnez « Combiné » et validez.</p>   |
|      | <p><b>3</b> Sélectionnez « Sonnerie » et validez.</p>  |
|    | <p><b>4</b> Sélectionnez « Externe » pour des appels externes ou « Interne » pour des appels internes, puis validez.</p> |
|    | <p><b>5</b> Sélectionnez la mélodie souhaitée et validez.</p>  |
|    | <p>La mélodie est diffusée pendant le défilement.</p> <p><b>6</b> Revenez au mode veille.</p>                            |









#### Vol. Sonnerie

Vous pouvez choisir parmi 5 niveaux de volume de sonnerie du combiné, voire même couper totalement le volume.









- |   |  |
|---|--|
|    | <p><b>1</b> Accédez au menu.</p>   |
|    | <p><b>2</b> Sélectionnez « Combiné » et validez.</p>   |
|    | <p><b>3</b> Sélectionnez « Vol. Sonnerie » et validez.</p>   |
|    | <p>La valeur en cours est affichée.</p> <p><b>4</b> Appuyez sur la touche haut pour augmenter le volume.</p> |
|    | <p><b>5</b> Appuyez sur la touche bas pour diminuer le volume.</p>   |
|    | <p><b>6</b> Sélectionnez « Mémor. » pour valider.</p>  |
|    | <p><b>7</b> Revenez au mode veille.</p>  |

## 6.2 Nom du combiné









Vous pouvez modifier le nom affiché sur le combiné pendant le mode veille (max. 9 caractères).

- |   |  |
|---|--|
|    | <b>1</b> Accédez au menu.                                  |
|   | <b>2</b> Sélectionnez « Combiné » et validez.              |
|   | <b>3</b> Sélectionnez « Nom Combiné » et validez.          |
|    | <b>4</b> Saisissez un nom à votre convenance.              |
|    | <b>5</b> Appuyez sur la touche contextuelle pour corriger. |
|    | <b>6</b> Sélectionnez « Mémor. » pour valider.             |
|    | <b>7</b> Revenez au mode veille.                           |

## 6.3 Bip Touche









- |   |   |
|---|---|
|    | <b>1</b> Accédez au menu.                                 |
|   | <b>2</b> Sélectionnez « Combiné » et validez.             |
|   | <b>3</b> Sélectionnez « Bip Touche » et validez.          |
|   | <b>4</b> Sélectionnez « Marche » ou « Arrêt » et validez. |
|    | <b>5</b> Revenez au mode veille.                          |

## 6.4 Réglage du contraste

- |   |   |
|---|---|
|   | <b>1</b> Accédez au menu.   |
|   | <b>2</b> Sélectionnez « Combiné » et validez.                                       |
|   | <b>3</b> Sélectionnez « Contraste » et validez.                                     |
|   | <b>4</b> Sélectionnez un niveau de contraste à votre convenance (1 à 8) et validez. |
|    | <b>5</b> Revenez au mode veille.  |







## 6.5 Autotalk





Lorsque vous recevez un appel entrant et que le combiné est sur la base, le téléphone prend automatiquement la ligne dès qu'il est retiré de la base. Cette fonction peut être activée ou désactivée.

- |   |   |
|---|---|
|    | <b>1</b> Accédez au menu.                                 |
|   | <b>2</b> Sélectionnez « Combiné » et validez.             |
|   | <b>3</b> Sélectionnez « Autotalk » et validez.            |
|   | <b>4</b> Sélectionnez « Marche » ou « Arrêt » et validez. |
|    | <b>5</b> Revenez au mode veille.                          |

## 6.6 Code de préfixe

Il vous est possible d'utiliser votre téléphone avec un code de préfixe. Lorsque vous composez des numéros, vous pouvez faire ajouter automatiquement le code de préfixe avant le numéro.









- |   |   |
|---|---|
|    | <b>1</b> Accédez au menu.                     |
|   | <b>2</b> Sélectionnez « Combiné » et validez. |
|   | <b>3</b> Sélectionnez « Prefix » et validez.  |
|   | <b>4</b> Sélectionnez « Modifie » et validez. |

- |   |  |
|---|--|
|  | <p><b>5</b> Saisissez le code de préfixe (par exemple « 0 ») et sélectionnez « Mémor. ».</p> <p>OU</p> |
|  | <p><b>4</b> Sélectionnez « Marche/Arrêt » et validez.</p>  |
|  | <p><b>5</b> Sélectionnez « Marche » ou « Arrêt » et validez.</p>                                       |
|  | <p><b>6</b> Revenez au mode veille.</p>  |



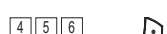

## 6.7 Fonction d'alarme

Vous pouvez définir une alarme différente sur chaque combiné enregistré sur votre base. L'alarme ne sonne que sur le combiné concerné, pas sur la base ni sur un autre combiné.





### Réglage de l'alarme

- |   |   |
|---|---|
|    | <p><b>1</b> Accédez au menu.</p>  |
|    | <p><b>2</b> Sélectionnez « Alarme/Horl. » et validez.</p>   |
|    | <p><b>3</b> Sélectionnez « Régler Alarme » et validez.</p>  |
|    | <p><b>4</b> Sélectionnez « Une fois », « Quotidienne », « Lun à Ven » ou « Arrêt » et validez.<br/>Si vous avez sélectionné « Une fois », « Quotidienne » ou « Lun à Ven », l'écran affiche ensuite :<br/>Temps (24h) :<br/>00:00</p> |
|    | <p><b>5</b> Spécifiez l'heure à laquelle vous voulez que le téléphone sonne et validez avec « Mémor. »</p>  |
|  | <p><b>6</b> Sélectionnez la sonnerie souhaitée et validez avec « Mémor. »</p>   |
|  | <p><b>7</b> Pour désactiver l'alarme, sélectionnez « Arrêt » et validez.</p>  |
|  | <p><b>8</b> Retournez au menu précédent.</p>  |

## 6.8 Réglage de la date et de l'heure

- |   |   |
|---|---|
|  | <p><b>1</b> Accédez au menu.</p>  |
|  | <p><b>2</b> Sélectionnez « Alarme/Horl. » et validez.</p>   |
|  | <p><b>3</b> Sélectionnez « Jour &amp; Heure » et validez.</p>   |
|  | <p><b>4</b> Saisissez l'année, le mois, le jour, l'heure et les minutes, puis sélectionnez « Mémor. » pour valider.</p> |
|  | <p><b>5</b> Retournez au menu précédent.</p>  |









## 6.9 Réglage du format horaire

- |   |   |
|---|---|
|  | <p><b>1</b> Accédez au menu.</p>                              |
|  | <p><b>2</b> Sélectionnez « Alarme/Horl. » et validez.</p>     |
|  | <p><b>3</b> Sélectionnez « Format Temps » et validez.</p>     |
|  | <p><b>4</b> Sélectionnez « 12 h » ou « 24 h » et validez.</p> |
|  | <p><b>5</b> Retournez au menu précédent.</p>                  |

## 7 Réglage Base









### 7.1 Sonnerie

Vous pouvez choisir parmi 9 mélodies de sonnerie différentes.

- |   |  |
|---|--|
|    | <b>1</b> Accédez au menu.                              |
|   | <b>2</b> Sélectionnez « Réglage Base » et validez.     |
|   | <b>3</b> Sélectionnez « Sonnerie » et validez.         |
|   | <b>4</b> Sélectionnez la mélodie souhaitée et validez. |
|   | Un extrait est diffusé pendant le défilement.          |
|    | <b>5</b> Revenez au mode veille.                       |

### 7.2 Vol. Sonnerie

Vous pouvez choisir parmi 5 niveaux de volume de sonnerie de la base.









- |   |   |
|---|---|
|    | <b>1</b> Accédez au menu.                                     |
|   | <b>2</b> Sélectionnez « Réglage Base » et validez.            |
|   | <b>3</b> Sélectionnez « Vol. Sonnerie » et validez.           |
|   | La valeur en cours est affichée.                              |
|    | <b>4</b> Appuyez sur la touche haut pour augmenter le volume. |
|   | <b>5</b> Appuyez sur la touche bas pour diminuer le volume.   |
|    | <b>6</b> Sélectionnez « Mémor. » pour valider.                |
|    | <b>7</b> Revenez au mode veille.                              |

### 7.3 Mode de numérotation

Il existe 2 modes de numérotation :





- Numérotation à tonalités DTMF (la plus courante)
- Numérotation à impulsions (sur les installations plus anciennes)

Pour changer le mode de numérotation :

- |   |   |
|---|---|
|    | <b>1</b> Accédez au menu.   |
|   | <b>2</b> Sélectionnez « Réglage Base » et validez.                                |
|   | <b>3</b> Sélectionnez « Mode Compos. » et validez.                                |
|   | <b>4</b> Sélectionnez « Tonalités » ou « Impulsions » et sélectionnez « Mémor. ». |
|    | <b>5</b> Revenez au mode veille.  |

### 7.4 Rappel (Flash)

Appuyez sur la touche Flash R (touche 4 - Figure 2C) pour utiliser certains services sur votre ligne extérieure, tels que « appel en attente » (si ce service est proposé par votre compagnie de téléphone), ou pour transférer les appels téléphoniques lorsque vous utilisez un autocommutateur privé (PABX). La touche Flash R produit une brève interruption de la ligne. Vous pouvez régler le flash à 100 ms ou 250 ms.

- |   |  |
|---|--|
|    | <b>1</b> Accédez au menu.                          |
|   | <b>2</b> Sélectionnez « Réglage Base » et validez. |
|   | <b>3</b> Sélectionnez « Rappel » et validez.       |



**4** Sélectionnez un flash court (100 ms) ou un flash long (250 ms) et sélectionnez « Mémor. ».



**5** Revenez au mode veille.

## 7.5 PIN Système

La fonction PIN Système permet d'activer ou supprimer l'enregistrement des combinés et de définir quelques paramètres supplémentaires. Le code PIN Système par défaut est 0000.



**1** Accédez au menu.



**2** Sélectionnez « Réglage Base » et validez.



**3** Sélectionnez « PIN Système » et validez.



**4** Saisissez l'ancien code PIN (0000 par défaut) et sélectionnez « Mémor. ».



**5** Saisissez le nouveau code PIN, sélectionnez « Mémor. » et répétez l'opération.



**6** Revenez au mode veille.

## 8 Outils

### 8.1 Rendez-Vous

Vous pouvez définir 5 rappels ou rendez-vous auxquels vous pouvez associer un nom et une alarme à déclencher à une date et une heure données.



**1** Accédez au menu.



**2** Sélectionnez « Outils » et validez.



**3** Sélectionnez « Rendez-Vous » et validez.



**4** Sélectionnez l'un des 5 rendez-vous et sélectionnez « Option ».

Pour modifier le rendez-vous :



**5** Sélectionnez « Modifie » et validez.



**6** Modifiez l'intitulé du rendez-vous et sélectionnez « Mémor. ».



**7** Saisissez la date du rendez-vous et sélectionnez « Mémor. ».



**8** Saisissez l'heure et sélectionnez « Mémor. ».



**9** Sélectionnez la mélodie d'alarme souhaitée et sélectionnez « Mémor. ».



**10** Revenez au mode veille.

Pour supprimer le rendez-vous :



**5** Sélectionnez « Efface » et validez.



**6** Appuyez sur la touche contextuelle droite pour valider.



**7** Appuyez sur la touche contextuelle gauche pour revenir en arrière.



**8** Revenez au mode veille.

### 8.2 Chronomètre



**1** Accédez au menu.



**2** Sélectionnez « Outils » et validez.



**3** Sélectionnez « Chronomètre » et validez.



**4** Sélectionnez « Démar. » pour démarrer le chronomètre.



**5** Sélectionnez « Arrêt » pour arrêter le chronomètre.





- Sélectionnez à nouveau « Démar. » pour redémarrer.
- Sélectionnez « RAZ » pour remettre à zéro le compteur.
- 6** Revenez au mode veille.

## 9 Combinés et stations de base supplémentaires

Vous pouvez enregistrer jusqu'à 4 combinés sur une seule base. Chaque combiné peut enregistrer jusqu'à 4 stations de base et l'utilisateur peut sélectionner la base qu'il souhaite utiliser.

### 9.1 Ajout d'un nouveau combiné



*Cette opération n'est nécessaire que si vous avez supprimé l'enregistrement d'un combiné ou si vous en avez acheté un nouveau.*

Pour placer la base en mode d'enregistrement :



- 1** Maintenez enfoncée la touche Paging de la base.
- La LED sur la base se met à clignoter pendant 90 secondes. Pendant cette période, la base est prête à enregistrer un combiné.

Sur le combiné :



- 1** Accédez au menu.
- 2** Sélectionnez « Combiné » et validez.
- 3** Sélectionnez « Enregistrer » et validez.
- 4** Sélectionnez « Enreg. Comb. » et validez.
- 5** Sélectionnez le numéro de la base à associer au combiné (1-4) et validez.
- 6** Saisissez le code PIN système (0000 par défaut) et validez.
- 7** Revenez au mode veille.

### 9.2 Suppression d'un combiné



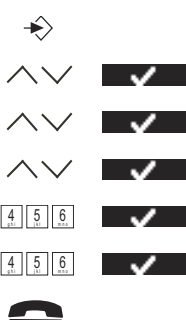





Cette procédure doit être réalisée sur un combiné différent de celui que vous souhaitez supprimer.



- 1** Accédez au menu.
- 2** Sélectionnez « Combiné » et validez.
- 3** Sélectionnez « Enregistrer » et validez.
- 4** Sélectionnez « Suppr. Comb. » et validez.
- 5** Saisissez le code PIN système (0000 par défaut) et validez.
- 6** Saisissez le numéro du combiné qui doit être supprimé et validez.
- 7** Revenez au mode veille.

### 9.3 Sélection d'une base

Vous pouvez basculer votre combiné d'une base vers une autre. Vous pouvez aussi le régler de façon qu'il sélectionne automatiquement la base offrant le meilleur signal. Le combiné doit, au préalable, être enregistré individuellement sur chaque base.



- |   |   |
|---|---|
|    | <b>1</b> Accédez au menu.                                       |
|   | <b>2</b> Sélectionnez « Combiné » et validez.                   |
|   | <b>3</b> Sélectionnez « Choix Base » et validez.                |
|   | <b>4</b> Sélectionnez « Manuel » ou « Auto » et validez.        |
|   | Si vous avez sélectionné « Manuel » :                           |
|   | <b>5</b> Sélectionnez la base à associer au combiné et validez. |



*Si vous avez activé la sélection de base automatique et que le combiné se trouve hors de portée de la base actuelle, il ne cherchera à s'associer à la base la plus proche qu'en mode de veille (pas pendant une communication).*



### 9.4 Fonction d'intercom

#### Appel vers un combiné interne

- |   |  |
|---|--|
| INT   | <b>1</b> Appuyez sur la touche gauche INT.   |
|   | L'écran affiche « Combiné _ ».   |
|  | <b>2</b> Saisissez le numéro interne du combiné que vous souhaitez joindre.                    |
|  | <b>3</b> Appuyez sur la touche Fin d'appel pour raccrocher ou replacez le combiné sur sa base. |

#### Transfert d'un appel externe vers un autre combiné

Pendant un appel externe :



- |   |  |
|---|--|
| INT   | <b>1</b> Appuyez sur la touche gauche INT.   |
|   | L'écran affiche « Combiné _ ».   |
|  | <b>2</b> Saisissez le numéro interne du combiné que vous souhaitez joindre.  |
|   | Votre correspondant externe est mis en attente.  |
|  | <b>3</b> Dès que le correspondant interne répond, appuyez sur la touche Fin d'appel pour transférer l'appel.   |
|   | OU   |
| INT   | <b>3</b> Si le correspondant interne ne répond pas, appuyez sur la touche gauche INT pour reprendre l'appel du correspondant externe ou pour transférer l'appel à quelqu'un d'autre. |
|  | <b>4</b> Appuyez sur la touche Fin d'appel pour raccrocher ou replacez le combiné sur sa base.   |

#### Conférence téléphonique

Vous pouvez associer 2 combinés et une ligne extérieure pour mener une conversation à trois.

Pendant un appel externe :



- |   |   |
|---|---|
| INT   | <b>1</b> Appuyez sur la touche gauche INT.                                  |
|   | L'écran affiche « Combiné _ ».  |
|  | <b>2</b> Saisissez le numéro interne du combiné que vous souhaitez joindre. |

-  **3** Dès que le correspondant interne répond, sélectionnez « Conf. ».
- OU
- 3** Si le correspondant interne ne répond pas, appuyez sur la touche gauche INT pour reprendre l'appel du correspondant externe.
-  **4** Appuyez sur la touche Fin d'appel pour raccrocher ou replacez le combiné sur sa base.

**Prise d'un appel externe pendant une communication interne**

Lorsque vous êtes en mode intercom avec un autre combiné interne, vous pouvez toujours répondre à un appel externe.

Pour prendre un appel entrant :

-  **1** Appuyez sur la touche Fin d'appel. La communication interne est alors interrompue.
-  **2** Appuyez sur la touche Prise d'appel. Vous êtes à présent en communication avec l'appelant externe.

**10 Problèmes et solutions**

Symptôme	Cause possible	Solution
Aucun affichage	Batteries déchargées	Vérifiez la position des batteries
		Rechargez les batteries
	Combiné désactivé	Activez le combiné
Pas de tonalité	Câble téléphonique mal raccordé	Vérifiez la connexion du câble téléphonique
	La ligne est occupée par un autre combiné	Attendez que l'autre combiné soit raccroché
L'icône  clignote	Combiné hors de portée	Rapprochez le combiné de la base
	La base n'est pas alimentée	Vérifiez la connexion électrique de la base
	Le combiné n'est pas enregistré sur la base	Enregistrez le combiné sur la base
La base ou le combiné ne sonne pas	Le volume de la sonnerie est désactivé ou faible	Réglez le volume de la sonnerie
Impossible de transférer un appel sur PABX	Le flash est trop court ou trop long	Modifiez le flash
Le téléphone ne répond pas lorsque vous appuyez sur les touches	Erreur de manipulation	Retirez les batteries et remettez-les en place.

## 11 Données et caractéristiques techniques

Norme	<b>DECT (Digital Enhanced Cordless Telecommunications)</b> <b>GAP (Generic Access Profile)</b>
Plage de fréquence	1880 MHz à 1900 MHz
Nombre de canaux	120 canaux duplex
Modulation	GFSK
Codage de la parole	32 kbit/s
Puissance d'émission	10 mW (puissance moyenne par canal)
Portée	300 m en zone dégagée ou 50 m maximum à l'intérieur
Nombre de combinés	Jusqu'à 4
Alimentation de la base	230V / 50 Hz/ 6V CC 300 mA
Batteries pour le combiné :	2 batteries rechargeables AAA, NiMh 1,2 V, 700 mA
Autonomie du combiné	110 heures en veille
Temps de conversation avec le combiné	11 heures
Conditions normales d'utilisation	+5 °C à +45 °C
Mode de numérotation	Impulsions / Tonalités
Durée de flash	100 ou 250 ms

## 12 Garantie

### 12.1 Période de garantie

Les appareils de Topcom bénéficient d'une période de garantie de 24 mois. La période de garantie commence le jour de l'achat du nouvel appareil. La garantie sur les batteries est limitée à 6 mois à compter de l'achat. Les accessoires et les défauts qui ont un effet négligeable sur le fonctionnement de l'appareil ne sont pas couverts.

La garantie doit être prouvée par la présentation du ticket original d'achat sur lequel sont mentionnés la date de l'achat et le modèle de l'appareil.

### 12.2 Traitement de la garantie

Tout appareil défectueux doit être retourné à un centre de service après-vente Topcom accompagné d'un ticket d'achat valable.

Si l'appareil tombe en panne pendant la période de garantie, Topcom ou son centre de service après-vente officiel réparera gratuitement toute panne due à un défaut matériel ou de fabrication. Topcom assurera, à sa seule discrétion, ses obligations en matière de garantie en réparant ou en remplaçant les appareils ou les pièces défectueux. En cas de remplacement, la couleur et le modèle peuvent être différents de ceux de l'appareil acheté initialement.

La date d'achat initiale détermine le début de la période de garantie. La période de garantie n'est pas prolongée si l'appareil est remplacé ou réparé par Topcom ou par l'un de ses centres de service après-vente officiels.

### 12.3 Exclusions de garantie

Les dommages et les pannes causés par un mauvais traitement ou une utilisation incorrecte et les dommages qui résultent de l'utilisation de pièces et d'accessoires non recommandés par Topcom ne sont pas couverts par la garantie. Les téléphones sans fil Topcom ont été conçus pour fonctionner avec des batteries rechargeables uniquement. Les dommages causés par l'utilisation de batteries non rechargeables ne sont pas couverts par la garantie.

La garantie ne couvre pas les dommages causés par des facteurs extérieurs tels que la foudre, l'eau et le feu ni les dommages provoqués par le transport.

Aucune garantie ne peut être invoquée si le numéro de série indiqué sur les appareils a été modifié, enlevé ou rendu illisible. Aucune garantie ne peut non plus être invoquée si l'appareil a été réparé ou modifié par l'acheteur ou par des techniciens non qualifiés et non agréés par Topcom.

## 13 Mise au rebut de l'appareil (environnement)



Au terme du cycle de vie de ce produit, ne le jetez pas avec les déchets ménagers ordinaires mais déposez-le dans un point de collecte pour le recyclage des équipements électriques et électroniques. Le symbole indiqué sur ce produit, sur le mode d'emploi et/ou sur la boîte est là pour vous le rappeler.

Certains matériaux qui composent le produit peuvent être réutilisés si vous les déposez dans un point de recyclage. En réutilisant certaines pièces ou matières premières de produits usagés, vous contribuez fortement à la protection de l'environnement.

Pour toute information supplémentaire sur les points de collecte dans votre région, contactez les autorités locales.

## 14 Nettoyage

Nettoyez le téléphone à l'aide d'un chiffon légèrement humide ou antistatique. N'utilisez jamais de détergents ni de solvants abrasifs.

## 15 Mode ECO (faible rayonnement)

- Ce téléphone sans fil (conforme à la norme DECT) permet un fonctionnement à faible rayonnement.
- L'intensité du rayonnement du signal radio entre la station de base et le combiné est réduite au minimum lorsque le combiné se trouve sur la station de base.
- L'intensité du rayonnement du signal radio n'augmente pour atteindre sa puissance normale que lorsque le combiné est retiré de la station de base ou lorsqu'un appel entre.
- Cela ne signifie par pour autant que le rayonnement DECT normal est nocif pour la santé.
- Le mode de faible rayonnement empêche tout rayonnement DECT inutile lorsque aucune communication n'est nécessaire entre la station de base et le combiné.
- Pour des raisons techniques, aucun combiné supplémentaire ne peut être utilisé en mode de rayonnement faible (un combiné supplémentaire situé à proximité immédiate de la station de base « rechercherait » celle-ci en permanence en raison de la faiblesse du signal radio).
- Le mode de faible rayonnement est activé en usine.
- Le mode de faible rayonnement est désactivé automatiquement si vous branchez un combiné supplémentaire.
- Le mode de faible rayonnement est réactivé immédiatement si vous débranchez tous les combinés supplémentaires (un seul combiné peut être connecté à la station de base).
- La procédure de branchement et de débranchement des combinés est expliquée dans le mode d'emploi.

## Deutsch

### 1 Sicherheitshinweise

- Verwenden Sie nur den mitgelieferten Netzadapter. Verwenden Sie keine fremden Adapter, da die Akkuzellen beschädigt werden könnten.
- Verwenden Sie nur aufladbare Batterien des gleichen Typs. Verwenden Sie niemals normale, nicht-aufladbare Batterien. Achten Sie beim Einlegen der Batterien auf richtige Polarität (wie im Batteriefach des Mobilteils angegeben).
- Berühren Sie nicht die Lade- und Steckerkontakte mit spitzen oder metallischen Gegenständen.
- Medizinische Geräte können in ihrer Funktion beeinflusst werden.
- Das Mobilteil kann in Hörgeräten einen unangenehmen Brummtönen verursachen.
- Stellen Sie das Basisgerät nicht in einem feuchten Raum oder in einem Abstand von weniger als 1,5 m von einem Wasseranschluss auf. Lassen Sie kein Wasser an das Mobilteil kommen.
- Verwenden Sie das Telefon nicht in Umgebungen, in denen Explosionsgefahr besteht.
- Entsorgen Sie die Batterien und das Telefon auf umweltfreundliche -Weise.
- Da bei Stromausfall das Telefonieren mit diesem Gerät nicht möglich ist, verwenden Sie bitte im Falle eines Notrufs ein -stromnetzunabhängiges Telefon, z. B. ein Handy.

### 2 Erste Schritte

#### 2.1 Zum Gebrauch dieser Bedienungsanleitung

In dieser Bedienungsanleitung wird folgende Methode angewendet, um die Anweisungen zu verdeutlichen:

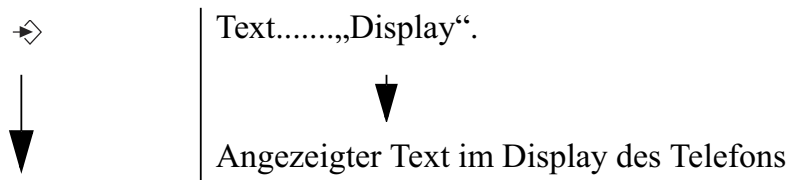

Zu drückende Taste. Diese Taste kann eine Menütaste sein (Siehe „2.4 Tasten / Anzeigen“). Ist die Menütaste ein Symbol, so wird sie in der linken Spalte abgebildet. Ist die Menütaste ein Text, wird die rechte oder linke Menütaste in der linken Spalte und der Text in der rechten Spalte in Anführungszeichen abgebildet.

#### 2.2 Basisstation installieren

Zur Installation gehen Sie folgendermaßen vor:

- 1** Verbinden Sie das eine Ende des Netzadapters mit der Steckdose und das andere Ende mit der Adapterbuchse auf der Rückseite der Basisstation.
- 2** Verbinden Sie das eine Ende des Telefonkabels mit dem Telefonwandanschluss und das andere Ende mit dem Anschluss auf der Rückseite der Basisstation.
- 3** Befestigen Sie das Telefon- und das Netzkabel wie in Abbildung 2A dargestellt.

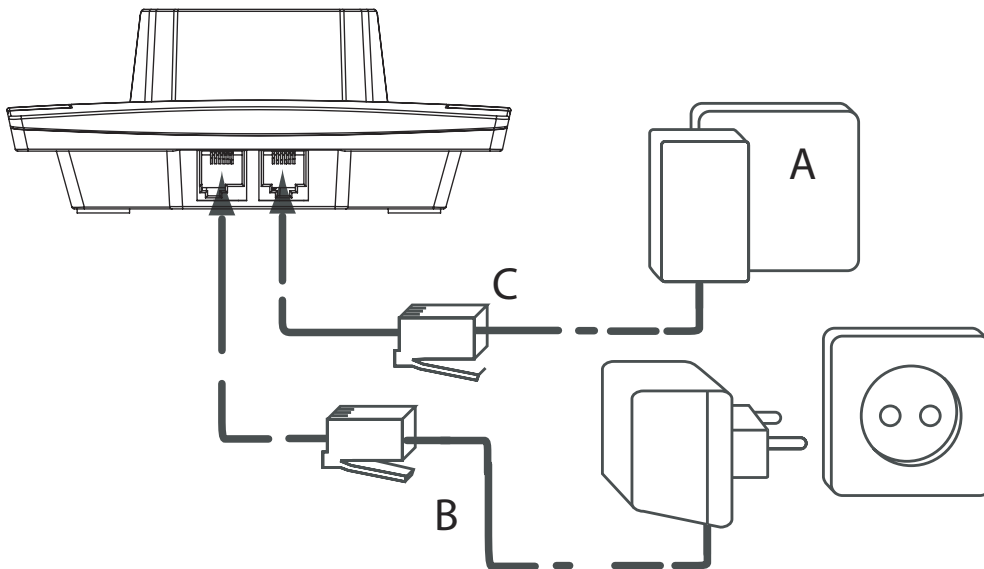

- 3A Rückseite der Basisstation -

A. Telefonwandanschluss

B. Netzkabel

C. Telefonkabel

## 2.3 Mobilteil installieren

- 1 Öffnen Sie das Batteriefach wie in Abbildung 2B dargestellt.
- 2 Legen Sie die Batterien ein. Achten Sie dabei auf die Polarität (+ und -).
- 3 Schließen Sie das Batteriefach.
- 4 Lassen Sie das Mobilteil 20 Stunden auf der Basisstation stehen. Die Ladeanzeige  an der Basisstation leuchtet auf.

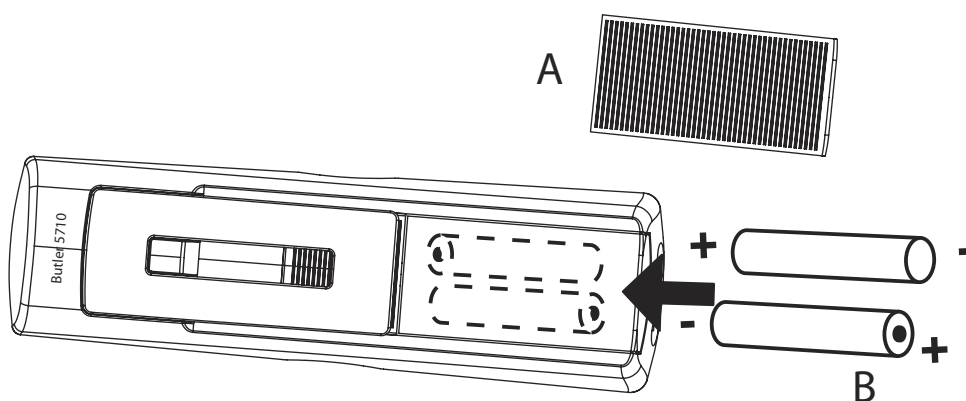

- 3B Rückseite des Mobilteils -

A. Abdeckung

B. Wiederaufladbare Batterien



Bevor Sie das Telefon verwenden, stellen Sie sicher, dass die Akkus 20 Stunden aufgeladen wurden. Geschieht dies nicht, funktioniert das Telefon nicht optimal.

## 2.4 Tasten / Anzeigen

### Mobilteil

1. Display
2. Nach-oben-Taste / Wahlwiederholung
3. Rechte Menütaste
4. Nach-rechts-Taste / Flash-Taste
5. Auflegen / AUS-Taste
6. Alphanumerische Tasten
7. Tastatursperre
8. Rufton-Aus-Taste
9. Nach-unten-Taste / Anrufliste
10. Gespräch annehmen / Freisprech- / EIN-Taste
11. Nach-links-Taste / Interner Anruf INT
12. OK-Taste
13. Linke Menütaste

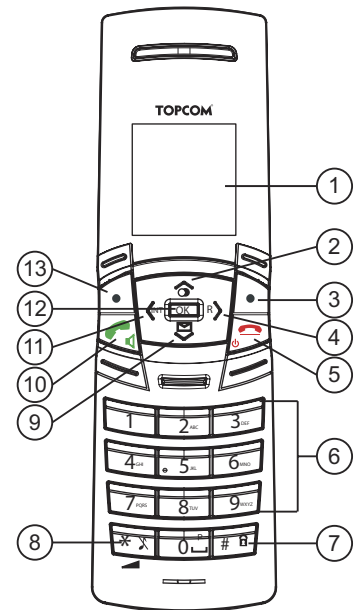

- 3C Mobilteil -





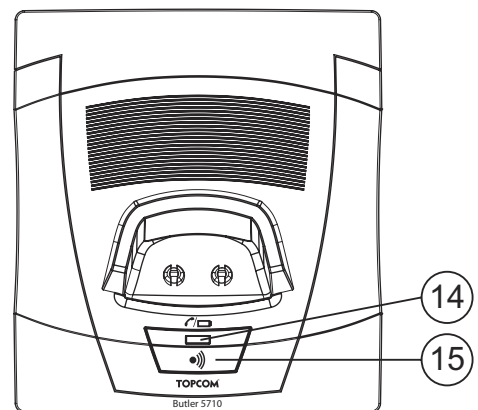









### Basisstation

14. LED-Anzeige: In Betrieb / Strom / Mobilteil auf Basisstation
15. Paging-Taste



- 3D Basisstation -

## 2.5 Symbole

	Gespräch angenommen		Tastatursperre
	Aufgelegt		Wecker eingeschaltet
	Entgangene Anrufe in der Anrufliste*		Mobilteil nicht angemeldet oder außer Reichweite
	Ruftonlautstärke Mobilteil AUS		Batterie leer
	Mobilteil innerhalb der Reichweite der Basisstation		Batterie schwach
	Interner Anruf		Batteriestand mittel
	Freisprechmodus aktiviert		Batterie voll
	Neue Mailbox-Nachricht		

\* Wenn die Anruferkennung für Ihren Telefonanschluss aktiviert ist.



## 2.6 Displaytasten

Die Displaytasten (Menütasten) befinden sich direkt unter dem Display. Die Funktion dieser 2 Tasten ändert sich je nach Betriebsmodus. Die jeweilige Funktion wird als Symbol oder Text direkt über den beiden Displaytasten angezeigt.

	Telefonbuch		Stummschaltung aktiviert
	OK / Bestätigen		Zurück
	Menü		Keine Taste
	Löschen		





## 2.7 LED der Basisstation

Die LED (14) zeigt folgendes an:



- AUS: Die Basisstation ist nicht an das Netz angeschlossen oder das Mobilteil befindet sich nicht auf der Basisstation
- EIN: Das Mobilteil wird geladen
- Langsames Blinken: Gespräch angenommen oder Telefon klingelt
- Schnelles Blinken: während der Anmeldung

## 2.8 Durch das Menü navigieren

Das Butler 5710 verfügt über ein leicht zu bedienendes Menü-System. Jedes Menü besteht aus einer Reihe von Unterpunkten. Die Menü-Übersicht finden Sie im folgenden Abschnitt.

- |   |   |
|---|---|
|  | <b>1</b> Um das Hauptmenü aufzurufen, drücken Sie die linke Menütaste  bei eingeschaltetem Mobilteil im Standby-Modus. |
|  | <b>2</b> Bewegen Sie sich zum gewünschten Menüpunkt.  |
|  | <b>3</b> Drücken Sie die Menütaste zum Aufrufen weiterer Unterpunkte oder zum Bestätigen der angezeigten Einstellung.   |

### Das Menü verlassen oder eine Stufe im Menü zurückgehen

- |   |  |
|---|--|
|  | Um zur vorherigen Stufe des Menüs zurückzugehen, drücken Sie die Menütaste.          |
|  | Zum Abbrechen und Zurückkehren in den Standby-Modus, drücken Sie die Auflegen-Taste. |

## 2.9 Menü-Übersicht

Menü	Untermenüpunkte
Mobilteil	Rufton Ruftonlautstärke Mobilteil Name Tastenton Kontrast Automatische Annahme Automatische Vorwahl Basis auswählen Sprache Anmelden
Basis Einstellungen	Rufton Ruftonlautstärke Wahlverfahren Flash PIN Nummer
Wecker	Wecker einstellen Datum/Uhr Zeitformat
Extras	Termin Stoppuhr
Ausschalten	

## 3 Telefon benutzen

### 3.1 Mobilteil ein-/ausschalten



- 1 Halten Sie die AUS-Taste gedrückt, um das Mobilteil auszuschalten.
- 2 Drücken Sie die Taste Gespräch annehmen oder stellen Sie das Mobilteil auf die Basisstation, um es einzuschalten.

### 3.2 Menüsprache ändern



- 1 Rufen Sie das Menü auf.
- 2 Wählen Sie „Mobilteil“ und bestätigen Sie.
- 3 Wählen Sie „Sprache“ und bestätigen Sie.
- 4 Wählen Sie die gewünschte Sprache und bestätigen Sie.  
Im Display erscheint „Gespeichert“.
- 5 Drücken Sie die Auflegen-Taste, um in den Standby-Modus zu gelangen.



Die  Pfeile zeigen an, dass das Menü weitere Unterpunkte enthält.

### 3.3 Telefonieren

#### Direkt wählen



- 1** Drücken Sie die Taste Gespräch annehmen, um das Gespräch zu beginnen.
- 2** Geben Sie die Telefonnummer ein.
- 3** Drücken Sie die Auflegen-Taste oder stellen Sie das Mobilteil auf die Basisstation, um das Gespräch zu beenden.

#### Vorwählen

Mit der Funktion Vorwählen, können Sie die Telefonnummer vor dem Gespräch eingeben und ändern.



- 1** Geben Sie eine Nummer mit bis zu 24 Ziffern ein.  
Halten Sie die Taste 0 gedrückt, um eine Pause einzugeben. Im Display erscheint ein „P“.
- 2** Drücken Sie die Menütaste zum Korrigieren.
- 3** Drücken Sie die Taste Gespräch annehmen, um das Gespräch zu beginnen.
- 4** Drücken Sie die Auflegen-Taste oder stellen Sie das Mobilteil auf die Basisstation, um das Gespräch zu beenden.

#### Eine Nummer aus der Wahlwiederholungsliste wählen

Sie können die letzten 10 gewählten Nummern erneut wählen. Haben Sie im Telefonbuch einen Namen mit dieser Nummer gespeichert, erscheint der Name in der Liste.



- 1** Drücken Sie die Taste Wahlwiederholung.
- 2** Wählen Sie eine Nummer aus. Ist die Nummer im Telefonbuch gespeichert, erscheint der Name.
- 3** Drücken Sie die Taste Gespräch annehmen, um das Gespräch zu beginnen, oder wählen Sie „Option“.
- 4** Haben Sie „Option“ gewählt, wählen Sie einen der folgenden Punkte:  
„Nr. löschen“: um die Nummer aus der Liste zu löschen  
„Nr. speichern“: um die Nummer im Telefonbuch zu speichern  
„Alle löschen“: um die Liste zu löschen
- 5** Bestätigen Sie die Auswahl.
- 6** Drücken Sie die Auflegen-Taste, um in den Standby-Modus zu gelangen.

### 3.4 Einen Anruf annehmen

Wenn Sie einen externen Anruf erhalten, erscheint im Display „Ext. Anruf“.

Um den Anruf anzunehmen:



- 1** Drücken Sie die Taste Gespräch annehmen.  
ODER  
Nehmen Sie das Mobilteil von der Basisstation, wenn Sie „Auto. Annahme“ aktiviert haben (Siehe „6.5 Automatische Anrufannahme“)  
Das Symbol  Gespräch angenommen erscheint im Display. Die Gesprächsdauer wird nach 15 Sekunden angezeigt.
- 2** Drücken Sie die Auflegen-Taste oder stellen Sie das Mobilteil auf die Basisstation, um das Gespräch zu beenden.



*Sie können die Rufionlautstärke während eines eingehenden Anrufs mit „Leise“ ausschalten.*

### 3.5 Freisprechmodus

Im Freisprechmodus können Sie telefonieren, ohne das Mobilteil in der Hand zu halten. Außerdem können andere Personen im Raum das Gespräch mitverfolgen.



- 1 Zum Aktivieren des Freisprechmodus, drücken Sie während eines Telefonats die Freisprechtaste.

### 3.6 Lautstärke Hörmuschel / Freisprechmodus anpassen



- 1 Drücken Sie die Tasten Nach-oben oder Nach-unten und wählen Sie Lautstärkestufe 1-5 während eines normalen Telefonats oder im Freisprechmodus.

### 3.7 Stummschaltung (Mute)

Sie können das Mikrofon ausschalten, so dass ihr Gesprächspartner Sie nicht mehr hört.



- 1 Drücken Sie während eines Gesprächs die Menütaste, um das Mikrofon auszuschalten.

„Mikrofon Aus“ erscheint im Display.



- 2 Wählen Sie „Aus“, um das Mikrofon wieder einzuschalten.

### 3.8 Mobilteil suchen (Paging)



- 1 Drücken Sie die Taste Paging an der Basisstation.

Alle an der Basisstation angemeldeten Mobilteile klingeln 30 Sekunden lang.



- 2 Drücken Sie eine beliebige Taste am Mobilteil, um das Klingeln zu beenden.

### 3.9 Tastatursperre

Sie können die Tastatur sperren, um unbeabsichtigtes Wählen beim Herumtragen des Mobilteils zu verhindern.

Im Standby-Modus:



- 1 Halten Sie die Taste Tastatursperre gedrückt (Taste 7 - Abbildung 2C), bis „Tasten gesperrt“ und das Symbol Tastatur gesperrt  im Display erscheinen.



- 2 Um die Tastatursperre wieder aufzuheben, drücken Sie „entsp.“ und anschließend die Taste Tastatursperre.

### 3.10 Die alphanumerischen Tasten verwenden

Sie können mit Ihrem Telefon auch alphanumerische Zeichen eingeben. Das ist notwendig, um Namen in das Telefonbuch einzugeben, zum Benennen des Mobilteils, ...

Zur Auswahl eines Buchstabens, drücken Sie die entsprechende Taste so oft wie notwendig.

Drücken Sie z. B. für den Buchstaben 'A' die Taste '2' einmal. Für den Buchstaben 'B' drücken Sie die Taste '2' zweimal, usw. Um die Buchstaben 'A' und 'B' hintereinander einzugeben, drücken Sie die Taste '2' einmal, warten Sie, bis der Cursor zur nächsten Stelle springt und drücken Sie dann die Taste '2' zweimal. Während der Eingabe eines Textes erscheinen die verfügbaren Zeichen jeder Taste unten im Display.













Sie können die Eingabezeichen von Englisch (abc) auf Lateinisch (aää), Griechisch (ABΓ) oder Russisch (ABB) umstellen, indem Sie die Taste # 2 Sekunden lang drücken.

┌	Drücken Sie die Taste '0', um eine Leerstelle einzufügen.
*	Drücken Sie die Taste '*', um von Kleinbuchstaben zu Großbuchstaben zu wechseln.
#	Halten Sie die Taste '#' 2 Sekunden gedrückt, um den Eingabezeichensatz zu ändern.
	Drücken Sie die Menütaste zum Korrigieren.





## 4 Telefonbuch

Jedes Mobilteil kann bis zu 200 Namen und Telefonnummern speichern. Namen können bis zu 16 Zeichen und Telefonnummern bis zu 24 Ziffern lang sein.







### 4.1 Einen Eintrag hinzufügen

	<b>1</b> Drücken Sie die Menütaste.
	Ist das Telefonbuch leer, erscheint „Telefonbuch leer“ im Display. Wenn bereits Namen gespeichert wurden, werden diese angezeigt.
 	<b>2</b> Wählen Sie „Option“.
 	<b>3</b> Wählen Sie „Neuer Eintrag“ und bestätigen Sie.
 	<b>4</b> Geben Sie den Namen über die Tastatur ein und wählen Sie „Speich“.
 	<b>5</b> Geben Sie die Telefonnummer über die Tastatur ein und wählen Sie „Speich“.
	<b>6</b> Wählen Sie die gewünschte Rufmelodie und wählen Sie „Speich“.
	<b>7</b> Kehren Sie in den Standby-Modus zurück.

### 4.2 Eine Nummer aus dem Telefonbuch anrufen

	<b>1</b> Drücken Sie die Menütaste.
	<b>2</b> Suchen Sie den gewünschten Namen oder geben Sie über die Tastatur den ersten Buchstaben des Namens ein.
	<b>3</b> Drücken Sie die Taste Gespräch annehmen, um das Gespräch zu beginnen.
	<b>4</b> Kehren Sie in den Standby-Modus zurück.

### 4.3 Einen Telefonbucheintrag anzeigen

	<b>1</b> Drücken Sie die Menütaste.
	<b>2</b> Suchen Sie den gewünschten Namen oder geben Sie über die Tastatur den ersten Buchstaben des Namens ein.
	<b>3</b> Wählen Sie „Option“.
 	<b>4</b> Wählen Sie „Eintrag anz.“ und bestätigen Sie. Der Name, die Telefonnummer und die Rufmelodie, die Sie dem Eintrag zugeordnet haben, erscheinen im Display.
	<b>5</b> Kehren Sie in den Standby-Modus zurück.

#### 4.4 Einen Eintrag oder alle Einträge löschen



- 1** Drücken Sie die Menütaste.
  - 2** Suchen Sie den gewünschten Namen oder geben Sie über die Tastatur den ersten Buchstaben des Namens ein.
  - 3** Wählen Sie „Option“.
- Um einen Eintrag zu löschen:
- 4** Wählen Sie „Eintrag lösch.“ und bestätigen Sie.
- Um alle Einträge zu löschen:
- 4** Wählen Sie „Alle löschen“ und bestätigen Sie.
  - 5** Drücken Sie die linke Menütaste, um abzubrechen oder die rechte Menütaste, um zu bestätigen.
  - 6** Kehren Sie in den Standby-Modus zurück.

#### 4.5 Einen Namen und Telefonnummer bearbeiten



- 1** Drücken Sie die Menütaste.
- 2** Suchen Sie den gewünschten Namen oder geben Sie über die Tastatur den ersten Buchstaben des Namens ein.
- 3** Wählen Sie „Option“.
- 4** Wählen Sie „Eintr. bearb.“ und bestätigen Sie.
- 5** Drücken Sie die Menütaste, um den Namen zu löschen und geben Sie den neuen Namen über die Tastatur ein.
- 6** Wählen Sie „Speich“.
- 7** Geben Sie die neue Nummer ein und wählen Sie „Speich“.
- 8** Wählen Sie die gewünschte Ruftonmelodie und wählen Sie „Speich“.
- 9** Kehren Sie in den Standby-Modus zurück.

#### 4.6 Einen Telefonbucheintrag auf ein anderes Mobilteil kopieren



- 1** Drücken Sie die Menütaste.
  - 2** Suchen Sie den gewünschten Namen oder geben Sie über die Tastatur den ersten Buchstaben des Namens ein.
  - 3** Wählen Sie „Option“.
  - 4** Wählen Sie „Eintr. Kop.“ und bestätigen Sie.
- Die verfügbaren Mobilteile werden angezeigt (alle Mobilteile, die an der Basisstation angemeldet sind).
- 5** Wählen Sie das gewünschte Mobilteil aus und bestätigen Sie.
- „Kopiere nach Mobilteil x“ erscheint im Display.
- „Telefonbucheintrag empfangen?“ erscheint im Display des ausgewählten Mobilteils.
- 6** Drücken Sie auf diesem Mobilteil die rechte Menütaste zum Bestätigen oder die linke Menütaste, um die Übertragung abzubrechen.
  - 7** Kehren Sie in den Standby-Modus zurück.

## 4.7 Alle Telefonbucheinträge auf ein anderes Mobilteil kopieren



Durch das Kopieren aller Einträge von einem Mobilteil zum anderen, löschen Sie alle bestehenden Einträge des empfangenden Mobilteils.



- 1** Drücken Sie die Menütaste.
- 2** Suchen Sie den gewünschten Namen oder geben Sie über die Tastatur den ersten Buchstaben des Namens ein.
- 3** Wählen Sie „Option“.
- 4** Wählen Sie „Alle Kopieren“ und bestätigen Sie.  
Die verfügbaren Mobilteile werden angezeigt (alle Mobilteile, die an der Basisstation angemeldet sind).
- 5** Wählen Sie das gewünschte Mobilteil aus und bestätigen Sie.  
“Kopiere nach Mobilteil x“ erscheint im Display.  
“Alle Telefonbucheinträge ersetzen?“ erscheint im Display des ausgewählten Mobilteils.
- 6** Drücken Sie auf diesem Mobilteil die rechte Menütaste zum Bestätigen oder die linke Menütaste, um die Übertragung abzubrechen.
- 7** Kehren Sie in den Standby-Modus zurück.

## 5 Anruferkennung

### 5.1 Normale eingehende PSTN-Anrufe



Dieser Dienst muss von Ihrem Telefonnetzanbieter aktiviert werden. Bitte setzen Sie sich mit Ihrem Netzanbieter in Verbindung.

Wenn Sie einen Anruf auf Ihrem Festnetzanschluss erhalten, erscheint die Telefonnummer des Anrufers im Display des Mobilteils. Das Telefon kann Anrufe im FSK- und DTMF-Modus empfangen. Sie können auch den Namen sehen, wenn er über das Netz übertragen wird. Ist der Name im Telefonbuch gespeichert, wird er im Display angezeigt!

Das Telefon kann 30 Anrufe in der Anrufliste (entgegengenommene und entgangene Anrufe) speichern, die Sie später anzeigen lassen können. Wenn der Speicher voll ist, überschreiben neue Anrufe automatisch die ältesten Einträge im Speicher.

















Entgangene Anrufe werden mit einem blinkenden Symbol im Display angezeigt. Der Name des Mobilteils wird durch das Symbol und die Anzahl der entgangenen Anrufe ersetzt.

### Empfangene Anrufe anzeigen



- 1** Drücken Sie die Nach-unten-Taste.  
Die Anrufliste erscheint im Display. Sie besteht aus entgegengenommenen und entgangenen Anrufen.
- 2** Wählen Sie den gewünschten Namen oder Nummer.











- |   |  |
|---|--|
|    | <b>3</b> Drücken Sie die Taste Gespräch annehmen, um das Gespräch zu beginnen.<br>ODER<br>Wählen Sie „Option“. |
|    | Um einen Eintrag zu löschen:   |
|   | <b>4</b> Wählen Sie „Nr. löschen“ und bestätigen Sie.  |
|    | <b>5</b> Kehren Sie in den Standby-Modus zurück.   |
|   | Um alle Einträge zu löschen:   |
|   | <b>5</b> Wählen Sie „Alle löschen“ und bestätigen Sie.   |
|    | <b>6</b> Kehren Sie in den Standby-Modus zurück.   |
|   | Die Telefonnummer zum Telefonbuch hinzufügen:  |
|   | <b>5</b> Wählen Sie „Nr. speichern“ und bestätigen Sie.  |
|    | <b>6</b> Geben Sie den Namen über die Tastatur ein und wählen Sie „Speich“.                                    |
|    | <b>7</b> Bearbeiten Sie die Telefonnummer mithilfe der Tastatur und wählen Sie „Speich“.                       |
|   | <b>8</b> Wählen Sie die gewünschte Ruftonmelodie und wählen Sie „Speich“.                                      |
|    | <b>9</b> Kehren Sie in den Standby-Modus zurück.   |

## 6 Mobilteil individuell anpassen

### 6.1 Rufton und Lautstärke









#### Rufton

Sie können 18 verschiedene Ruftonmelodien für interne und externe Anrufe wählen.

- |   |   |
|---|---|
|    | <b>1</b> Rufen Sie das Menü auf.  |
|   | <b>2</b> Wählen Sie „Mobilteil“ und bestätigen Sie.   |
|   | <b>3</b> Wählen Sie „Rufton“ und bestätigen Sie.  |
|   | <b>4</b> Wählen Sie „Extern“ für externe Anrufe oder wählen Sie „Intern“ für interne Anrufe und bestätigen Sie. |
|   | <b>5</b> Wählen Sie die gewünschte Melodie aus und bestätigen Sie.  |
|   | Während Sie durch die Liste blättern, wird die jeweilige Melodie abgespielt.                                    |
|    | <b>6</b> Kehren Sie in den Standby-Modus zurück.  |

#### Ruftonlautstärke









Sie können 5 Ruftonlautstärken am Mobilteil einstellen und den Rufton ausschalten.

- |   |   |
|---|---|
|    | <b>1</b> Rufen Sie das Menü auf.  |
|   | <b>2</b> Wählen Sie „Mobilteil“ und bestätigen Sie.                             |
|   | <b>3</b> Wählen Sie „Rufton Laut.“ und bestätigen Sie.                          |
|   | Die aktuelle Einstellung erscheint im Display.                                  |
|    | <b>4</b> Drücken Sie die Nach-oben-Taste, um die Lautstärke zu erhöhen.         |
|    | <b>5</b> Drücken Sie die Nach-unten-Taste, um die Lautstärke leiser zu stellen. |
|    | <b>6</b> Wählen Sie „Speich“ und bestätigen Sie.                                |
|    | <b>7</b> Kehren Sie in den Standby-Modus zurück.                                |











## 6.2 Mobilteil-Name









Sie können den Namen, der im Display des Mobilteils im Standby-Modus angezeigt wird, ändern (max. 9 Zeichen).

- |   |          |   |
|---|----------|---|
|    | <b>1</b> | Rufen Sie das Menü auf.                       |
|   | <b>2</b> | Wählen Sie „Mobilteil“ und bestätigen Sie.    |
|   | <b>3</b> | Wählen Sie „Mobilt. Name“ und bestätigen Sie. |
|    | <b>4</b> | Geben Sie den gewünschten Namen ein.          |
|    | <b>5</b> | Drücken Sie die Menütaste zum Korrigieren.    |
|    | <b>6</b> | Wählen Sie „Speich“ und bestätigen Sie.       |
|    | <b>7</b> | Kehren Sie in den Standby-Modus zurück.       |

## 6.3 Tastentöne









- |   |          |   |
|---|----------|---|
|    | <b>1</b> | Rufen Sie das Menü auf.                         |
|   | <b>2</b> | Wählen Sie „Mobilteil“ und bestätigen Sie.      |
|   | <b>3</b> | Wählen Sie „Tastenton“ und bestätigen Sie.      |
|   | <b>4</b> | Wählen Sie „Ein“ oder „Aus“ und bestätigen Sie. |
|    | <b>5</b> | Kehren Sie in den Standby-Modus zurück.         |

## 6.4 Kontrast einstellen

- |   |          |   |
|---|----------|---|
|    | <b>1</b> | Rufen Sie das Menü auf.   |
|   | <b>2</b> | Wählen Sie „Mobilteil“ und bestätigen Sie.                        |
|   | <b>3</b> | Wählen Sie „Kontrast“ und bestätigen Sie.                         |
|   | <b>4</b> | Wählen Sie die gewünschte Kontraststufe (1-8) und bestätigen Sie. |
|    | <b>5</b> | Kehren Sie in den Standby-Modus zurück.                           |



## 6.5 Automatische Anrufannahme











Steht das Mobilteil bei einem ankommenden Anruf auf der Basisstation, so wird das Gespräch automatisch angenommen, sobald das Mobilteil von der Basisstation abgehoben wird. Diese Funktion kann ein- oder ausgeschaltet werden.

- |   |          |   |
|---|----------|---|
|    | <b>1</b> | Rufen Sie das Menü auf.                         |
|   | <b>2</b> | Wählen Sie „Mobilteil“ und bestätigen Sie.      |
|   | <b>3</b> | Wählen Sie „Auto. Annahme“ und bestätigen Sie.  |
|   | <b>4</b> | Wählen Sie „Ein“ oder „Aus“ und bestätigen Sie. |
|    | <b>5</b> | Kehren Sie in den Standby-Modus zurück.         |

## 6.6 Automatische Vorwahl

Sie können Ihr Telefon mit einer festen Vorwahlnummer verwenden. Wenn Sie eine Telefonnummer wählen, können Sie automatisch die Vorwahl vor die Nummer hinzufügen.















- |   |          |  |
|---|----------|--|
|    | <b>1</b> | Rufen Sie das Menü auf.                    |
|   | <b>2</b> | Wählen Sie „Mobilteil“ und bestätigen Sie. |

- |   |   |  |
|---|---|--|
|  |  | <b>3</b> Wählen Sie „Auto. Vorwahl“ und bestätigen Sie.                |
|  |  | <b>4</b> Wählen Sie „Bearbeiten“ und bestätigen Sie.                   |
|  |  | <b>5</b> Geben Sie die Vorwahl ein, z. B. '0' und wählen Sie „Speich“. |
| ODER  |   |  |
|  |  | <b>4</b> Wählen Sie „Ein/Aus“ und bestätigen Sie.                      |
|  |  | <b>5</b> Wählen Sie „Ein“ oder „Aus“ und bestätigen Sie.               |
|  |   | <b>6</b> Kehren Sie in den Standby-Modus zurück.                       |









## 6.7 Weckfunktion verwenden

Sie können für jedes Mobilteil, das an der Basisstation angemeldet ist, die Weckfunktion einzeln einstellen. Der Wecker klingelt nur am Mobilteil, nicht an der Basisstation oder einem anderen Mobilteil.









### Wecker einstellen

- |   |   |  |
|---|---|--|
|    |   | <b>1</b> Rufen Sie das Menü auf.   |
|    |    | <b>2</b> Wählen Sie „Wecker“ und bestätigen Sie.   |
|    |    | <b>3</b> Wählen Sie „Wecker einst.“ und bestätigen Sie.  |
|    |    | <b>4</b> Wählen Sie „Einmal“, „Täglich“, „Mon - Fr“ oder „Aus“ und bestätigen Sie.<br>Wenn Sie „Einmal“, „Täglich“ oder „Mon - Fr“ gewählt haben, zeigt das Display folgendes an:<br>Zeit 24 Std:<br>00:00 |
|  |  | <b>5</b> Geben Sie die gewünschte Weckzeit ein und bestätigen Sie mit „Speich“.  |
|  |  | <b>6</b> Wählen Sie den gewünschten Rufton und bestätigen Sie mit „Speich“.  |
|  |  | <b>7</b> Um den Wecker auszuschalten, wählen Sie „Aus“ und bestätigen Sie.   |
|  |   | <b>8</b> Kehren Sie zum vorhergehenden Menüpunkt zurück.   |

## 6.8 Datum und Uhrzeit einstellen

- |   |   |   |
|---|---|---|
|  |   | <b>1</b> Rufen Sie das Menü auf.  |
|  |  | <b>2</b> Wählen Sie „Wecker“ und bestätigen Sie.  |
|  |  | <b>3</b> Wählen Sie „Datum/Uhr“ und bestätigen Sie.   |
|  |  | <b>4</b> Geben Sie Jahr, Monat, Tag, Stunden und Minuten ein und bestätigen Sie mit „Speich“. |
|  |   | <b>5</b> Kehren Sie zum vorhergehenden Menüpunkt zurück.                                      |









## 6.9 Zeitformat einstellen

- |   |   |  |
|---|---|--|
|  |   | <b>1</b> Rufen Sie das Menü auf.                                       |
|  |  | <b>2</b> Wählen Sie „Wecker“ und bestätigen Sie.                       |
|  |  | <b>3</b> Wählen Sie „Zeitformat“ und bestätigen Sie.                   |
|  |  | <b>4</b> Wählen Sie „12 Stunden“ oder „24 Stunden“ und bestätigen Sie. |
|  |   | <b>5</b> Kehren Sie zum vorhergehenden Menüpunkt zurück.               |

## 7 Basis Einstellungen









### 7.1 Rufton

Sie können 9 verschiedene Ruftonmelodien wählen.

- |   |  |
|---|--|
|    | <b>1</b> Rufen Sie das Menü auf.                                   |
|   | <b>2</b> Wählen Sie „Basis Einst.“ und bestätigen Sie.             |
|   | <b>3</b> Wählen Sie „Rufton“ und bestätigen Sie.                   |
|   | <b>4</b> Wählen Sie die gewünschte Melodie aus und bestätigen Sie. |
|    | <b>5</b> Kehren Sie in den Standby-Modus zurück.                   |
- Während Sie durch die Liste blättern, wird die jeweilige Melodie abgespielt.

### 7.2 Ruftonlautstärke

Sie können 5 Ruftonlautstärken an der Basisstation einstellen.









- |   |   |
|---|---|
|    | <b>1</b> Rufen Sie das Menü auf.  |
|   | <b>2</b> Wählen Sie „Basis Einst.“ und bestätigen Sie.                          |
|   | <b>3</b> Wählen Sie „Rufton Laut.“ und bestätigen Sie.                          |
|   | <b>4</b> Drücken Sie die Nach-oben-Taste, um die Lautstärke zu erhöhen.         |
|    | <b>5</b> Drücken Sie die Nach-unten-Taste, um die Lautstärke leiser zu stellen. |
|    | <b>6</b> Wählen Sie „Speich“ und bestätigen Sie.                                |
|    | <b>7</b> Kehren Sie in den Standby-Modus zurück.                                |
- Die aktuelle Einstellung erscheint im Display.

### 7.3 Wahlverfahren

Es gibt zwei Wahlverfahren:





- DTMF/Tonwahlverfahren (am häufigsten)
- Impulswahlverfahren (bei älteren Geräten)

Um das Wahlverfahren zu ändern:

- |   |  |
|---|--|
|    | <b>1</b> Rufen Sie das Menü auf.   |
|   | <b>2</b> Wählen Sie „Basis Einst.“ und bestätigen Sie.                   |
|   | <b>3</b> Wählen Sie „Wahlverfahren“ und bestätigen Sie.                  |
|   | <b>4</b> Wählen Sie „Ton“ oder „Impuls“ und bestätigen Sie mit „Speich“. |
|    | <b>5</b> Kehren Sie in den Standby-Modus zurück.                         |

### 7.4 Flash

Drücken Sie die Flashtaste „R“ (Taste 4 - Abbildung 2C), um verschiedene Dienste wie „Anklopfen“ (wenn dieser Dienst von Ihrem Telefonanbieter unterstützt wird) zu nutzen oder um Anrufe weiterzuleiten, wenn Sie eine Telefonanlage (PABX) verwenden. Die Flashtaste „R“ unterbricht kurzzeitig Ihre Verbindung. Sie können die Flashzeit auf 100 ms oder 250 ms einstellen.

- |   |  |
|---|--|
|    | <b>1</b> Rufen Sie das Menü auf.                       |
|   | <b>2</b> Wählen Sie „Basis Einst.“ und bestätigen Sie. |
|   | <b>3</b> Wählen Sie „Flash“ und bestätigen Sie.        |



**4** Wählen Sie die kurze Flash-Zeit (100 ms) oder die längere Flash-Zeit (250 ms) und bestätigen Sie mit „Speich“.



**5** Kehren Sie in den Standby-Modus zurück.

## 7.5 PIN Nummer

Die PIN Nummer wird zum An- und Abmelden von Mobilteilen und einigen anderen Einstellungen benötigt. Die voreingestellte PIN Nummer lautet 0000.



**1** Rufen Sie das Menü auf.



**2** Wählen Sie „Basis Einst.“ und bestätigen Sie.



**3** Wählen Sie „PIN Nummer“ und bestätigen Sie.



**4** Geben Sie die alte PIN Nummer (voreingestellt 0000) ein und wählen Sie „Speich“.



**5** Geben Sie die neue PIN Nummer ein, wählen Sie „Speich“. Wiederholen Sie diesen Schritt.



**6** Kehren Sie in den Standby-Modus zurück.

## 8 Extras

### 8.1 Termin

Sie können 5 Termine oder Erinnerungen programmieren, denen Sie einen Namen geben und für die Sie einen Weckruf mit Datum und Uhrzeit einstellen können.



**1** Rufen Sie das Menü auf.



**2** Wählen Sie „Extras“ und bestätigen Sie.



**3** Wählen Sie „Termin“ und bestätigen Sie.



**4** Wählen Sie einen der 5 Termine und wählen Sie „Option“.

Um einen Termin zu bearbeiten:



**5** Wählen Sie „Bearbeiten“ und bestätigen Sie.



**6** Bearbeiten Sie den Namen des Termins und bestätigen Sie mit „Speich“.



**7** Geben Sie das Datum des Termins ein und bestätigen Sie mit „Speich“.



**8** Geben Sie die Uhrzeit ein und wählen Sie „Speich“.



**9** Wählen Sie die gewünschte Ruftonmelodie und wählen Sie „Speich“.



**10** Kehren Sie in den Standby-Modus zurück.

Um einen Termin zu löschen:



**5** Wählen Sie „Löschen“ und bestätigen Sie.



**6** Drücken Sie die rechte Menütaste zum Bestätigen.



**7** Drücken Sie die linke Menütaste zum Zurückgehen.



**8** Kehren Sie in den Standby-Modus zurück.













### 8.2 Stoppuhr



**1** Rufen Sie das Menü auf.



**2** Wählen Sie „Extras“ und bestätigen Sie.

- |  |  |  |
|--|--|--|
| <br><br><br><br><br> | <br><br><br><br><br> | <p><b>3</b> Wählen Sie „Stoppuhr“ und bestätigen Sie.</p> <p><b>4</b> Wählen Sie „Start“, um die Stoppuhr zu starten.</p> <p><b>5</b> Wählen Sie „Stopp“, um die Stoppuhr anzuhalten.<br/>Wählen Sie „Start“, um noch einmal zu beginnen.</p> <p>Wählen Sie „Reset“, um den Zeitzähler zurückzusetzen.</p> <p><b>6</b> Kehren Sie in den Standby-Modus zurück.</p> |
|--|--|--|

## 9 Zusätzliche Mobilteile und Basisstationen



Sie können bis zu 4 Mobilteile an der Basisstation anmelden. Jedes Mobilteil kann an bis zu 4 Basisstationen angemeldet werden und der Benutzer kann die jeweilige Basisstation wählen.

### 9.1 Ein neues Mobilteil hinzufügen

















*Diese Funktion brauchen Sie nur, wenn Sie ein Mobilteil abgemeldet haben oder ein neues gekauft haben.*

Um die Basisstation in den Anmeldemodus zu stellen:















- |  |  |
|--|--|
| <br> | <p><b>1</b> Drücken Sie die Taste Paging an der Basisstation.</p> <p>Die LED der Basisstation beginnt zu blinken (90 Sekunden lang). Während dieser Zeit ist die Basisstation bereit zum Anmelden.</p> |
|--|--|

Am Mobilteil:

- |   |  |  |
|---|--|--|
| <br><br><br><br><br><br> | <br><br><br><br><br><br><br> | <p><b>1</b> Rufen Sie das Menü auf.</p> <p><b>2</b> Wählen Sie „Mobilteil“ und bestätigen Sie.</p> <p><b>3</b> Wählen Sie „Anmelden“ und bestätigen Sie.</p> <p><b>4</b> Wählen Sie „MT anmelden“ und bestätigen Sie.</p> <p><b>5</b> Wählen Sie die Nummer der Basisstation, an dem Sie das Mobilteil anmelden möchten (1-4) und bestätigen Sie.</p> <p><b>6</b> Geben Sie die PIN Nummer (voreingestellt 0000) ein und bestätigen Sie.</p> <p><b>7</b> Kehren Sie in den Standby-Modus zurück.</p> |
|---|--|--|









### 9.2 Ein Mobilteil abmelden

Die folgenden Schritte müssen Sie an einem Mobilteil durchführen, das Sie nicht abmelden möchten.

- |   |   |  |
|---|---|--|
| <br><br><br><br><br><br> | <br><br><br><br><br><br> | <p><b>1</b> Rufen Sie das Menü auf.</p> <p><b>2</b> Wählen Sie „Mobilteil“ und bestätigen Sie.</p> <p><b>3</b> Wählen Sie „Anmelden“ und bestätigen Sie.</p> <p><b>4</b> Wählen Sie „MT abmelden“ und bestätigen Sie.</p> <p><b>5</b> Geben Sie die PIN Nummer (voreingestellt 0000) ein und bestätigen Sie.</p> <p><b>6</b> Geben Sie die Nummer des Mobilteils ein, das Sie abmelden möchten und bestätigen Sie.</p> <p><b>7</b> Kehren Sie in den Standby-Modus zurück.</p> |
|---|---|--|

### 9.3 Eine Basisstation auswählen

Sie können Ihr Mobilteil über verschiedene Basisstationen benutzen. Sie können auch die Basisstation mit dem stärksten Signal automatisch suchen lassen. Das Mobilteil muss zunächst an allen Basisstationen einzeln angemeldet werden.



- |   |  |  |
|---|--|--|
| <br><br><br><br><br> | <br><br><br><br> | <ol style="list-style-type: none"> <li><b>1</b> Rufen Sie das Menü auf.</li> <li><b>2</b> Wählen Sie „Mobilteil“ und bestätigen Sie.</li> <li><b>3</b> Wählen Sie „Basis ausw.“ und bestätigen Sie.</li> <li><b>4</b> Wählen Sie „Manuell“ oder „Automatisch“ und bestätigen Sie.</li> </ol> <p>Wenn Sie „Manuell“ ausgewählt haben:</p> <ol style="list-style-type: none"> <li><b>5</b> Wählen Sie die gewünschte Basisstation für Ihr Mobilteil und bestätigen Sie.</li> </ol> |
|---|--|--|



*Wenn Sie die Basisstation automatisch auswählen lassen und das Mobilteil außer Reichweite der derzeitigen Basisstation gelangt, sucht das Mobilteil nur nach der stärksten Basisstation im Standby-Modus (nicht während eines Gesprächs).*



### 9.4 Interner Anruf verwenden

#### Ein internes Mobilteil anrufen

- |  |  |
|--|--|
| <p>INT</p><br><br> | <ol style="list-style-type: none"> <li><b>1</b> Drücken Sie die Nach-links-Taste / INT.<br/>Im Display erscheint „Mobilteil_“.</li> <li><b>2</b> Geben Sie die interne Nummer des gewünschten Mobilteils ein.</li> <li><b>3</b> Drücken Sie die Auflegen-Taste oder stellen Sie das Mobilteil auf die Basisstation, um das Gespräch zu beenden.</li> </ol> |
|--|--|

#### Ein externes Gespräch an ein anderes Mobilteil weiterleiten.

Während eines externen Gesprächs:

- |  |  |
|--|--|
| <p>INT</p><br><br> | <ol style="list-style-type: none"> <li><b>1</b> Drücken Sie die Nach-links-Taste / INT.<br/>Im Display erscheint „Mobilteil_“.</li> <li><b>2</b> Geben Sie die interne Nummer des gewünschten Mobilteils ein.<br/>Ihr externer Gesprächspartner wird in die Warteschleife gesetzt.</li> <li><b>3</b> Wenn der interne Gesprächspartner antwortet, drücken Sie die Auflegen-Taste, um das Gespräch weiterzuleiten.</li> </ol> <p>ODER</p> |
| <p>INT</p><br>  | <ol style="list-style-type: none"> <li><b>3</b> Wenn der interne Gesprächspartner nicht antwortet, drücken Sie die Nach-links-Taste / INT, um den externen Gesprächspartner wieder zu übernehmen oder von einem zum anderen zu wechseln.</li> <li><b>4</b> Drücken Sie die Auflegen-Taste oder stellen Sie das Mobilteil auf die Basisstation, um das Gespräch zu beenden.</li> </ol>  |

## Konferenzschaltung

Sie können mit zwei Mobilteilen und einem externen Anrufer gleichzeitig sprechen.

Während eines externen Gesprächs:

INT





INT



**1** Drücken Sie die Nach-links-Taste / INT.

Im Display erscheint „Mobilteil\_“.

**2** Geben Sie die interne Nummer des gewünschten Mobilteils ein.

Ihr externer Gesprächspartner wird in die Warteschleife gesetzt.

**3** Wenn der interne Gesprächspartner antwortet, wählen Sie „Konf.“.

ODER

**3** Wenn der interne Gesprächspartner nicht antwortet, drücken Sie die Nach-links-Taste / INT, um den externen Gesprächspartner wieder zu übernehmen.

**4** Drücken Sie die Auflegen-Taste oder stellen Sie das Mobilteil auf die Basisstation, um das Gespräch zu beenden.

## Einen externen Anruf während eines internen Gesprächs annehmen

Wenn Sie ein internes Gespräch mit einem anderen Mobilteil führen, können Sie weiterhin externe Anrufe annehmen.

Um einen eingehenden Anruf anzunehmen:



**1** Drücken Sie die Auflegen-Taste. Das interne Gespräch wird unterbrochen.

**2** Drücken Sie die Taste Gespräch annehmen. Sie haben nun das externe Gespräch angenommen.

## 10 Problemlösung

Störung	Mögliche Ursache	Lösung
Kein Display	Batterien nicht geladen	Überprüfen Sie die Position der Batterien
		Batterien aufladen
	Mobilteil ist ausgeschaltet	Mobilteil einschalten
Kein Ton	Telefonkabel schlecht angeschlossen	Überprüfen Sie die Verbindung des Telefonkabels
	Die Leitung ist von einem anderen Mobilteil besetzt	Warten Sie, bis das andere Mobilteil aufgehängt wird
Das Symbol  blinkt	Mobilteil außer Reichweite	Gehen Sie mit dem Mobilteil dichter zur Basisstation
	Die Basisstation hat keine Stromzufuhr	Überprüfen Sie die Stromverbindung zur Basisstation
	Das Mobilteil ist nicht an der Basisstation angemeldet	Melden Sie das Mobilteil an der Basisstation an
Basisstation oder Mobilteil klingeln nicht	Die Ruftonlautstärke ist ausgeschaltet oder zu gering	Passen Sie die Ruftonlautstärke an
Es ist nicht möglich, einen Anruf auf PABX weiterzuleiten	Die Flashzeit ist zu kurz oder zu lang	Ändern Sie die Flashzeit
Telefon reagiert nicht auf Tastendrücke	Bedienfehler	Entfernen Sie die Batterien und legen Sie sie erneut ein

## 11 Technische Daten

Standard	<b>DECT (Digital Enhanced Cordless Telecommunications)</b> <b>GAP (Generic Access Profile)</b>
Frequenzbereich	1880 MHz bis 1900 MHz
Anzahl Kanäle	120 Duplexkanäle
Modulation	GFSK
Codiergeschwindigkeit	32 kbit/s
Emissionsleistung	10 mW (durchschnittliche Leistung pro Kanal)
Reichweite	300 m im freien Gelände / 50 m maximal im Gebäude
Anzahl Mobilteile	Bis zu 4
Stromzufuhr Basisstation	230V / 50 Hz / 6V DC 300mA
Mobilteil Batterien:	2 wiederaufladbare Batterien AAA, NiMh 1,2V, 700mA
Mobilteil Bereitschaft	110 Stunden im Standby-Modus
Mobilteil Sprechzeit	11 Stunden
Normale Gebrauchsbedingungen	+5 °C bis +45 °C
Wahlverfahren	Impuls / Ton
Flashzeit	100 oder 250 ms



## 12 Garantie

### 12.1 Garantiezeit

Topcom Geräte haben eine 24-monatige Garantiezeit. Die Garantiezeit beginnt an dem Tag, an dem das neue Gerät erworben wurde. Die Garantie für Batterien ist auf 6 Monate nach Erwerb begrenzt. Verschleißteile oder Mängel, die den Wert oder die Gebrauchstauglichkeit des Geräts nur unerheblich beeinflussen, sind von der Garantie ausgeschlossen.

Der Garantieanspruch muss durch den Originalkaufbeleg, auf dem das Kaufdatum und das Gerätemodell ersichtlich sind, nachgewiesen werden.

### 12.2 Abwicklung des Garantiefalls

Senden Sie das fehlerhafte Gerät mit dem gültigen Kaufbeleg an ein Topcom Service-Zentrum. Tritt ein Gerätefehler innerhalb der Garantiezeit auf, übernimmt Topcom oder ein autorisiertes Service-Zentrum unentgeltlich die Reparatur jedes durch einen Material- oder Herstellungsfehler aufgetretenen Defekts. Topcom wird nach eigenem Ermessen die Garantieansprüche mittels Reparatur oder Austausch des fehlerhaften Geräts oder von Teilen des fehlerhaften Geräts erfüllen. Bei einem Austausch können Farbe und Modell vom eigentlich erworbenen Gerät abweichen. Das ursprüngliche Kaufdatum bestimmt den Beginn der Garantiezeit. Die Garantiezeit verlängert sich nicht, wenn das Gerät von Topcom oder einem seiner autorisierten Service-Zentren ausgetauscht oder repariert wird.

### 12.3 Garantiausschlüsse

Schäden oder Mängel, die durch unsachgemäße Handhabung oder Betrieb verursacht werden sowie Defekte, die durch die Verwendung von Nicht-Originalteilen oder die Verwendung von nicht von Topcom empfohlenem Zubehör entstehen, werden nicht von der Garantie abgedeckt. Schnurlose Telefone von Topcom wurden so konstruiert, dass sie ausschließlich mit wiederaufladbaren Batterien funktionieren. Ein durch nicht-wiederaufladbare Batterien verursachter Schaden fällt nicht unter die Garantieleistung. Die Garantie deckt keine Schäden ab, die durch äußere Einflüsse entstanden sind, wie z. B. Blitzeinschlag, Wasser, Brände oder auch jegliche Transportschäden. Wenn die Seriennummer des Geräts verändert, entfernt oder unleserlich gemacht wurde, kann keine Garantie in Anspruch genommen werden.

Alle Garantieansprüche erlöschen, wenn das Gerät durch den Käufer oder durch unqualifizierte und nicht offiziell anerkannte Topcom Service-Zentren repariert, verändert oder umgebaut wurde.

## 13 Entsorgung des Geräts (Umweltschutz)



Am Ende der Lebensdauer des Produkts darf das Gerät nicht im normalen Hausmüll entsorgt werden. Bringen Sie es zu einer Sammelstelle zur Aufbereitung elektrischer und elektronischer Geräte. Das Symbol am Produkt, in der Bedienungsanleitung und/oder Verpackung zeigt dies an. Einige der Materialien des Produkts können wiederverwendet werden, wenn Sie das Gerät in einer Aufbereitungsstelle abgeben.

Mit der Wiederverwertung einiger Teile oder Rohmaterialien aus gebrauchten Produkten leisten Sie einen wichtigen Beitrag zum Umweltschutz. Wenden Sie sich bitte an Ihre örtlichen Behörden, wenn Sie weitere Informationen über Sammelstellen in Ihrer Umgebung benötigen.

## 14 Reinigung

Reinigen Sie das Telefon mit einem leicht feuchten Lappen oder mit einem anti-statischen Tuch. Verwenden Sie niemals Reinigungs- oder Scheuermittel.

## 15 ECO mode (Strahlungsarme Betriebsweise)

- Dieses schnurlose Telefon (nach DECT-Standard) ermöglicht einen strahlungsarmen Betrieb.
- Dabei wird die Strahlungsintensität der Funksignale zwischen Basisstation und Mobilteil auf ein Minimum reduziert, wenn sich das Mobilteil auf der Basisstation befindet.
- Erst wenn das Mobilteil von der Basisstation genommen wird oder ein Anruf eingeht, wird die Strahlungsintensität des Funksignals auf die normale Stärke angehoben.
- Das bedeutet nicht, dass die normale DECT-Funkstrahlung gesundheitsschädlich ist.
- Die Funktion des strahlungsarmen Betriebs vermeidet unnötige DECT-Strahlungsbelastung, wenn keine Kommunikation zwischen Basisstation und Mobilteil notwendig ist.
- Bei strahlungsarmer Betriebsweise können technisch bedingt keine zusätzlichen Mobilteile betrieben werden (ein weiteres Mobilteil, das sich nicht in unmittelbarer Nähe der Basisstation befindet, würde wegen des schwachen Funksignals ständig auf "Basissuche" sein).
- Im Auslieferungszustand ist die strahlungsarme Betriebsweise eingeschaltet.
- Wenn Sie ein weiteres Mobilteil anmelden, wird die strahlungsarme Betriebsweise automatisch ausgeschaltet.
- Die strahlungsarme Betriebsweise wird wieder automatisch eingeschaltet, wenn Sie alle zusätzlichen Mobilteile abmelden (es darf nur noch ein Mobilteil an der Basisstation angemeldet sein).
- Die Vorgehensweise zum Anmelden und Abmelden von Mobilteilen ist in der Bedienungsanleitung erklärt.

## Español

### 1 Instrucciones de seguridad

- Usar sólo el cargador suministrado. El uso de otros cargadores podría dañar las baterías.
- Insertar sólo baterías recargables del mismo tipo. No usar nunca baterías normales no recargables. Introducir las baterías recargables de manera que conecten con los polos correctos (indicados en el compartimiento de las baterías del teléfono).
- No tocar los contactos del cargador ni del enchufe con objetos afilados o metálicos.
- El funcionamiento de ciertos dispositivos médicos podría verse afectado.
- El teléfono puede causar un desagradable zumbido en audífonos.
- No poner la unidad base en una habitación húmeda o a una distancia de menos de 1,5 m de una fuente de agua. Mantener el teléfono lejos del agua.
- No usar el teléfono en ambientes donde haya riesgo de explosiones.
- Tirar las baterías y realizar el mantenimiento del teléfono de manera respetuosa con el medio ambiente.
- Como este teléfono no se puede utilizar en caso de corte del suministro eléctrico, para realizar llamadas de emergencia debería emplearse un teléfono independiente de la red eléctrica, como por ejemplo un teléfono móvil.

### 2 Introducción

#### 2.1 Cómo utilizar este manual del usuario

En este manual del usuario, se utiliza el siguiente método para aclarar las instrucciones:

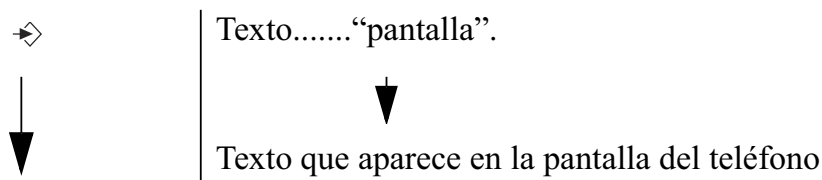

Tecla que debe pulsarse. Esta tecla puede ser una tecla configurable (Ver “2.4 Teclas/LED”). Cuando la tecla configurable es un símbolo, aparece en la columna de la izquierda. Cuando la tecla configurable es texto, la tecla de la izquierda o de la derecha aparece en la columna de la izquierda y el texto en la columna de la derecha entre comillas.

#### 2.2 Instalación de la base

Para la instalación, haga lo siguiente:

- 1** Conecte un extremo del adaptador a la toma y el otro a la conexión del adaptador de la parte trasera de la base.
- 2** Conecte un extremo del cable de teléfono a la toma telefónica de la pared y el otro extremo a la parte inferior de la base.
- 3** Coloque el teléfono y el cable de alimentación en las guías de la base, tal y como se muestra en la imagen 2A.

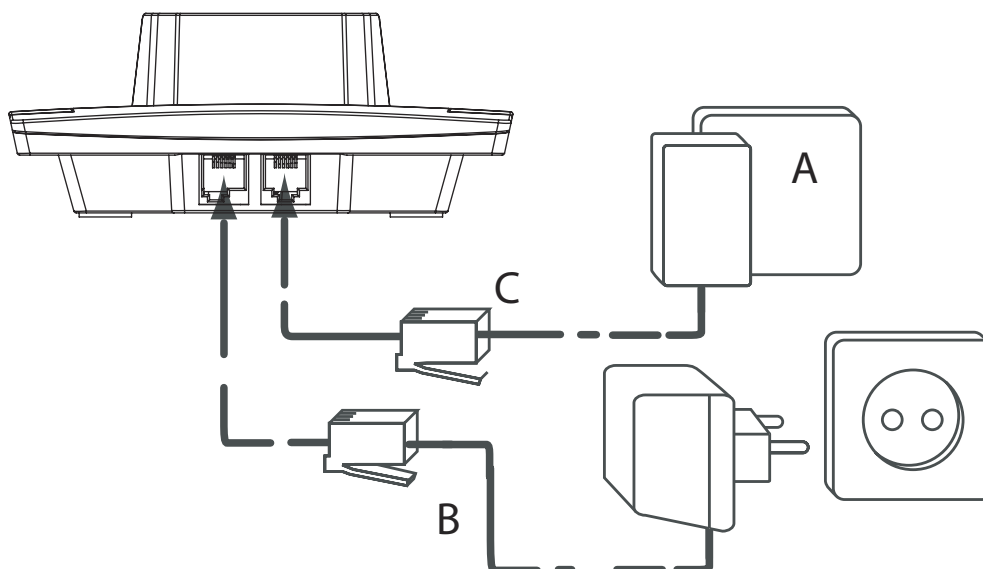

- 2A Vista posterior de la base -

A. Toma de teléfono

B. Cable de alimentación

C. Cable telefónico

### 2.3 Instalación del terminal

- 1 Abra el compartimento de las baterías tal y como se muestra en la imagen 2B.
- 2 Inserte las baterías respetando la polaridad (+ y -).
- 3 Cierre el compartimento de las baterías.
- 4 Deje el terminal en la unidad base durante 20 horas. El indicador de Línea/Carga  de la base se iluminará.

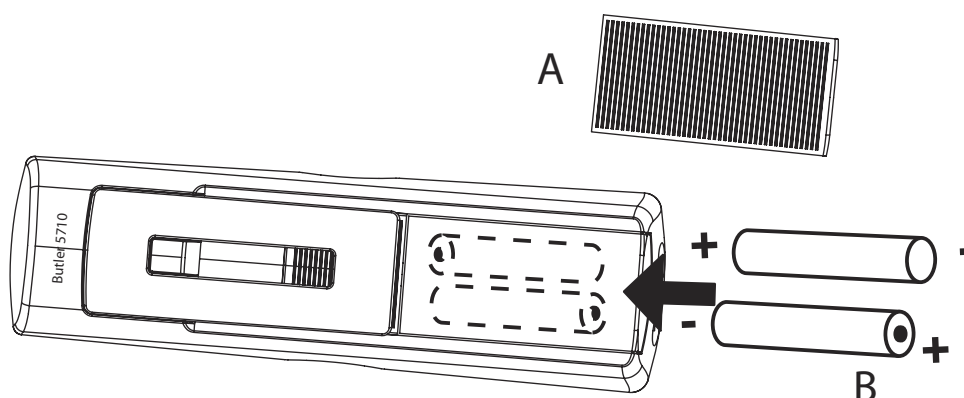

- 2B Vista posterior del terminal -

A. Tapa

B. Baterías recargables



Antes de utilizar el teléfono por primera vez, debe asegurarse de que las baterías han estado cargándose durante 20 horas. De lo contrario, el teléfono no funcionará correctamente.

## 2.4 Teclas/LED

### Terminal

1. Pantalla
2. Tecla Arriba / Rellamada
3. Tecla configurable de menú derecha
4. Tecla Derecha / Flash
5. Tecla Colgar / Apagado
6. Teclas alfanuméricas
7. Bloqueo del teclado
8. Tecla Timbre desactivado
9. Tecla Abajo / Registro de llamadas
10. Tecla Descolgar / Manos libres / Encendido
11. Tecla Izquierda / INT
12. Tecla OK
13. Tecla configurable de menú derecha

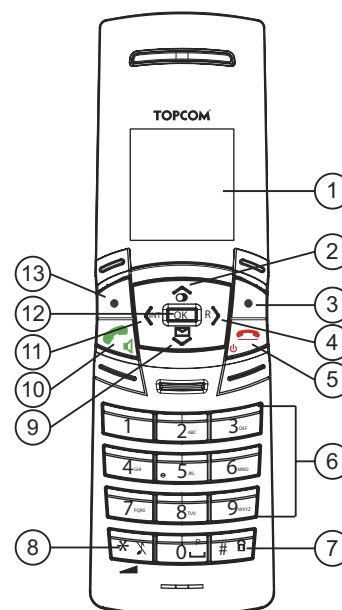

- 2C Terminal -

### Base

14. LED En uso / Alimentación / Terminal en la base
15. Tecla de búsqueda

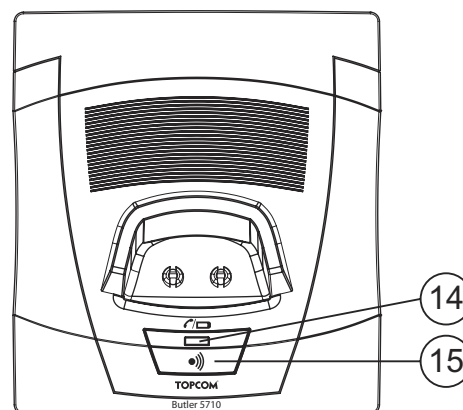

- 2D Base -

## 2.5 Símbolos

	Descolgar		Bloqueo del teclado
	Colgar		Alarma activada
	Llamadas perdidas en la lista de llamadas*		Terminal no registrado o fuera de alcance
	Volumen del timbre del terminal desactivado		Batería agotada
	Terminal dentro del alcance de la base		Nivel de carga de la batería bajo
	Llamada interna		Nivel de carga de la batería medio
	Manos libres		Carga completa
	Nuevo mensaje de voz		

\* Si en la línea telefónica está disponible el servicio de identificación de llamadas.

## 2.6 Teclas de pantalla

Las teclas de pantalla (teclas configurables) están situadas directamente debajo de la pantalla. La función de estas dos teclas cambia dependiendo del modo de funcionamiento. La función real se muestra en forma de icono o texto directamente encima de las dos teclas de pantalla.

	Agenda		Mute
	OK / Confirmar		Atrás
	Menú		Sin tecla
	Borrar		





## 2.7 LED Base

El LED (14) indica el siguiente estado:

- Apagado: la base no está conectada a la alimentación o el terminal no está en la base para recargarse
- Encendido: terminal cargándose
- Parpadeo lento: terminal descolgado o durante el timbre de llamada
- Parpadeo rápido: durante el registro

## 2.8 Navegación por el menú

El teléfono Butler 5710 cuenta con un sistema de menús muy fácil de usar. Cada uno de los menús lleva a una lista de opciones. El mapa de menús se muestra a continuación.

- |   |  |
|---|--|
|  | <b>1</b> Cuando el terminal esté encendido y en modo en espera, pulse la tecla de menú izquierda  para abrir el menú principal. |
|  | <b>2</b> Desplácese hasta la opción de menú deseada.   |
|  | <b>3</b> Pulse la tecla de menú para ver más opciones o para confirmar el ajuste mostrado.   |

### Para salir o para subir un nivel en el menú



Para ir al nivel anterior del menú, pulse la tecla de menú.

Para cancelar y volver al modo en espera en cualquier momento, pulse la tecla Colgar.

## 2.9 Vista general de los menús

Menú	Opciones del submenú
Terminal	Timbre Volumen del timbre Nombre term. Tono tecla Contraste Descuelgue aut. Prefijo Selec. base Idioma Registro
Configurar la base	Timbre Volumen del timbre Marcación Tecla R PIN del sistema
Alarma/Reloj	Config alarma Fecha&Hora Formato hora
Herramientas	Cita Cronómetro
Apagar	

## 3 Uso del teléfono

### 3.1 ACTIVAR/DESACTIVAR el terminal



- 1 Mantenga pulsada la tecla DESACTIVAR para apagar el terminal.
- 2 Pulse la tecla Descolgar o coloque el terminal en la base para encender de nuevo el terminal.

### 3.2 Cambiar el idioma de los menús



- 1 Acceda al menú.
- 2 Seleccione "Terminal" y confirme la selección.
- 3 Seleccione "Idioma" y confirme la selección.
- 4 Seleccione un idioma y confirme la selección.  
La pantalla mostrará "Guardado".
- 5 Pulse la tecla Colgar para regresar al modo en espera.



Las flechas ⇄ indican que hay más opciones disponibles.

### 3.3 Realizar una llamada telefónica normal

#### Marcación directa



- 1** Pulse la tecla Descolgar para iniciar la llamada.
- 2** Marque el número de teléfono.
- 3** Pulse la tecla Colgar para finalizar la llamada o coloque el terminal otra vez en la base.

#### Premarcación

Con esta función podrá introducir y modificar un número antes de realizar la llamada.



- 1** Marque un número de hasta 24 dígitos.  
Mantenga pulsada la tecla 0 para insertar una pausa. La pantalla mostrará una "P".
- 2** Pulse la tecla de menú para corregir el nombre introducido.
- 3** Pulse la tecla Descolgar para iniciar la llamada.
- 4** Pulse la tecla Colgar para finalizar la llamada o coloque el terminal otra vez en la base.

#### Volver a marcar un número de la lista

Puede volver a marcar como máximo los 10 últimos números a los que haya llamado. Si ha guardado un nombre en la agenda junto con el número, aparecerá el nombre en lugar del número.



- 1** Pulse la tecla Rellamada.
- 2** Seleccione un número. Si el número está en la agenda, aparecerá el nombre.
- 3** Pulse la tecla Descolgar para iniciar la llamada o seleccione "Opción".
- 4** Si selecciona "Opción", desplace la lista y seleccione:  
"Borrar llamad" para eliminar el número de la lista de llamadas;  
"Guardar num" para guardar el número en la agenda;  
"Borrar todo" para borrar la lista de llamadas.
- 5** Confirme la selección.
- 6** Pulse la tecla Colgar para regresar al modo en espera.

### 3.4 Recibir una llamada de teléfono

Cuando reciba una llamada externa, en la pantalla aparecerá "Llam. externa".

Para contestar a la llamada:



- 1** Pulse la tecla Descolgar.  
O  
Retire el terminal de la base (si "Descuelgue aut." está activado (Ver "6.5 Descolgar automáticamente"))  
El icono de llamada en curso  aparecerá en la pantalla. La duración de la llamada se mostrará pasados 15 segundos.
- 2** Pulse la tecla Colgar para finalizar la llamada o coloque el terminal otra vez en la base.



*Puede desactivar el volumen del timbre durante una llamada entrante seleccionando "Silenc".*



### 3.5 Modo manos libres

El modo manos libres le permite hablar con su interlocutor sin sujetar el terminal. También permite a otras personas de la habitación escuchar a ambas partes de la conversación.



- 1 Para pasar cualquier llamada al modo manos libres, pulse la tecla Manos libres durante la llamada.

### 3.6 Ajustar el volumen del auricular/manos libres



- 1 Pulse Arriba o Abajo para seleccionar el volumen (1-5) durante una llamada normal o manos libres.

### 3.7 Función Secreto (función Mute)

Para desactivar el micrófono de manera que su interlocutor no pueda oírle.



- 1 Durante una conversación, pulse la tecla de menú para desactivar el micrófono.

En la pantalla aparecerá “Mute act.”.



- 2 Para volver a activar el micrófono, seleccione “Desac.”.

### 3.8 Localizar un terminal (función de búsqueda)



- 1 Pulse la tecla de búsqueda de la unidad base.

Todos los terminales registrados con esa base sonarán durante 30 segundos.



- 2 Pulse cualquier tecla del terminal para detener la búsqueda.

### 3.9 Bloqueo del teclado

El teclado se bloquea para evitar marcar accidentalmente un número mientras lleva consigo el terminal.

En modo en espera:



- 1 Mantenga pulsada tecla de bloqueo del teclado (tecla 7 - Imagen 2C) hasta que en la pantalla aparezca “Bloqueado” y el icono  de bloqueo del teclado.



- 2 Para desbloquear las teclas, seleccione “Desblo”, seguido de la tecla de bloqueo del teclado.

### 3.10 Usar las teclas alfanuméricas

Con su teléfono, también puede introducir caracteres alfanuméricos. Esto resulta útil a la hora de introducir un nombre en la agenda, dar un nombre al terminal, etc.





Para seleccionar una letra, pulse la tecla correspondiente las veces que sea necesario.

Por ejemplo, para seleccionar la “A”, pulse “2” una vez. Para seleccionar “B” pulse “2” dos veces, y así sucesivamente.

Para seleccionar “A” y “B” consecutivamente pulse “2” una vez, espere a que el cursor se desplace al siguiente carácter y pulse “2” dos veces.

Durante la introducción de texto, el carácter disponible debajo de cada tecla aparece en la parte inferior de la pantalla.











Puede cambiar el conjunto de caracteres de entrada de inglés (abc) a latino (aàá), griego (ΑΒΓ) o ruso (АБВ) manteniendo pulsada la tecla # durante dos segundos.

   	<p>Para seleccionar un espacio pulse “0”.</p> <p>Pulse la tecla * para cambiar entre minúsculas y mayúsculas.</p> <p>Mantenga pulsada la tecla # durante 2 segundos para cambiar el conjunto de caracteres de entrada.</p> <p>Pulse la tecla de menú para corregir el nombre introducido.</p>
--	---





## 4 Agenda

Cada terminal puede almacenar hasta 200 nombres y números. Los nombres pueden tener un máximo de 16 caracteres y los números pueden contener hasta 24 dígitos.







### 4.1 Para añadir una entrada

           	<ol style="list-style-type: none"> <li><b>1</b> Pulse la tecla de menú. Si la agenda está vacía, en la pantalla aparecerá “Agenda vacía”. Si hay nombres guardados, se mostrarán.</li> <li><b>2</b> Seleccione “Opción”.</li> <li><b>3</b> Seleccione “Nueva entrada” y confirme la selección.</li> <li><b>4</b> Utilice el teclado para escribir el nombre y seleccione “Guarda”.</li> <li><b>5</b> Utilice el teclado para escribir el número y seleccione “Guarda”.</li> <li><b>6</b> Seleccione la melodía deseada y seleccione “Guarda”.</li> <li><b>7</b> Regrese al modo en espera.</li> </ol>
---	---











### 4.2 Para marcar una entrada

    	<ol style="list-style-type: none"> <li><b>1</b> Pulse la tecla de menú.</li> <li><b>2</b> Seleccione el nombre deseado o utilice el teclado para introducir la primera letra del nombre.</li> <li><b>3</b> Pulse la tecla Descolgar para iniciar la llamada.</li> <li><b>4</b> Regrese al modo en espera.</li> </ol>
--	--











### 4.3 Ver detalles

       	<ol style="list-style-type: none"> <li><b>1</b> Pulse la tecla de menú.</li> <li><b>2</b> Seleccione el nombre deseado o utilice el teclado para introducir la primera letra del nombre.</li> <li><b>3</b> Seleccione “Opción”.</li> <li><b>4</b> Seleccione “Ver detalles” y confirme la selección. El nombre, el número y la melodía asignada a esa entrada aparecerán en la pantalla.</li> <li><b>5</b> Regrese al modo en espera.</li> </ol>
---	--









#### 4.4 Eliminar una entrada o todas las entradas

- |   |   |
|---|---|
| <br><br><br> <br> <br> <br> | <p><b>1</b> Pulse la tecla de menú.</p> <p><b>2</b> Seleccione el nombre deseado o utilice el teclado para introducir la primera letra del nombre.</p> <p><b>3</b> Seleccione “Opción”.</p> <p>Para eliminar una entrada:</p> <p><b>4</b> Seleccione “Borrar entra” y confirme la selección.</p> <p>Para eliminar todas las entradas:</p> <p><b>4</b> Seleccione “Borrar todo” y confirme la selección.</p> <p><b>5</b> Pulse la tecla de menú izquierda para cancelar la operación o la derecha para confirmarla.</p> <p><b>6</b> Regrese al modo en espera.</p> |
|---|---|

#### 4.5 Editar un nombre y un número

- |   |  |
|---|--|
| <br><br><br> <br><br><br><br> <br> | <p><b>1</b> Pulse la tecla de menú.</p> <p><b>2</b> Seleccione el nombre deseado o utilice el teclado para introducir la primera letra del nombre.</p> <p><b>3</b> Seleccione “Opción”.</p> <p><b>4</b> Seleccione “Editar” y confirme la selección.</p> <p><b>5</b> Pulse la tecla de menú para borrar y use el teclado para cambiar el nombre.</p> <p><b>6</b> Seleccione “Guarda”.</p> <p><b>7</b> Edite el número y seleccione “Guarda”.</p> <p><b>8</b> Seleccione la melodía deseada y seleccione “Guarda”.</p> <p><b>9</b> Regrese al modo en espera.</p> |
|---|--|

#### 4.6 Copiar una entrada de la agenda en otro terminal

- |  |   |
|--|---|
| <br><br><br> <br> <br> | <p><b>1</b> Pulse la tecla de menú.</p> <p><b>2</b> Seleccione el nombre deseado o utilice el teclado para introducir la primera letra del nombre.</p> <p><b>3</b> Seleccione “Opción”.</p> <p><b>4</b> Seleccione “Copiar” y confirme la selección.</p> <p>Se mostrarán los terminales disponibles (todos los terminales registrados en la base).</p> <p><b>5</b> Seleccione el terminal deseado y confirme la selección.</p> <p>En la pantalla aparecerá “Copiando a term x ...”.</p> <p>En la pantalla del terminal de destino aparecerá “¿Recibir registro de agenda?”.</p> <p><b>6</b> En el terminal de destino, pulse la tecla de menú derecha para confirmar la operación o la izquierda para cancelar la transferencia.</p> <p><b>7</b> Regrese al modo en espera.</p> |
|--|---|

## 4.7 Copiar todas las entradas de la agenda en otro terminal



*Al copiar todas las entradas de un terminal a otro, borrará los registros existentes en el terminal de destino.*



- 1** Pulse la tecla de menú.
- 2** Seleccione el nombre deseado o utilice el teclado para introducir la primera letra del nombre.
- 3** Seleccione “Opción”.
- 4** Seleccione “Copiar todo” y confirme la selección.  
Se mostrarán los terminales disponibles (todos los terminales registrados en la base).
- 5** Seleccione el terminal deseado y confirme la selección.  
En la pantalla aparecerá “Copiando a term x ...”.  
En la pantalla del terminal de destino aparecerá “¿Reemplazar todos los registros?”.
- 6** En el terminal de destino, pulse la tecla de menú derecha para confirmar la operación o la izquierda para cancelar la transferencia.
- 7** Regrese al modo en espera.

## 5 Identificación de llamadas

### 5.1 Llamadas RTPC entrantes normales



*Este servicio sólo funciona cuando ha contratado el servicio de identificación de llamadas. Para ello, póngase en contacto con su compañía telefónica.*

Cuando reciba una llamada desde su línea de teléfono fija, el número de teléfono de la llamada entrante aparecerá en la pantalla del terminal. El teléfono puede recibir llamadas tanto en FSK como en DTMF. También puede ver el nombre de la persona que le llama si la red lo transmite. Si el nombre está programado en la agenda, aparecerá el nombre que figura en ella. El teléfono puede guardar 30 llamadas en una lista de llamadas (recibidas y perdidas) que puede revisar más tarde. Cuando la memoria está llena, las llamadas nuevas sustituyen automáticamente a las antiguas en la memoria.



















Las llamadas perdidas quedan señalizadas mediante un icono parpadeante en la pantalla. El nombre del terminal se sustituye por este icono y por la cantidad de llamadas perdidas.

#### Para leer las llamadas recibidas



- 1** Pulse el botón Abajo.  
La lista de llamadas recibidas aparecerá en la pantalla. Se trata de una combinación de llamadas recibidas y perdidas.
- 2** Seleccione el nombre o número deseado.











- |   |  |
|---|--|
|    | <b>3</b> Pulse la tecla Descolgar para iniciar la llamada.                 |
|    | O<br>Seleccione “Opción”.  |
|   | Para eliminar una entrada:   |
|    | <b>4</b> Seleccione “Borrar llamad” y confirme la selección.               |
|    | <b>5</b> Regrese al modo en espera.  |
|   | Para eliminar todas las entradas:  |
|    | <b>5</b> Seleccione “Borrar todo” y confirme la selección.                 |
|    | <b>6</b> Regrese al modo en espera.  |
|   | Para añadir el número a la agenda:   |
|    | <b>5</b> Seleccione “Guardar num” y confirme la selección.                 |
|    | <b>6</b> Utilice el teclado para escribir el nombre y seleccione “Guarda”. |
|   | <b>7</b> Utilice el teclado para editar el número y seleccione “Guarda”.   |
|    | <b>8</b> Seleccione la melodía deseada y seleccione “Guarda”.              |
|   | <b>9</b> Regrese al modo en espera.  |

## 6 Personalizar el terminal

### 6.1 Timbre y volumen









#### Timbre

Puede seleccionar entre 18 melodías diferentes para las llamadas internas y externas.

- |   |  |
|---|--|
|    | <b>1</b> Acceda al menú.   |
|   | <b>2</b> Seleccione “Terminal” y confirme la selección.  |
|   | <b>3</b> Seleccione “Timbre” y confirme la selección.  |
|   | <b>4</b> Seleccione “Externa” para las llamadas externas o “Interna” para las llamadas internas y confirme la selección. |
|   | <b>5</b> Seleccione la melodía deseada y confirme la selección.  |
|   | Durante el desplazamiento se reproducirá una melodía.  |
|    | <b>6</b> Regrese al modo en espera.  |









#### Volumen del timbre

Puede seleccionar entre 5 volúmenes de timbre diferentes del terminal además de la opción de volumen desactivado.









- |   |   |
|---|---|
|    | <b>1</b> Acceda al menú.                                  |
|   | <b>2</b> Seleccione “Terminal” y confirme la selección.   |
|   | <b>3</b> Seleccione “Vol timbre” y confirme la selección. |
|   | Se mostrará el ajuste actual.                             |
|    | <b>4</b> Pulse la tecla Arriba para subir el volumen.     |
|    | <b>5</b> Pulse la tecla Abajo para disminuir el volumen.  |
|    | <b>6</b> Seleccione “Guarda” para confirmar.              |
|    | <b>7</b> Regrese al modo en espera.                       |

## 6.2 Nombre del terminal









Puede cambiar el nombre que se muestra en la pantalla del terminal cuando se encuentra en modo en espera (máx. 9 caracteres).

- |   |  |
|---|--|
|    | <b>1</b> Acceda al menú.   |
|   | <b>2</b> Seleccione "Terminal" y confirme la selección.              |
|   | <b>3</b> Seleccione "Nombre term." y confirme la selección.          |
|    | <b>4</b> Escriba el nombre que desee.                                |
|    | <b>5</b> Pulse la tecla de menú para corregir el nombre introducido. |
|    | <b>6</b> Seleccione "Guarda" para confirmar.                         |
|    | <b>7</b> Regrese al modo en espera.                                  |

## 6.3 Tono de pulsación de teclas









- |   |   |
|---|---|
|    | <b>1</b> Acceda al menú.  |
|   | <b>2</b> Seleccione "Terminal" y confirme la selección.                 |
|   | <b>3</b> Seleccione "Tono tecla" y confirme la selección.               |
|   | <b>4</b> Seleccione "Activado" o "Desactivado" y confirme la selección. |
|    | <b>5</b> Regrese al modo en espera.                                     |

## 6.4 Ajustar el contraste

- |   |   |
|---|---|
|    | <b>1</b> Acceda al menú.  |
|   | <b>2</b> Seleccione "Terminal" y confirme la selección.                   |
|   | <b>3</b> Seleccione "Contraste" y confirme la selección.                  |
|   | <b>4</b> Seleccione el contraste que desee (1-8) y confirme la selección. |
|    | <b>5</b> Regrese al modo en espera.                                       |





## 6.5 Descolgar automáticamente









Cuando hay una llamada entrante y el terminal se encuentra en la base, el teléfono se conecta a la línea de forma automática cuando se separa de la base. Esta función puede activarse o desactivarse.

- |   |   |
|---|---|
|    | <b>1</b> Acceda al menú.  |
|   | <b>2</b> Seleccione "Terminal" y confirme la selección.                 |
|   | <b>3</b> Seleccione "Descuelgue aut." y confirme la selección.          |
|   | <b>4</b> Seleccione "Activado" o "Desactivado" y confirme la selección. |
|    | <b>5</b> Regrese al modo en espera.                                     |

## 6.6 Código de prefijo

Es posible utilizar el teléfono con un número de prefijo. Al marcar los números de teléfono, puede añadir de forma automática el código de prefijo antes del número.















- |   |   |
|---|---|
|    | <b>1</b> Acceda al menú.                                |
|   | <b>2</b> Seleccione "Terminal" y confirme la selección. |
|   | <b>3</b> Seleccione "Prefijo" y confirme la selección.  |

- |   |   |   |
|---|---|---|
|  |  | <b>4</b> Seleccione “Editar” y confirme la selección.                   |
|  |  | <b>5</b> Escriba el prefijo, por ejemplo “0” y seleccione “Guarda”.     |
|   |   | <b>0</b>  |
|  |  | <b>4</b> Seleccione “Activado/Desactivado” y confirme la selección.     |
|  |  | <b>5</b> Seleccione “Activado” o “Desactivado” y confirme la selección. |
|  |   | <b>6</b> Regrese al modo en espera.                                     |









## 6.7 Usar la función de alarma

Puede tener un ajuste de alarma diferente para cada terminal registrado en la base. La alarma suena únicamente en el terminal, no en la base ni en ningún otro terminal.









### Ajustar la alarma

- |   |   |   |
|---|---|---|
|    |   | <b>1</b> Acceda al menú.  |
|    |    | <b>2</b> Seleccione “Alarma/Reloj” y confirme la selección.   |
|    |    | <b>3</b> Seleccione “Config alarma” y confirme la selección.  |
|    |    | <b>4</b> Seleccione “Una vez”, “Diario”, “Lun a Vie” o “Desactivado” y confirme la selección.<br>Si ha seleccionado “Una vez”, “Diario” o “Lun a Vie”, la pantalla mostrará la siguiente información:<br>Hora (24H):<br>00:00 |
|  |  | <b>5</b> Escriba la hora a la que desea que suene el teléfono y confirme la selección con “Guarda”.   |
|  |  | <b>6</b> Seleccione la melodía deseada y confirme la selección con “Guarda”.  |
|  |  | <b>7</b> Para desactivar la alarma, seleccione “Desactivada” y confirme la selección.   |
|  |   | <b>8</b> Regrese al menú anterior.  |

## 6.8 Ajustar la fecha y la hora

- |   |   |   |
|---|---|---|
|  |   | <b>1</b> Acceda al menú.  |
|  |  | <b>2</b> Seleccione “Alarma/Reloj” y confirme la selección.   |
|  |  | <b>3</b> Seleccione “Fecha&Hora” y confirme la selección.   |
|  |  | <b>4</b> Introduzca el año, el mes, el día, la hora y los minutos y seleccione “Guarda” para confirmar los datos. |
|  |   | <b>5</b> Regrese al menú anterior.  |









## 6.9 Ajustar el formato de hora

- |   |   |   |
|---|---|---|
|  |   | <b>1</b> Acceda al menú.                                    |
|  |  | <b>2</b> Seleccione “Alarma/Reloj” y confirme la selección. |
|  |  | <b>3</b> Seleccione “Formato hora” y confirme la selección. |
|  |  | <b>4</b> Seleccione “12H” o “24H” y confirme la selección.  |
|  |   | <b>5</b> Regrese al menú anterior.                          |

## 7 Configurar la base









### 7.1 Timbre

Puede elegir entre 9 melodías diferentes.

- |   |   |
|---|---|
|    | <b>1</b> Acceda al menú.  |
|   | <b>2</b> Seleccione “Config base” y confirme la selección.      |
|   | <b>3</b> Seleccione “Timbre” y confirme la selección.           |
|   | <b>4</b> Seleccione la melodía deseada y confirme la selección. |
|   | Durante el desplazamiento se reproducirá una muestra.           |
|    | <b>5</b> Regrese al modo en espera.                             |

### 7.2 Volumen del timbre

Puede seleccionar entre 5 niveles de volumen de timbre para la base.









- |   |  |
|---|--|
|    | <b>1</b> Acceda al menú.                                   |
|   | <b>2</b> Seleccione “Config base” y confirme la selección. |
|   | <b>3</b> Seleccione “Vol timbre” y confirme la selección.  |
|   | Se mostrará el ajuste actual.                              |
|    | <b>4</b> Pulse la tecla Arriba para subir el volumen.      |
|    | <b>5</b> Pulse la tecla Abajo para disminuir el volumen.   |
|    | <b>6</b> Seleccione “Guarda” para confirmar.               |
|    | <b>7</b> Regrese al modo en espera.                        |

### 7.3 Marcación

Hay dos tipos de modos de marcación:





- DTMF/Marcación por tonos (la más empleada)
- Marcación por pulsos (en instalaciones antiguas)

Para cambiar el modo de marcación:

- |   |   |
|---|---|
|    | <b>1</b> Acceda al menú.  |
|   | <b>2</b> Seleccione “Config base” y confirme la selección.      |
|   | <b>3</b> Seleccione “Marcación” y confirme la selección.        |
|   | <b>4</b> Seleccione “Tonos” o “Pulsos” y haga clic en “Guarda”. |
|    | <b>5</b> Regrese al modo en espera.                             |

### 7.4 Rellamada (Flash)

Pulse la tecla Flash “R” (tecla 4 - Imagen 2C) para utilizar determinados servicios de su línea externa como “llamada en espera” (si su compañía telefónica ofrece esta opción); o para transferir llamadas si utiliza una centralita telefónica (PABX). La tecla Flash “R” es una breve interrupción de la línea. Puede ajustar el tiempo flash a 100 o 250 ms.

- |   |  |
|---|--|
|    | <b>1</b> Acceda al menú.                                   |
|   | <b>2</b> Seleccione “Config base” y confirme la selección. |
|   | <b>3</b> Seleccione “Tecla R” y confirme la selección.     |



- 
- 4** Seleccione un tiempo flash corto (100 ms) o un tiempo flash largo (250 ms) y seleccione “Guarda”.
  - 5** Regrese al modo en espera.

## 7.5 PIN del sistema

El PIN del sistema se utiliza para registrar y dar de baja terminales, y para otros ajustes opcionales. El PIN predeterminado del sistema es 0000.

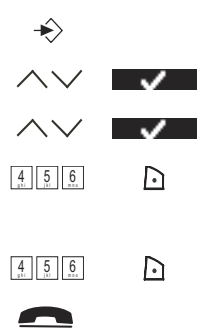
- 
- 1** Acceda al menú.
  - 2** Seleccione “Config base” y confirme la selección.
  - 3** Seleccione “PIN sistema” y confirme la selección.
  - 4** Introduzca el PIN antiguo (0000 de forma predeterminada) y seleccione “Guarda”.
  - 5** Escriba el nuevo PIN, seleccione “Guarda” y repita este paso.
  - 6** Regrese al modo en espera.

## 8 Herramientas



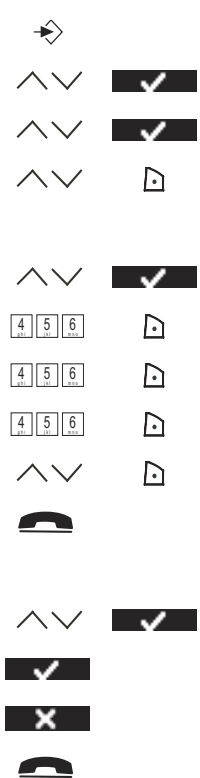

### 8.1 Cita

Puede configurar 5 citas o recordatorios que pueden ofrecer un nombre y una alarma por fecha y hora.

- 
- 1** Acceda al menú.
  - 2** Seleccione “Herramientas” y confirme la selección.
  - 3** Seleccione “Citas” y confirme la selección.
  - 4** Seleccione una de las 5 citas y seleccione “Opción”.
- Para editar la cita:
- 5** Seleccione “Editar” y confirme la selección.
  - 6** Edite el nombre de la cita y seleccione “Guarda”.
  - 7** Edite la fecha de la cita y seleccione “Guarda”.
  - 8** Edite la hora y seleccione “Guarda”.
  - 9** Seleccione la melodía de alarma deseada y seleccione “Guarda”.
  - 10** Regrese al modo en espera.
- Para eliminar la cita:
- 5** Seleccione “Borrar” y confirme la selección.
  - 6** Pulse la tecla de menú derecha para confirmar la operación.
  - 7** Pulse la tecla de menú izquierda para volver atrás.
  - 8** Regrese al modo en espera.

### 8.2 Cronómetro

- 
- 1** Acceda al menú.
  - 2** Seleccione “Herramientas” y confirme la selección.
  - 3** Seleccione “Cronómetro” y confirme la selección.

- |   |  |
|---|--|
|  | <b>4</b> Seleccione “Comenz” para poner en marcha el cronómetro. |
|  | <b>5</b> Seleccione “Parar” para detener el cronómetro.          |
|  | Seleccione de nuevo “Comenz” para reiniciar el cronómetro.       |
|  | Seleccione “Reinic” para reiniciar el contador.                  |
|  | <b>6</b> Regrese al modo en espera.                              |

## 9 Terminales y bases adicionales



Pueden vincularse a una base hasta 4 terminales. Cada terminal puede registrarse en un máximo de 4 bases y el usuario puede seleccionar la base que desee utilizar.

### 9.1 Añadir un nuevo terminal









*Sólo se necesita cuando haya dado de baja un terminal o cuando haya comprado uno nuevo.*

Para colocar la base en modo de registro:







- |   |   |
|---|---|
|  | <b>1</b> Mantenga pulsada la tecla de búsqueda de la base.  |
|  | El indicador LED de la base comenzará a parpadear durante 90 segundos. Durante este tiempo, la base está lista para realizar el registro. |

En el terminal:

- |   |   |
|---|---|
|  | <b>1</b> Acceda al menú.  |
|  | <b>2</b> Seleccione “Terminal” y confirme la selección.   |
|  | <b>3</b> Seleccione “Registro” y confirme la selección.   |
|  | <b>4</b> Seleccione “Registrar” y confirme la selección.  |
|  | <b>5</b> Seleccione el número de la base que desee asociar al terminal (1-4) y confirme la selección. |
|  | <b>6</b> Introduzca el PIN del sistema (0000 de forma predeterminada) y confírmelo.                   |
|  | <b>7</b> Regrese al modo en espera.   |









### 9.2 Eliminar un terminal

Este procedimiento debe llevarse a cabo desde un terminal diferente al que desea eliminar.

- |   |   |
|---|---|
|  | <b>1</b> Acceda al menú.  |
|  | <b>2</b> Seleccione “Terminal” y confirme la selección.                             |
|  | <b>3</b> Seleccione “Registro” y confirme la selección.                             |
|  | <b>4</b> Seleccione “Dar de baja” y confirme la selección.                          |
|  | <b>5</b> Introduzca el PIN del sistema (0000 de forma predeterminada) y confírmelo. |
|  | <b>6</b> Introduzca el número del terminal que necesite eliminar y confírmelo.      |
|  | <b>7</b> Regrese al modo en espera.   |

### 9.3 Seleccionar una base

Puede intercambiar su terminal entre diferentes bases. También puede configurarlo para que seleccione automáticamente la base que transmita la señal más potente. El terminal debe registrarse primero en cada una de las bases.





- |   |   |  |
|---|---|--|
| <br><br><br><br><br> | <br><br> | <ol style="list-style-type: none"> <li><b>1</b> Acceda al menú.</li> <li><b>2</b> Seleccione “Terminal” y confirme la selección.</li> <li><b>3</b> Seleccione “Selec. base” y confirme la selección.</li> <li><b>4</b> Seleccione “Manual” o “Auto” y confirme la selección.<br/>Si ha seleccionado “Manual”:</li> <li><b>5</b> Seleccione la base que desee asociar al terminal y confirme la selección.</li> </ol> |
|---|---|--|



*Cuando haya activado la selección automática de la base y el terminal esté fuera del alcance de la base actual, el terminal sólo buscará la base con la señal más potente en modo en espera (no durante la comunicación).*







### 9.4 Usar la función de intercomunicación

#### Llamar a un terminal interno

- |   |   |   |
|---|---|---|
| INT<br><br><br> | <br><br> | <ol style="list-style-type: none"> <li><b>1</b> Pulse la tecla Izquierda/INT.<br/>La pantalla mostrará “Terminal _”.</li> <li><b>2</b> Introduzca el número interno del terminal al que desee llamar.</li> <li><b>3</b> Pulse la tecla Colgar para finalizar la llamada o coloque el terminal otra vez en la base.</li> </ol> |
|---|---|---|

#### Transferir una llamada externa a otro terminal

Durante una llamada externa:

- |   |   |   |
|---|---|---|
| INT<br><br><br> | <br><br><br><br><br> | <ol style="list-style-type: none"> <li><b>1</b> Pulse la tecla Izquierda/INT.<br/>La pantalla mostrará “Terminal _”.</li> <li><b>2</b> Introduzca el número interno del terminal al que desee llamar.<br/>Se pondrá a su interlocutor externo en espera.</li> <li><b>3</b> Cuando el interlocutor interno conteste, pulse la tecla Colgar para transferir la llamada.</li> <li><b>0</b></li> <li><b>3</b> Si el interlocutor interno no contesta, pulse la tecla Izquierda/INT para recuperar al interlocutor externo o para ir de uno al otro.</li> <li><b>4</b> Pulse la tecla Colgar para finalizar la llamada o coloque el terminal otra vez en la base.</li> </ol> |
|---|---|---|

#### Conferencia

Puede hablar entre dos terminales y una línea externa al mismo tiempo.

Durante una llamada externa:

- |     |   |   |
|-----|---|---|
| INT |  | <ol style="list-style-type: none"> <li><b>1</b> Pulse la tecla Izquierda/INT.<br/>La pantalla mostrará “Terminal _”.</li> </ol> |
|-----|---|---|

4 5 6



INT



**2** Introduzca el número interno del terminal al que desee llamar.

Se pondrá a su interlocutor externo en espera.

**3** Cuando el interlocutor interno conteste, seleccione “Conf.”.

O

**3** Si el interlocutor interno no contesta, pulse la tecla Izquierda/INT para recuperar al interlocutor externo.

**4** Pulse la tecla Colgar para finalizar la llamada o coloque el terminal otra vez en la base.

### Recibir una llamada externa durante una comunicación interna

Si está participando en una comunicación interna con otro terminal, puede seguir recibiendo llamadas del exterior.

Para recibir una llamada entrante:



**1** Pulse la tecla Colgar. La comunicación interna se interrumpirá.

**2** Pulse la tecla Descolgar. De este modo entrará en comunicación con la persona que ha realizado la llamada desde el exterior.

## 10 Solucionar problemas

Síntoma	Posible causa	Solución
Pantalla vacía	Baterías descargadas	Compruebe la posición de las baterías
		Recargue las baterías
Ausencia de tono	Terminal apagado	Encienda el terminal
	Cable telefónico mal conectado	Compruebe la conexión del cable telefónico
	La línea está ocupada por otro terminal	Espere hasta que cuelgue el otro terminal
El icono  parpadea	Terminal fuera del radio de alcance	Acerque el terminal a la base
	La base no recibe alimentación eléctrica	Compruebe la conexión de la toma de corriente de la base
	El terminal no está registrado en la base	Registre el terminal en la base
Ausencia de timbre en la base o el terminal	El volumen del timbre está desactivado o muy bajo	Ajuste el volumen del timbre
No se puede transferir una llamada de la centralita (PABX)	El tiempo flash es demasiado corto o demasiado largo	Cambie el tiempo flash
El teléfono no responde al pulsar las teclas	Error de manipulación	Quite las baterías y vuelva a colocarlas

## 11 Datos técnicos Características técnicas

Estándar	<b>DECT (Digital Enhanced Cordless Telecommunications - Telecomunicaciones digitales inalámbricas mejoradas)</b> <b>GAP (Generic Access Profile - Perfil de acceso genérico)</b>
Intervalo de frecuencia	1.880 MHz a 1.900 MHz
Número de canales	120 canales dúplex
Modulación	GFSK
Codificación de habla	32 kb/s
Potencia de emisión	10 mW (potencia media por canal)
Alcance	300 m en espacios abiertos / 50 m como máximo en el interior de la vivienda
Número de terminales	Hasta 4
Alimentación de la base	230 V / 50 Hz / 6 V CC 300 mA
Baterías del terminal:	2 baterías recargables AAA NiMh 1,2 V, 700 mA
Autonomía del terminal	110 horas en espera
Tiempo de conversación del terminal	11 horas
Condiciones normales de uso	+5 °C a +45 °C
Modo de marcación	Pulsos / Tonos
Tiempo flash	100 o 250 ms

## 12 Garantía

### 12.1 Periodo de garantía

Las unidades de Topcom tienen un periodo de garantía de 24 meses. El periodo de garantía entra en vigor el día en que se adquiere la nueva unidad. La garantía de las baterías está limitada a 6 meses desde la compra. La garantía no cubre los consumibles ni los defectos que tengan un efecto insignificante en el funcionamiento o en el valor del equipo.

La garantía debe demostrarse presentando el comprobante original de compra, en el que constarán la fecha de compra y el modelo de la unidad.

### 12.2 Tratamiento de la garantía

La unidad defectuosa deberá devolverse al centro de servicio de Topcom junto con un comprobante de compra válido.

Si la unidad tiene una avería durante el periodo de garantía, Topcom o su centro de servicio oficial repararán sin cargo alguno cualquier avería causada por defectos de material o fabricación. Topcom, a su discreción, cumplirá sus obligaciones de garantía reparando o sustituyendo las unidades defectuosas o las piezas de las unidades defectuosas. En caso de sustitución, el color y el modelo pueden variar respecto a los de la unidad adquirida inicialmente.

La fecha de compra inicial determinará el comienzo del periodo de garantía. Éste no se extenderá si Topcom o sus centros de servicio autorizados cambian o reparan la unidad.

### 12.3 Limitaciones de la garantía

Los daños o defectos causados por tratamiento o manejo incorrectos y los daños resultantes del uso de piezas o accesorios no originales no recomendados por Topcom no están cubiertos por la garantía.

Los teléfonos inalámbricos Topcom están diseñados para funcionar sólo con baterías recargables. Los daños provocados por el uso de baterías no recargables no están cubiertos por la garantía.

La garantía no cubre los daños ocasionados por factores externos tales como relámpagos, agua o fuego; así como tampoco los daños causados durante el transporte.

La garantía no será válida si el número de serie de las unidades se cambia, se elimina o resulta ilegible.

Cualquier reclamación de la garantía se invalidará si la unidad ha sido reparada, alterada o modificada por el comprador o algún centro de servicio no cualificado o no designado oficialmente por Topcom.

## 13 Eliminación del dispositivo (medio ambiente)



Al final de su vida útil este producto no debe ser desechado en un contenedor normal, sino en un punto de recogida destinado al reciclaje de equipos eléctricos y electrónicos. Tanto en el producto como en el manual de usuario y en la caja se incluye este símbolo.

Algunos de los materiales del producto podrán reutilizarse si los lleva a un punto de reciclaje. La reutilización de algunas de las piezas o materias primas de estos productos supone una importante contribución a la protección del medio ambiente.

Si necesita más información sobre los puntos de reciclaje existentes en su zona, póngase en contacto con las autoridades locales correspondientes.

## 14 Limpieza

Limpie el teléfono con un trapo ligeramente humedecido o con un trapo antiestático. No use nunca agentes limpiadores ni disolventes abrasivos.

## 15 Modo ECO (radiación baja)

- Este teléfono inalámbrico (que cumple con la norma DECT) facilita el funcionamiento con un nivel de radiación bajo.
- La intensidad de radiación de la señal de radio entre la estación base y el teléfono se reduce al mínimo cuando el teléfono se encuentra en la estación base.
- Sólo cuando se retira el teléfono de la estación base o cuando se recibe una llamada, la intensidad de la radiación de la señal de radio aumenta hasta alcanzar el nivel normal.
- Esto no significa que la radiación DECT normal sea perjudicial para la salud.
- El modo de radiación baja evita una carga de radiación DECT innecesaria cuando no es necesaria la comunicación entre la estación base y el teléfono.
- Por razones técnicas, no pueden utilizarse otros teléfonos en modo de radiación baja (un teléfono adicional que no esté situado en las inmediaciones de la estación base siempre estaría "buscando la estación base" debido a una señal de radio baja).
- El modo de radiación baja viene ya activado en la configuración de fábrica.
- El modo de radiación baja se desactiva automáticamente si conecta un teléfono adicional.
- El modo de radiación baja se activa de forma automática de nuevo al desactivar todos los teléfonos adicionales (sólo puede haber un teléfono conectado a la estación base).
- El procedimiento de conexión y desconexión de teléfonos se explica en el Manual del usuario.

## Svenska

### 1 Säkerhetsföreskrifter

- Använd endast den medföljande laddaren. Använd inte andra laddare eftersom det kan skada battericellerna.
- Sätt endast i uppladdningsbara batterier av samma sort. Använd aldrig vanliga, ej uppladdningsbara batterier. Sätt i de uppladdningsbara batterierna så att de ansluter till rätt poler (indikeras i handenhetens batterifack).
- Rör inte vid laddaren eller kontakterna med vassa föremål eller metallföremål.
- Viss medicinsk utrustning kan påverkas.
- Handenheten kan orsaka ett obehagligt surrande ljud i hörapparater.
- Placera inte basenheten i ett fuktigt rum eller mindre än 1,5 meter från en vattenkran. Håll vatten borta från handenheten.
- Använd inte telefonen i miljöer där det finns risk för explosioner.
- Gör dig av med batterierna och underhåll telefonen på ett miljövänligt-sätt.
- Eftersom telefonen inte kan användas vid strömavbrott bör du använda en telefon-som är oberoende av elnätet för nödsamtal, t.ex. en mobiltelefon.

### 2 Komma igång

#### 2.1 Så här används bruksanvisningen

I den här bruksanvisningen används följande metod för att förtydliga instruktionerna:

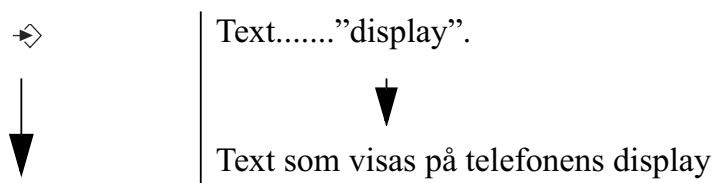

Knapp som ska tryckas ned. Den här knappen kan vara en snabbknapp (Se ”2.4 Knappar/Lampor”). När snabbknappen är en symbol, visas den i den vänstra kolumnen. När snabbknappen är text, visas den vänstra eller högra snabbknappen i den vänstra kolumnen och texten visas inom citattecken i den högra kolumnen.

#### 2.2 Installera basenheten

Gör så här för att installera:

- 1** Sätt i ena änden av adaptern i eluttaget och den andra i adapterjacket på baksidan av basenheten.
- 2** Anslut ena änden av telefonsladden till väggtelefonjacket och den andra änden till basenhetens nederdel.
- 3** Sätt i telefon- och elsladden i basenheten såsom visas på bild 2A.

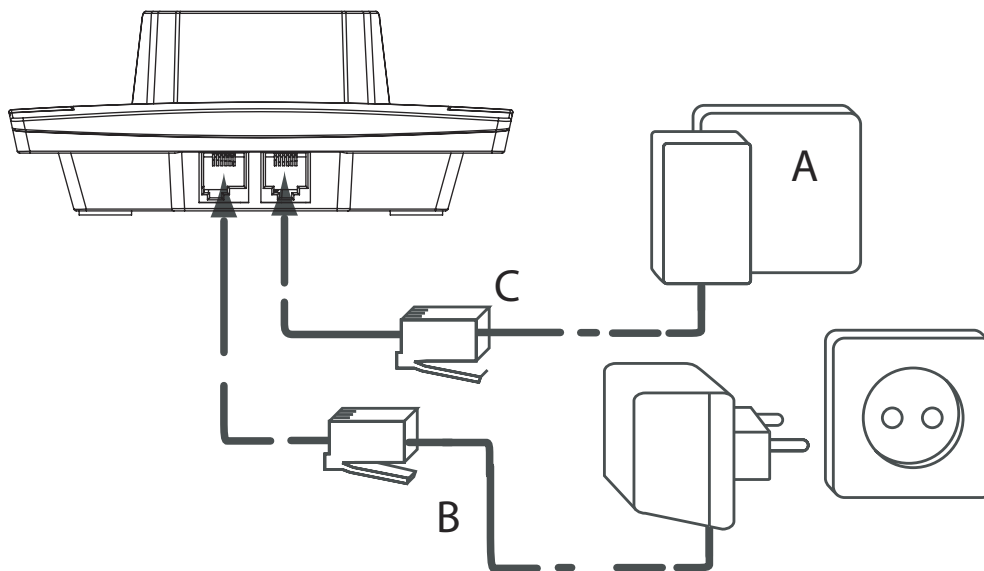

- 2A Basenhetens baksida -

A. Telefonjack

B. Nätsladd

C. Telefonsladd

### 2.3 Installera handenheten

- 1 Öppna batterifacket såsom visas på bild 2B.
- 2 Sätt i batterierna med hänsyn till polariteten (+ och -).
- 3 Stäng batterifacket.
- 4 Låt handenheten stå i basenheten i 20 timmar. Linje-/laddningslampan  på basenheten lyser.

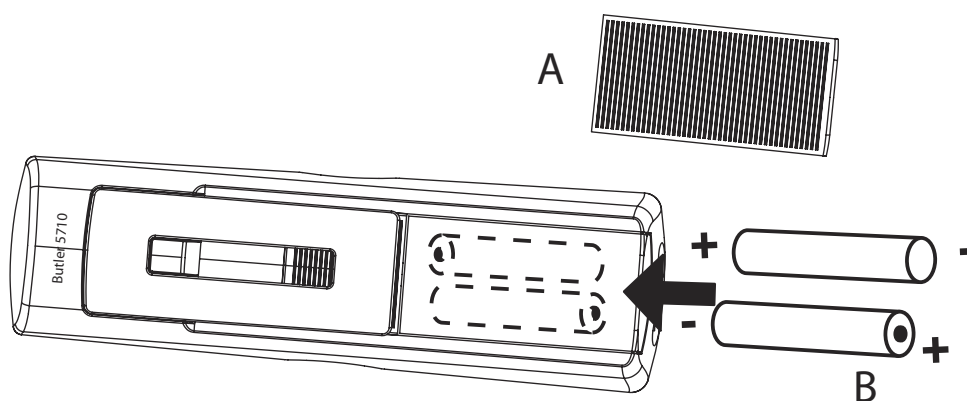

- 2B Handenhetens baksida -

A. Hölje

B. Laddningsbara batterier



*Innan du använder telefonen första gången, måste batteriet laddas i 20 timmar. Om du inte gör det kommer inte telefonen att fungera optimalt.*



## 2.4 Knappar/Lampor

### Handenhet

1. Display
2. Upp-/återuppringningsknapp
3. Höger snabbmenyknapp
4. Höger knapp/pausknapp
5. Lur på-/AV-knapp
6. Alfanymeriska knappar
7. Knappsatslås
8. Ringsignal av
9. Ned-/samtalsloggknapp
10. Lur av-knapp/ Högtalartelefon/ På-key
11. Vänster-/INT-knapp
12. OK-knapp
13. Vänster snabbmenyknapp

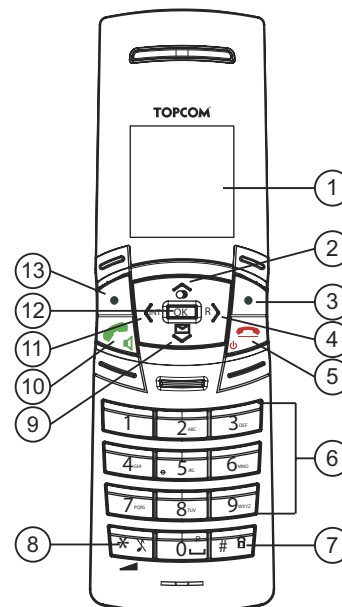

- 2C Handenhet -





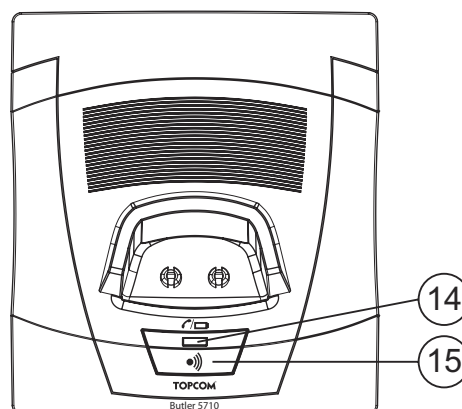









### Basenhet

14. Används/Power/Handenhet på basenhetens lampa
15. Söknapp



- 2D Basenhet -

## 2.5 Symboler

	Lur av		Knappsatslås
	Lur på		Alarminställning
	Missade samtal i samtalslista*		Handenhet ej registrerad eller för långt bort
	Handenhetens ringsignalsvolym AV		Batteri tomt
	Handenhet inom basenhetens räckvidd		Batteri lågt
	Internt samtal		Batteri medium
	Högtalartelefon		Batteri fullt
	Nytt röstmeddelande		

\* Om nummerpresentationstjänsten är tillgänglig på telefonlinjen.

## 2.6 Displayknappar

Displayknapparna (snabbknappar) sitter precis nedanför displayen. Funktionen för de här 2 knapparna ändras beroende på användningsläget. Den aktuella funktionen visas som en ikon eller text precis ovanför de 2 displayknapparna.

	Telefonbok		Tyst
	OK/Bekräfta		Tillbaka
	Meny		Ingen knapp
	Radera		





## 2.7 Lysdiod på basenheten

Lysdioden (14) indikerar följande status:



- AV: ingen ström ansluten till basenhet eller handenhet inte i basenhet för laddning
- PÅ: handenhet laddar
- Blinkar långsamt: Luren av eller under samtal
- Blinkar snabbt: under registrering

## 2.8 Navigera i menyn

Butler 5710 har ett menysystem som är enkelt att använda. Varje meny leder till en lista med alternativ. Menykartan visas i följande stycke.

- |   |   |
|---|---|
|  | <b>1</b> När handenheten är påslagen och i vänteläge, tryck på vänster snabbmenyknapp  för att öppna huvudmenyn. |
|  | <b>2</b> Bläddra till önskat menyalternativ.  |
|  | <b>3</b> Tryck på snabbmenyknapp 1 för att visa fler alternativ eller för att bekräfta den visade inställningen.  |

### För att lämna eller för att gå tillbaka en nivå i menyn

- |   |   |
|---|---|
|  | För att gå till den föregående nivån i menyn, tryck på snabbmenyknappen.          |
|  | För att avbryta och återgå till vänteläge när som helst, tryck på lur på-knappen. |

## 2.9 Meny-översikt

Meny	Undermenyobjekt
Handenhet	Ringsignal
	Uppringningsvolym
	Handenhetens namn
	Knappsatsljud
	Kontrast
	Autosamtal
	Prefix
	Välj basenhet
	Språk
	Registrering
Grundinställningar	Ringsignal
	Uppringningsvolym
	Uppringningsläge
	Återuppringning
Alarm/klocka	System-PIN
	Ställ in alarm
	Datum och tid
Verktyg	Tidformat
	Möte
Ström av	Stoppur

## 3 Använda telefonen

### 3.1 Sätta på och stänga av handenheten



- Tryck och håll ned AV-knappen för att stänga av handenheten.
- Tryck på lur av-knappen eller sätt handenheten i basenheten för att sätta på handenheten igen.

### 3.2 Byta menyspråk



- Gå in i menyn.
- Välj "Handenhet" och bekräfta.
- Välj "Språk" och bekräfta.
- Välj ett språk och bekräfta.  
Skärmbilden visar "Sparat".
- Tryck på lur på-knappen för att återgå till vänteläge.



*Pilarna ◊ visar att det finns fler alternativ i menyn.*

### 3.3 Ringa ett vanligt telefonsamtal

#### Ringa direkt



- 1** Tryck på lur av-knappen för att starta samtalet.
- 2** Slå telefonnumret.
- 3** Tryck på lur på-knappen för att lägga på eller sätt tillbaka handenheten i basenheten.

#### Föruppringning

Med föruppringningsfunktionen kan du slå och ändra ett nummer innan du ringer upp.



- 1** Slå ett nummer på upp till 24 siffror.  
Tryck och håll ned 0-knappen för att göra en paus. Skärmbilden visar ett "P".
- 2** Tryck ned snabbmenyknappen för att korrigera.
- 3** Tryck på lur av-knappen för att starta samtalet.
- 4** Tryck på lur på-knappen för att lägga på eller sätt tillbaka handenheten i basenheten.

#### Återuppring ett nummer från listan

Du kan återuppringa upp till 10 av de sist slagna numren. Om du har sparat ett namn i telefonboken tillsammans med numret, kommer namnet att visas i stället.



- 1** Tryck på återuppringningsknappen.
- 2** Välj ett nummer. Om numret finns i telefonboken visas namnet.
- 3** Tryck på lur av-knappen för att starta samtalet eller välj "Alternativ".
- 4** Om du valde "Alternativ", bläddra och välj:  
"Ta bort samtal": för att ta bort numret från samtalslistan;  
"Spara nummer": för att spara numret i telefonboken;  
"Ta bort alla": för att radera samtalslistan.
- 5** Bekräfta val.
- 6** Tryck på lur på-knappen för att återgå till vänteläge.

### 3.4 Ta emot ett telefonsamtal

När du tar emot ett externt samtal visar displayen "Externt samtal".

För att ta emot samtalet:



- 1** Tryck på lur av-knappen.  
ELLER  
Lyft handenheten från basenheten om du har aktiverat "Autosamtal"  
(Se "6.5 Autosamtal")  
Ikonen för pågående  samtal visas på skärmen. Samtalslängden visas efter 15 sekunder.
- 2** Tryck på lur på-knappen för att lägga på eller sätt tillbaka handenheten i basenheten.



*Du kan stänga av ringvolymen under ett inkommande samtal genom att välja "Tyst".*

### 3.5 Högtalar-läge

Högtalaranvändning gör att du kan prata utan att hålla i handenheten. Det gör också att andra människor i rummet kan lyssna på båda sidor i er konversation.



- 1 För att växla över ett samtal till högtalaranvändning, tryck på högtalarknappen under samtalet.

### 3.6 Justera volymen för öronsnäcka/högtalare



- 1 Tryck upp eller ned för att välja volym 1-5 under ett vanligt eller ett högtalarsamtal.

### 3.7 Sekretess-funktion (Ljud av-funktion)

Stänger av mikrofonen så att personen på andra sidan inte kan höra dig.



- 1 Tryck på snabbmenyknappen för att stänga av mikrofonen under telefonsamtalet.

”Tyst på” visas på skärmen.



- 2 Välj ”Av” för att aktivera mikrofonen igen.

### 3.8 Leta efter en handenhet (Sök-funktion)



- 1 Tryck på sökknappen på basenheten.

Alla handenheter som är registrerade med basenheten ringer i 30 sekunder.



- 2 Tryck på valfri knapp på handenheten för att stoppa sökningen.

### 3.9 Knapplås

Låser knappsatsen för att förhindra oavsiktlig uppringning när du bär med dig handenheten.

I vänteläge:



- 1 Tryck och håll knapplåsknappen (knapp 7 - bild 2C) tills ”Låst” och knapplåsikonen  visas på skärmen.



- 2 För att låsa upp, välj ”Lås upp”, följt av knapplåsknappen.

### 3.10 Använda den alfanumeriska knappsatsen

Med din telefon kan du även ange alfanumeriska tecken. Det är användbart för att ange ett namn i telefonboken, namnge handenheten, ...





För att välja en bokstav, tryck på motsvarande knapp så många gånger som behövs.

Till exempel, för att välja ett ”A”, tryck ”2” en gång. För att välja ett ”B”, tryck ”2” två gånger och så vidare.

För att välja ”A” och därefter ”B” efter varandra, tryck ”2” en gång, vänta tills markören flyttar till nästa tecken, tryck därefter ”2” två gånger.

Medan du skriver in texten visas den tillgängliga bokstaven under varje knapp nederst på skärmen.













Du kan ändra inmatningsteckensnitt från engelska (abc) till latin (aää), grekiska (ABΓ) eller ryska (ABB) genom att trycka och hålla ned #-knappen i 2 sekunder.

	Tryck "0" för att välja en plats.
	Tryck på *-knappen för att växla mellan små bokstäver och stora.
	Tryck och håll ned #-knappen i 2 sekunder för att ändra inmatningsteckensnitt.
	Tryck ned snabbmenyknappen för att korrigera.





## 4 Telefonbok

Varje enhet kan lagra upp till 200 namn och nummer. Namn kan vara upp till 16 tecken långa och nummer upp till 24 siffror.







### 4.1 För att lägga till en kontakt

	<b>1</b> Tryck på snabbknappen.
	Om telefonboken är tom visas "Telefonbok tom" på skärmen. Om namn har sparats, listas de.
 	<b>2</b> Välj "Alternativ".
 	<b>3</b> Välj "Ny kontakt" och bekräfta.
 	<b>4</b> Använd knappsatsen för att skriva namnet, välj sedan "Spara".
 	<b>5</b> Använd knappsatsen för att skriva numret, välj sedan "Spara".
 	<b>6</b> Välj önskad ringmelodi och välj "Spara".
	<b>7</b> Återgå till vänteläge.











### 4.2 För att ringa en kontakt

	<b>1</b> Tryck på snabbknappen.
	<b>2</b> Välj önskat namn eller använd knappsatsen för att skriva in den första bokstaven i namnet.
	<b>3</b> Tryck på lur av-knappen för att starta samtalet.
	<b>4</b> Återgå till vänteläge.











### 4.3 Visa detaljer

	<b>1</b> Tryck på snabbknappen.
	<b>2</b> Välj önskat namn eller använd knappsatsen för att skriva in den första bokstaven i namnet.
	<b>3</b> Välj "Alternativ".
 	<b>4</b> Välj "Visa detaljer" och bekräfta.
	Det namn, nummer och den ringmelodi du har tilldelat kontakten visas på skärmen.
	<b>5</b> Återgå till vänteläge.











#### 4.4 Ta bort en kontakt eller alla kontakter

- |   |   |
|---|---|
|    | <b>1</b> Tryck på snabbknappen.   |
|    | <b>2</b> Välj önskat namn eller använd knappsatsen för att skriva in den första bokstaven i namnet. |
|    | <b>3</b> Välj "Alternativ".   |
|   | För att ta bort en kontakt:   |
|   | <b>4</b> Välj "Ta bort kontakt" och bekräfta.   |
|   | För att ta bort alla kontakter:   |
|   | <b>4</b> Välj "Ta bort alla" och bekräfta.  |
|   | <b>5</b> Tryck på den vänstra menyknappen för att avbryta eller den högra för att bekräfta.         |
|    | <b>6</b> Återgå till vänteläge.   |

#### 4.5 Redigera namn och nummer

- |   |   |
|---|---|
|    | <b>1</b> Tryck på snabbknappen.   |
|    | <b>2</b> Välj önskat namn eller använd knappsatsen för att skriva in den första bokstaven i namnet. |
|    | <b>3</b> Välj "Alternativ".   |
|     | <b>4</b> Välj "Redigera kontakt" och bekräfta.  |
|    | <b>5</b> Tryck på snabbmenyknappen för att ta bort och använd knappsatsen för att ändra namnet.     |
|    | <b>6</b> Välj "Spara".  |
|    | <b>7</b> Redigera numret och välj "Spara".  |
|   | <b>8</b> Välj önskad ringmelodi och välj "Spara".   |
|    | <b>9</b> Återgå till vänteläge.   |

#### 4.6 Kopiera en telefonbokskontakt till en annan handenheter

- |   |   |
|---|---|
|    | <b>1</b> Tryck på snabbknappen.   |
|    | <b>2</b> Välj önskat namn eller använd knappsatsen för att skriva in den första bokstaven i namnet.   |
|    | <b>3</b> Välj "Alternativ".   |
|   | <b>4</b> Välj "Kopiera kontakt" och bekräfta.   |
|   | Tillgängliga handenheter (alla handenheter som är registrerade på basenheten) visas.  |
|   | <b>5</b> Välj önskad handenhet och bekräfta.  |
|   | "Kopierar till handenhet x" visas på skärmen.   |
|   | "Ta emot telefonbokskontakt?" visas på skärmen på mottagande handenhet.   |
|   | <b>6</b> På den mottagande handenheten trycker du på den högra menyknappen för att bekräfta eller den vänstra för att avbryta överföringen. |
|    | <b>7</b> Återgå till vänteläge.   |

## 4.7 Kopiera alla telefonbokskontakter till en annan handenhet



*Genom att kopiera alla kontakter från en handenhet till en annan, raderas alla befintliga kontakter på den mottagande handenheten.*



- 1** Tryck på snabbknappen.
- 2** Välj önskat namn eller använd knappsatsen för att skriva in den första bokstaven i namnet.
- 3** Välj "Alternativ".
- 4** Välj "Kopiera alla" och bekräfta.  
Tillgängliga handenheter (alla handenheter som är registrerade på basenheten) visas.
- 5** Välj önskad handenhet och bekräfta.  
"Kopierar till handenhet x" visas på skärmen.  
"Ersätt alla telefonbokskontakter?" visas på skärmen på den mottagande handenheten.
- 6** På den mottagande handenheten trycker du på den högra menyknappen för att bekräfta eller den vänstra för att avbryta överföringen.
- 7** Återgå till vänteläge.

## 5 Nummerpresentation

### 5.1 Vanliga inkommande PSTN-samtal



*Den här tjänsten fungerar bara när du har ett nummerpresentationsabonnemang. Kontakta ditt telefonbolag.*

När du tar emot ett samtal från din fasta telefon, visas det uppringande telefonnumret på handenhetens skärm. Telefonen kan ta emot samtal i både FSK och DTMF. Du kan också se hans eller hennes namn om det överförs av nätverket. Om namnet är programmerat i telefonboken, visas namnet från telefonboken!

Telefonen kan lagra 30 samtal i en samtalslista (mottagna och missade) som kan visas senare. När minnet är fullt ersätter nya samtal automatiskt de gamla i minnet.



















Missade samtal signaleras med en blinkande ikon på skärmen. Handenhetens namn ersätts av den här ikonen och antalet missade samtal.

### För att läsa mottagna samtal



- 1** Tryck på ned-knappen.  
Listan med mottagna samtal visas på skärmen. Det här är kombination av mottagna och missade samtal.
- 2** Välj önskat namn eller nummer.
- 3** Tryck på lur av-knappen för att starta samtalet.  
ELLER  
Välj "Alternativ".  
För att ta bort en kontakt:

















- |   |   |   |  |
|---|---|---|--|
|  |  |  | <b>4</b> Välj "Ta bort samtal" och bekräfta.                           |
|  |   |   | <b>5</b> Återgå till vänteläge.  |
|   |   |   | För att ta bort alla kontakter:  |
|  |  |  | <b>5</b> Välj "Ta bort alla" och bekräfta.                             |
|  |   |   | <b>6</b> Återgå till vänteläge.  |
|   |   |   | Lägga till ett nummer till telefonboken.                               |
|  |  |  | <b>5</b> Välj "Spara nummer" och bekräfta.                             |
|  |   |   | <b>6</b> Använd knappsatsen för att skriva namnet, välj sedan "Spara". |
|  |   |   | <b>7</b> Använd knappsatsen för att skriva numret, välj sedan "Spara". |
|  |  |  | <b>8</b> Välj önskad ringmelodi och välj "Spara".                      |
|  |   |   | <b>9</b> Återgå till vänteläge.  |

## 6 Anpassa handenheten

### 6.1 Ringsignal och volym











#### Ringsignal

Du kan välja mellan 18 olika ringmelodier för interna och externa samtal.

- |   |   |   |  |
|---|---|---|--|
|    |   |   | <b>1</b> Gå in i menyn.  |
|  |  |  | <b>2</b> Välj "Handenhet" och bekräfta.  |
|  |  |  | <b>3</b> Välj "Ringsignal" och bekräfta.   |
|  |  |  | <b>4</b> Välj "Externt" för externa samtal eller välj "Internt" för interna samtal och bekräfta. |
|  |  |  | <b>5</b> Välj önskad melodi och bekräfta.  |
|   |   |   | Vid bläddring spelas melodin upp.  |
|  |   |   | <b>6</b> Återgå till vänteläge.  |









#### Uppringningsvolym

Du kan välja mellan 5 volymnivåer för handenhetsringsignaler och av.









- |   |   |   |  |
|---|---|---|--|
|  |   |   | <b>1</b> Gå in i menyn.                              |
|  |  |  | <b>2</b> Välj "Handenhet" och bekräfta.              |
|  |  |  | <b>3</b> Välj "Ringsignalsvolym" och bekräfta.       |
|   |   |   | Den nuvarande inställningen visas.                   |
|  |   |   | <b>4</b> Tryck på uppknappen för att öka volymen.    |
|  |   |   | <b>5</b> Tryck på nedknappen för att minska volymen. |
|  |   |   | <b>6</b> Välj "Spara" för att bekräfta.              |
|  |   |   | <b>7</b> Återgå till vänteläge.                      |

## 6.2 Handenhetens namn









Du kan ändra namnet som visas på handenheten i vänteläge (max. 9 tecken).

- |   |          |   |
|---|----------|---|
|    | <b>1</b> | Gå in i menyn.                                |
|   | <b>2</b> | Välj "Handenhet" och bekräfta.                |
|   | <b>3</b> | Välj "Handenhetsnamn" och bekräfta.           |
|    | <b>4</b> | Skriv in det namn du vill ha.                 |
|    | <b>5</b> | Tryck ned snabbmenyknappen för att korrigera. |
|    | <b>6</b> | Välj "Spara" för att bekräfta.                |
|    | <b>7</b> | Återgå till vänteläge.                        |

## 6.3 Knappljud









- |   |          |                                    |
|---|----------|------------------------------------|
|    | <b>1</b> | Gå in i menyn.                     |
|   | <b>2</b> | Välj "Handenhet" och bekräfta.     |
|   | <b>3</b> | Välj "Knappsatsljud" och bekräfta. |
|   | <b>4</b> | Välj "På" eller "Av" och bekräfta. |
|    | <b>5</b> | Återgå till vänteläge.             |

## 6.4 Ställ in kontrast

- |   |          |  |
|---|----------|--|
|    | <b>1</b> | Gå in i menyn.                                   |
|   | <b>2</b> | Välj "Handenhet" och bekräfta.                   |
|   | <b>3</b> | Välj "Kontrast" och bekräfta.                    |
|   | <b>4</b> | Välj den kontrast du vill ha (1-8) och bekräfta. |
|    | <b>5</b> | Återgå till vänteläge.                           |







## 6.5 Autosamtal







När det kommer ett inkommande samtal och handenheten är i basenheten, går telefonen automatiskt ut på linjen när den lyfts från basenheten. Den här funktionen kan slås på och av.

- |   |          |                                    |
|---|----------|------------------------------------|
|    | <b>1</b> | Gå in i menyn.                     |
|   | <b>2</b> | Välj "Handenhet" och bekräfta.     |
|   | <b>3</b> | Välj "Autosamtal" och bekräfta.    |
|   | <b>4</b> | Välj "På" eller "Av" och bekräfta. |
|    | <b>5</b> | Återgå till vänteläge.             |

## 6.6 Prefix-kod

Det är möjligt att använda din telefon med ett prefixnummer. När du slår telefonnummer kan du automatiskt lägga till prefixkoden innan numret.















- |   |          |                                |
|---|----------|--------------------------------|
|    | <b>1</b> | Gå in i menyn.                 |
|   | <b>2</b> | Välj "Handenhet" och bekräfta. |
|   | <b>3</b> | Välj "Prefix" och bekräfta.    |
|   | <b>4</b> | Välj "Redigera" och bekräfta.  |

- |   |   |   |
|---|---|---|
|  |  | <b>5</b> Ange prefixkoden, exempelvis "0" och välj "Spara". |
|   |   | ELLER   |
|  |  | <b>4</b> Välj "På/Av" och bekräfta.                         |
|  |  | <b>5</b> Välj "På" eller "Av" och bekräfta.                 |
|  |   | <b>6</b> Återgå till vänteläge.                             |









## 6.7 Använd alarmfunktionen

Du kan ha olika alarminställningar för varje handenhet som är registrerad till din basenhet. Alarmet ringer bara på den handenheten, inte på basenheten eller någon annan handenhet.









### Ställ in alarmet

- |   |   |  |
|---|---|--|
|    |   | <b>1</b> Gå in i menyn.  |
|    |    | <b>2</b> Välj "Alarm/Klocka" och bekräfta.   |
|    |    | <b>3</b> Välj "Ställ in alarm" och bekräfta.   |
|    |    | <b>4</b> Välj "En gång", "Varje dag", "Mån till Fre" eller "Av" och bekräfta.<br>Om du har valt "En gång", "Varje dag" eller "Mån till Fre", så visar skärmen:<br>Tid (24 tim):<br>00:00 |
|   |   | <b>5</b> Ange tidpunkt när du vill att telefonen ska ringa och bekräfta med "Spara".   |
|  |  | <b>6</b> Välj önskad ringsignal och bekräfta med "Spara".  |
|  |  | <b>7</b> För att stänga av alarmet, välj "Av" och bekräfta.  |
|  |   | <b>8</b> Återgå till föregående meny.  |

## 6.8 Ställa in datum och tid

- |   |   |  |
|---|---|--|
|  |   | <b>1</b> Gå in i menyn.  |
|  |  | <b>2</b> Välj "Alarm/Klocka" och bekräfta.                                       |
|  |  | <b>3</b> Välj "Datum & Tid" och bekräfta.  |
|  |  | <b>4</b> Ange år, månad, dag, tid och minuter och välj "Spara" för att bekräfta. |
|  |   | <b>5</b> Återgå till föregående meny.  |









## 6.9 Ställa in tidformatet

- |   |   |   |
|---|---|---|
|  |   | <b>1</b> Gå in i menyn.                             |
|  |  | <b>2</b> Välj "Alarm/Klocka" och bekräfta.          |
|  |  | <b>3</b> Välj "Tidformat" och bekräfta.             |
|  |  | <b>4</b> Välj "12 tim" eller "24 tim" och bekräfta. |
|  |   | <b>5</b> Återgå till föregående meny.               |

## 7 Grundinställningar









### 7.1 Ringsignal

Du kan välja mellan 9 olika ringmelodier.

- |   |          |   |
|---|----------|---|
|    | <b>1</b> | Gå in i menyn.                          |
|   | <b>2</b> | Välj "Grundinställningar" och bekräfta. |
|   | <b>3</b> | Välj "Ringsignal" och bekräfta.         |
|   | <b>4</b> | Välj önskad melodi och bekräfta.        |
|   |          | Vid bläddring spelas ett exempel upp.   |
|    | <b>5</b> | Återgå till vänteläge.                  |

### 7.2 Uppringningsvolym

Du kan välja mellan 5 volymnivåer för basenhetsringsignaler.









- |   |          |   |
|---|----------|---|
|    | <b>1</b> | Gå in i menyn.                              |
|   | <b>2</b> | Välj "Grundinställningar" och bekräfta.     |
|   | <b>3</b> | Välj "Ringsignalsvolym" och bekräfta.       |
|   |          | Den nuvarande inställningen visas.          |
|    | <b>4</b> | Tryck på uppknappen för att öka volymen.    |
|    | <b>5</b> | Tryck på nedknappen för att minska volymen. |
|    | <b>6</b> | Välj "Spara" för att bekräfta.              |
|    | <b>7</b> | Återgå till vänteläge.                      |

### 7.3 Uppringningsläge

Det finns 2 typer av uppringning:





- DTMF/Tonuppringning (vanligast)
- Uppringning med pulsval (för äldre installationer)

För att ändra uppringningsläge:

- |   |          |   |
|---|----------|---|
|    | <b>1</b> | Gå in i menyn.                            |
|   | <b>2</b> | Välj "Grundinställningar" och bekräfta.   |
|   | <b>3</b> | Välj "Uppringningsläge" och bekräfta.     |
|   | <b>4</b> | Välj "Ton" eller "Puls" och välj "Spara". |
|    | <b>5</b> | Återgå till vänteläge.                    |

### 7.4 Återuppring (Paus)

Tryck på pausknappen "R" (knapp 4 - bild 2C) för att använda vissa tjänster på den externa linjen som t.ex. "samtal väntar" (om telefonoperatören erbjuder denna tjänst) eller för att överföra samtal om du använder en telefonväxel (PABX). Pausknappen "R" innebär ett kort avbrott på linjen. Du kan ställa in paustiden till 100 ms eller 250ms.

- |   |          |   |
|---|----------|---|
|    | <b>1</b> | Gå in i menyn.                          |
|   | <b>2</b> | Välj "Grundinställningar" och bekräfta. |
|   | <b>3</b> | Välj "Återuppring" och bekräfta.        |



- 4** Välj kort paustid (100 ms) eller lång paustid (250 ms) och välj "Spara".
- 5** Återgå till vänteläge.

## 7.5 System-PIN

System-PIN används för registrering och avregistrering av handenheter och en del valfria inställningar. Standard för system-PIN är 0000.



- 1** Gå in i menyn.
- 2** Välj "Grundinställningar" och bekräfta.
- 3** Välj "System-PIN" och bekräfta.
- 4** Ange den gamla PIN (0000 som standard) och välj "Spara".
- 5** Ange ny PIN, välj "Spara" och upprepa detta.
- 6** Återgå till vänteläge.

## 8 Verktyg

### 8.1 Möte

Du kan ange 5 möten eller påminnelser som du kan ge ett namn och ett alarm med datum och tid.



- 1** Gå in i menyn.
  - 2** Välj "Verktyg" och bekräfta.
  - 3** Välj "Möten" och bekräfta.
  - 4** Välj ett av 5 möten och välj "Alternativ".
- För att redigera mötet:
- 5** Välj "Redigera" och bekräfta.
  - 6** Redigera namnet för mötet och välj "Spara".
  - 7** Redigera datumet för mötet och välj "Spara".
  - 8** Ange tiden och välj "Spara".
  - 9** Välj önskad alarmmelodi och välj "Spara".
  - 10** Återgå till vänteläge.



- För att ta bort mötet:
- 5** Välj "Ta bort" och bekräfta.
  - 6** Tryck på den högra snabbmenyknappen för att bekräfta.
  - 7** Tryck på den vänstra snabbmenyknappen för att gå tillbaka.
  - 8** Återgå till vänteläge.

### 8.2 Stoppur



- 1** Gå in i menyn.
- 2** Välj "Verktyg" och bekräfta.
- 3** Välj "Stoppur" och bekräfta.
- 4** Välj "Starta" för att starta stoppuret.
- 5** Välj "Stopp" för att stoppa stoppuret.



- Välj "Starta" igen för att starta om.
- Välj "Återställ" för att återställa räknaren.
- 6** Återgå till vänteläge.

## 9 Ytterligare handenheter och basenheter.

Du kan registrera upp till 4 handenheter på en basenhet. Varje handenhet kan registrera upp till 4 basenheter och användaren kan välja den basenhet som ska användas.

### 9.1 Lägg till en ny handenhet



*Behövs bara när du har avregistrerat en handenhet eller när du har köpt en ny.*

Försätta basenheten i registreringsläge:



- 1** Tryck och håll ned söknappen på basenheten.
- Lysdioden på basenheten blinkar i 90 sekunder. Under den tiden är basenheten redo att registrera.

På handenheten:

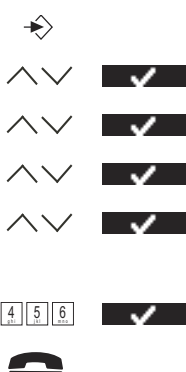

- 1** Gå in i menyn.
- 2** Välj "Handenhet" och bekräfta.
- 3** Välj "Registrering" och bekräfta.
- 4** Välj "Registrera" och bekräfta.
- 5** Välj basenhetens nummer som ska associeras med handenheten (1-4) och bekräfta.
- 6** Ange system-PIN (0000 som standard) och bekräfta.
- 7** Återgå till vänteläge.

### 9.2 Ta bort en handenhet



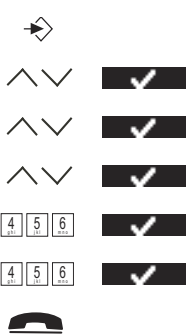





Den här proceduren måste göras på en annan handenhet än den du vill ta bort.



- 1** Gå in i menyn.
- 2** Välj "Handenhet" och bekräfta.
- 3** Välj "Registrering" och bekräfta.
- 4** Välj "Avregistrera" och bekräfta.
- 5** Ange system-PIN (0000 som standard) och bekräfta.
- 6** Ange numret på den handenhet som måste tas bort och bekräfta.
- 7** Återgå till vänteläge.

### 9.3 Välj en basenhet

Du kan flytta din handenhet mellan olika basenheter. Du kan också ställa in den att automatiskt välja den basenhet som har starkast signal. Handenheten måste först vara registrerad med varje basenhet för sig.





- |   |   |  |
|---|---|--|
| <br><br><br><br><br> | <br><br> | <ol style="list-style-type: none"> <li><b>1</b> Gå in i menyn.</li> <li><b>2</b> Välj ”Handenhet” och bekräfta.</li> <li><b>3</b> Välj ”Välj basenhet” och bekräfta.</li> <li><b>4</b> Välj ”Manuell” eller ”Auto” och bekräfta.</li> </ol> <p>Om du har valt ”Manuell”:</p> <ol style="list-style-type: none"> <li><b>5</b> Välj den basenhet som ska associeras med handenheten och bekräfta.</li> </ol> |
|---|---|--|



*När du har aktiverat Automatiskt basenhetsval och handenheten är utom räckvidd för nuvarande basenhet, kommer handenheten bara att leta efter den starkaste basenheten i vänteläge (inte under kommunikation).*







### 9.4 Använda snabbtelefonsfunktion

#### Ringa en intern handenhet

- |   |   |   |
|---|---|---|
| INT<br><br><br> | <br><br> | <ol style="list-style-type: none"> <li><b>1</b> Tryck på den vänstra INT-knappen.<br/>Skärmen visar ”Handenhet _”.</li> <li><b>2</b> Ange det interna numret till den handenhet du vill ringa till.</li> <li><b>3</b> Tryck på lur på-knappen för att lägga på eller sätt tillbaka handenheten i basenheten.</li> </ol> |
|---|---|---|

#### Överföra ett externt samtal till en annan handenhet

Under ett externt samtal:

- |   |   |   |
|---|---|---|
| INT<br><br><br> | <br><br> | <ol style="list-style-type: none"> <li><b>1</b> Tryck på den vänstra INT-knappen.<br/>Skärmen visar ”Handenhet _”.</li> <li><b>2</b> Ange det interna numret till den handenhet du vill ringa till.<br/>Din externa samtalspartner parkeras.</li> <li><b>3</b> När den interna samtalspartnern svarar, tryck på lur på-knappen för att överföra samtalet.</li> </ol> <p>ELLER</p> |
| INT<br><br>  |    | <ol style="list-style-type: none"> <li><b>3</b> Om den interna samtalspartnern inte svarar, tryck på den vänstra INT-knappen för att återta det externa samtalet eller för att gå från den ena till den andra.</li> <li><b>4</b> Tryck på lur på-knappen för att lägga på eller sätt tillbaka handenheten i basenheten.</li> </ol>  |

## Konferenssamtal

Du kan prata med 2 handenheter och en extern linje samtidigt.

Under ett externt samtal:

INT





INT



**1** Tryck på den vänstra INT-knappen.

Skärmen visar ”Handenhet \_”.

**2** Ange det interna numret till den handenhet du vill ringa till.

Din externa samtalspartner parkeras.

**3** När den interna samtalspartnern svarar, välj ”Konf.”.

ELLER

**3** Om den interna samtalspartnern inte svarar, tryck på den vänstra INT-knappen för att återta det externa samtalet.

**4** Tryck på lur på-knappen för att lägga på eller sätt tillbaka handenheten i basenheten.

## Ta emot ett externt samtal under en intern kommunikation

När du har intern kommunikation med en annan handenhet, kan du fortfarande ta emot externa samtal.

För att ta ett inkommande samtal:



**1** Tryck på lur på-knappen. Den interna kommunikationen avbryts.

**2** Tryck på lur av-knappen. Du kommunicerar nu med den som ringde utifrån.

## 10 Felsökning

Fel	Möjlig orsak	Lösning
Ingen display	Batterierna är urladdade	Kontrollera batteriernas läge
		Ladda batterierna
	Handenheten är avstängd	Ställ in handenheten på TILL
Ingen ton	Telefonsladden är dåligt ansluten	Kontrollera anslutningen av telefonsladden
	Linjen används av en annan handenhet	Vänta tills den andra handenheten lägger på
Ikonen  blinkar	Handenheten är utom räckvidd	Flytta handenheten närmare basen
	Basen har ingen strömförsörjning	Kontrollera att basen är ansluten till elnätet
	Handenheten är inte registrerad till basen	Registrera handenheten till basen
Basen eller handenheten ringer inte	Ringvolymen är avstängd eller låg	Justera ringvolymen
Det är inte möjligt att överföra ett samtal på PABX	Paustiden är för kort eller för lång	Ändra paustiden
Telefonen reagerar inte när du trycker på knapparna	Fel användning	Ta bort batterierna och sätt tillbaka dem på sin plats



## 11 Tekniska data Tekniska kännetecken

Standard	<b>DECT (Digital Enhanced Cordless Telecommunications)</b> <b>GAP (Generic Access Profile)</b>
Frekvensomfång	1880 MHz till 1900 MHz
Antal kanaler	120 duplexkanaler
Modulering	GFSK
Talkodning	32 kbit/s
Utsläppsenergi	10 mW (medelenergi per kanal)
Räckvidd	300 m i öppen miljö/50 m max inomhus
Antal handenheter	Upp till 4
Basens strömförsörjning	230V / 50 Hz / 6V DC 300mA
Handenhetens batterier:	2 laddningsbara batterier AAA, NiMh 1,2V, 700mA
Handenhetens varaktighet	110 timmar i vänteläge
Handenhetens samtalstid	11 timmar
Normala användarförhållanden	+5 °C till +45 °C
Uppringningsläge	Puls/Signal
Paustid	100 eller 250 ms

## 12 Garanti

### 12.1 Garantiperiod

Garantiperioden på Topcoms produkter omfattar 24 månader. Garantiperioden startar den dag då en ny apparat inhandlas. Garantin på batterier begränsas till 6 månader efter inköp.

Förbrukningsdelar eller defekter som orsakar en försumbar effekt på apparatens funktion eller värde, täcks inte.

Garantianspråk kräver uppvisande av inköpskvitto i original, där inköpsdatum och produktmodell ska framgå.

### 12.2 Garantiregler

En felaktig produkt måste returneras till ett av Topcoms servicecentrer tillsammans med ett giltigt inköpskvitto.

Om ett fel uppstår på produkten under garantiperioden reparerar Topcom eller dess officiellt förordnade servicecenter utan kostnad alla defekter som orsakats av material- eller tillverkningsfel.

Topcom uppfyller efter eget gottfinnande sina garantiåtaganden genom att antingen reparera eller byta ut den felaktiga produkten eller delar av den felaktiga produkten. Vid händelse av byte, kan färg eller modell skilja sig från den ursprungligen köpta apparaten.

Det ursprungliga inköpsdatumet ska avgöra starten på garantitiden. Garantiperioden förlängs inte om produkten byts ut eller repareras av Topcom eller dess förordnade servicecentrer.

### 12.3 Garantiundantag

Skador eller defekter orsakade av felaktig hantering eller användning och skador till följd av användning av icke originaldelar eller tillbehör som inte rekommenderats av Topcom omfattas inte av garantin.

Topcom trådlösa telefoner är utformade för att endast fungera med uppladdningsbara batterier. Garantin omfattar inte skador som uppkommer till följd av att icke uppladdningsbara batterier används.

Garantin täcker inte skada orsakad av yttre faktorer som blixtnedslag, vatten och eld eller annan skada orsakad under transport.

Ingen garanti kan krävas om serienumret på apparaten har ändrats, avlägsnats eller gjorts oläsligt. Alla garantianspråk blir ogiltiga om enheten har reparerats, ändrats eller modifierats av köparen eller av okvalificerade, icke officiellt utsedda Topcom servicecenter.

## 13 Avyttring av apparaten (miljö)



I slutet av produktens livscykel, ska du inte kasta den här produkten i de vanliga hushållssoporna utan lämna den på en avfallsstation för återvinning av elektronisk utrustning. Symbolen på produkten, bruksanvisningen och/eller förpackningen anger detta.

Vissa av apparatens material kan återanvändas om du tar den till ett återvinningsställe. Genom att återanvända vissa delar eller råmaterial från använda produkter, kan du göra en betydande insats för att skydda miljön.

Var vänlig kontakta dina lokala myndigheter för mer information om insamlingsställen i ditt område.

## 14 Rengöring

Rengör telefonen med en lätt fuktad duk eller med en antistatisk duk. Använd aldrig rengöringsmedel eller frätande lösningsmedel.

## 15 ECO-läge (lågstrålande)

- Den här sladdlösa telefonen (som överensstämmer med DECT-standard) underlättar användning med låg strålning.
- Strålningsintensiteten hos radiosignalen mellan basenheten och handenhetsen har reducerats till ett minimum när handenhetsen sitter i basenheten.
- Det är endast när handenhetsen avlägsnas från basenheten eller när ett samtal tas emot som strålningsintensiteten hos radiosignalen ökar till normal styrka.
- Detta innebär inte att normal DECT-strålning är skadlig för hälsan.
- Det lågstrålande läget förhindrar onödig DECT-strålning när ingen kommunikation krävs mellan basenheten och handenhetsen.
- Av tekniska skäl går det inte att använda några ytterligare handenheter i lågstrålande läge (en ytterligare handenhet som inte befinner sig i basenhetens omedelbara närhet skulle hela tiden "söka efter basenheten" på grund av den svaga radiosignalen).
- Lågstrålande läge har aktiverats i fabriksinställningarna.
- Lågstrålande läge inaktiveras automatiskt om du loggar in ytterligare en handenhet.
- Lågstrålande läge aktiveras automatiskt igen om du loggar ut alla ytterligare handenheter (endast en handenhet får vara inloggad på basenheten).
- Proceduren för att logga in och ut handenheter förklaras i bruksanvisningen.

## Dansk

### 1 Sikkerhedsanvisninger

- Brug kun det medfølgende opladerstik. Brug ikke andre opladere, da dette kan beskadige battericellerne.
- Isæt kun genopladelige batterier af samme type. Brug aldrig almindelige ikke-genopladelige batterier. Isæt genopladelige batterier, så de har forbindelse til de korrekte poler (fremgår af håndsettets batterikammer).
- Berør ikke opladeren eller stikkets kontakter med skarpe genstande eller metalgenstande.
- Driften af medicinsk udstyr kan blive forstyrret.
- Håndsettet kan forårsage en ubehagelig summende lyd i høreapparater.
- Baseenheden må ikke opstilles i fugtige lokaler og skal placeres mindst 1,5 m væk fra vandhaner o. lign. Håndsettet må ikke komme i kontakt med vand.
- Telefonen må ikke anvendes i områder med eksplosionsfare.
- Batterierne skal bortskaffes, og telefonen skal vedligeholdes på en miljøvenlig-måde.
- Da denne telefon ikke kan bruges i tilfælde af strømsvigt, bør der bruges netstrøm-uaafhængig telefon til nødopkald, f.eks. en mobiltelefon.

### 2 Sådan kommer du i gang

#### 2.1 Sådan anvendes denne brugervejledning

Denne brugervejledning er opbygget på flg. måde:

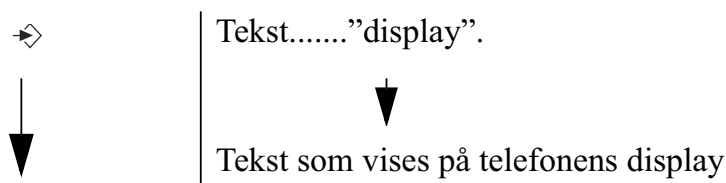

Tast, der skal trykkes på. Denne tast kan være en softkey (Se ”2.4 Taster/Led”). Når denne softkey er et symbol, vises den i venstre kolonne. Når denne softkey er tekst, vises venstre eller højre softkey i venstre kolonne og teksten vises i højre kolonne mellem citationstegnene.

#### 2.2 Sådan installeres basen

For at installere basen skal du foretage følgende:

- 1** Indsæt den ene ende af adapteren i stikket og den anden i adapterstikket bag på basen.
- 2** Sæt den ene ende af telefonledningen i telefonstikket i væggen og den anden ende i bunden af telefonen.
- 3** Indsæt telefon- og vekselstrømsledningen i bunden, som vist på billedet nedenfor.

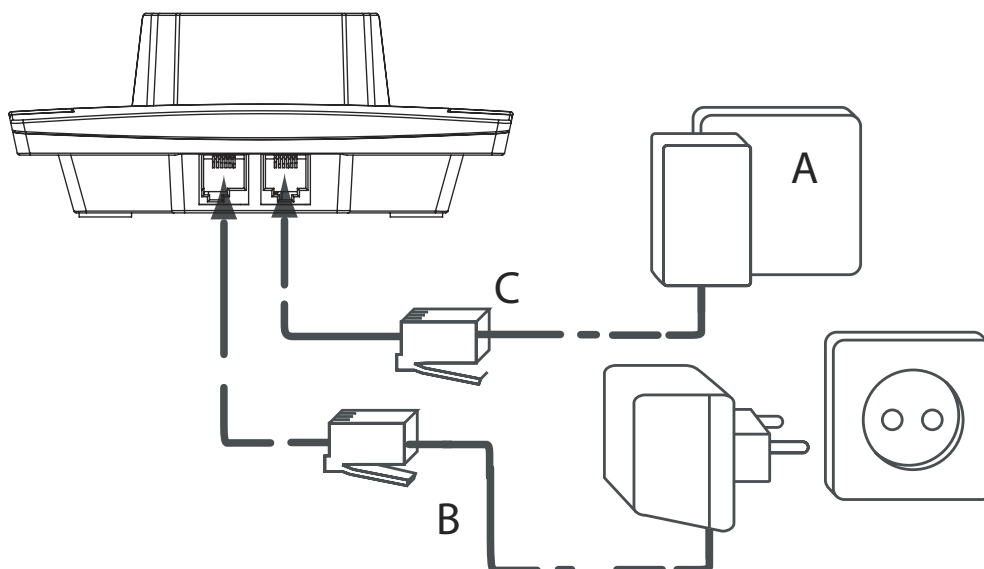

- 2A Basen set bagfra -

A. Telefonstik i væggen

B. Strømledning

C. Telefonledning

### 2.3 Sådan installeres håndsettet

- 1 Åbn batterikammeret som vist på billede 2B.
- 2 Indsæt batterierne i henhold til den viste polaritet (+ og -).
- 3 Luk batterikammeret.
- 4 Efterlad håndsettet i basen i 20 timer. Linje-/ladeniveauindikatoren  på basen lyser.

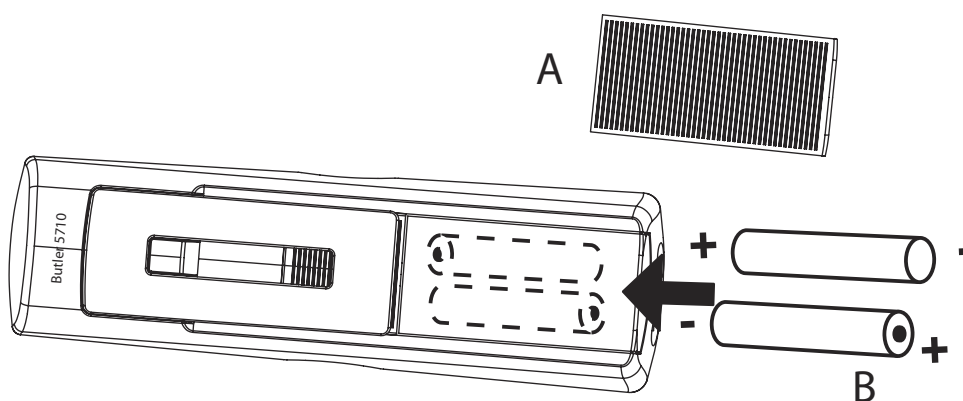

- 2B Håndsettet set bagfra -

A. Dæksel

B. Genopladelige batterier



Før du bruger telefonen første gang, skal du sikre dig, at batteriet er blevet opladet i 20 timer. Hvis du ikke sørger for dette, vil telefonen ikke fungere optimalt.

## 2.4 Taster/Led

### Håndsæt

1. Display
2. Tasten Op/Genopkald
3. Højre menutast
4. Højre/Flash-tast
5. On-hook /Tasten Sluk
6. Alfanumeriske taster
7. Tastatur låst
8. Tasten Sluk ringelyd
9. Ned/Tasten Opkaldsliste
10. Tasten Off-hook/ Håndfri/ Tasten Tænd
11. Venstre/Tasten INT
12. OK-tast
13. Venstre menutast

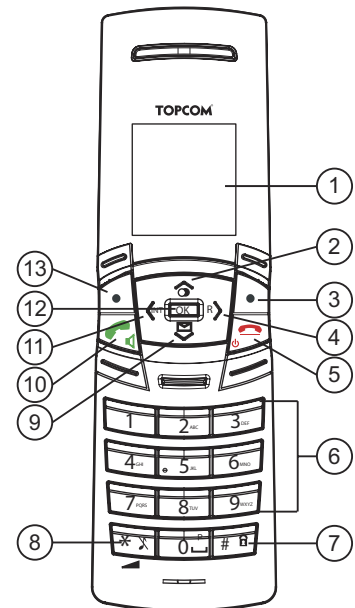

- 2C Håndsæt -





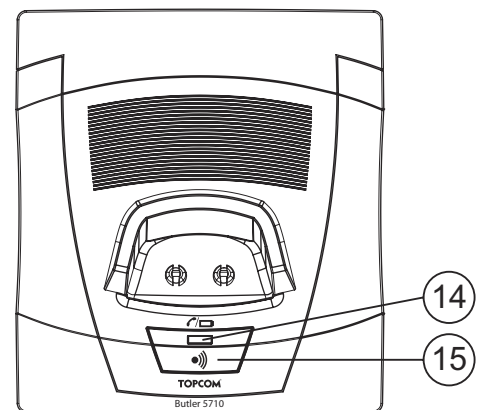









### Base

14. I brug/Strøm/Håndsæt på basen LED
15. Tasten Håndsætssøgning



- 2D Base -

## 2.5 Symboler

	Off hook		Tastatur låst
	On hook		Alarmindstilling
	Ubesvarede opkald i opkaldsliste*		Håndsæt ikke registreret eller uden for rækkevidde
	Sluk håndsætringelyd		Batteri afladt
	Håndsæt inden for rækkevidde		Batteriniveau lavt
	Internt opkald		Batteriniveau medium
	Håndfri		Batteri fuldt opladet
	Ny mobilvarbesked		

\* Hvis Opkalder ID-tjeneste er til rådighed på telefonlinjen.

## 2.6 Display-taster

Display-taster (softkeys) findes lige under displayet. Disse 2 tasters funktion afhænger af betjeningstilstanden. Den faktiske funktion vises som ikon eller tekst direkte over de 2 display-taster.

	Telefonbog		Mute
	OK/Bekræft		Tilbage
	Menu		Ingen tast
	Slet		





## 2.7 Basens LED

LED'en (14) angiver flg. status:



- Sluk: ingen strøm forbundet til basen eller håndsæt ikke i basen til opladning
- Tændt: håndsæt oplader
- Blinker langsomt: Off hook eller ringer
- Blinker hurtigt: under registrering

## 2.8 Navigation af menuen

Butler 5710 har et menusystem, der er nemt at bruge. Hver menu fører til en liste over valgmuligheder. Menuoversigten vises i det følgende afsnit.

- |   |   |
|---|---|
|  | <b>1</b> Når håndsættet er tændt og på standby, skal du trykke på venstre menutast  for at åbne hovedmenuen. |
|  | <b>2</b> Bladr til den ønskede menuvalgmulighed.  |
|  | <b>3</b> Tryk på tasten Soft menu for at se flere valgmuligheder eller for at bekræfte den viste indstilling.   |

### For at afslutte eller gå et niveau tilbage i menuen

- |   |  |
|---|--|
|  | Hvis du vil gå til det foregående niveau på menuen, skal du trykke på tasten Soft menu.                                    |
|  | Hvis du vil annullere eller vende tilbage til standby på et hvilket som helst tidspunkt, skal du trykke på tasten On hook. |

## 2.9 Menuoversigt

Menu	Undermenupunkter
Håndsæt	Ringtone
	Ringevolumen
	Håndsætnavn
	Tastaturlyd
	Kontrast
	Autotalk
	Forkaldsnr.
	Vælg base
	Sprog
	Registrering
Baseindstillinger	Ringtone
	Ringevolumen
	Opkaldstype
	Genkald
Alarm/Tid	System-PIN
	Alarntid
	Dato & Tid
Værktøj	Tidsformat
	Aftale
Sluk	Stopur

## 3 Sådan bruges telefonen

### 3.1 Tænding/slukning af håndsættet



- 1 Tryk, og hold tasten OFF nede for at slukke for håndsættet.
- 2 Tryk på tasten Off-hook, eller sæt håndsættet i basen for at tænde håndsættet igen.

### 3.2 Sådan ændrer du sprog

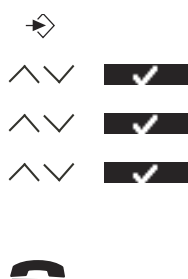

- 1 Gå til menuen.
  - 2 Vælg "Håndsæt", og bekræft.
  - 3 Vælg "Sprog", og bekræft.
  - 4 Vælg et sprog, og bekræft.
- Skærmen viser "Gemt".
- 5 Tryk på tasten On hook for at vende tilbage til standby-tilstand.



◆ *Pilene viser, at flere valgmuligheder er til rådighed.*

### 3.3 Sådan foretages et normalt telefonopkald

#### Direkte opkald



- 1 Tryk på tasten Off hook for ringe op.
- 2 Indtast telefonnummeret.
- 3 Tryk på tasten On hook for at afslutte samtalen, eller sæt håndsættet tilbage i basen.

#### Før-opkald

Med før-opkaldsfunktionen kan du indtaste og ændre et nummer, før du foretager opkaldet.



- 1 Kald et nummer på op til 24 cifre.  
Tryk og hold tasten 0 nede for at indsætte en pause. Skærmen viser et "P".
- 2 Tryk på tasten Soft menu for at rette.
- 3 Tryk på tasten Off hook for ringe op.
- 4 Tryk på tasten On hook for at afslutte samtalen, eller sæt håndsættet tilbage i basen.

#### Genkald et nummer fra listen

Du kan genkalde op til 10 af de sidst kaldte numre. Hvis du har gemt et navn i telefonbogen sammen med nummeret, vil navnet blive vist i stedet.



- 1 Tryk på genkald-tasten.
- 2 Vælg et nummer. Hvis nummeret findes i telefonbogen, vises navnet.
- 3 Tryk på tasten Off hook for ringe op, eller vælg "Vælg".
- 4 Hvis du valgte "Vælg", skal du bladre ned og vælge:  
"Slet opkald": for at fjerne nummeret fra opkaldslisten;  
"Gem nummer": for at gemme nummeret i telefonbogen;  
"Slet alle": for at slette opkaldslisten
- 5 Bekræft dit valg.
- 6 Tryk på tasten On hook for at vende tilbage til standby-tilstand.

### 3.4 Sådan modtages et telefonopkald

Når du modtager et eksternt opkald, viser skærmen "Eksternt opkald".

Sådan besvares opkaldet:



- 1 Tryk på tasten Off hook.  
ELLER  
Løft håndsættet fra basen, hvis "Autotalk" er aktiveret  
(Se "6.5 Autotalk")  
Ikonet Opkald i gang vises på skærmen. Opkaldets varighed vises efter 15 sekunder.
- 2 Tryk på tasten On hook for at afslutte samtalen, eller sæt håndsættet tilbage i basen.



*Du kan slukke for ringevolumenen under indgående opkald ved at vælge "Stille".*



### 3.5 Tilstanden Håndfri

Håndfri giver dig mulighed for at tale med opkalderen uden at holde håndsættet. Det giver også andre i lokalet mulighed for at lytte til begge sider af din samtale.



- 1 Hvis du vil skifte til håndfri under et opkald, skal du trykke på tasten Håndfri under opkaldet.

### 3.6 Juster ørestykke/håndfrivolumen



- 1 Tryk op eller ned for at vælge volumen 1-5 under et normalt eller håndfrit opkald.

### 3.7 Hemmelighedsfunktion (funktionen Slå lyd fra)

Under en samtale kan du slukke for mikrofonen, så personen på den anden ende af linjen ikke kan høre dig.



- 1 Tryk på tasten Soft menu for at deaktivere mikrofonen.  
”Mute til” vises på skærmen.



- 2 Vælg ”Sluk” for at aktivere mikrofonen igen.

### 3.8 Lokalisering af håndsættet (funktionen Håndsætsøgning)



- 1 Tryk på tasten til håndsætsøgning på basen.  
Alle håndsæt, der er registreret på basen, vil ringe i 30 sekunder.



- 2 Tryk på en vilkårlig tast for at afbryde håndsættets søgen.

### 3.9 Tastlås

Du kan låse tastaturet for at forhindre utilsigtet opkald, når du bærer rundt på håndsættet.

I standby-tilstand:



- 1 Tryk og hold tasten Tastlås nede (tast 7 - billed 2C), indtil Låst og ikonet Tastlås vises på skærmen.



- 2 Hvis du vil låse op igen, skal du vælge ”Lås” op efterfulgt af tasten Tastlås.

### 3.10 Sådan bruges det alfanumeriske tastatur

Du kan også indtaste alfanumeriske tegn med din telefon. Dette er nyttigt, hvis du vil indtaste et navn i telefonbogen, give håndsættet et navn,...





Hvis du vil vælge et bogstav, skal du trykke på den tilsvarende tast så mange gange som nødvendigt.

F.eks. for at vælge et ‘A’ skal du trykke ‘2’ en gang. For at vælge et ‘B’ skal du trykke ‘2’ to gange og så videre.

For at vælge ‘A’ og derefter ‘B’ i rækkefølge skal du trykke på ‘2’ en gang, vente, indtil markøren flytter til det næste tegn, og derefter trykke ‘2’ to gange.

Under indtastning af tekst vises det aktuelle tegn under hver tast nederst på skærmen.











Du kan ændre indtastningstegnsættet fra engelsk (abc) til latinsk (aåá), græsk (ΑΒΓ) eller russisk (АВВ) ved at trykke på #-tasten og holde den nede i 2 sekunder.

	Tryk '0' for at vælge et mellemrum.
	Tryk på tasten * for at skifte imellem små og store bogstaver.
	Tryk og hold tasten # nede i 2 sekunder for at ændre inputtegnsettet.
	Tryk på tasten Soft menu for at rette.





## 4 Telefonbog

Hvert håndsæt kan lagre op til 200 navne og numre. Navne kan være på op til 16 tegn og numre op til 24 cifre.







### 4.1 Sådan tilføjes et punkt

	<b>1</b> Tryk på tasten Soft menu.
	Hvis telefonbogen er tom, vises "Telefonbog tom" på skærmen. Hvis navnene er lagret, vises de på listen.
 	<b>2</b> Vælg "Vælg".
 	<b>3</b> Vælg "Ny kontakt", og bekræft.
 	<b>4</b> Brug tastaturet til at indtaste navnet, og vælg derefter "Gem".
 	<b>5</b> Brug tastaturet til at indtaste nummeret, og vælg derefter "Gem".
	<b>6</b> Vælg den ønskede ringemelodi, og vælg derefter "Gem".
	<b>7</b> Vend tilbage til standby.











### 4.2 Sådan ringes der op til en kontakt

	<b>1</b> Tryk på tasten Soft menu.
	<b>2</b> Vælg det ønskede navn, eller brug tastaturet til at indtaste navnets første bogstav.
	<b>3</b> Tryk på tasten Off hook for ringe op.
	<b>4</b> Vend tilbage til standby.











### 4.3 Vis detaljer

	<b>1</b> Tryk på tasten Soft menu.
	<b>2</b> Vælg det ønskede navn, eller brug tastaturet til at indtaste navnets første bogstav.
	<b>3</b> Vælg "Vælg".
 	<b>4</b> Vælg "Vis detaljer" og bekræft.
	Navnet, nummeret og ringemelodien, som du har tilknyttet punktet, vises på skærmen.
	<b>5</b> Vend tilbage til standby.











#### 4.4 Slet en eller alle kontakter

- |   |   |
|---|---|
|    | <b>1</b> Tryk på tasten Soft menu.  |
|    | <b>2</b> Vælg det ønskede navn, eller brug tastaturet til at indtaste navnets første bogstav. |
|    | <b>3</b> Vælg "Vælg".   |
| Hvis du vil slette en kontakt:  |   |
|   | <b>4</b> Vælg "Slet kontakt", og bekræft.   |
| Hvis du vil slette alle kontakter:  |   |
|   | <b>4</b> Vælg "Slet alle", og bekræft.  |
|   | <b>5</b> Tryk på højre menutast for at bekræfte eller venstre menutast for at annullere.      |
|    | <b>6</b> Vend tilbage til standby.  |

#### 4.5 Rediger navn og nummer

- |   |   |
|---|---|
|    | <b>1</b> Tryk på tasten Soft menu.  |
|    | <b>2</b> Vælg det ønskede navn, eller brug tastaturet til at indtaste navnets første bogstav. |
|    | <b>3</b> Vælg "Vælg".   |
|     | <b>4</b> Vælg "Rediger kontakt", og bekræft.  |
|    | <b>5</b> Tryk på tasten Soft menu for at slette, og brug tastaturet til at ændre navnet.      |
|    | <b>6</b> Vælg "Gem".  |
|    | <b>7</b> Rediger nummeret, og vælg "Gem".   |
|   | <b>8</b> Vælg den ønskede ringemelodi, og vælg derefter "Gem".                                |
|    | <b>9</b> Vend tilbage til standby.  |

#### 4.6 Kopier et telefonbogspunkt til et andet håndsæt

- |   |  |
|---|--|
|    | <b>1</b> Tryk på tasten Soft menu.   |
|    | <b>2</b> Vælg det ønskede navn, eller brug tastaturet til at indtaste navnets første bogstav.                            |
|    | <b>3</b> Vælg "Vælg".  |
|   | <b>4</b> Vælg "Kopier kontakt", og bekræft.  |
| De aktuelle håndsæt (alle de håndsæt, der er registreret på basen) vises.   |  |
|   | <b>5</b> Vælg det ønskede håndsæt, og bekræft.   |
| "Kopierer til håndsæt x" vises på skærmen.  |  |
| "Accepter kontaktperson?" vises på skærmen på destinationshåndsættet.   |  |
|   | <b>6</b> På destinationshåndsættet trykkes på højre menutast for at bekræfte eller på venstre menutast for at annullere. |
|    | <b>7</b> Vend tilbage til standby.   |

## 4.7 Kopier alle telefonbogskontakter til et andet håndsæt



Ved at kopiere alle punkter fra et håndsæt til et andet sletter du de eksisterende kontakter på destinationshåndsættet.



- 1** Tryk på tasten Soft menu.
- 2** Vælg det ønskede navn, eller brug tastaturet til at indtaste navnets første bogstav.
- 3** Vælg "Vælg".
- 4** Vælg "Kopier alle", og bekræft.  
De aktuelle håndsæt (alle de håndsæt, der er registreret på basen) vises.
- 5** Vælg det ønskede håndsæt, og bekræft.  
"Kopierer til håndsæt x" vises på skærmen.  
"Erstat alle kontaktpersoner?" vises på skærmen på destinationshåndsættet.
- 6** På destinationshåndsættet trykkes på højre menutast for at bekræfte eller venstre menutast for at annullere.
- 7** Vend tilbage til standby.

## 5 Nummerviser

### 5.1 Normale, indgående PSTN-opkald



Denne tjeneste fungerer kun, hvis du har et nummerviser-/Clip-abonnement. Kontakt venligst din telefonudbyder.

Når du modtager et opkald fra din faste telefonlinje, vises opkalderens telefonnummer på håndsættets skærm. Telefonen kan modtage opkald i både FSK og DTMF. Du kan også se opkalderens navn, hvis dette transmitteres af netværket. Hvis navnet er programmeret ind i telefonbogen, vises navnet i telefonbogen!

Telefonen kan lagre 30 opkald i Opkaldslisten (modtaget og ubesvaret), som kan gennemses senere. Når hukommelsen er fuld, erstatter nye opkald automatisk de ældste opkald i hukommelsen.













Ubesvarede opkald signaleres ved et blinkende ikon på skærmen. Håndsættets navn erstattes af dette ikon og antal ubesvarede opkald.

### Sådan aflæses de modtagne opkald



- 1** Tryk på knappen Ned.  
Listen over Modtagne opkald vises på skærmen. Dette er en kombination af modtagne og ubesvarede opkald.
- 2** Vælg det ønskede navn eller nummer.
- 3** Tryk på tasten Off hook for ringe op.  
ELLER  
Vælg "Vælg".  
Hvis du vil slette en kontakt:
- 4** Vælg "Slet opkald", og bekræft.











- |   |  |
|---|--|
|    | <b>5</b> Vend tilbage til standby.   |
|   | Hvis du vil slette alle kontakter:   |
|   | <b>5</b> Vælg ”Slet alle”, og bekræft.                                     |
|    | <b>6</b> Vend tilbage til standby.   |
|   | Sådan tilføjes et nummer til telefonbogen:                                 |
|   | <b>5</b> Vælg ”Gem nummer”, og bekræft.                                    |
|    | <b>6</b> Brug tastaturet til at indtaste navnet, og vælg derefter ”Gem”.   |
|    | <b>7</b> Brug tastaturet til at redigere nummeret, og vælg derefter ”Gem”. |
|   | <b>8</b> Vælg den ønskede ringemelodi, og vælg derefter ”Gem”.             |
|    | <b>9</b> Vend tilbage til standby.   |

## 6 Personalisér håndsettet

### 6.1 Ringetone og volumen









#### Ringetone

Du kan vælge mellem 18 forskellige ringemelodier til interne og eksterne opkald.

- |   |   |
|---|---|
|    | <b>1</b> Gå til menuen.   |
|       | <b>2</b> Vælg ”Håndsat”, og bekræft.  |
|   | <b>3</b> Vælg ”Ringetone”, og bekræft.  |
|   | <b>4</b> Vælg ”Ekstern” for eksterne opkald eller vælg ”Intern” for interne opkald, og bekræft. |
|   | <b>5</b> Vælg den ønskede melodi, og bekræft.   |
|   | Under bladring afspilles et eksempel.   |
|    | <b>6</b> Vend tilbage til standby.  |









#### Ringevolumen

Du kan vælge imellem fem ringevolumenniveauer på håndsettet og slået fra.









- |   |  |
|---|--|
|    | <b>1</b> Gå til menuen.                              |
|   | <b>2</b> Vælg ”Håndsat”, og bekræft.                 |
|   | <b>3</b> Vælg ”Ringestyrke”, og bekræft.             |
|   | Den aktuelle indstilling vises.                      |
|    | <b>4</b> Tryk på tasten Op for at øge volumen.       |
|    | <b>5</b> Tryk på tasten Ned for at reducere volumen. |
|    | <b>6</b> Vælg ”Gem” for at bekræfte.                 |
|    | <b>7</b> Vend tilbage til standby.                   |

## 6.2 Håndsetnavn









Du kan ændre det navn, der vises på håndsettet under standby (maksx. 9 tegn).

- |   |   |
|---|---|
|    | <b>1</b> Gå til menuen.                         |
|   | <b>2</b> Vælg "Håndset", og bekræft.            |
|   | <b>3</b> Vælg "Håndset navn", og bekræft.       |
|    | <b>4</b> Indtast det navn, du vil have.         |
|    | <b>5</b> Tryk på tasten Soft menu for at rette. |
|    | <b>6</b> Vælg "Gem" for at bekræfte.            |
|    | <b>7</b> Vend tilbage til standby.              |

## 6.3 Tastaturlyd









- |   |  |
|---|--|
|    | <b>1</b> Gå til menuen.                      |
|   | <b>2</b> Vælg "Håndset", og bekræft.         |
|   | <b>3</b> Vælg "Tastatur lyd", og bekræft.    |
|   | <b>4</b> Vælg "Til" eller "Fra", og bekræft. |
|    | <b>5</b> Vend tilbage til standby.           |

## 6.4 Sådan indstilles kontrasten

- |   |  |
|---|--|
|    | <b>1</b> Gå til menuen.                                    |
|   | <b>2</b> Vælg "Håndset", og bekræft.                       |
|   | <b>3</b> Vælg "Kontrast", og bekræft.                      |
|   | <b>4</b> Vælg den kontrast, du vil have (1-8), og bekræft. |
|    | <b>5</b> Vend tilbage til standby.                         |







## 6.5 Autotalk







Når der er et indgående opkald og håndsettet er i basen, tager telefonen automatisk linjen, når den løftes fra basen. Denne funktion kan slås til eller fra.

- |   |  |
|---|--|
|    | <b>1</b> Gå til menuen.                      |
|   | <b>2</b> Vælg "Håndset", og bekræft.         |
|   | <b>3</b> Vælg "Autotalk", og bekræft.        |
|   | <b>4</b> Vælg "Til" eller "Fra", og bekræft. |
|    | <b>5</b> Vend tilbage til standby.           |

## 6.6 Præfikskode

Det er muligt at bruge din telefon med et præfiksnummer. Når du indtaster telefonnumre, kan du automatisk tilføje præfikskoden før nummeret.















- |   |  |
|---|--|
|    | <b>1</b> Gå til menuen.                  |
|   | <b>2</b> Vælg "Håndset", og bekræft.     |
|   | <b>3</b> Vælg "Forkaldsnr.", og bekræft. |
|   | <b>4</b> Vælg "Rediger", og bekræft.     |

- |   |   |  |
|---|---|--|
|  |  | <b>5</b> Indtast Forkaldsnr.-koden, f.eks. '0', og vælg "Gem". |
|   |   | ELLER  |
|  |  | <b>4</b> Vælg "Til/Fra", og bekræft.                           |
|  |  | <b>5</b> Vælg "Til" eller "Fra", og bekræft.                   |
|  |   | <b>6</b> Vend tilbage til standby.                             |









## 6.7 Sådan bruges alarmfunktionen

Du kan have forskellige alarmindstillinger til hvert håndsat, der er registreret på din base. Alarmen ringer kun på det pågældende håndsat ikke på basen eller på et andet håndsat.









### Indstil alarmen

- |   |   |  |
|---|---|--|
|    |   | <b>1</b> Gå til menuen.  |
|    |    | <b>2</b> Vælg "Alarm/Tid", og bekræft.   |
|    |    | <b>3</b> Vælg "Alarmtid", og bekræft.  |
|    |    | <b>4</b> Vælg "En gang", "Dagligt", "Man til fre" eller "Fra", og bekræft.<br>Hvis du har valgt En gang, Dagligt eller Man til fre, vil skærmen vise:<br>Tid:<br>00:00 |
|    |    | <b>5</b> Indtast den tid, du vil have telefonen skal ringe, og bekræft med "Gem".  |
|  |  | <b>6</b> Vælg den ønskede ringetone, og bekræft med "Gem".   |
|  |  | <b>7</b> Hvis du vil deaktivere alarmen, skal du vælge "Fra", og bekræfte.   |
|  |   | <b>8</b> Vend tilbage til den foregående menu.   |

## 6.8 Indstilling af dato og tid

- |   |   |  |
|---|---|--|
|  |   | <b>1</b> Gå til menuen.  |
|  |  | <b>2</b> Vælg "Alarm/Tid", og bekræft.   |
|  |  | <b>3</b> Vælg "Dato & Tid", og bekræft.  |
|  |  | <b>4</b> Indtast år, måned, dag, tid og minutter, og vælg "Gem" for at bekræfte. |
|  |   | <b>5</b> Vend tilbage til den foregående menu.                                   |









## 6.9 Indstilling af tidsformat

- |   |   |  |
|---|---|--|
|  |   | <b>1</b> Gå til menuen.                                |
|  |  | <b>2</b> Vælg "Alarm/Tid", og bekræft.                 |
|  |  | <b>3</b> Vælg "Tidsformat", og bekræft.                |
|  |  | <b>4</b> Vælg "12 timer" eller "24 timer", og bekræft. |
|  |   | <b>5</b> Vend tilbage til den foregående menu.         |

## 7 Baseindstillinger









### 7.1 Ringetone

Du kan vælge imellem 9 forskellige ringemelodier.

- |   |  |
|---|--|
|    | <b>1</b> Gå til menuen.                        |
|   | <b>2</b> Vælg "Baseindstillinger", og bekræft. |
|   | <b>3</b> Vælg "Ringetone", og bekræft.         |
|   | <b>4</b> Vælg den ønskede melodi, og bekræft.  |
|   | Under bladring afspilles et eksempel.          |
|    | <b>5</b> Vend tilbage til standby.             |

### 7.2 Ringe volumen

Du kan vælge imellem 5 ringevolumenniveauer på håndsættet.









- |   |  |
|---|--|
|    | <b>1</b> Gå til menuen.                              |
|   | <b>2</b> Vælg "Baseindstillinger", og bekræft.       |
|   | <b>3</b> Vælg "Ringe volumen", og bekræft.           |
|   | Den aktuelle indstilling vises.                      |
|    | <b>4</b> Tryk på tasten Op for at øge volumen.       |
|    | <b>5</b> Tryk på tasten Ned for at reducere volumen. |
|    | <b>6</b> Vælg "Gem" for at bekræfte.                 |
|    | <b>7</b> Vend tilbage til standby.                   |

### 7.3 Opkaldstilstand

Der er to typer opkaldstilstande:





- DTMF/tone-opkald (mest almindelig)
- Impulsopkald (til ældre installationer)

Sådan skiftes opkaldstilstand:

- |   |   |
|---|---|
|    | <b>1</b> Gå til menuen.                           |
|   | <b>2</b> Vælg "Baseindstillinger", og bekræft.    |
|   | <b>3</b> Vælg "Opkaldstype", og bekræft.          |
|   | <b>4</b> Vælg "Tone" eller "Puls", og vælg "Gem". |
|    | <b>5</b> Vend tilbage til standby.                |

### 7.4 Vælg (Flash)

Tryk Flash-tast "R" (Tast 4 - billede 2C) for at bruge bestemte tjenester på din eksterne linje, såsom "ventende opkald" (hvis dit telefonselskab udbyder denne tjeneste); eller til at viderestille opkald, hvis du vil bruge telefonomstilling (PABX). Flash-tasten "R" er en kort afbrydelse af linjen. Du kan indstille flashtiden til 100ms eller 250ms.

- |   |  |
|---|--|
|    | <b>1</b> Gå til menuen.                        |
|   | <b>2</b> Vælg "Baseindstillinger", og bekræft. |
|   | <b>3</b> Vælg "Genkald", og bekræft.           |





- 4** Vælg kort flashtid (100ms) eller lang flashtid (250ms), og vælg Gem.
- 5** Vend tilbage til standby.

## 7.5 System-PIN

System-PIN bruges til registrering og afregistrering af håndsæt og andre valgfrie indstillinger. Standard system-PIN-koden er 0000.



- 1** Gå til menuen.
- 2** Vælg "Baseindstillinger", og bekræft.
- 3** Vælg "System-PIN", og bekræft.
- 4** Indtast gammel PIN (0000 som standard), og vælg "Gem".
- 5** Indtast den nye PIN, vælg "Gem" og gentag dette.
- 6** Vend tilbage til standby.

## 8 Værktøj

### 8.1 Aftale

Du kan indstille 5 aftaler eller påmindelser, som du kan give et navn og en dato- eller tidsalarm.



- 1** Gå til menuen.
  - 2** Vælg "Værktøj", og bekræft.
  - 3** Vælg "Aftaler", og bekræft.
  - 4** Vælg en af de 5 aftaler, og vælg "Vælg".
- Sådan redigeres aftalen:
- 5** Vælg "Rediger", og bekræft.
  - 6** Rediger aftalens navn, og vælg "Gem".
  - 7** Rediger aftalens dato, og vælg "Gem".
  - 8** Rediger tiden, og vælg "Gem".
  - 9** Vælg den ønskede alarmmelodi, og vælg derefter "Gem".
  - 10** Vend tilbage til standby.

Sådan slettes aftalen:



- 5** Vælg "Slet", og bekræft.
- 6** Tryk på tasten Soft menu til højre for at bekræfte.
- 7** Tryk på tasten Soft menu til venstre for at gå tilbage.
- 8** Vend tilbage til standby.

### 8.2 Stopur



- 1** Gå til menuen.
- 2** Vælg "Værktøj", og bekræft.
- 3** Vælg "Stopur", og bekræft.
- 4** Vælg "Start" for at starte stopuret.
- 5** Vælg "Stop" for at stoppe stopuret.



- Vælg "Start" igen for at genstarte.
- Vælg "Nulstil" for at nulstille tælleren.
- 6** Vend tilbage til standby.

## 9 Yderligere håndsat og basestationer

Der kan knyttes op til 4 håndsat til hver base. Hvert håndsat kan registrere op til 4 basestationer, og brugeren kan vælge den ønskede base.

### 9.1 Sådan tilføjes et nyt håndsat



*Behøves kun, når du har afregistreret et håndsat, eller når du køber et nyt.*

Sådan sættes basen i registreringstilstand:



- 1** Tryk, og hold tasten nede til håndsatetsøgning på basen.
- LED på baseenheden starter med at blinke på basen i 90 sekunder. I disse 90 sekunder er basen klar til registrering.

På håndsettet:

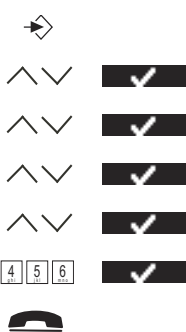

- 1** Gå til menuen.
- 2** Vælg "Håndsat", og bekræft.
- 3** Vælg "Registrering", og bekræft.
- 4** Vælg "Registrer", og bekræft.
- 5** Vælg nummeret på basen, der skal tilknyttes håndsettet (1-4), og bekræft.
- 6** Indtast system-PIN-koden (0000 som standard), og bekræft.
- 7** Vend tilbage til standby.

### 9.2 Sådan fjernes et håndsat



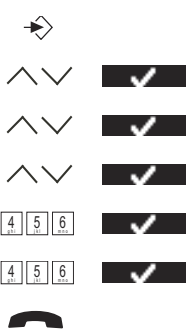





Denne fremgangsmåde skal udføres på et andet håndsat end det, du vil afinstallere.



- 1** Gå til menuen.
- 2** Vælg "Håndsat", og bekræft.
- 3** Vælg "Registrering", og bekræft.
- 4** Vælg "Afregistrer", og bekræft.
- 5** Indtast system-PIN-koden (0000 som standard), og bekræft.
- 6** Indtast det håndsatnummer, der skal fjernes, og bekræft.
- 7** Vend tilbage til standby.

### 9.3 Vælg en basen

Dine håndsat kan skiftes imellem basen. Du kan også indstille håndsettet til automatisk at vælge basen med det stærkeste signal. Håndsettet skal først registreres individuelt med hver base.



- |   |   |
|---|---|
|    | <b>1</b> Gå til menuen.   |
|   | <b>2</b> Vælg "Håndsat", og bekræft.                                |
|   | <b>3</b> Vælg "Vælg base", og bekræft.                              |
|   | <b>4</b> Vælg "Manuel" eller "Auto", og bekræft.                    |
|   | Hvis du har valgt "Manuel":   |
|   | <b>5</b> Vælg den base, der skal tilknyttes håndsettet, og bekræft. |



Når du har aktiveret Automatisk basevalg, og håndsettet er uden for rækkevidde på den aktuelle base, vil håndsettet kun søge efter den stærkeste base i standby (ikke under kommunikation).



### 9.4 Sådan bruges samtaleanlægsfunktionen

#### Sådan ringer du til et internt håndsat

- |   |   |
|---|---|
| INT   | <b>1</b> Tryk på venstre tast INT.  |
|  | Skærmen viser "Håndsat _".  |
|  | <b>2</b> Indtast det interne nummer på det håndsat, du vil ringe til.                           |
|   | <b>3</b> Tryk på tasten On hook for at afslutte samtalen, eller sæt håndsettet tilbage i basen. |

#### Viderestil et eksternt opkald til et andet håndsat

Under et eksternt opkald:



- |   |  |
|---|--|
| INT   | <b>1</b> Tryk på venstre tast INT.   |
|  | Skærmen viser "Håndsat _".   |
|  | <b>2</b> Indtast det interne nummer på det håndsat, du vil ringe til.  |
|   | Din eksterne samtale placeres i kø.  |
|   | <b>3</b> Når det interne opkald besvares, skal du trykke på tasten On hook for at viderestille opkaldet.   |
|   | ELLER  |
| INT   | <b>3</b> Hvis det interne opkald ikke besvares, skal du trykke på venstre tast INT for at hente den eksterne samtale eller skifte fra den ene til den anden. |
|  | <b>4</b> Tryk på tasten On hook for at afslutte samtalen, eller sæt håndsettet tilbage i basen.  |

#### Konferenceopkald

Du kan tale mellem 2 håndsat og en ekstern linje på samme tid.

Under et eksternt opkald:

- |   |   |
|---|---|
| INT   | <b>1</b> Tryk på venstre tast INT.                                    |
|  | Skærmen viser "Håndsat _".  |
|   | <b>2</b> Indtast det interne nummer på det håndsat, du vil ringe til. |

-  Din eksterne samtale placeres i kø.
- 3** Når det interne opkald besvares, skal du vælge ”Konf”.
- ELLER
- 3** Hvis det interne opkald ikke besvares, skal du trykke på venstre tast INT for at hente den eksterne samtale.
-  **4** Tryk på tasten On hook for at afslutte samtalen, eller sæt håndsettet tilbage i basen.

### Sådan besvares et eksternt opkald under intern kommunikation

Når du er på samtaleanlægget med et andet håndsat, kan du stadig besvare eksterne opkald.

Sådan besvares et indgående opkald:



- 1** Tryk på tasten On hook. Den interne kommunikation afbrydes nu.
- 2** Tryk på tasten Off hook. Du kommunikerer nu med den eksterne opkalder.

## 10 Fejlsøgning

Symptom	Mulig årsag	Løsning
Tom skærm	Batterierne er afladte	Kontrollér batteriernes position
		Genoplad batterierne
	Håndsat slukket	Tænd håndsettet (ON)
Ingen tone	Telefonledning tilsluttet forkert	Kontrollér tilslutningen af telefonledningen
	Linjen er optaget af et andet håndsat	Vent, indtil det andet håndsat lægger på
Ikonet  blinker	Håndsat uden for rækkevidde	Flyt håndsettet tættere på basen
	Basen har ingen strømforsyning	Kontrollér strømforsyningen til basen
	Håndsettet er ikke registreret på basen	Registrer håndsettet på basen
Base eller håndsat ringer ikke	Ringelydstyrken er slukket eller indstillet for lavt	Juster ringelydstyrken
Ikke muligt at viderestille opkald på PABX	Flash-tiden er for kort eller for lang	Skift Flash-tid
Telefonen reagerer ikke på tastetryk	Håndteringsfejl	Tag batterierne ud, og sæt dem på plads igen

## 11 Tekniske data Tekniske specifikationer

Standard	<b>DECT (Digital Enhanced Cordless Telecommunications)</b> <b>GAP (Generic Access Profile)</b>
Frekvens	1880 MHz til 1900 MHz
Antal kanaler	120 duplekskanaler
Modulation	GFSK
Talekodning	32 kbit/s
Emissionsstrøm	10 mW (gennemsnitlig strøm pr kanal)
Rækkevidde	300m udendørs /50m maks indendørs
Antal håndsæt	Op til 4
Basestrømforsyning	230V / 50 Hz / 6V DC 300mA
Håndsætbatterier:	2 genopladelige batterier AAA, NiMh 1.2V, 700mA
Håndsæt, driftstid	110 timer i standby
Håndsæt, taletid	11 timer
Normale brugsforhold	+5 °C til +45 °C
Opkaldstilstand	Impuls / Tone
Flash-tid	100 eller 250 ms

## 12 Garanti

### 12.1 Garantiperiode

Der er 24 måneders garanti på Topcom-enhederne. Garantiperioden starter den dag, hvor den nye enhed købes. Garantien på batterierne er begrænset til 6 måneder efter købet. Forbrugsvarer og fejl, der har ubetydelig indvirkning på udstyrets funktion eller værdi, dækkes ikke.

Garantien skal bevises ved fremlæggelse af den originale kvittering for købet, hvoraf købsdatoen og enhedsmodellen fremgår.

### 12.2 Håndtering af garantien

En defekt enhed skal returneres til et Topcom-servicecenter sammen med en gyldig kvittering. Hvis der forekommer en fejl i enheden i løbet af garantiperioden, vil Topcom eller det af Topcom officielt udpegede servicecenter gratis reparere evt. fejl, der skyldes materiale- eller fremstillingsfejl.

Topcom vil efter eget skøn opfylde sine garantiforpligtelser enten ved at reparere eller udskifte den defekte enhed eller dele af den defekte enhed. I tilfælde af udskiftning kan farve og model afvige fra den oprindeligt købte enhed.

Den oprindelige købsdato forbliver starten på garantiperioden. Garantiperioden forlænges ikke, såfremt enheden udskiftes eller repareres af Topcom eller det af Topcom udpegede servicecenter.

### 12.3 Undtagelser fra garantien

Skader og fejl, der skyldes forkert behandling eller betjening, og skader, der skyldes brug af uoriginale dele eller tilbehør, der ikke er anbefalet af Topcom, dækkes ikke af garantien.

Topcoms trådløse telefoner er konstrueret til udelukkende at fungere med genopladelige batterier. Skader, der skyldes brug af ikke-genopladelige batterier, dækkes ikke af garantien.

Garantien dækker ikke skader, der skyldes udefra kommende faktorer såsom lynnedslag, vand og brand, eller transportskader.

Der kan ikke fremsættes krav i henhold til garantien, hvis serienummeret på enheden er ændret, fjernet eller gjort ulæseligt.

Evt. anmeldelser i henhold til garantien er ugyldige, hvis enheden er repareret, ændret eller modificeret af køber eller af ikke kvalificerede, ikke officielt udpegede Topcom-servicecentre.

### 13 Bortskaffelse af enheden (miljø)



Når produktet er udtjent, må det ikke kasseres sammen med det almindelige husholdningsaffald, men skal afleveres på et indsamlingssted til genbrug af elektrisk og elektronisk udstyr. Dette angives af symbolet på produktet, brugervejledningen og/eller emballagen.

Nogle af produktets materialer kan genanvendes, hvis de afleveres på en genbrugsstation. Ved genanvendelse af dele eller råstoffer fra brugte produkter kan man yde et vigtigt bidrag til beskyttelse af miljøet.

Kontakt de lokale myndigheder, hvis du har brug for yderligere oplysninger om genbrugsstationerne i dit område.

### 14 Rengøring

Telefonen rengøres med en let fugtig klud eller med en antistatisk klud. Der må aldrig anvendes rengøringsmidler eller slibende opløsningsmidler.

### 15 ECO-tilstand (lavstråling)

- Denne trådløse telefon (overholder DECT-standarden) giver mulighed for drift med lavstråling.
- Strålingsintensiteten i radiosignalet mellem basestationen og håndsættet reduceres til et minimum, når håndsættet er anbragt på basestationen.
- Først når håndsættet fjernes fra basestationen, eller der modtages et opkald, stiger strålingsintensiteten i radiosignalet til den normale styrke.
- Dette betyder ikke, at normal DECT-stråling er sundhedsskadelig.
- Lavstrålingsfunktionen forhindrer overflødig DECT-strålingsbelastning, når der ikke er brug for kommunikation imellem basestationen og håndsættet.
- Af tekniske årsager kan ekstra håndsæt ikke betjenes i lavstrålingstilstand (et ekstra håndsæt, som ikke findes i umiddelbar nærhed af basestationen, vil altid "søge efter basestationen" på grund af det svage radiosignal).
- Lavstrålingstilstanden aktiveres i fabriksindstillingerne.
- Lavstrålingstilstanden deaktiveres automatisk, hvis der logges på med yderligere et håndsæt.
- Lavstrålingstilstanden aktiveres automatisk igen, når samtlige ekstra håndsæt logges af (der må kun være logget ét enkelt håndsæt på basestationen).
- Proceduren for til- og frakobling af håndsæt er beskrevet i brugervejledningen.

## Norsk

### 1 Sikkerhetsinstruksjoner

- Bruk bare den medfølgende ladepluggen. Ikke bruk andre ladere, da dette kan skade battericellene.
- Sett bare inn oppladbare batterier av samme type. Bruk aldri ordinære, ikke-oppladbare batterier. Sett inn oppladbare batterier så de overensstemmer med de riktige terminalene (som merket i batterirommet på håndsettet).
- Ikke berør laderen og ladepluggen med skarpe eller metallgjenstander.
- Funksjonen til enkelte medisinske utstyrsenheter kan bli påvirket.
- Håndsettet kan forårsake en skarp summelyd i høreapparater.
- Basisenheten må ikke plasseres i et fuktig rom, eller på mindre enn 1,5 meters avstand fra en vannkilde. Hold håndsettet unna vann.
- Telefonen skal ikke brukes i omgivelser der det er fare for eksplosjon.
- Kast batteriene som spesialavfall, og vedlikehold telefonen på en miljøvennlig måte.
- Ettersom denne telefonen ikke kan brukes ved et eventuelt strømbrydd, bør du ha en strømuavhengig telefon tilgjengelig for nødansrop - for eksempel en mobiltelefon.

### 2 Komme i gang

#### 2.1 Slik bruker du denne veiledningen

I denne veiledningen brukes følgende metode for å klargjøre instruksjonene:

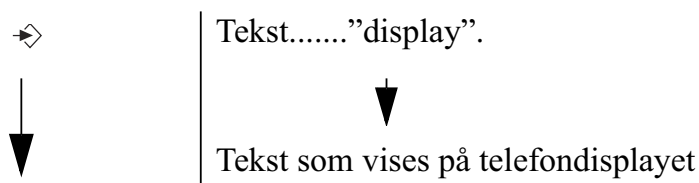

Tastetrykk. Dette kan være en menyttast (Se "2.4 Taster/led-indikator"). Hvis menyttasten er et symbol, vises det i venstre kolonne. Hvis menyttasten er en tekst, vises venstre eller høyre funksjonstast i venstre kolonne, og teksten vises i høyre kolonne mellom anførselstegn.

#### 2.2 Installere baseenheten

Installer på følgende måte:

- 1** Sett den ene enden av adapteren i stikkontakten og den andre enden i adapterkontakten bak på baseenheten.
- 2** Koble den ene enden av telefonledningen til telefonkontakten i veggen, og den andre enden på undersiden av baseenheten.
- 3** Koble telefonledningen og AC-strømledningen til kontaktene i baseenheten som vist i illustrasjon 2A.

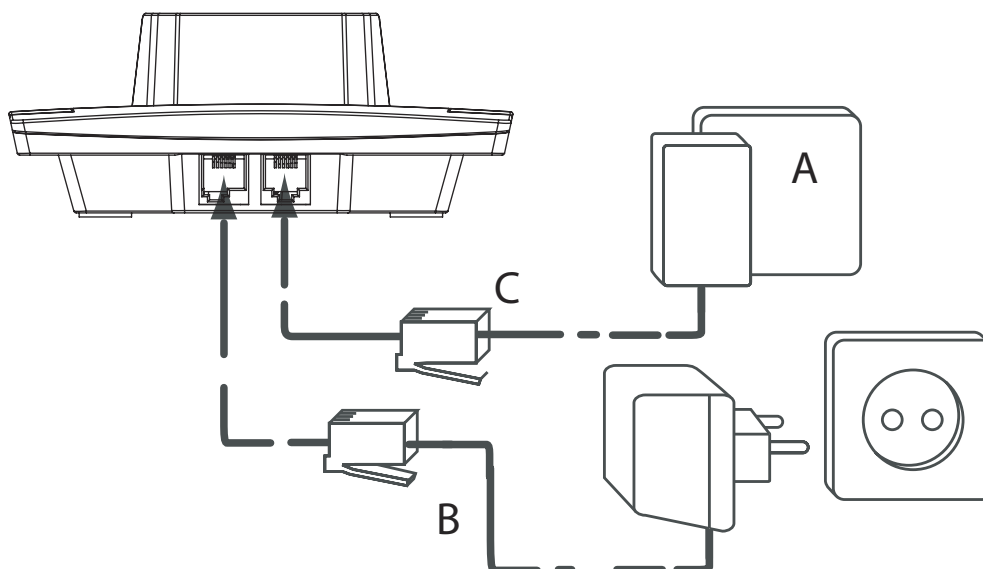

- 2A Baksiden av baseenheten -

A. Vegguttak for telefon

B. Strømledning

C. Telefonledning

### 2.3 Installere håndsettet

- 1 Åpne batteridekselet som vist i illustrasjon 2B.
- 2 Sett inn batteriene med polene (+ og -) riktig vei.
- 3 Lukk batteridekselet.
- 4 La håndsettet stå i baseenheten i 20 timer. Linje-/ladeindikatoren  på baseenheten tennes.

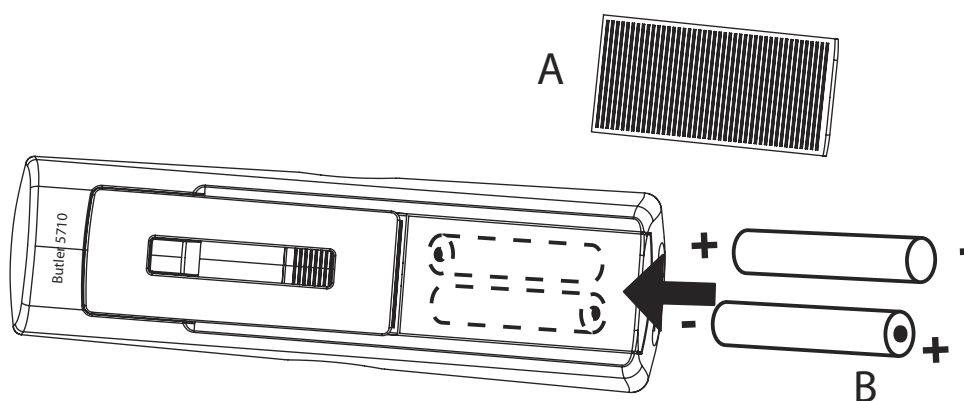

- 2B Håndsettet sett bakfra -

A. Deksel

B. Oppladbare batterier



Før du bruker telefonen første gang, må du forsikre deg om at batteriet har blitt ladet i 20 timer. Hvis du ikke gjør dette, vil ikke telefonen fungere optimalt.



## 2.4 Taster/led-indikator

### Håndsett

1. Display
2. Opp-/repetertast
3. Høyre menyttast
4. Høyre/Flash-tast
5. Legg på/AV-tast
6. Alfanymeriske taster
7. Tastelås
8. Ringesignal av-tast
9. Ned-/samtaleloggast
10. Løft av-tast/ håndfri-/ På-tast
11. Venstre/INT-tast
12. OK-tast
13. Venstre menyttast

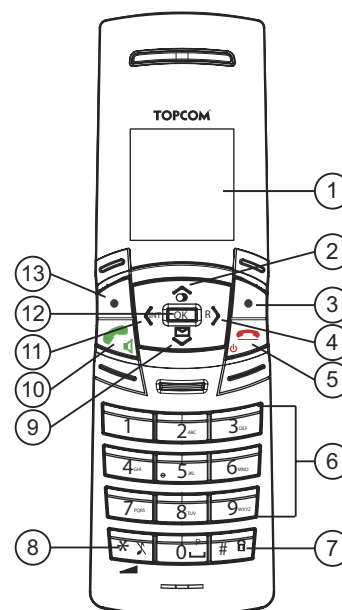

- 2C Håndsett -





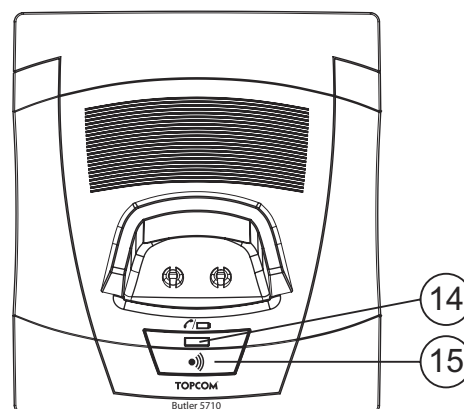









### Baseenhet

14. LED-indikator i baseenhet for I bruk/strøm/håndsett
15. Søkeknapp



- 2D Baseenhet -

## 2.5 Symboler

	Løft av		Tastelås
	Legg på		Alarm på
	Tapte anrop i anropsliste*		Håndsett ikke registrert eller utenfor rekkevidden
	Håndsettringevolum AV		Batteri utladet
	Håndsett innenfor baseenhetens rekkevidde		Lavt batterinivå
	Intern samtale		Middels batterinivå
	Håndfri		Fulladet batteri
	Ny talemelding		

\* Hvis Hvem ringer-funksjonen er tilgjengelig for telefonlinjen.

## 2.6 Displaytaster

Displaytastene (menytastene) er plassert like under displayet. Funksjonen til disse 2 tastene endres, avhengig av hvordan telefonen brukes. Den aktuelle funksjonen vises som et symbol eller som tekst rett over de 2 displaytastene.

	Telefonbok		Demp
	OK/Bekreft		Tilbake
	Meny		Ingen tast
	Slett		





## 2.7 LED-indikator på baseenhet

LED-indikatoren (14) har følgende betydninger:



- AV: baseenheten er ikke koblet til strøm, eller håndsettet står ikke til lading i baseenheten
- PÅ: håndsettet lader
- Blinker sakte: Røret er av eller oppringning pågår
- Blinker hurtig: registrering pågår

## 2.8 Navigere i menyen

Menysystemet i Butler 5710 er lett å bruke. Hver meny fører til en liste over alternativer. Menykartet er beskrevet i neste avsnitt.

- |   |  |
|---|--|
|  | <b>1</b> Trykk på venstre menyttast  mens håndsettet er slått på og håndsettet er i beredskapsmodus for å åpne hovedmenyen. |
|  | <b>2</b> Bla til ønsket menyalternativ.  |
|  | <b>3</b> Trykk på menyttasten for å vise flere alternativer eller for å bekrefte innstillingen på displayet.   |

### Avslutte eller gå ett trinn tilbake i menyen

- |   |  |
|---|--|
|  | Trykk på menyttasten for å gå til forrige nivå i menyen.                 |
|  | Trykk på legg på-tasten for å avbryte og gå tilbake til beredskapsmodus. |

## 2.9 Menyoversikt

Meny	Menyelementer
Håndsett	Ringetone Ringevolum Navn på håndsett Tastetoner Kontrast Autotalk Prefiks Velg base Språk Registrering
Baseinnst.	Ringetone Ringevolum Ringemodus Flash-tid System-PIN
Alarm/klokke	Still alarm Dato & tid Tidsformat
Verktøy	Avtale Stoppeklokke
Slå av	

## 3 Bruke telefonen

### 3.1 Slå håndsettet PÅ/AV



- 1 Trykk og hold inne AV-tasten for å slå av håndsettet.
- 2 Trykk på løft av-tasten eller sett håndsettet i baseenheten for å slå det på igjen.

### 3.2 Endre menyspråket

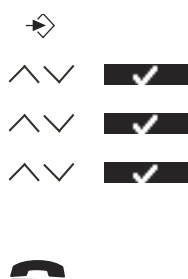

- 1 Åpne menyen.
  - 2 Velg "Håndsett" og bekreft.
  - 3 Velg "Språk" og bekreft.
  - 4 Velg ønsket språk og bekreft.
- Displayet viser "Lagret".
- 5 Trykk på legg på-tasten for å gå tilbake til beredskapsmodus.



◊ -pilene viser at det finnes flere alternativer i menyen.

### 3.3 Foreta et vanlig telefonanrop

#### Direkteoppringning



- 1** Trykk på løft av-tasten for å foreta anropet.
- 2** Tast telefonnummeret.
- 3** Trykk på legg på-tasten eller sett håndsettet i baseenheten for å legge på.

#### Forhåndsvalg

Med forhåndsvalgfunksjonen kan du taste inn og endre et nummer før du ringer opp.



- 1** Tast inn et nummer med opptil 24 siffer.  
Trykk og hold inne 0-tasten for å sette inn en pause. Displayet viser "P".
- 2** Trykk på meny-tasten for å korrigere.
- 3** Trykk på løft av-tasten for å foreta anropet.
- 4** Trykk på legg på-tasten eller sett håndsettet i baseenheten for å legge på.

#### Repetere et nummer fra listen

Du kan repetere de 10 siste oppringte numrene. Hvis du har lagret et navn sammen med nummeret i telefonboken, vises navnet i stedet for nummeret.



- 1** Trykk på gjenta-tasten.
- 2** Velg et nummer. Hvis nummeret finnes i telefonboken vises navnet.
- 3** Trykk på løft av-tasten for å slå nummeret, eller velg "Alt."
- 4** Hvis du valgte "Alt.", blar du i menyen og velger ett av følgende:  
"Slett samtale": hvis du vil fjerne nummeret fra samtalelisten.  
"Lagre nummer": hvis du vil lagre nummeret i telefonboken.  
"Slett alle": hvis du vil slette samtalelisten.
- 5** Bekreft valget.
- 6** Trykk på legg på-tasten for å gå tilbake til beredskapsmodus.

### 3.4 Motta en telefonsamtale

Når du mottar en ekstern samtale, viser displayet "Ekst. anrop".

Besvare anropet:



- 1** Trykk på løft av-tasten.  
ELLER  
Løft håndsettet opp fra baseenheten hvis du har aktivert "Autotalk"  
(Se "6.5 Autotalk")  
Samtale pågår-symbolet  vises på displayet. Samtalens varighet vises etter 15 sekunder.
- 2** Trykk på legg på-tasten eller sett håndsettet i baseenheten for å legge på.



*Du kan slå av ringesignalet mens telefonen ringer ved å velge "Stille".*

### 3.5 Håndfrimodus

Med håndfri kan du snakke i telefonen uten å holde håndsettet. På denne måten kan også andre personer i rommet høre på begge sider av samtalen.



- 1 Hvis du vil sette en samtale over til håndfri, trykker du på håndfritastens mens samtalen pågår.

### 3.6 Justere høyttaler/håndfrivolum



- 1 Trykk opp eller ned for å velge volumnivå 1-5 mens en normal samtale eller en håndfrisamtale pågår.

### 3.7 Privat-funksjon (dempefunksjon)

Brukes til å slå av mikrofonen slik at personen i den andre enden ikke kan høre deg.



- 1 Trykk på meny-tasten for å deaktivere mikrofonen mens en samtale pågår. "Sperr på" vises på displayet.



- 2 Velg "Av" for å aktivere mikrofonen igjen.

### 3.8 Finne et håndsett (søkefunksjon)



- 1 Trykk på søkeknappen på baseenheten.

Alle håndsett som er registrert av baseenheten ringer i 30 sekunder.



- 2 Trykk på en hvilken som helst tast på håndsettet for å avslutte søkefunksjonen.

### 3.9 Tastelås

Slik låser du tastaturet for å unngå at du ringer utilsiktet mens du bærer håndsettet med deg.

I beredskapsmodus:



- 1 Trykk og hold inne tastelåstasten (tast 7 - illustrasjon 2C) til "Låst" og låsesymbolet  vises på displayet.



- 2 Du låser opp tastaturet ved å trykke på "Lås opp" og deretter trykke på tastelåstasten.

### 3.10 Bruke det alfanumeriske tastaturet

Du kan også taste inn alfanumeriske tegn på denne telefonen. Dette er nyttig hvis du vil angi et navn i telefonboken eller gi navn til et håndsett.





Trykk den aktuelle tasten så mange ganger som nødvendig for å velge en bokstav.

Hvis du for eksempel vil velge en "A", trykker du én gang på "2". For "B" trykker du to ganger på "2", osv.

Hvis du vil velge "A" og deretter "B", trykker du én gang på "2", venter til markøren beveger seg til neste tegn, og trykker deretter to ganger på "2".

Når du skriver inn tekst, vises tilgjengelige tegn under hver tast nederst på displayet.











Du kan endre innmatingsstegnsettet fra engelsk (abc) til latin (aåå), gresk (ABΓ) eller russisk (ABB) ved å trykke og holde inne #-tasten i 2 sekunder.

	Trykk på "0" for å velge mellomrom.
	Trykk på *-tasten for å veksle mellom små og store bokstaver.
	Trykk og hold inne #-tasten i 2 sekunder for å endre tegnsett.
	Trykk på meny-tasten for å korrigere.





## 4 Telefonbok

Du kan lagre opptil 200 navn og numre på hvert håndsett. Navnene kan inneholde opptil 16 tegn, og numrene opptil 24 siffer.







### 4.1 Slik legger du til en oppføring

	<b>1</b> Trykk på meny-tasten.
	Hvis telefonboken er tom, vises "Telefonbok tom" på displayet. Hvis det er lagret navn i telefonboken, vises en liste over navnene.
	<b>2</b> Velg "Alt."
 	<b>3</b> Velg "Ny post" og bekreft.
 	<b>4</b> Tast inn navnet med tastaturet, og velg deretter "Lagre".
 	<b>5</b> Tast inn nummeret med tastaturet, og velg deretter "Lagre".
 	<b>6</b> Velg ønsket ringetone og velg "Lagre".
	<b>7</b> Gå tilbake til beredskap.







### 4.2 Slik ringer du opp en oppføring

	<b>1</b> Trykk på meny-tasten.
	<b>2</b> Velg ønsket navn, eller bruk tastaturet til å angi den første bokstaven i navnet.
	<b>3</b> Trykk på løft av-tasten for å foreta anropet.
	<b>4</b> Gå tilbake til beredskap.









### 4.3 Vis detalj

	<b>1</b> Trykk på meny-tasten.
	<b>2</b> Velg ønsket navn, eller bruk tastaturet til å angi den første bokstaven i navnet.
	<b>3</b> Velg "Alt."
 	<b>4</b> Velg "Vis detalj" og bekreft.
	Navnet, nummeret og den valgte ringetonen vises på displayet.
	<b>5</b> Gå tilbake til beredskap.







#### 4.4 Slette en oppføring eller alle oppføringer

- |   |  |
|---|--|
|  | <b>1</b> Trykk på menyta   |
|  | <b>2</b> Velg ønsket navn, eller bruk tastaturet til å angi den første bokstaven i navnet. |
|  | <b>3</b> Velg "Alt."   |
|  | <b>4</b> Velg "Slett post" og bekreft.   |
|  | <b>4</b> Velg "Slett alle" og bekreft.   |
|  | <b>5</b> Trykk på venstre menyta   |
|  | <b>6</b> Gå tilbake til beredskap.   |
- Slik sletter du én oppføring:
- Slik sletter du alle oppføringer:

#### 4.5 Redigere navn og nummer

- |   |  |
|---|--|
|    | <b>1</b> Trykk på menyta   |
|    | <b>2</b> Velg ønsket navn, eller bruk tastaturet til å angi den første bokstaven i navnet. |
|    | <b>3</b> Velg "Alt."   |
|   | <b>4</b> Velg "Endre post" og bekreft.   |
|  | <b>5</b> Trykk på menyta   |
|  | <b>6</b> Velg "Lagre".   |
|  | <b>7</b> Rediger nummeret og velg "Lagre".   |
|  | <b>8</b> Velg ønsket ringetone og velg "Lagre".  |
|  | <b>9</b> Gå tilbake til beredskap.   |

#### 4.6 Kopiere en oppføring i telefonboken til et annet håndsett

- |   |   |
|---|---|
|  | <b>1</b> Trykk på menyta  |
|  | <b>2</b> Velg ønsket navn, eller bruk tastaturet til å angi den første bokstaven i navnet.  |
|  | <b>3</b> Velg "Alt."  |
|  | <b>4</b> Velg "Kop. post" og bekreft.   |
|  | <b>5</b> Velg ønsket håndsett og bekreft.   |
|  | <b>6</b> På håndsettet som mottar oppføringen trykker du på høyre menyta for å bekrefte, eller venstre menyta for å avbryte overføringen. |
|  | <b>7</b> Gå tilbake til beredskap.  |
- De tilgjengelige håndsettene (alle håndsett som er registrert av baseenheten) vises.
- "Kopierer til håndsett x" vises på displayet.
- "Motta telefonbok-post?" vises på displayet på det andre håndsettet.

## 4.7 Kopiere alle oppføringer i telefonboken til et annet håndsett



Hvis du kopierer alle oppføringer fra ett håndsett til et annet, sletter du alle eksisterende oppføringer i håndsettet som mottar oppføringene.



- 1** Trykk på meny-tasten.
- 2** Velg ønsket navn, eller bruk tastaturet til å angi den første bokstaven i navnet.
- 3** Velg ”Alt.”.
- 4** Velg ”Kopier alt” og bekreft.  
De tilgjengelige håndsettene (alle håndsett som er registrert av baseenheten) vises.
- 5** Velg ønsket håndsett og bekreft.  
”Kopierer til håndsett x” vises på displayet.  
”Erstatt alle telefonbok-poster?” vises på displayet på det andre håndsettet.
- 6** På håndsettet som mottar oppføringen trykker du på høyre meny-tast for å bekrefte, eller venstre meny-tast for å avbryte overføringen.
- 7** Gå tilbake til beredskap.

## 5 Hvem ringer

### 5.1 Normale innkommende PSTN-samtaler



Denne tjenesten fungerer bare hvis telefonabonnementet har en Hvem ringer-funksjon. Kontakt telefonselskapet.

Når du mottar en samtale på den faste telefonlinjen vises nummeret samtalen kommer fra på displayet på håndsettet. Telefonen kan motta samtaler i både FSK- og DTMF-format. Du kan også se navnet til den som ringer, hvis dette overføres via nettverket. Hvis navnet er lagret i telefonboken, vises navnet fra telefonboken!

Telefonen kan lagre 30 oppringninger i samtalelisten (mottatte og tapte), slik at du kan se gjennom dem senere. Når minnet er fullt, vil nye samtaler automatisk erstatte de eldste oppringningene i minnet.



















Tapte anrop indikeres ved et blinkende symbol på displayet. Navnet på håndsettet blir erstattet av dette symbolet og antall tapte anrop.

### Vise mottatte samtaler



- 1** Trykk på ned-tasten.  
Listen over mottatte anrop vises på displayet. Dette er en kombinasjon av mottatte og ubesvarte anrop.
- 2** Velg ønsket navn eller nummer.
- 3** Trykk på løft av-tasten for å foreta anropet.  
ELLER  
Velg ”Alt.”.  
Slik sletter du én oppføring:

















- |   |   |   |   |
|---|---|---|---|
|  |  |  | <b>4</b> Velg "Slett samtale" og bekreft.                           |
|  |   |   | <b>5</b> Gå tilbake til beredskap.                                  |
|   |   |   | Slik sletter du alle oppføringer:                                   |
|  |  |  | <b>5</b> Velg "Slett alle" og bekreft.                              |
|  |   |   | <b>6</b> Gå tilbake til beredskap.                                  |
|   |   |   | Slik legger du til nummeret i telefonboken:                         |
|  |  |  | <b>5</b> Velg "Lagre nummer" og bekreft.                            |
|  |   |   | <b>6</b> Tast inn navnet med tastaturet, og velg deretter "Lagre".  |
|  |   |   | <b>7</b> Rediger nummeret med tastaturet, og velg deretter "Lagre". |
|  |  |  | <b>8</b> Velg ønsket ringetone og velg "Lagre".                     |
|  |   |   | <b>9</b> Gå tilbake til beredskap.                                  |

## 6 Tilpasse håndsettet

### 6.1 Ringetone og volum











#### Ringetone

Du kan velge mellom 18 ulike ringetoner for interne og eksterne samtaler.

- |   |   |   |  |
|---|---|---|--|
|    |   |   | <b>1</b> Åpne menyen.  |
|  |  |  | <b>2</b> Velg "Håndsett" og bekreft.   |
|  |  |  | <b>3</b> Velg "Ringetone" og bekreft.  |
|  |  |  | <b>4</b> Velg "Ekstern" for eksterne samtaler eller "Intern" for interne samtaler, og bekreft. |
|  |  |  | <b>5</b> Velg ønsket ringetone og bekreft.   |
|   |   |   | Ringetonene spilles av mens du blar gjennom listen.  |
|  |   |   | <b>6</b> Gå tilbake til beredskap.   |









#### Ringevolum

Du kan velge mellom 5 ringevolum, samt av.









- |   |   |   |  |
|---|---|---|--|
|  |   |   | <b>1</b> Åpne menyen.                                |
|  |  |  | <b>2</b> Velg "Håndsett" og bekreft.                 |
|  |  |  | <b>3</b> Velg "Ringevolum" og bekreft.               |
|   |   |   | Den valgte innstillingen vises.                      |
|  |   |   | <b>4</b> Trykk på opp-tasten for å øke volumet.      |
|  |   |   | <b>5</b> Trykk på ned-tasten for å redusere volumet. |
|  |   |   | <b>6</b> Velg "Lagre" for å bekrefte.                |
|  |   |   | <b>7</b> Gå tilbake til beredskap.                   |

## 6.2 Navn på håndsett









Du kan endre navnet som vises på displayet når håndsettet står i beredskap (maks. 9 tegn).

- |   |  |
|---|--|
|    | <b>1</b> Åpne menyen.                          |
|   | <b>2</b> Velg "Håndsett" og bekreft.           |
|   | <b>3</b> Velg "Håndsettnavn" og bekreft.       |
|    | <b>4</b> Tast inn ønsket navn.                 |
|    | <b>5</b> Trykk på meny-tasten for å korrigere. |
|    | <b>6</b> Velg "Lagre" for å bekrefte.          |
|    | <b>7</b> Gå tilbake til beredskap.             |

## 6.3 Tastetoner









- |   |   |
|---|---|
|    | <b>1</b> Åpne menyen.                     |
|   | <b>2</b> Velg "Håndsett" og bekreft.      |
|   | <b>3</b> Velg "Tastelyd" og bekreft.      |
|   | <b>4</b> Velg "På" eller "Av" og bekreft. |
|    | <b>5</b> Gå tilbake til beredskap.        |

## 6.4 Stille inn kontrast

- |   |   |
|---|---|
|    | <b>1</b> Åpne menyen.                           |
|   | <b>2</b> Velg "Håndsett" og bekreft.            |
|   | <b>3</b> Velg "Kontrast" og bekreft.            |
|   | <b>4</b> Velg ønsket kontrast (1-8) og bekreft. |
|    | <b>5</b> Gå tilbake til beredskap.              |







## 6.5 Autotalk







Telefonen besvarer innkommende samtaler automatisk når håndsettet blir løftet fra baseenheten. Denne funksjonen kan slås på eller av.

- |   |   |
|---|---|
|    | <b>1</b> Åpne menyen.                     |
|   | <b>2</b> Velg "Håndsett" og bekreft.      |
|   | <b>3</b> Velg "Autotalk" og bekreft.      |
|   | <b>4</b> Velg "På" eller "Av" og bekreft. |
|    | <b>5</b> Gå tilbake til beredskap.        |

## 6.6 Prefikskode

Du kan bruke telefonen med et prefiksnummer. Når du slår et telefonnummer, kan du automatisk legge til prefikskoden foran nummeret.















- |   |                                      |
|---|--------------------------------------|
|    | <b>1</b> Åpne menyen.                |
|   | <b>2</b> Velg "Håndsett" og bekreft. |
|   | <b>3</b> Velg "Prefiks" og bekreft.  |
|   | <b>4</b> Velg "Rediger" og bekreft.  |

- |   |   |  |
|---|---|--|
|  |  | <b>5</b> Tast inn prefikskoden, f.eks. "0", og velg "Lagre". |
|   |   | ELLER  |
|  |  | <b>4</b> Velg "På/Av" og bekreft.                            |
|  |  | <b>5</b> Velg "På" eller "Av" og bekreft.                    |
|  |   | <b>6</b> Gå tilbake til beredskap.                           |









## 6.7 Bruke alarmfunksjonen

Du kan velge ulike alarminnstillinger for hvert håndsett som er registrert i baseenheten. Alarmen ringer bare på det valgte håndsettet, ikke på baseenheten eller andre håndsett.









### Stille inn alarmen

- |   |   |   |
|---|---|---|
|    |   | <b>1</b> Åpne menyen.   |
|    |    | <b>2</b> Velg "Alarm/klokke" og bekreft.  |
|    |    | <b>3</b> Velg "Still alarm" og bekreft.   |
|    |    | <b>4</b> Velg "En gang", "På daglig", "Man til Fre" eller "Av" og bekreft.<br>Hvis du valgte "En gang", "På daglig" eller "Man til Fre", vises følgende på displayet:<br>Tid (24 t):<br>00:00 |
|  |  | <b>5</b> Angi klokkeslettet når du vil at telefonen skal ringe, og bekreft med "Lagre".   |
|  |  | <b>6</b> Velg ønsket ringetone og bekreft med "Lagre".  |
|  |  | <b>7</b> Hvis du vil slå av alarmen, velger du "Av" og bekrefter.   |
|  |   | <b>8</b> Tilbake til forrige meny.  |

## 6.8 Stille inn dato og klokkeslett

- |   |   |  |
|---|---|--|
|  |   | <b>1</b> Åpne menyen.  |
|  |  | <b>2</b> Velg "Alarm/klokke" og bekreft.                                     |
|  |  | <b>3</b> Velg "Dato & tid" og bekreft.                                       |
|  |  | <b>4</b> Angi år, måned, dag og klokkeslett, og velg "Lagre" for å bekrefte. |
|  |   | <b>5</b> Tilbake til forrige meny.   |









## 6.9 Stille inn klokkeslettformat

- |   |   |  |
|---|---|--|
|  |   | <b>1</b> Åpne menyen.                          |
|  |  | <b>2</b> Velg "Alarm/klokke" og bekreft.       |
|  |  | <b>3</b> Velg "Tidsformat" og bekreft.         |
|  |  | <b>4</b> Velg "12 t" eller "24 t", og bekreft. |
|  |   | <b>5</b> Tilbake til forrige meny.             |

## 7 Baseinnst.









### 7.1 Ringetone

Du kan velge mellom 9 ulike ringetoner.

- |   |  |
|---|--|
|    | <b>1</b> Åpne menyen.                          |
|   | <b>2</b> Velg "Baseinnst." og bekreft.         |
|   | <b>3</b> Velg "Ringetone" og bekreft.          |
|   | <b>4</b> Velg ønsket ringetone og bekreft.     |
|   | Tonene spilles av mens du blar gjennom listen. |
|    | <b>5</b> Gå tilbake til beredskap.             |

### 7.2 Ringe volum

Du kan velge mellom 5 ringevolumer for baseenheten.









- |   |  |
|---|--|
|    | <b>1</b> Åpne menyen.                                |
|   | <b>2</b> Velg "Baseinnst." og bekreft.               |
|   | <b>3</b> Velg "Ringe volum" og bekreft.              |
|   | Den valgte innstillingen vises.                      |
|   | <b>4</b> Trykk på opp-tasten for å øke volumet.      |
|    | <b>5</b> Trykk på ned-tasten for å redusere volumet. |
|    | <b>6</b> Velg "Lagre" for å bekrefte.                |
|    | <b>7</b> Gå tilbake til beredskap.                   |

### 7.3 Ringemodus

Det finnes to typer ringemodus:





- DTMF/tonesignal (mest vanlig)
- Pulssignal (for eldre telefonsentraler)

Slik endrer du ringemodus:

- |   |  |
|---|--|
|    | <b>1</b> Åpne menyen.  |
|   | <b>2</b> Velg "Baseinnst." og bekreft.                       |
|   | <b>3</b> Velg "Ringemodus" og bekreft.                       |
|   | <b>4</b> Velg "Tone" eller "Puls", og velg deretter "Lagre". |
|    | <b>5</b> Gå tilbake til beredskap.                           |

### 7.4 Repetisjon (Flash)

Trykk på Flash-tasten "R" (tast 4 - illustrasjon 2C) for å bruke bestemte tjenester på den eksterne linjen, for eksempel "samtale venter" (hvis telefonabonnementet har denne tjenesten), eller for å overføre samtaler hvis du bruker telefonoverføring (PABX). Flash-tasten "R" er et kort avbrudd av linjen. Du kan stille inn Flash-tiden til 100 ms eller 250 ms.

- |   |  |
|---|--|
|    | <b>1</b> Åpne menyen.                  |
|   | <b>2</b> Velg "Baseinnst." og bekreft. |
|   | <b>3</b> Velg "Flash-tid" og bekreft.  |



- 4** Velg kort (100 ms) eller lang (250 ms) Flash-tid, og velg "Lagre".
- 5** Gå tilbake til beredskap.

## 7.5 System-PIN

System-PIN-koden brukes til registrering og avregistrering av håndsett, samt enkelte valgfrie innstillinger. Standard system-PIN-kode er 0000.



- 1** Åpne menyen.
- 2** Velg "Baseinnst." og bekreft.
- 3** Velg "System pin" og bekreft.
- 4** Tast inn den gamle PIN-koden (0000 som standard) og velg "Lagre".
- 5** Tast inn den nye PIN-koden, velg "Lagre", og gjenta koden.
- 6** Gå tilbake til beredskap.

## 8 Verktøy

### 8.1 Avtale

Du kan stille inn 5 avtaler eller påminnelser, med et navn og et alarmtidspunkt og en alarmdatø.



- 1** Åpne menyen.
  - 2** Velg "Verktøy" og bekreft.
  - 3** Velg "Avtale" og bekreft.
  - 4** Velg en av de 5 avtalene, og velg "Alt.".
- Slik redigerer du avtalen:
- 5** Velg "Rediger" og bekreft.
  - 6** Rediger navnet på avtalen og velg "Lagre".
  - 7** Angi dato for avtalen og velg "Lagre".
  - 8** Angi klokkeslett og velg "Lagre".
  - 9** Velg ønsket alarmringetone og velg "Lagre".
  - 10** Gå tilbake til beredskap.

Slik sletter du avtalen:



- 5** Velg "Slett" og bekreft.
- 6** Trykk på høyre menyttast for å bekrefte.
- 7** Trykk på venstre menyttast for å gå tilbake.
- 8** Gå tilbake til beredskap.

### 8.2 Stoppeklokke



- 1** Åpne menyen.
- 2** Velg "Verktøy" og bekreft.
- 3** Velg "Stoppekl." og bekreft.
- 4** Velg "Start" for å starte stoppeklokken.
- 5** Velg "Stopp" for å stoppe stoppeklokken.



- Velg "Start" for å starte på nytt.
- Velg "Tilb." for å nullstille telleren.
- 6** Gå tilbake til beredskap.

## 9 Flere håndsett og basestasjoner

Du kan registrere opptil 4 håndsett på en baseenhet. Hvert håndsett kan registrere opptil 4 basestasjoner, og brukeren kan velge hvilken baseenhet som skal brukes.

### 9.1 Legge til et nytt håndsett



*Bare nødvendig hvis du har avregistrert et håndsett eller kjøpt et nytt håndsett.*

Slik setter du baseenheten i registreringsmodus:



- 1** Trykk og hold inne søkeknappen på baseenheten.
- LED-indikatoren på basestasjonen blinker i 90 sekunder. Baseenheten er klar for registrering i dette tidsrommet.

På håndsettet:

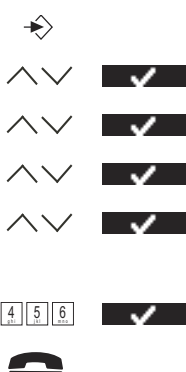

- 1** Åpne menyen.
- 2** Velg "Håndsett" og bekreft.
- 3** Velg "Registrering" og bekreft.
- 4** Velg "Register" og bekreft.
- 5** Velg nummeret på baseenheten som skal tilknyttes håndsettet (1-4) og bekreft.
- 6** Tast inn system-PIN-koden (0000 som standard) og bekreft.
- 7** Gå tilbake til beredskap.

### 9.2 Fjerne et håndsett



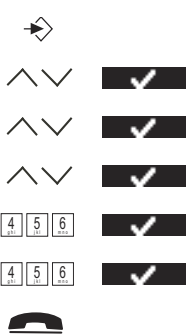





Denne fremgangsmåten må utføres på et annet håndsett enn det du vil fjerne.



- 1** Åpne menyen.
- 2** Velg "Håndsett" og bekreft.
- 3** Velg "Registrering" og bekreft.
- 4** Velg "Avregistrer" og bekreft.
- 5** Tast inn system-PIN-koden (0000 som standard) og bekreft.
- 6** Angi nummeret på håndsettet som skal fjernes, og bekreft.
- 7** Gå tilbake til beredskap.

### 9.3 Velge en baseenhet

Du kan bruke et håndsett med flere baseenheter. Du kan også angi at håndsettet automatisk skal velge den baseenheten med sterkest signal. Håndsettet må først registreres på hver enkelt baseenhet.



- |   |   |
|---|---|
|    | <b>1</b> Åpne menyen.   |
|   | <b>2</b> Velg "Håndsett" og bekreft.                                  |
|   | <b>3</b> Velg "Velg base" og bekreft.                                 |
|   | <b>4</b> Velg "Manuell" eller "Auto" og bekreft.                      |
|   | Hvis du valgte "Manuell":   |
|   | <b>5</b> Velg baseenheten som skal tilknyttes håndsettet, og bekreft. |



*Hvis du har aktivert automatisk basevalg og håndsettet er utenfor rekkevidden til den valgte baseenheten, vil håndsettet bare søke etter det sterkeste basesignalet i beredskapsmodus (ikke mens en samtale pågår).*



### 9.4 Bruke internsamtalesfunksjonen

#### Ring opp et internt håndsett

- |   |  |
|---|--|
| INT   | <b>1</b> Trykk på den venstre INT-tasten.<br>Displayet viser "Håndsett_".            |
|  | <b>2</b> Tast inn det interne nummeret til håndsettet du vil ringe opp.              |
|  | <b>3</b> Trykk på legg på-tasten eller sett håndsettet i baseenheten for å legge på. |

#### Overføre en ekstern samtale til et annet håndsett

I en ekstern samtale:

- |   |  |
|---|--|
| INT   | <b>1</b> Trykk på den venstre INT-tasten.<br>Displayet viser "Håndsett_".  |
|  | <b>2</b> Tast inn det interne nummeret til håndsettet du vil ringe opp.<br>Den eksterne samtalepartneren settes på venting.  |
|  | <b>3</b> Når den interne samtalepartneren svarer, trykker du legg på-tasten for å overføre samtalen.   |
|   | ELLER  |
| INT   | <b>3</b> Hvis den interne samtalepartneren ikke svarer, trykker du på den venstre INT-tasten for å hente inn den eksterne samtalepartneren igjen, eller for å overføre til en annen. |
|  | <b>4</b> Trykk på legg på-tasten eller sett håndsettet i baseenheten for å legge på.   |

#### Konferansesamtale

Du kan ha en samtale med 2 håndsett og én ekstern linje samtidig.

I en ekstern samtale:

- |   |   |
|---|---|
| INT   | <b>1</b> Trykk på den venstre INT-tasten.<br>Displayet viser "Håndsett_". |
|  | <b>2</b> Tast inn det interne nummeret til håndsettet du vil ringe opp.   |



Den eksterne samtalepartneren settes på venting.

**3** Når den interne samtalepartneren svarer, velger du ”Konf.”.

ELLER

INT

**3** Hvis den interne samtalepartneren ikke svarer, trykker du på den venstre INT for å hente inn den eksterne samtalepartneren.



**4** Trykk på legg på-tasten eller sett håndsettet i baseenheten for å legge på.

### Motta en ekstern oppringning mens intern kommunikasjon pågår

Du kan besvare eksterne samtaler mens du er i en internsamtale med et annet håndsett.

Slik besvarer du en innkommende samtale:



**1** Trykk på legg på-tasten. Den interne samtalen blir avbrutt.



**2** Trykk på løft av-tasten. Du blir nå forbundet med den eksterne oppringningen.

## 10 Feilsøking

Symptom	Mulig årsak	Løsning
Intet display	Batteriene er utladet	Kontroller batterienes stilling
		Lad opp batteriene
	Håndsettet slått AV	Slå håndsettet PÅ
Ingen tone	Telefonledningen ikke riktig tilkople	Kontroller telefonledningen og tilkoplingen
	Linjen er opptatt av et annet håndsett	Vent til det andre håndsettet legger på
Ikonet  blinker	Håndsettet er utenfor rekkevidde av baseenheten	Før håndsettet nærmere baseenheten
	Strømmen til baseenheten er brutt	Kontroller strømforsyningen til baseenheten
	Håndsettet er ikke registrert i baseenheten	Registrer håndsettet i baseenheten
Baseenheten eller håndsettet ringer ikke	Ringevolumet er slått av eller for lavt	Juster ringevolumet
Kan ikke sette over en samtale i en hussentral	Flash-tiden er for kort eller for lang	Endre Flash-tiden
Telefonen reagerer ikke på tastetrykk	Manipuleringsfeil	Ta ut batteriene og sett dem tilbake på plass



## 11 Tekniske karakteristikk

Standard	<b>DECT (Digital Enhanced Cordless Telecommunications)</b> <b>GAP (Generic Access Profile)</b>
Frekvensområde	1880 MHz til 1900 MHz
Antall kanaler	120 duplekskanaler
Modulering	GFSK
Talekoding	32 kbit/s
Stråleeffekt	10 mW ( gjennomsnittlig effekt per kanal )
Rekkevidde	300 m i åpent landskap /50 m maks. innendørs
Antall håndsett	Opptil 4
Strømforsyning til baseenheten	230V / 50 Hz / 6 V DC 300mA
Håndsett batterier:	2 oppladbare batterier AAA, NiMh 1,2 V, 700 mA
Beredskapstid for håndsett	110 timer mellom oppladinger
Taletid for håndsett	11 timer
Normalt driftsmiljø	+5 °C til +45 °C
Ringemoduser	Puls / tone
Flash-tid	100 eller 250 ms

## 12 Garanti

### 12.1 Garantiperiode

Alle Topcom-produkter leveres med 24 måneders garanti. Garantiperioden starter den dagen produktet blir kjøpt. Garantien for batteriene begrenses til 6 måneder etter kjøpsdatoen. Forbruksvarer eller feil som har ubetydelig innvirkning på driften eller verdien av utstyret, dekkes ikke.

Garantien forutsetter fremvisning av original kjøpskvittering der kjøpsdato og produktets modellnummer fremgår.

### 12.2 Garantihåndtering

Defekte produkter må returneres til et Topcom-servicesenter sammen med en gyldig kjøpskvittering. Hvis det oppstår feil ved produktet i løpet av garantiperioden, vil Topcom eller deres offisielle servicesenter gratis reparere eventuelle feil/mangler forårsaket av material- eller produksjonsfeil. Topcom vil etter eget valg oppfylle sine garantiforpliktelser ved å reparere eller skifte ut defekte produkter eller deler på de defekte produktene. Ved utskifting kan farge og modell være forskjellig fra det opprinnelige produktet som ble kjøpt.

Den opprinnelige kjøpsdatoen vil fortsatt gjelde som start på garantiperioden. Garantiperioden utvides ikke selv om produktet er skiftet ut eller reparert av Topcom eller deres servicesentre.

### 12.3 Ikke inkludert i garantien

Feil eller mangler som skyldes feil håndtering eller bruk, og feil som skyldes bruk av uoriginale deler eller tilbehør som ikke er anbefalt av Topcom, dekkes ikke av garantien.

De trådløse telefonene fra Topcom er kun ment for bruk med oppladbare batterier. Eventuell skade som skyldes bruk av ikke-oppladbare batterier, dekkes ikke av garantien.

Garantien dekker ikke skade forårsaket av eksterne faktorer, for eksempel lyn, vann og brann.

Transportskader dekkes heller ikke.

Det kan ikke fremsettes garantikrav hvis serienummeret på produktet er forandret, fjernet eller uleselig.

Eventuelle garantikrav anses som ugyldige hvis produktet er reparert, endret eller modifisert av kjøperen eller et serviceverksted som ikke er kvalifisert og offisielt godkjent av Topcom.

## 13 Avhending av produktet (miljø)



Når produktet skal avhendes, må du ikke kaste det sammen med det vanlige husholdningsavfallet, men ta det med til et innsamlingspunkt for resirkulering. Symbolet på produktet, bruksanvisningen og/eller boksen angir dette.

Noen av produktets materialer kan brukes om igjen hvis du tar produktet med til et innsamlingspunkt for resirkulering. Ved å sørge for at deler eller råmateriale fra brukte produkter kan brukes om igjen, bidrar du til å ta vare på miljøet.

Ta kontakt med de lokale myndighetene hvis du trenger mer informasjon om innsamlingspunkter i ditt område.

## 14 Rengjøring

Rengjør telefonen med en fuktig eller antistatisk klut. Bruk aldri rengjøringsmidler eller slipemidler.

## 15 ECO-modus (lav stråling)

- Denne trådløse telefonen (DECT-kompatibel) har mulighet for bruk med lav stråling.
- Strålingsstyrken i radiosignalet mellom basestasjonen og håndsettet er redusert til et minimum når håndsettet står i basestasjonen.
- Strålingen økes til normal styrke bare når håndsettet fjernes fra basestasjonene eller når en samtale mottas.
- Dette betyr ikke at normal DECT-stråling er helseskadelig.
- Innstillingen med lav stråling hindrer unødig DECT-stråling når det ikke kreves kommunikasjon mellom basestasjonen og håndsettet.
- Av tekniske årsaker kan ytterligere håndsett ikke brukes i lavstrålingsmodus (ytterligere håndsett som ikke befinner seg like ved basestasjonen vil alltid "søke etter basestasjonen" på grunn av svake radiosignaler).
- Lavstrålingsmodus er aktivert i fabrikkinnstillingene.
- Lavstrålingsmodus deaktiveres automatisk hvis du logger på et tilleggshåndsett.
- Lavstrålingsmodus blir automatisk aktivert igjen når du logger av alle tilleggshåndsett (bare ett håndsett kan være logget på basestasjonen).
- Fremgangsmåten for av- og pålogging av håndsett er beskrevet i brukerveiledningen.

## Suomi

### 1 Turvaohjeet

- Käytä ainoastaan mukana toimitettua latauspistoketta. Älä käytä muita latureita, sillä se voisi vaurioittaa akkujen kennoja.
- Käytä laitteessa ainoastaan samantyyppisiä ladattavia akkuja. Älä koskaan käytä tavallisia, ei-ladattavia akkuja. Aseta ladattavat akut siten, että ne koskettavat oikeita napoja (jotka on merkitty kuulokkeen akkulokeroon).
- Älä kosketa laturin ja pistokkeen koskettimia terävillä tai metallisilla esineillä.
- Tämä voisi vaikuttaa joidenkin lääketieteellisten laitteiden toimintaan.
- Kuuloke voi aiheuttaa kuulolaitteissa epämiellyttävää surinaa.
- Älä sijoita peruslaitetta kosteaan huoneeseen tai alle 1,5 metrin päähän vedenlähteestä. Älä päästä vettä kuulokkeeseen.
- Älä käytä puhelinta ympäristöissä, joissa on olemassa räjähdysvaara.
- Hävitä akut ja pidä puhelin kunnossa ympäristöystävällisellä tavalla.
- Koska tätä puhelinta ei voi käyttää sähkökatkosten aikana, hätäpuheluihin tulee käyttää verkkovirrasta riippumatonta puhelinta, esim. matkapuhelinta.

### 2 Käytön aloittaminen

#### 2.1 Tämän käyttöohjeen käyttäminen

Tässä käyttöohjeessa ohjeiden selventämiseen käytetään seuraavaa menetelmää:

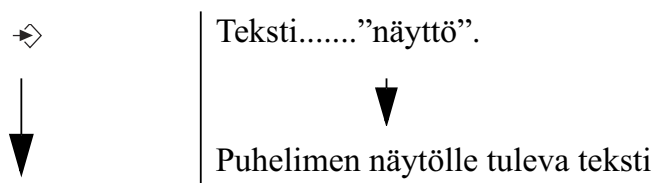

Painettava näppäin. Näppäin voi olla soft key -näppäin (Katso ”2.4 Näppäimet/LED”). Jos soft key -näppäin on kuvake, se näkyy vasemmassa sarakkeessa. Kun soft key -näppäin on teksti, vasemman- tai oikeanpuoleinen soft key -näppäin näkyy vasemmassa sarakkeessa ja teksti oikeassa sarakkeessa lainausmerkeissä.

#### 2.2 Tukiaseman asentaminen

Suorita asennus seuraavasti:

- 1 Kytke sovittimen toinen pää lähtöön ja toinen tukiaseman takana olevaan sovitinliitântään.
- 2 Kytke puhelinjohdon toinen pää puhelinpistorasiaan ja toinen tukiaseman pohjaan.
- 3 Aseta puhelin- ja vaihtovirtaverkkojohto tukiaseman ohjaimiin kuten kuvassa 2A.

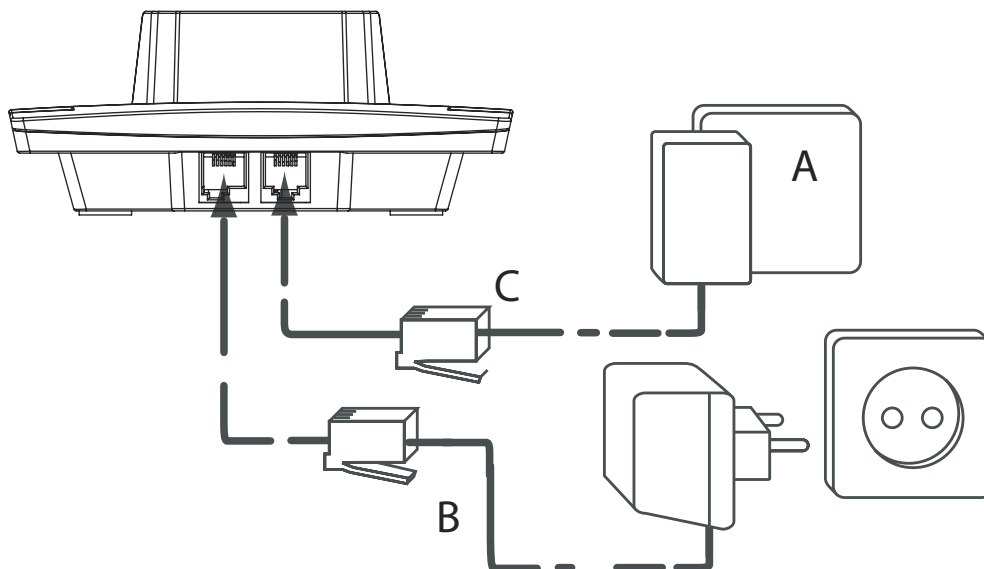

- 2A Tukiasema takaa -

A. Puhelinpistorasia

B. Virtajohto

C. Puhelinjohto

### 2.3 Kuulokkeen asentaminen

- 1 Avaa akkulokero kuten kuvassa 2B.
- 2 Aseta akut lokeroon niin, että +- ja - -navat tulevat oikein päin.
- 3 Sulje akkulokero.
- 4 Jätä käsiosa tukiasemaan 20 tunniksi. Tukiaseman linjan/latauksen merkkivalo  syttyy.

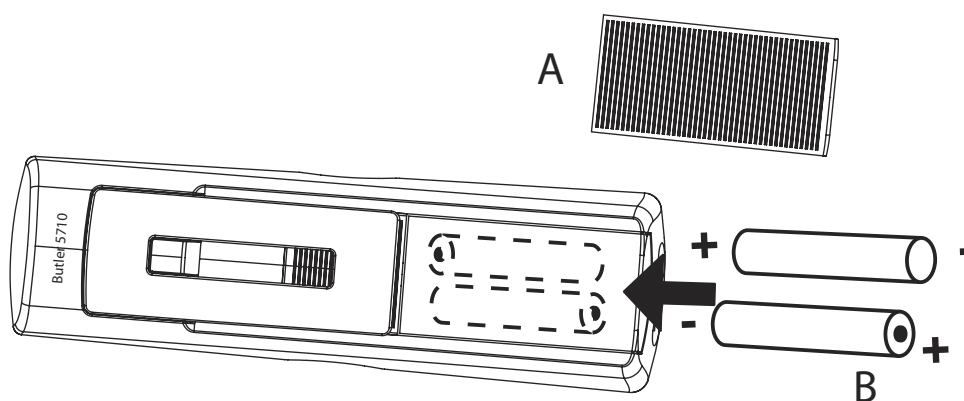

- 2B Käsiosa takaa -

A. Kanssi

B. Ladattavat akut



Ennen kuin käytät puhelinta ensimmäisen kerran, varmista, että akkua on ladattu 20 tuntia. Ellet noudata tätä ohjetta, puhelin ei toimi parhaalla mahdollisella tavalla.

## 2.4 Näppäimet/LED

### Käsiosa

1. Näyttö
2. Ylös/uudelleenvalinta-näppäin
3. Oikea soft menu -näppäin
4. Oikea/flash-näppäin
5. Käsiosa paikallaan / OFF-näppäin
6. Aakkosnumeeriset näppäimet
7. Näppäinlukko
8. Ei soittoääntä -näppäin
9. Alas/puheluloki-näppäin
10. Käsiosa pois paikaltaan / handsfree / päällä -näppäin
11. Vasen/INT-näppäin
12. OK-näppäin
13. Vasen soft menu -näppäin

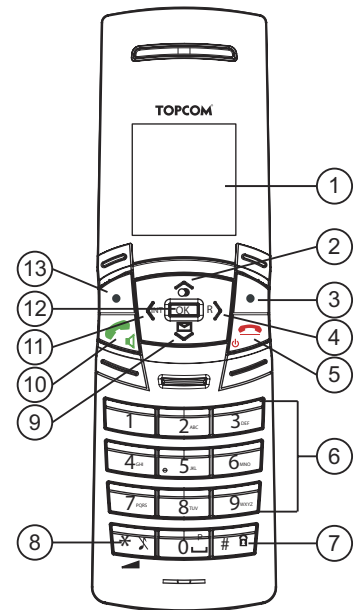

- 2C Käsiosa -

### Tukiasema

14. Käytössä / virta / käsiosa tukiasemassa -merkkivalo
15. Hakunäppäin

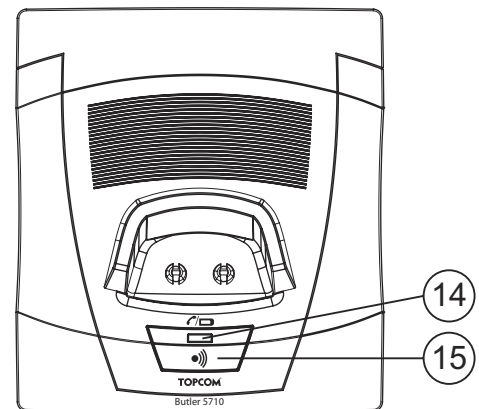

-2D Tukiasema -

## 2.5 Symbolit

	Käsiosa pois paikaltaan		Näppäinlukko
	Käsiosa paikallaan		Hälytys asetettu
	Puhelulistalla menetettyjä puheluita*		Käsiosaa ei rekisteröity tai poissa kuuluvuusalueelta
	Käsiosan soittoäänen voimakkuus pois päältä		Akku tyhjä
	Käsiosa tukiaseman kuuluvuusalueen sisällä		Akun virta vähissä
	Sisäpuhelu		Akussa virtaa kohtuullisesti
	Handsfree		Akku täynnä
	Uusi ääniposti		

\* Jos puhelinlinjalle on saatavana soittajan linjan tunnustuspalvelu.

## 2.6 Näytön näppäimet

Näytön näppäimet (soft key -näppäimet) ovat aivan näytön alapuolella. Näiden 2 näppäimen toiminnot vaihtuvat toimintatilan mukaan. Käytössä oleva toiminto näkyy kuvakkeena tai tekstinä aivan näytön 2 näppäimen yläpuolella.

	Puhelinluettelo		Mykistys
	OK/Vahvista		Paluu
	Valikko		Ei näppäintä
	Poista		





## 2.7 Tukiaseman LED

LED (14) ilmaisee seuraavan tilan:



- POIS: tukiasemassa ei virtaa tai käsiosa ei tukiasemassa ladattavana
- PÄÄLLÄ: käsiosa latautuu
- Vilkkuu hitaasti: Käsiosa pois paikaltaan tai soiton aikana
- Vilkkuu nopeasti: rekisteröinnin aikana

## 2.8 Valikossa liikkuminen

Butler 5710:n valikkojärjestelmä on helppokäyttöinen. Jokaisesta valikosta saa esiin joukon vaihtoehtoja. Valikkokartta näkyy seuraavassa kappaleessa.

- |   |   |
|---|---|
|  | <b>1</b> Kun käsiosa on päällä ja valmiustilassa, avaa päävalikko painamalla soft menu key -näppäintä  . |
|  | <b>2</b> Siirry haluamasi vaihtoehdon kohdalle valikossa.   |
|  | <b>3</b> Katso lisää vaihtoehtoja tai vahvista näytössä olevan asetuksen valinta painamalla soft menu key -näppäintä.   |

### Lopeta tai siirry yksi taso takaisinpäin valikossa

- |   |  |
|---|--|
|  | Siirry valikon edelliselle tasolle painamalla soft menu key -näppäintä.                          |
|  | Voit milloin tahansa peruuttaa ja palata valmiustilaan painamalla käsiosa paikallaan -näppäintä. |

## 2.9 Valikkonäkymä

Valikko	Alavalikon kohdat
Käsiosa	Soittoääni Soit.voimak. Käsiosan nimi Näppäinäännet Kontrasti Autom.puh. Prefiksi Val. tukias. Kieli Rekisteröinti
Tukias.aset.	Soittoääni Soit.voimak. Valintatapa Toisto Järjest. PIN
Herätys/Kello	Aseta herätys Pvm&aika Ajannäyttö
Työkalut	Tapaaminen Sekuntikello
Virta pois	

## 3 Puhelimen käyttö

### 3.1 Käsiosan kytkeminen päälle/pois



- 1 Kytke käsiosa pois päältä painamalla ja pitämällä pohjassa OFF-näppäintä.
- 2 Paina käsiosa poissa paikaltaan -näppäintä tai aseta käsiosa tukiasemaan kytkeäksesi käsiosan taas päälle.

### 3.2 Valikkokielen vaihtaminen

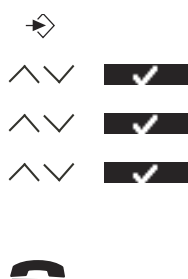

- 1 Siirry valikkoon.
  - 2 Valitse ”Käsiosa” ja vahvista.
  - 3 Valitse ”Kieli” ja vahvista.
  - 4 Valitse kieli ja vahvista.
- Näytölle tulee teksti ”Tallennettu”.
- 5 Palaa valmiustilaan painamalla käsiosa tukiasemassa -näppäintä.



◇ nuolet tarkoittavat, että valikossa on lisää vaihtoehtoja.

### 3.3 Normaalin puhelun soittaminen

#### Suoravalinta



- 1** Aloita puhelu painamalla käsiosa poissa paikaltaan -näppäintä.
- 2** Näppäile puhelinnumero.
- 3** Katkaise puhelu painamalla käsiosa paikallaan -näppäintä tai aseta käsiosa takaisin tukiasemaan.

#### Esivalinta

Esivalintatoiminnolla voit näppäillä ja muokata numeroa ennen soittamista.



- 1** Valitse puhelinnumero, jossa on enintään 24 numeroa. Lisää väli painamalla ja pitämällä pohjassa näppäintä 0. Näytölle tulee ”P”.
- 2** Tee korjaukset painamalla soft menu key -näppäintä.
- 3** Aloita puhelu painamalla käsiosa poissa paikaltaan -näppäintä.
- 4** Katkaise puhelu painamalla käsiosa paikallaan -näppäintä tai aseta käsiosa takaisin tukiasemaan.

#### Valitse numero uudelleen listalta

Voit valita uudelleen enintään 10 viimeksi valittua numeroa. Jos olet tallentanut numeron yhteyteen puhelinluetteloon nimen, numeron sijasta näkyy nimi.



- 1** Paina uudelleenvalintanäppäintä.
- 2** Valitse numero. Jos numero on puhelinluettelossa, näytölle tulee nimi.
- 3** Aloita puhelu painamalla käsiosa poissa paikaltaan -näppäintä tai valitse ”Vaiht.”.
- 4** Jos valitsit ”Vaiht.”, siirry haluamaasi kohtaan ja valitse:  
 ”Poista puhelu”: poistaaksesi numeron puhelulistalta;  
 ”Tallenna nro”: tallentaaksesi numeron puhelinluetteloon;  
 ”Poista puhelu”: tyhjentääksesi puhelulistan.
- 5** Vahvista valinta.
- 6** Palaa valmiustilaan painamalla käsiosa tukiasemassa -näppäintä.

### 3.4 Puhelun vastaanottaminen

Kun saat ulkoisen puhelun, näytölle tulee teksti ”Ulkopuhelu”.

Puhelun vastaanottaminen:



- 1** Paina käsiosa pois paikaltaan -näppäintä.  
 TAI  
 Nosta käsiosa pois tukiasemasta, jos ”Autom.puh.” on aktiivinen  
 (Katso ”6.5 Autom.puh.”)  
 Näytölle tulee käynnissä olevan puhelun kuvake  . Puhelun kesto tulee näkyviin 15 sekunnin kuluttua.
- 2** Katkaise puhelu painamalla käsiosa paikallaan -näppäintä tai aseta käsiosa takaisin tukiasemaan.



*Voit kytkeä soittoäänien pois käytöstä saapuvan puhelun aikana valitsemalla ”Hilj.”.*



### 3.5 Handsfree-tila

Handsfree-tilassa voit puhua vastapuolen kanssa pitämättä käsiosaa kädessä. Silloin muut huoneessa olijat voivat myös kuulla keskustelun molemmat osapuolet.



- 1 Voit siirtyä käyttämään puhelussa handsfree-toimintoa painamalla handsfree-näppäintä puhelun aikana.

### 3.6 Käsiosan/handsfree-laitteen äänenvoimakkuuden säätäminen



- 1 Voit valita äänenvoimakkuudeksi normaalin tai handsfree-puhelun aikana 1-5 painamalla nuolta ylös tai alas.

### 3.7 Salaustoiminto (mykistys)

Voit poistaa mikrofonin käytöstä, niin että linjan toisessa päässä oleva henkilö ei kuule puhettasi.



- 1 Poista mikrofoni käytöstä keskustelun aikana painamalla soft menu key -näppäintä.

Näytölle tulee teksti ”Myk.päällä”.



- 2 Ota mikrofoni uudelleen käyttöön valitsemalla ”Pois”.

### 3.8 Käsiosan paikallistaminen (hakutoiminto)



- 1 Paina tukiaseman henkilöhakunäppäintä.

Kaikki tukiasemaan rekisteröidyt käsiosat soivat 30 sekunnin ajan.



- 2 Lopeta henkilöhaku painamalla mitä tahansa käsiosan näppäintä.

### 3.9 Näppäinlukko

Voit lukita näppäimet estääksesi tahattomat soitot kantaessasi käsiosaa mukana.

Valmiustilassa:



- 1 Paina ja pidä pohjassa näppäinten lukitusnäppäintä (näppäin 7 – kuva 2C), kunnes näytölle tulee teksti ”Lukittu” ja näppäinten lukituskuvake .



- 2 Jos haluat poistaa lukituksen käytöstä, valitse ”Avaa” ja paina sitten näppäinten lukitusnäppäintä.

### 3.10 Aakkosnumeerisen näppäimistön käyttö





Puhelimellasi voit myös kirjoittaa aakkosnumeerisia merkkejä. Tämä on hyödyllistä halutessasi kirjoittaa nimen puhelinluetteloon, antaa nimen kuulokkeelle...

Kirjaimen valinta tapahtuu painamalla sitä vastaavaa näppäintä niin monta kertaa kuin on tarpeen. Jos haluat esimerkiksi valita kirjaimen 'A', paina kerran näppäintä '2'. Jos haluat valita kirjaimen 'B', paina näppäintä '2' kahdesti ja niin edelleen.

Jos haluat valita kirjaimet 'A' ja 'B' peräkkäin, paina näppäintä '2' kerran, odota kunnes osoitin siirtyy seuraavan merkin kohdalle ja paina sitten näppäintä '2' kahdesti.

Kun kirjoitat tekstiä, käytettävissä oleva merkki kunkin näppäimen kohdalla näkyy näytön alareunassa.













Voit valita käytettävän merkistön englannista (abc) latinaan (aää), kreikkaan (ABΓ) tai venäjään (ABB) painamalla ja pitämällä pohjassa #-näppäintä 2-sekunnin ajan.

	Valitse välilyönti painamalla näppäintä '0'.
	Vaihda pienten ja isojen kirjainten välillä painamalla *-näppäintä.
	Vaihda käytettävä merkistö painamalla ja pitämällä pohjassa #-näppäintä 2 sekunnin ajan.
	Tee korjaukset painamalla soft menu key -näppäintä.





## 4 Puhelinluettelo

Jokaiseen käsiosaan voi tallentaa enintään 200 nimeä ja numeroa. Jokaisessa nimessä voi olla enintään 16 merkkiä ja puhelinnumerossa 24 merkkiä.







### 4.1 Merkinnän lisääminen

	<b>1</b> Paina soft menu key -näppäintä.
	Jos puhelinluettelo on tyhjä, näytölle tulee teksti ”Puh.luettelo tyhjä”. Jos nimiä on tallennettu, ne näkyvät luettelossa.
 	<b>2</b> Valitse ”Vaiht.”.
	<b>3</b> Valitse ”Uusi nro” ja vahvista.
 	<b>4</b> Kirjoita nimi näppäimistön avulla ja valitse sitten ”Tallen”.
 	<b>5</b> Kirjoita numero näppäimistön avulla ja valitse sitten ”Tallen”.
 	<b>6</b> Valitse haluamasi soittoääni ja valitse ”Tallen”.
	<b>7</b> Palaa valmiustilaan.











### 4.2 Merkinnän valitseminen

	<b>1</b> Paina soft menu key -näppäintä.
	<b>2</b> Valitse haluamasi nimi tai kirjoita nimen ensimmäinen kirjain näppäimistön avulla.
	<b>3</b> Aloita puhelu painamalla käsiosa poissa paikaltaan -näppäintä.
	<b>4</b> Palaa valmiustilaan.











### 4.3 Näytä tiedot

	<b>1</b> Paina soft menu key -näppäintä.
	<b>2</b> Valitse haluamasi nimi tai kirjoita nimen ensimmäinen kirjain näppäimistön avulla.
	<b>3</b> Valitse ”Vaiht.”.
 	<b>4</b> Valitse ”Näytä tiedot” ja vahvista.
	Näytöllä näkyvät merkintään liittämäsi nimi, numero ja soittoääni.
	<b>5</b> Palaa valmiustilaan.











#### 4.4 Poista yksi merkintä tai kaikki merkinnät

- |   |   |   |
|---|---|---|
|  | <b>1</b> Paina soft menu key -näppäintä.  |   |
|  | <b>2</b> Valitse haluamasi nimi tai kirjoita nimen ensimmäinen kirjain näppäimistön avulla. |   |
|  | <b>3</b> Valitse ”Vaiht.”.  |   |
|  |            | <b>4</b> Valitse ”Poista nro” ja vahvista.  |
|  |            | <b>4</b> Valitse ”Poista kaikki” ja vahvista.   |
|  |            | <b>5</b> Vahvista painamalla vasemmanpuoleista valikkonäppäintä tai peruuta painamalla oikeanpuoleista näppäintä. |
|  | <b>6</b> Palaa valmiustilaan.   |   |
- Yhden merkinnän poistaminen:
- Kaikkien merkintöjen poistaminen:

#### 4.5 Muokkaa nimeä ja numeroa

- |   |   |  |
|---|---|--|
|    | <b>1</b> Paina soft menu key -näppäintä.  |  |
|    | <b>2</b> Valitse haluamasi nimi tai kirjoita nimen ensimmäinen kirjain näppäimistön avulla. |  |
|    | <b>3</b> Valitse ”Vaiht.”.  |  |
|   |           | <b>4</b> Valitse ”Muok.nro” ja vahvista.                   |
|  | <b>5</b> Poista nimi painamalla soft menu key -näppäintä tai muuta sitä näppäimistöllä.     |  |
|  | <b>6</b> Valitse ”Tallen”.  |  |
|  | <b>7</b> Muokkaa numeroa ja valitse ”Tallen”.   |  |
|  |          | <b>8</b> Valitse haluamasi soittoääni ja valitse ”Tallen”. |
|  | <b>9</b> Palaa valmiustilaan.   |  |

#### 4.6 Kopioi puhelinluettelon merkintä toiseen käsiosaan

- |   |   |   |
|---|---|---|
|  | <b>1</b> Paina soft menu key -näppäintä.  |   |
|  | <b>2</b> Valitse haluamasi nimi tai kirjoita nimen ensimmäinen kirjain näppäimistön avulla. |   |
|  | <b>3</b> Valitse ”Vaiht.”.  |   |
|  |          | <b>4</b> Valitse ”Kopioi nro” ja vahvista.  |
|  |          | <b>5</b> Valitse haluamasi käsiosa ja vahvista.   |
|  |          | <b>6</b> Paina kohdekäsiosassa oikeanpuoleista valikkonäppäintä vahvistaaksesi tai vasenta valikkonäppäintä peruaksesi siirron. |
|  | <b>7</b> Palaa valmiustilaan.   |   |
- Esiin tulevat käsiosat (kaikki tukiasemaan rekisteröidyt käsiosat).
- Näytölle tulee teksti ”Kopioi käsiosaan x”.
- Kohdekäsiosan näytölle tulee teksti ”Vastaanota puh.luet. tiedot?”.

## 4.7 Kopioi kaikki puhelinluettelon merkinnät toiseen käsiosaan



*Kun kopioit kaikki merkinnät käsiosasta toiseen, pyyhki samalla pois kaikki kohdekäsiosan olemassa olevat merkinnät.*



**1** Paina soft menu key -näppäintä.



**2** Valitse haluamasi nimi tai kirjoita nimen ensimmäinen kirjain näppäimistön avulla.



**3** Valitse ”Vaiht.”.



**4** Valitse ”Kopioi kaikki” ja vahvista.

Esiin tulevat käsiosat (kaikki tukiasemaan rekisteröidyt käsiosat).



**5** Valitse haluamasi käsiosa ja vahvista.

Näytölle tulee teksti ”Kopioi käsiosaan x”.

Kohdekäsiosan näytölle tulee teksti ”Korv. kaikki puh.luet. tiedot?”.



**6** Paina kohdekäsiosassa oikeanpuoleista valikkonäppäintä vahvistaaksesi tai vasenta valikkonäppäintä peruaksesi siirron.



**7** Palaa valmiustilaan.

## 5 Soittajan tunnistus

### 5.1 Normaalit saapuvat PSTN-puhelut



*Tämä palvelu toimii vain, jos olet tilannut numeronäyttö-/luettelopalvelun. Ota yhteyttä puhelinyhtiöösi.*

Kun saat puhelun lankapuhelinlinjasta, soittajan numero näkyy käsiosan näytöllä. Puhelin voi vastaanottaa puheluja sekä FSK- että äänimuotoisina. Jos verkko lähettää soittajan nimen, näet myös sen. Jos nimi on tallennettu puhelinluetteloon, näyttöön tulee puhelinluetteloon merkitty nimi!

Puhelin voi tallentaa puhelulistalle 30 puhelua (vastaanotettua ja menetettyä), joita voidaan myöhemmin tarkastella. Kun muisti on täynnä, uudet puhelut korvaavat automaattisesti vanhimmat muistissa olevat puhelut.



Menetetyistä puhelusta ilmoittaa näytöllä vilkkuva kuvake. Käsiosan nimen tilalla näkyy tämä kuvake ja menetettyjen puheluiden määrä.

### Vastaanotettujen puheluiden tarkastelu



**1** Paina alas-näppäintä.

Näytölle tulee luettelo vastaanotetuista puhelusta. Siinä näkyvät sekä vastaanotetut että menetetyt puhelut.



**2** Valitse haluamasi nimi tai numero.



**3** Aloita puhelu painamalla käsiosa poissa paikaltaan -näppäintä.

TAI













Valitse ”Vaiht.”.

Yhden merkinnän poistaminen:



**4** Valitse ”Poista nro” ja vahvista.











- |   |  |
|---|--|
|    | <b>5</b> Palaa valmiustilaan.  |
|   | Kaikkien merkintöjen poistaminen:  |
|   | <b>5</b> Valitse ”Poista kaikki” ja vahvista.                            |
|    | <b>6</b> Palaa valmiustilaan.  |
|   | Numeron lisääminen puhelinluetteloon:                                    |
|   | <b>5</b> Valitse ”Tallenna nro” ja vahvista.                             |
|    | <b>6</b> Kirjoita nimi näppäimistön avulla ja valitse sitten ”Tallen”.   |
|    | <b>7</b> Muokkaa numeroa näppäimistön avulla ja valitse sitten ”Tallen”. |
|   | <b>8</b> Valitse haluamasi soittoääni ja valitse ”Tallen”.               |
|    | <b>9</b> Palaa valmiustilaan.  |

## 6 Personoi käsiosa

### 6.1 Soittoääni ja äänenvoimakkuus









#### Soittoääni

Voit valita soittoäänit sisäisille ja ulkoisille puheluille 18 eri soittoäänien joukosta.

- |   |   |
|---|---|
|    | <b>1</b> Siirry valikkoon.  |
|       | <b>2</b> Valitse ”Käsiosa” ja vahvista.   |
|   | <b>3</b> Valitse ”Soittoääni” ja vahvista.  |
|   | <b>4</b> Valitse ulkoiset puhelut valitsemalla ”Ulko” tai sisäiset puhelut valitsemalla ”Sisä” ja vahvista. |
|   | <b>5</b> Valitse haluamasi melodia ja vahvista.   |
|   | Selatessasi soittoääniä kuulet melodian.  |
|    | <b>6</b> Palaa valmiustilaan.   |









#### Soit.voimak.

Voit valita jonkin viidestä käsiosan soittoäänien voimakkuudesta tai mykistää soittoäänien.









- |   |  |
|---|--|
|    | <b>1</b> Siirry valikkoon.                                     |
|   | <b>2</b> Valitse ”Käsiosa” ja vahvista.                        |
|   | <b>3</b> Valitse ”Soit.voimak.” ja vahvista.                   |
|   | Näytölle tulee nykyinen asetus.                                |
|    | <b>4</b> Lisää äänenvoimakkuutta painamalla ylös-näppäintä.    |
|    | <b>5</b> Pienennä äänenvoimakkuutta painamalla alas-näppäintä. |
|    | <b>6</b> Vahvista valitsemalla ”Tallen”.                       |
|    | <b>7</b> Palaa valmiustilaan.                                  |

## 6.2 Käsiosan nimi









Voit vaihtaa käsiosassa näkyvän nimen valmiustilan aikana (maks. 9 merkkiä).

- |   |  |
|---|--|
|    | <b>1</b> Siirry valikkoon.                                   |
|   | <b>2</b> Valitse ”Käsiosa” ja vahvista.                      |
|   | <b>3</b> Valitse ”Käsiosan nimi” ja vahvista.                |
|    | <b>4</b> Kirjoita haluamasi nimi.                            |
|    | <b>5</b> Tee korjaukset painamalla soft menu key -näppäintä. |
|    | <b>6</b> Vahvista valitsemalla ”Tallen”.                     |
|    | <b>7</b> Palaa valmiustilaan.                                |

## 6.3 Näppäinäänet









- |   |  |
|---|--|
|    | <b>1</b> Siirry valikkoon.                               |
|   | <b>2</b> Valitse ”Käsiosa” ja vahvista.                  |
|   | <b>3</b> Valitse ”Näppäinäänet” ja vahvista.             |
|   | <b>4</b> Valitse ”Päällä” tai ”Pois päältä” ja vahvista. |
|    | <b>5</b> Palaa valmiustilaan.                            |

## 6.4 Kontrastin asettaminen

- |   |   |
|---|---|
|    | <b>1</b> Siirry valikkoon.                              |
|   | <b>2</b> Valitse ”Käsiosa” ja vahvista.                 |
|   | <b>3</b> Valitse ”Kontrasti” ja vahvista.               |
|   | <b>4</b> Valitse haluamasi kontrasti (1-8) ja vahvista. |
|    | <b>5</b> Palaa valmiustilaan.                           |







## 6.5 Autom.puh.







Kun puhelu saapuu ja käsiosa on tukiasemassa, puhelin valitsee linjan automaattisesti, kun se otetaan pois tukiasemasta. Tämän toiminnon voi kytkeä päälle tai pois.

- |   |  |
|---|--|
|    | <b>1</b> Siirry valikkoon.                               |
|   | <b>2</b> Valitse ”Käsiosa” ja vahvista.                  |
|   | <b>3</b> Valitse ”Autom.puh.” ja vahvista.               |
|   | <b>4</b> Valitse ”Päällä” tai ”Pois päältä” ja vahvista. |
|    | <b>5</b> Palaa valmiustilaan.                            |

## 6.6 Prefiksikoodi

Puhelinta voi käyttää siten, että puhelinnumeron eteen lisätään prefiksi. Puhelinnumeroita valitessasi voit lisätä puhelinnumeron eteen automaattisesti prefiksin.















- |   |  |
|---|--|
|    | <b>1</b> Siirry valikkoon.               |
|   | <b>2</b> Valitse ”Käsiosa” ja vahvista.  |
|   | <b>3</b> Valitse ”Prefiksi” ja vahvista. |
|   | <b>4</b> Valitse ”Muuta” ja vahvista.    |

- |   |   |  |
|---|---|--|
|  |  | <b>5</b> Näppäile eteen liitettävä numero, esim. '0', ja valitse "Tallen". |
|   |   | TAI  |
|  |  | <b>4</b> Valitse "Päällä/pois" ja vahvista.                                |
|  |  | <b>5</b> Valitse "Päällä" tai "Pois päältä" ja vahvista.                   |
|  |   | <b>6</b> Palaa valmiustilaan.  |









## 6.7 Hälytystoiminnon käyttö

Voit käyttää eri hälytysasetusta jokaisessa tukiasemaan rekisteröidyssä käsiosassa. Hälytys soi vain käsiosassa, ei tukiasemassa eikä muissa käsiosissa.









### Aseta herätys

- |   |   |  |
|---|---|--|
|    |   | <b>1</b> Siirry valikkoon.   |
|    |    | <b>2</b> Valitse "Herätys/Kello" ja vahvista.  |
|    |    | <b>3</b> Valitse "Aseta herätys" ja vahvista.  |
|    |    | <b>4</b> Valitse "Kerran", "Päivittäin", "Ma-Pe" tai "Pois päältä" ja vahvista. Jos olet valinnut "Kerran", "Päivittäin" tai "Ma-Pe", näytölle tulee:<br>Aika (24 h):<br>00:00 |
|    |    | <b>5</b> Näppäile aika, jolloin haluat puhelimen soivan, ja vahvista valitsemalla "Tallen".  |
|  |  | <b>6</b> Valitse haluamasi soittoääni ja vahvista valitsemalla "Tallen".   |
|  |  | <b>7</b> Voit poistaa hälytyksen käytöstä valitsemalla "Pois päältä" ja vahvistamalla valinnan.  |
|  |   | <b>8</b> Palaa edelliseen valikkoon.   |

## 6.8 Päivämäärän ja kellonajan asettaminen

- |   |   |   |
|---|---|---|
|  |   | <b>1</b> Siirry valikkoon.  |
|  |  | <b>2</b> Valitse "Herätys/Kello" ja vahvista.   |
|  |  | <b>3</b> Valitse "Pvm&aika" ja vahvista.  |
|  |  | <b>4</b> Näppäile vuosi, kuukausi, päivä, tunnit ja minuutit ja vahvista valitsemalla "Tallen". |
|  |   | <b>5</b> Palaa edelliseen valikkoon.  |











## 6.9 Ajannäytön asettaminen

- |   |   |   |
|---|---|---|
|  |   | <b>1</b> Siirry valikkoon.                      |
|  |  | <b>2</b> Valitse "Herätys/Kello" ja vahvista.   |
|  |  | <b>3</b> Valitse "Ajannäyttö" ja vahvista.      |
|  |  | <b>4</b> Valitse "12 h" tai "24 h" ja vahvista. |
|  |   | <b>5</b> Palaa edelliseen valikkoon.            |

## 7 Tukias.aset.











### 7.1 Soittoääni

Voit valita yhdeksästä eri soittoäänimelodiasta.

- |   |          |   |
|---|----------|---|
|    | <b>1</b> | Siirry valikkoon.   |
|    | <b>2</b> | Valitse ”Tukias.aset.” ja vahvista.   |
|    | <b>3</b> | Valitse ”Soittoääni” ja vahvista.   |
|    | <b>4</b> | Valitse haluamasi melodia ja vahvista.<br>Selatessasi soittoääniä kuulet niistä näytteet. |
|    | <b>5</b> | Palaa valmiustilaan.  |

### 7.2 Soit.voimak.

Voit valita jonkin viidestä tukiaseman soittoäänien voimakkuudesta.











- |   |          |  |
|---|----------|--|
|    | <b>1</b> | Siirry valikkoon.  |
|    | <b>2</b> | Valitse ”Tukias.aset.” ja vahvista.                                      |
|    | <b>3</b> | Valitse ”Soit.voimak.” ja vahvista.<br>Näytölle tulee nykyinen asetetus. |
|    | <b>4</b> | Lisää äänenvoimakkuutta painamalla ylös-näppäintä.                       |
|    | <b>5</b> | Pienennä äänenvoimakkuutta painamalla alas-näppäintä.                    |
|    | <b>6</b> | Vahvista valitsemalla ”Tallen”.  |
|    | <b>7</b> | Palaa valmiustilaan.   |

### 7.3 Valintatila

Valintatiloja on kahta tyyppiä:







- DTMF/äänivalinta (yleisimmin käytetty)
- Pulssivalinta (vanhemmissa asennuksissa)

Valintatilan muuttaminen:

- |   |          |   |
|---|----------|---|
|    | <b>1</b> | Siirry valikkoon.                               |
|    | <b>2</b> | Valitse ”Tukias.aset.” ja vahvista.             |
|    | <b>3</b> | Valitse ”Valintatapa” ja vahvista.              |
|    | <b>4</b> | Valitse ”Ääni” tai ”Pulssi” ja sitten ”Tallen”. |
|    | <b>5</b> | Palaa valmiustilaan.                            |

### 7.4 Toisto (Flash)

Voit käyttää tiettyjä ulkolinjan palveluja, kuten ”jonotusta”, tai puhelinvaihdetta (PABX) käyttäessäsi siirtää puheluita painamalla flash-näppäintä ”R” (näppäin 4 – kuva 2C) (jos puhelinyhtiösi antaa mahdollisuuden tähän toimintoon). Flash-näppäimellä ”R” voit katkaista linjan hetkeksi. Voit valita flash-ajaksi 100–250 ms.

- |   |          |                                     |
|---|----------|-------------------------------------|
|    | <b>1</b> | Siirry valikkoon.                   |
|    | <b>2</b> | Valitse ”Tukias.aset.” ja vahvista. |
|    | <b>3</b> | Valitse ”Toisto” ja vahvista.       |





- 4** Valitse lyhyt (100 ms) tai pitkä flash-aika (250 ms) ja valitse ”Tallen”.
- 5** Palaa valmiustilaan.

## 7.5 Järjest. PIN

Järjestelmän PIN-koodilla rekisteröidään ja poistetaan rekisteristä käsiosia sekä määritetään muita vaihtoehtoisia asetuksia. Järjestelmän oletus-PIN-koodi on 0000.

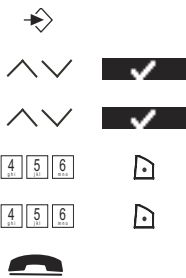

- 1** Siirry valikkoon.
- 2** Valitse ”Tukias.aset.” ja vahvista.
- 3** Valitse ”Järjest. PIN” ja vahvista.
- 4** Näppäile vanha PIN (oletus 0000) ja valitse ”Tallen”.
- 5** Näppäile uusi PIN, valitse ”Tallen” ja toista tämä.
- 6** Palaa valmiustilaan.

## 8 Työkalut

### 8.1 Tapaaminen

Voit määrittää 5 tapaamista tai muistutusta, joille voit antaa nimet ja asettaa hälytyksen päivämäärän ja kellonajan mukaan.

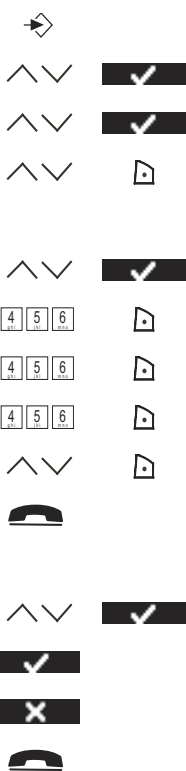

- 1** Siirry valikkoon.
- 2** Valitse ”Työkalut” ja vahvista.
- 3** Valitse ”Tapaamiset” ja vahvista.
- 4** Valitse jokin viidestä tapaamisesta ja valitse ”Vaiht.”.  
Tapaamisen muokkaaminen:
- 5** Valitse ”Muuta” ja vahvista.
- 6** Muokkaa tapaamisen nimeä ja valitse ”Tallen”.
- 7** Muokkaa tapaamisen nimeä ja valitse ”Tallen”.
- 8** Muokkaa kellonaikaa ja valitse ”Tallen”.
- 9** Valitse haluamasi hälytyksääni ja valitse ”Tallen”.
- 10** Palaa valmiustilaan.  
Tapaamisen poistaminen:
- 5** Valitse ”Poista” ja vahvista.
- 6** Vahvista painamalla oikeanpuoleista soft menu key -näppäintä.
- 7** Palaa takaisin painamalla vasemmanpuoleista soft menu key -näppäintä.
- 8** Palaa valmiustilaan.

### 8.2 Sekuntikello

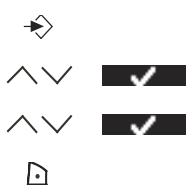

- 1** Siirry valikkoon.
- 2** Valitse ”Työkalut” ja vahvista.
- 3** Valitse ”Sekuntikello” ja vahvista.
- 4** Käynnistä sekuntikello valitsemalla ”Alku”.



- 5** Pysäytä sekuntikello valitsemalla ”Seis”.
- Käynnistä uudelleen valitsemalla uudelleen ”Alku”.
- Nollaa laskuri valitsemalla ”Palaut”.
- 6** Palaa valmiustilaan.

## 9 Lisäkäsiosat ja -tukiasemat

Voit rekisteröidä tukiasemaan enintään 4 käsiosaa. Kuhunkin käsiosaan voi rekisteröidä enintään 4 tukiasemaa, ja käyttäjä voi valita tukiaseman, jota haluaa käyttää.

### 9.1 Uuden käsiosan lisääminen



*Tarpeen vain, jos olet poistanut käsiosan rekisteröinnin tai jos olet ostanut uuden.*

Tukiaseman siirtäminen rekisteröintitilaan:



- 1** Paina ja pidä pohjassa tukiaseman henkilöhakunäppäintä.
- Tukiaseman LED-valo vilkkuu 90 sekunnin ajan. Tänä aikana tukiasema on valmis rekisteröintiin.

Käsiosassa:



- 1** Siirry valikkoon.
- 2** Valitse ”Käsiosa” ja vahvista.
- 3** Valitse ”Rekisteröinti” ja vahvista.
- 4** Valitse ”Rekisteri” ja vahvista.
- 5** Valitse käsiosaan liitettävä numero tukiasemassa (1-4) ja vahvista.
- 6** Näppäile järjestelmän PIN (oletus 0000) ja vahvista.
- 7** Palaa valmiustilaan.

### 9.2 Käsiosan poistaminen



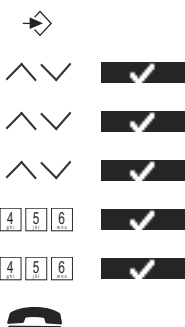





Tämä toiminto on suoritettava muussa kuin poistettavassa käsiosassa.



- 1** Siirry valikkoon.
- 2** Valitse ”Käsiosa” ja vahvista.
- 3** Valitse ”Rekisteröinti” ja vahvista.
- 4** Valitse ”Rek.poisto” ja vahvista.
- 5** Näppäile järjestelmän PIN (oletus 0000) ja vahvista.
- 6** Näppäile poistettava käsiosan numero ja vahvista.
- 7** Palaa valmiustilaan.

### 9.3 Valitse tukiasema

Voit vaihtaa käsiosaa tukiasemasta toiseen. Voit asettaa sen myös valitsemaan automaattisesti tukiaseman, jonka signaali on vahvin. Käsiosa on ensin rekisteröitävä erikseen jokaiseen tukiasemaan.



- |   |   |
|---|---|
|    | <b>1</b> Siirry valikkoon.                                      |
|   | <b>2</b> Valitse ”Käsiosa” ja vahvista.                         |
|   | <b>3</b> Valitse ”Val.tukias.” ja vahvista.                     |
|   | <b>4</b> Valitse ”Manuaalinen” tai ”Automaattinen” ja vahvista. |
|   | Jos olet valinnut vaihtoehdon ”Manuaalinen”:                    |
|   | <b>5</b> Valitse käsiosaan liitettävä tukiasema ja vahvista.    |



*Kun olet aktivoinut automaattisen tukiaseman valinnan ja käsiosa on nykyisen tukiaseman alueen ulkopuolella, käsiosa etsii vahvinta tukiasemaa ainoastaan valmiustilassa (ei kommunikoinnin aikana).*



### 9.4 Intercom-toiminnon käyttö

#### Sisäiseen käsiosaan soittaminen

- |   |   |
|---|---|
| INT   | <b>1</b> Paina vasemmanpuoleista INT-näppäintä.   |
|  | Näytölle tulee teksti ”Käsiosa _”.  |
|  | <b>2</b> Näppäile sen käsiosan sisäinen numero, johon haluat soittaa.                                     |
|   | <b>3</b> Katkaise puhelu painamalla käsiosa paikallaan -näppäintä tai aseta käsiosa takaisin tukiasemaan. |

#### Siirrä ulkoinen puhelu toiseen käsiosaan

Ulkoisen puhelun aikana:

- |   |   |
|---|---|
| INT   | <b>1</b> Paina vasemmanpuoleista INT-näppäintä.   |
|  | Näytölle tulee teksti ”Käsiosa _”.  |
|  | <b>2</b> Näppäile sen käsiosan sisäinen numero, johon haluat soittaa.   |
|   | Ulkoinen keskustelukumppani asetetaan pitoon.   |
|   | <b>3</b> Kun sisäinen keskustelukumppani vastaa, siirrä puhelu painamalla käsiosa paikallaan -näppäintä.  |
|   | TAI   |
| INT   | <b>3</b> Jos sisäinen keskustelukumppani ei vastaa, palaa puheluun ulkoisen keskustelukumppanin kanssa tai siirry keskustelukumppanista toiseen painamalla vasemmanpuoleista INT-näppäintä. |
|  | <b>4</b> Katkaise puhelu painamalla käsiosa paikallaan -näppäintä tai aseta käsiosa takaisin tukiasemaan.   |

#### Puhelinneuvottelu

Voit käydä keskustelua samanaikaisesti kahden käsiosan ja ulkolinjan välityksellä.

Ulkoisen puhelun aikana:

- |     |   |
|-----|---|
| INT | <b>1</b> Paina vasemmanpuoleista INT-näppäintä. |
|     | Näytölle tulee teksti ”Käsiosa _”.              |



INT



**2** Näppäile sen käsiosan sisäinen numero, johon haluat soittaa.

Ulkoinen keskustelukumppani asetetaan pitoon.

**3** Kun sisäinen keskustelukumppani vastaa, valitse ”Konf.”.

TAI

**3** Jos sisäinen keskustelukumppani ei vastaa, palaa keskusteluun ulkoisen keskustelukumppanin kanssa painamalla vasemmanpuoleista INT-näppäintä.

**4** Katkaise puhelu painamalla käsiosa paikallaan -näppäintä tai aseta käsiosa takaisin tukiasemaan.

### Ulkoisen puhelun vastaanottaminen sisäisen kommunikoinnin aikana

Jos käyt sisäpuhelia toisen käsiosan välityksellä, voit silti vastaanottaa ulkopuheluita.

Saapuvan puhelun vastaanottaminen:



**1** Paina käsiosa paikallaan -näppäintä. Nyt sisäinen kommunikaatio keskeytyy.



**2** Paina käsiosa pois paikaltaan -näppäintä. Nyt kommunikoit ulkoisen soittajan kanssa.

## 10 Vianmääritys

Oire	Mahdollinen syy	Ratkaisu
Tyhjä näyttö	Akkuja ei ole ladattu	Tarkista akkujen paikka
		Lataa akut
	Käsiosa pois päältä	Kytke käsiosa päälle
Ei ääntä	Puhelinjohto kytketty huonosti	Tarkista puhelinjohdon liitäntä
	Toinen käsiosa käyttää linjaa	Odot, kunnes toisen käsiosan puhelu loppuu
Kuvake  vilkkuu	Käsiosa kantama-alueen ulkopuolella	Tuo käsiosa lähemmäs tukiasemaa
	Tukiasemaan ei tule virtaa	Tarkista tukiaseman johdon kytkentä
	Käsiosaa ei ole rekisteröity tukiasemaan	Rekisteröi käsiosa tukiasemaan
Tukiasema tai käsiosa ei soi	Soittoääni on mykistetty tai hiljaisella	Säädä soittoäänän voimakkuutta
Soitonsiirto PABX:ssa ei onnistu	Flash-aika on liian lyhyt tai liian pitkä	Muuta flash-aikaa
Puhelin ei reagoi näppäinten painamiseen	Käsittelyvirhe	Ota akut irti ja aseta ne takaisin paikalleen

## 11 Tekniset tiedot Tekniset ominaisuudet

Standardi	<b>DECT (Digital Enhanced Cordless Telecommunications)</b> <b>GAP (Generic Access Profile)</b>
Taajuusalue	1880 MHz - 1900 MHz
Kanavamäärä	120 kaksisuuntaista kanavaa
Modulointi	GFSK
Puheen koodaus	32 kbit/s
Päästöteho	10 mW (keskimääräinen teho/kanava)
Alue	300 m avoimessa maastossa / sisällä enintään 50 m
Käsiosien määrä	Enintään 4
Tukiaseman tehonsyöttö	230V / 50 Hz / 6V DC 300mA
Käsiosan akut:	2 ladattavaa akkua AAA, NiMh 1,2 V, 700 mA
Käsiosan itsenäinen toiminta	110 tuntia valmiustilassa
Käsiosan puheaika	11 tuntia
Normaalit käyttöolosuhteet	+5 °C - +45 °C
Valintatapa	Pulssi/ääni
Flash-aika	100 tai 250 ms

## 12 Takuu

### 12.1 Takuu aika

Topcom-laitteilla on 24 kuukauden takuu. Takuu aika alkaa sinä päivänä, jolloin uusi laite ostetaan. Akkujen ja paristojen takuu aika on 6 kuukautta ostosta. Jos tarvikkeet tai viat aiheuttavat laitteelle vähäisiä toimintahäiriöitä tai laskevat hieman laitteen arvoa, takuu ei korvaa tällaisia menetyksiä. Takuu myönnetään alkuperäistä kuittia vastaan, jos kuitissa on mainittu ostopäivämäärä ja laitteen tyyppi.

### 12.2 Takuutoimet

Palauta viallinen laite Topcomin palvelukeskukseen ostokuitin kera.

Jos laitteeseen tulee vika takuuajana, Topcom tai sen virallisesti nimetty palvelukeskus korjaa materiaali- tai valmistusvirheistä johtuvat viat maksutta.

Topcom voi täyttää takuuvollisuutensa joko korjaamalla tai vaihtamalla viallisen laitteen tai viallisen laitteen osan. Jos laite vaihdetaan uuteen, tilalle annetun laitteen väri ja malli voivat poiketa alkuperäisen laitteen väristä ja mallista.

Alkuperäinen ostopäivämäärä määrää takuuajan alkamisajankohdan. Takuu aika ei pitene, jos Topcom tai sen nimetty palvelukeskus vaihtaa tai korjaa laitteen.

### 12.3 Takuuehdot

Takuu ei korvaa vääränlaisesta käsittelystä tai käytöstä johtuvia vaurioita eikä vaurioita, jotka johtuvat muiden kuin Topcomin suosittelemien, ei-alkuperäisten osien tai lisälaitteiden käytöstä. Topcom langattomat puhelimet on suunniteltu toimimaan ainoastaan uudelleenladattavilla akuilla. Takuu ei korvaa vahinkoja, jotka aiheutuvat sellaisten paristojen käytöstä, joita ei voi ladata uudelleen.

Takuu ei korvaa ulkopuolisten tekijöiden, kuten salama-, vesi- tai palovahinko, aiheuttamia vaurioita eikä kuljetuksen aikana aiheutuneita vaurioita.

Takuu ei ole voimassa, jos laitteen sarjanumero on muutettu, poistettu tai tehty lukukelvottomaksi. Takuu ei ole voimassa, jos ostaja tai muu kuin Topcomin virallisesti valtuuttama palvelukeskus on korjannut, muuttanut tai muunnellut laitetta.

### 13 Laitteen hävittäminen (ympäristöystävällisesti)



Kun et enää käytä laitetta, älä heitä sitä tavallisen kotitalousjätteen sekaan vaan vie se sähkö- ja elektroniikkalaitteiden kierrätystä varten perustettuun keräyspisteeseen. Tuotteessa, käyttöoppaassa ja/tai tuotepakkauksessa on tästä kertova merkki. Jos viet laitteen kierrätyspisteeseen, joitakin sen osia voidaan käyttää uudelleen. Käyttämällä uudelleen tuotteen joitakin osia tai raaka-aineita teet arvokasta

ympäristötyötä.

Ota yhteyttä paikallisiin viranomaisiin, jos tarvitset lisätietoja alueellasi sijaitsevista keräyspisteistä.

### 14 Puhdistus

Puhdista puhelin hieman kostutetulla liinalla tai sähköisyyttä poistavalla liinalla. Älä koskaan käytä puhdistusaineita tai hankausliuoksia.

### 15 ECO-tila (säteily vähäistä)

- Tämä (DECT-standardin mukainen) langaton puhelin helpottaa käyttöä pienellä säteilymäärällä.
- Tukiaseman ja käsiaseman välisen radiosignaalin aiheuttama säteily pienenee minimiin käsiosan ollessa tukiasemassa.
- Radiosignaalin säteilymäärä kasvaa normaalille tasolle vain, kun käsiosa on poissa tukiasemasta tai vastaanotetaan puhelu.
- Tämä ei tarkoita, että normaalista DECT-säteilystä olisi haittaa terveydelle.
- Vähäisen säteilyn tila estää tarpeetonta DECT-säteilykuormitusta, kun tukiaseman ja käsiosan välinen tiedonsiirto ei ole tarpeen.
- Teknisistä syistä vähäisen säteilyn tilassa ei voida käyttää lisäkäsiosia (lisäkäsiosa, joka ei ole tukiaseman välittömässä läheisyydessä, "etsisi aina tukiasemaa" heikon radiosignaalin johdosta).
- Tehdasasetusten mukaan vähäisen säteilyn tila on käytössä.
- Se poistetaan automaattisesti käytöstä, jos kirjaat sisään lisäkäsiosan.
- Vähäisen säteilyn tila otetaan automaattisesti jälleen käyttöön, kun kirjaat ulos kaikki lisäkäsiosat (vain yksi käsiosa voi olla kirjattuna tukiasemaan).
- Käsiosien kirjaaminen sisään ja ulos selostetaan käyttöohjeessa.

## Ελληνικά

### 1 Οδηγίες ασφαλείας

- Χρησιμοποιείτε μόνο το παρεχόμενο βύσμα του φορτιστή. Μην χρησιμοποιείτε άλλους φορτιστές γιατί μπορεί να καταστραφούν τα στοιχεία της μπαταρίας.
- Τοποθετείτε μόνο επαναφορτιζόμενες μπαταρίες του ίδιου τύπου. Μην χρησιμοποιείτε συνηθισμένες, μη-επαναφορτιζόμενες μπαταρίες. Τοποθετείτε επαναφορτιζόμενες μπαταρίες με τρόπο ώστε να συνδέονται στους σωστούς πόλους (όπως υποδεικνύεται στην υποδοχή μπαταρίας του ακουστικού).
- Μην αγγίζετε τον φορτιστή και τις επαφές του βύσματος με αιχμηρά ή μεταλλικά αντικείμενα.
- Μπορεί να επηρεαστεί η λειτουργία ορισμένων ιατρικών συσκευών.
- Το ακουστικό μπορεί να προκαλέσει ένα δυσάρεστο βουητό στα ακουστικά βαρηκοΐας.
- Μην τοποθετείτε τη βασική μονάδα σε χώρο με υγρασία ή σε απόσταση μικρότερη από 1,5m από παροχή νερού. Το ακουστικό δεν πρέπει να βραχεί.
- Μην χρησιμοποιείτε το τηλέφωνο σε περιβάλλον όπου υπάρχει κίνδυνος έκρηξης.
- Απορρίψτε τις μπαταρίες και συντηρείτε το τηλέφωνο με τρόπο φιλικό προς το περιβάλλον.
- Καθώς αυτό το τηλέφωνο δεν μπορεί να χρησιμοποιηθεί σε περίπτωση διακοπής τροφοδοσίας, για τις κλήσεις έκτακτης ανάγκης θα πρέπει να χρησιμοποιείτε κάποιο τηλέφωνο που δεν εξαρτάται από το δίκτυο παροχής ρεύματος, π.χ. κάποιο κινητό τηλέφωνο.

### 2 Ξεκινώντας

#### 2.1 Τρόπος χρήσης του οδηγού χρήσης

Στον παρόν οδηγό χρήσης, χρησιμοποιείται η ακόλουθη μέθοδος για την αποσαφήνιση των οδηγιών:

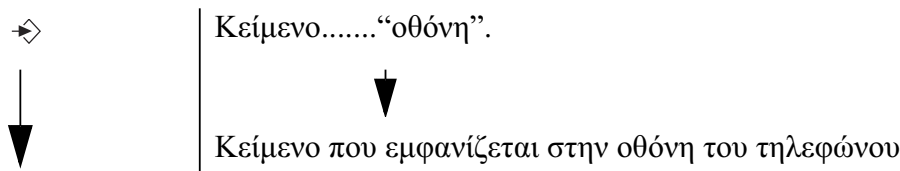

Πλήκτρο που πρέπει να πατήσετε. Αυτό το πλήκτρο μπορεί να είναι ένα πλήκτρο επιλογής (Ανατρέξτε στην ενότητα “2.4 Πλήκτρα/Φωτεινή ένδειξη”). Όταν το πλήκτρο επιλογής εμφανίζεται ως σύμβολο, εμφανίζεται στην αριστερή στήλη. Όταν το πλήκτρο επιλογής εμφανίζεται ως κείμενο, το αριστερό ή το δεξιό πλήκτρο επιλογής εμφανίζεται στην αριστερή στήλη και το κείμενο εμφανίζεται στη δεξιά στήλη εντός εισαγωγικών.

#### 2.2 Εγκατάσταση της βάσης

Για να εγκαταστήσετε τη βάση κάντε τα εξής:

- 1** Συνδέστε το ένα άκρο του προσαρμογέα στην πρίζα και το άλλο άκρο στην υποδοχή του προσαρμογέα στο πίσω μέρος της βάσης.
- 2** Συνδέστε το ένα άκρο του καλωδίου του τηλεφώνου στην πρίζα τηλεφωνικής γραμμής και το άλλο άκρο στο κάτω μέρος της βάσης.
- 3** Τοποθετήστε το καλώδιο τηλεφώνου και το καλώδιο τροφοδοσίας στους οδηγούς της βάσης όπως φαίνεται στην εικόνα 2Α.

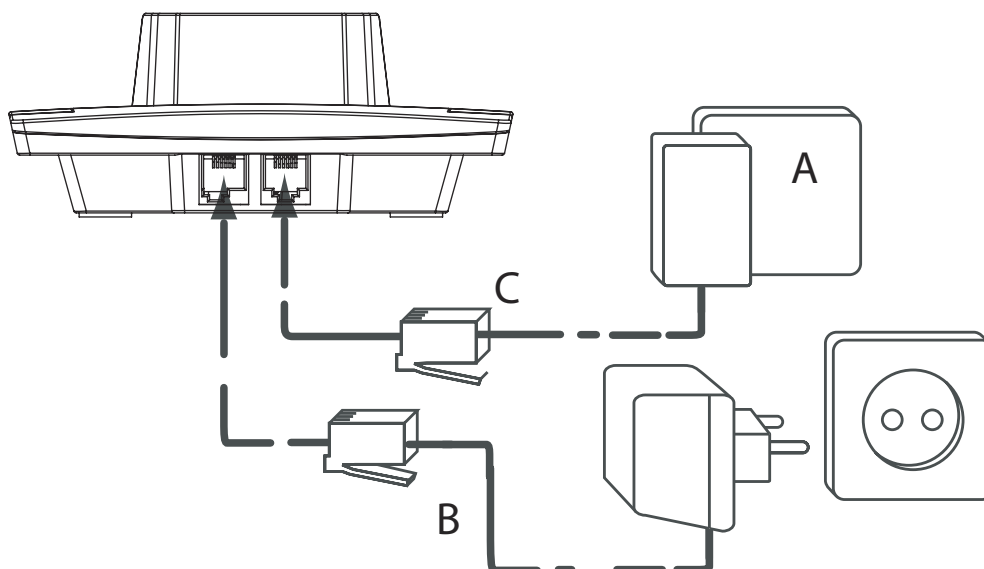

- 2A Πίσω όψη της βάσης -

A. Πρίζα τηλεφώνου

B. Καλώδιο τροφοδοσίας

C. Καλώδιο τηλεφώνου

### 2.3 Εγκατάσταση του ακουστικού

- 1 Ανοίξτε την υποδοχή μπαταρίας όπως φαίνεται στην εικόνα 2B.
- 2 Τοποθετήστε τις μπαταρίες προσέχοντας την πολικότητα (+ και -).
- 3 Κλείστε την υποδοχή μπαταρίας.
- 4 Αφήστε το ακουστικό στη μονάδα βάσης για 20 ώρες. Η ένδειξη Γραμμή/Φόρτιση  της βάσης ανάβει.

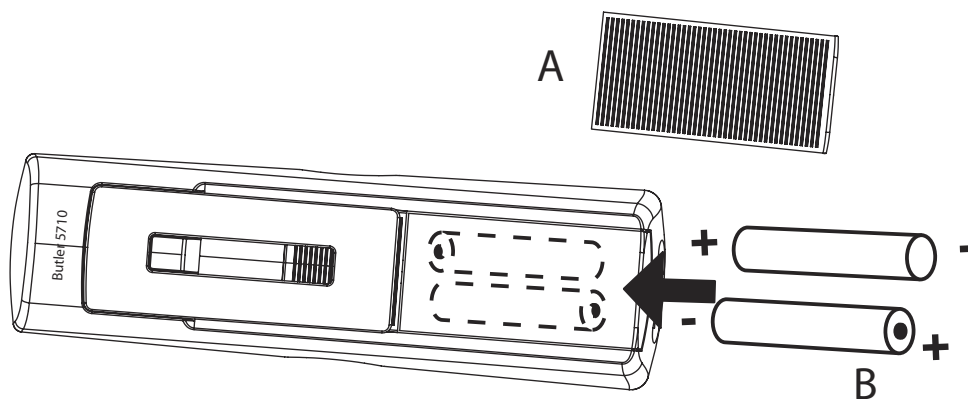

- 2B Πίσω όψη του ακουστικού -

A. Κάλυμμα

B. Επαναφορτιζόμενες μπαταρίες



Πριν χρησιμοποιήσετε το τηλέφωνο για πρώτη φορά, πρέπει να φορτίσετε την μπαταρία για 20 ώρες. Διαφορετικά, επηρεάζεται αρνητικά η λειτουργία του τηλεφώνου.



## 2.4 Πλήκτρα/Φωτεινή ένδειξη

### Ακουστικό

1. Οθόνη
2. Επάνω πλήκτρο/Επανάκλησης
3. Δεξιό πλήκτρο μενού
4. Δεξιό πλήκτρο/Flash
5. Πλήκτρο τερματισμού κλήσης / απενεργοποίησης
6. Αλφαριθμητικά πλήκτρα
7. Κλείδωμα πληκτρολογίου
8. Πλήκτρο απενεργοποίησης κουδουνίσματος
9. Κάτω πλήκτρο/καταγραφής κλήσεων
10. Πλήκτρο πραγματοποίησης κλήσης/ Ανοιχτής συνομιλίας/ πλήκτρο ενεργοποίησης
11. Αριστερό πλήκτρο/INT
12. Πλήκτρο OK
13. Αριστερό πλήκτρο μενού

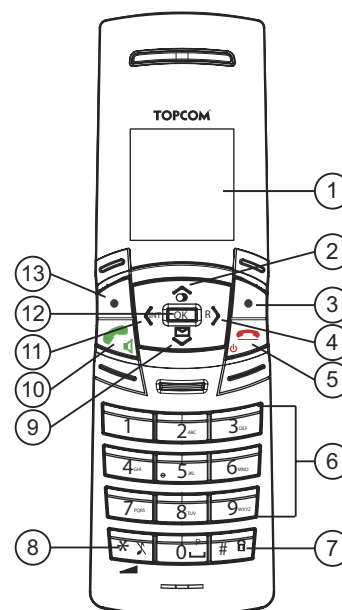

- 2Γ Ακουστικό -

### Βάση

14. Φωτεινή ένδειξη λειτουργίας/  
Ενεργοποίησης/Ακουστικού στη μονάδα βάσης
15. Πλήκτρο αναζήτησης

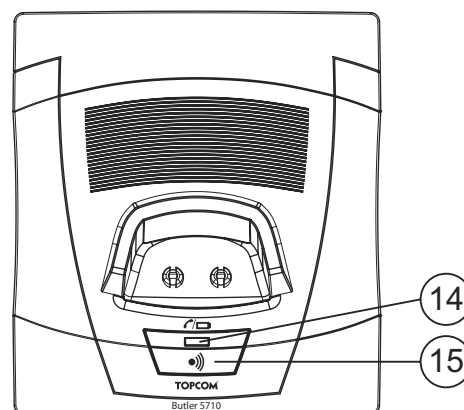

- 2Δ Βάση -

## 2.5 Σύμβολα

	Πραγματοποίηση κλήσης		Κλείδωμα πληκτρολογίου
	Τερματισμός κλήσης		Ενεργή αφύπνιση
	Αναπάντητες κλήσεις στη λίστα κλήσεων*		Το ακουστικό δεν έχει καταχωρηθεί ή βρίσκεται εκτός εμβέλειας
	Απενεργοποίηση έντασης κουδουνίσματος ακουστικού		Άδεια μπαταρία
	Το ακουστικό βρίσκεται εντός εμβέλειας βάσης		Χαμηλή μπαταρία
	Εσωτερική κλήση		Ενδιάμεση στάθμη μπαταρίας
	Ανοιχτή συνομιλία		Πλήρης μπαταρία
	Νέο φωνητικό μήνυμα		

\* Εάν υποστηρίζεται η υπηρεσία Αναγνώρισης γραμμής εισερχόμενης κλήσης από την τηλεφωνική γραμμή.

## 2.6 Πλήκτρα οθόνης

Τα πλήκτρα οθόνης (πλήκτρα επιλογής) βρίσκονται ακριβώς κάτω από την οθόνη. Η λειτουργία αυτών των δύο πλήκτρων αλλάζει ανάλογα με την κατάσταση λειτουργίας. Η τρέχουσα λειτουργία εμφανίζεται με τη μορφή εικονιδίου ή κειμένου ακριβώς κάτω από τα δύο πλήκτρα οθόνης.

	Ευρητήριο		Σίγαση
	OK/Επιβεβαίωση		Πίσω
	Μενού		Κανένα πλήκτρο
	Διαγραφή		





## 2.7 Ενδεικτική λυχνία βάσης

Η ενδεικτική λυχνία (14) υποδεικνύει τις ακόλουθες καταστάσεις:



- Σβηστή: η βάση δεν είναι συνδεδεμένη στο ρεύμα ή το ακουστικό δεν είναι τοποθετημένο στη βάση για φόρτιση
- Αναμμένη: φόρτιση ακουστικού
- Αναβοσβήνει αργά: Όταν είναι σηκωμένο το ακουστικό ή κατά τη διάρκεια του κουδουνίσματος
- Αναβοσβήνει γρήγορα: κατά την καταχώριση

## 2.8 Περιήγηση στα μενού

Το τηλέφωνο Butler 5710 διαθέτει ένα εύχρηστο σύστημα μενού. Κάθε μενού οδηγεί σε μια λίστα επιλογών. Στην παρακάτω παράγραφο εμφανίζεται ο χάρτης μενού.

	<b>1</b> Όταν το ακουστικό είναι ενεργοποιημένο και βρίσκεται σε κατάσταση αναμονής, πατήστε το πλήκτρο μενού  για να ανοίξετε το κύριο μενού.
	<b>2</b> Μεταβείτε στην επιθυμητή επιλογή μενού.
	<b>3</b> Πατήστε το πλήκτρο μενού για να εμφανίσετε περισσότερες επιλογές ή για να επιβεβαιώσετε τη ρύθμιση που εμφανίζεται.

### Για έξοδο από το μενού ή για να μετακινηθείτε ένα επίπεδο προς τα πίσω

	Για να μεταβείτε στο προηγούμενο επίπεδο στο μενού, πατήστε το πλήκτρο μενού.
	Για να ακυρώσετε μια λειτουργία και να επιστρέψετε στην κατάσταση αναμονής οποιαδήποτε στιγμή, πατήστε το πλήκτρο τερματισμού κλήσης.

## 2.9 Επισκόπηση των μενού

Μενού	Στοιχεία υπομενού
Ακουστικό	Ήχος Ένταση κουδουνιού Όνομα ακουστικού Ήχος πληκτρολογίου Αντίθεση Αυτόματη απάντηση Πρόθεμα Επιλογή βάσης Γλώσσα Καταχώρηση
Ρυθμίσεις βάσης	Ήχος Ένταση κουδουνιού Σύστημα κλήσης Επανάκληση Κωδικός συστήματος
Ξυπνητήρι	Ρυθμίσεις ξυπνητηριού Ημέρα & ώρα Εμφάνιση ώρας
Εργαλεία	Συνάντηση Χρονόμετρο
Σβήσιμο	

## 3 Χρήση του τηλεφώνου

### 3.1 Ενεργοποίηση/Απενεργοποίηση ακουστικού



- 1 Πατήστε και κρατήστε πατημένο το πλήκτρο απενεργοποίησης για να απενεργοποιήσετε το ακουστικό.
- 2 Πατήστε το πλήκτρο πραγματοποίησης κλήσης ή τοποθετήστε το ακουστικό στη βάση για να ενεργοποιήσετε ξανά το ακουστικό.

### 3.2 Αλλαγή της γλώσσας μενού



- 1 Μεταβείτε στο μενού.
- 2 Επιλέξτε “Ακουστικό” και επιβεβαιώστε.
- 3 Επιλέξτε “Γλώσσα” και επιβεβαιώστε.
- 4 Επιλέξτε μια γλώσσα και επιβεβαιώστε.  
Στην οθόνη εμφανίζεται το μήνυμα “Αποθήκευση”.
- 5 Πατήστε το πλήκτρο πραγματοποίησης κλήσης για να επιστρέψετε στην κατάσταση αναμονής.



Τα βέλη ⇄ δηλώνουν ότι είναι διαθέσιμες περισσότερες επιλογές στο μενού.

### 3.3 Πραγματοποίηση κανονικής τηλεφωνικής κλήσης

#### Άμεση κλήση



- 1 Για να ξεκινήσετε την κλήση, πατήστε το πλήκτρο πραγματοποίησης κλήσης.
- 2 Πληκτρολογήστε τον αριθμό τηλεφώνου.
- 3 Πατήστε το πλήκτρο τερματισμού κλήσης για να κλείσετε το τηλέφωνο ή τοποθετήστε ξανά το ακουστικό στη βάση.

#### Προκαθορισμένη κλήση

Η δυνατότητα προκαθορισμένης κλήσης σας επιτρέπει να πληκτρολογήσετε και να τροποποιήσετε έναν αριθμό πριν τον καλέσετε.



- 1 Πληκτρολογήστε έναν αριθμό μέχρι 24 ψηφία.  
Κρατήστε πατημένο το πλήκτρο 0 για να εισαγάγετε μια παύση. Στην οθόνη εμφανίζεται ένα “P”.
- 2 Πατήστε το πλήκτρο μενού για να διορθώσετε τον αριθμό.
- 3 Για να ξεκινήσετε την κλήση, πατήστε το πλήκτρο πραγματοποίησης κλήσης.
- 4 Πατήστε το πλήκτρο τερματισμού κλήσης για να κλείσετε το τηλέφωνο ή τοποθετήστε ξανά το ακουστικό στη βάση.

#### Επανάκληση αριθμού από τη λίστα

Μπορείτε να επαναλάβετε την κλήση των τελευταίων 10 αριθμών που καλέσατε. Εάν έχετε αποθηκεύσει ένα όνομα στο ευρετήριο για το συγκεκριμένο αριθμό, εμφανίζεται το αντίστοιχο όνομα.



- 1 Πατήστε το πλήκτρο επανάκλησης.
- 2 Επιλέξτε έναν αριθμό. Εάν ο αριθμός είναι καταχωρημένος στο ευρετήριο, θα εμφανιστεί το όνομα.
- 3 Για να ξεκινήσετε την κλήση, πατήστε το πλήκτρο πραγματοποίησης κλήσης ή πατήστε “Επιλογή”.
- 4 Εάν έχετε επιλέξει “Επιλογή”, επιλέξτε ένα από τα παρακάτω:  
“Διαγραφή κλήσης”: για να διαγράψετε τον αριθμό από τη λίστα κλήσεων,  
“Αποθήκευση αριθμού”: για να αποθηκεύσετε τον αριθμό στο ευρετήριο,  
“Διαγραφή όλων”: για να διαγράψετε τη λίστα κλήσεων.
- 5 Επιβεβαιώστε την επιλογή.
- 6 Πατήστε το πλήκτρο πραγματοποίησης κλήσης για να επιστρέψετε στην κατάσταση αναμονής.

### 3.4 Λήψη τηλεφωνικής κλήσης

Όταν λαμβάνετε μια εξωτερική κλήση, στην οθόνη εμφανίζεται το μήνυμα “Εξωτερική κλήση”.

Για να απαντήσετε στην κλήση:



- 1 Πατήστε το πλήκτρο πραγματοποίησης κλήσης.  
Η Σηκώστε το ακουστικό από τη βάση εάν είναι ενεργοποιημένη η επιλογή “Αυτόματη απάντηση” (Ανατρέξτε στην ενότητα “6.5 Αυτόματη απάντηση”).  
Στην οθόνη εμφανίζεται το εικονίδιο κλήσης σε εξέλιξη . Η διάρκεια της κλήσης εμφανίζεται μετά από 15 δευτερόλεπτα.
- 2 Πατήστε το πλήκτρο τερματισμού κλήσης για να κλείσετε το τηλέφωνο ή τοποθετήστε ξανά το ακουστικό στη βάση.



Μπορείτε να απενεργοποιήσετε την ένταση κουνούσματος κατά τη διάρκεια μιας εισερχόμενης κλήσης, επιλέγοντας “Αθόρυβο”.

### 3.5 Λειτουργία ανοιχτής συνομιλίας

Η δυνατότητα ανοιχτής συνομιλίας σας επιτρέπει να μιλάτε στο τηλέφωνο χωρίς να κρατάτε το ακουστικό. Επίσης επιτρέπει σε άλλα άτομα που βρίσκονται στο χώρο να ακούν τη συνομιλία σας.



- 1 Για να ενεργοποιήσετε τη λειτουργία ανοιχτής συνομιλίας, πατήστε το πλήκτρο ανοιχτής συνομιλίας κατά τη διάρκεια της κλήσης.

### 3.6 Ρύθμιση έντασης ακουστικού/ανοιχτής συνομιλίας



- 1 Πατήστε επάνω ή κάτω για να επιλέξετε το επίπεδο έντασης ήχου από 1 έως 5 κατά τη διάρκεια μια κανονικής κλήσης ή μιας κλήσης ανοιχτής συνομιλίας.

### 3.7 Λειτουργία εμπιστευτικότητας (Λειτουργία σίγασης)

Για να απενεργοποιήσετε το μικρόφωνο, ώστε να μην μπορεί να σας ακούσει το άτομο που βρίσκεται στην άλλη άκρη της γραμμής.



- 1 Κατά τη διάρκεια μιας συνομιλίας, πατήστε το πλήκτρο μενού για να απενεργοποιήσετε το μικρόφωνο.

Στην οθόνη εμφανίζεται το μήνυμα “Σίγαση ενεργή”.



- 2 Επιλέξτε “Απενεργοποίηση” για να ενεργοποιήσετε ξανά το μικρόφωνο.

### 3.8 Εντοπισμός ακουστικού (Λειτουργία αναζήτησης)



- 1 Πατήστε το πλήκτρο αναζήτησης που βρίσκεται στη βάση.  
Όλα τα ακουστικά που έχουν καταχωριστεί στη βάση θα ηχήσουν για 30 δευτερόλεπτα.



- 2 Πατήστε οποιοδήποτε πλήκτρο στο ακουστικό για να διακόψετε την αναζήτηση.

### 3.9 Κλειδώμα πληκτρολογίου

Για να κλειδώσετε το πληκτρολόγιο για να αποφύγετε την εσφαλμένη πραγματοποίηση κλήσης κατά τη μεταφορά του ακουστικού.

Σε κατάσταση αναμονής:



- 1 Κρατήστε πατημένο το πλήκτρο κλειδώματος πληκτρολογίου (πλήκτρο 7 - Εικόνα 2Γ) μέχρι να εμφανιστεί το μήνυμα “Κλειδωμένο” και το εικονίδιο κλειδωμένου πληκτρολογίου στην οθόνη.



- 2 Για να ξεκλειδώσετε το πληκτρολόγιο, επιλέξτε “Ξεκλειδώμα” και πατήστε το πλήκτρο κλειδώματος πληκτρολογίου.

### 3.10 Χρήση του αλφαριθμητικού πληκτρολογίου





Στο τηλέφωνό σας μπορείτε επίσης να πληκτρολογήσετε αλφαριθμητικούς χαρακτήρες. Η δυνατότητα αυτή είναι χρήσιμη για την καταχώριση ενός ονόματος στο ευρετήριο, την αντιστοίχιση ενός ονόματος στο ακουστικό, ...

Για να επιλέξετε ένα γράμμα, πατήστε το αντίστοιχο πλήκτρο όσες φορές χρειάζεται.

Για παράδειγμα, για να επιλέξετε το γράμμα ‘Α’, πατήστε το πλήκτρο ‘2’ μια φορά. Για να επιλέξετε το γράμμα ‘Β’, πατήστε το πλήκτρο ‘2’ δύο φορές και ούτω καθ' εξής.

Για να επιλέξετε το γράμμα ‘Α’ και στη συνέχεια το γράμμα ‘Β’, πατήστε το πλήκτρο ‘2’ μια φορά, περιμένετε μέχρι να μετακινηθεί ο δρομέας στον επόμενο χαρακτήρα και στη συνέχεια πατήστε το πλήκτρο ‘2’ δυο φορές. Κατά την πληκτρολόγηση του κειμένου, ο διαθέσιμος χαρακτήρας για κάθε πλήκτρο εμφανίζεται στο κάτω μέρος της οθόνης.













Μπορείτε να αλλάξετε το σύνολο χαρακτήρων εισαγωγής από Αγγλικά (abc) σε Λατινικά (a), Ελληνικά (ΑΒΓ) ή Ρώσικα (ΑΒВ) κρατώντας πατημένο το πλήκτρο # για 2 δευτερόλεπτα.

	Πατήστε το πλήκτρο '0' για να επιλέξετε ένα κενό.
	Πατήστε το πλήκτρο * για εναλλαγή μεταξύ πεζών και κεφαλαίων.
	Πατήστε και κρατήστε πατημένο το πλήκτρο # για 2 δευτερόλεπτα για να αλλάξετε το σύνολο χαρακτήρων εισαγωγής.
	Πατήστε το πλήκτρο μενού για να διορθώσετε τον αριθμό.





## 4 Ευρετήριο

Σε κάθε ακουστικό μπορείτε να αποθηκεύσετε έως 200 ονόματα και αριθμούς. Τα ονόματα μπορούν να έχουν μήκος έως 16 χαρακτήρες και οι αριθμοί έως 24 ψηφία.







### 4.1 Για να προσθέσετε μια καταχώριση

	<b>1</b> Πατήστε το πλήκτρο μενού.
	Εάν το ευρετήριο είναι κενό, στην οθόνη εμφανίζεται το μήνυμα “Ευρετήριο κενό”. Εάν υπάρχουν αποθηκευμένα ονόματα, εμφανίζονται στην οθόνη.
 	<b>2</b> Πατήστε “Επιλογή”.
 	<b>3</b> Επιλέξτε “Νέα καταχώριση” και επιβεβαιώστε.
 	<b>4</b> Χρησιμοποιήστε το πληκτρολόγιο για να πληκτρολογήσετε το όνομα και επιλέξτε “Αποθήκευση”.
 	<b>5</b> Χρησιμοποιήστε το πληκτρολόγιο για να πληκτρολογήσετε τον αριθμό και επιλέξτε “Αποθήκευση”.
	<b>6</b> Επιλέξτε την επιθυμητή μελωδία κουδουνίσματος και επιλέξτε “Αποθήκευση”.
	<b>7</b> Επιστρέψτε στην κατάσταση αναμονής.

### 4.2 Για να καλέσετε μια καταχώριση

	<b>1</b> Πατήστε το πλήκτρο μενού.
	<b>2</b> Επιλέξτε το επιθυμητό όνομα ή χρησιμοποιήστε το πληκτρολόγιο για να εισαγάγετε το πρώτο γράμμα του ονόματος.
	<b>3</b> Για να ξεκινήσετε την κλήση, πατήστε το πλήκτρο πραγματοποίησης κλήσης.
	<b>4</b> Επιστρέψτε στην κατάσταση αναμονής.

### 4.3 Εμφάνιση λεπτομερειών

	<b>1</b> Πατήστε το πλήκτρο μενού.
	<b>2</b> Επιλέξτε το επιθυμητό όνομα ή χρησιμοποιήστε το πληκτρολόγιο για να εισαγάγετε το πρώτο γράμμα του ονόματος.
	<b>3</b> Πατήστε “Επιλογή”.
 	<b>4</b> Επιλέξτε “Εμφάνιση λεπτομερειών” και επιβεβαιώστε.
	Στην οθόνη εμφανίζεται το όνομα, ο αριθμός και η μελωδία κουδουνίσματος που αντιστοιχούν στην καταχώριση.
	<b>5</b> Επιστρέψτε στην κατάσταση αναμονής.

#### 4.4 Διαγραφή μιας καταχώρισης ή όλων των καταχωρίσεων



- 1 Πατήστε το πλήκτρο μενού.
- 2 Επιλέξτε το επιθυμητό όνομα ή χρησιμοποιήστε το πληκτρολόγιο για να εισαγάγετε το πρώτο γράμμα του ονόματος.
- 3 Πατήστε “Επιλογή”.

Για να διαγράψετε μια καταχώριση:

- 4 Επιλέξτε “Διαγραφή καταχώρισης” και επιβεβαιώστε.

Για να διαγράψετε όλες τις καταχωρίσεις:

- 4 Επιλέξτε “Διαγραφή όλων” και επιβεβαιώστε.
- 5 Πατήστε το αριστερό πλήκτρο μενού για ακύρωση ή το δεξιό πλήκτρο μενού για επιβεβαίωση.
- 6 Επιστρέψτε στην κατάσταση αναμονής.

#### 4.5 Επεξεργασία ονόματος και αριθμού



- 1 Πατήστε το πλήκτρο μενού.
- 2 Επιλέξτε το επιθυμητό όνομα ή χρησιμοποιήστε το πληκτρολόγιο για να εισαγάγετε το πρώτο γράμμα του ονόματος.
- 3 Πατήστε “Επιλογή”.
- 4 Επιλέξτε “Επεξεργασία καταχώρισης” και επιβεβαιώστε.
- 5 Πατήστε το πλήκτρο μενού για να διαγράψετε την καταχώριση και χρησιμοποιήστε το πληκτρολόγιο για να αλλάξετε το όνομα.
- 6 Επιλέξτε “Αποθήκευση”.
- 7 Επεξεργαστείτε τον αριθμό και επιλέξτε “Αποθήκευση”.
- 8 Επιλέξτε την επιθυμητή μελωδία κουδουνίσματος και επιλέξτε “Αποθήκευση”.
- 9 Επιστρέψτε στην κατάσταση αναμονής.

#### 4.6 Αντιγραφή καταχώρισης ευρετηρίου σε άλλο ακουστικό



- 1 Πατήστε το πλήκτρο μενού.
- 2 Επιλέξτε το επιθυμητό όνομα ή χρησιμοποιήστε το πληκτρολόγιο για να εισαγάγετε το πρώτο γράμμα του ονόματος.
- 3 Πατήστε “Επιλογή”.
- 4 Επιλέξτε “Αντιγραφή καταχώρισης” και επιβεβαιώστε.  
Εμφανίζονται τα διαθέσιμα ακουστικά (όλα τα ακουστικά που έχουν καταχωριστεί στη βάση).
- 5 Επιλέξτε το ακουστικό που θέλετε και επιβεβαιώστε.  
Στην οθόνη εμφανίζεται το μήνυμα “Αντιγραφή στο ακουστικό x”.  
Στην οθόνη του ακουστικού προορισμού εμφανίζεται το μήνυμα “Λήψη καταχώρισης ευρετηρίου;”.
- 6 Στο ακουστικό προορισμού πατήστε το δεξί πλήκτρο μενού για επιβεβαίωση ή το αριστερό πλήκτρο μενού για ακύρωση της μεταφοράς.
- 7 Επιστρέψτε στην κατάσταση αναμονής.

## 4.7 Αντιγραφή όλων των καταχωρίσεων ευρετηρίου σε άλλο ακουστικό



Κατά την αντιγραφή όλων των καταχωρίσεων ενός ακουστικού σε ένα άλλο, διαγράφονται όλες οι υπάρχουσες καταχωρίσεις στο ακουστικό προορισμού.



- 1** Πατήστε το πλήκτρο μενού.
- 2** Επιλέξτε το επιθυμητό όνομα ή χρησιμοποιήστε το πληκτρολόγιο για να εισαγάγετε το πρώτο γράμμα του ονόματος.
- 3** Πατήστε “Επιλογή”.
- 4** Επιλέξτε “Αντιγραφή όλων” και επιβεβαιώστε.  
Εμφανίζονται τα διαθέσιμα ακουστικά (όλα τα ακουστικά που έχουν καταχωριστεί στη βάση).
- 5** Επιλέξτε το ακουστικό που θέλετε και επιβεβαιώστε.  
Στην οθόνη εμφανίζεται το μήνυμα “Αντιγραφή στο ακουστικό x”.  
Στην οθόνη του ακουστικού προορισμού εμφανίζεται το μήνυμα “Αντικατάσταση όλων των καταχωρίσεων ευρετηρίου;”.
- 6** Στο ακουστικό προορισμού πατήστε το δεξί πλήκτρο μενού για επιβεβαίωση ή το αριστερό πλήκτρο μενού για ακύρωση της μεταφοράς.
- 7** Επιστρέψτε στην κατάσταση αναμονής.

## 5 Αναγνώριση καλούντος

### 5.1 Κανονικές εισερχόμενες κλήσεις PSTN



Η υπηρεσία λειτουργεί μόνο εάν η συνδρομή σας υποστηρίζει την αναγνώριση ταυτότητας καλούντος. Επικοινωνήστε με την εταιρία παροχής υπηρεσιών τηλεφωνίας.

Όταν λαμβάνετε μια κλήση από μια σταθερή τηλεφωνική γραμμή, ο αριθμός τηλεφώνου του καλούντος εμφανίζεται στην οθόνη του ακουστικού. Το τηλέφωνο μπορεί να λάβει κλήσεις σε σύστημα FSK και DTMF. Ενδέχεται να εμφανίζεται και το όνομα του καλούντος, εάν διατίθεται από το δίκτυο. Εάν ο αριθμός είναι καταχωρημένος στο ευρετήριο, εμφανίζεται το όνομα στο ευρετήριο!

Το τηλέφωνο έχει δυνατότητα αποθήκευσης 30 κλήσεων σε μια Λίστα κλήσεων (εισερχόμενων και αναπάντητων) τις οποίες μπορείτε να προβάλετε αργότερα. Όταν η μνήμη είναι πλήρης, οι νέες κλήσεις αντικαθιστούν αυτόματα τις παλιότερες κλήσεις στη μνήμη.



Οι αναπάντητες κλήσεις υποδηλώνονται με ένα εικονίδιο που αναβοσβήνει στην οθόνη. Το όνομα του ακουστικού αντικαθίσταται από αυτό το εικονίδιο και τον αριθμό των αναπάντητων κλήσεων.

#### Για να εμφανίσετε τις εισερχόμενες κλήσεις



- 1** Πατήστε το κάτω πλήκτρο.  
Στην οθόνη εμφανίζεται η λίστα των εισερχόμενων κλήσεων. Είναι ένας συνδυασμός εισερχόμενων και αναπάντητων κλήσεων.
- 2** Επιλέξτε το όνομα ή τον αριθμό που θέλετε.
- 3** Για να ξεκινήσετε την κλήση, πατήστε το πλήκτρο πραγματοποίησης κλήσης.  
Ή  
Πατήστε “Επιλογή”.





Για να διαγράψετε μια καταχώριση:

- 4** Επιλέξτε “Διαγραφή κλήσης” και επιβεβαιώστε.
- 5** Επιστρέψτε στην κατάσταση αναμονής.



Για να διαγράψετε όλες τις καταχωρίσεις:

- 5** Επιλέξτε “Διαγραφή όλων” και επιβεβαιώστε.
- 6** Επιστρέψτε στην κατάσταση αναμονής.



Για να προσθέσετε τον αριθμό στο ευρετήριο:

- 5** Επιλέξτε “Αποθήκευση αριθμού” και επιβεβαιώστε.
- 6** Χρησιμοποιήστε το πληκτρολόγιο για να πληκτρολογήσετε το όνομα και επιλέξτε “Αποθήκευση”.



- 7** Χρησιμοποιήστε το πληκτρολόγιο για να επεξεργαστείτε τον αριθμό και επιλέξτε “Αποθήκευση”.



- 8** Επιλέξτε την επιθυμητή μελωδία κουδουνίσματος και επιλέξτε “Αποθήκευση”.



- 9** Επιστρέψτε στην κατάσταση αναμονής.

## 6 Διαμόρφωση του ακουστικού

### 6.1 Ήχος και ένταση κουδουνίσματος

#### Ήχος

Μπορείτε να επιλέξετε 18 διαφορετικές μελωδίες κουδουνισμού για εσωτερικές και εξωτερικές κλήσεις.



- 1** Μεταβείτε στο μενού.



- 2** Επιλέξτε “Ακουστικό” και επιβεβαιώστε.



- 3** Επιλέξτε “Ήχος” και επιβεβαιώστε.



- 4** Επιλέξτε “Εξωτερικό” για εξωτερικές κλήσεις ή “Εσωτερικό” για εσωτερικές κλήσεις και επιβεβαιώστε.



- 5** Επιλέξτε τη μελωδία που θέλετε και επιβεβαιώστε.



Κατά τη μετακίνηση γίνεται αναπαραγωγή της μελωδίας.

- 6** Επιστρέψτε στην κατάσταση αναμονής.

#### Ένταση κουδουνιού

Μπορείτε να επιλέξετε 5 διαφορετικά επίπεδα έντασης κουδουνισμού και απενεργοποίηση.



- 1** Μεταβείτε στο μενού.



- 2** Επιλέξτε “Ακουστικό” και επιβεβαιώστε.



- 3** Επιλέξτε “Ένταση κουδουνίσματος” και επιβεβαιώστε.

Εμφανίζεται η τρέχουσα ρύθμιση.



- 4** Πατήστε το επάνω πλήκτρο για να αυξήσετε την ένταση ήχου.



- 5** Πατήστε το κάτω πλήκτρο για να μειώσετε την ένταση ήχου.











- 6** Επιλέξτε “Αποθήκευση” για επιβεβαίωση.











- 7** Επιστρέψτε στην κατάσταση αναμονής.

## 6.2 Όνομα ακουστικού









Μπορείτε να αλλάξετε το όνομα που εμφανίζεται στο ακουστικό στην κατάσταση αναμονής (μέχρι 9 χαρακτήρες).

- |   |   |
|---|---|
|    | <b>1</b> Μεταβείτε στο μενού.                                 |
|   | <b>2</b> Επιλέξτε “Ακουστικό” και επιβεβαιώστε.               |
|   | <b>3</b> Επιλέξτε “Όνομα ακουστικού” και επιβεβαιώστε.        |
|    | <b>4</b> Πληκτρολογήστε το όνομα που θέλετε.                  |
|    | <b>5</b> Πατήστε το πλήκτρο μενού για να διορθώσετε το όνομα. |
|    | <b>6</b> Επιλέξτε “Αποθήκευση” για επιβεβαίωση.               |
|    | <b>7</b> Επιστρέψτε στην κατάσταση αναμονής.                  |

## 6.3 Ήχος πληκτρολογίου









- |   |   |
|---|---|
|    | <b>1</b> Μεταβείτε στο μενού.   |
|   | <b>2</b> Επιλέξτε “Ακουστικό” και επιβεβαιώστε.                       |
|   | <b>3</b> Επιλέξτε “Ήχος πληκτρολογίου” και επιβεβαιώστε.              |
|   | <b>4</b> Επιλέξτε “Ενεργοποίηση” ή “Απενεργοποίηση” και επιβεβαιώστε. |
|    | <b>5</b> Επιστρέψτε στην κατάσταση αναμονής.                          |

## 6.4 Ρύθμιση της αντίθεσης

- |   |  |
|---|--|
|    | <b>1</b> Μεταβείτε στο μενού.                                    |
|   | <b>2</b> Επιλέξτε “Ακουστικό” και επιβεβαιώστε.                  |
|   | <b>3</b> Επιλέξτε “Αντίθεση” και επιβεβαιώστε.                   |
|   | <b>4</b> Επιλέξτε την επιθυμητή αντίθεση (1-8) και επιβεβαιώστε. |
|    | <b>5</b> Επιστρέψτε στην κατάσταση αναμονής.                     |







## 6.5 Αυτόματη απάντηση







Εάν κατά τη λήψη μιας εισερχόμενης κλήσης το ακουστικό είναι τοποθετημένο στη βάση, μπορείτε να απαντήσετε αυτόματα στην κλήση σηκώνοντας το ακουστικό από τη βάση. Μπορείτε να ενεργοποιήσετε και να απενεργοποιήσετε αυτή τη λειτουργία.

- |   |   |
|---|---|
|    | <b>1</b> Μεταβείτε στο μενού.   |
|   | <b>2</b> Επιλέξτε “Ακουστικό” και επιβεβαιώστε.                       |
|   | <b>3</b> Επιλέξτε “Αυτόματη απάντηση” και επιβεβαιώστε.               |
|   | <b>4</b> Επιλέξτε “Ενεργοποίηση” ή “Απενεργοποίηση” και επιβεβαιώστε. |
|    | <b>5</b> Επιστρέψτε στην κατάσταση αναμονής.                          |

## 6.6 Πρόθεμα κωδικού

Μπορείτε να χρησιμοποιήσετε το τηλέφωνό σας με ένα πρόθεμα. Όταν καλείτε αριθμούς τηλεφώνου μπορείτε να προσθέτετε αυτόματα το πρόθεμα κωδικού πριν από τον αριθμό.















- |   |   |
|---|---|
|    | <b>1</b> Μεταβείτε στο μενού.                     |
|   | <b>2</b> Επιλέξτε “Ακουστικό” και επιβεβαιώστε.   |
|   | <b>3</b> Επιλέξτε “Πρόθεμα” και επιβεβαιώστε.     |
|   | <b>4</b> Επιλέξτε “Επεξεργασία” και επιβεβαιώστε. |

- |   |   |   |
|---|---|---|
|  |  | <b>5</b> Εισαγάγετε το πρόθεμα κωδικού, π.χ. ‘0’ και επιλέξτε “Αποθήκευση”. |
|   |   | Ή   |
|  |  | <b>4</b> Επιλέξτε “Ενεργοποίηση/Απενεργοποίηση” και επιβεβαιώστε.           |
|  |  | <b>5</b> Επιλέξτε “Ενεργοποίηση” ή “Απενεργοποίηση” και επιβεβαιώστε.       |
|  |   | <b>6</b> Επιστρέψτε στην κατάσταση αναμονής.                                |









## 6.7 Χρήση της λειτουργίας ειδοποίησης

Μπορείτε να ορίσετε διαφορετική ειδοποίηση για κάθε ακουστικό που είναι καταχωρημένο στη βάση. Η ειδοποίηση ηχεί μόνο στο συγκεκριμένο ακουστικό και όχι στη βάση ή στα άλλα ακουστικά.









### Ρυθμίστε την ειδοποίηση

- |   |   |   |
|---|---|---|
|    | <b>1</b> Μεταβείτε στο μενού.   |   |
|    |    | <b>2</b> Επιλέξτε “Ξυπνητήρι” και επιβεβαιώστε.   |
|    |    | <b>3</b> Επιλέξτε “Ρύθμιση ξυπνητηριού” και επιβεβαιώστε.   |
|    |    | <b>4</b> Επιλέξτε “Μία φορά”, “Καθημερινά”, “Δευτ-Παρ” ή “Απενεργοποίηση” και επιβεβαιώστε.<br>Εάν έχετε επιλέξει “Μία φορά”, “Καθημερινά” ή “Δευτ-Παρ”, στην οθόνη εμφανίζεται η ένδειξη:<br>Ώρα (24ωρο):<br>00:00 |
|  |  | <b>5</b> Εισαγάγετε την ώρα ειδοποίησης και επιβεβαιώστε πατώντας “Αποθήκευση”.   |
|  |  | <b>6</b> Επιλέξτε τον επιθυμητό ήχο κουδουνίσματος και επιβεβαιώστε πατώντας “Αποθήκευση”.  |
|  |  | <b>7</b> Για να απενεργοποιήσετε την ειδοποίηση, επιλέξτε “Απενεργοποίηση” και επιβεβαιώστε.  |
|  |   | <b>8</b> Επιστρέψτε στο προηγούμενο μενού.  |

## 6.8 Ρύθμιση ημερομηνίας και ώρας

- |   |   |  |
|---|---|--|
|  | <b>1</b> Μεταβείτε στο μενού.   |  |
|  |  | <b>2</b> Επιλέξτε “Ξυπνητήρι” και επιβεβαιώστε.  |
|  |  | <b>3</b> Επιλέξτε “Ημέρα & Ώρα” και επιβεβαιώστε.  |
|  |  | <b>4</b> Πληκτρολογήστε το έτος, το μήνα, την ημέρα, την ώρα και τα λεπτά και επιλέξτε “Αποθήκευση” για επιβεβαίωση. |
|  |   | <b>5</b> Επιστρέψτε στο προηγούμενο μενού.   |









## 6.9 Ρύθμιση της μορφής ώρας

- |   |   |   |
|---|---|---|
|  | <b>1</b> Μεταβείτε στο μενού.   |   |
|  |  | <b>2</b> Επιλέξτε “Ξυπνητήρι” και επιβεβαιώστε.         |
|  |  | <b>3</b> Επιλέξτε “Εμφάνιση ώρας” και επιβεβαιώστε.     |
|  |  | <b>4</b> Επιλέξτε “12 ωρο” ή “24 ωρο” και επιβεβαιώστε. |
|  |   | <b>5</b> Επιστρέψτε στο προηγούμενο μενού.              |

## 7 Ρυθμίσεις βάσης









### 7.1 Ήχος

Μπορείτε να επιλέξετε 9 διαφορετικές μελωδίες κουδουνισμού.

- |   |   |
|---|---|
|    | <b>1</b> Μεταβείτε στο μενού.   |
|   | <b>2</b> Επιλέξτε “Ρυθμίσεις βάσης” και επιβεβαιώστε.   |
|   | <b>3</b> Επιλέξτε “Ήχος” και επιβεβαιώστε.  |
|   | <b>4</b> Επιλέξτε τη μελωδία που θέλετε και επιβεβαιώστε.<br>Κατά τη μετακίνηση γίνεται αναπαραγωγή ενός δείγματος. |
|    | <b>5</b> Επιστρέψτε στην κατάσταση αναμονής.  |

### 7.2 Ένταση κουδουνιού

Μπορείτε να επιλέξετε 5 διαφορετικά επίπεδα έντασης κουδουνισμού της βάσης.









- |   |  |
|---|--|
|    | <b>1</b> Μεταβείτε στο μενού.  |
|   | <b>2</b> Επιλέξτε “Ρυθμίσεις βάσης” και επιβεβαιώστε.  |
|   | <b>3</b> Επιλέξτε “Ένταση κουδουνίσματος” και επιβεβαιώστε.<br>Εμφανίζεται η τρέχουσα ρύθμιση. |
|    | <b>4</b> Πατήστε το επάνω πλήκτρο για να αυξήσετε την ένταση ήχου.                             |
|   | <b>5</b> Πατήστε το κάτω πλήκτρο για να μειώσετε την ένταση ήχου.                              |
|    | <b>6</b> Επιλέξτε “Αποθήκευση” για επιβεβαίωση.  |
|    | <b>7</b> Επιστρέψτε στην κατάσταση αναμονής.   |

### 7.3 Λειτουργία κλήσης

Υπάρχουν δύο τύποι λειτουργιών κλήσης:





- DTMF/Τονική κλήση (ο πιο κοινός τύπος)
- Παλμική κλήση (για παλαιότερες εγκαταστάσεις)

Για να αλλάξετε τη λειτουργία κλήσης:

- |   |   |
|---|---|
|    | <b>1</b> Μεταβείτε στο μενού.                                     |
|   | <b>2</b> Επιλέξτε “Ρυθμίσεις βάσης” και επιβεβαιώστε.             |
|   | <b>3</b> Επιλέξτε “Σύστημα κλήσης” και επιβεβαιώστε.              |
|   | <b>4</b> Επιλέξτε “Τονικό” ή “Παλμικό” και επιλέξτε “Αποθήκευση”. |
|    | <b>5</b> Επιστρέψτε στην κατάσταση αναμονής.                      |

### 7.4 Επανάκληση (Flash)

Πατήστε το πλήκτρο flash “R” (Πλήκτρο 4 - Εικόνα 2C) για να χρησιμοποιήσετε ορισμένες υπηρεσίες στην εξωτερική σας γραμμή, όπως “Αναμονή κλήσεων” (εάν η τηλεφωνική εταιρεία παρέχει αυτήν την υπηρεσία) ή για να μεταφέρετε κλήσεις εάν χρησιμοποιείτε αυτόματο ιδιωτικό τηλεφωνικό κέντρο (PABX). Το πλήκτρο flash “R” διακόπτει προσωρινά τη γραμμή. Μπορείτε να ρυθμίσετε το χρόνο flash σε 100ms ή 250ms.

- |   |   |
|---|---|
|    | <b>1</b> Μεταβείτε στο μενού.                         |
|   | <b>2</b> Επιλέξτε “Ρυθμίσεις βάσης” και επιβεβαιώστε. |
|   | <b>3</b> Επιλέξτε “Επανάκληση” και επιβεβαιώστε.      |



- 4** Επιλέξτε σύντομο χρόνο flash (100ms) ή μεγάλο χρόνο flash (250ms) και επιλέξτε “Αποθήκευση”.
- 5** Επιστρέψτε στην κατάσταση αναμονής.

## 7.5 Κωδικός συστήματος

Ο κωδικός συστήματος χρησιμοποιείται για την καταχώριση και την κατάργηση ακουστικών και άλλες προαιρετικές ρυθμίσεις. Ο προεπιλεγμένος κωδικός συστήματος είναι 0000.

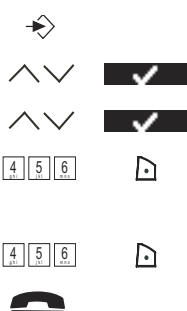

- 1** Μεταβείτε στο μενού.
- 2** Επιλέξτε “Ρυθμίσεις βάσης” και επιβεβαιώστε.
- 3** Επιλέξτε “Κωδικός συστήματος” και επιβεβαιώστε.
- 4** Πληκτρολογήστε τον παλιό κωδικό (0000 από προεπιλογή) και επιλέξτε “Αποθήκευση”.
- 5** Πληκτρολογήστε το νέο κωδικό, επιλέξτε “Αποθήκευση” και επαναλάβετε.
- 6** Επιστρέψτε στην κατάσταση αναμονής.

## 8 Εργαλεία

### 8.1 Συνάντηση

Μπορείτε να ρυθμίσετε 5 συναντήσεις ή υπενθυμίσεις στις οποίες μπορείτε να ορίσετε όνομα και ειδοποίηση για συγκεκριμένη ημερομηνία και ώρα.

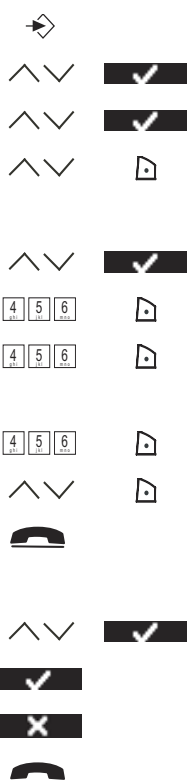

- 1** Μεταβείτε στο μενού.
  - 2** Επιλέξτε “Εργαλεία” και επιβεβαιώστε.
  - 3** Επιλέξτε “Συναντήσεις” και επιβεβαιώστε.
  - 4** Επιλέξτε μία από τις 5 συναντήσεις και πατήστε “Επιλογή”.
- Για να επεξεργαστείτε τη συνάντηση:
- 5** Επιλέξτε “Επεξεργασία” και επιβεβαιώστε.
  - 6** Επεξεργαστείτε το όνομα της συνάντησης και επιλέξτε “Αποθήκευση”.
  - 7** Πληκτρολογήστε την ημερομηνία της συνάντησης και επιλέξτε “Αποθήκευση”.
  - 8** Πληκτρολογήστε την ώρα και επιλέξτε “Αποθήκευση”.
  - 9** Επιλέξτε την επιθυμητή μελωδία ειδοποίησης και επιλέξτε “Αποθήκευση”.
  - 10** Επιστρέψτε στην κατάσταση αναμονής.
- Για να διαγράψετε τη συνάντηση:
- 5** Επιλέξτε “Διαγραφή” και επιβεβαιώστε.
  - 6** Πατήστε το δεξί πλήκτρο μενού για επιβεβαίωση.
  - 7** Πατήστε το αριστερό πλήκτρο μενού για επιστροφή.
  - 8** Επιστρέψτε στην κατάσταση αναμονής.

### 8.2 Χρονόμετρο



- 1** Μεταβείτε στο μενού.
- 2** Επιλέξτε “Εργαλεία” και επιβεβαιώστε.
- 3** Επιλέξτε “Χρονόμετρο” και επιβεβαιώστε.



- 4** Επιλέξτε “Εναρξη” για να ξεκινήσει το χρονόμετρο.
- 5** Επιλέξτε “Διακοπή” για να σταματήσει το χρονόμετρο.  
Επιλέξτε πάλι “Εναρξη” για να ξεκινήσει ξανά.
- Επιλέξτε “Επαναφορά” για να μηδενιστεί ο μετρητής.
- 6** Επιστρέψτε στην κατάσταση αναμονής.

## 9 Πρόσθετα ακουστικά και σταθμοί βάσης

Μπορείτε να δηλώσετε μέχρι 4 ακουστικά σε μια βάση. Κάθε ακουστικό μπορεί να καταχωριστεί σε 4 σταθμούς βάσης και ο χρήστης μπορεί να επιλέξει τη βάση που θέλει να χρησιμοποιήσει.

### 9.1 Προσθήκη νέου ακουστικού



*Απαιτείται μόνο εάν έχετε καταργήσει ένα ακουστικό ή εάν θέλετε να καταχωρίσετε ένα νέο ακουστικό.*

Για να θέσετε τη βάση στη λειτουργία καταχώρισης:



- 1** Κρατήστε πατημένο το πλήκτρο αναζήτησης που βρίσκεται στη βάση.  
Η φωτεινή ένδειξη στη βάση αρχίζει να αναβοσβήνει για 90 δευτερόλεπτα. Όσο αναβοσβήνει η φωτεινή ένδειξη μπορείτε να πραγματοποιήσετε την καταχώριση.

Στο ακουστικό:



- 1** Μεταβείτε στο μενού.
- 2** Επιλέξτε “Ακουστικό” και επιβεβαιώστε.
- 3** Επιλέξτε “Καταχώριση” και επιβεβαιώστε.
- 4** Επιλέξτε “Καταχώριση” και επιβεβαιώστε.
- 5** Επιλέξτε τον αριθμό της βάσης που θέλετε να αντιστοιχίσετε στο ακουστικό (1-4) και επιβεβαιώστε.
- 6** Πληκτρολογήστε τον κωδικό συστήματος (0000 από προεπιλογή) και επιβεβαιώστε.
- 7** Επιστρέψτε στην κατάσταση αναμονής.

### 9.2 Κατάργηση ακουστικού



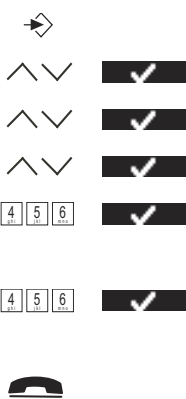





Η διαδικασία αυτή πρέπει να εκτελεστεί σε διαφορετικό ακουστικό από αυτό που θέλετε να αφαιρέσετε.



- 1** Μεταβείτε στο μενού.
- 2** Επιλέξτε “Ακουστικό” και επιβεβαιώστε.
- 3** Επιλέξτε “Καταχώριση” και επιβεβαιώστε.
- 4** Επιλέξτε “Αποσύνδεση” και επιβεβαιώστε.
- 5** Πληκτρολογήστε τον κωδικό συστήματος (0000 από προεπιλογή) και επιβεβαιώστε.
- 6** Πληκτρολογήστε τον αριθμό του ακουστικού που θέλετε να καταργήσετε και επιβεβαιώστε.
- 7** Επιστρέψτε στην κατάσταση αναμονής.

### 9.3 Επιλογή βάσης

Μπορείτε να χρησιμοποιείτε το ακουστικό σε διάφορες βάσεις. Μπορείτε επίσης να το ρυθμίσετε να επιλέγει αυτόματα τη βάση με το ισχυρότερο σήμα. Πρέπει πρώτα να καταχωρίσετε το ακουστικό σε κάθε βάση ξεχωριστά.



- |   |   |
|---|---|
|    | <b>1</b> Μεταβείτε στο μενού.   |
|   | <b>2</b> Επιλέξτε “Ακουστικό” και επιβεβαιώστε.   |
|   | <b>3</b> Επιλέξτε “Επιλογή βάσης” και επιβεβαιώστε.   |
|   | <b>4</b> Επιλέξτε “Χειροκίνητη” ή “Αυτόματη” και επιβεβαιώστε.<br>Εάν έχετε επιλέξει “Χειροκίνητη”: |
|   | <b>5</b> Επιλέξτε τη βάση που θέλετε να αντιστοιχίσετε στο ακουστικό και επιβεβαιώστε.              |



*Εάν έχετε ενεργοποιήσει την αυτόματη επιλογή βάσης και το ακουστικό βρίσκεται εκτός εμβέλειας στην τρέχουσα βάση, το ακουστικό θα αναζητήσει τη βάση με το ισχυρότερο σήμα μόνο στην κατάσταση αναμονής (όχι κατά τη διάρκεια επικοινωνίας).*



### 9.4 Χρήση της λειτουργίας ενδοεπικοινωνίας

#### Κλήση εσωτερικού ακουστικού

- |   |  |
|---|--|
| INT   | <b>1</b> Πατήστε το αριστερό πλήκτρο INT.  |
|  | Στην οθόνη εμφανίζεται το μήνυμα “Ακουστικό _”.  |
|  | <b>2</b> Πληκτρολογήστε τον εσωτερικό αριθμό του ακουστικού που θέλετε να καλέσετε.                                  |
|   | <b>3</b> Πατήστε το πλήκτρο τερματισμού κλήσης για να κλείσετε το τηλέφωνο ή τοποθετήστε ξανά το ακουστικό στη βάση. |

#### Μεταφορά εξωτερικής κλήσης σε άλλο ακουστικό

Κατά τη διάρκεια μιας εξωτερικής κλήσης:

- |   |  |
|---|--|
| INT   | <b>1</b> Πατήστε το αριστερό πλήκτρο INT.  |
|  | Στην οθόνη εμφανίζεται το μήνυμα “Ακουστικό _”.  |
|  | <b>2</b> Πληκτρολογήστε τον εσωτερικό αριθμό του ακουστικού που θέλετε να καλέσετε. Ο εξωτερικός συνομιλητής τίθεται σε αναμονή.   |
|   | <b>3</b> Όταν απαντήσει ο εσωτερικός συνομιλητής, πατήστε το πλήκτρο τερματισμού κλήσης για να μεταφέρετε την κλήση.   |
| Η   |  |
| INT   | <b>3</b> Εάν δεν απαντήσει ο εσωτερικός συνομιλητής, πατήστε το αριστερό πλήκτρο INT για να ανακτήσετε τον εξωτερικό συνομιλητή ή για να μεταβείτε από τον έναν στον άλλο. |
|  | <b>4</b> Πατήστε το πλήκτρο τερματισμού κλήσης για να κλείσετε το τηλέφωνο ή τοποθετήστε ξανά το ακουστικό στη βάση.   |

#### Κλήση συνδιάσκεψης

Μπορείτε να συνομιλείτε με 2 ακουστικά και μια εξωτερική γραμμή ταυτόχρονα.

Κατά τη διάρκεια μιας εξωτερικής κλήσης:

- |     |   |
|-----|---|
| INT | <b>1</b> Πατήστε το αριστερό πλήκτρο INT.       |
|     | Στην οθόνη εμφανίζεται το μήνυμα “Ακουστικό _”. |

4 5 6



INT



**2** Πληκτρολογήστε τον εσωτερικό αριθμό του ακουστικού που θέλετε να καλέσετε.

Ο εξωτερικός συνομιλητής τίθεται σε αναμονή.

**3** Όταν απαντήσει ο εσωτερικός συνομιλητής, επιλέξτε “Συνδ.”.

Ή

**3** Εάν δεν απαντήσει ο εσωτερικός συνομιλητής, πατήστε το αριστερό πλήκτρο INT για να ανακτήσετε τον εξωτερικό συνομιλητή.

**4** Πατήστε το πλήκτρο τερματισμού κλήσης για να κλείσετε το τηλέφωνο ή τοποθετήστε ξανά το ακουστικό στη βάση.

### Λήψη εξωτερικής κλήσης κατά τη διάρκεια εσωτερικής επικοινωνίας

Μπορείτε να λαμβάνετε εξωτερικές κλήσεις κατά τη διάρκεια ενδοεπικοινωνίας με άλλο ακουστικό. Για να λάβετε μια εισερχόμενη κλήση:



**1** Πατήστε το πλήκτρο τερματισμού κλήσης. Η εσωτερική επικοινωνία διακόπτεται.

**2** Πατήστε το πλήκτρο πραγματοποίησης κλήσης. Ξεκινάει η επικοινωνία με τον εξωτερικό καλούντα.

## 10 Επίλυση προβλημάτων

Σύμπτωμα	Πιθανή αιτία	Λύση
Καμία ένδειξη	Αφόρτιστες μπαταρίες	Ελέγξτε τη θέση των μπαταριών
		Επαναφορτίστε τις μπαταρίες
	Το ακουστικό έχει τεθεί εκτός λειτουργίας	Ενεργοποιήστε το ακουστικό
Κανένας τόνος	Το καλώδιο του τηλεφώνου δεν έχει συνδεθεί σωστά	Ελέγξτε τη σύνδεση του καλωδίου του τηλεφώνου
	Η γραμμή είναι κατειλημμένη από άλλο ακουστικό	Περιμένετε μέχρι να κλείσει το άλλο ακουστικό
Το εικονίδιο Ψ αναβοσβήνει	Το ακουστικό είναι εκτός εμβέλειας	Φέρτε το ακουστικό πιο κοντά στη βάση
	Δεν υπάρχει παροχή ισχύος στη βάση	Ελέγξτε τη σύνδεση του κεντρικού δικτύου με τη βάση
	Το ακουστικό δεν είναι δηλωμένο στη βάση	Δηλώστε το ακουστικό στη βάση
Η βάση ή το ακουστικό δεν χτυπά	Η ένταση κουδουνίσματος είναι απενεργοποιημένη ή χαμηλή	Ρυθμίστε την ένταση του κουδουνίσματος
Δεν είναι δυνατή η εκτροπή κλήσης στο PABX	Ο χρόνος flash είναι πολύ σύντομος ή πολύ μεγάλος	Αλλάξτε το χρόνο flash
Το τηλέφωνο δεν αποκρίνεται στο πάτημα των πλήκτρων	Σφάλμα χειρισμού	Αφαιρέστε τις μπαταρίες και ξαναβάλτε τις στη θέση τους



## 11 Τεχνικά δεδομένα Τεχνικά χαρακτηριστικά

Πρότυπο	<b>DECT (Digital Enhanced Cordless Telecommunications)</b> <b>GAP (Generic Access Profile)</b>
Εύρος συχνότητας	1880 MHz έως 1900 MHz
Αριθμός καναλιών	120 αμφίδρομα κανάλια
Διαμόρφωση	GFSK
Κωδικοποίηση ομιλίας	32 kbit/s
Ισχύς εκπομπής	10 mW ( μέση ισχύς ανά κανάλι)
Εμβέλεια	300 μ. σε ανοιχτό χώρο /έως 50 μ. σε κλειστό χώρο
Αριθμός ακουστικών	Μέχρι 4
Παροχή ισχύος στη βάση	230V / 50 Hz / 6V DC 300mA
Μπαταρίες ακουστικού:	2 επαναφορτιζόμενες μπαταρίες AAA, NiMh 1,2V, 700mA
Αυτονομία ακουστικού	110 ώρες σε λειτουργία αναμονής
Χρόνος ομιλίας ακουστικού	11 ώρες
Κανονικές συνθήκες χρήσης	+5 °C έως +45 °C
Σύστημα κλήσης	Παλμικό / Τονικό
Χρόνος flash	100 ή 250 ms

## 12 Εγγύηση

### 12.1 Περίοδος εγγύησης

Οι μονάδες Torcom έχουν εγγύηση 24 μηνών. Η εγγύηση ξεκινάει από την ημερομηνία αγοράς της νέας μονάδας. Η εγγύηση των μπαταριών περιορίζεται στους 6 μήνες από την ημερομηνία αγοράς. Η εγγύηση δεν καλύπτει αναλώσιμα ή ελαττώματα με αμελητέα επίδραση στη λειτουργία ή την αξία του εξοπλισμού. Η εγγύηση αποδεικνύεται με προσκόμιση της αυθεντικής απόδειξης αγοράς, στην οποία αναγράφονται η ημερομηνία αγοράς και το μοντέλο της συσκευής.

### 12.2 Χρήση της εγγύησης

Οι ελαττωματικές μονάδες πρέπει να επιστρέφονται σε κέντρο τεχνικής υποστήριξης Torcom και να συνοδεύονται από έγκυρη απόδειξη αγοράς. Εάν η μονάδα παρουσιάσει κάποιο ελάττωμα κατά τη διάρκεια ισχύος της εγγύησης, η Torcom ή εξουσιοδοτημένο κέντρο τεχνικής υποστήριξης αναλαμβάνουν δωρεάν την επισκευή οποιωνδήποτε ελαττωμάτων τα οποία οφείλονται σε ελαττωματικό υλικό ή κατασκευαστικό σφάλμα. Εναπόκειται στη διακριτική ευχέρεια της Torcom να εκπληρώσει τις υποχρεώσεις της που απορρέουν από την εγγύηση, προβαίνοντας είτε σε επισκευή είτε σε αλλαγή των ελαττωματικών μονάδων ή μερών των ελαττωματικών μονάδων. Σε περίπτωση αντικατάστασης, ενδέχεται να μην διατίθεται το χρώμα και το μοντέλο της αρχικής μονάδας που αγοράσατε. Ως ημερομηνία έναρξης της περιόδου ισχύος της εγγύησης ορίζεται η ημερομηνία αγοράς. Σε περίπτωση αλλαγής ή επισκευής της μονάδας από την Torcom ή από εξουσιοδοτημένο κέντρο τεχνικής υποστήριξης, η περίοδος ισχύος της εγγύησης δεν παρατείνεται.

### 12.3 Εξαιρέσεις

Η εγγύηση δεν καλύπτει βλάβες ή ελαττώματα τα οποία οφείλονται σε εσφαλμένη χρήση ή λειτουργία που προκύπτει από τη χρήση μη γνήσιων εξαρτημάτων ή παρελκομένων τα οποία δεν συνιστώνται από την Torcom. Τα ασύρματα τηλέφωνα Torcom είναι σχεδιασμένα για λειτουργία αποκλειστικά και μόνο με επαναφορτιζόμενες μπαταρίες. Η εγγύηση δεν καλύπτει τυχόν βλάβη η οποία οφείλεται στη χρήση μη επαναφορτιζόμενων μπαταριών. Η εγγύηση δεν καλύπτει τυχόν βλάβη η οποία οφείλεται σε εξωτερικούς

παράγοντες, όπως αστραπή, νερό και φωτιά, ούτε βλάβη που προκύπτει κατά τη μεταφορά της μονάδας. Δεν μπορεί να εγερθεί αξίωση εγγύησης εάν ο σειριακός αριθμός των μονάδων μεταβληθεί, αφαιρεθεί ή καταστεί δυσανάγνωστος. Οποιοσδήποτε αξιώσεις εγγύησης θεωρούνται μη έγκυρες σε περίπτωση που η μονάδα έχει επισκευαστεί, αλλοιωθεί ή τροποποιηθεί από τον αγοραστή ή από μη επίσημα εξουσιοδοτημένο κέντρο τεχνικής υποστήριξης Torcom.

### 13 Απόρριψη της συσκευής (περιβάλλον)



Όταν ολοκληρωθεί ο κύκλος ζωής του προϊόντος, μην το πετάξετε στα οικιακά απορρίμματα, αλλά φέρτε το σε ένα σημείο συλλογής για την ανακύκλωση ηλεκτρικών και ηλεκτρονικών προϊόντων. Αυτό υποδεικνύεται από το σύμβολο πάνω στο προϊόν, στον οδηγό χρήστη και/ή στο κουτί.

Ορισμένα από τα υλικά του προϊόντος μπορούν να ξαναχρησιμοποιηθούν εάν τα φέρετε σε κάποιο σημείο συλλογής προϊόντων προς ανακύκλωση. Με την επαναχρησιμοποίηση ορισμένων μερών ή πρώτων υλών από χρησιμοποιημένα προϊόντα συμβάλλετε σημαντικά στην προστασία του περιβάλλοντος. Επικοινωνήστε με τις τοπικές αρχές για πληροφορίες σχετικά με τα σημεία περισυλλογής στην περιοχή σας.

### 14 Καθαρισμός

Καθαρίζετε το τηλέφωνο με ελαφρώς νοτισμένο ή αντιστατικό ύφασμα. Ποτέ μην χρησιμοποιείτε καθαριστικά, λειαντικά μέσα ή διαλύτες.

### 15 Λειτουργία ECO (χαμηλής ακτινοβολίας)

- Αυτό το ασύρματο τηλέφωνο (συμβατό με το πρότυπο DECT) διευκολύνει τη λειτουργία χαμηλής ακτινοβολίας.
- Η ένταση της ακτινοβολίας του ραδιοσήματος μεταξύ του σταθμού βάσης και του ακουστικού μειώνεται στο ελάχιστο όταν το ακουστικό βρίσκεται στο σταθμό βάσης.
- Η ισχύς ακτινοβολίας του ραδιοσήματος αυξάνεται σε κανονικά επίπεδα μόνο όταν το ακουστικό αφαιρείται από το σταθμό βάσης ή κατά τη λήψη κλήσης.
- Αυτό δεν σημαίνει ότι τα κανονικά επίπεδα ακτινοβολίας που εκπέμπονται από συσκευές DECT είναι επιζήμια για την υγεία σας.
- Η λειτουργία χαμηλής ακτινοβολίας αποτρέπει τον περιττό φόρτο ακτινοβολίας DECT, όταν δεν απαιτείται επικοινωνία μεταξύ του σταθμού βάσης και του ακουστικού.
- Για τεχνικούς λόγους, δεν είναι δυνατή η λειτουργία πρόσθετων ακουστικών σε λειτουργία χαμηλής ακτινοβολίας (ένα πρόσθετο ακουστικό, το οποίο δεν βρίσκεται σε πολύ κοντινή απόσταση από το σταθμό βάσης, θα αναζητάει πάντα το σταθμό βάσης λόγω του αδύναμου ραδιοσήματος).
- Η λειτουργία χαμηλής ακτινοβολίας είναι ενεργοποιημένη στις προεπιλεγμένες εργοστασιακές ρυθμίσεις.
- Η λειτουργία χαμηλής ακτινοβολίας απενεργοποιείται αυτόματα σε περίπτωση που καταχωρήσετε πρόσθετο ακουστικό.
- Η λειτουργία χαμηλής ακτινοβολίας ενεργοποιείται αυτόματα ξανά όταν αναιρέσετε την καταχώρηση όλων των πρόσθετων ακουστικών (μόνο ένα ακουστικό μπορεί να είναι καταχωρημένο στο σταθμό βάσης).
- Η διαδικασία καταχώρησης και αναίρεσης καταχώρησης ακουστικών περιγράφεται στο Εγχειρίδιο χρήσης .



# **TOPCOM<sup>®</sup>**

## **BUTLER 5710**

**visit our website  
[www.topcom.net](http://www.topcom.net)**

MD3600080

## Free Manuals Download Website

<http://myh66.com>

<http://usermanuals.us>

<http://www.somanuals.com>

<http://www.4manuals.cc>

<http://www.manual-lib.com>

<http://www.404manual.com>

<http://www.luxmanual.com>

<http://aubethermostatmanual.com>

Golf course search by state

<http://golfingnear.com>

Email search by domain

<http://emailbydomain.com>

Auto manuals search

<http://auto.somanuals.com>

TV manuals search

<http://tv.somanuals.com>