

TOPFIELD



## The User's Manual

FREE TO AIR  
Digital Satellite Receiver

TF3100FEi





TF3100FEP pro

**- Embedded Positioner**

Please read this User's Manual carefully.  
The menu structure and specification can be changed without notice.

# TABLE OF CONTENTS

- INTRODUCTION ..... 4
- CONTENTS ..... 5
- FEATURES ..... 5
- FRONT/ REAR PANELS ..... 6
  - 1) FRONT PANEL ..... 6
  - 2) REAR PANEL ..... 6
- REMOTE CONTROL UNIT (RCU) ..... 8
- GETTING STARTED ..... 14
- FUNCTION GUIDE ..... 15
- MENU OPERATIONS ..... 17
  - 1) SYSTEM SETTING ..... 18
  - 2) ORGANIZING CHANNEL ..... 28
  - 3) ORGANIZING FAVORITES ..... 30
  - 4) INSTALLATION ..... 31
  - \* POSITIONER SETTING GUIDE(Positioner model only) ..... 38
  - 5) INFORMATION ..... 50
  - 6) GAME ..... 52
- TROUBLE SHOOTING(Q & A) ..... 54
- SPECIFICATIONS ..... 55

	<b>CAUTION</b>	
	<b>RISK ELECTRIC SHOCK</b> Do NOT OPEN	
	This symbol indicates "dangerous voltage" inside the product that presents a risk of electric shock or personal injury.	
	This symbol indicates important instructions accompanying the product.	
<b>CAUTION: TO REDUCE THE RISK OF FIRE OR ELECTRIC SHOCK, DO NOT EXPOSE THIS APPLIANCE TO RAIN OR MOISTURE</b>		
<b>Warning!</b>		
Please do not insert metal or alien substance into the slots for the Modules and Cards. In doing so can cause damage to the STB and reduce its life span.		

---

## WARNING Warning WARNING Warning WARNING

---

**Please read the following recommended safety precautions carefully for your safety.**

**MAINS SUPPLY :** 90-250V AC 50/60 Hz.

**OVERLOADING :** Do not overload wall outlets, extension cords or adapters as these can result in fire or electrical shock.

**LIQUIDS :** Keep liquids away from the STB.  
The apparatus shall not be exposed to dripping or splashing and that no objects filled with liquids, such as vases, shall be placed on the apparatus.

**SMALL OBJECTS :** Coins or other small objects must be kept away from the IRD as they can fall through the ventilation slots of the IRD and cause serious damage.

**CLEANING :** Disconnect the IRD from the wall socket before cleaning it. Use a dry cloth lightly dampened (no solvents) to clean the exterior of the IRD.

**VENTILATION :** Do not block the decoder's ventilation slots. Ensure that a free airflow is maintained around the IRD. NEVER stand the IRD on soft furnishings or carpets. Do not use or store the IRD where it is exposed to direct sunlight or near a heater. NEVER stack other electronic equipment on top of the IRD.

**ATTACHMENTS :** Do not use any attachments that are not recommended as these may cause hazards or damage the equipment .

**CONNECTION TO THE SATELLITE DISH LNB :**  
Disconnect the IRD from the mains before connecting or disconnecting the cable from the satellite dish.  
**FAILURE TO DO SO CAN DAMAGE THE LNB,**

**SERVICING :** Do not attempt to service this product yourself. Refer all servicing to qualified service agents.

**LIGHTNING :** It is recommended that the IRD should remain connected at all times to the mains supply and satellite dish (except when working on the LNB). However, the manufacturer's instructions for safeguarding other equipment connected to the IRD, i. e, TV set, must be followed during lightning storms. LNB and the modem telephone line are essential.

**EARTHING :** The LNB cable **must be earthed** to the system earth for the satellite dish.

**LOCATION :** Locate the IRD indoor place properly to prevent lightning, raining and direct sunlight.

---

## INTRODUCTION

---

Thank you for purchasing the Digital Satellite Receiver (STB).

This Digital Satellite Receiver is fully compliant with the international DVB standard and thus transmits digital images, sounds, information guides and teletext directly to your TV through the satellite. Now you can comfortably see and receive digitally transmitted music, news, movie and sports satellite broadcasts in your office or at your home.

In the Channel Search section, both the automatic channel search method and the manual Search mode are provided. Also it supports DiSEqC 1.2, enabling you to move your antenna in order to focus your preferred satellite. You can save up to 3500 TV and 1500 Radio channels and work around with the Favorite, Lock, Delete, Move and Sort functions. The Menu is very modern and supports different languages. All functions can be carried out using the remote control and some of the functions can also be carried out using the front panel.

The STB is easy to use and adaptable for future advances. Please be aware that new software may change the functions of the STB. If you have any difficulties concerning the operation of your STB, please refer to the relevant section of this manual, including the 'Troubleshooting'. This Manual will provide you with useful information on using the STB.

---

## CONTENTS

---

Please ensure that the following items are included with the STB.

- 1) Remote control unit
- 2) Batteries (size AAA)
- 3) User's Guide (this document)

---

## FEATURES

---

Fully Compliant to DVB

Antenna/LNB control

- 22KHz mode On/Off
- 0/12V mode selection
- Automatic FEC Detection
- DiSEqC 1.0 & 1.2 compatible
- Built-In Positioner (High Power Azimuth Control-36DC,5A) ....**(Positioner model only)**

Satellite/Channel support

- 3500 TV channels, 1500 Radio channels storable

Video/Audio

- Automatic and Manual PAL/NTSC selection
- Multi-lingual Audio support
- Automatic channel search

OSD (On Screen Display) support

- 256 color support.
- Multi-lingual menu text support.
- GMT and Time Offset support
- 10 favorite channel groups support
- Page Up/Page Down available on your channel list
- PIG ( Picture In Graphic ) support

Teletext

- Software emulation mode with always VBI insertion mode on.

Games are embedded.

## FRONT / REAR PANELS

### 1) Front Panel

#### - STANDBY

- The power button of STB (ON / Stand by)

#### - LED

- REMOTE
- STANDBY

#### - CHANNEL

- The channel buttons are to change channels.

### 2) Rear Panel



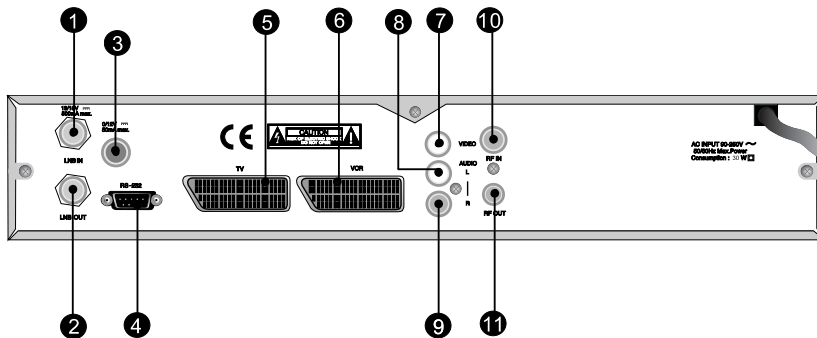

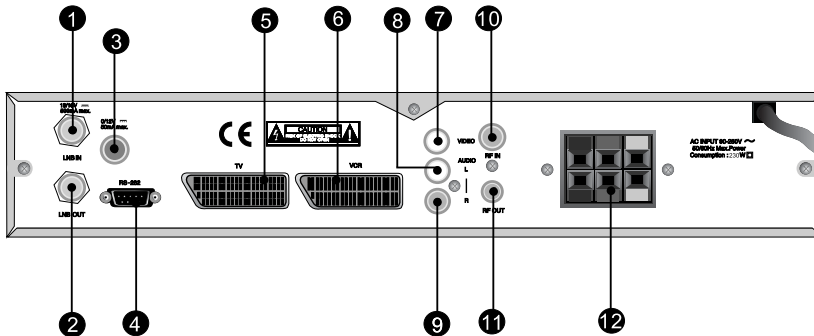





(Non-Positioner model)



**(Embedded Positioner model)**

- |  |   |
|--|---|
| <p><b>1</b> LNB IN</p> <ul style="list-style-type: none"> <li>• Connects the satellite antenna cable.</li> </ul>   | <p><b>7</b> VIDEO OUTPUT</p> <ul style="list-style-type: none"> <li>• Video output (YELLOW).</li> </ul>       |
| <p><b>2</b> LNB OUT</p> <ul style="list-style-type: none"> <li>• Use it to connect to another STB.</li> </ul>      | <p><b>8</b> AUDIO-LEFT INPUT</p> <ul style="list-style-type: none"> <li>• Audio input (WHITE).</li> </ul>     |
| <p><b>3</b> 0/12V OUTPUT</p> <ul style="list-style-type: none"> <li>• Chooses the LNB on the antenna.</li> </ul>   | <p><b>9</b> AUDIO-RIGHT INPUT</p> <ul style="list-style-type: none"> <li>• Audio input (RED).</li> </ul>      |
| <p><b>4</b> RS232</p> <ul style="list-style-type: none"> <li>• Upgrades the STB Program &amp; software.</li> </ul> | <p><b>10</b> RF IN</p> <ul style="list-style-type: none"> <li>• Connects the TV antenna.</li> </ul>           |
| <p><b>5</b> TV SCART</p> <ul style="list-style-type: none"> <li>• Connects the TV SCART.</li> </ul>                | <p><b>11</b> RF OUT</p> <ul style="list-style-type: none"> <li>• Connects the TV.</li> </ul>                  |
| <p><b>6</b> VCR SCART</p> <ul style="list-style-type: none"> <li>• Connects the VCR SCART.</li> </ul>              | <p><b>12</b> DISH CONTROL</p> <ul style="list-style-type: none"> <li>• Connects the actuated dish.</li> </ul> |





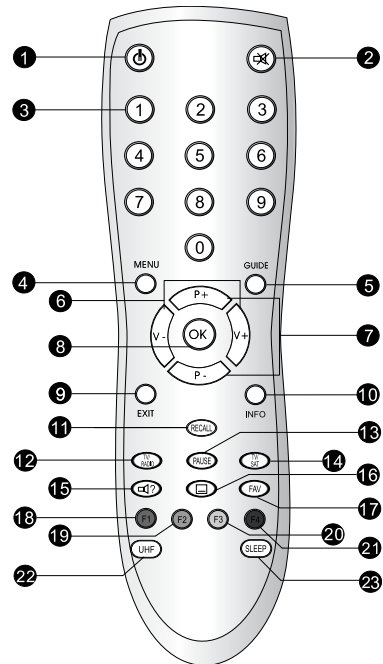





## REMOTE CONTROL UNIT (RCU)

- ❶ POWER Button (  )
  - Switches the STB between Operation and Standby mode.
- ❷ MUTE Button (  )
  - Enables/ Disables the Audio.
- ❸ Numeric Keys (  ~  )
  - Selects the TV or Radio service channels and individual menu options.
- ❹ MENU Button (MENU)
  - Displays the Menu on screen or returns to previous menu from submenu.
- ❺ GUIDE Button (GUIDE)
  - Displays the EPG (Electronic Program Guide) on screen only when available.
- ❻ V+/V- Buttons (  ,  )
  - Adjusts the volume (Increase/Decrease).
- ❼ P+/P- Buttons (  ,  )
  - Tunes to the next or previous service.  
Services up or down through the available services.
- ❽ OK Button (  )
  - Displays Channel List on screen. Selects the item in the menu mode.
- ❾ EXIT Button (EXIT)
  - Returns to the previous menu and the screen.
- ❿ INFO Button (INFO)
  - Displays the program information box on the screen and removes it.
- ⓫ RECALL Button (  )
  - Selects the previously viewed channel.







## REMOTE CONTROL UNIT (RCU)

- 12 TV/Radio Button (  )
  - Selects the TV/Radio mode.
  
- 13 PAUSE Button (  )
  - Stills the playing picture.
  
- 14 TV/SAT Button (  )
  - Changes the terrestrial TV and Satellite mode.
  
- 15 SOUND Button (  )
  - Selects LEFT/RIGHT/MONO/STEREO sound function.
  
- 16 SUBTITLE and TELETEXT Button (  )
  - Selects the subtitle language list for the current service.
  - Enables the teletext with software emulation.
  
- 17 FAV Button (  )
  - Displays the favorite channel list.
  
- 18  Button (Red)
  - Selects function. (F1)
  
- 19  Button (Green)
  - Selects function. (F2)
  
- 20  Button (Yellow)
  - Selects function. (F3)
  
- 21  Button (Blue)
  - Selects function. (F4)

---

## REMOTE CONTROL UNIT (RCU)

---

- ⑫ UHF Button (  )
  - Displays and alters the UHF setting in menu.
  
- ⑬ SLEEP Button (  )
  - Displays sleep time. When sleep time, the power automatically turns to the OFF mode and the STB to the STANDBY mode.

## INSTALLATION (Connection)

- First, connect both the satellite antenna and the TV line to the STB and switch the power on.
- In this manual there are some of the most common ways to connect the equipment: TV, VCR and STB.
- There are several ways of connecting the STB to the existing Audio/TV system. We recommend using one of the following setups.
- If you have problems with your connections and need help, contact your dealer or Service Provider.

### 1) Connection to TV, VCR and Hi-Fi

#### 1-1) Connection to the TV with the SCART Cable.

Connect one end of the SCART cable to the TV SCART socket on the STB and the other end to a SCART socket on the TV.

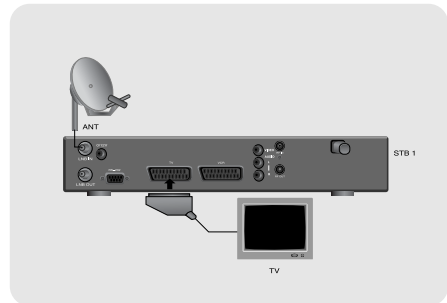

#### 1-2) Connection to the VCR with the SCART Cable.

Connect one end of the SCART cable to the VCR SCART socket on the STB and the other end to a SCART socket on the VCR.

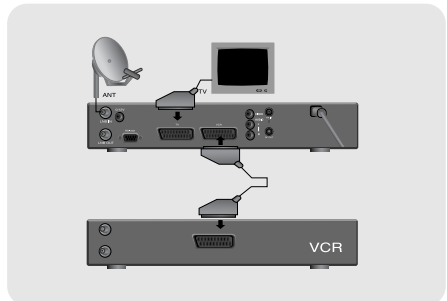

## INSTALLATION (Connection)

### 1-3) Connection to the TV with the CINCH Cable.

Connect one end (3 connectors) of the CINCH cable to the AUDIO-RIGHT (red), AUDIO-LEFT (white) and the VIDEO OUTPUT (yellow) socket on the STB.

Connect the other end (3 connectors) to the AUDIO-RIGHT input (red), AUDIO-LEFT input (white) and the VIDEO input (yellow) socket on the TV or Hi-Fi.

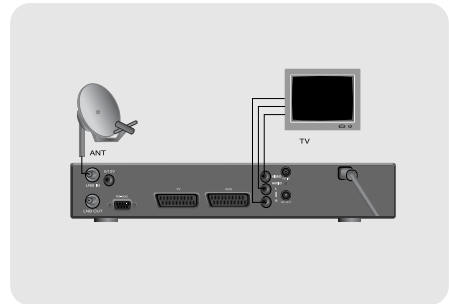

### 1-4) Connection to the TV using the RF cable.

Connect a terrestrial antenna to RF IN socket on the STB.

Connect one end of the RF cable to the RF OUT socket on the STB.

Connect the other end to the ANT IN socket on the TV.

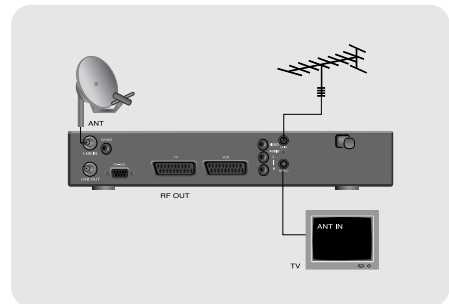

### 2) Connection to the other Satellite Receiver.

Connect the satellite cable to the LNB IN socket on the STB. With a connector, connect the LNB OUT socket on the STB and the ANT IN socket of the other STB.

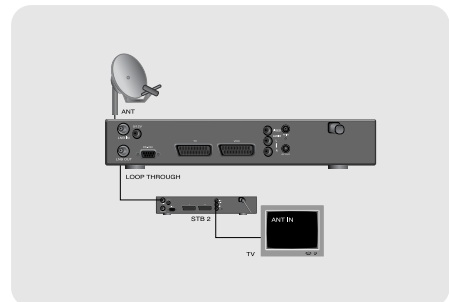

**3. Connection to the dish. (Positioner model only)**

**3-1) Connection to an actuated dish**

Connect the LNB IN socket of the STB to the LNB.

Connect motor wires to M1 and M2.

Switch these connections if the motor moves to the wrong direction.

Connect sensor wires to PULSE and GND connector.

Connect a mechanical polarotor to +5V, GND and SKEW connectors.

Improper connection cause malfunction or may break down your STB and Motor

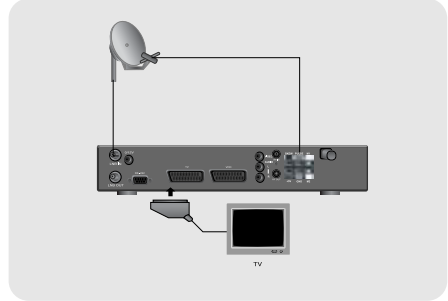

**3-2) Connection to an actuated dish with C/Ku switch .**

Connect the cables from C and ku-band LNB to 12 Volt C/Ku switch.

Connect the coaxial cable from the 0/12 Volt switch to LNB IN connector.

Connect the power cable which comes from the 0/12 Volt switch to the 0/12V connector.

Connect motor wires to M1 and M2.



Switch these connections if the motor moves to the wrong direction.

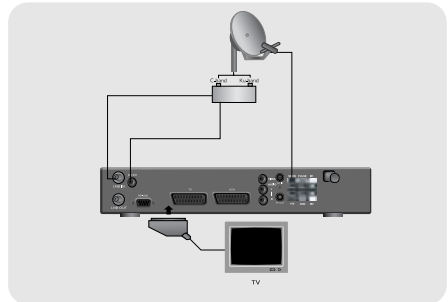

Connect sensor wires to PULSE and GND connectors.

Connect a mechanical polarotor to +5V, GND and SKEW connectors.







## GETTING STARTED

Press the Power  button to operate the STB from the STANDBY mode. Now, the Info box will appear for a given time and disappear. Pressing the  button, the Info box will remain on the screen. The display time of the Info box is adjustable under the Installation Menu of the Main Menu.

If the current broadcast has EPG (Electronic Program Guide) with it, press the  button to see not only the current channel's but also other channel's EPG without any time constraints. Also, press the  button to reserve and save the current service and to watch the broadcast automatically when it starts.

**IMPORTANT: Before taking charge of your new STB, some important technical settings are essential.**

- Adjust your antenna through Dish Setting menu in installation menu.
- First, press the  button on the RCU to make the Main Menu appear.
- Go to the LNB Setting menu under the Channel Search item of the Installation menu and press  button.
- The Default PIN CODE is 0000.
- Choose the right parameters for Satellite Name, LNB Frequency, 22KHz, 12 V, DiSEqC 1.0, and Motorized System according to your LNB and satellite settings. If the right Satellite Name and LNB Frequency were not found in the list, call the dealer for satellite information.
- Then, press the  button and go back to the Channel Search menu.
- Set the Search Mode to the Auto mode. (A Manual or Advanced Search can always be performed later on)
- Select the Start Search... item and press  button.
- The search procedure will take a while. Press the  button when the searching process is over (100%) to confirm and save the new channel list.
- For further information, please refer to the LNB Setting item of the MENU OPERATIONS on this manual.

# Function Guide

## Information Box

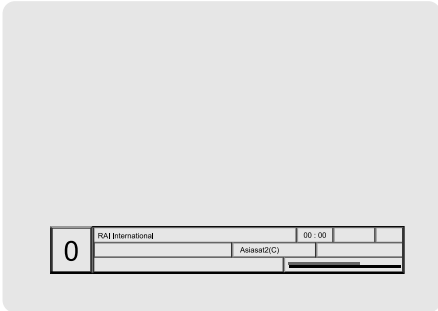

Press INFO key on the RCU to see the program information. The Information box displays as follows:



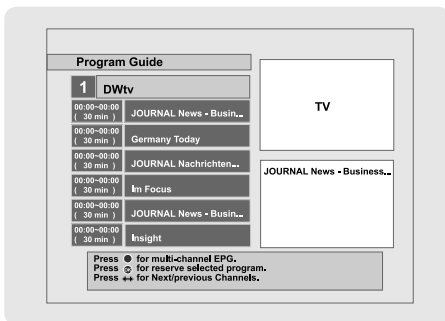

- Channel Number
- Channel Name
- Detailed Program Information
- Signal Level & Quality
- Satellite Information
- Information of subtitle and / or teletext

## EPG (Electronic Program Guide)



To use currently showing TV, and Radio services as well as to use next program schedules, press **[GUIDE]** button on the remote control unit.

If EPG is available on programs, you will see the detailed description of the programs, start/end time and programs schedules etc.

,  and ,  buttons will be used to move program and to see next program

schedules. The **[OK]** button makes the reservation for the next program.

**[INFO]** button shows extended information of the current program.

**[TV/RADIO]** button will change the contents of EPG between TV and Radio services.

# Function Guide

## Subtitle

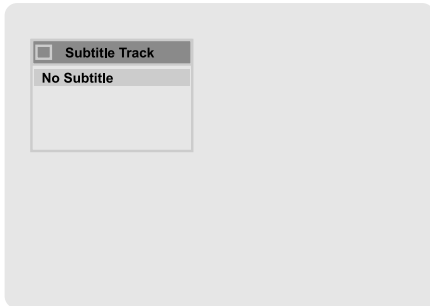

You can choose a language of subtitle using  button on the RCU.

If a broadcaster provides subtitles, you can see  symbol in the Information Box.

## Teletext

If a broadcaster supports teletext, you can see  symbol in the Information Box.

There are VBI insertion mode and software emulation mode in teletext.

In the VBI insertion mode, which is always on, you can watch the teletext with your TV using the RCU of your TV. To watch teletext with VBI insertion, your TV must support teletext.

In the software emulation mode, you can watch the teletext even though your TV does not support teletext. You can watch the teletext using the RCU of STB.

Press  button twice to watch the teletext with software emulation mode.

Press  button or **EXIT** button to escape from teletext.

## Soundtrack

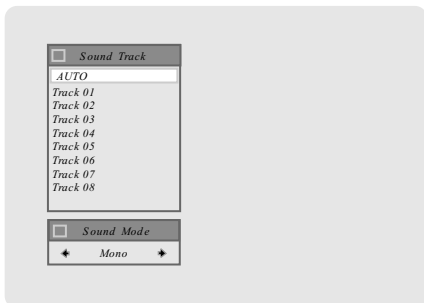

You can choose a language of soundtrack using  button on the RCU when a broadcaster supports various languages of soundtrack.

Also, it is possible to choose a mode among Stereo, Mono, Left and Right using the  buttons on the RCU.



## MENU OPERATIONS

Now this chapter assumes that the STB system has been installed correctly, meaning:

- \* The satellite dish for the STB has been installed, connected to the STB and correctly adjusted to the proper satellite.
- \* The STB is connected to the TV.
- \* The RCU has batteries and ready to control the STB.

If the STB has not been installed or connected properly, please refer to the **INSTALLATION** (connection) menu on this manual.

Many of the functions of the STB are available from the **Main Menu**. Press the **MENU** button to open it.

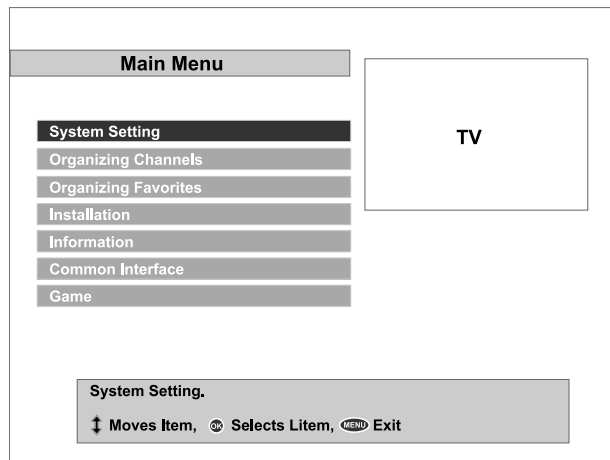

## MENU OPERATIONS

### I. SYSTEM SETTING

#### I-1 TIME SETTING

Various time modes can be set, such as the current local time, the Power On/Off time and the Sleep Time. The exact local present time can be adjusted by using the GMT, the Time Offset and the Mode sub menus.

**PLEASE NOTE: Configure the Local Time before adjusting the Wakeup Time, Power Off Time or the Sleep Time.**

Time Setting	
Local Time setting	08:19
Timer	On
Wakeup time	11:12
Wakeup channel	0
Power Off Time	00:00
Sleep Time	Disable

IRD will wakeup according to the Wakeup time

↑ Moves Item, ↔ Selects Litem,  Previous Menu

## A. Local Time Setting

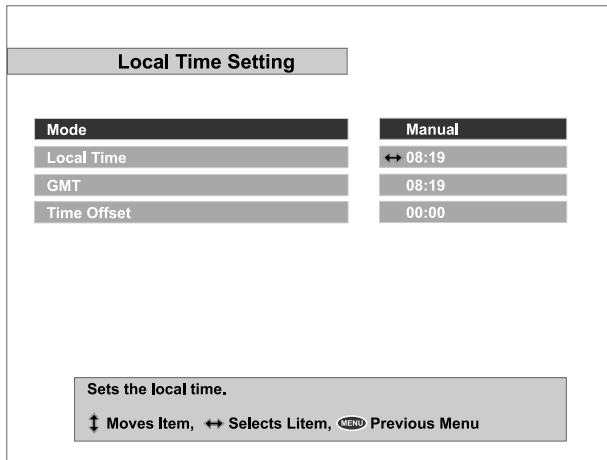

Press the **OK** button at Local Time Setting item in the Time Setting Menu to open the Local Time Setting menu. Inside the Local Time Setting menu, there are 4 sub menus: Mode, Local Time, GMT and Time Offset.

### Mode

By using the **←**, **→** buttons, you can control the Auto/Manual mode. The Auto mode automatically updates the time settings by adding the GMT received from the satellite and the Time Offset value you have inserted. The Auto mode is recommended.

### Local Time

The Local Time is adjustable only when the Mode is on the Manual mode. Adjust the current time, if necessary, by using the numeric buttons and the **←**, **→** buttons.

### GMT

GMT is referred to the standard time of Greenwich. This cannot be changed.

## MENU OPERATIONS

### Time Offset

The current time of the local area can be inserted. In another words, insert the time difference of the local time zone from the GMT. For example, if the local area is Seoul (the time difference from the GMT being 9), insert 9:00. The time is adjustable by using the  $\left(\leftarrow, \rightarrow\right)$  buttons, 15 minutes at a time.

### B. Timer

Time Setting	
Local Time setting	08:19
Timer	On
Wakeup time	↔ 11:12
Wakeup channel	0
Power Off Time	00:00
Sleep Time	Disable

IRD will wakeup according to the Wakeup time

↑ Moves Item, ↔ Selects Litem, **MENU** Previous Menu

Use the  $\left(\leftarrow, \rightarrow\right)$  buttons to select the On/Off mode. If the Timer item is set to On, the Wakeup Time item, the Wakeup channel item and the Power Off Time item becomes adjustable.

### C. Wakeup Time

The Wakeup Time item sets up the time the STB automatically turns on. Insert the preferable Wakeup Time by using the numeric buttons and the  $\left(\leftarrow, \rightarrow\right)$  buttons on the RCU. To disable the wakeup function, make the Timer item Off.

### D. Wakeup Channel

The Wakeup Channel item automatically turns the STB to the preset channel when it automatically turns on by the Wakeup function.

### E. Power Off Time

Time Setting	
Local Time setting	08:19
Timer	On
Wakeup time	11:12
Wakeup channel	0
Power Off Time	↔ 12:00
Sleep Time	Disable

IRD will be on Standby mode after the Power Off time is activated.  
↓ Moves Item, ↔ Selects Item,  Previous Menu

The Power Off Time item sets the time of the STB automatically turns off.

### F. Sleep Time

The Sleep Time item is similar to the Power Off menu. The Sleep Time function turns off after the adjusted sleep time.

## I-2. PARENTAL CONTROL

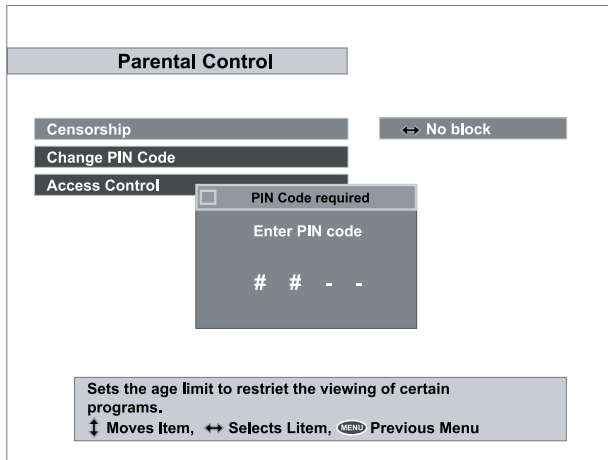

The age rating control, the PIN(Personal Identification Number) Code and the passwords to various menus can be configured. The PIN Code box will automatically appear when this menu is selected. The default PIN Code is 0000.

### A. Censorship

The Censorship item blocks programs according to each specific setting.

Use the (V), (V-) buttons to select the items below.

No Block: Access to everyone.

4~18(age): Inaccessible for viewers within each minimum age limit.

Total Block: Access to no one .

If the channel is limitation free, the block function will not work.

### B. Change PIN Code

Go to the PIN Code item to configure new PIN Code. Press the (OK) button, and a box will appear the screen. Enter the PIN code by using the numeric buttons on your RCU.

## C. Access Control

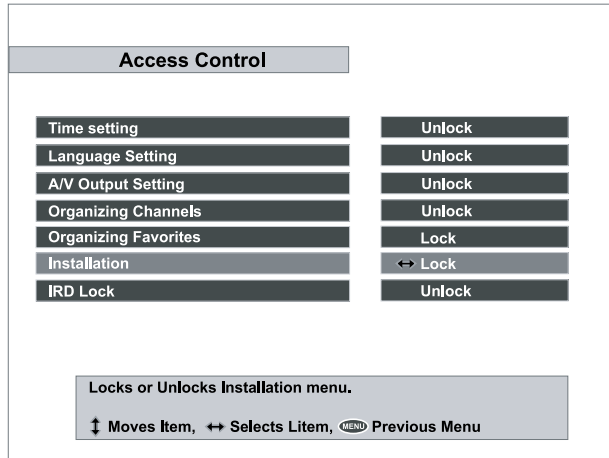

The Access Control menu controls access to 6 items: Time Setting, Language Setting, A/V Output Setting, Organizing Channels, Organizing Favorites and Installation. Press the buttons to Lock/Unlock the access. Locking means controlling the access to specific menus with the PIN Code system. The default PIN Code is 0000.

## I-3. LANGUAGE SETTING

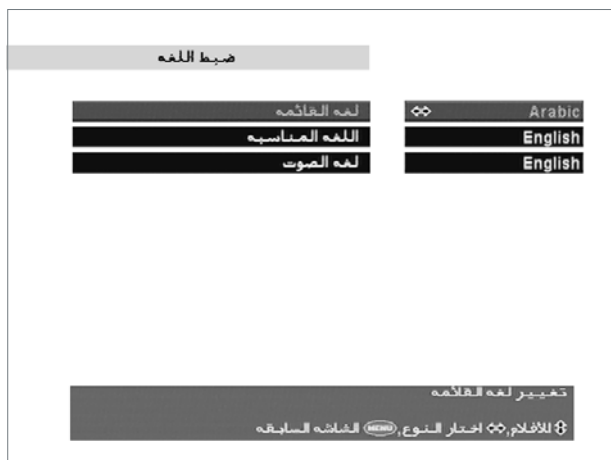

There are many languages available for the menu. The default language is English.

### A. Menu Language

It is an item for changing the language of the Main Menu.

Select the language which the menus will be shown in.

[English / French / German / Italian / Spanish / Arabic / Greek / Turkish / Danish / Swedish / Norwegian]

### B. Subtitle Language

It is an item for changing the language of the subtitle.

As long as the services support, the subtitle language is changeable by pressing the  button on your RCU.

[English / French / German / Italian / Spanish / Arabic / Greek / Turkish / Danish / Swedish / Norwegian]



## MENU OPERATIONS

### C. Audio Language

It is an item for changing the language of the Audio.

The first audio language is set to English. If more than one audio language is transmitted, you may select one language among several languages transmitted by pressing the  button.

[English / French / German / Italian / Spanish / Arabic / Greek / Turkish / Danish / Swedish / Norwegian]

### I-4. A/V OUTPUT SETTING

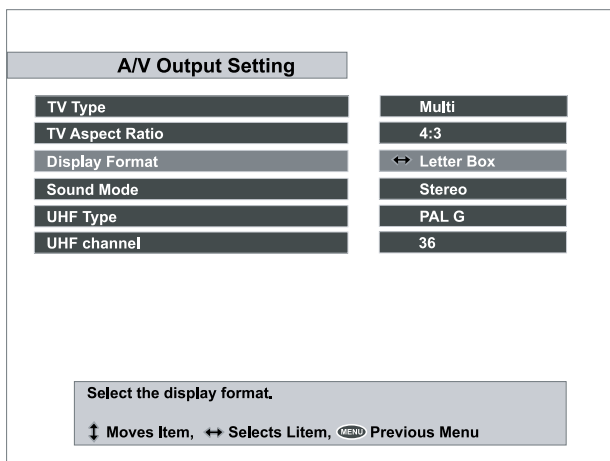

The STB has many A/V Outputs. Control this menu properly according to external components connected to the STB. Configurations concerning Audio and Video can be made here.

#### A. TV Type

Enables the setting of the TV standard. For automatic PAL/NTSC selection, set to Multi.

#### B. TV Aspect Ratio

Enables the setting of the screen format of the TV. Select 4 : 3 or 1 6 : 9 mode by using  buttons.

## MENU OPERATIONS

### C. Display Format

Enables the setting of the screen format of the TV. Select the Letter Box or Center extract mode of 16:9 pictures by using (V-), (V+) buttons.

### D. Sound Mode

Allows you to configure the sound mode. Select the Stereo, Mono, Left and Right modes by using the (V-), (V+) buttons. The Sound mode is configurable later on by using the (M) button on your RCU.

### E. UHF Type

Allows you to change the UHF Type. Select the PAL G, PAL I, PAL K modes by using the (V-), (V+) buttons.

### F. UHF Channel

Choose the UHF Channel by using the (V-), (V+) buttons. The default UHF channel is CH36.

## I-5. OSD Transparency

Adjusts the OSD transparency level of all kinds of menus. The available levels are ranging from 0% to 50%.

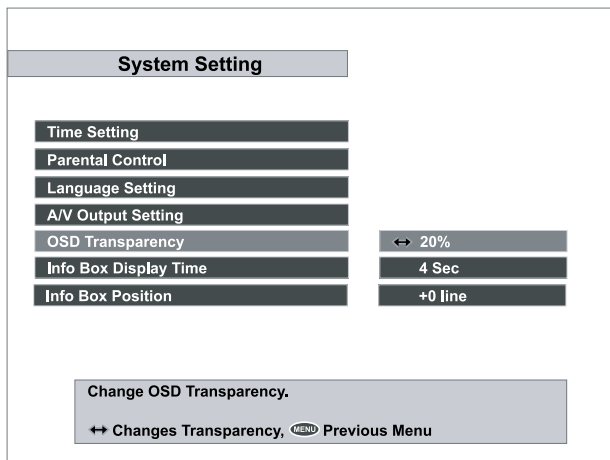

## MENU OPERATIONS

### I-6. Info Box Display Time

Adjusts the time-out of the Info Box. Sets the period of time the Info Box is displayed on screen. The adjustable time is from 0 to 30 seconds.

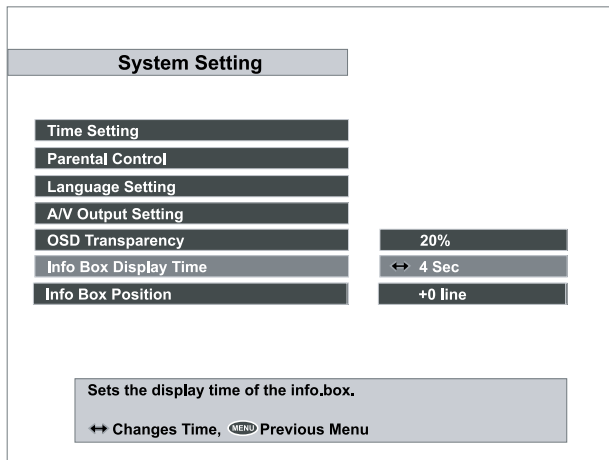

### I-7. Info Box Position

Adjusts the position of the Info Box. Allows you to change the position by using the  buttons.

## II. ORGANIZING CHANNELS

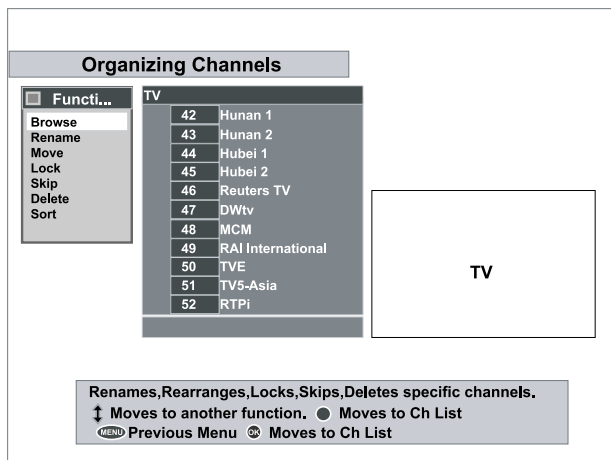

This mode can be used to rename, reorder, lock, hide and to delete TV Services.

### A. Browse

Press the **OK** button. Now, browsing through the Organizing Channels is possible. Press assigned buttons on the help message.

### B. Rename

Use the **P+**, **P-** buttons to select **R e n a m e** item and press the **OK** button to move the cursor to the Channel List. Press **OK** button to display keyboard, and rename the channel. After renaming it, be sure to save it by pressing the **OK** button at **S a v e** item.

### C. Move

You can reorder and move the service to the preferred position. Mark the desired channel to move and press **OK** button. Use the **P+**, **P-** buttons to choose the **M o v e** mode.

## MENU OPERATIONS

### D. Lock

You can restrain and lock the use of the services. From here, locking (and later unlocking) channels in any of the lists is possible e.g. in order to prevent children from watching it. If a locked service is selected, enter the PIN code in order to enjoy it.

### E. Skip

You can ride and skip the services. In order to unlock the skip function, press the  button on the skipped channel. The skipped channels will not be visible on channel list.

### F. Delete

Press  button to delete channels. The delete function differs from the skip function as it deletes the channel completely. Whereas, the skip function just makes the channel invisible.

**NOTE: Deleted channels are permanently deleted. The only way to reobtain is to perform a new channel search.**

### G. Sort

You can sort and rearrange the sequence for the services.

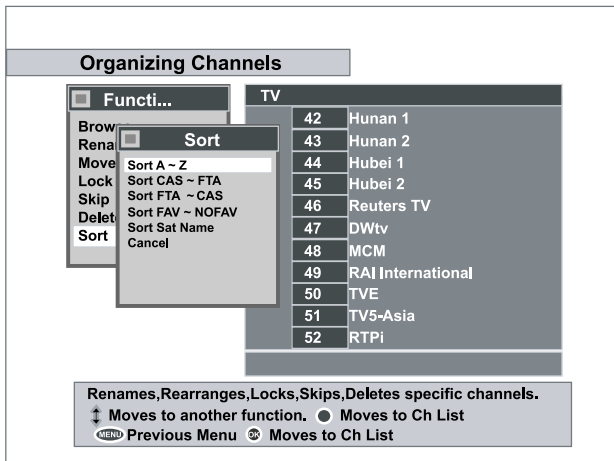

## III. ORGANIZING FAVORITES

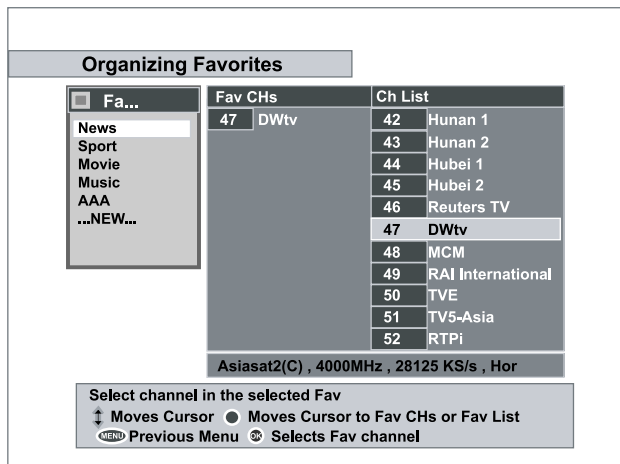

This mode is helpful in adding and deleting services to and from the favorite group.

Under the menu Organizing Favorites, there are three different modes: Fav List, Fav CHs and Ch List. On the Fav List mode, four standard lists are selected as the default menus: News, Sports, Movie and Music. Up to 10 lists including these lists can be added and renamed.

When deleting a service, select a service in the Fav CHs section and press the assigned button on the help message.

To add services into Favorites, locate the cursor to the desired service and press the **OK** button.

Even in the Favorite CHs, you will see basic satellite & Channel information.

## MENU OPERATIONS

### IV. INSTALLATION

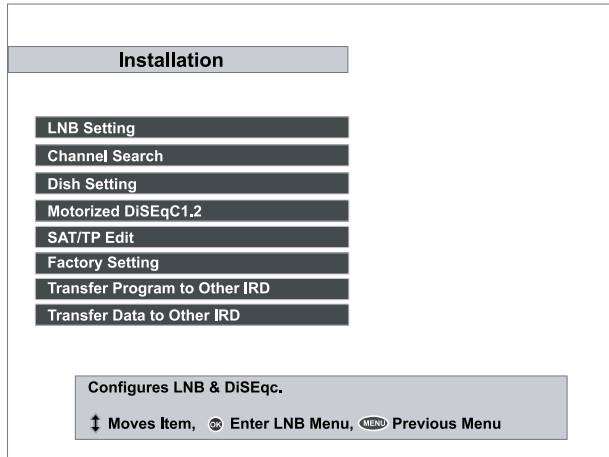

#### IV-1.LNB Setting

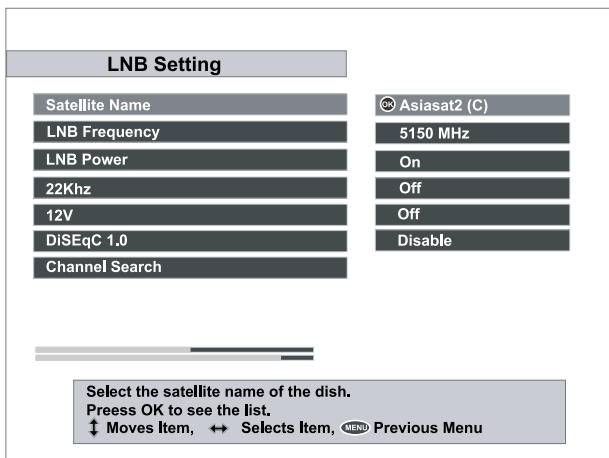

The Low Noise Blockdown Converter (LNB) amplifies the signal received by the satellite dish and lowers the frequency of the signal. The signal is then fed from the LNB at the dish via cable to the STB.



For the LNB Settings, move the cursor to **INSTALLATION** item and press  button.

Then, set the cursor to the **LNB Setting** item and press  button.

### A. Satellite Name

Press the  button to display the Satellite List box. The Satellite name list is put in alphabetical order. Select one of the preprogrammed satellites that correspond to the value of the antenna. If the desired satellite name is not in the list, then select **Others**.

### B. LNB Frequency

Select the L.O. Frequency set to antenna. The LNB Frequency of 5150, 9750, 10600, 10750, 11475 MHz or Universal can be selected by using the  or  button.

**NOTE: If the Universal LNB is selected, both 9750 and 10600 MHz are supported at the same time, and therefore the 22 KHz tone setting is not required.**

### C. LNB Power

Select LNB power ‘**On**’ for internal and ‘**Off**’ for external.

### D. 22 KHz

If you are using a 22 KHz tone switch box, make 22 KHz tone switch enable or disable to select LNB or antenna.



## MENU OPERATIONS

### E. 12V

Use it if the switch box is controlled by 12V DC.

### F. DiSEqC 1.0

The STB is designed to be DiSEqC 1.0 compatible. This allows multiple antennas to be connected to the STB at the same time. If using two or more fixed antennas or LNBs, then it is recommended to use a DiSEqC 1.0 switch.

Select from 1 of DiSEqC to 4 of DiSEqC, Mini A, MiniB or Disable according to the option or the configuration of DiSEqC switch box or antenna.

### G. Channel Search

To go to channel search menu directly from LNB setting menu, press

 button at this item.

## IV-2. Channel Search

Channel Search	
Satellite Name	Asiasat2(C)
Search Mode	Auto
Frequency	
Symbol Rate	
Polarization	
Network Search	Off
PID	
FTA/Scrambled	FTA + CAS
Start Search...	
LNB Setting	5150Mhz

Select the satellite name of the dish,  
press OK to see the list.  
↓ Moves Item, ↔ Selects Item,  Previous Menu

TV

## A. Satellite Name

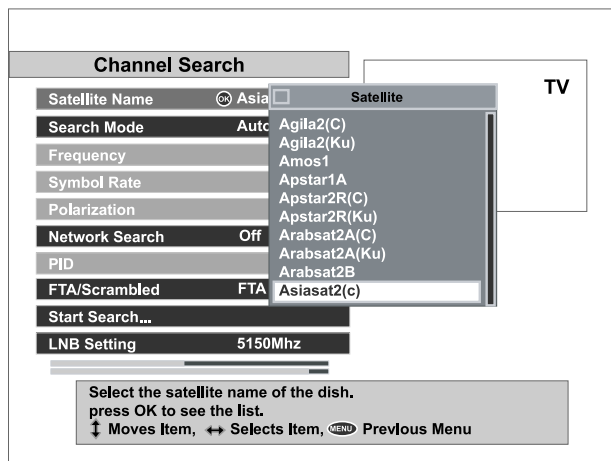

Press the **OK** button to display the Satellite List Box. The Satellite name list is put in alphabetical order. Select one of the preprogrammed satellites that correspond to the value of the antenna. If the desired satellite name is not in the list, then select **Others**.

## B. Search Mode

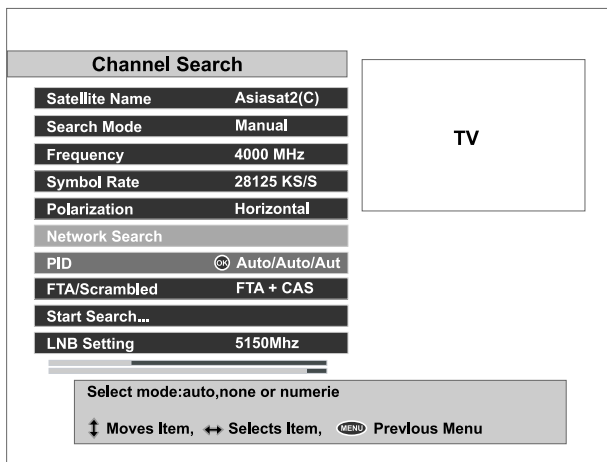

There are 4 search modes, Auto, Manual, Advanced and SMATV. The Auto mode enables to search using the information the STB has. On the other hand, there will be a need to know in advance the frequencies and the symbol rates before using the Manual mode. On the Advanced mode, enter the Audio PID, Video PID or the PCR PID. The SMATV mode is used to special purposes on satellite master antenna TV system.

## C. Frequency

Enter the Transponder's Frequency by using the numeric buttons on your RCU.

## D. Symbol Rate

Enter the Transponder's Symbol Rate by using the numeric buttons on your RCU.

## E. Polarization

Choose the Type of polarization, either the Horizontal or the Vertical.

### F. Network Search

This Network Search item can be used if the Search mode is set to the Manual or Auto mode. If the Network Search item is set to On and the NIT (Network Information Table) is available, the Transponder's information can be found.

### G. PID

Press  button to enter Video/Audio/PCR PID's.

#### 1) Video PID

Insert the Video PID by using the numeric buttons on your RCU.

#### 2) Audio PID

Insert the Audio PID by using the numeric buttons on your RCU

#### 3) PCR PID

Insert the PCR PID by using the numeric buttons on your RCU.

#### 4) SAVE

To ensure the above Video/Audio/PCR PID change, press  button at this item.

### H. FTA/ Scrambled

Choose your favorable channels among FTA only / CAS only / FTA+CAS.

### I. Start Search...

Searches for digital channels after the configuration of the LNB is over. To stop the searching process on the way, press either the **MENU** button or the **EXIT** button.

This menu will be shown as long as the STB is searching for channels. All channels found will be listed in two columns on the screen; with TV channels in one column

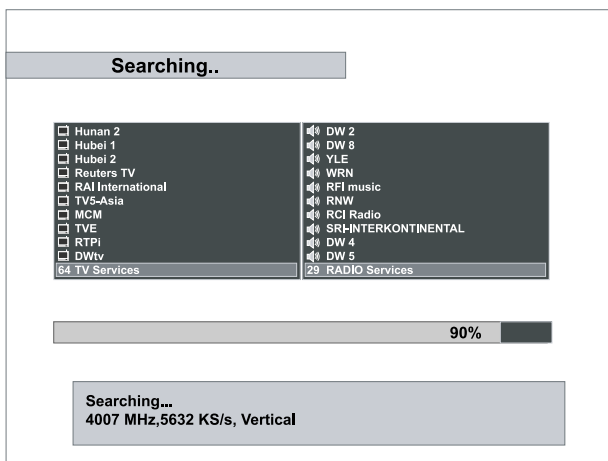

and Radio channels in the other. Please note that the search procedure may take a few minutes. When the search procedure is completed, the screen will show how many TV and Radio channels have been found. Press **OK** button to save the channels.

### J. LNB Setting

To go to LNB Setting menu directly from Channel Search menu,press **OK** button at this item.

## Positioner Setting Guide

For the viewing of certain programs and satellites, the satellite and the antenna has to be configured. This is possible through the Motorized Dish Setting menu.

**NOTE: The positioner should be installed correctly, before proceeding this part of manual.**

### Installation

**Warning: Disconnect STB from mains supply, before installing the positioner and/or skew motors.**

### Positioner

There are 4 wires from actuator motor. That is to say, M1, M2, Pulse(or reed) and GND wires. Please check and follow the procedures.

- A. Connect the GND wire to the GND terminal on your STB.
- B. Connect the motor wires of actuator to the motor terminal(M1,M2) on your STB.

**Caution** : Please do not connect the pulse(or reed) wires to the motor terminals(M1,M2) on STB. It may break down your STB and Motor.

- C. Connect the reed wires of actuator to the 'Pulse' terminal on your STB.

**Caution** : Please do not connect the motor wires(M1,M2) to the pulse terminal on STB. It may break down your STB and motor.

### Skew

There are 3 wires from skew motor. That is to say, +5V, Skew and GND wires. Please check and follow the procedures.

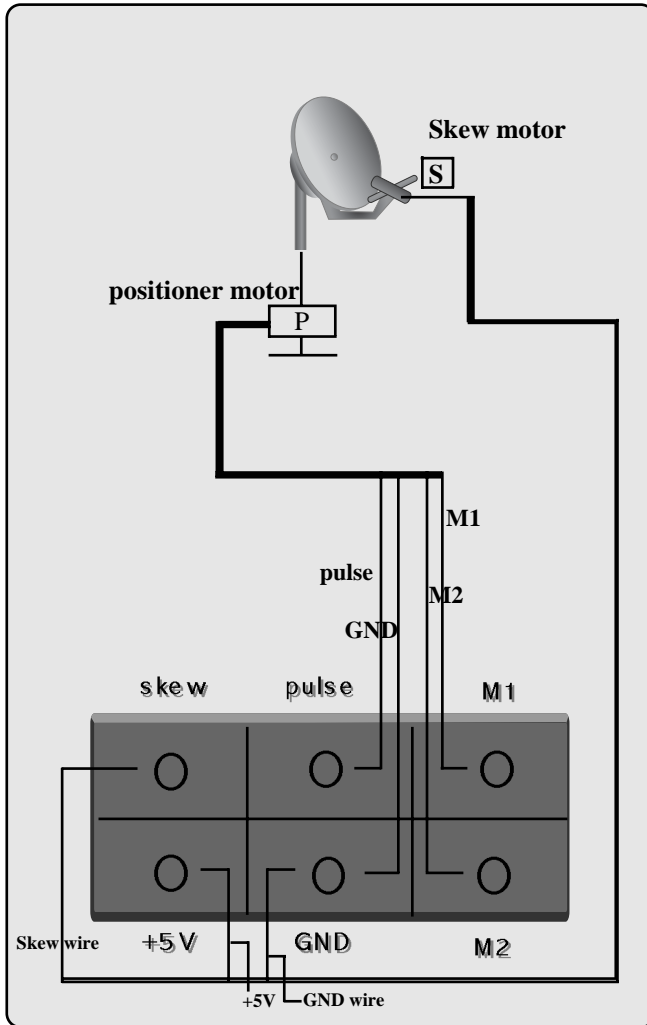

- A. Connect the GND wire of skew motor to the GND terminal on your STB.
- B. Connect the +5V wire of skew motor to the +5V terminal on your STB.
- C. Connect the skew wire of skew motor to the Skew terminal on your STB.

**Caution** : Please do not exchange the above three wires. It May break down your STB and skew motor.

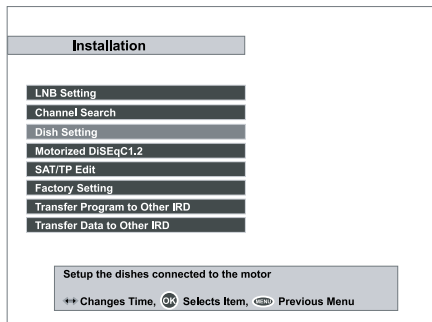

**IV-3. Dish Setting**





First, go to the Motorized Dish Setting under the Installation-Dish Setting-Auto Setting menu. Please note that the  button always indicates the eastern direction and similarly the  button always the western direction.

**IMPORTANT:** After the configurations, “saving” the information is crucial! Press the red (F1) button to save the settings.

Before setting the antenna position, the East Limit and the West limit have to be set.

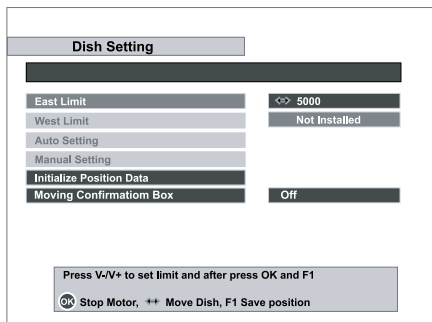
**A. East Limit**



Press the  button to move and adjust the motor to a certain position of the East limit. Save it by pressing **red (F1)** button. The indicated number will be set as 1000.



## B. West Limit

Dish Setting	
East Limit	<< 1000
West Limit	1000
Auto Setting	
Manual Setting	
Initialize Position Data	
Moving Confirmation Box	Off

Press V-V+ to set limit and after press OK and F1

⊙ Stop Motor, ++ Move Dish, F1 Save position

Press the  button to move and adjust the motor to a certain position of the West limit. Save it by pressing **red (F1)** button. The indicated number will increase from 1000.

The dish limits are now saved in the receiver and the dish is positioned to the most western limit.

**CAUTION: If you do not have a movable dish, just press the red(F1) button twice to program the East and the West limit in the same position. This will be indicated by a numeric value of 1000 for both limits.**

There are two main ways of configuring the antenna: the Auto and the Manual setting.







## C. Auto Setting

Motorized Dish Setting	
Configure the most western satellite and press F1	
Satellite Name	Asiasat2(C)
LNB Setting	
Frequency	3640 / 27850 / H
Position	E ... W
Align dish	E W
Skew	Not Set
Channel Search	
Positioned Satellite	
EL	WL 1000

Select the satellite name of the dish.  
Press OK to see the list.  
↑ Moves Item, F1 Save Position, F2 Go to the Position



The Auto Setting consists of 4 main steps: configuring the most western, middle and the most eastern satellite and the specific Satellite you want to set.

### 1) Most Western Satellite

- . **Satellite Name** : Press the  button to display the satellite list. Choose the desirable most western satellite among the list by highlighting it and press the .
- . **Frequency** : Press the  button to display the frequency list. Any frequency will function. Please contact the installer or the service provider for more specific information.
- . **Position dish** : Press the  button to search and allocate the antenna to the adequate position. The positioning procedure might not succeed the first time. Repeat the procedure, if it is needed. As you press the  buttons, the cursor will subsequently move to the left/right until it finds the matching position. As soon as the cursor finds the position, the signal quality (yellow bar) will appear. If the signal strength is appear, the motor will be stopped.
- . **Align dish** : In the position, move the dish to obtain the highest signal quality using the  buttons.
- . *Press the **red (F1)** button to save it!*



**NOTE: There could be an error, though rare, concerning the misplacement of east and west positions. Please check the position of the Antenna Positioner for the best solution.**



### 2) Middle Satellite

- . *Repeat the first 2 steps (Satellite Name, Frequency) as listed above.*
- . **Position dish** : Press the  button to search and allocate the antenna to the adequate position. The positioning procedure might not succeed the first time. Repeat the procedure, if it is needed. As you press the  button, the cursor will subsequently move to the left/right until it finds the matching position. As soon as the cursor finds the position, the signal quality (yellow bar) will appear. If the signal strength is appear, the motor will be stopped.
- . **Align dish** : In the position, move the dish to obtain the highest signal quality using the  buttons.
- . *Press the **red (F1)** button to save it!*

### 3) The Most Eastern Satellite



. Repeat the first 2 steps(Satellite Name, Frequency) as listed above.

. **Position dish** : Press the  button to search and allocate the antenna to the adequate position. The positioning procedure might not succeed the first time. (Repeat the procedure, if it is needed.) As you press the  /  button, the cursor will subsequently move to the left/right until it finds the matching position. As soon as the cursor finds the position, the signal quality (yellow bar) will appear.

. **Align dish** : In the position, peak the dish to obtain the highest signal quality using the  or  buttons.

Press the **red (F1)** button to save it!

### 4) Program Satellites



Now go to the Satellite Name section and press  to display the satellite list. Accordingly, check all satellites you want to positioned between the most western and the most eastern satellite using the  button. Press the **red (F1)** button to save it. Let the receiver calculate all intermediate satellite positions. All selected satellite positions are now stored.







The STB now has programmed the position of all selected satellites. Next step is to store all channels on the satellite. Under the same Dish Setting menu, go to the Channel Search section. Select the Start Search... section to launch the searching procedure and to store all channels.

Repeat this procedure for all satellites.

## D. Manual Setting

Motorized Dish Setting	
Satellite Name	Asiasat2(C)
LNB Satting	
Frequency	3640 / 27850 / H
Position	E .... W
Align dish	E W
Skew	Not Set
Channel Search	
Positioned Satellite	
EL	WL 1000
Select the satellite name of the dish. Press OK to see the list. † Moves Item,F1 Save Position,F2 Go to the Position	

1) **Satellite Name** : Press the  button to display the satellite list. Choose the desirable most western satellite among the list by highlighting it and pressing the  button.

- 2) **Frequency** : Press the  button to display the frequency list. Any frequency will function. Please contact the installer or the service provider for more specific information.
- 3) **Position dish** : Press the  button to search and allocate the antenna to the adequate position. The positioning procedure might not succeed the first time. Repeat the procedure, if it is needed. As you press the  /  buttons, the cursor will subsequently move to the left/right until it finds the matching position. As soon as the cursor finds the position, the quality signal (yellow bar) will appear.
- 4) **Align dish** : In the position, peak the dish to obtain the highest signal quality using the  or  buttons.  
*. Press the red (F1) button to save it!*
- 5) **Channel Search** : Select Start Search... to store all channels.

**NOTE:** There could be an error, though rare, concerning the misplacement of east and west positions. Please check the position of the Antenna Positioner for the best solution.

## E. Initialize Position Data

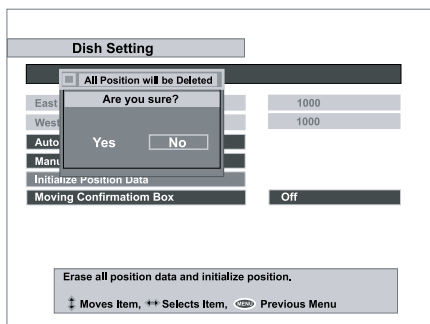

You can initialize all stored position data when you want set up new satellite position.

## F. Moving Confirmation Box

If this item is set to Off, you need not confirm the moving when channel is changed to other satellite.

If this item is set to On, you have to confirm the moving antenna position when channel is changed to other satellite.

## IV-4 . Motorized DiSEqC 1.2

Motorized DiSEqC1.2	
Satellite Name	Asiasat2(C)
Frequency	3640 / 27850 / H
LNB Setting	
Motorized DiSEqC1.2	Disable
DiSEqC1.2 Command Mode	User
Movement	0(Stop)
Motor Control	Goto
Channel Search	

Select the satellite name of the dish.  
Press OK to see the list.

↓ Move Item, OK Selects Item, MENU Previous Menu

If you have DiSEqC 1.2 motorised system, then you can use the DiSEqC 1.2 functions.

### . Satellite Name

A selection of satellite names that will be used to identify a motor position.

. **Frequency:** Selects the frequency to catch the strong signal.

. **DiSEqC Command Mode :** Change the current mode between User and Installer modes.

- User: This mode is used to fine-tune the position of the motor for better reception.

- Installer: This mode is used to search for the position of a satellite manually.

. **Movement:** In case of User mode, the movement is adjustable by fine-tuning.

In case of Installer mode, the movement is adjustable by East, West going command.



## MENU OPERATIONS

### . Motor Control





- Goto : Moves the motor to the stored position of the selected satellite.
- Store : Stores the current position of the motor for the selected satellite.
- Reset : Resets all stored position of the motor relative to the “0” position.  
(Installer mode only)
- Recalculate : Recalculates the position of the Stab Rotor motor.
- Limit E,W: Limits east and west position.
- Limit OFF : Setting of the limitation.
- Goto Ref : Goes to reference.

. **Channel Search**: After saving the DiSEqC configuration at the highest signal quality, press  button to start channel searching of the selected satellite.





### IV-5. SAT/TP Edit

SAT/TP Edit	
Satellite Name	 Asiasat2(C)
Frequency	3640 MHz
Symbol Rate	27850 KS/s
Polarization	Horizontal
SAT Name Edit	
Add new TP	
Delete TP	
Add Satellite	
Delete Satellite	
Channel Search	
<hr/> <hr/>	
Select the satellite name of the dish. Press OK to see the list.	
↑ Moves Item, ↔ Selects Item,  Previous Menu	

### A. Satellite Name

By pressing  button, you can see the listed satellite names .  
Then, using , ,  or  buttons, you can select satellite.

### B. Frequency

By pressing  button, you can see the all frequencies of transponders of a satellite, and also you can select a frequency. Or, by pressing , ,  or  buttons, you can select and view a frequency one by one.

### C. Symbol Rate

You can see the symbol rate of specified satellite on the right side of the menu.

### D. Polarization

You can select the polarization from Horizontal and Vertical modes.





### E. SAT Name Edit

You can change the name of the satellite name by this menu.

Press  button to display a keyboard. There are several items such as Other, Save and Space in the keyboard.

By selecting Other item, you can see a new alphabet character sets.

The Space item a space between two characters. And the Save item is used to confirm the new name of the satellite.

**Notes:** You can move the cursor in the satellite name row by  or  and column by  or  button.

### F. Add New TP

In case of new transponder information is added by broadcaster, you can add new TP(transponder) information and enjoy new services.

Before adding new TP information, you should know the frequency, symbol rate and polarization types.

After adding new information, you should confirm the new information by pressing



button at OK item.

### G. Delete TP

By selecting this item, you can delete the selected TP(Transponder) information.

### H. Add Satellite

Using this menu, you can add new satellite name by keyboard, then it will be added in the Satellite Name menu.

### I. Delete Satellite

By selecting this item, you can delete the selected satellite information.

### J. Channel Search

It is used to go to Channel Search menu directly from SAT/TP Edit menu.



### IV-6. Factory Setting

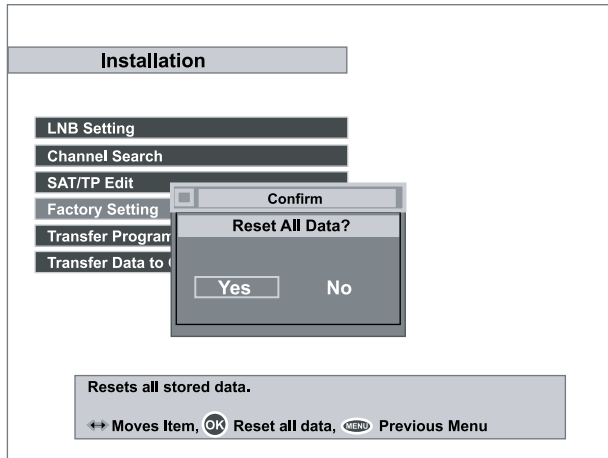

All the stored data can be reset just like it was manufactured.

### IV-7. Transfer Program to Other IRD

It is used to transfer program to other IRD for upgrading the IRD.

**Notes: Please proceed this menu with connecting the IRD of same model and same specification.**

### IV-8. Transfer Data to Other IRD

It is used to transfer data such as satellite/TP information to other IRD for upgrading the IRD.

**Notes: Please proceed this menu with connecting the IRD of same model and same specification.**

## MENU OPERATIONS

### V. INFORMATION

You can check the STB version and refer the calendar.

#### V-1. IRD STATUS

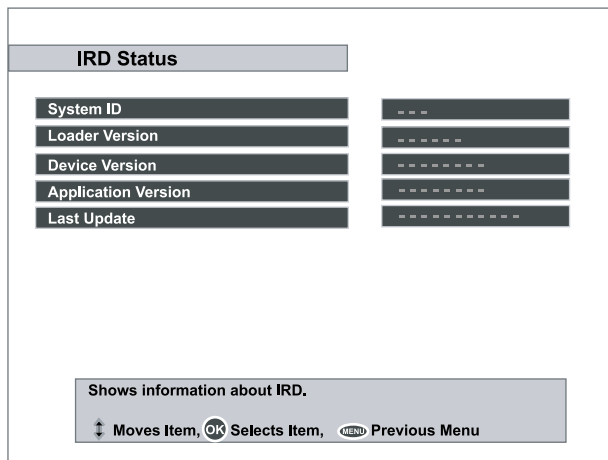





Check the IRD's system information. It shows the IRD's:

- v System ID
- v Loader Version
- v Device Version
- v Application Version
- v Last Update

## V-2. CALENDAR



Press the  or  button to select the year. Press the  or  button to select the month.

## MENU OPERATIONS

### VI. GAME

#### VI-1. Block



#### VI-2. Poker

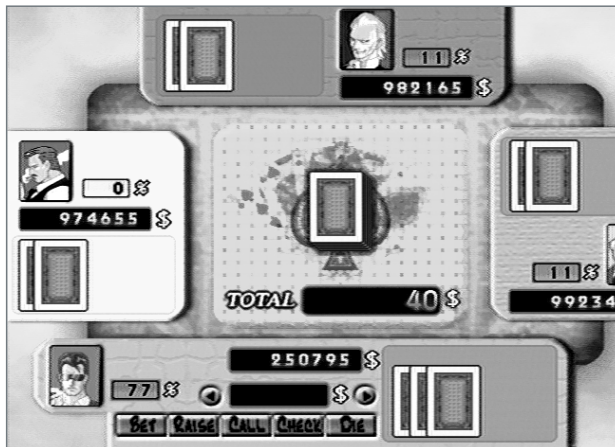

## MENU OPERATIONS

### VI-3. Bricks Lay

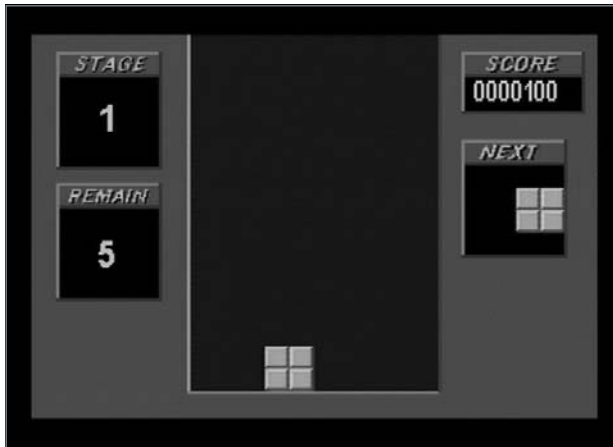

### VI-4. Bomb Hexa

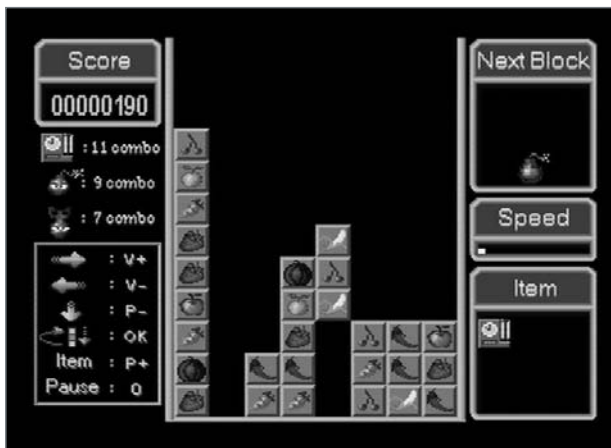

## TROUBLESHOOTING (Q & A)

Problem	Possible Causes	What to do
Nothing appears on the Front Panel.	The main power cable is not connected.	Check that the main power cable is plugged into the power socket.
No sound or picture, but the front panel shows the time or -- : --	STB is in standby mode.	Turn the power ON.
No Picture, No Sound.	<ul style="list-style-type: none"> <li>• The satellite dish is not pointing at the satellite.</li> <li>• No Signal or Weak Signal.</li> <li>• LNB is faulty.</li> <li>• The UHF Key is "pushed down".</li> </ul>	<ul style="list-style-type: none"> <li>• Adjust the dish.</li> <li>• Check the settings in one of the channel search submenus.</li> <li>• Check the cable connections.</li> <li>• Replace the LNB.</li> <li>• Get out of the UHF mode.</li> </ul>
The Remote Control Unit (RCU) is not working.	<ul style="list-style-type: none"> <li>• No Batteries.</li> <li>• The RCU is incorrectly aimed.</li> <li>• The STB is in standby mode.</li> </ul>	<ul style="list-style-type: none"> <li>• Change the batteries (both).</li> <li>• Aim the RCU properly to the STB.</li> <li>• Change the mode to the normal mode.</li> </ul>
You have forgotten your secret PIN Code.		Contact your Service Provider.
Time Setting is wrong.	The Time is not set properly.	Adjust the Time on the Menu.
2 broadcasts overlap.	The channels are not configured properly on the RF mode.	Set the channels in the RF mode under the A/V setting of the Menu between 21 to 69 on the TV.

## SPECIFICATIONS(IRD)

### I . STB SPECIFICATIONS

Item	Specification
Power	90 - 250VAC, 50 / 60Hz
Input Frequency	950 - 2150 MHz
DATA Service	1 RS - 232C, 115kbps
SCART	2 SCARTS: 1 VCR, 1 TV
CINCH A/V Out	1Video / 2 Audio (left and right)
LNB Power	Convertible 13.5/18V (500mA max)
Modulation / FEC Type	QPSK / Multiple convolution coding (DVB Compliant)
DiSEqC Bus	DiSEqC Ver. 1.0 / 1.2 compatible
Tone Switching	22 KHz
RF Modulator	UHF Ch. 21-69 with PAL I/G/B
Specification	MPEG - 2/DVB Compliant SI
Video Compression	MP@ML in MPEG-2
Aspect Ratio	4:3 or 16:9
On-Screen Display	256 colors with full resolution
EPG	Supported

### II . CHANNEL PROCESSING

Item	Specification
Input Frequency Range	950 - 2150 MHz
Number of Channels	3500 TV Channels and 1500 Radio Channels
Tuning System	PLL Digital Synthesis Channels
Tuning Step Size	125 KHz Max
Modulation	QPSK (DVB Specification)
Inner FEC	Rates: 1/2, 2/3, 3/4, 5/6, 7/8 (DVB Specification)
Outer FEC	Reed Solomon coding RS (204, 188, t=8)
Input Symbol Rate	2 to 45 Ms/s
IF Bandwidth	27MHz
Connector Type	F Type ( IEC 169 - 24 female)

## SPECIFICATIONS(IRD)

### III. MPEG AUDIO

Item	Specification
Operation Mode	Mono , Left , Right and Stereo
Sampling Rates	32, 44.1 and 48 kHz
Resolution	18 bit digital to analogue Converters

### IV. VIDEO SPECIFICATIONS

Item	Specification
Specification	Meets ETR 154 amended in ALM-95-021
TV System	PAL I ,G,K
Video Decoding	ISO / IEC 13818-2, MP@ML
Video Resolution	720 pixels × 576 lines × 25 frames per sec.

### V. RF MODULATOR

Item	Specification
Features	Input RF bypass Supported.
Connector	IEC Coaxial female 9.5 mm.(IEC 168-2)
Channel Range	CCIR UHF E 22-69 adjustable
Pre-Set Channel	Channel 36 (or TBD)

### VI -1. POWER SUPPLY (Non-Positioner model only)

Item	Specification
Input Voltage	90 - 250VAC, 50 / 60Hz
Type	SMPS
Power Consumption	Max.30Watt
Standby Power	8Watt
Protection	Separate internal fuse



## SPECIFICATIONS(IRD)

### VI - 1 . POWER SUPPLY (Embedded Positioner model only)

Item	Specification
Input Voltage	90 - 250VAC, 50 / 60Hz
Type	SMPS
Power Consumption	Max.230Watt
Standby Power	8Watt
Protection	Separate internal fuse

### VII. POSITIONER (Embedded Positioner model only)

Item	Specification
Satellite Position	50
Azimuth Control	4 push terminals (M1,M2,Pulse,GND)
Output Power	36VDC, 5A Max
Sensor Type	Reed Switch

## Free Manuals Download Website

<http://myh66.com>

<http://usermanuals.us>

<http://www.somanuals.com>

<http://www.4manuals.cc>

<http://www.manual-lib.com>

<http://www.404manual.com>

<http://www.luxmanual.com>

<http://aubethermostatmanual.com>

Golf course search by state

<http://golfingnear.com>

Email search by domain

<http://emailbydomain.com>

Auto manuals search

<http://auto.somanuals.com>

TV manuals search

<http://tv.somanuals.com>