

**TOPFIELD**



## *The User's Manual*

### *Digital Satellite Receiver*

***TF4000Fe***

***TF5000Fe***

Please read this User's Manual carefully.  
The menu structure and specification can be changed without notice.

---

**TABLE OF CONTENTS**

---

**TABLE OF CONTENTS**

INTRODUCTION.....	5
CONTENTS .....	5
FEATURES .....	6
REMOTE CONTROL UNIT(RCU) .....	9
INSTALLATION (Connection).....	11
Connection to TV, VCR and Hi-Fi .....	11
Connection to the other Satellite Receiver .....	12
GETTING STARTED.....	12
MENU OPERATIONS .....	13
System Setting.....	14
Local Time Setting.....	14
VCR Timer Setting.....	15
Parental Control.....	16
Language Setting .....	17
A/V Output Setting.....	19
OSD Transparency.....	20
Info Box Display Time.....	20
Info Box Position.....	20
Organizing Services.....	21
Organizing Favorites.....	22
Installation.....	23
LNB Setting .....	23
Service Search .....	25
Motorized DiSEqC 1.2 .....	27
USALS Setting.....	28
SAT/TP Edit.....	30
Factory Setting .....	31
System Recovery .....	32
Transfer Program to Other IRD .....	32
Transfer Data to Other IRD.....	32
Firmware Upgrade.....	33
Information.....	34
IRD Status .....	34
Calendar .....	34
Game.....	35
ExBlock .....	35
Bomb Hexa.....	35
Pac Man .....	35
FUNCTION GUIDE .....	36
Service List .....	36
Information Box.....	36
EPG (Electronic Program Guide).....	37

## TABLE OF CONTENTS

Subtitle .....	38
Teletext .....	38
Sound Track .....	38
Multifeed .....	38
SOFTWARE UPGRADE AND PC INTERFACE .....	39
Software Upgrade .....	39
MENU MAP .....	40
SPECIFICATIONS .....	43

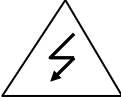

CAUTION

RISK ELECTRIC SHOCK  
DO NOT OPEN





This symbol indicates "dangerous voltage" inside the product that presents a risk of electric shock or personal injury.



This symbol indicates important instructions accompanying the product.

CAUTION : TO REDUCE THE RISK OF FIRE OR ELECTRIC SHOCK,  
DO NOT EXPOSE THIS APPLIANCE TO RAIN OR MOISTURE.

Warning

Please do not insert metal or alien substance into the slots for the Modules and Cards.  
In doing so can cause damage to the STB and reduce its life span.

---

**WARNING**

---

**Please read the following recommended safety precautions carefully for your safety.**

**MAINS SUPPLY** : 90-250V AC 50/60 Hz.

**OVERLOADING** : Do not overload wall outlets, extension cords or adapters as these can result in fire or electrical shock.

**LIQUIDS** : Keep liquids away from the STB. The apparatus shall not be exposed to dripping or splashing and that no objects filled with liquids, such as vases, shall be placed on the apparatus.

**FLAME SOURCES** : Do not place naked flame sources, such as lighted candles, on the STB or near the STB.

**SMALL OBJECTS** : Coins or other small objects must be kept away from the STB as they can fall through the ventilation slots of the STB and cause serious damage.

**CLEANING** : Disconnect the STB from the wall socket before cleaning it. Use a dry cloth lightly dampened (no solvents) to clean the exterior of the STB.

**VENTILATION** : Do not block the STB's ventilation slots. Ensure that a free airflow is maintained around the STB.

**Never** stand the STB on soft furnishings or carpets. Do not use or store the STB where it is exposed to direct sunlight or near a heater.

**Never** stack other electronic equipment on top of the STB.

**ATTACHMENTS** : Do not use any attachments that are not recommended as these may cause hazards or damage the equipment.

**CONNECTION TO THE SATELLITE DISH LNB** : Disconnect the STB from the mains before connecting or disconnecting the cable from the satellite dish. Failure to do so can damage the LNB.

**SERVICING** : Do not attempt to service this product by yourself. Do not remove the cover. Refer all servicing to qualified service agents.

**LIGHTNING** : For protection we recommend that you connect the STB via an external surge protection device. Disconnect the antenna cable from STB during lightning storms.

**EARTHING** : The antenna cable **must be earthed**.

**LOCATION** : Locate the STB indoor place properly to prevent lightening, raining and direct sunlight. Do not allow the STB to be exposed to hot, cold or humid conditions.

---

## INTRODUCTION

### INTRODUCTION

Thank you for purchasing the STB.

This STB is fully compliant with the international DVB standard and thus transmits digital images, sounds, information guides and teletext directly to your TV through the satellite broadcasting.

Now you can comfortably see and receive digitally transmitted music, news, movie and sports satellite broadcasts in your office or at your home. The STB records and plays back satellite broadcasts. You can enjoy interesting games embedded in STB.

In the Service Search section, both the automatic channel search method and the manual search mode are provided. Also it supports DiSEqC 1.0, 1.1, 1.2 and USALS(DiSEqC 1.3), enabling you to move your antenna in order to focus preferred satellite. You can save up to 3500 TV and 1500 Radio channels and work around with the Favorite, Lock, Delete, Move and Sort functions.

The menu is very modern and supports multiple languages. All functions can be carried out using the remote control and some of the functions can also be carried out using the front panel. The STB is easy to use and adaptable for future advances. Please be aware that new software may change the functions of the STB.

If you have any difficulties concerning the operation of your STB, please refer to the relevant section of this manual, including the 'Troubleshooting'. This Manual will provide you with useful information on using the STB.

### CONTENTS

Please ensure that the following items are included with the STB.

- 1) Remote control unit
- 2) Batteries (size AAA)
- 3) User's Guide (this document)

---

## FEATURES

---

### FEATURES

- Fully Compliant with DVB.
- MPEG-2 Digital and fully DVB compliant
- 22KHz On/Off
- Automatic FEC detection
- Automatic Service Search
- DiSEqC 1.0, 1.1, 1.2 and USALS(DiSEqC 1.3)
- 5000 services (TV and Radio) programmable
- Service switching time less than 1 second
- Service list editing
- Favorite service list editing
- 30 favorite service groups support
- Automatic and Manual PAL/NTSC selection
- Multilingual Audio support
- 256 color On-screen Display (OSD)
- Multilingual menu text support
- GMT and Time Offset support
- Full Picture In Graphic (PIG) function
- Electronic Program Guide (EPG) for on screen service information
- Subtitle supported
- Teletext supported by VBI insertion and software emulation
- Parental lock facility by service and program event
- Program and Service information transfer from receiver to receiver
- Exciting games embedded
- RF modulator output
- S/PDIF for digital audio or Dolby AC-3 bitstream output
- SCART and RCA A/V output
- CVBS, RGB, YUV and S-VIDEO output via SCART connector
- VCR Timer function

## FRONT/ REAR PANELS

### FRONT/ REAR PANELS

#### 1) FRONT PANEL

##### - DISPLAY

During the STANDBY mode, the current time is displayed.

When the power is ON, the current status is displayed (TV/ Radio/ Menu).

##### - POWER

The power button of STB (ON / Stand by)

##### - CHANNEL

Change the channels

##### - LED

TV / STB

REMOTE

STAND BY

#### 2) REAR PANEL

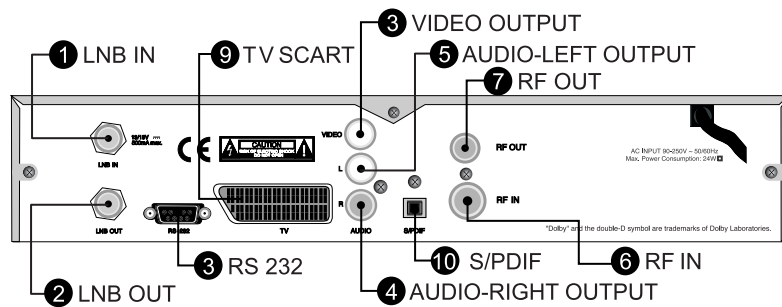

---

## FRONT/ REAR PANELS











---

1. LNB IN
  - Connect the satellite antenna cable
2. LNB Out
  - Use it to connect to another STB
3. VIDEO OUTPUT
  - Video output. (YELLOW)
4. AUDIO-RIGHT OUTPUT
  - Audio output. (RED)
5. AUDIO-LEFT OUTPUT
  - Audio output. (WHITE)
6. RF IN
  - Connect the TV antenna
7. RF OUT
  - Connect the TV RF IN
8. RS232
  - Upgrade the STB data & software
9. TV SCART
  - Connect the TV or VCR
10. S/PDIF
  - Optical output for Digital Audio









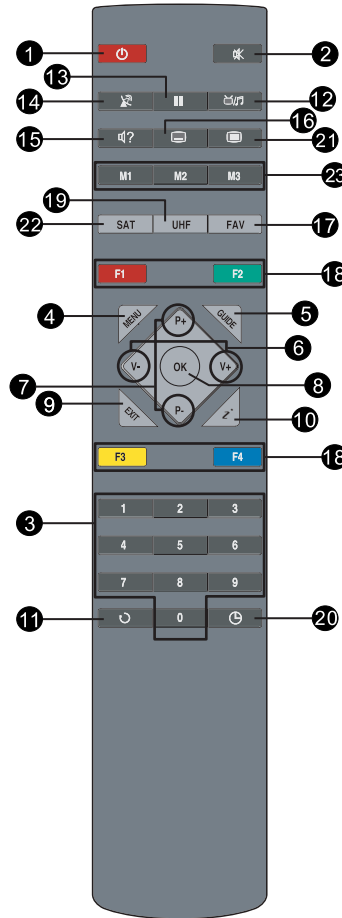











## REMOTE CONTROL UNIT(RCU)

### REMOTE CONTROL UNIT(RCU)

- POWER Button** (  )
  - Switch the STB between Operation and Standby mode.
- MUTE Button** (  )
  - Enable / Disable the Audio.
- Numeric Buttons** (  )
  - Select the TV or Radio service services and menu options.
- MENU Button** (  )
  - Display the Menu on screen or return to previous menu from submenu.
- GUIDE Button** (  )
  - Display the EPG on screen when available.
  - Remove EPG when EPG is displayed.
- V+/V- Buttons** (  )
  - Adjust the volume (Increase / Decrease).
  - Change the value of the selected item in Menu.
- P+/P- Buttons** (  )
  - Service up or down through the available services.
  - Move the selection bar in Menu.
- OK Button** (  )
  - Display Service List on screen.
  - Select an item in the menu.
- EXIT Button** (  )
  - Return to the previous menu and the screen.
- INFO Button** (  )
  - Display the program information box on the Screen and remove it.
  - Display the extended event information when the information box is displayed.



## REMOTE CONTROL UNIT(RCU)

11. RECALL Button (  )
  - Select the previously viewed service.
12. TV/ Radio Button (  )
  - Select the TV/Radio mode.
13. PAUSE Button (  )
  - Pause the live picture.
14. TV/STB Button (  )
  - Change the terrestrial TV and STB mode.
15. SOUND Button (  )
  - Select Sound Track and LEFT / RIGHT / MONO / STEREO sound.
  - Select the multifeed service if multifeed is available.
16. SUBTITLE Button (  )
  - Activate the subtitle selection window. Select the subtitle language in the list.
17. FAV Button (  )
  - Display the favorite service list.
18.  Button (Red),  Button (Green),  Button (Yellow),  Button (Blue)
  - These buttons are function key. So, the function in each OSD Screen can be referred in each instruction message in help window.
19. UHF Button (  )
  - Display and alter the UHF setting in menu.
20. SLEEP Button (  )
  - Display the sleep time. At the sleep time, the power is automatically turned OFF and the STB goes to the STANDBY mode.
21. TELETEXT Button (  )
  - Enable the teletext with software emulation.
22. SAT Button (  )
  - Display service list by satellite.
23.    Button
  - Reserved

## INSTALLATION (Connection)

### INSTALLATION (Connection)

- First, connect both the satellite antenna and the TV to the STB.
- There are some of the most common ways to connect the equipment in this manual.
- There are several ways of connecting the STB to the existing Audio/TV system.
- We recommend one of the following setup.
- If you have problems with your connections and need help, contact your dealer or service provider.

#### **Connection to TV, VCR and Hi-Fi**

##### **1) Connection to the TV with the SCART Cable.**

Connect one end of the SCART cable to the TV SCART socket on the STB and the other end to a SCART socket on the TV.

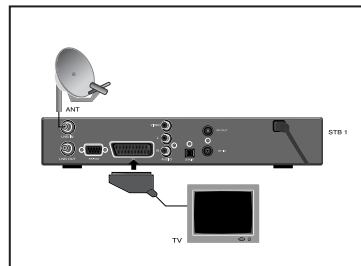

##### **2) Connection to the TV with the CINCH Cable.**

Connect one end (3 connectors) of the CINCH cable to the AUDIO-RIGHT (red), AUDIO-LEFT (white) and the VIDEO output (yellow) socket on the STB. Connect the other end (3 connectors) to the AUDIO-RIGHT (red), AUDIO-LEFT (white) and the VIDEO input (yellow) socket on the TV or Hi-Fi.

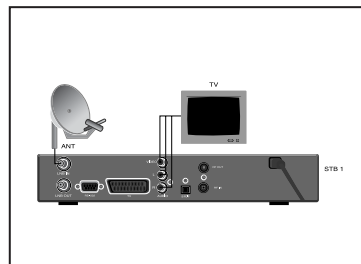

##### **3) Connection to the TV using the RF cable.**

Connect a terrestrial antenna to RF IN socket on the STB.

Connect one end of the RF cable to the RF OUT socket on the STB.

Connect the other end to the ANT IN socket on the TV.

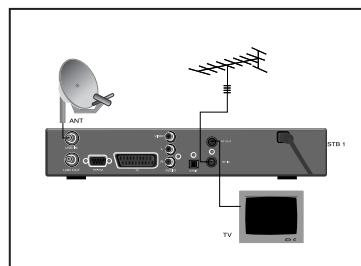



## INSTALLATION (Connection)

### Connection to the other Satellite Receiver.

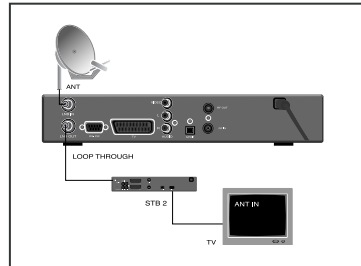



Connect the satellite antenna cable to the LNB IN socket on the STB. With other connector, connect the IF OUT socket on the STB and the LNB IN socket of the other STB or STB.



## GETTING STARTED

Press the Power (  ) button to operate the STB from the STANDBY mode. Now, the Info Box will appear for a given time and disappear. By pressing  button, the Info Box will remain on the screen. The display time of the Info Box is adjustable in the **System Setting** menu of the **Main** menu.

**IMPORTANT: Before taking charge of your new STB, some important technical settings are essential.**

- First, press the **MENU** (  ) button on the RCU to make the Main Menu appear.
- Go to the **LNB Setting** item in the **Installation** menu and press  button.
- Choose the right parameters for **Satellite Name**, **LNB Frequency**, **LNB Power**, **22KHz**, **DiSEqC 1.1** and **DiSEqC 1.0**.
- Set the **Motorized DiSEqC1.2** and the **USALS** items according to your antenna, LNB and satellite settings. If the right Satellite Name and LNB Frequency were not found in the list, call the dealer for satellite information.
- Then, press  button at Service **Search** item and go to the **Service Search** menu.
- Set the **Search Mode** to the **Auto**. (**Manual**, **Advanced** or **SMATV Search**)
- Select the **Start Search...** item and press  button.
- The search procedure will take a while. Press  button when the searching process is finished to confirm and save the new service list.
- For further information, please refer to the **LNB Setting** part of MENU OPERATIONS in this manual.

## MENU OPERATIONS

### MENU OPERATIONS

Now this chapter assumes that the STB system has been installed correctly, meaning:

- The satellite dish for the STB has been installed, connected to the STB and correctly adjusted to the proper satellite.
- The STB is connected to the TV.
- The RCU has batteries and ready to control the STB.

If the STB has not been installed or connected properly, please refer to the **INSTALLATION** menu on this manual.

Many of the functions of the STB are available from the **Main Menu**. Press  button to open it.

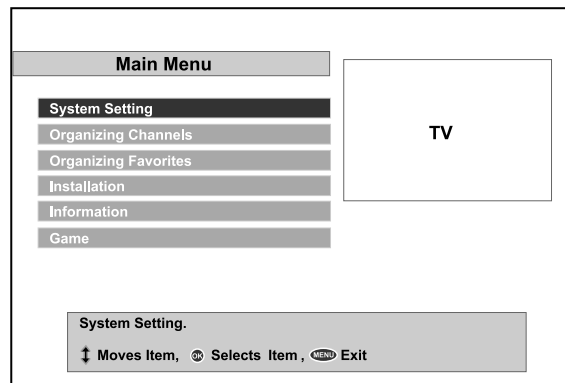

## MENU OPERATIONS

### System Setting

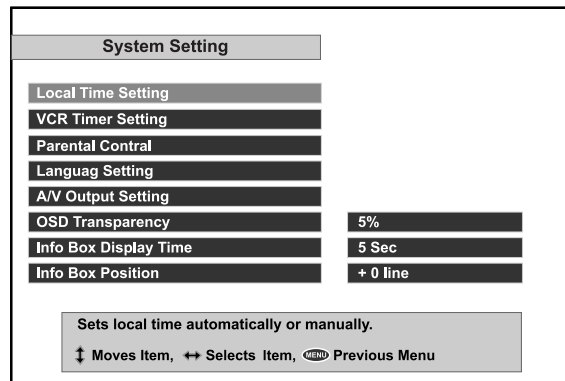

#### Local Time Setting

The exact local current time can be adjusted by using the **GMT**, the **Time Offset** and the **Mode** sub menus.

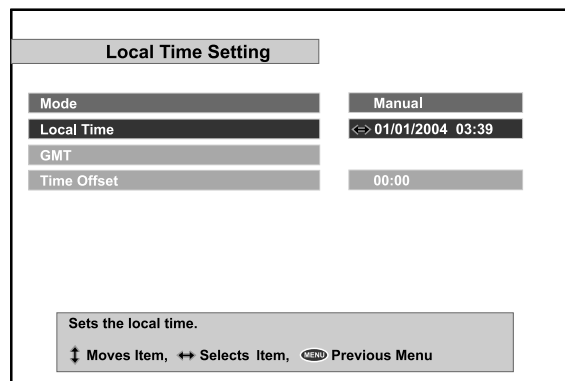

#### A. Mode

By using ◀, ▶ buttons, you can select on of the **Auto/Manual** mode. The **Auto** mode updates the time settings automatically by the GMT received from the broadcast and the **Time Offset** you have inserted. The **Auto** mode is recommended.

#### B. Local Time

## MENU OPERATIONS

The Local Time is adjustable only when the Mode is in the **Manual** mode. Adjust the current time, if necessary, by using the numeric buttons and ◀, ▶ buttons.

### C. GMT

GMT is referred to the standard time of Greenwich. It cannot be changed.

### D. Time Offset

The current time of the local area can be inserted. In another words, insert the time difference of the local time zone from the GMT. For example, if the local area is Seoul (the time difference from the GMT is 9), insert 9:00. The time is adjustable by using ◀, ▶ buttons, 15 minutes at a time.

### VCR Timer Setting

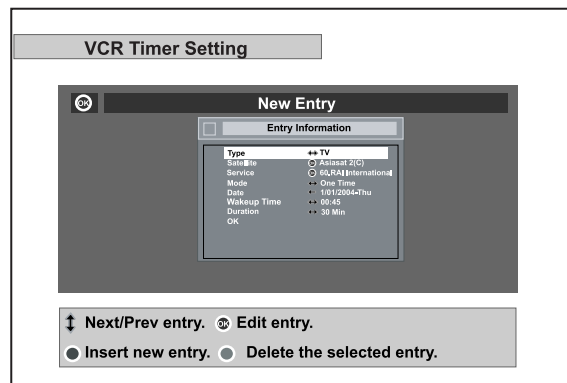

01	21	FASHION TV	08/03-Wed	11:39	30Min	OT
02	70	DWtv	07/02-Mon	13:00	60Min	WL

Service Number      Service Name      Reseved Date and Time to Start playing      Duration      Mode

## MENU OPERATIONS

To insert new entry of Timer Setting, press **F1** (Red) Button. Press **OK** button to edit the entry, and press **F2** (Green) button to delete the selected entry.

- **Type** : Select TV or Radio by pressing **◀** , **▶** button.
- **Satellite** : Press **OK** button to display the satellite list. Select a satellite that includes the service to be played.
- **Service** : Select the service to be reserved for recording by pressing **OK** button.
- **Mode** : By using **◀** , **▶** buttons, select one among **One Time**, **Everyday**, **Every Weekend**, **Weekly**, and **Every Weekday**.
- **Date** : Select the recording start date by pressing **◀** , **▶** buttons.
- **Wakeup Time** : Select the wakeup time. **◀** , **▶** buttons and **0** – **9** buttons are available.
- **Duration** : Select the recording duration by pressing **◀** , **▶** buttons.
- **OK** : To confirm the setting for the reserved recording, press **OK** button.

### Parental Control

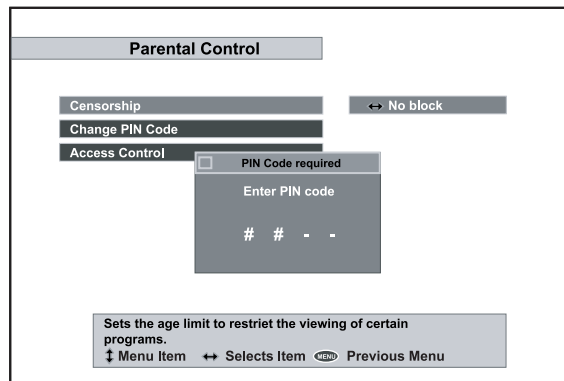

Password to various menus can be configured. The PIN Code box will automatically appear when this menu is selected. The default PIN Code is **0000**.

#### A. Censorship

The **Censorship** item blocks programs according to each specific setting.

Use **◀** , **▶** buttons to select the items below.

**No Block** : Access to everyone.



## MENU OPERATIONS

**Total Block** : Access to no one without PIN code.

If the service is limitation free, the block function will not work.

**4~18(age)**: Inaccessible for viewers within each minimum age limit if a maturing rating of the event is same or lower than the age limit.

In case of inaccessible, the STB asks the PIN Code and check the age limit.



If the service is limitation free, the block function will not work.

### B. Change PIN Code

Go to the **Change PIN Code** item to configure new PIN Code. Press  button, then a box will appear on the screen. Enter the PIN code by using the numeric buttons on your RCU.

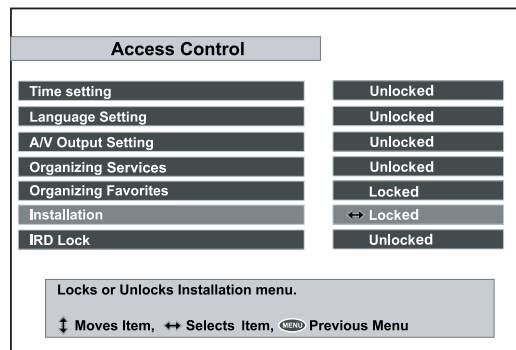
### C. Access Control



The **Access Control** menu controls access to following items: **Time Setting**, **Language Setting**, **A/V Output Setting**, **Organizing Services**, **Organizing Favorites**, **Installation** and **IRD Lock**. Press ,  buttons to **Locked/Unlocked** the access. **Locked** means controlling the access to the specific menus with the PIN Code system. The default PIN Code is **0000**.

### Language Setting

There are many languages available for the menu.

## MENU OPERATIONS

### A. Menu Language

It is an item for changing the language of the Main menu.

Select the language that the menus will be shown in.

[English / French / Deutsch / Italian / Spanish / Arabic / Greek / Turkish / Danish / Swedish / Norwegian / Dutch / Russian / Polish / Persian]

\* The supported language can be changed without any notice.

### B. Subtitle Language

It is an item for changing the language of the subtitle.

As long as the services support it, the subtitle language is changeable by pressing  button on your RCU.

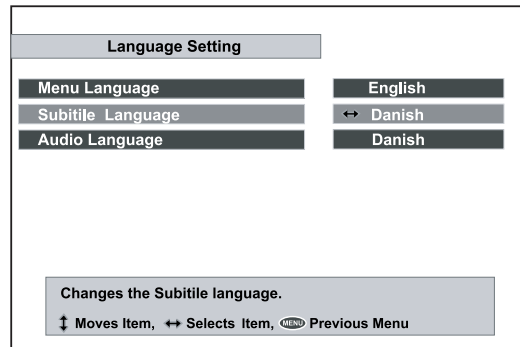

[English / French / Deutsch / Italian / Spanish / Arabic / Greek / Turkish / Danish / Swedish / Norwegian / Dutch / Russian / Polish / Persian / Disable]

\* The supported language can be changed without any notice.

### C. Audio Language

It is an item for changing the language of the Audio.

If more than one audio language is transmitted, you may select one language among the languages transmitted by pressing  button.

[English / French / Deutsch / Italian / Spanish / Arabic / Greek / Turkish / Danish / Swedish / Norwegian / Dutch / Russian / Polish / Persian]

\* The supported language can be changed without any notice.

## MENU OPERATIONS

### A/V Output Setting

The STB has many A/V Outputs. Control this menu properly according to external components connected to the STB. Configurations concerning Audio and Video can be made here.



#### A. TV Type

Select your TV standard. For automatic **PAL/NTSC** selection, set it to **Multi**.



#### B. Video Output

Select the mode of Video output among **RGB**, **S-Video**, **YUV** and **CVBS** on TV SCART by using  ,  buttons.



#### C. TV Aspect Ratio

Select your TV screen format. Select **4:3** or **16:9** mode by using  ,  buttons.



#### D. Display Format

If you have a TV set with the 4:3 picture format and transmission is in 16:9, you can select the display format. Select the **Letter Box** or **Center extract** by using  ,  buttons.



#### E. Sound Mode

It allows you to configure the sound mode. Select the **Stereo**, **Mono**, **Left** and **Right** mode by using  ,  buttons. The Sound mode is configurable later on by using  button on your RCU.

#### F. RF Output

When the STB is connected to the TV by an RF cable, you may need to select the correct TV standard system. Select the **PAL G**, **PAL I**, **PAL K**, **NTSC M** mode by using  ,  buttons.

#### G. RF Channel

Select a UHF channel by using  ,  buttons. The default UHF channel is CH36. When you change the UHF channel number, you must also change to the same value on the TV. If you do not, there will be no picture and sound.

## MENU OPERATIONS

### OSD Transparency

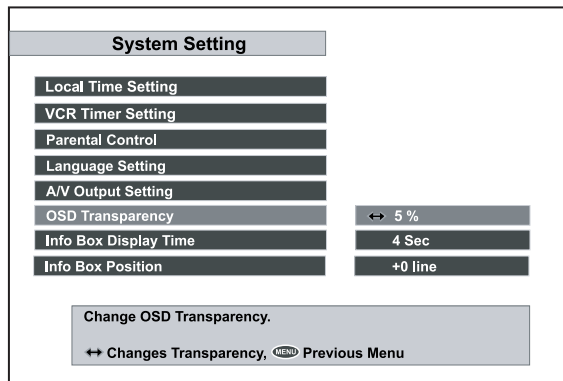



Adjust the OSD transparency of all the menus. The available levels are ranging from **0%** to **50%**.

### Info Box Display Time

Adjust the time-out of the Info Box. Set the period of time that the Info Box is displayed on screen. The adjustable time is **0** to **30** seconds, **No info box** and **Never Hide**.

### Info Box Position

Adjust the position of the Info Box. It allows you to change the position by using  ,  buttons.

## MENU OPERATIONS

### Organizing Services

This mode can be used to rename, reorder, lock, hide and delete TV Services.

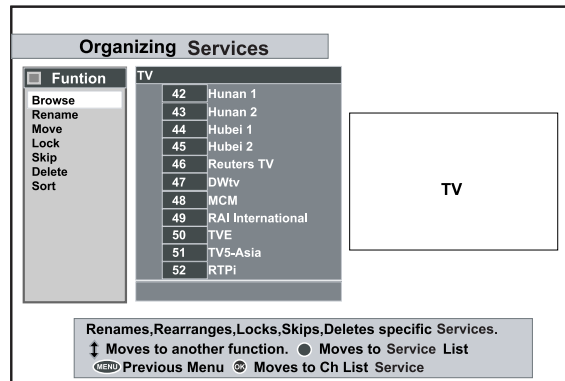

#### A. Browse

Press button. Now, browsing through the **Organizing Services** is possible. Press assigned buttons on the help message.

#### B. Rename

Use , buttons to select **Rename** item and press button to move the cursor to the Service List. Press button to display keyboard, and rename the service. After renaming it, be sure to save it by pressing button at **Save** item.

#### C. Move

You can reorder and move the service to the preferred position. Mark the desired service to move and press button. Use , buttons to choose the **Move** mode.

#### D. Lock

You can restrain and lock the services. From here, locking (and later unlocking) services in any of the lists is possible e.g. in order to prevent children from watching it. If a locked service is selected, you should enter the PIN code in order to enjoy it.

#### E. Skip

You can hide and skip the services. In order to unlock the skip function, press button on the skipped service. The skipped services will not be visible on the service list.

## MENU OPERATIONS

### F. Delete

Press  button to delete services. The delete function differs from the skip function as it deletes the service completely. Whereas, the skip function just makes the service invisible.

**NOTE: Deleted services are permanently deleted. The only way to recover them is to perform a new service search.**

### G. Sort

You can sort and rearrange the service list.

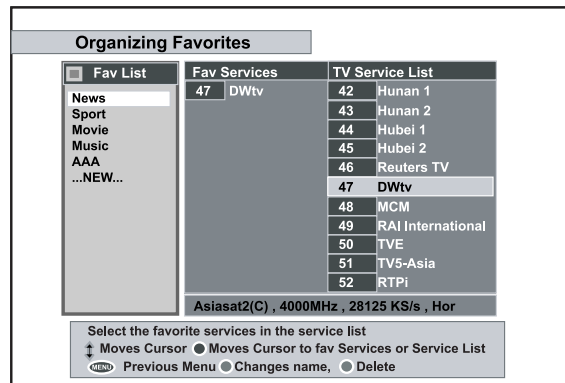

## Organizing Favorites



This mode is helpful in adding and deleting services to and from the favorite group. Under the menu **Organizing Favorites**, there are three different modes:

**Fav List**, **Fav Services** and **TV or Radio Services List**.

On the **Fav List** mode, four standard lists are selected as the default menus: **News**, **Sports**, **Movie** and **Music**. Up to 30 lists including these lists can be added and renamed. When deleting a service, select a service in the **Fav Services** section and press the assigned button on the help message.



To add services into **Favorites**, locate the cursor to the desired service in **Services List** and press  button. To delete a service from Favorites, locate the cursor to the service in **Fav Services** and press  button.

## MENU OPERATIONS

### Installation

#### LNB Setting



The Low Noise Block down Converter (LNB) amplifies the signal received by the satellite dish and lowers the frequency of the signal. The signal is then fed from the LNB at the dish via cable to the STB.

For the LNB Setting, move the cursor to **Installation** item and press  button. Then, move the cursor to the **LNB Setting** item and press  button.

#### A. Satellite Name

Press  button to display the Satellite List. The list of Satellite is put in alphabetical order. Select one of the preprogrammed satellites that corresponds to the direction of the antenna. If the desired satellite name is not in the list, then select **Other**.

#### B. LNB Frequency

Select the L.O. Frequency of the LNB. The LNB Frequency of 5150, 9750, 10600, 10750, 11250, 11475, 9750/10600, 9750/10700 or 9750/10750 can be selected by  or  button.

Also you can insert LNB frequency by using Numeric key on the RCU.

#### E. LNB Power

Select LNB power **On** to output the LNB voltage.

#### F. 22 KHz

If you are using a 22 KHz tone switch box, make 22 KHz tone switch enable or disable to select LNB or antenna.

**NOTE: If the LNB Frequency is set to Universal LNB (9750/10600, 9750/10700 or 9750/10750), it is not possible to set 22KHz because high or low band is selected by 22KHz.**

#### G. DiSEqC 1.1

The STB is designed to be DiSEqC 1.1 compatible. This allows multiple antennas to be connected to the STB at the same time. If you are using two or more fixed antennas or LNBs, then it is recommended to use a DiSEqC 1.1 switch.

If you use a DiSEqC 1.1 switch only, it is possible to connect up to 4 antennas.

Set the DiSEqC 1.0 to **Disable** and select an item in DiSEqC1.1.

## MENU OPERATIONS

If you use a DiSEqC1.1 switch and DiSEqC1.0 switches, it is possible to connect up to 16 antennas. Connect the DiSEqC1.1 switch to the LNB input and connect the DiSEqC1.0 switches to the DiSEqC1.1 switch.

Set the DiSEqC1.1 item and DiSEqC1.0 item according to the antenna configuration. For example, set DiSEqC1.1 to **2 of 4** and DiSEqC1.0 to **3 of 4** to select **A7**.

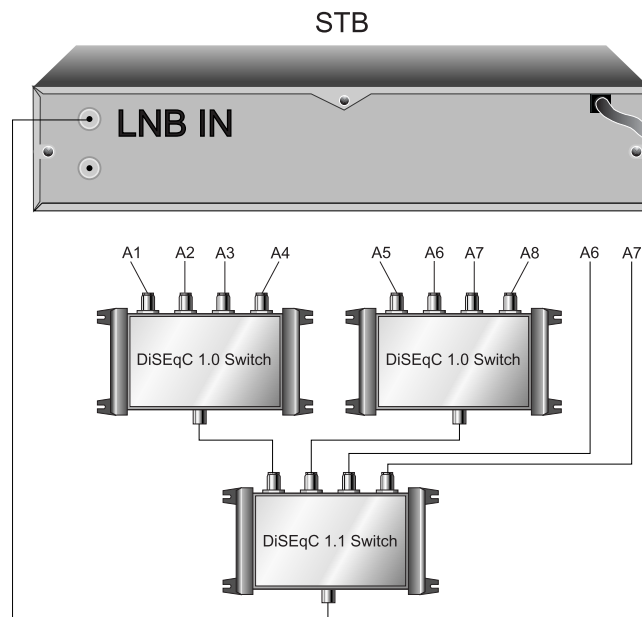

### H. DiSEqC 1.0

The STB is designed to be DiSEqC 1.0 compatible. This allows multiple antennas to be connected to the STB at the same time. If you are using two or more fixed antennas or LNBs, then it is recommended to use a DiSEqC 1.0 switch.

Select one of **1 of DiSEqC** to **4 of DiSEqC**, **Mini A**, **Mini B** or **Disable** according to the option or the configuration of DiSEqC switch box or antenna.

### I. Service Search

To go to Service Search menu directly from LNB Setting menu, press  button at this item.



## MENU OPERATIONS

### Service Search

Service Search	
Satellite Name	Asiasat2(C)
Search Mode	↔ Auto
Frequency	
Symbol Rate	
Polarization	
Network Search	Off
PID	
FTA/Scrambled	FTA + CAS
Start Search...	
LNB Setting	5150Mhz

00% Level  
00% Quality

Select the scanning mode  
↓ Moves Item, ↔ Selects Item, ⏪ Previous Menu

#### A. Satellite Name

Press  button to display the Satellite List Box. The list of Satellite is put in alphabetical order. Select one of the preprogrammed satellites that correspond to the direction of the antenna. If the desired satellite name is not in the list, then select **Other**.

#### B. Search Mode

There are 4 search modes, There are 4 search modes, **Auto**, **Manual**, **Advanced** and **SMATV**. The **Auto** mode enables you to search using the information the STB has. On the other hand, you may need to know in advance the frequencies and the symbol rates before using the **Manual** mode. On the **Advanced** mode, enter the Audio PID, Video PID or the PCR PID. The **SMATV** mode is used to special purposes on satellite master antenna TV system.

#### C. Frequency

Select or enter the Transponder's Frequency by using the numeric buttons on your RCU.

#### D. Symbol Rate

Enter the Transponder's Symbol Rate by using the numeric buttons on your RCU.

#### E. Polarization

Choose the type of polarization, either the **Horizontal** or the **Vertical**.

#### F. Network Search

## MENU OPERATIONS

This **Network Search** item can be used if the **Search mode** is set to **Manual** or **Auto**. If the **Network Search** item is set to **On** and the NIT (Network Information Table) is available, the Transponder's information can be found.

### G. PID

This item is valid when the Search Mode is set to **Advanced** only.

Press  button to enter Video, Audio and PCR PID's.

#### 1) Video PID

Insert the Video PID by using the numeric buttons on your RCU.

#### 2) Audio PID

Insert the Audio PID by using the numeric buttons on your RCU.

#### 3) PCR PID

Insert the PCR PID by using the numeric buttons on your RCU.

#### 4) SAVE



To ensure the above Video, Audio and PCR PID change, press  button at this item.

### H. FTA/Scrambled

Choose your favorable services you want to search among **FTA only**, **CAS only** and **FTA+CAS**.

### I. Start Search...

To start the searching process, press  button at this item.

To stop the searching process on the way, press either the  button or the  button. This menu will be shown as long as the STB is searching for services. All services found will be listed in two columns on the screen with TV services in one column and Radio services in the other. Please note that the search procedure may take a few minutes.

When the search procedure is completed, the screen will show how many TV and Radio services have been found. Press  button to save the services.

### J. LNB Setting

To go to **LNB Setting** menu directly from **Service Search** menu, press  button at this item.

## MENU OPERATIONS

### Motorized DiSEqC 1.2

Motorized DiSEqC1.2	
Satellite Name	Asiasat2(C)
Frequency	3640 / 27850 / H
LNB Setting	
Motorized DiSEqC1.2	Disable
DiSEqC Command Mode	User
Movement	0(Stop)
Motor Control	Goto
Service Search	

00% Level  
00% Quality

Select the satellite name of the dish.  
Press OK to see the list.  
↓ Move Item, OK Selects Item, MENU Previous Menu

If you have DiSEqC 1.2 motorized system, then you can use the DiSEqC 1.2 functions.

#### A. Satellite Name

Select a satellite name that will be used to identify a motor position.

#### B. Frequency

Select the transponder to catch the strong signal. Select the TP from TP list box to get the strong signal.

#### C. LNB Setting

Please refer to **LNB setting** of this chapter.

#### D. Motorized DiSEqC1.2

Select **Enable** or **Disable**. If you are using DiSEqC1.2 antenna, set to **Enable**.

#### E. DiSEqC Command Mode

Change the current mode between **User** and **Installer** modes.

-**User**: This mode is used to fine-tune the position of the motor for better reception.

-**Installer**: This mode is used to search for the position of a satellite manually.

**F. Movement**: In case of **User** mode, the movement is adjustable by fine-tuning.

In case of **Installer** mode, the movement is adjustable by **East**, **West** going command.

## MENU OPERATIONS

### G . Motor Control

- **Goto** : Move the motor to the stored position of the selected satellite.
- **Store** : Store the current position of the motor for the selected satellite.
- \* **The followings are available only at the Installer mode.**
- **Recalculate** : Recalculate the position of the Stab Rotor motor.
- **Goto Ref** : Go to reference.
- **Limit E , Limit W** : Set the limits of East and West position.
- **Limit Off** : Remove the limitation.
- **Reset** : Reset all the stored position of the motor relative to the "0" position

### H . Service Search

After saving the DiSEqC configuration at the highest signal quality, press  button to start service searching of the selected satellite.

### USALS Setting

USALS is very convenient motorized DiSEqC system that supports DiSEqC 1.3 command and also can get the satellite position automatically if you know your geographical location. Basically, the listed satellites have its Longitude and therefore the angle of the satellite can be calculated without problem.

If you have USALS motorized system, then you can use the USALS as followings.

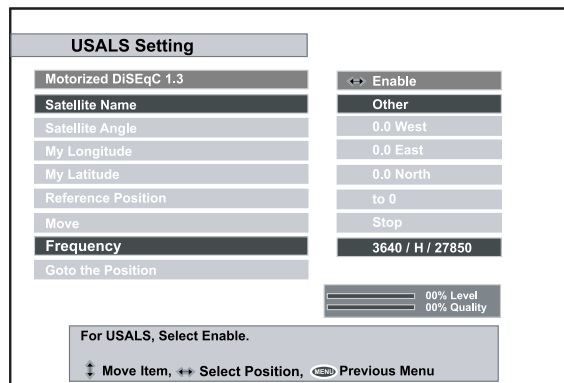

USALS Setting	
Motorized DiSEqC 1.3	Enable
Satellite Name	Other
Satellite Angle	0.0 West
My Longitude	0.0 East
My Latitude	0.0 North
Reference Position	to 0
Move	Stop
Frequency	3640 / H / 27850
Goto the Position	
	00% Level
	00% Quality

For USALS, Select Enable.

Move Item, Select Position, Previous Menu

## MENU OPERATIONS



### A. Motorized DiSEqC1.3

Select **Enable** or **Disable**. If you are using DiSEqC1.3 switch, set to **Enable**.



### B. Satellite Name

Select a satellite that will be used to identify a motor system.



### C. Satellite Angle

It is the longitude of the selected satellite and it can be set automatically in case of selecting a satellite name. You can use numeric keys of RCU to enter the angle. **East** or **West** will be selected by  ,  button.

### D. My Longitude



It means the longitude of your location. You can select the angle, East and West by  ,  or numeric button.

### E. My Latitude

It means the latitude of your location. You can select the angle, **South** or **North** by  ,  or numeric button.

### F. Reference Position

Go to Reference position ( $0^\circ$ )

**G. Move** : After searching the position you want by **Goto the position** item, you can tune the antenna to go to the exact position by this item.  ,  button moves the antenna to anti-clockwise and clockwise respectively.

**H. Frequency** : Selects the Transponder to catch the strong signal.

### I. Goto the position

After setting the **Longitude**, **Latitude** and the longitude of the selected satellite, this menu is used when you want to move the desired direction (position) of the dish saved before. Its moving limit is  $\pm 65^\circ$ .

## MENU OPERATIONS





### SAT/TP Edit

The screenshot shows the 'SAT/TP Edit' menu with the following fields and values:





Satellite Name	Asiasat2(C)
Frequency	3640 MHz
Symbol Rate	27850 KS/s
Polarization	Horizontal
SAT Name Edit	
Add new TP	
Delete TP	
Add Satellite	
Delete Satellite	
Service Search	00% Level 00% Quality

Select the satellite name of the dish.  
Press OK to see the list.  
↓ Moves Item, ↑ Selects Item, ← Previous Menu

#### A. Satellite Name

By pressing  button, you can see the listed satellite names. Then, using  ,  or  or  buttons, you can select satellite.

#### B. Frequency

By pressing  button, you can see the all frequencies of transponders of a satellite and can select a frequency. Or, by pressing  ,  ,  or  buttons, you can select and view a frequency one by one.

#### C. Symbol Rate

You can see the symbol rate of specified satellite on the right side of the menu.





#### D. Polarization

You can select the polarization from **Horizontal** and **Vertical** modes.

#### E. SAT Name Edit

You can change the name of the satellite name by this menu.

Press  button to display a keyboard. There are several items such as **Other**, **Save** and **Space** in the keyboard. By selecting **Other** item, you can see a new alphabet character sets. The **Space** item make a space between two characters. And the **Save** item is used to confirm the new name of the satellite.

**Notes:** You can move the cursor in the keyboard row by  or  or and column by  or  , button.

## MENU OPERATIONS

### F. Add New TP

In case of new transponder information is added by broadcaster, you can add new TP(transponder) information and enjoy new services.

Before adding new TP information, you should know the frequency, symbol rate and polarization types.

After adding new information, you should confirm the new information by pressing  button at **OK** item.

### G. Delete TP

By selecting this item, you can delete the selected TP(Transponder) information.

### H. Add Satellite

Using this menu, you can add new satellite name by keyboard, then it will be added in the Satellite Name menu.

### I. Delete Satellite

By selecting this item, you can delete the selected satellite information.

### J. Service Search

It is used to go to Channel Search menu directly from SAT/TP Edit menu.

## Factory Setting

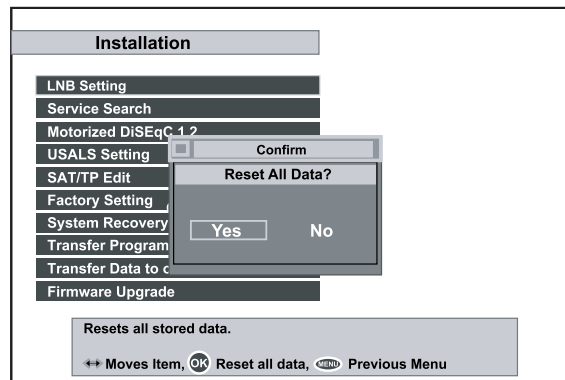

All the stored data can be reset just like it was manufactured. The factory setting has two steps. The first is to reset the service data and other system configurations except

---

## MENU OPERATIONS

---

Motorized DiSEqC1.2 setting. The second is to reset the parameters of Motorized DiSEqC 1.2.

### **System Recovery**

All the data and system setting can be stored and restored.

#### **Recover**

It recovers all the stored data and system setting. The factory default setting will be reloaded unless the installer stores the data and system setting by **Store** function.

#### **Store**

It stores all the data and system setting as current setting. The stored data and setting will be restored by **Recover** function.

It is permitted only to the installers. The PIN code is different from that of users.

### **Transfer Program to Other IRD**

It is used to transfer STB firmware to other STB for upgrading the STB.

**Notes: Please proceed this menu with connecting the STB of same model and same specification.**

### **Transfer Data to Other IRD**

It is used to transfer STB Data such as service information to other STB for upgrading the STB.

**Notes: Please proceed this menu with connecting the STB of same model and same specification.**



## MENU OPERATIONS

### Firmware Upgrade

The screenshot shows a menu titled "Firmware Upgrade". It contains the following fields and values:

Satellite Name	Asiasat2(C)
Frequency	3640 MHz
Symbol Rate	27850 KS/s
Polarization	Horizontal
PID	347
Start	

Below the fields is a progress bar showing "00% Level" and "00% Quality". At the bottom, there is a text box that says "Select the Satellite name for OTA" and a legend: "↑ Moves Item, ++ Selects Item, [OK] Previous Menu".

At this menu, you can download the latest STB software from Satellite.  
The TP details are as follows.

#### Astra

FREQUENCY : 12603 MHz  
S / R : 22000 KS/s  
Polarity : Horizontal  
PID : 347

#### Hotbird 4

FREQUENCY : 12673 MHz  
S / R : 27500 KS/s  
Polarity : Vertical  
PID : 730

For OTA (Over - The - Air Upgrade), it takes around several minutes to download software from the Satellite.

To start OTA, press  button at **Start** item.

For better service, the satellite and TP can be added or changed. You can get the information at [www.topfield.co.kr](http://www.topfield.co.kr).

## MENU OPERATIONS

### Information

You can check the IRD(STB) version and refer the calendar.

#### IRD Status

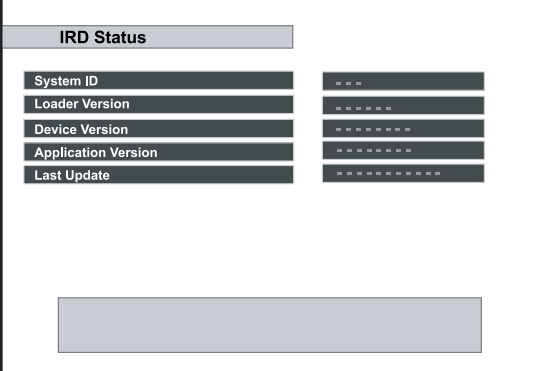





The screenshot shows a menu titled "IRD Status" with the following information:

System ID	==
Loader Version	=====
Device Version	=====
Application Version	=====
Last Update	=====

Check the STB's system information here. It shows the System ID, Loader Version, Device Version, Application Version and Last Update.

#### Calendar

Press  or  button to select the year. Press  or  button to select the month.



The screenshot shows a menu titled "Calendar" with a calendar for 2000 October. The calendar is displayed as follows:

2000 October						
Sun	Mon	Tue	Wed	Thu	Fri	Sat
1	2	3	4	5	6	7
8	9	10	11	12	13	14
15	16	17	18	19	20	21
22	23	24	25	26	27	28
29	30	31				

Below the calendar, there is a legend:

- P-/P+ : Next / Previous month
- V+/V- : Next / Previous year.

## MENU OPERATIONS

### Game

ExBlock



Bomb Hexa

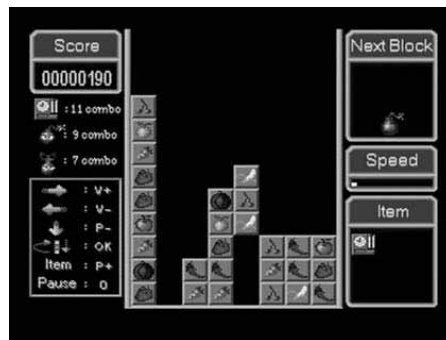

Pac Man

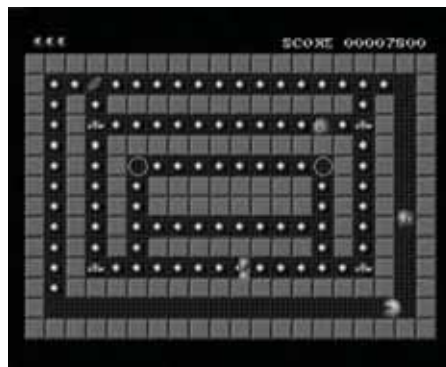



## FUNCTION GUIDE

## FUNCTION GUIDE

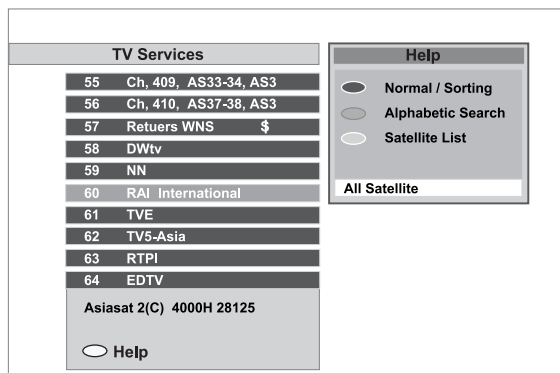
### Service List



Press  button to see the Service List and **Help** window will be displayed. Select one of the services you want to enjoy.

By pressing  button instead of  button, satellite selection window will appear. You can select a satellite there.

Sorting, alphabetic search and selecting a channel by satellite is possible.

### Information Box

Press  button on the RCU to see the program information. The Information box displays as follows:

- . Service Number
- . Service Name
- . Detailed Program Information
- . Signal Level and Quality
- . Satellite Information

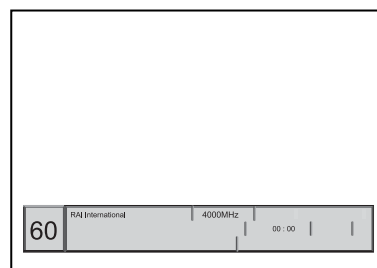







## FUNCTION GUIDE

- . Information of subtitle and / or teletext
- . Parental Lock

You can hide the Information Box by pressing  button.

Service Number	Service Name	Freq	Signal Strength	
	Event Name	Time Information	CAS, Subtitle, Teletext	Parental Lock Mark
	Event Description	Start Time ~ End Time / Dolby / Multifeed		



You can see the Current/Next event by pressing  /  button in the information box. To control the volume in the information box, you have to press  /  button two times without interval.



If EPG is available on programs, by using  ,  buttons, you can see the EPG. You can see extended information of the event by pressing  button once more.

## EPG (Electronic Program Guide)

To display the information about currently being broadcasted as well as those that will be broadcasted next, press  button on the remote control unit.

If EPG is available on programs, you will see the detailed description of the programs, start/end time and programs schedules etc.

 ,  buttons will be used to move program and to see next program schedules.

 ,  buttons will be used to switch the service.

 button makes the reservation for the next program.

 button shows extended information of the event.

 button will change the contents of EPG between TV and Radio services.

 (Red) button switches the EPG from Single Service to Multi Service and in opposition.

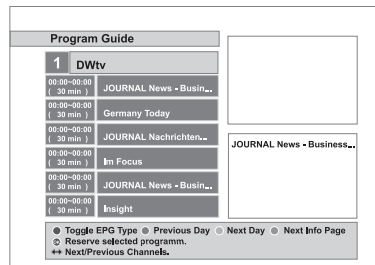

## FUNCTION GUIDE

### Subtitle

You can choose a language of subtitle using  button on the RCU.



If the broadcaster provides subtitles, you can see  symbol in the Information Box.

### Teletext

If the broadcaster supports teletext, you can see  symbol in the Information Box. There are VBI insertion mode and software emulation mode in teletext. In the VBI insertion mode, which is always on, you can watch the teletext with your TV using the RCU of your TV. To watch teletext with VBI insertion, your TV must support teletext.



In the software emulation mode, you can watch the teletext even though your TV does not support teletext. You can watch the teletext using the RCU of STB.

Press **Teletext** () button to watch the teletext with software emulation mode.

Press  button once more or **EXIT** () button to escape from teletext.

### Sound Track

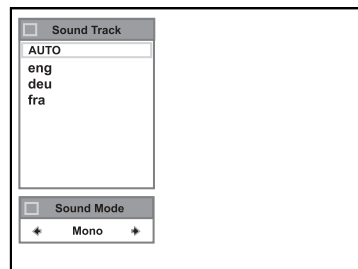

You can choose a language of soundtrack by pressing  button when a broadcaster supports various languages of soundtrack.

Also, it is possible to choose a mode among Stereo, Mono, Left and Right using ,  buttons.  button is used for multifeed function, too. If the multifeed is available in current service,



Multifeed Track will be displayed first. You can change the display to Sound Track selection menu by pressing  button once more.

### Multifeed

If multifeed is available in the service, Multifeed Icon () will appear at the right side of the Information box. If available, the Multifeed Track and Sound Track are toggled by  button. It is possible to choose one of the multifeed services.

SOFTWARE UPGRADE AND PC INTERFACE

### Software Upgrade

The STB has stable and convenience software to use. But, to improve the STB the new software of the STB may be released.

Whenever a problem is found or functions are added or modified, the software in the STB has to be upgraded to enjoy better function.

The latest news, software, utility, driver, product and manual will be found at Topfield website <http://www.topfield.co.kr>.

There are some methods to download the new software.

The configuration of the RS232 cable is as follows.

PC pin 2 <-> STB pin3

PC pin 3 <-> STB pin2

PC pin 5 <-> STB pin5

The other pins do not need care.

(a) STB to STB download via RS232C

It is possible to download the firmware or service data from STB to another STB.

(b) PC to STB download via RS232C

You need the **TFD-down.exe** to download the software.

To start download, start download at PC and turn on the STB.

(c) OTA

You can download the latest STB software from Satellite by OTA.

The satellite and TP can be added or changed. You can get the information at [www.topfield.co.kr](http://www.topfield.co.kr).

For more information, refer to the **transfer firmware** chapter of **Menu Operations**.

## MENU MAP

### MENU MAP

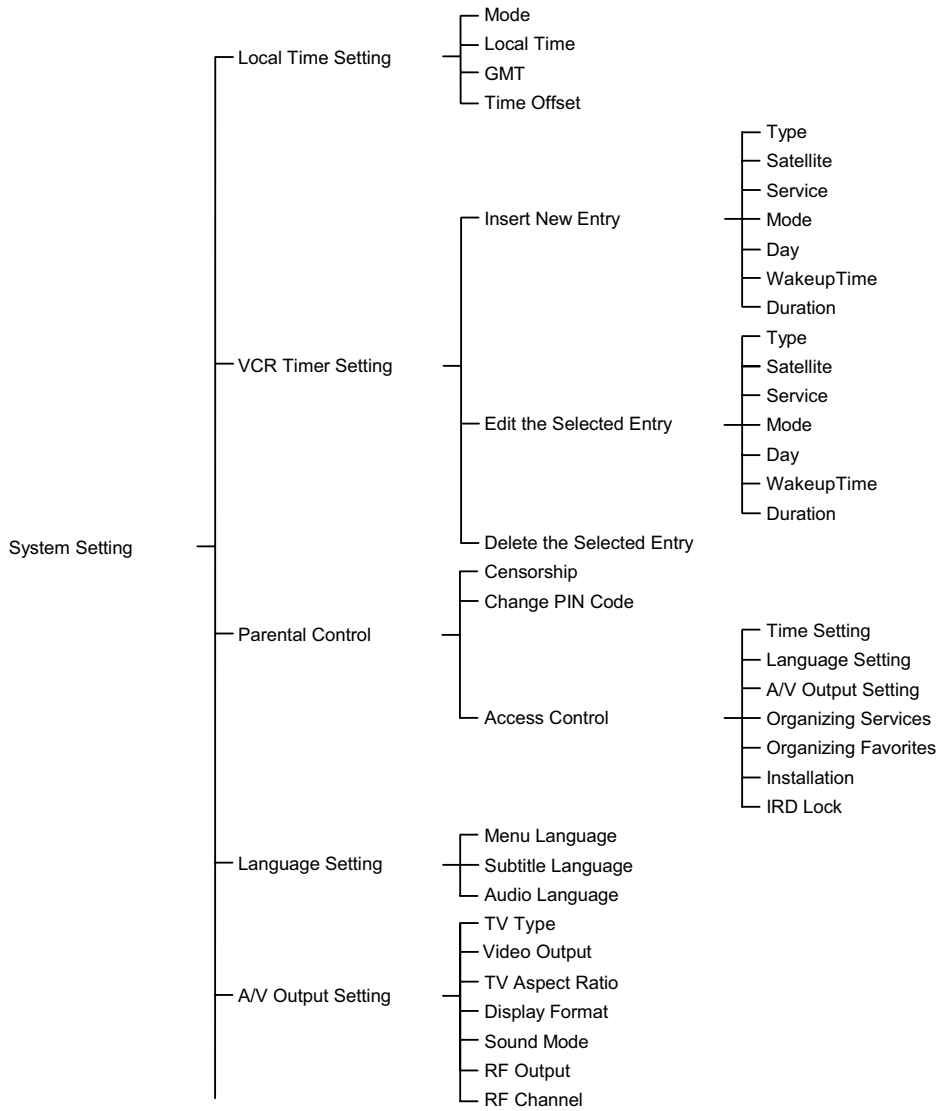



## MENU MAP

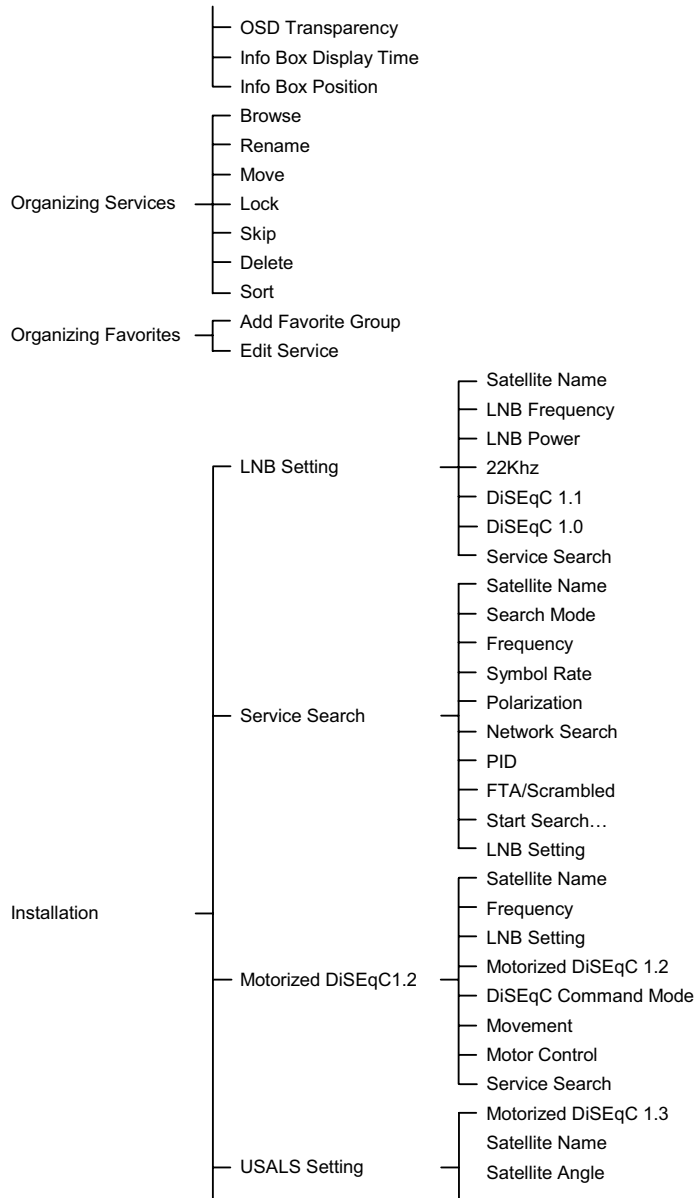

## MENU MAP

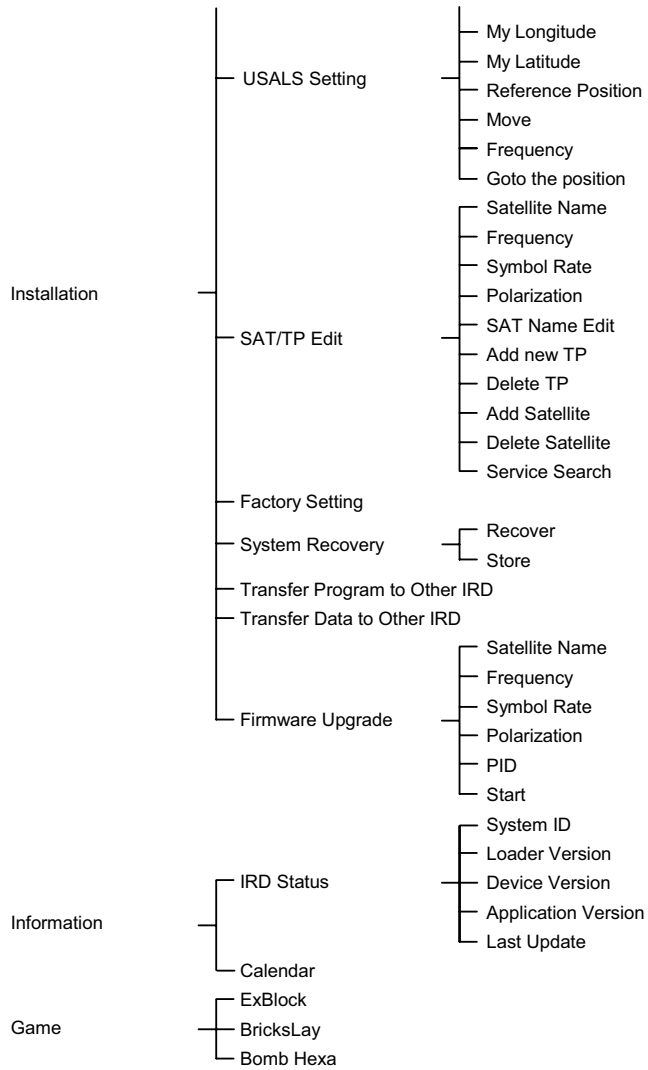

## SPECIFICATIONS

### SPECIFICATIONS

<b>Tuner &amp; Channel Decoder</b>	
Input/Loop through Connector	F-type, IEC 169-24, Female
Frequency Range	950 ~ 2150MHz
Signal Level Input	-65 ~ -25dBm
LNB Power & Polarization	Vertical : +13.5VDC Horizontal : +18VDC Current : Max. 500mA with Overload Protection
22KHz Tone	Frequency : 22±1KHz Amplitude : 0.65±0.2V
DiSEqC Control	Version 1.0/1.1/1.2/1.3 Compatible
Demodulation	QPSK
Input Symbol Rate	1~45 Msps
Code Rate	1/2, 2/3, 3/4, 5/6 and 7/8
<b>MPEG Transport Stream A/V Decoding</b>	
Transport Stream	ISO/IEC 13818-1 MPEG-2 Transport stream Specification
Profile Level	MPEG-2 MP@ML
Aspect Ratio	4:3, 16:9, Pan & scan, Letterbox
Video Resolution	720 x 576
Audio Decoding	MPEG-1 Layer 1 & 2
<b>Main System</b>	
Main Processor	Power PC
<b>A/V &amp; Data In/Out</b>	
RCA A/V	Video CVBS output Audio L/R output
SCART	Video CVBS/S-VIDEO/RGB/YUV output Audio L/R output
RS-232C	9 pin D-sub type Transfer rate : max. 115.2Kbps
<b>RF-Modulator</b>	
RF-Connector	75Ω, IEC 169-2, Female/Male
Frequency	470 ~ 860MHz(PAL) / 470 ~ 890MHz(NTSC)
Output Service	CH21 ~ 69(PAL) / CH3,4,14 ~ 83(NTSC)
TV standard	PAL G/I/K/NTSC-M selectable by Menu

## SPECIFICATIONS

Power Supply	
Input Voltage	90 ~ 250VAC, 50/60Hz
Type	SMPS
Power Consumption	Running: Max. 24W, Standby: 9W
Protection	Separate internal fuse. The input shall have lightning protection.
Physical Specification ( 340mm Model )	
Size(W x H x D)	340 x 60 x 265 mm
Weight(Net)	3.0Kg
Physical Specification ( 260mm Model )	
Size(W x H x D)	260 x 54 x 185 mm
Weight(Net)	1.8Kg

- \* **Specifications and functions may be changed for improvement without notice in advance.**

**[www.i-topfield.com](http://www.i-topfield.com)**

110T-F45B3-201-0  
rev.2

## Free Manuals Download Website

<http://myh66.com>

<http://usermanuals.us>

<http://www.somanuals.com>

<http://www.4manuals.cc>

<http://www.manual-lib.com>

<http://www.404manual.com>

<http://www.luxmanual.com>

<http://aubethermostatmanual.com>

Golf course search by state

<http://golfingnear.com>

Email search by domain

<http://emailbydomain.com>

Auto manuals search

<http://auto.somanuals.com>

TV manuals search

<http://tv.somanuals.com>