



University

Reel Mower Basics

PART NO. 09168SL

This page is intentionally blank.

Table of Contents

Historical Background..... 2

Application..... 6

Theory 8

Importance of the Operator 18

Preventive Maintenance 19

Set-up and Adjustments 21

Quality of Cut and Aftercut Appearance 30

Sharpening 34

Bedknives, Rollers and Accessories..... 47

Groomers and Thatchers..... 52

Historical Background



The concept of the reel mower goes back to the 1800's. It evolved out of a need for groomed turf areas being maintained on a regular basis.



The first reel type fairway gang mowers were horse drawn.

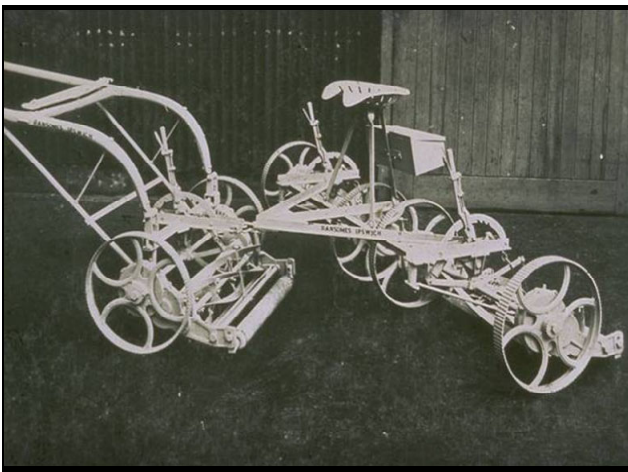

Here is an example of a horse drawn three gang fairway mower.

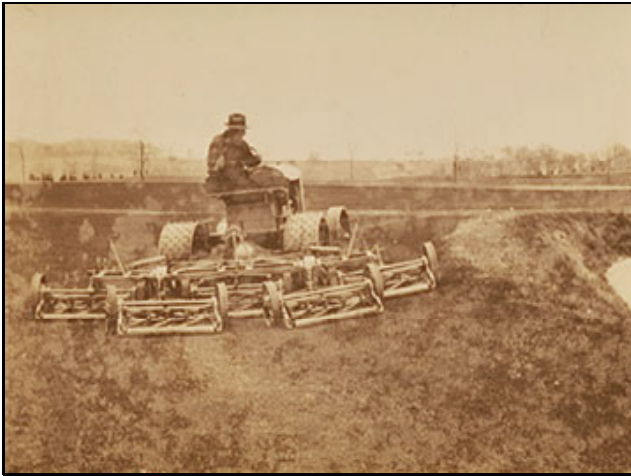

The first tractor drawn gang mower. (Toro "Bull" Tractor in 1926).

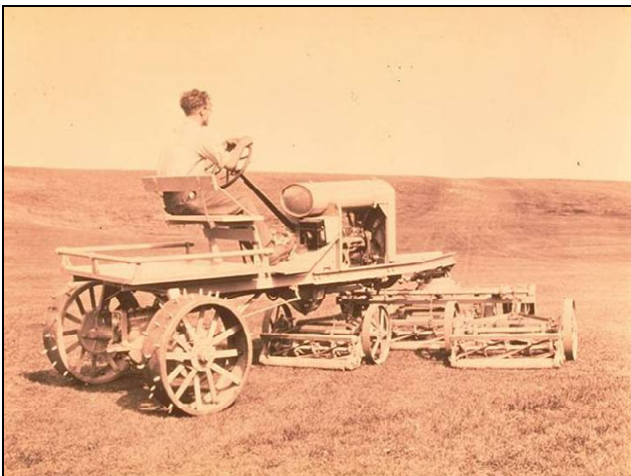

Golf course development during the 1920's and 30's brought about design improvements in engines and mower drive systems.

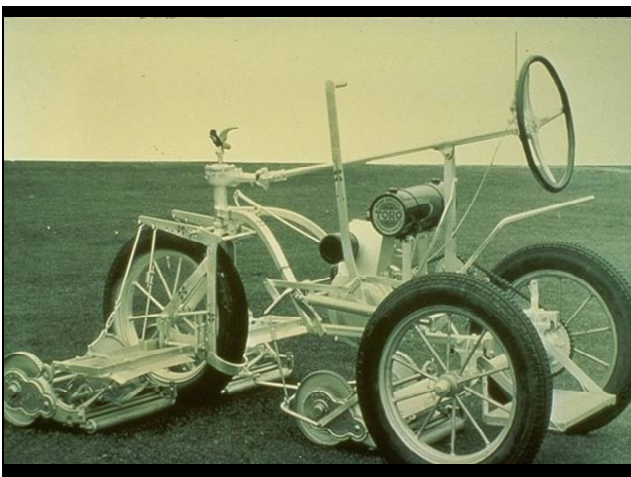

These improvements continued, allowing for lighter weight and easier to use equipment.



Productivity and quality of cut improved.



The development of hydraulics during the 50's and 60's improved the reliability, safety, operator comfort and lowered maintenance costs.



With the introduction of the riding greens mower, the industry reached new heights in the areas of productivity and efficiency.



The introduction of hydraulically driven cutting units greatly reduced wheel slippage and the resulting turf stress.

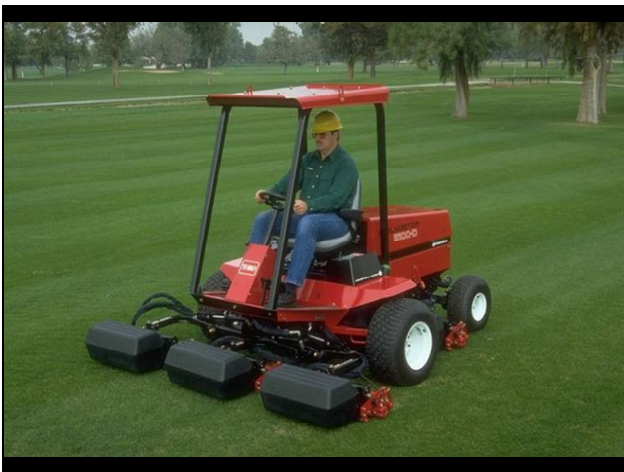

Although dramatic improvements have been made in reel type mowers, some of the same frustrations that developed working with reel cutting units years ago are still present today.

Application



When properly maintained and operated, reel mowers provide superior quality of cut and aftercut appearance. These mowers are typically dedicated to mowing formal turf areas at low heights of cut. A triplex riding greens mower is shown here; a Toro Greensmaster 3150 with DPA (Dual Precision Adjust) cutting units.

Applications



Average Height of Cut:
1/16 in. – 1/4 in.
(2.5 mm – 5 mm)
Mowing Frequency:
Daily



Greensmaster

Golf course greens are intensely managed, and mowed every day, at heights of cut from 1/16 in. – 1/4 in. (2.5 mm – 5 mm).



Average Height of Cut:
3/8 in. – 1/2 in.
(9 mm – 12 mm)
Mowing Frequency:
Three times per week



Reelmaster



Greensmaster

Tees are typically mowed three times per week, at heights of cut from 3/8 in. – 1/2 in. (9 mm – 12 mm).



Average Height of Cut:
3/8 in. – 3/4 in.
(9 mm – 19 mm)
Mowing Frequency:
Three times per week
to daily





Reelmaster

Fairways are typically mowed three times per week, at heights of cut, from 3/8 in. – 3/4 in. (9 mm – 19 mm). Other areas, such as intermediate / semi-roughs and surrounds may also be maintained with reel mowers.

Other Applications

- Sports fields
- Other finely manicured turf areas



Reelmaster Greensmaster

Reel mowers are also utilized, for mowing elite sports fields and other finely manicured turf areas.

Theory

This section will describe the construction, and cutting action of a reel mower cutting unit.

If reel mowers' unique characteristics are not understood and responded to, the end result will be a poor quality of cut, and expensive down time and repairs.

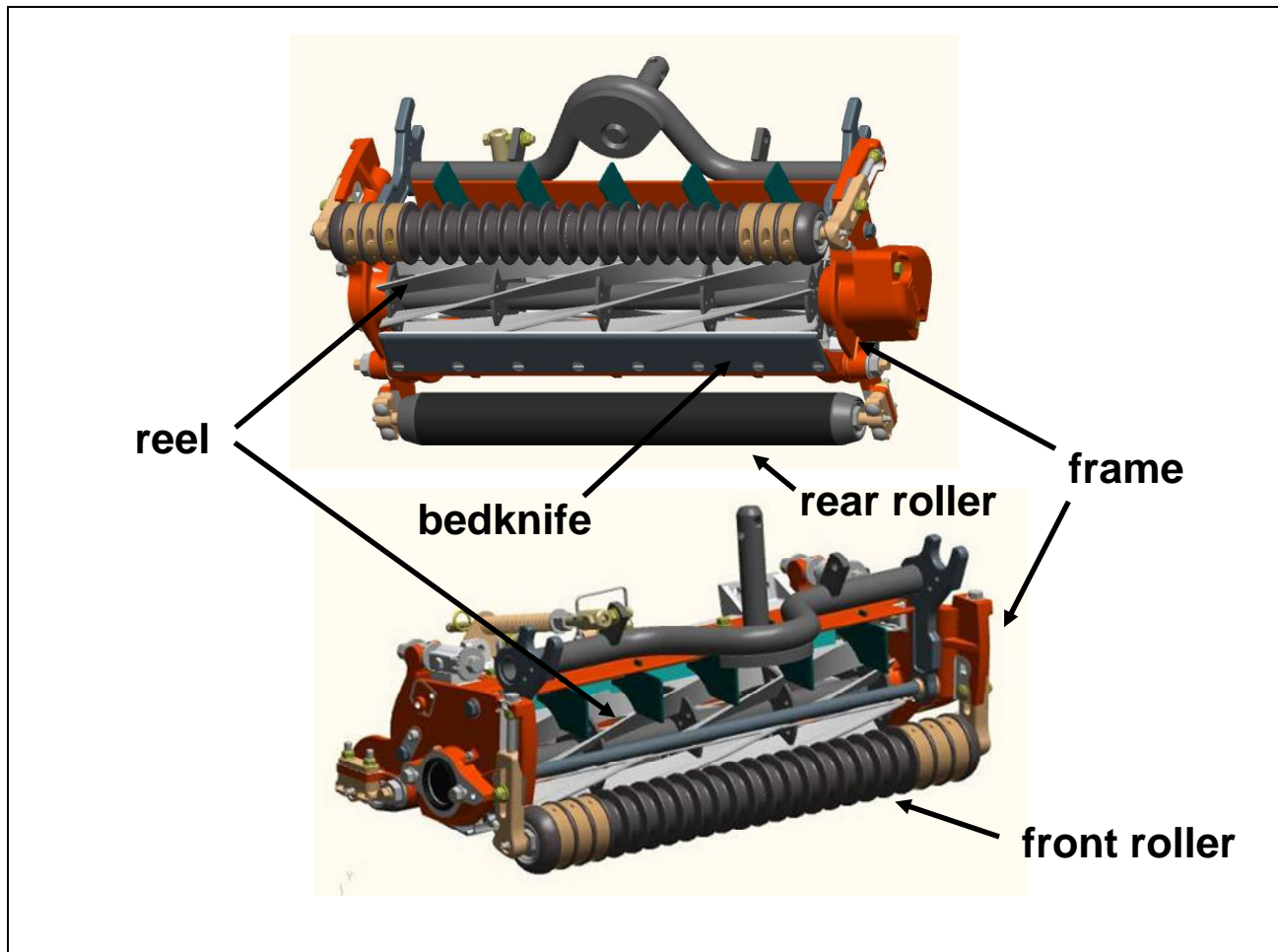

There are three main structural members in a reel cutting unit:

The REEL, consists of several helix shaped blades, mounted to a rotating shaft.

The BEDKNIFE, is attached to the bedbar and the assembly is mounted to the main frame in a manner that allows for paralleling and adjustment to the reel.

The FRAME, supports the rollers, the bedbar assembly and reel with its drive mechanism, which can be hydraulic, belt driven, or ground driven.

A reel mower cuts grass with a scissors-like shearing action, as the moving helix shaped blades pass over the stationary bedknife. The cutting action requires that the bedknife and reel blades, be sharp, matched, and in close relationship with each other.

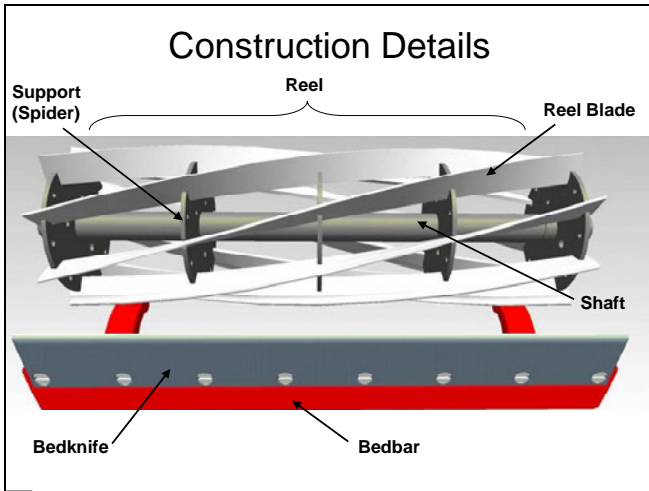

The reel consists of a number of helix shaped blades, welded to supports and mounted to a shaft. This weldment is then ground to be a perfect cylinder.

The reel is rotated by a drive system, usually a hydraulic motor.

Below the reel is the bedbar assembly. The bedknife is held rigidly in position on the bedbar by screws.

The bedknife is sharpened to be flat and square so the sharp edge contacts the reel blades across their entire length.

If the bedknife is not flat, or the reel is not a perfect cylinder, it is impossible to get the bedknife to contact along the entire length of the reel.

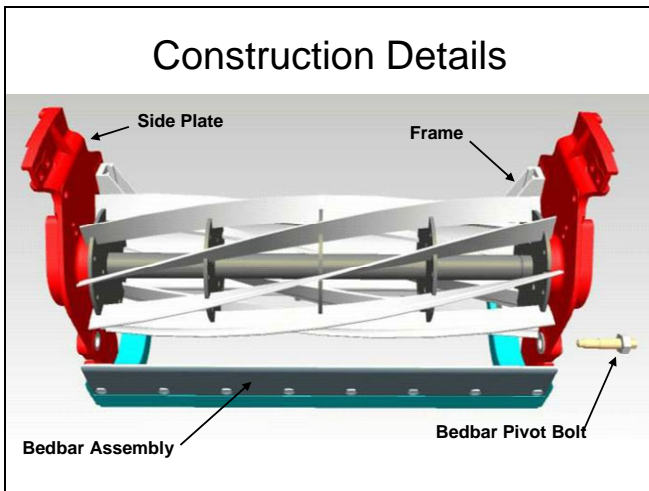

The reel is supported by precision bearings held within the side plates.

The side plates are held in place by a frame.

This becomes the reel assembly, and is a precision cutting tool.

The reel assembly is supported by rollers, and pulled along the ground by a carrier frame.

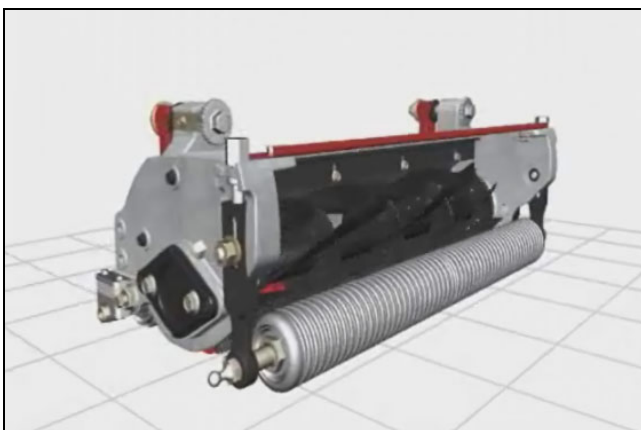

Everything comes together, to make a precision cutting tool.

Terminology

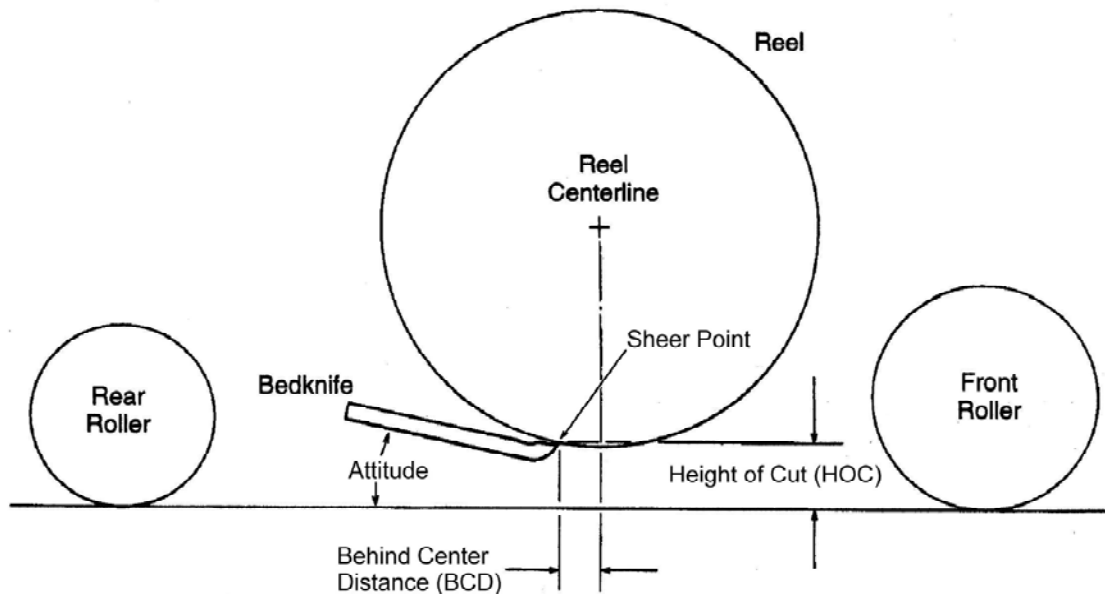

This drawing depicts the common terms used when referring to a reel mower.

We have already discussed the reel, and the bedknife.

The attitude, refers to the angle of the bedknife. This reference is in degree differential from the surface of the turf, (or the line intersecting the bottom of the rollers).

The shear point, is the point that a reel blade contacts any given point on the bedknife at a specific point in time.

The reel centerline, is the imaginary line drawn perpendicular to the turf dissecting the reel at its center.

This line is used to find the Behind Center Distance (BCD), this is the distance the shear point lies behind the centerline.

There are two rollers. The rear roller trails the cutting unit, and is usually a solid roller. The front roller leads the cutting unit, and due to the forces working on it may be any one of many types. The different types of rollers will be discussed later in the program.

The Height of Cut (HOC) defines the distance between the roller plane and the shear point. Some cutting units have a fixed front roller, and the rear roller is used to set the height of cut. Others, such as the newer DPA design cutting units, have a fixed rear roller, and the front roller is used to set the height of cut.

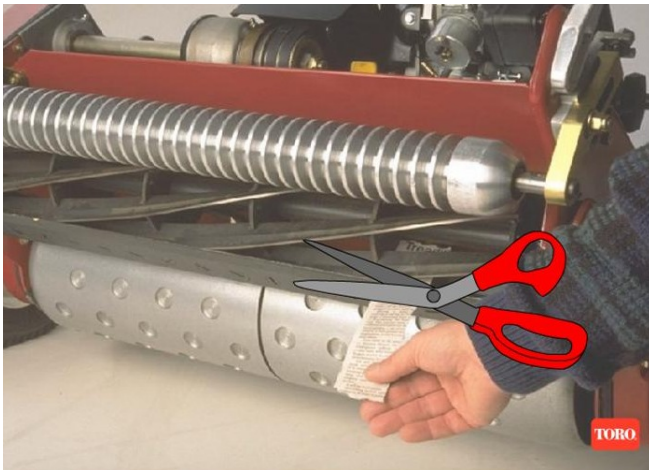

Think of the reel mower cutting action like a scissors; two blades coming together, with light contact, to cut the grass. Without sharp reel and bedknife edges and properly maintained, light contact, the reel mower will not cut the grass and give a good quality of cut.

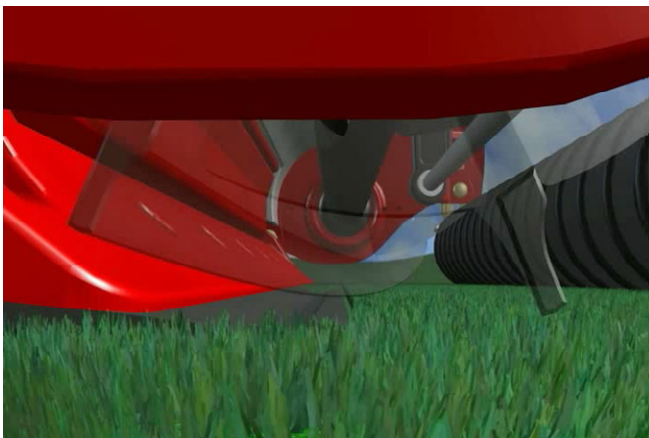

This illustrates the scissors-like cutting action, as viewed, from turf level, below the cutting unit. Note how the helix shaped reel blades, move across the bedknife, to cut the grass.

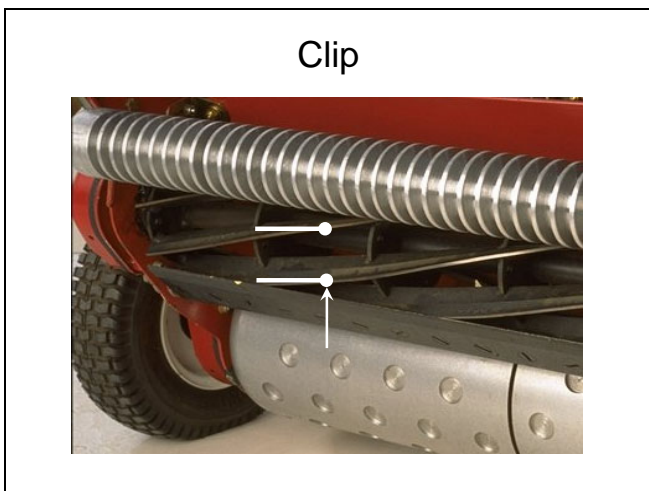

To understand reel cutting theory, you must understand the concept of clip and the shear point.

A shear point is any single point of contact made between the reel blade and bedknife.

Here we can see the distance between two successive shear points, one factor that affects the clip rate.

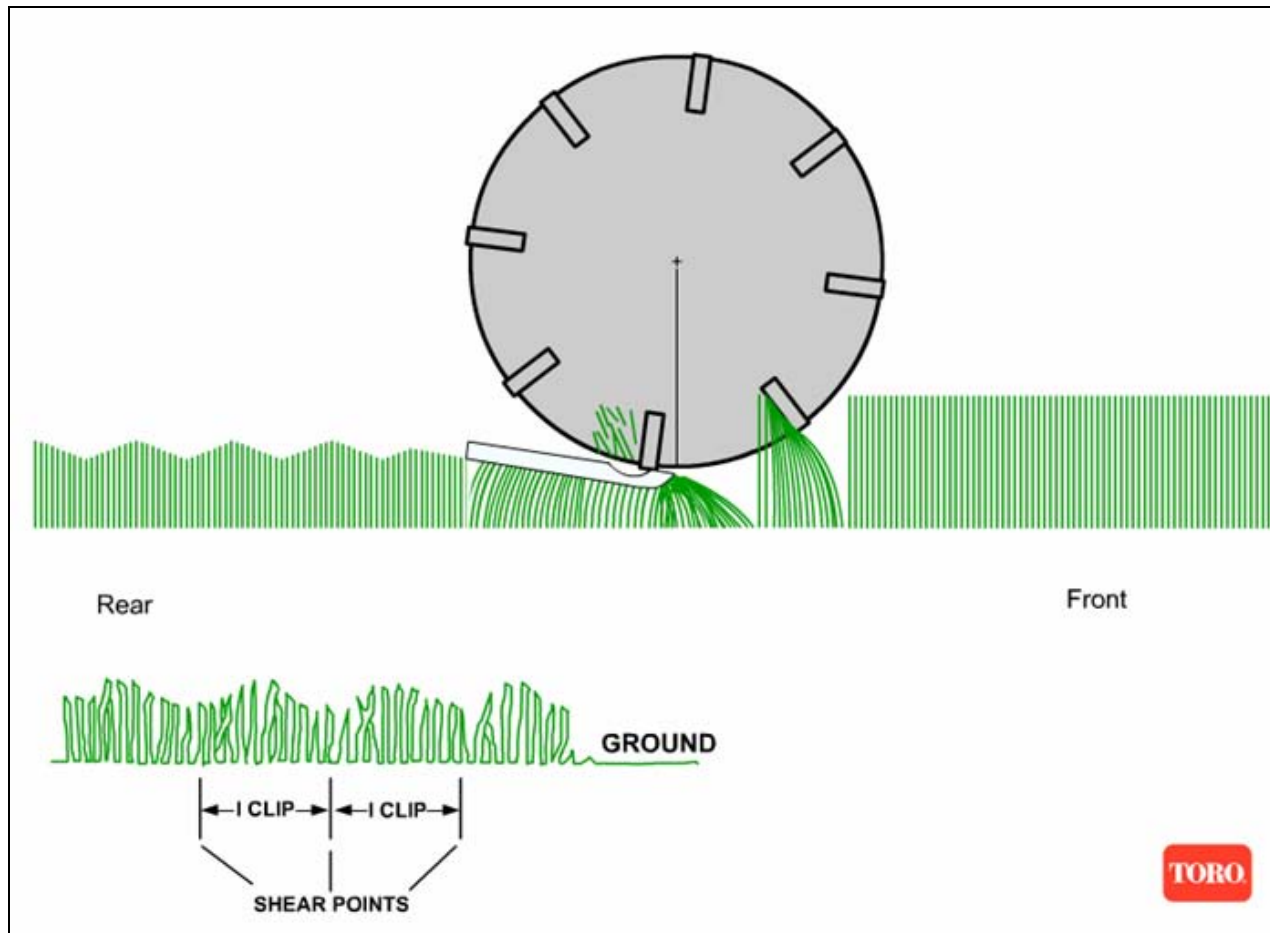

Clip is the forward distance traveled between successive blade contacts at one shear point.

This is viewed as a single contact point on the bedknife.

As the reel travels forward it pushes the grass in front of it, at the same time the reel blade is gathering the grass as it moves toward the bedknife.

The opposing forces working on the grass, bunch the grass together at the shear point creating a triangle.

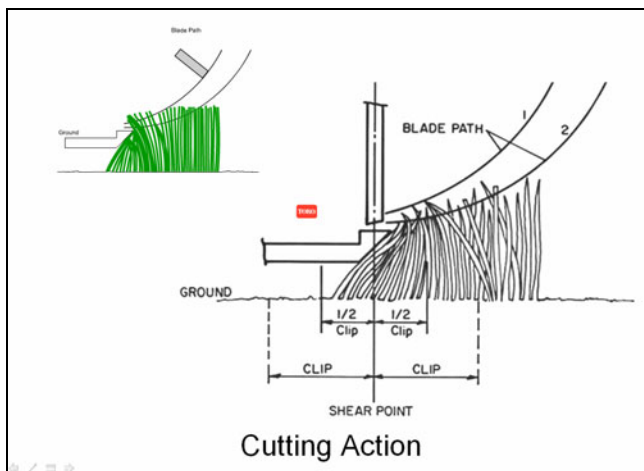

By following the blade path through two "clips" as the machine moves forward we can illustrate the actual process of cutting grass. The bedknife pushes grass toward the shear point, while the reel blade gathers it in front.

Factors that affect the clip rate:

- Diameter of reel
- Number of blades
- Speed of reel
- Ground speed

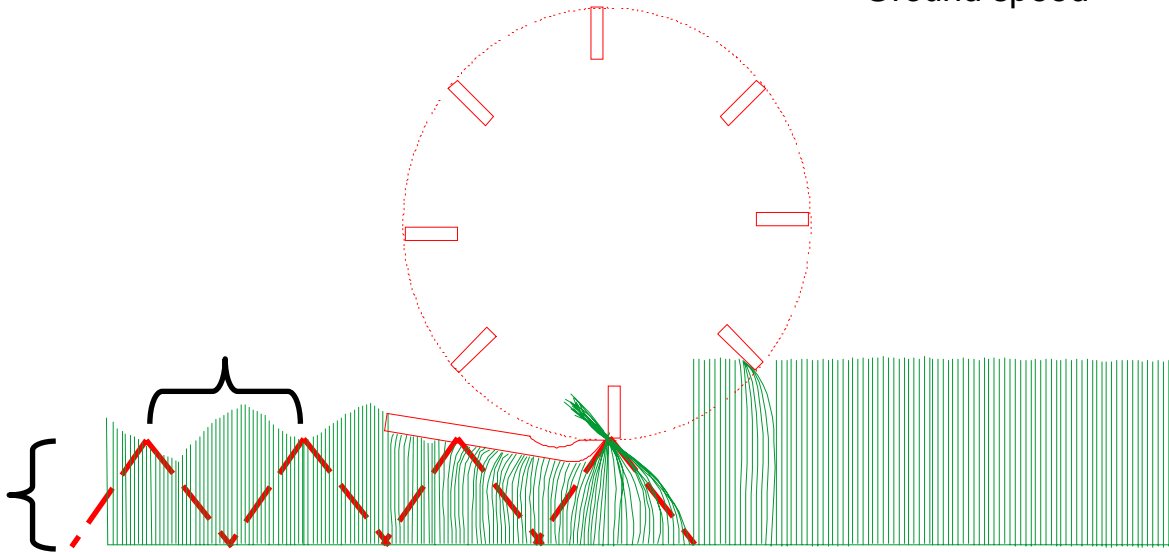

The ideal situation is when $H.O.C. = \text{Clip Rate}$

If we observe multiple clips we get a series of triangles set side by side.

The top of the triangle represents the individual shear point.

The clip rate is therefore, the distance between the tips of the triangles.

The clip rate is critical to the appearance of the cut. Ideally, the clip rate should equal the height of cut.

Factors that affect the Clip Rate are listed in the illustration.

Generally, the lower the height of cut, the more blades are required, or the reel must rotate at a faster speed to keep the clip range in sync. A greens mower cutting unit, for example, may be available with 8, 11, or even 14 blade cutting units.

Most cutting units have a preferred operating range and all cutting units can be adjusted beyond that preferred range. Choose a cutting unit where the intended height of cut is in the middle of the height of cut range

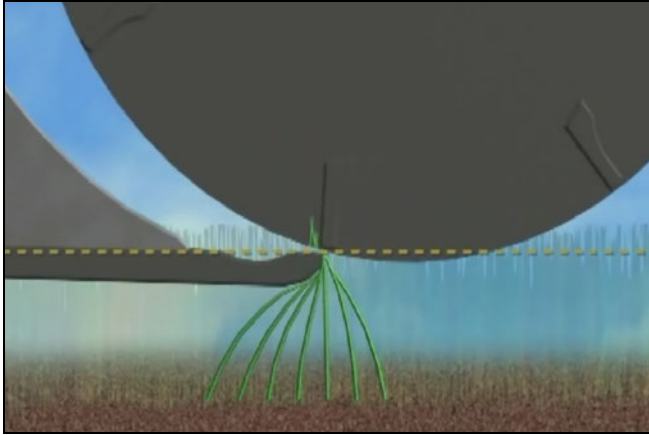

Here is what the mowing action looks like when the clip rate is ideal. The bedknife pushes grass forward, while the reel blade gathers it toward the bedknife. Optimum clip rate is achieved when the bedknife and reel blades create small, even gatherings that are then cut. The result is a small, unnoticeable clip and an even aftercut appearance.

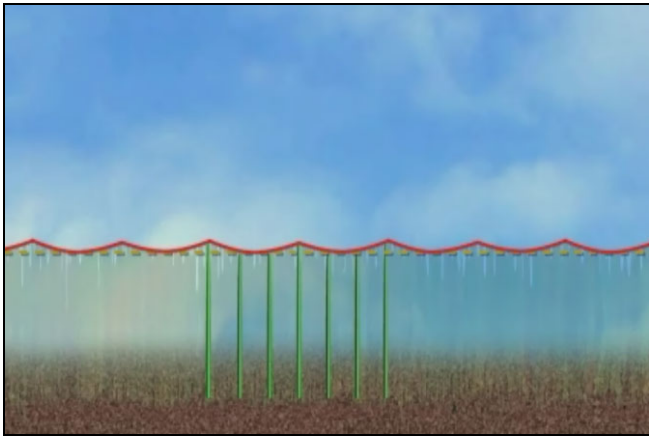

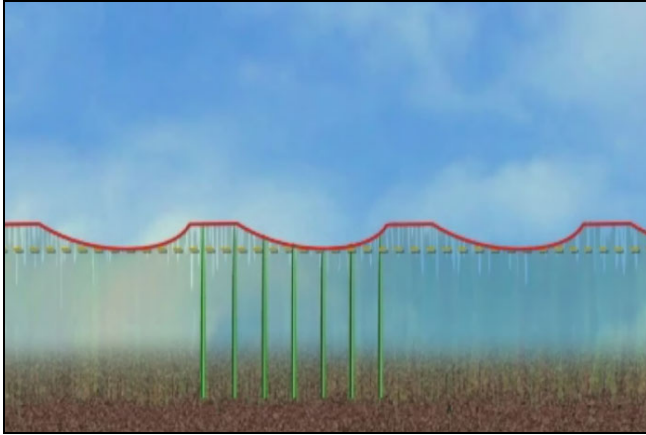

If the reel speed is too slow in relation to the ground speed, there is too much space between cuts, resulting in visible clip marks and uncut grass.



Visible clip marks in the turf are the result of an incorrect clip rate.

NOTE: If you make a large change in height of cut, you may notice some visible clip marks after the first mowing. This will go away after the grass is maintained at this height over a period of time.

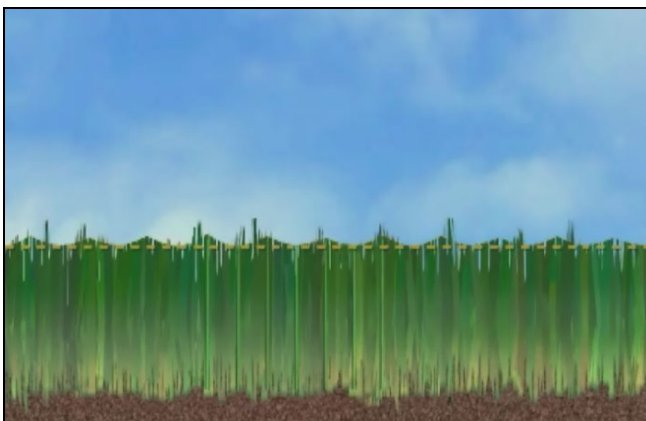

If the reel speed is too fast, in relation to ground speed, the leaves of the grass plants impacted multiple times before being cut. This can cause leaf tissue damage, and is detrimental to the long term health of the turf.

Reel Speed Chart

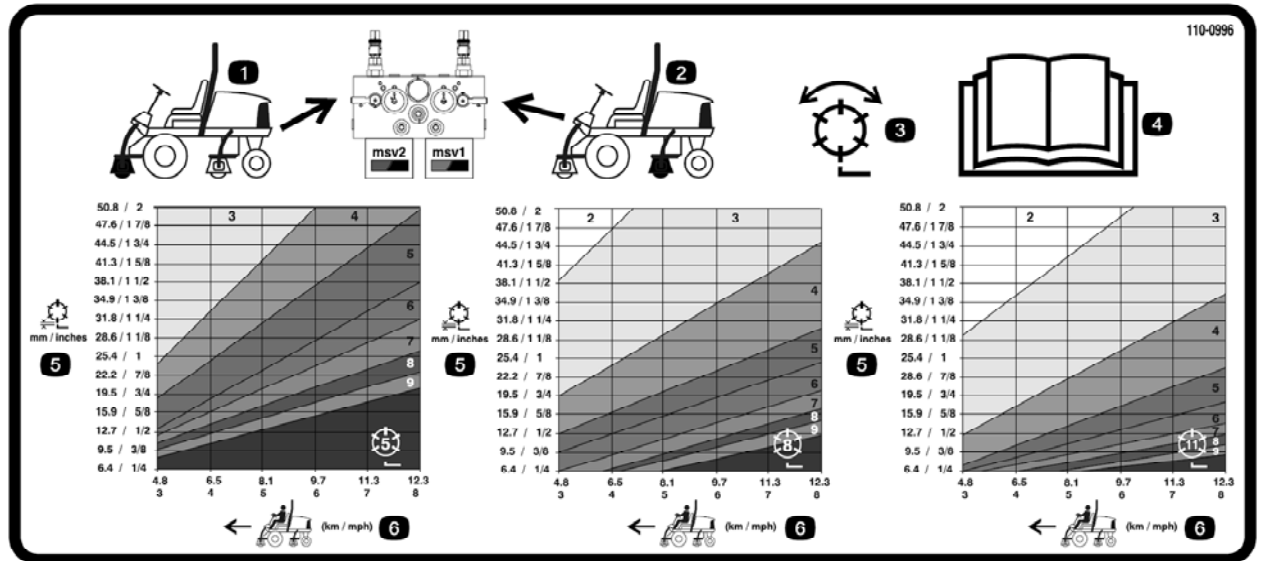

The speed of the reel can be adjusted on some machines. As we have discussed, it is important that the reel speed be matched with the number of reel blades and the forward speed of the tractor.

Factors Affecting Performance

Cross section of turf cut at various heights

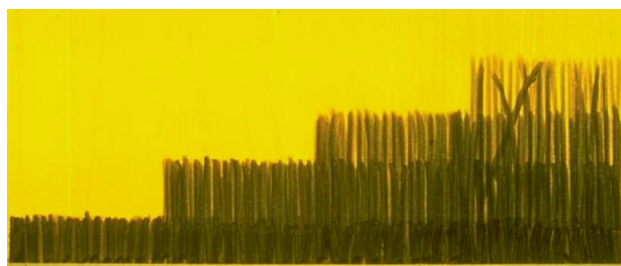

1/4" (6 mm) 1/2" (13 mm) 3/4" (19 mm) 1" (25 mm)

Grass density, and grain, can affect reel mower cutting results. Grass grows denser at lower heights of cut. The denser the grass, the easier it is for the reel mower to cut it with good results.

Requirements for good performance

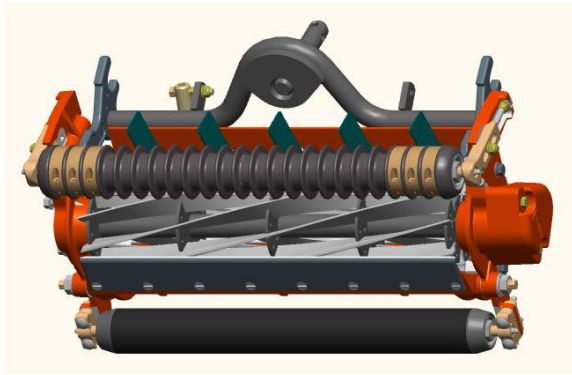

These are basic requirements for good performance of reel mowers:

The cutting edges on the reel blades and bedknife must be straight and sharp.

The bedknife must be exactly parallel with the reel. And, the bedknife should be positioned against the reel with light contact.

When properly maintained and operated, reel mowers provide superior quality of cut. It cannot be overstated that reel mowers are precision tools. It is essential that they be adjusted, and operated with this in mind.

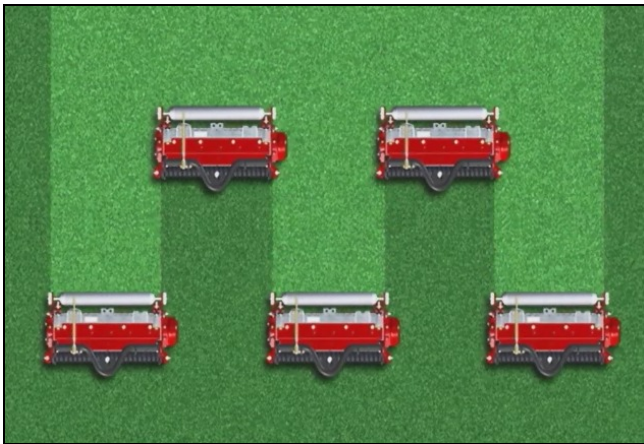

This illustrates a nice clean cut with all five cutting units on a fairway mower set-up and adjusted identically; rollers, bedknife and reel on each cutting unit, all parallel, bedknife attitude, height of cut, and bedknife to reel contact, set the same on every cutting unit.

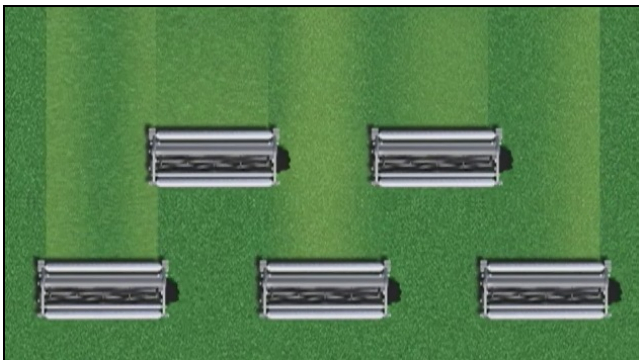

Here, the cutting units are not set-up the same, or have different wear patterns between the individual cutting units. This can cause a mismatched appearance across the width of the mower.

Reel mower performance depends on proper set-up and adjustment procedures. An error of .010 inch or .25 mm, in height of cut, end to end, or from one cutting unit to another, can be visible in the turf. In after-cut appearance terms this is known as, mismatch.

Importance of the Operator

The Operator has a significant influence on the aftercut appearance that a reel mower can deliver.

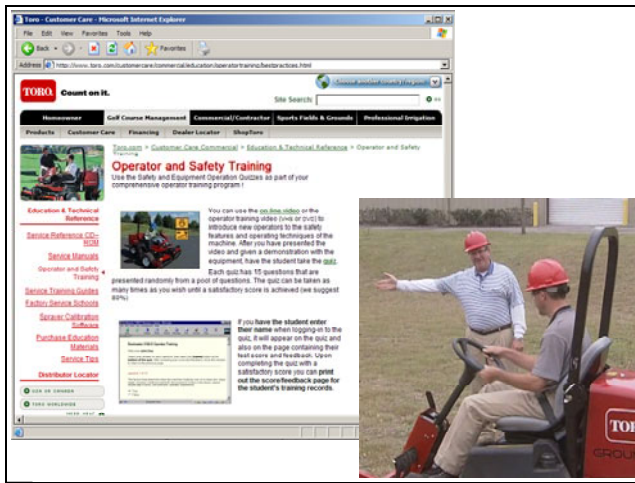

The large investment in specialized mowing equipment cannot be jeopardized by unqualified operators. Before an operator can be considered qualified to operate a piece of equipment, there should be a significant effort by the supervisor towards their training and familiarization with each piece of equipment.

Make sure the operator reads and understands the Operator's Manual. Have the operator watch the Operator Training Video and take the on-line quiz at toro.com, Customer Care. You should also take time to explain the mowing practices used on your grounds, and have the operator practice with the equipment in an open area.

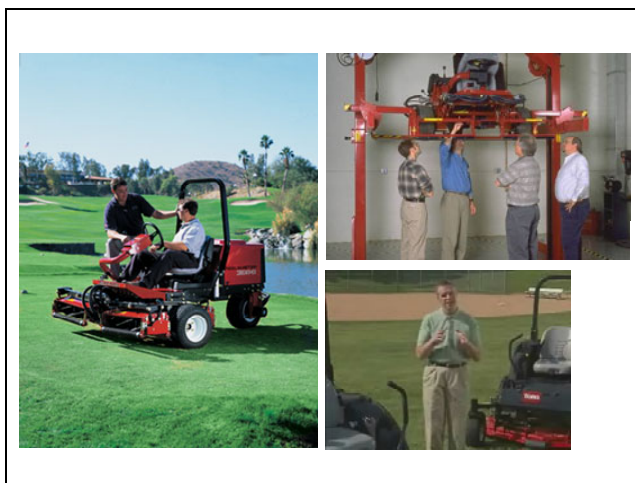

A supervisor should play a key role in establishing the proper attitude and behavior patterns toward operating turf equipment. A supervisor should not create the impression that a few minutes orientation on a piece of equipment will qualify the operator.

Operators and service technicians play a significant role in determining quality of cut, down time, and life of mowing equipment. Make a commitment to train and familiarize staff with each product. Remember, that each type of mowing equipment will have specific operating characteristics, and noise qualities. Operators should become familiar with the product, and listen for any unusual changes. Concerns should be reported to the service technician before significant problems develop.

Preventive Maintenance

To get the most out of your equipment investment, it is important to have a good preventive maintenance program.

Maintenance Check Item	For the week of:						
	Mon.	Tues.	Wed.	Thurs.	Fri.	Sat.	Sun.
Check safety interlock operation.							
Check brake operation.							
Check engine oil level.							
Check cooling system fluid level.							
Drain water/fuel separator.							
Check air filter/pre-cleaner condition.							
Check radiator and screen for debris.							
Check unusual engine noises.							
Check unusual operating noises.							
Check height of cut.							
Check hydraulic system oil level.							
Check hydraulic hoses for damage.							
Check fluid leaks.							
Check tire pressure.							
Check instrument operation.							
Check condition of blades.							
Lubricate all grease fittings. ¹							
Touch up damaged paint.							



REELMASTER 5210 / 5410 / 5510 / 5610
QUICK REFERENCE AID

CHECK/SERVICE (daily)
 1. OIL LEVEL, ENGINE
 2. OIL LEVEL, HYDRAULIC TANK
 3. COOLANT LEVEL, RADIATOR
 4. FUEL /WATER SEPARATOR
 5. PRECLEANER - AIR CLEANER

6. RADIATOR SCREEN
 7. BRAKE FUNCTION
 8. TIRE PRESSURE
 9. BATTERY
 10. BELTS (FAN, ALT.)
 GREASING - SEE OPERATOR'S MANUAL

FLUID SPECIFICATIONS/CHANGE INTERVALS

SEE OPERATOR'S MANUAL FOR INITIAL CHANGES.	FLUID TYPE	CAPACITY	CHANGE INTERVAL FLUID	FILTER	FILTER PART NO.
A. ENGINE OIL	SAE 15W-40CH4	14 QTS. (5.1 L) 15 QTS. (5.7 L) 16 QTS. (6.0 L)	150 HRS.	150 HRS.	104-5167
B. HYD. CIRCUIT OIL	ISO VG 46/68	9 GALS.*	800 HRS.	SEE INDICATOR 400 HRS.	98-2027 98-2028 98-2029
C. AIR CLEANER				SEE INDICATOR	100-9910 (2118) 101-1012 (2112) 102-5012 (2112)
D. FILTER, IN-LINE FUEL				400 HRS.	98-7612
E. WATER SEPARATOR				400 HRS.	98-9764
F. FUEL TANK	NO. 2-Diesel	14 GALS.	Drain and flush, 2 yrs.		
G. COOLANT	50/50 Ethylene glycol/water	15 QTS. (5.7 L) 16 QTS. (6.0 L) 16.5 QTS. (6.2 L)	Drain and flush, 2 yrs.		

*INCLUDING FILTER

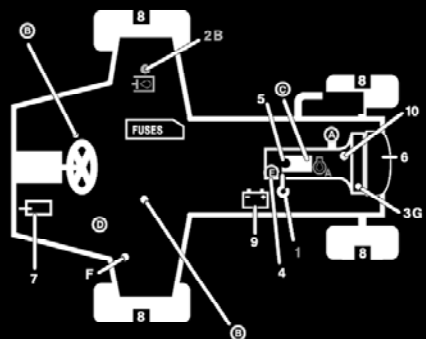

Doing scheduled maintenance and adjustments will prolong the life of your equipment, help prevent expensive downtime, and give the best possible quality of cut and performance. Experience has shown that a high percentage of problems that occur in turf equipment have developed over a period of time and could have been prevented by adjustment, lubrication, or other required maintenance.

Follow the maintenance and adjustment recommendations listed in the Operator's Manual. Some products may also have a Quick Reference maintenance decal on the machine. Recommended maintenance intervals should be considered minimum requirements. If the equipment is operated in particularly harsh conditions, such as very hot weather, during the "grow in" period after construction, or on top-dressed greens, these procedures may have to be performed more often.

Use original Toro parts when doing maintenance or repairs. These parts have been tested and designed for this specific, very demanding, application. "Will fit" parts may look the same and fit, but they can give totally different performance. Don't take a risk on your important equipment investment by saving a little money now that can cost you expensive repairs or increased maintenance intervals later.

Information Resources

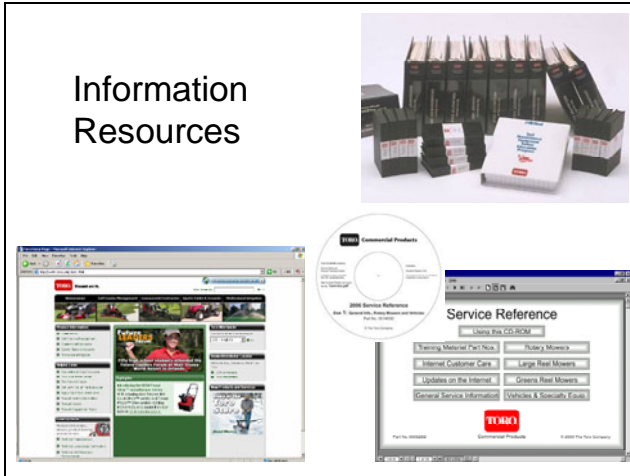

The maintenance charts and Operator's Manuals should be used for reference to identify specific areas requiring ongoing scheduled maintenance. Service Manuals and Training Guides are also available from your Toro Distributor for many models.

Information about Service Education Materials, Maintenance Schedules, Service Bulletins and more is also available on the Internet at: www.toro.com.

Keep Thinking and Be Aware



Mowing equipment is designed for a specific application and should be operated keeping those restrictions in mind. Accidents and personal injuries can be minimized if persons will keep thinking and be aware in their every day work habits.

Cutting Unit Setup and Adjustments

The following pages will cover basic requirements for cutting unit set-up and adjustment. Always use the instructions in the Operator's Manual or Service Manual when working on a specific model.

Reel mower performance depends on proper set-up, and adjustment procedures. An error of .010 inch or .25 mm in height of cut, end-to-end, or from one cutting unit to another, can be visible as miss-match. Although there are design variations in cutting units, most require the same basic procedures. A surface plate, accurate height of cut tools, and proper instruction, are essential for setting up a cutting unit.

To Maintain Performance

Check Daily

- Bedknife to reel adjustment
- Edge sharpness
- Height of cut

Check Periodically

- Roller condition
- Reel bearings
- Bedknife attitude
- Roller Parallelism
- General mechanical condition

Prior to mowing each day there are several items that should be checked. There are several more items that should be checked periodically, according to the mowing conditions and mowing frequency.

Lubrication



Greasing should also be a part of your daily maintenance routine. Greaseable bearings should be greased after every use and after any washing. This not only lubricates, but purges water, which is responsible for the majority of bearing failures on this type of equipment.

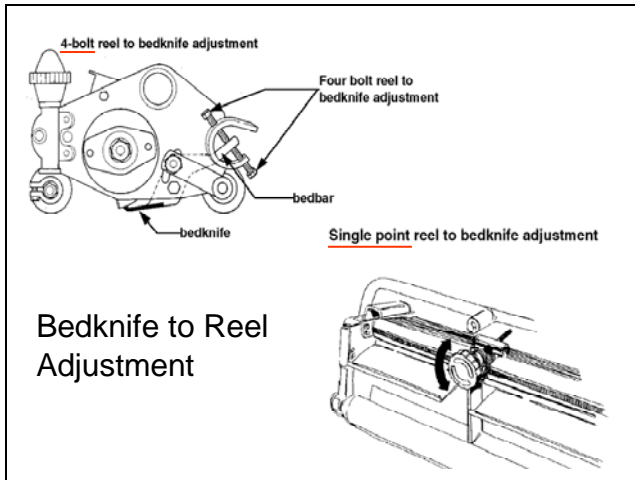

Before performing any set-up procedures, it is critical that the reel and knife cutting edges are straight, and sharp. Backlap, or grind as necessary. Adjust as needed, to ensure the knife, and reel, contact their full length, with LIGHT contact, and free reel rotation.

Note that different cutting unit models have different methods of adjusting reel to bedknife contact. The top illustration shows a four bolt style, adjustment mechanism. The bottom illustration shows a single point, adjustment, mechanism. Single point adjust, cutting units also have an adjustment mechanism on one end of the bedknife, for adjusting the bedknife parallel to the reel.

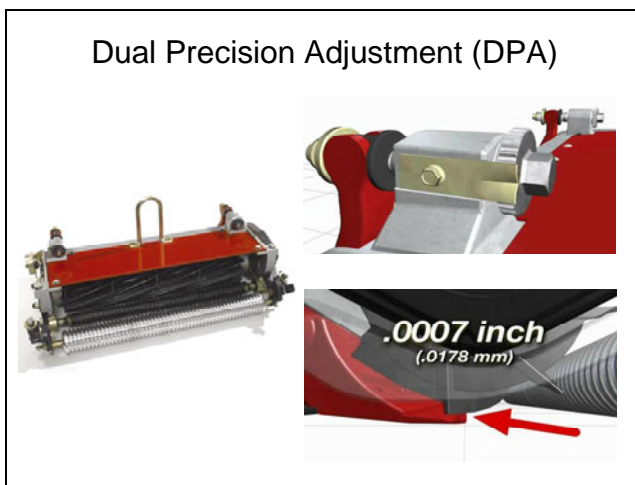

This illustration shows the dual precision adjustment (DPA) mechanism used on the newer Toro cutting unit designs. On this Greensmaster DPA cutting unit, each click of the adjustment screw results in .0007 inch movement of the bedknife; a VERY precise adjustment. On the Reelmaster DPA cutting unit, each click results in .0009 inch of movement.

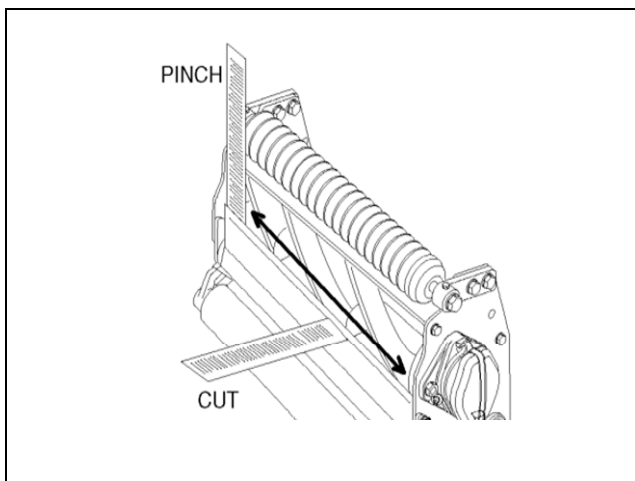

Adjust the bedknife against the reel to EVENLY pinch one paper thickness across the entire width of the bedknife. Then cut paper strips to check blade sharpness.

Parallel, Light Contact and Sharp

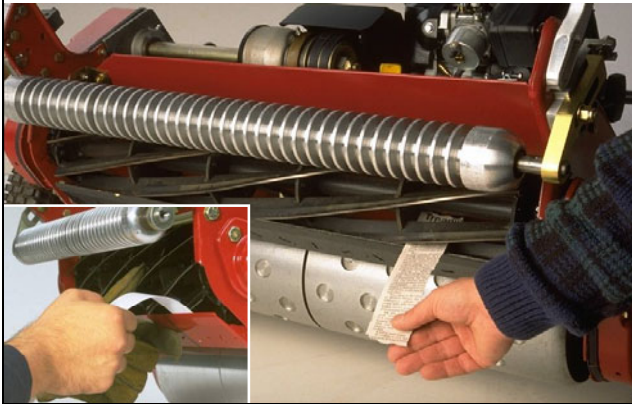

“ Pull, and cut ”:

When the paper is used as a feeler gauge to set even contact across the bedknife, it is held parallel to the bedknife. The reel should pinch with the same amount of resistance at both ends and the center. The “feel” of this measurement should be somewhat the same as pulling the paper between your fingers while applying moderate pressure with your fingers.

The paper must be held perpendicular to the bedknife in order to check sharpness by cutting the paper. If it is not perpendicular it can be pinched between the reel and the bedknife. This is possible even if the components are sharp.

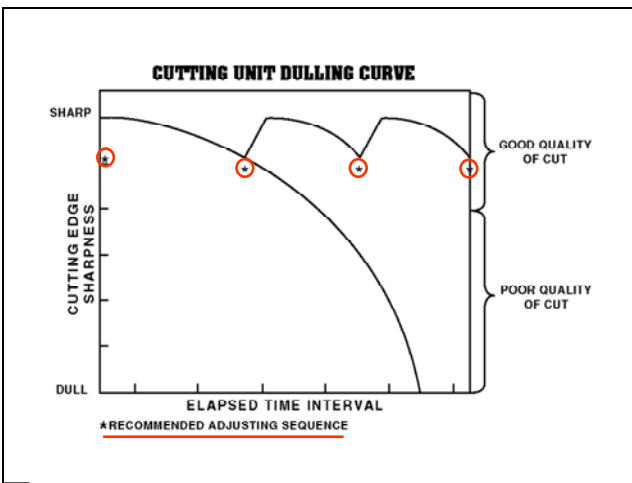

Properly adjusting the bedknife to the reel is one of the most effective preventive maintenance practices for reel mowers. The amount of contact, and how frequently it is checked, are major factors in performance. A light contact adjustment, if maintained, will help keep cutting edges sharp on the reel and bedknife. This requires that the adjustment be checked frequently at a predetermined time interval. Dulled cutting edges cannot be corrected by adjustment or over-tightening.

TORO University

**Don't wait until
quality of cut
deteriorates**

Do not wait until the quality of cut has deteriorated to check the bedknife to reel adjustment.

If the cutting edges on the reel blades and bedknife are not straight and sharp the mowing results may not be acceptable. This is true even if all other set-up procedures are correct.

Attitude and Behind Center Distance (BCD) of Bedknife

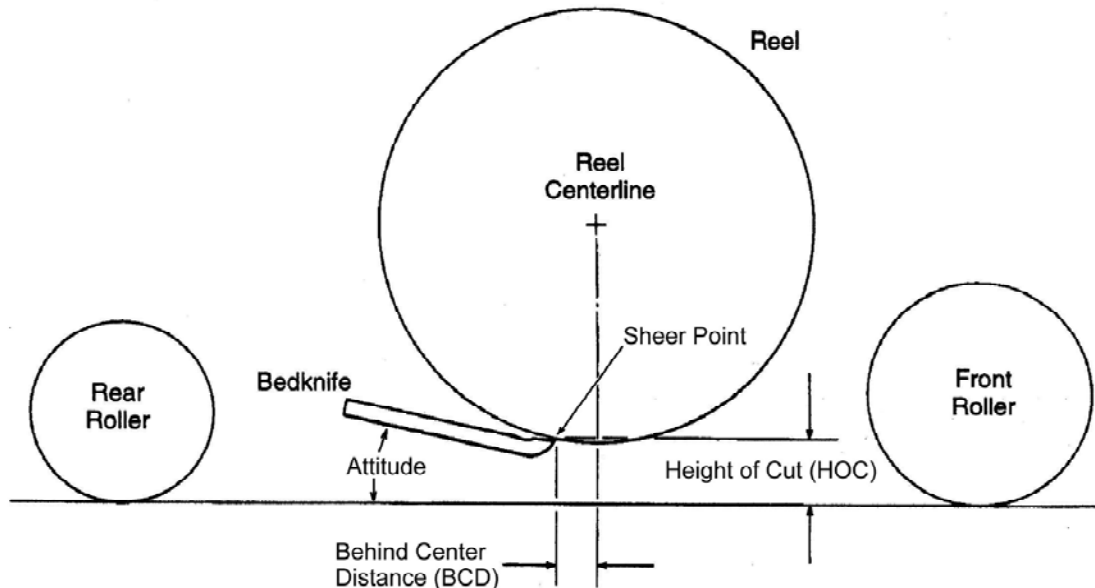

The cutting unit attitude is the angle between the bottom of the bedknife and the surface of the turf under the cutting unit. As the bedknife attitude is changed, it is important to note that the reel to bedknife shear point changes relative to the center line of the reel. This is known as the Behind Center Distance (BCD). A change in the behind center distance can change the after cut appearance of the turf. The result may be better or worse depending on several factors.

Bedknife attitude is adjusted by changing the height of the front, rear, or both rollers depending on the design of the cutting unit. A height of cut change is not necessarily part of a change to the bedknife attitude. A large angle is also referred to as an aggressive bedknife attitude. A small angle is also referred to as a less aggressive bedknife attitude.

The front or the cutting edge must be lower than the back. This prevents the bedbar from contacting the ground surface in low heights of cut. It will also prevent streaking or ruffling of the turf after it has been cut and passed over by the bedbar.

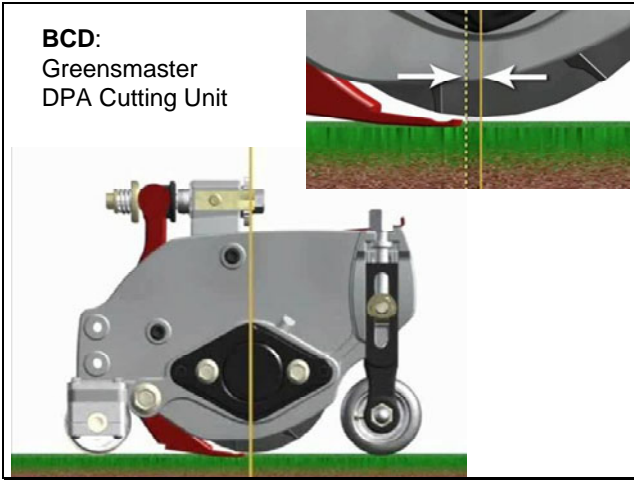

This illustrates the bedknife behind center distance on an actual cutting unit.

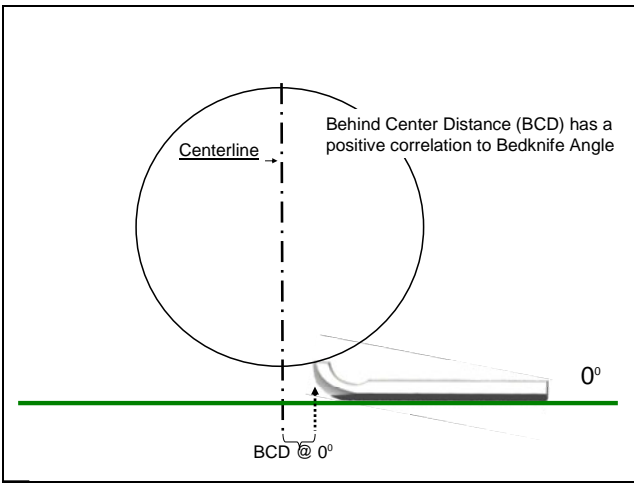

The bedknife angle and the behind center distance have a direct correlation.

When one changes the other changes in the same direction.

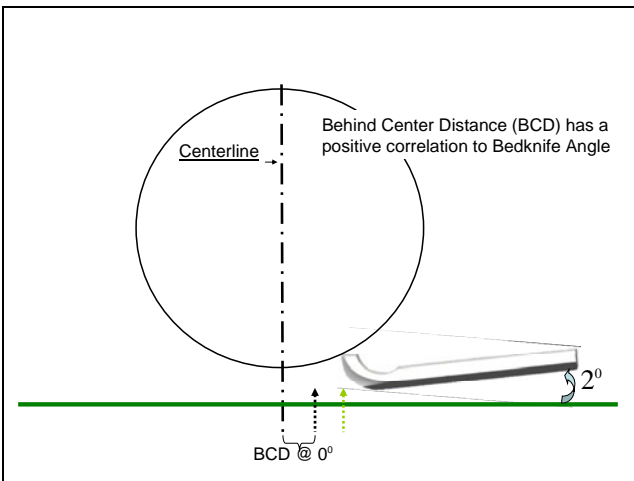

As the angle increases to 2 degrees, the behind center distance has also increased.

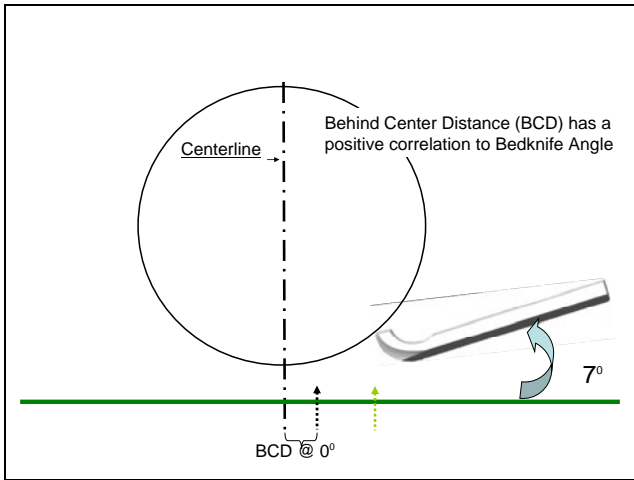

At seven degrees the behind center distance is even greater.

Increasing the behind center distance results in a more aggressive blade path.

Attitude

An aggressive setting is:

- Bedknife angle is extreme
- The bedknife is further from the centerline of the reel
- The reel blades approach is from an aggressive angle

The result can be a crisp, clean cut, however; differences in up and back appearance, a stripe, is pronounced. The down side of this aggressive setting is that any variation in reflections can be very noticeable and perhaps undesirable.

An aggressive setting means the bedknife angle is extreme. The bedknife is further from the centerline of the reel and the reel blades approach is from an aggressive angle.

The result can be a crisp, clean cut, however; differences in up and back appearance, a stripe, is pronounced. The down side of this aggressive setting is that any variation in reflections can be very noticeable and perhaps undesirable.

Attitude

A flat setting (less aggressive) is:

- The angle of the bedknife is flat
- The bedknife is closer to the centerline of the reel
- The reel blade approaches from a horizontal direction

The result: A diffused appearance. Reflective variations cannot be seen as readily. The stripe is less defined. Cut is prone to stragglers.

With a reduction in behind center distance, the reel does not gather grass as cleanly; therefore the grass blades can be different lengths.

This is by definition stragglers, however; the difference can be negligible and tends to diffuse the reflective qualities of the cut grass thereby masking imperfections

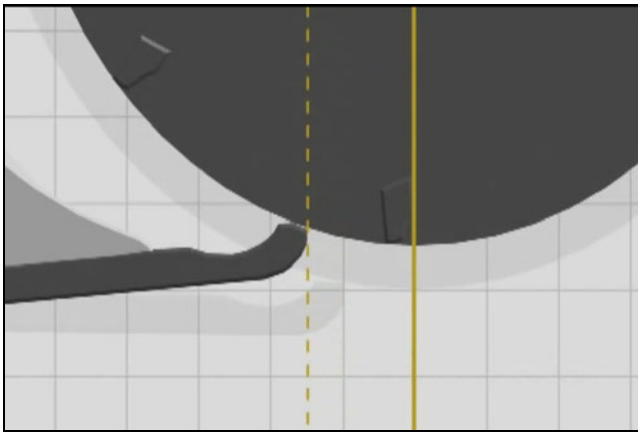

On many cutting unit designs, the bedknife attitude and behind center distance change as the reel wears and its diameter get smaller. This can result in a deteriorating quality of cut, and poor after-cut appearance, including miss-match between cutting units.

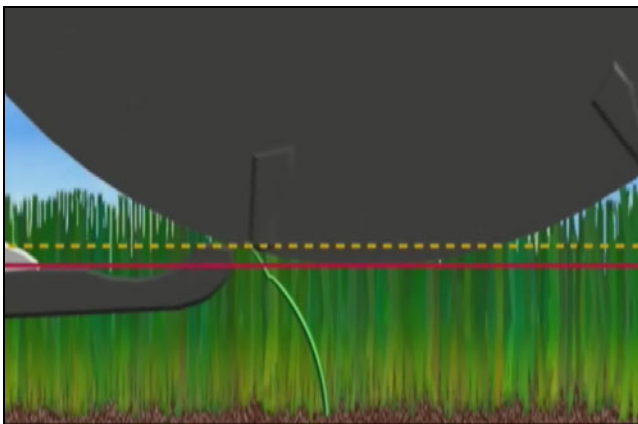

Here is a close up view of the problem. Note the bedknife angle and behind center distance. This illustrates how the quality of cut can deteriorate, when the bedknife angle and behind center distance change as the reel wears.

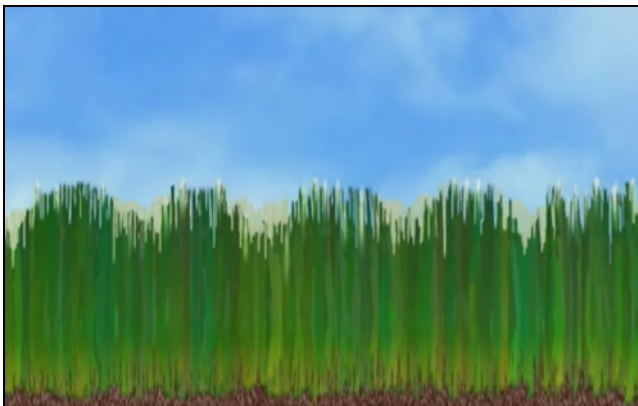

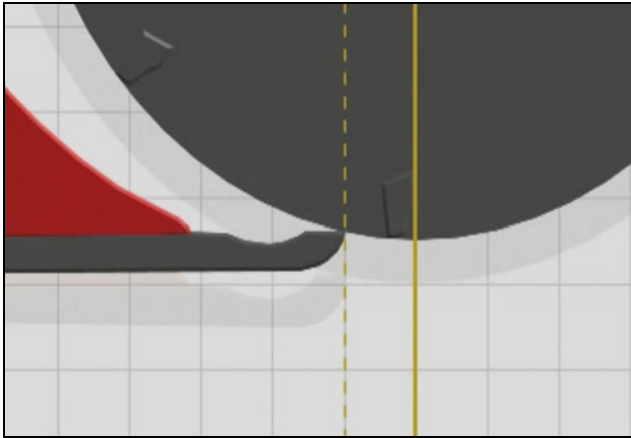

On DPA cutting units, bedknife angle and behind center distance are maintained as the reel wears. This keeps the attitude, or aggressiveness, consistent throughout the life of the bedknife and reel.

As you can see, the reel diameter gets smaller as the reel wears. Note that all cutting units have a specified wear limit diameter for the cutting reel. The reel must be replaced when this wear limit is reached. A chart, with this, and other specifications is provided later in this program.

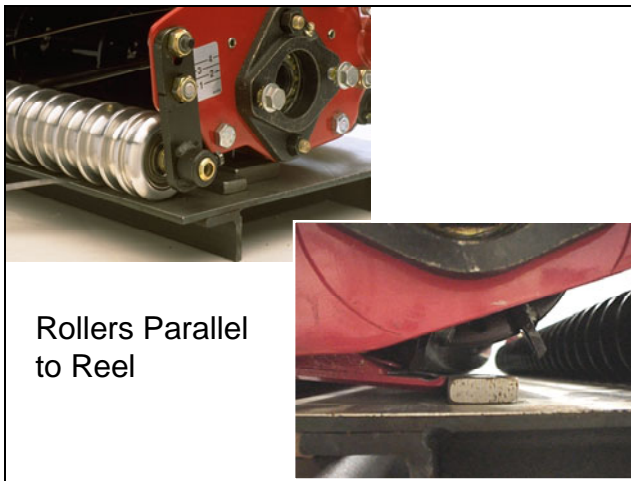

Rollers Parallel to Reel

To achieve an acceptable quality of cut the rollers must be parallel to the reel. Before adjusting roller parallelism check for loose roller bearings. Adjust or replace the bearings as necessary. First parallel the front, or rear roller, which ever is not used for setting the height of cut. This paralleling roller is set to match the reel using a surface plate fixture. With the reel blades resting on a raised bar on the plate, use a feeler gauge along the bottom of the roller between the roller and plate.

Newer DPA model cutting units, with a rigid, bolted frame, normally do not require this procedure.

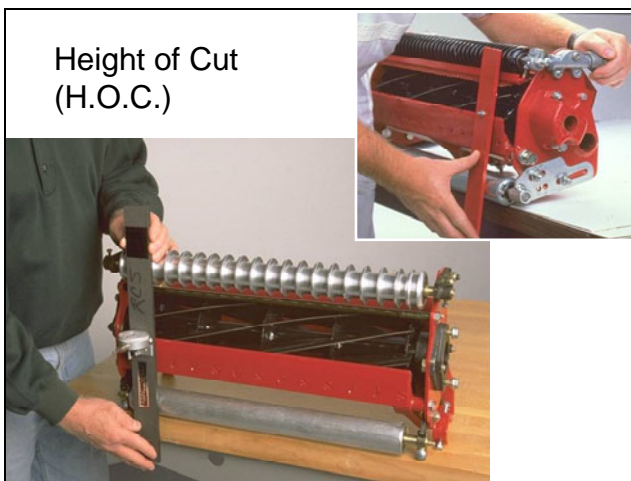

Height of Cut (H.O.C.)

Set the height of cut to the desired height using an accurate tool. This procedure must be done exactly the same on each cutting unit. Before doing this adjustment the bedknife and roller, the one not used for height of cut adjustment, must be parallel to the reel, as described on previous pages.

As reel cutting unit design and configuration continue to evolve, height of cut settings may need modifying to retain visual and playability goals.

Remember, the setting you are making here, the "bench set height of cut", is different from the effective or actual height of cut in the turf

Bench Set vs. Effective H.O.C.

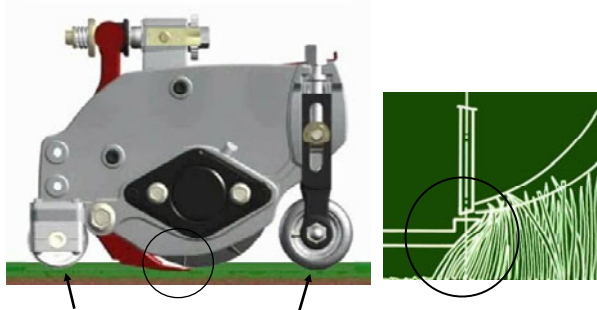

There can be a significant difference between a bench set height of cut and the actual height of cut when in the turf.

The bench set height of cut, is theoretical, based on the assumption that the rollers will set at the same place in the grass and that the turf is firm.

The turf can have varying densities. Different cutting unit models can weigh more or less and the rollers do not always set in the grass in the same manner.

In the circle above you see that after the grass is cut, the remaining grass must make it under the bedknife.

Effective H.O.C. and Bedknife Selection

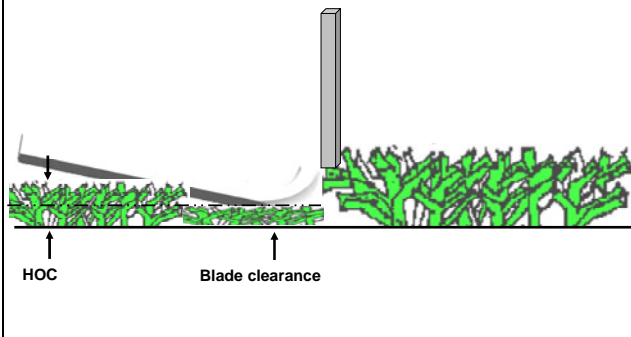

After the grass is cut, the remaining grass must make it under the bedknife. There is not a lot of room for that to happen.

If there is too much grass under the bedknife, it can lift up on the knife causing rifling or the appearance can vary due to the rollers lifting from the turf as the bedknife becomes the support and pivot point for the cutting unit.

On the other hand, if we have too thin of a knife or the height of cut is set higher; there may not be enough grass to aid in heat dissipation.

As you can see, selecting the proper bedknife for your height of cut and turf conditions is important. Bedknife selection will be discussed in more detail later in the program

Quality of Cut and Aftercut Appearance

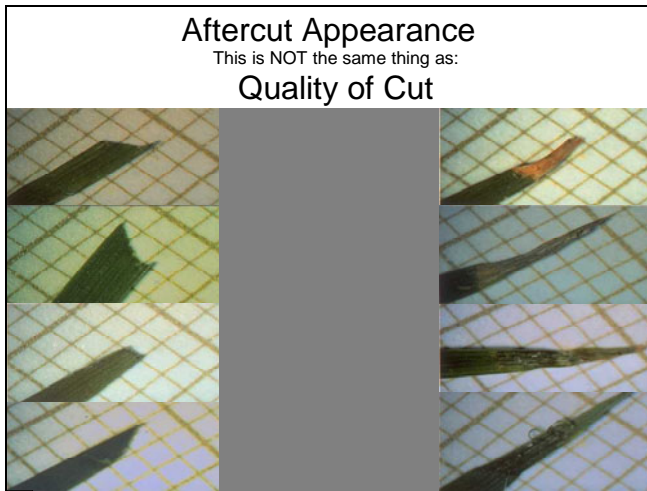

The term Aftercut Appearance, is very specific to appearance and is not the same thing as Quality of Cut. Quality of Cut can affect the appearance, but appearance does not, in itself, affect Quality of Cut. Quality of Cut refers to how well the individual leaves of the grass plant are cut. A quality cut minimizes damage to the leaves of the grass plant. After cut appearance, refers to the visual effects of the turf after it has been cut and across the entire width of the mower.

Turf plant stress increases with:

Too much tissue removed at one time (infrequent mowing).
Removal of more than 1/3 leaf tissue at one time can stop root growth from 6 days to 2 weeks depending on the amount of tissue removed.

- Increased leaf damage (dull blade, sub-optimum setup)
- Increased environmental stress in combination with mowing

Ideal is to raise height of cut during periods of turf stress, such as high heat and/or low moisture

The standard rule for mowing, is never remove more than 1/3 of the grass plant leaf. This is true of all turf cultivars and any type of mowing device.

Leaf damage refers to quality of cut.

In the case of leaf damage, poor quality of cut will result in poor aftercut appearance.

Raising the height of cut is always an option that will usually increase both the health and appearance of the turf.



Quality of cut can be affected by reel blade sharpness and contact with the bedknife. There is a lot of discussion in the industry about the desirability of running units with light contact. One camp says light contact is not necessary while the other says it is if you want the best quality of cut.

We are interested not only in the effect of these things on appearance, but the effect of leaf injury resulting from a less than optimum set-up on plant vigor and the plants susceptibility to disease. Most believe that increasing injury increases susceptibility to disease.

Factors that can affect aftercut appearance

- Tire pressure
- Engine governed speed
- Reel bearing condition/adjustment
- Reel and bedknife sharpness
- Bedknife parallel to reel
- Bedknife to reel contact
- Bedknife attitude (angle)
- Roller(s) parallel to reel
- Height of cut (bench set vs. actual)
- Bedknife selection
- Roller selection
- Cutting unit alignment and ground following
- Roller and roller bearing condition
- Reel speed
- Traction speed
- Cutting unit drop speed and sequence
- Cutting unit counterbalance or down pressure setting

There are many factors that can affect after cut appearance, including, condition of the mowing equipment and agronomic factors. Turf conditions, such as excessive thatch, sponginess, or attempting to cut off too much grass height may not always be overcome by adjusting the machine. It is important to remember that, the lower the height of cut, the more critical these factors are.

Also, remember that the effective or actual height of cut depends on many factors, including, cutting unit weight, cutting unit accessories, and turf conditions. Effective height of cut will be different than the bench set height of cut.



Aftercut Appearance
Troubleshooting Guide



PART NO. 00076SL (Rev. A)

Overlap Marks

Description:

An overlap area is defined as the area where cutting units mow over the path of other cutting units causing various color variations to appear. This is the result of either individual cutting units within the path of a machine or where the paths meet (up and back with alternating directions). The grass is both rolled and/or cut at least twice in this area and appearance can be affected by either or both.

Exaggerated View



TurfEvaluator™ View

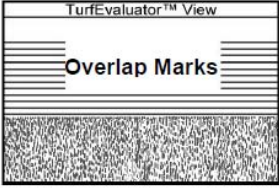

Causes of Overlap Marks:

- Being out twice resulting in indentations or marks of lighter color
- Being rolled twice can create raised or darker marks, which generally dissipate within a few hours after mowing
- Excessive thatch or grain
- Color variations in canopy (Small green leaves on longer stem can increase overlap mark occurrence)
- Cutting off too much grass at one time
- Dull cutting units
- Cutting out of clip range
- Turf stresses due to weather conditions
- Turf compensation system improperly set

Possible Corrective Actions:

- Decrease the bedknife attitude/BCD
- Rollers with different end designs (shouldered roller), shorter front or rear rollers or install Collars
- Longer or shorter rollers to alter the roll effect in the overlap area
- Dethatch, verti-cut, aerate
- Increase fertilizer
- Mow more frequently
- Sharpen reel and bedknife
- Increase or decrease reel speed
- Adjust turf compensation system
- Change mowing direction frequently
- Adjust counterbalance of rear cutting units to be slightly different

TIP

Colors change when observing the cutting coming toward you versus moving away. Always observe and compare results while looking at the same direction of travel.

TORO® Service Training

There are published resources available for troubleshooting aftercut appearance issues. The Aftercut Appearance Troubleshooting Guide is setup with one page dedicated to each issue. At the top is a description followed by a list of possible causes, then possible corrective actions.

Aftercut Appearance Troubleshooting Guide: Part No. **00076SL**

First review the issue and then determine the complaint. Many complaints look very similar but if you have duplicated the condition, this should be relatively easy to work through. Use the definition to pick out subtle differences then review the possible causes. Compare to the issue and you can determine if some corrective actions are easier to try than others. Determine a course of action.

Try one thing and only one thing at a time. Do so in a manner that the results can be watched over a period of time, at least a week. Give it time to work. Remember that after cutting, the grass needs to heal before the result will be realized.

While talking with others use the descriptions listed. Not, because it is the only correct description, but because it has a definition that is identifiable to both of you.

You may download this publication directly from the location you obtained this document, or from toro.com, customer care, technical reference and education resources web pages, at www.toro.com.

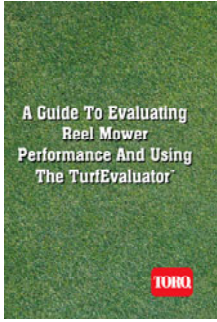

**Part No.
97931SL**

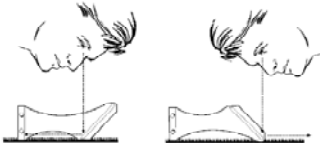
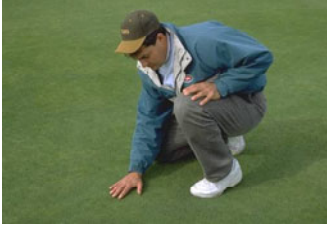

Model 04399

Some turf discrepancies are subtle and require closer examination. In these instances, the Turf Evaluator, grass viewing tool, is helpful. It can assist turf managers in determining causes for poor reel mower performance and comparing the effective height of cut of one mowed surface to another.

Sharpening

Sharpening is part of the required maintenance for proper function of a reel mower cutting unit.

How can you tell if sharpening is necessary?

The grass is not cut cleanly.

The color of the grass; it may have a dull appearance or have brown tips.

Streaks.

Stragglers.

The cutting unit is noisy.

One sure way to determine the answer to this is by actually checking the cutting edges of the reel and bedknife, to see if they are dull, nicked, bent or being run without light contact against one another.

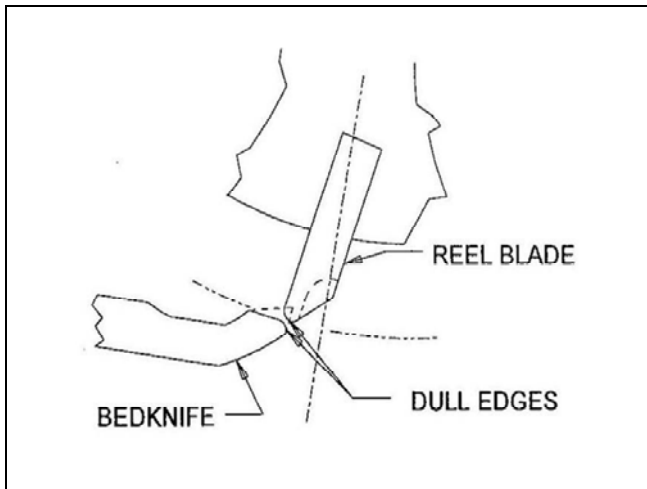

This profile drawing of the blades shows the result of wear.

The leading edges are rounded and the angle of the bedknife has worn to match the circle created by the blade path.

Reel blades, and the edge of the bedknife, should be checked for damage visually and by carefully feeling the edges. Of course, this should only be done when it is certain that the reel cannot be started, and never slide your fingers down the edges lengthwise.

Rounded edges on the reel blades and bedknife will cause the grass blades to be pinched and torn rather than sheared off cleanly. When light contact is not maintained, dull edges will soon result.

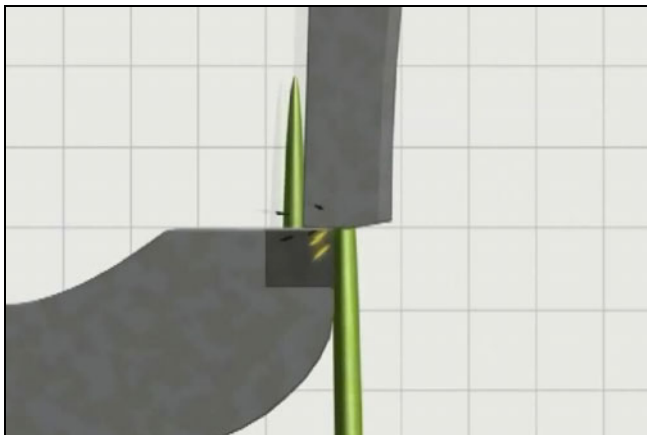

Here is light bedknife to reel contact, which gives a clean cut and helps to maintain a sharp edge.

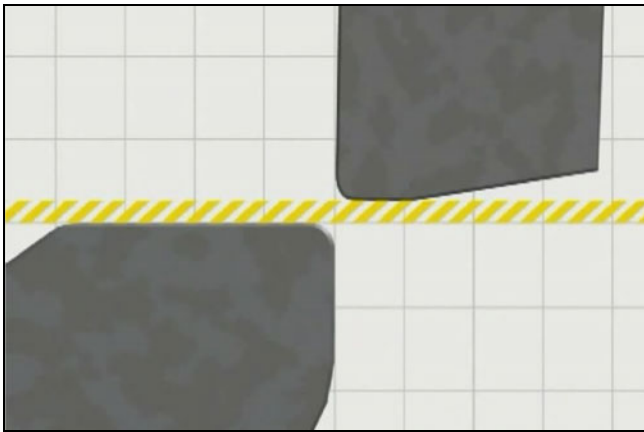

If there is no contact (a gap between bedknife and reel blade) it can result in faster wear of the cutting edges and more frequent grinding.

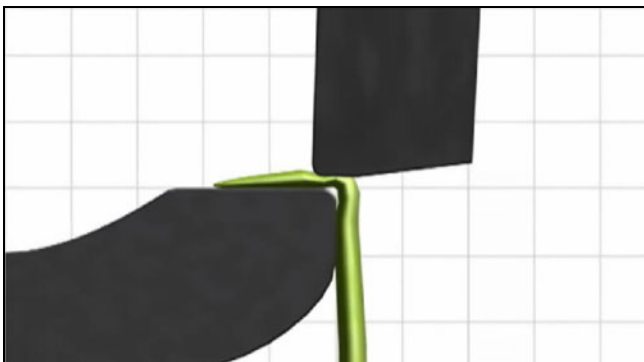

No contact results in the leaves of the grass plant being pinched or torn rather than cleanly cut. This causes poor quality of cut and can actually accelerate the wear process of the cutting edges. The result? deteriorating aftercut appearance and leaf tissue damage which is detrimental to the long term health of the turf.



Sharp vs. Dull Cutting Blades

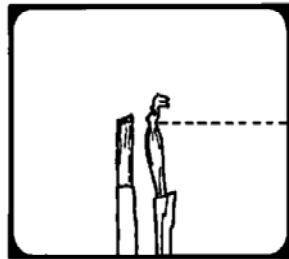
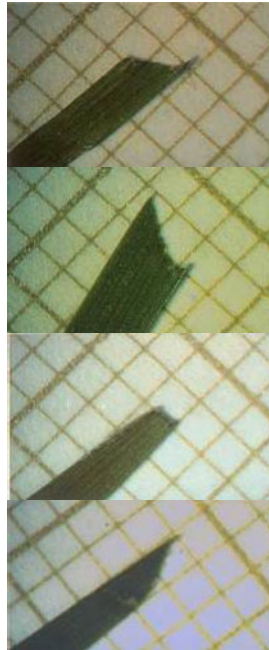

3 hours after cut

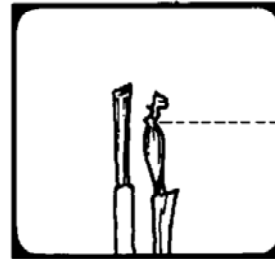

24 hours after cut

Effect of sharp versus dull cut on growth rate on two nearly identical blades of Bluegrass (sketched from actual time-lapse photos).

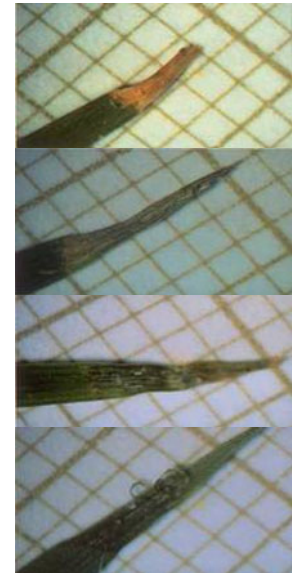

Cutting units should be kept as sharp as possible. This will:

- Promote growth of healthy grass.
- Optimize cutting unit performance.
- Extend the life of the mower.
- Maximize operator mowing time.
- Allow the tractor to run most efficiently.
- And provide the best possible aftercut appearance of the turf.

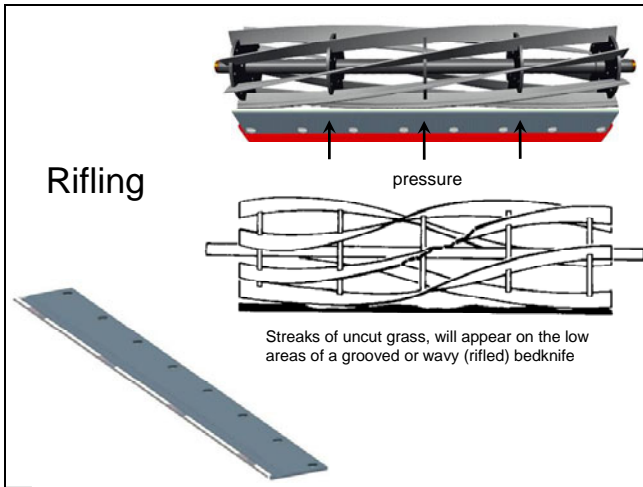

When the cutting unit blades become dull and quality of cut deteriorates, the tendency is to want to tighten the bedknife to reel contact, resulting in heavy contact.

Heavy bedknife to reel contact can cause rifling, which appears as a grooved or wavy wear pattern on the reel and or bedknife. This condition can only be corrected by grinding the reel and bedknife. **BACKLAPPING WILL NOT CORRECT THIS CONDITION.** The bedknife will usually need to be replaced rather than just ground.

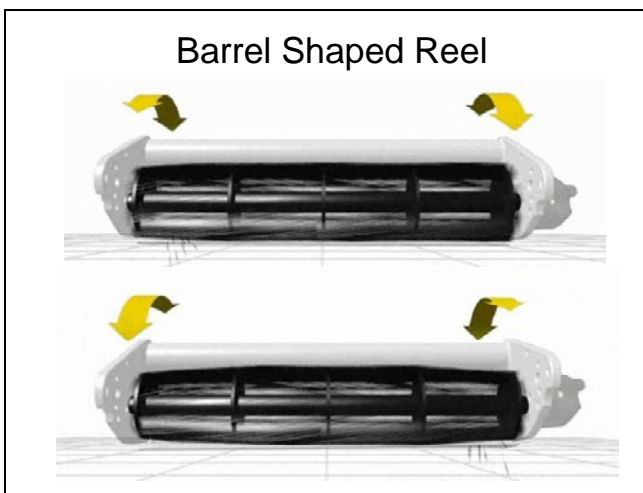

A barrel shaped reel, caused by flexing of the cutting unit frame will also require grinding to bring the reel back to a cylindrical shape.

It is more likely that this will occur on cutting units with welded frames and not on the newer DPA model cutting units with more rigid bolted frames.

Flexing of the frame can cause uneven wear and eventually lead to rifling.

If the reel wears unevenly, it becomes difficult to keep the bedknife parallel across the entire width of the reel. You may be able to pinch paper in the middle, but not on the ends, or vice-versa. When adjusting a cutting unit with this condition, the tendency is to want to tighten the bedknife to reel contact, so the paper can be pinched and cut across the entire bedknife and reel, resulting in heavy contact.

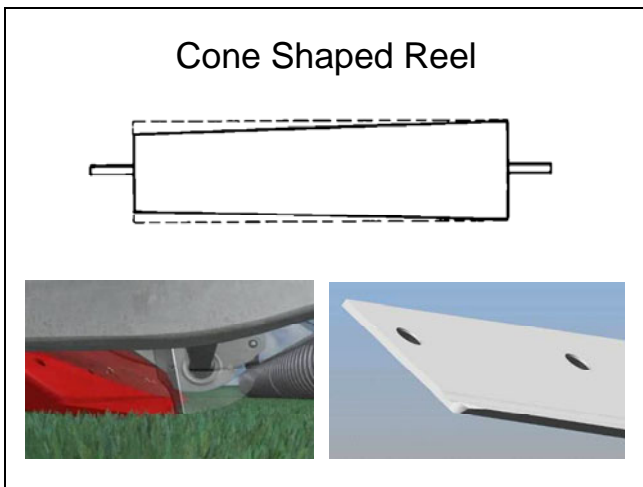

Grinding will also be required if the reel is cone shaped or tapered. Reels eventually become tapered with use. If the reel is not ground to a cylinder shape again, a mismatch, in the height of cut between adjacent cutting units can result.

Sharpening Methods

- Maintain proper ADJUSTMENT
- BACKLAP the bedknife and reel
- GRIND the reel and bedknife

There are several methods that may be used to sharpen a cutting unit. The one that you choose will depend upon the condition of the cutting unit. It should also make the most sense for the anticipated use. For example, if you are about to cut greens that have been core aerated or top dressed, you may not want to grind the reels and install new bed knives.

BACKLAPPING

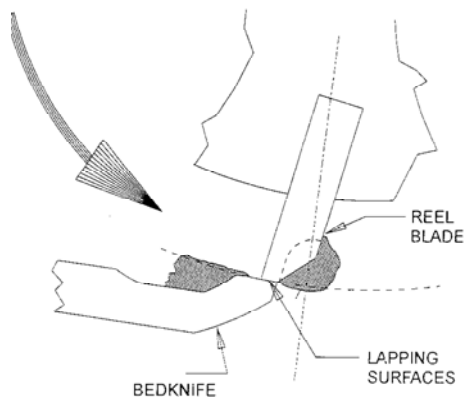

By backlapping regularly, reel blade and bedknife sharpness can be maintained longer between grindings.

Backlapping cannot be used to sharpen a dull reel or bedknife. Backlapping is an edge maintenance practice.

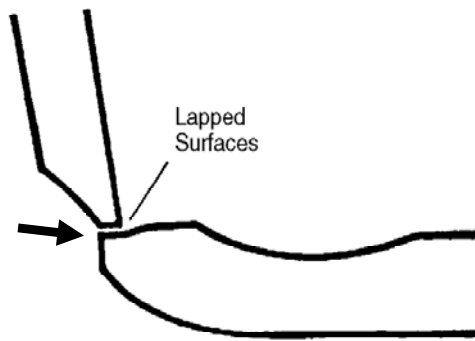

As the reel blades run against the bedknife during backlapping, a slight burr will appear at the front cutting edge surface the full length of the bedknife. Run a file or facing grinder across the front edge to remove this burr.

Backlapping must be done after single blade grinding. This is done to establish a land area and to insure a perfect match between the bedknife and the reel edge.

Backlapping is not intended to be a reconditioning process to correct severely nicked or rounded blades, rifling or taper. If, after approximately 5 minutes of lapping, the edge is not restored, it is time to grind the reel and bedknife.

Backlapping is often a regularly scheduled maintenance process, particularly with greens mowers.

**WARNING:**

Always use a brush with an extended handle to apply the lapping compound to the rotating reel. Using a short handle brush could cause your hand to be pulled into the reel, and cause serious injury. Keep your hands, feet and clothing away from moving parts!

**BACKLAP OFTEN
but
VERY LITTLE**

Approximately
5 Minutes per Cutting Unit

If you use backlapping as a regular maintenance practice, backlap often, but for a very short time. For example, five minutes per cutting unit.

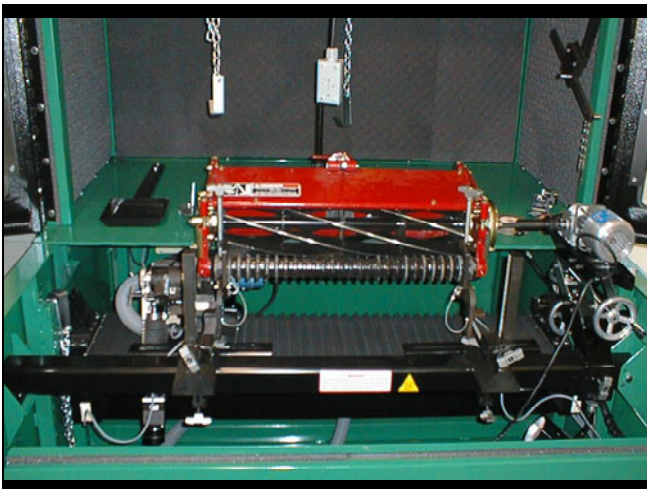

Before a reel can be ground correctly, the reel has to be cleaned and checked for loose or bent blades. The reel bearings must be in good condition, with no end play evident. Make sure the cutting unit frame and roller brackets are true and not bent or damaged from impacts with trees, posts or cart path edges. The cutting unit must be aligned so the grinding wheel will travel parallel to the reel shaft. This will result in the reel being ground to the desired cylinder shape.

Follow the grinder manufacturer's instructions for set-up and operation of the grinder.

When grinding, be careful to not overheat the reel blades. Remove small amounts of material with each pass of the grinder.

After completing the grinding process, do a complete set-up and adjustment procedure on each cutting unit.

Grinders

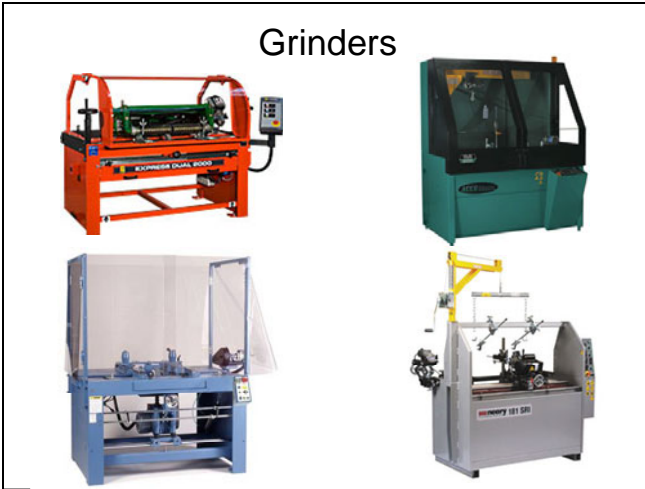

There are several manufacturers of reel grinders. These same manufacturers also produce bedknife grinders.

WARNING !

Always wear a face shield or safety glasses when grinding or backlapping.

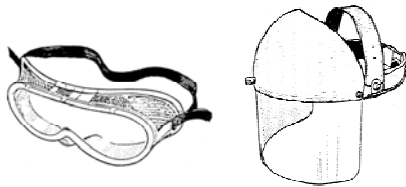

Remember to always wear a face shield or safety glasses when grinding or backlapping.

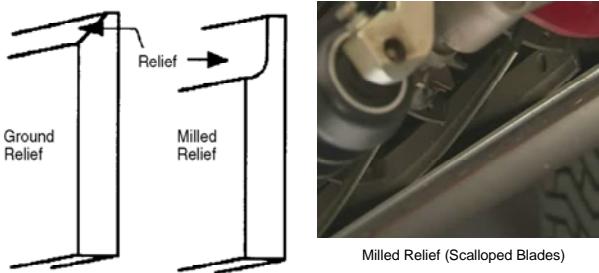

Milled Relief (Scalloped Blades)

It is important to understand that Toro reel mowers are designed and manufactured to optimize available power from the engine and hydraulic systems. To help do this, we put a “relief” or back grind on every reel blade to reduce the width of reel blade that contacts the bedknife. This has been proven to reduce power requirements, as well as allow the machine to operate more efficiently. This can be very important, depending on the terrain, type of grass and amount of grass being cut.

Toro has two different methods of manufacturing reel blades with a relief. The reel blades are made from straight stock steel and then are either relief ground or the relief is milled in. Either way, there is a relief on the blade when it is manufactured. A small, ground relief is also put on milled relief blades, during manufacture.

Toro greens mowers and DPA fairway cutting units are manufactured with a milled relief. Other trim, utility, and fairway mowers have a ground relief.

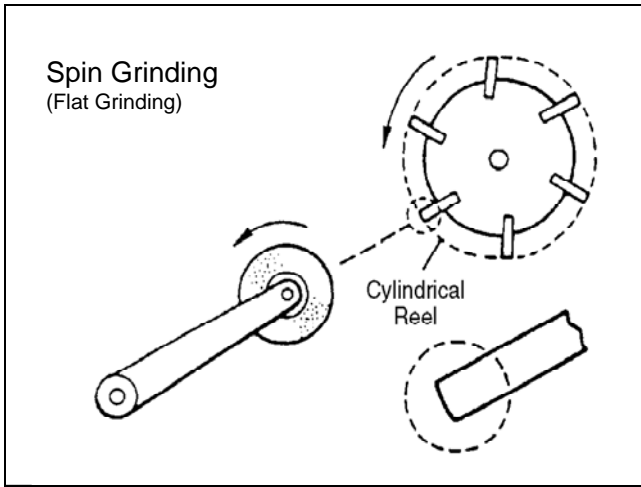

There are two methods of grinding reels. This illustrates Spin Grinding (which is also known as Flat Grinding).

With this method, both the reel and the grinding stone are turning as the reel is being sharpened. It is sometimes stated that backlapping is not required after spin grinding because the reel is a perfect cylinder when grinding is completed. This depends on proper alignment of the reel in the grinder before sharpening. Also, the bedknife and bedbar must be straight and perfectly parallel to the reel when it is mounted. Backlapping will remove burrs and rough edges, producing a honed edge that will cut grass evenly.

If using a spin grinder to sharpen straight stock reel blades (such as on fairway mowers), some or all of the relief will be ground off. If you are going to restore the relief that was on the blade when was manufactured, you will need to also use the other method of grinding (single blade relief grinding). It is recommended to do the relief grinding first, then spin grind to restore the reel to a cylinder shape and establish the land width.

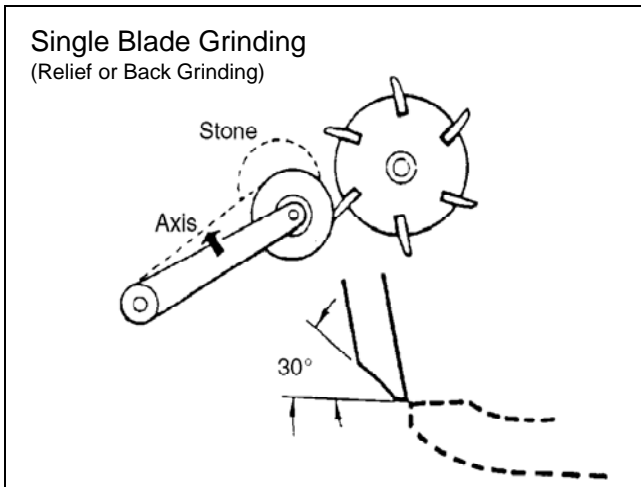

This illustrates Single Blade Grinding (which is also know as Relief, Grinding, or Back Grinding).

With modern grinding equipment, spin (or flat) grinding and single blade grinding are available on the same machine. Single blade grind if necessary, to restore the relief or back grind, then spin grind to sharpen and return the reel to a cylinder shape.

Toro recommends a 30 degree relief angle on each reel blade. The angle itself is not critical. You can put as little or as much angle on the blade as you think is proper. A larger angle will take off more steel and the reel may have to be replaced sooner. With a smaller angle, you may have to grind the reel more often to maintain a relief. See the reel and bedknife grinding guidelines chart, at the end of this section, for grinding specifications on each cutting unit model.

Reel Grinding

Grind parallel to the Reel Shaft
 Do Not grind by equaling the spark pattern on each end

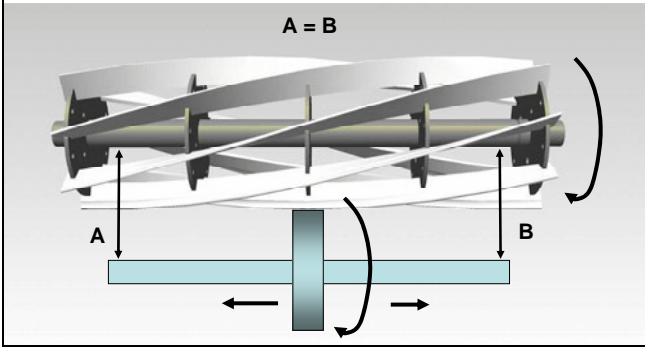

Whichever grinder you use, be sure to compensate for a cone or barrel shaped condition.

Grind parallel to the Reel Shaft. Do Not setup the grinder by simply equaling the spark pattern on each end. This will not remove the slight cone shape of the worn reel.

Reels naturally wear more on one end than the other.

Verify the reel centerline, which is the reel shaft, is parallel to the grinder stone travel.

Bedknife Installation



If replacing the bedknife it is important to use the following procedures:

- Remove all rust, scale and corrosion from the bedbar surface before installing new bedknife.
- Make sure the bedbar threads are clean.
- Use new Toro screws. Apply anti-seize lubricant to the screw threads before installing.

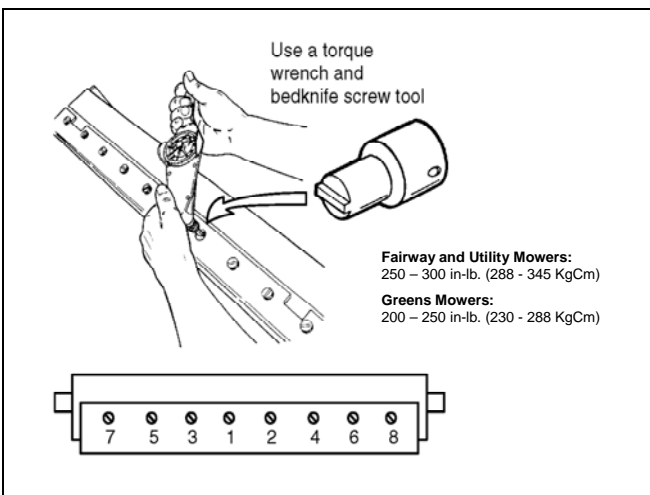

Use a torque wrench and bedknife screw tool

Fairway and Utility Mowers:
 250 – 300 in-lb. (288 - 345 KgCm)
 Greens Mowers:
 200 – 250 in-lb. (230 - 288 KgCm)

Tighten the screws working from the center toward each end of the bedbar. Do not use an impact wrench.

Fairway/utility mowers:
 250 – 300 in-lb. (288 – 345 KgCm)
Greens mowers:
 200 - 250 in-lb. (230 - 288 KgCm)

Since there can be variations in the mounting surface of the bedbar, a new bedknife may not be perfectly flat after it is installed. Because of this, it is necessary to backlap or grind a new bedknife after installing it to the bedbar. Follow the existing angle that was ground into the bedknife and grind only enough to make sure the top surface is true.

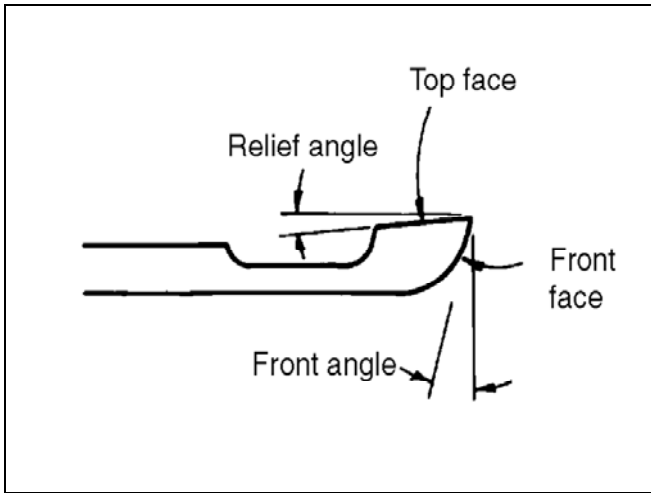

This illustrates the characteristics for the bedknife that are specified in the Toro Reel and Bedknife Grinding Guidelines, such as Relief Angle and Front Angle.

When regrinding a bedknife it is important to use the following procedures:

- Remove the bedbar and bedknife assembly from the cutting unit before attempting to grind a used bedknife.
- Keep the bedknife fastened to the bedbar when grinding.
- When grinding, be careful to not overheat the bedknife. Remove small amounts of material with each pass of the grinder.

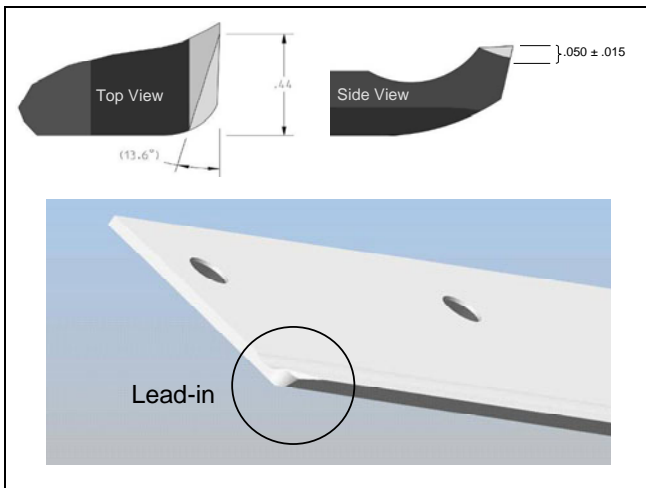

A lead-in provides a softened entry for the leading side of the reel blade helix as it approaches the bedknife. This helps eliminate rifling caused by heavy contact and vibration. If the bedknife had the lead-in originally, be sure to put it there when done grinding the bedknife and reel.

Example specifications for this lead-in for a fairway mower knife are as shown. These specifications are only a suggestion. The idea is to get a grind in place not to spend a lot of time making sure it is exact. Using a file to make the lead-in is a perfectly acceptable method. It is important not to make the lead-in too long or you will notice that there is a streak left behind at the edge of the cutting unit as the reel will not cut well in the area of the grind or may adversely affect the overlap area.

It is also important that the lead-in make a smooth transition. Be sure to remove any burr that develops as a result of making the lead-in. The lead-in will lessen as a result of bedknife wear and should be redressed with a file at the same time the ears are removed.

The EdgeMax™ bedknife includes a leading edge of harder steel

Holds an edge twice as long and reduces the need for adjustments, backlapping and grinding



- Set bedknife to reel adjustment as usual
 - Light contact while running on the ground
- No special requirements

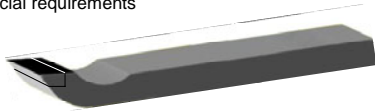

The Edge Max bedknife includes a leading edge of harder steel.

The Edge Max bedknife Holds an edge twice as long as a standard bedknife, and reduces the need for adjustments, backlapping and grinding.

Set the bedknife to reel adjustment on an Edge Max bedknife as usual. Light contact while running on the ground.

There are no other special requirements.

Maintaining the EdgeMax Bedknife

- A dull knife must be sharpened
- If backlapping is part of your maintenance practice, be prepared to backlap for two to three times the amount of time as compared to a standard bedknife
- Front face grinding is acceptable in moderation
 - Any facing or grinding must be done with exacting tolerances. Do not use a hand held grinder

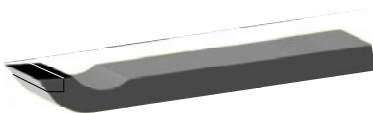

A dull knife must be sharpened.

If backlapping is part of your maintenance practice, be prepared to backlap for two to three times the amount of time as compared to a standard bedknife. Front face grinding is acceptable in moderation.

Any facing or grinding must be done with exacting tolerances. Do not use a hand held grinder

Sharpening the EdgeMax Bedknife

- No special stones required
- Dress the stone more frequently
 - Before starting and at least once during grinding
- One pass to dress
 - Multiple passes will cause the stone to back up
- When grinding, remove smaller amounts of material (shallower cut)
- Expect a different spark pattern



Mild Steel: Many orange visible streaks with few sparks



Tool Steel: Few visible streaks with noticeable sparks

No special stones required.

Dress the stone more frequently. Before starting, and at least once during grinding. One pass to dress. Multiple passes will cause the stone to load up.

When grinding, remove smaller amounts of material (a shallower cut).

Expect a different spark pattern.

See **Toro Reel and Bedknife Grinding Guidelines** chart for specifications.

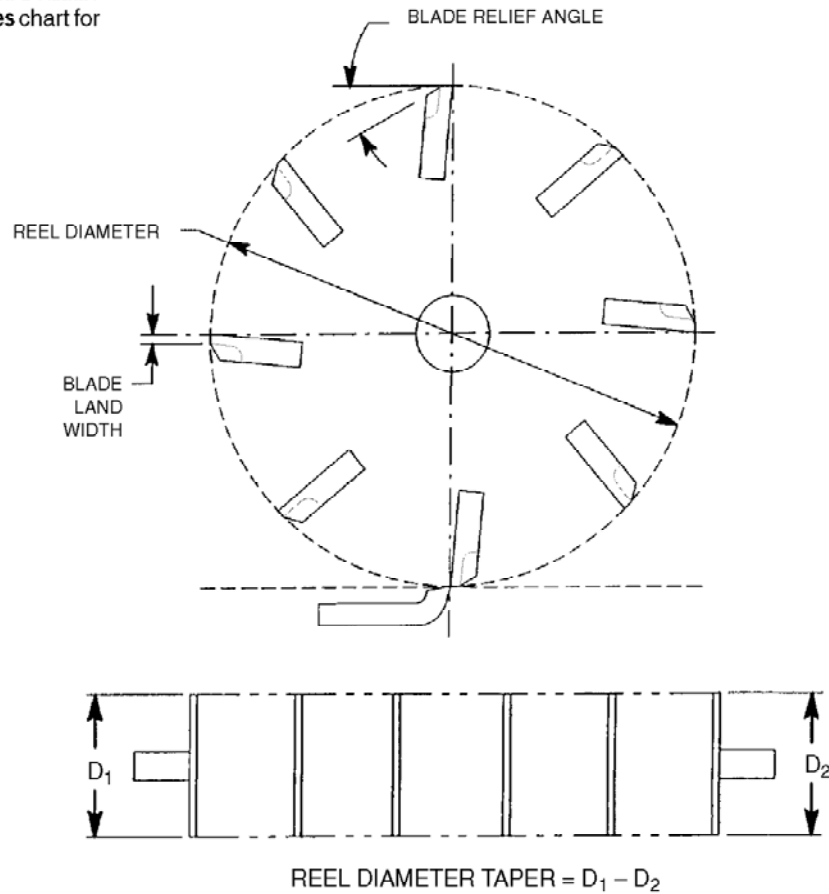

This diagram illustrates the characteristics that are specified for the reel in the Toro Reel and Bedknife Grinding Guidelines, such as the Reel Diameter, Blade Relief Angle, Blade Land Width and Reel Taper.

When regrinding a cutting unit reel or bedknife, use the specifications from the Toro Reel and Bedknife Grinding Guidelines on the next page. If the reel diameter is less than the service limit shown, it must be replaced.

Reel and Bedknife Grinding Guidelines

Product Group	Reel Cylinder							Bedknife	
	Diameter	Service Limit	Blade Choices	Relief Angle	Land Width	Maximum Taper	Top Angle	Front Angle	
GR 105, 500	3.5" (89mm)	3.2" (81mm)	9	30° ± 10°	.040" ± .010" (1 ± .2mm)	.010" (.2mm)	0°	30° ± 4°	
GR 800 & 1000 Flex 18 & 21	5" (127mm)	4.5" (114mm)	5, 8 & 11	30° ± 10°	.040" ± .010" (1 ± .2mm)	.010" (.2mm)	3°	13° ± 2°	
GR 3000 Std reels	5" (127mm)	4.5" (114mm)	5, 8 & 11	30° ± 10°	.030" ± .010" (.7 ± .2mm)	.010" (.2mm)	3°	13° ± 2°	
GR 3000 HD reels	5" (127mm)	4.5" (114mm)	5, 8 & 12	43° ± 10°	.060" ± .010" (1.5 ± .2mm)	.010" (.2mm)	3° ± 2°	13° ± 2°	
RM 108	7" (178mm)	6.6" (168mm)	5 & 6	30° ± 10°	.060" ± .010" (1.5 ± .2mm)	.010" (.2mm)	5° ± 2°	30° ± 5°	
RM 223D	5" (127mm)	4.5" (114mm)	5 & 8	30° ± 10°	.040" ± .010" (1 ± .2mm)	.010" (.2mm)	5° ± 2°	5° ± 2°	
RM 5100 - 5400	5" (127mm)	4.5" (114mm)	5, 8 & 11	25° ± 5°	.040" ± .010" (1 ± .2mm)	.010" (.2mm)	5° ± 2°	5° ± 2°	
RM 216									
RM 2000 series	7" (178mm)	6.6" (168mm)	5 & 8	30° ± 10°	.060" ± .010" (1.5 ± .2mm)	.010" (.2mm)	5° ± 2°	30° ± 5°	
RM 3100									
Grounds Pro									
RM 5500	7" (178mm)	6.6" (168mm)	5, 7 & 11	30° ± 10°	.060" ± .010" (1.5 ± .2mm)	.010" (.2mm)	5° ± 2°	5° ± 2°	
RM 6500 & 6700	7" (178mm)	6.6" (168mm)	5, 8 & 11	25° ± 5°	.040" ± .010" (1 ± .2mm)	.010" (.2mm)	5° ± 2°	5° ± 2°	
RM 5510 & 5610	7" (178mm)	6.6" (168mm)	5, 8 & 11	25° ± 5°	.040" ± .010" (1 ± .2mm)	.010" (.2mm)	5° ± 2°	5° ± 2°	
RM 335 & 450									
RM 3500	8" (203mm)	7.2" (183mm)	5, 7 & 11	30° ± 10°	.060" ± .010" (1.5 ± .2mm)	.010" (.2mm)	5° ± 2°	30° ± 5°	
RM 4000 series									
Turf Pro	7" (178mm)	6.6" (168mm)	5 & 7	30° ± 10°	.060" ± .010" (1.5 ± .2mm)	.010" (.2mm)	5° ± 2°	15° ± 2°	
Spartan & RM 11	7" (178mm)	6.6" (168mm)	11	30° ± 10°	.060" ± .010" (1.5 ± .2mm)	.010" (.2mm)	5° ± 2°	30° ± 5°	
Spartan & RM 5 & 7	8" (203mm)	7.2" (183mm)	5 & 7	30° ± 10°	.060" ± .010" (1.5 ± .2mm)	.010" (.2mm)	5° ± 2°	30° ± 5°	

Bedknives, Rollers and Accessories

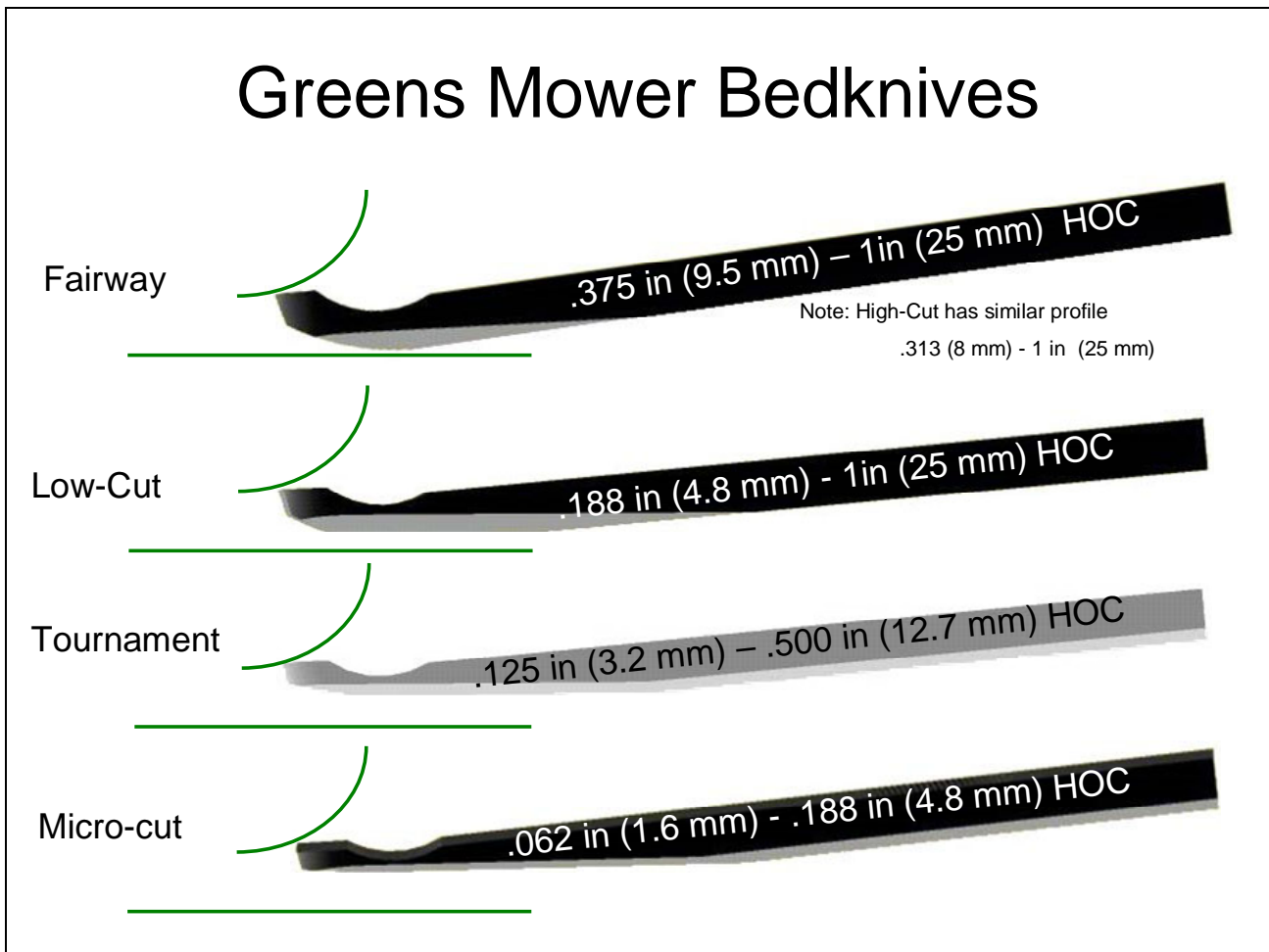

Bedknife design must allow for maximum material to dissipate heat and yet allow the remaining uncut grass under the bedknife.

Unfortunately, there is no set rule for space left under the knife, nor can there be. This is due primarily to surface density and turf conditions. There is no measurable plane that works, other than, **your** mower, in **your** turf.

The only thing that is absolute is that while on the bench, the bedknife can not touch the height of cut adjusting tool. There **must** be a reasonable space between the bedknife and height of cut adjusting tool.

To look at that in a different manner, place the cutting unit on a table resting on the rollers so as you can look at the end of the cutting unit. The bedknife can not touch the table top. This is the absolute! Everything else depends on the agronomic conditions of the turf.

Listed here are popular Greens mower bedknives and their recommended operating range.

DPA Fairway Mower Bedknives

EdgeMax™
(Original Equipment)

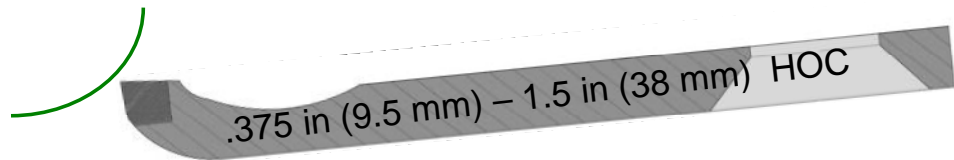

Standard

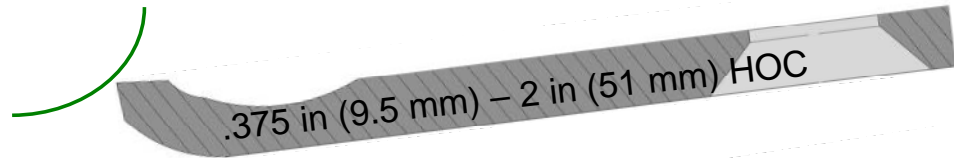

HD

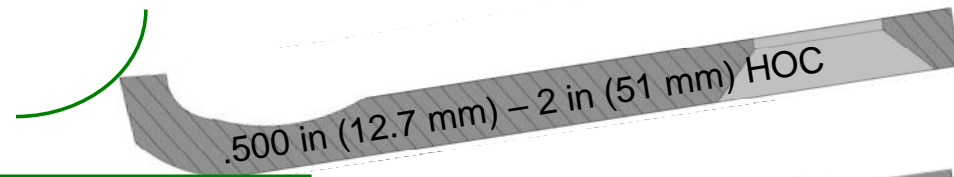

Low-Cut

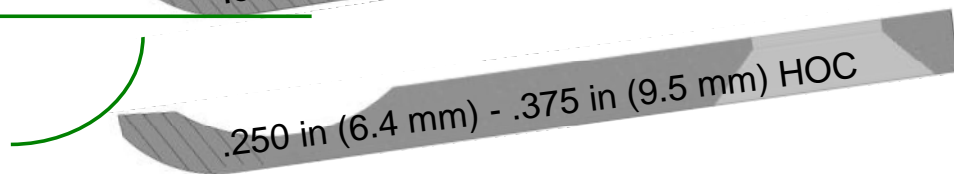

Due to the height of cut variations on a fairway and the requirements of cutting conditions there is another line of bedknives for the fairway or higher height of cut ranges.



The basic groups of ground contacting rollers are shown here.



Full rollers provide a stable platform using full width contact. Some characteristics of full rollers include:
Increases, the effective cutting height.

Rides higher or floats more on the turf.

Can be made heavier or larger to help with cutting unit control.

Less likely to scuff the turf in turns.

Less likely to damage the turf when lowering onto it.

Narrower rear rollers can help address overlap roller marks in cool season grasses. Note that the narrower rollers can reduce the stability of the cutting unit.



Wiehle (or grooved) rollers also provide a stable platform with some different characteristics.

Contact line is broken into individual contact points allowing for greater surface pressure at the contact point.

Individual contact points allow for better incursion into the turf canopy.

Allows seed heads to be cut and gathered better. Note that these rollers can sometimes scuff the turf in turns.

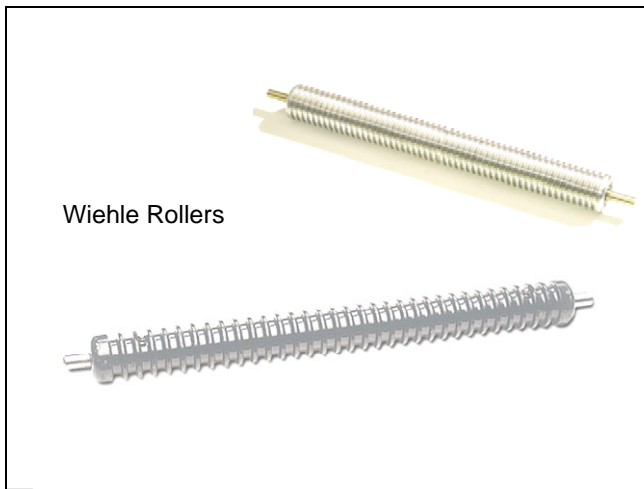

Wiehle Rollers

Here are some adaptations of the Wiehle roller:
Aluminum lessens contact pressure due to weight difference.

Cast iron increases cutting unit control by increasing contact pressure.

Wider spacing tends to increase incursion into the canopy due to increased contact pressure while disturbing less grass.

Narrower spacing tends to lessen incursion into the canopy acting more as a full roller.

The end of the roller is designed to allow for a clean transition.

Tapered or wider transitions are less disruptive to the turf during cutting unit steer.

Disc (flute or Wiehle) design modifies turf interaction.



Shouldered Wiehle Rollers

The shouldered Wiehle roller offers the same ground engaging characteristics as a non-shouldered Wiehle roller.

Outermost grooves are filled to help minimize stripping of grass due to cutting unit overlap in warm season grasses.



Accessories

There is an entire array of accessories available for reel mower cutting units.

Accessories



Combs and Brushes



Combs and brushes are designed to be mounted behind the front.

Generally these devices are used to just make contact with the grass after the roller has pressed it down. This is to help stand the grass up for a more uniform cut.

Brushes may also be in combination with scrapers on front rollers.

Accessories

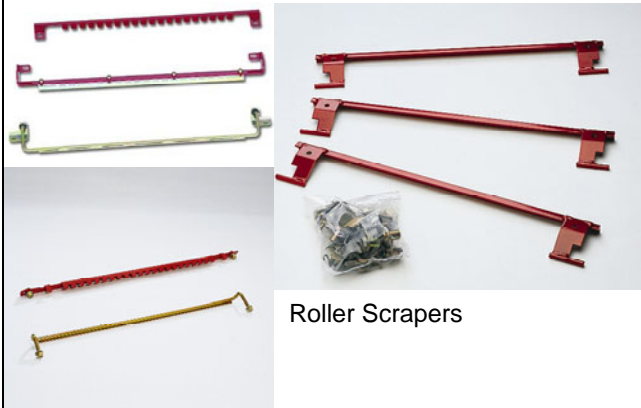

Roller Scrapers

Roller scrapers are designed to do just that, scrape rollers. This is to keep grass clippings from building up on the rollers, which can change the height of cut during mowing.

Scrapers are set with a small clearance from the roller. Note that affixing the scraper too close or on the trailing side of rotation will cause them to trap clippings, cause excessive wear to the roller or increase rolling resistance binding the roller.

Accessories

Powered Rear Roller Brushes

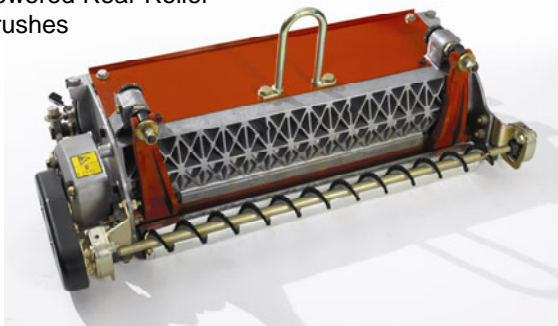

Powered rear roller brushes are also intended to keep the rollers from collecting debris. The difference is that these brushes help disperse the debris and do an excellent job of cleaning up the final appearance.

Groomers and Thatchers

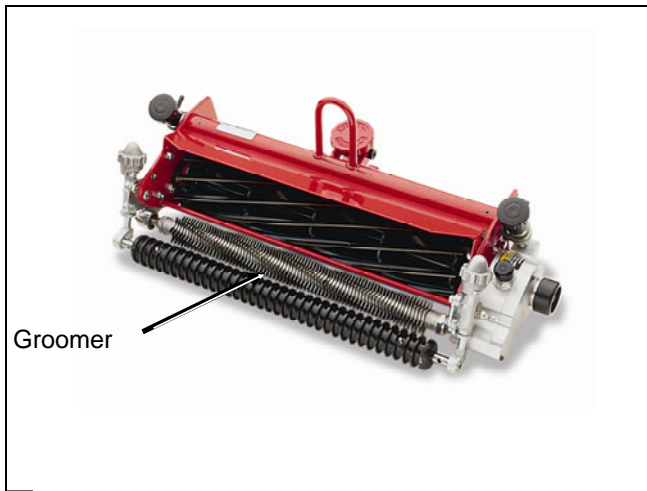

Groomers are intended to cut stolons, promote upright growth and stand grass up for a more uniform cut.

Warm season grasses such as Bermuda grass and others, but also Creeping Bentgrass, which is considered a cool season grass, all benefit from the use of groomers on a regular basis.

One word of caution; groomers are used in a straight line. Turning or engaging the turf with groomers on cleanup passes can cause some serious issues.



A new variation is the Broomer. The brush helps to stand the grass up better than the blades alone, along with knocking off dew to reduce clumping.



Because of the stoloniferous growth of some cultivars, the turf tends to be "grainy" as can be seen in the photo.

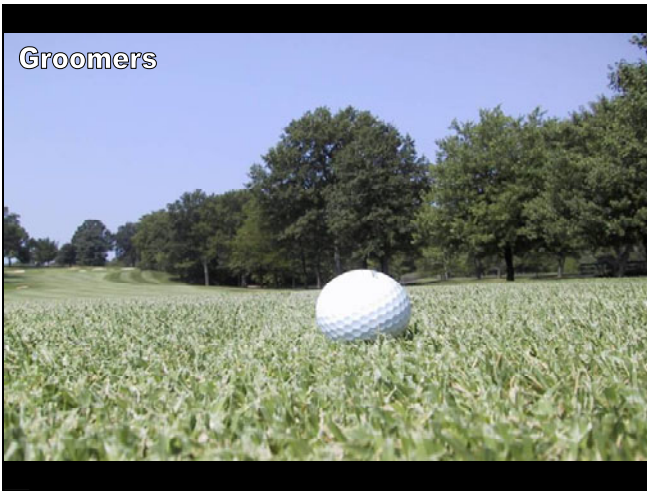

Because of the many leaves that are laying over, the lie of the ball is quite low and the roll is inconsistent.

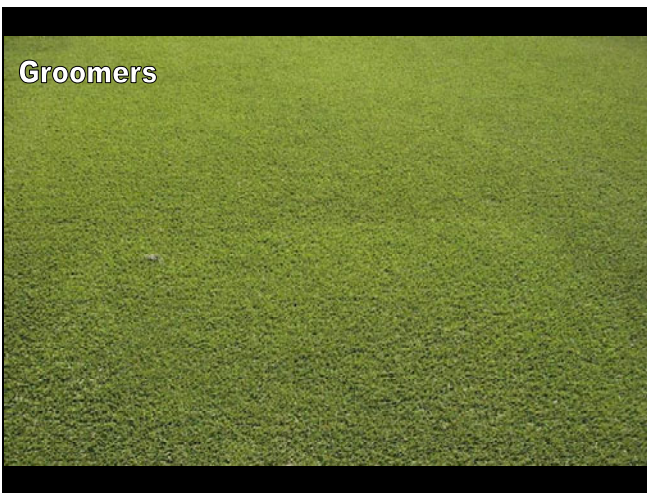

As can be seen in this photo, grooming can greatly improve the appearance of the turf area.

The precaution is that groomers are to be set just below the height of cut. Grooming does not contact the ground or thatch. Doing so can be very disruptive to the turf, have a negative effect on the appearance and possibly damage the equipment. Overly aggressive grooming is detrimental to the turf.

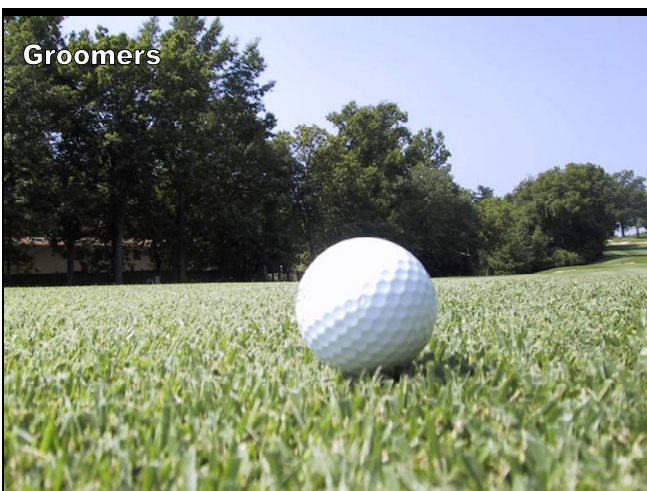

When grooming is done correctly and regularly it can have a dramatic effect on the turf and the result is a better lie. As you can see with a healthier upright growth, the lie of the ball is much higher on the turf.

IMPORTANT: Grooming is performed above the soil level. Grooming promotes vertical growth of the grass by cutting runners, or stolons, standing grass blades up and encouraging denser growth and deeper rooting. This can, in effect, yield a more even grass with less grain, for faster and truer action of the golf ball

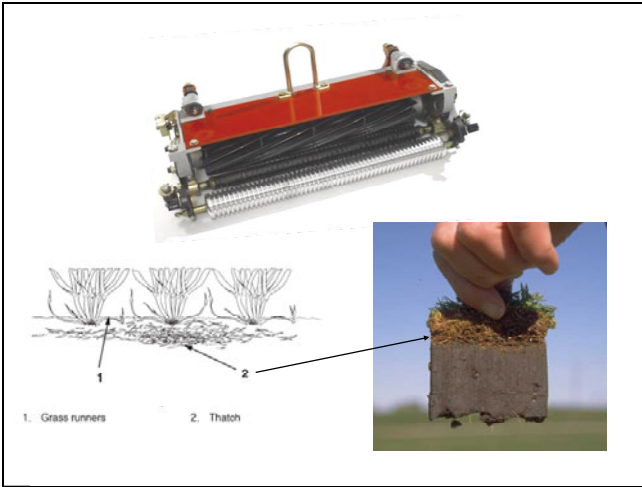

Grooming is similar to verti-cutting in its runner cutting action. Grooming blades however, should never penetrate the soil like verti-cutting or dethatching. Groomer blades are spaced closer together and are used more often than verti-cutters so that they are more effective in cutting runners and standing up the grass.

It is difficult to give precise recommendations on the use of groomers because so many variables affect the performance of grooming:

- Time of year and weather pattern
- General condition of the green
- Frequency of grooming/cutting
 - Number of cuttings per week and number of passes per cutting
- Height of cut
- Height of grooming
- How long grooming has been in use on a green
- Type of grass on the green
- Overall greens management program
 - Irrigation, fertilizing, spraying, coring, overseeding
- Traffic
- Stress periods
 - Temperature, humidity, traffic

IMPORTANT: Improper use or over-aggressive use of the grooming reel (such as too deep or too frequent grooming) may cause unnecessary stress on the turf, leading to severe damage to the green. Use the groomer cautiously.

It is important to determine the performance of the groomer before putting it into regular use on greens. We strongly suggest that a formal test procedure be used to determine the proper depth setting for your conditions.

It is difficult to give precise recommendations on the use of groomers because so many variables affect the performance of grooming.

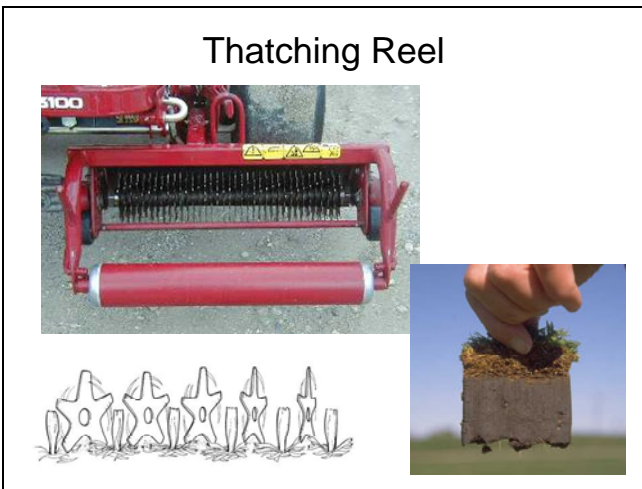

Here is an example of a thatching unit, on a triplex riding greens mower.

Thatch is the accumulation of organic material at the soil surface and comes primarily from stolen, rhizome and root tissue in warm season grasses. Thatching (vertical mowing) is a mechanical method of removing excess thatch. Please note that dethatching is very disruptive to turf. This mechanical removal does not address the cause of excess thatch.

Conclusion



This document has provided you with a basic knowledge of reel mower operating theory, set-up, adjustment, and maintenance.

This information will not only help you understand the how, but also give some insight into why some operating, adjustment, and maintenance procedures are so important.

Understanding that reel mowers are precision machines, requiring regular maintenance and adjustment, can help achieve attractive, consistent, aftercut appearance, while reducing downtime and operating costs.

Notes:



© Copyright – The Toro Company

Free Manuals Download Website

<http://myh66.com>

<http://usermanuals.us>

<http://www.somanuals.com>

<http://www.4manuals.cc>

<http://www.manual-lib.com>

<http://www.404manual.com>

<http://www.luxmanual.com>

<http://aubethermostatmanual.com>

Golf course search by state

<http://golfingnear.com>

Email search by domain

<http://emailbydomain.com>

Auto manuals search

<http://auto.somanuals.com>

TV manuals search

<http://tv.somanuals.com>