



GRASS COLLECTION SYSTEM

DESIGNED FOR:

**MODEL 22621223 - 24
TORO Z100 SERIES**



OPERATOR'S MANUAL

ASSEMBLY • OPERATION • MAINTENANCE

MANUAL PART#: Q0309

\$4.00

REV: 0

Download from [Www.Somanuals.com](http://www.Somanuals.com). All Manuals Search And Download.

PECO GRASS COLLECTION SYSTEM

TABLE OF CONTENTS

SECTION	PAGE	SECTION	PAGE
Safety	2	2-10 Adjustment Of The Hose Length	9
Safety Alert Symbols	3	2-11 Attachment Of The Upper Hose	9
Warranty	4	2-12 Attachment Of The Lower Hose To The	
I INTRODUCTION AND DESCRIPTION	5	Engine/Blower/Blade Assembly	9
1-1 Introduction	5	2-13 Attachment Of The Boot To The ZT Mower Deck	10
1-2 Description	5	2-14 Attachment Of The Lower Hose To The Boot	10
II PREPARATION FOR USE	5	2-15 Front Weight Assembly	10
2-1 Modification Of Zero Turn	5	2-16 Exhaust Diverter Installation	10
2-2 Attaching The Main Frame Assembly	5	2-17 Tips On Mowing With The Collection System	10
2-3 Attaching The Lift Handle To The Aluminum		III OPERATING INSTRUCTIONS	11
Grass Container	6	3-1 General Safety	11
2-4 Attaching The Aluminum Grass Container To		3-2 Operation	11
The ZT Mower	6	3-3 Unloading The Collection System	11
2-5 Aluminum Grass Container Inlet Attachment	6	IV MAINTENANCE	11
2-6 Adjustment Of The Dump Mechanism	6	4-1 Maintenance Checklist	11
2-7 Attachment Of The Outer Engine Mount Tube	6	V PARTS AND SERVICE	12
2-8 Engine Mount Arm Installation	9	5-1 Parts And Service Information	12
2-9 Engine/Blower/Blade Assembly Installation	9	Torque Specifications	13
		Notes	14-15

Outdoor Power Equipment Institute Recommendations

WARNING TO PURCHASERS OF INTERNAL COMBUSTION ENGINE EQUIPPED MACHINERY OR DEVICES IN THE STATE OF CALIFORNIA:

- 1.** Read the operator's manual carefully and familiarize yourself with the proper use of your attachment. Do not allow anyone who is not acquainted with the Safety Instructions to use your attachment.
- 2.** Know the controls and how to stop quickly. READ THE OPERATOR'S MANUAL!
- 3.** Do not allow children to operate the vehicle. Do not allow adults to operate it without proper instruction.
- 4.** Be especially watchful of children and pets darting into the area while operating.
- 5.** Keep your eyes and mind on your tractor while mowing or operating your attachment. Don't let others distract you.
- 6.** Do not attempt to operate your tractor or mower when not in the driver's seat.
- 7.** Always stop Vac blower when emptying the container.
- 8.** Stop tractor or mower engine and remove spark plug wire before removing or replacing hose, boot, blower cone, or performing any maintenance.
- 9.** Mow up and down the face of slopes (not steeper than 10 degrees); never across the face of the slope.
- 10.** It is recommended that the container be kept only half full when negotiating any slopes. Start mowing on slopes when the container is empty.
- 11.** Inspect your lawn and remove any foreign objects before mowing. Never deliberately run the mower across any foreign object.
- 12.** Wear ear protection if the noise level is offensive.
- 13.** Wear eye protection to prevent debris from damaging your eyes.

SAFETY

WARNING! NEVER operate the mower unless the discharge guard and either the deflector assembly or the vacuum collector adapter are fastened securely in place.

WARNING! Do not work around the mower deck boot or the blower area until you are certain that the mower blades and the blower impeller have stopped rotating.

WARNING! To avoid serious injury, perform maintenance on the vacuum collector; **ONLY AFTER STOPPING THE MOWER'S ENGINE AND WAITING FOR ALL MOVING PARTS TO COME TO A COMPLETE STOP.** Set the parking brake. Always remove the ignition key before beginning maintenance.

WARNING! For your own personal safety, **ALWAYS** mow **UP** and **DOWN** the face of slopes and **NEVER** across the face. **NEVER** attempt to mow excessively steep slopes, and use caution when turning on any slope.

Safety Alert Symbol



This Safety Alert Symbol means: **“ATTENTION! BECOME ALERT! YOUR SAFETY IS INVOLVED!”**

This symbol is used to call attention to safety precautions that should be followed by the operator to avoid accidents. When you see this symbol, carefully read the message that follows and heed its advice. Failure to comply with safety precautions could result in death or serious bodily injury.

Safety Signs

The signal words **DANGER**, **WARNING**, and **CAUTION** are used on the equipment safety signs. These words are intended to alert the viewer to the existence and the degree of hazard seriousness.



White letters on **RED**

This signal word indicates a potentially hazardous situation which, if not avoided, will result in death or serious injury.



Black letters on **ORANGE**

This signal word indicates a potentially hazardous situation which, if not avoided, could result in death or serious injury.

It may also be used to alert against unsafe practices.



Black letters on **YELLOW**

This signal word indicates a potentially hazardous situation exist which, if not avoided, will result in minor or moderate injury.

It may also be used to alert against unsafe practices.

PECO LIMITED WARRANTY FOR NEW PRODUCTS

A. WHAT IS WARRANTED?

Peco extends the following warranties to the original purchaser of each new Peco consumer product subject to the following limitations.

- 1. PRODUCT WARRANTY:** Any part of any consumer product, which is defective in material or workmanship as delivered to the purchaser will be repaired or replaced, as Peco elects, without charge for parts or labor, if the defect appears within 12 months from the date of delivery of the product to the original purchaser. **ALL DEFECTIVE PARTS MUST BE RETURNED TO PECO FOR INSPECTION TO DETERMINE VALIDITY OF WARRANTY CLAIMS.** Freight and mailing will be borne by the customer.
- 2. PARTS REPLACED DURING WARRANTY:** Any new Peco part which is furnished in performance of this warranty and is defective in material or workmanship as delivered to the purchaser will be repaired or replaced, as Peco elects, without charge if the defect appears within 90 days from the date of installation of such part or before the expiration of the original warranty period, whichever is later.

B. SECURING WARRANTY ADJUSTMENTS.

Call Peco for Return Authorization. Damaged or broken parts other than engines or batteries, must be returned to Peco, Inc., PO Box 1197, Arden, NC 28704 before any warranty adjustment can be authorized. At the time of requesting warranty adjustment, the purchaser must present evidence of the date of delivery of the product. The purchaser shall pay any charge for the product to and from Arden, NC.

C. ITEMS NOT COVERED BY PECO WARRANTY.

Engines and batteries attached to PECO products are covered under a separate warranty by the respective manufacturer.

D. UNAPPROVED ALTERATION OR MODIFICATION.

All obligations of Peco, Inc. under this warranty shall be terminated if products are altered or modified in ways not approved by Peco Inc.

E. ACCIDENTS AND NORMAL MAINTENANCE.

The warranty covers only defective material and workmanship. It does not cover depreciation or damage caused by normal wear, accident, improper use or abuse of products. The cost of normal maintenance and normal replacement of service items such as belts, cutting blades, hoses, etc., which are not defective shall be paid for by the purchaser.

F. NO REPRESENTATIONS ADDITIONAL WARRANTIES, DISCLAIMER.

Neither Peco Inc. nor any company affiliated with it makes any warranties, representations or promises as to the quality of performance of its products other than those set forth herein. Except as described above, Peco Inc. makes no other warranties **AND SPECIFICALLY DISCLAIMS ANY AND ALL IMPLIED WARRANTIES OF FITNESS AND MERCHANTABILITY.**

G. ANY MACHINE USED FOR RENTAL PURPOSES ARE GUARANTEED FOR 45 DAYS FROM DATE OF ORIGINAL SALE ONLY.

H. REMEDIED EXCLUSIVE.

The only remedies the purchaser has in connection with the breach or performance of any warranty on Peco Inc. consumer products are set forth above. In no event will Peco be liable for special incidental or consequential damages.

1. NO SERVICE CENTER WARRANTY.

The selling Service Center makes no warranty on his own on any item warranted by Peco Inc. unless he delivers to purchaser a separate written warranty certificate specifically warranting the item. The dealer has no authority to make any representation or promise on behalf of Peco or to modify the terms of this warranty in any way.

SECTION I

INTRODUCTION AND DESCRIPTION

1-1 Introduction

We are pleased to have you as a PeCo customer. Your collection system has been designed to give you a low maintenance, simple, and effective way to collect the grass clippings from your ZT mower. This manual is provided to give you the necessary instructions to properly mount and operate the collection system on your ZT mower. Please read this manual thoroughly. Understand what each control is for and how to use it. Observe all safety decal precautions on the machine and noted throughout the manual.

Note: all references made to right, left, front, rear, top or bottom are as viewed from the normal operator's position on the ZT mower.

1-2 Description

The collection system is designed for turf maintenance where there is a need to collect the grass clippings as the ZT mower cuts the turf. It is also good for picking up leaves and twigs in pre-season and post-season clean-up.

The engine/blower/blade assembly, is mounted on the right side of the unit. The blower draws grass clippings from the discharge area of the cutter deck up to the aluminum container mounted over the rear portion of the ZT frame. The operator can engage the engine/blower/blade assembly by starting the engine. Once the container is full of clippings, the operator can easily push and raise the lift handle, releasing the container's rear door and the container will pivot towards the ground.

Section II

PREPARATION FOR USE

2-1 Modification Of Zero Turn

Carefully dismantle wooden shipping crate from around the components. Cut retaining straps and separate the parts. The collection system will have various parts located inside. Remove and sort all parts for easy identification.

NOTE: before each step of assembly it will help to study the exploded drawings on pages 7 and 8.

Remove the rear heat guard from the mower by removing the (12) bolts and nuts that hold the heat guard in place.

Figure 1 Rear Heat Guard Removal

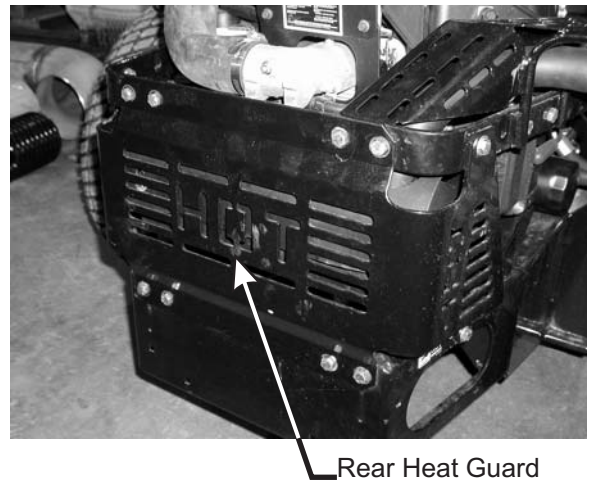

2-2 Attaching The Main Frame Assembly

Place the main frame assembly P#(A0403) (Figure 2) onto the rear of the mower and align the holes of the frame to where the heat guard was removed. Fasten by using (8) 5/16" x 1" hex bolts P#(K1154), (8) 5/16" flat washers P#(K0042) and (8) 5/16" flange nuts P#(K1178).

Figure 2 Main Frame Assy.

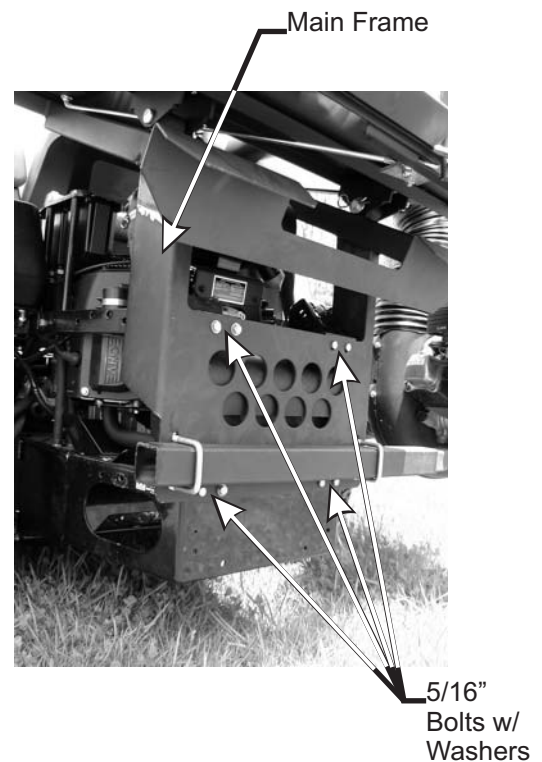

2-3 Attaching The Lift Handle To The Aluminum Grass Container

The various parts of the handle assembly P#(A0273) must be attached to the container frame. (Figure 4) shows the orientation and location of the components. Slide the lift handle into the slot in the handle mount bracket P#(B1730) on the grass container. It may be necessary to remove the handle grip P#(J0522) to allow the handle to fit through the slot.

Before attaching the handle, hook one end of the spring P#(J0176) into the hole on the underside of the handle. Hook the other end of the spring into the open hole in the handle mount bracket. Fasten the handle to the grass container frame by using (1) 3/8"-16 x 2" HHCS P#(K1208) and (2) 3/8"-16 flange nuts P#(K1215). At this point the handle can pivot back and forth in the slot of the handle mount bracket. With the handle in place, fasten the ball joint P#(K1442), (Figure 5) to the end of the latch rod P#(A0260). Tighten to approximately half way down the threads of the latch rod. Slide the ball joint into the hole on the latch hook P#(B1529). Use (1) 5/16"-24 hex nut P#(K1444) and (1) 5/16" lock washer P#(K0043) to fasten the ball joint to the latch hook. Attach the opposite end of the latch rod into the handle. Fasten the rod to the handle by using (1) 3/32" x 3/4" cotter pin P#(K0094). Adjust the rod to allow the hook to close the box door completely.

Refer to Figures 4,5,6,7, and 8 for exploded parts drawings and photographs of the complete assembly.

2-4 Attaching The Aluminum Grass Container To The ZT Mower

NOTE: IT IS RECOMMENDED FOR THREE PEOPLE TO ASSIST IN THE MOUNTING OF THE CONTAINER.

With three people available, two can lower the container onto the frame while the third person inserts the pivot pins P#(K0172) through the holes. Insert the pins from the outside to the inside. Secure with (1) 5/8" washer P#(K0058) and (1) 5/32" x 2-5/8" hair pin clip P#(K0088) per pivot pin.

Reattach the bottom ends of the door opening linkages to the main frame by using (1) Rue-Ring cotter pin P#(K1437) per side.

To test the functionality of the dump mechanism, pull the lift handle, (Figure 4), away from the unit, and lift upward. The door of the container should open and the box should pivot clockwise towards the ground.

2-5 Aluminum Grass Container Inlet Attachment

The inlet, (Figure 7), will need to be attached to the container. Open the container, push the inlet, from the inside of the container through the hole in the container to the outside. Orient the inlet opening to face the ground. Use the tabs P#(B1668) inside of the box to hold the inlet in place. It is recommended that two people perform this step. That way, one person on the inside of the container can position the tabs, while the other person tightens the bolts. Looking at the outside of the container, the most difficult tab to tighten down will be the tab at the 4-5 o'clock position. Tighten that tab first. Then proceed to tighten the others.

2-6 Adjustment Of The Dump Mechanism

The linkage may be adjusted in two places, at the adjusting screw P#(K1435) and the latch assembly items. See (Figures 4 & 7) for visual clarification. To change the door closure tightness, screw the adjusting screw in or out. To adjust the latch, change the length of the latch rod by screwing the latch adjusting ball joint in or out. The latch hook pivot should be in the middle of the slot in the latch hook pivot plate. Slide the pivot back or forth and then re-tighten.

2-7 Attachment Of The Outer Engine Mount Tube

Place the outer engine mount tube P#(B1117) against the rear of the main frame assembly (Figure 3), with the hole in the tube to the right hand side of the mower. Fasten to the main frame assembly by using (2) 3/8" u-bolts P#(K1432) and (4) 3/8" flange nuts P#(K1215).

Figure 3 Outer Engine Mount Tube Attachment

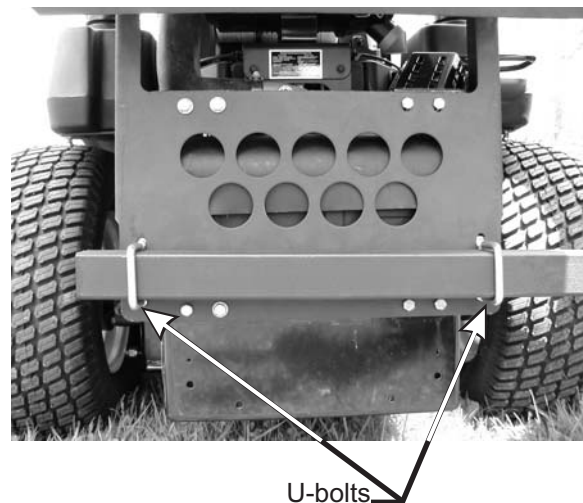

Figure 4
Lift Handle Assy.

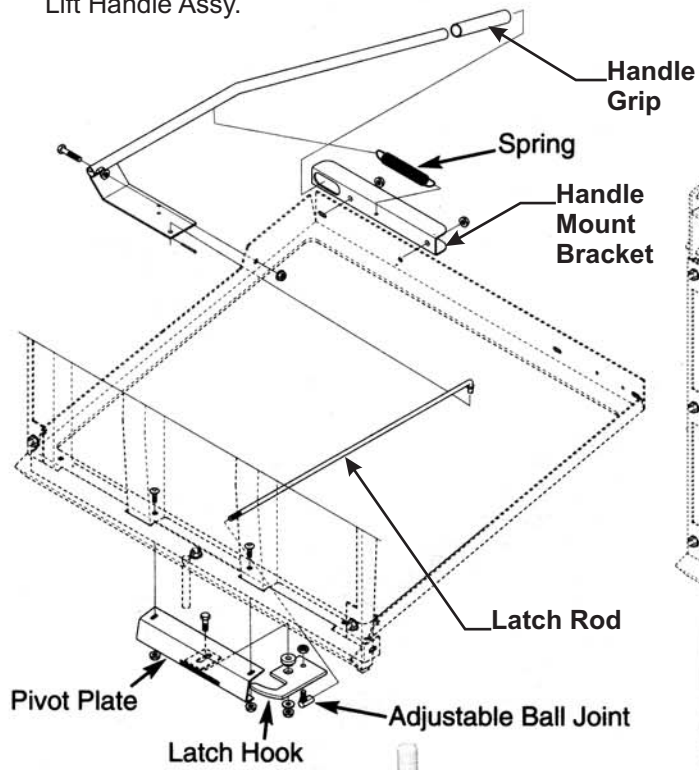

Figure 5
Aluminum Grass Container
With Handle Attached

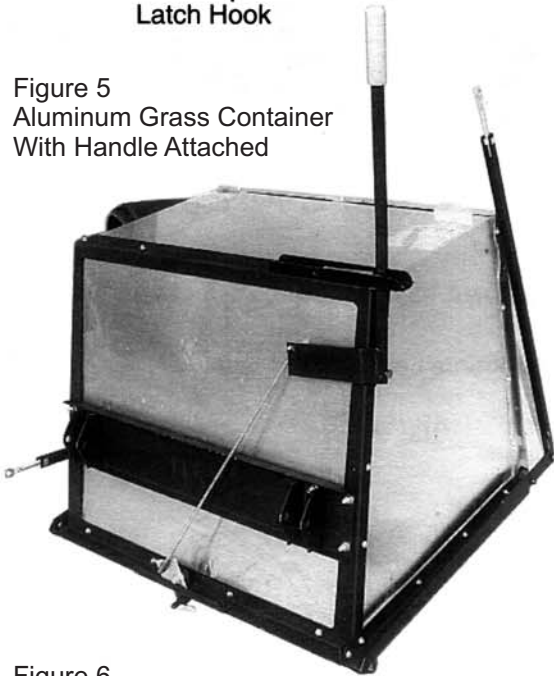

Figure 6
Latch Hook Mechanism Assembled

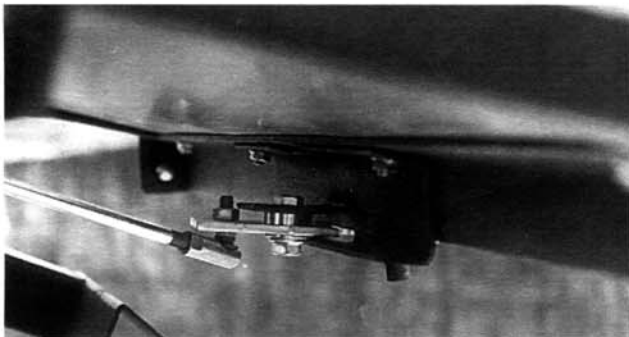

Figure 7 Aluminum Grass Container Assy.

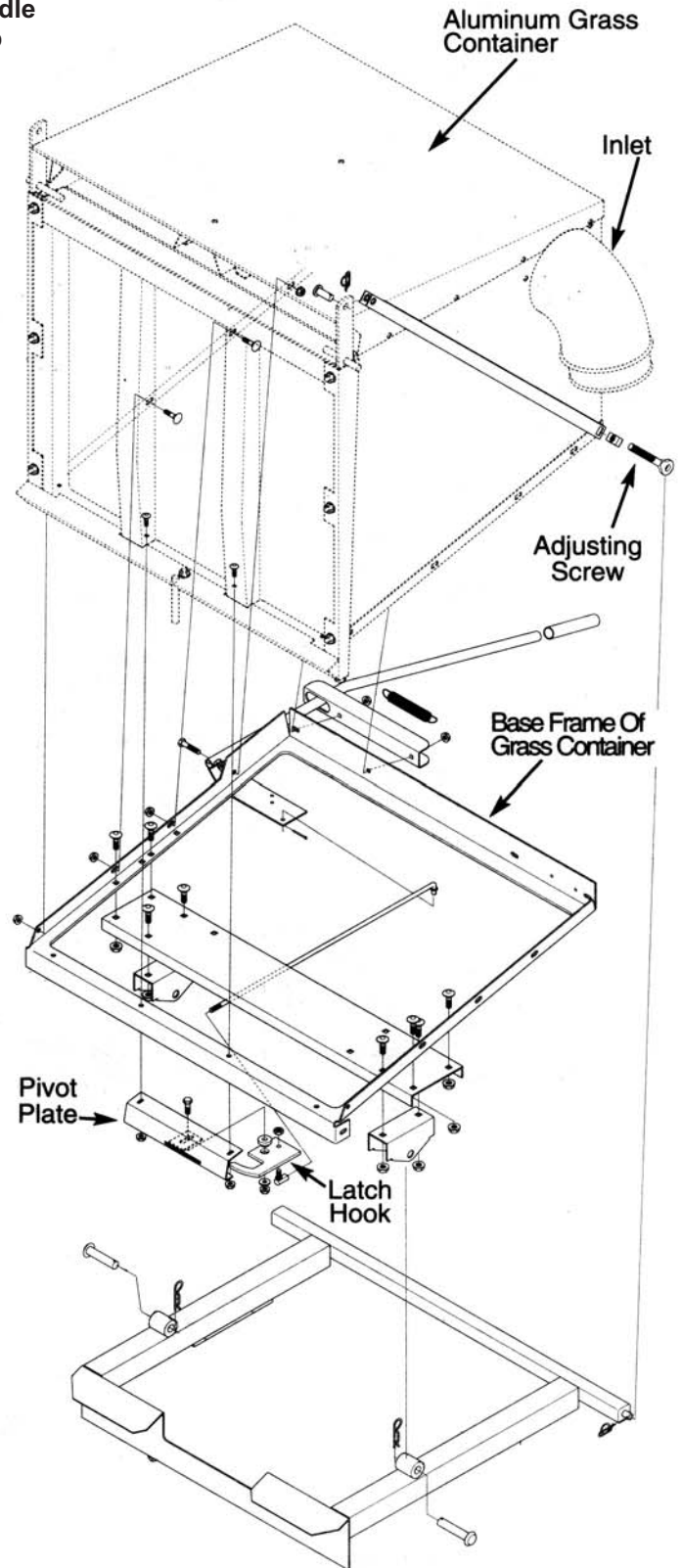

Figure 8 Aluminum Grass Container Exploded View

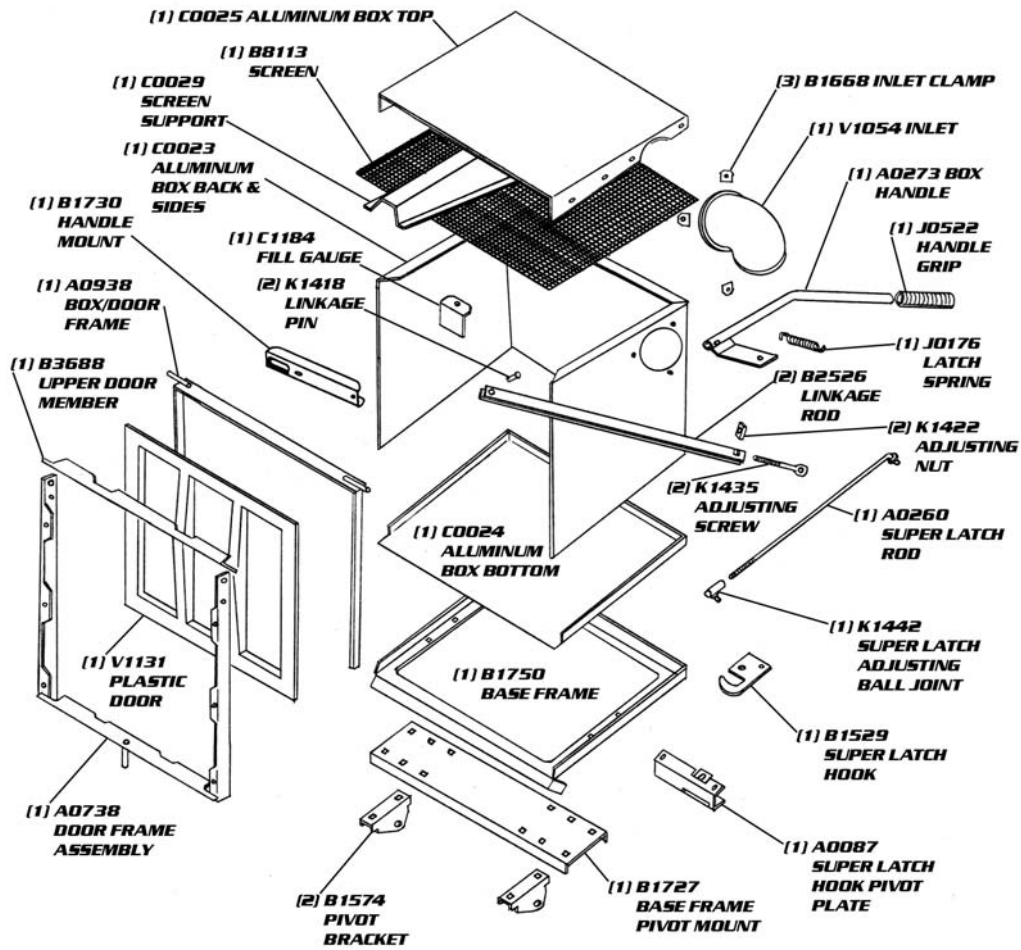
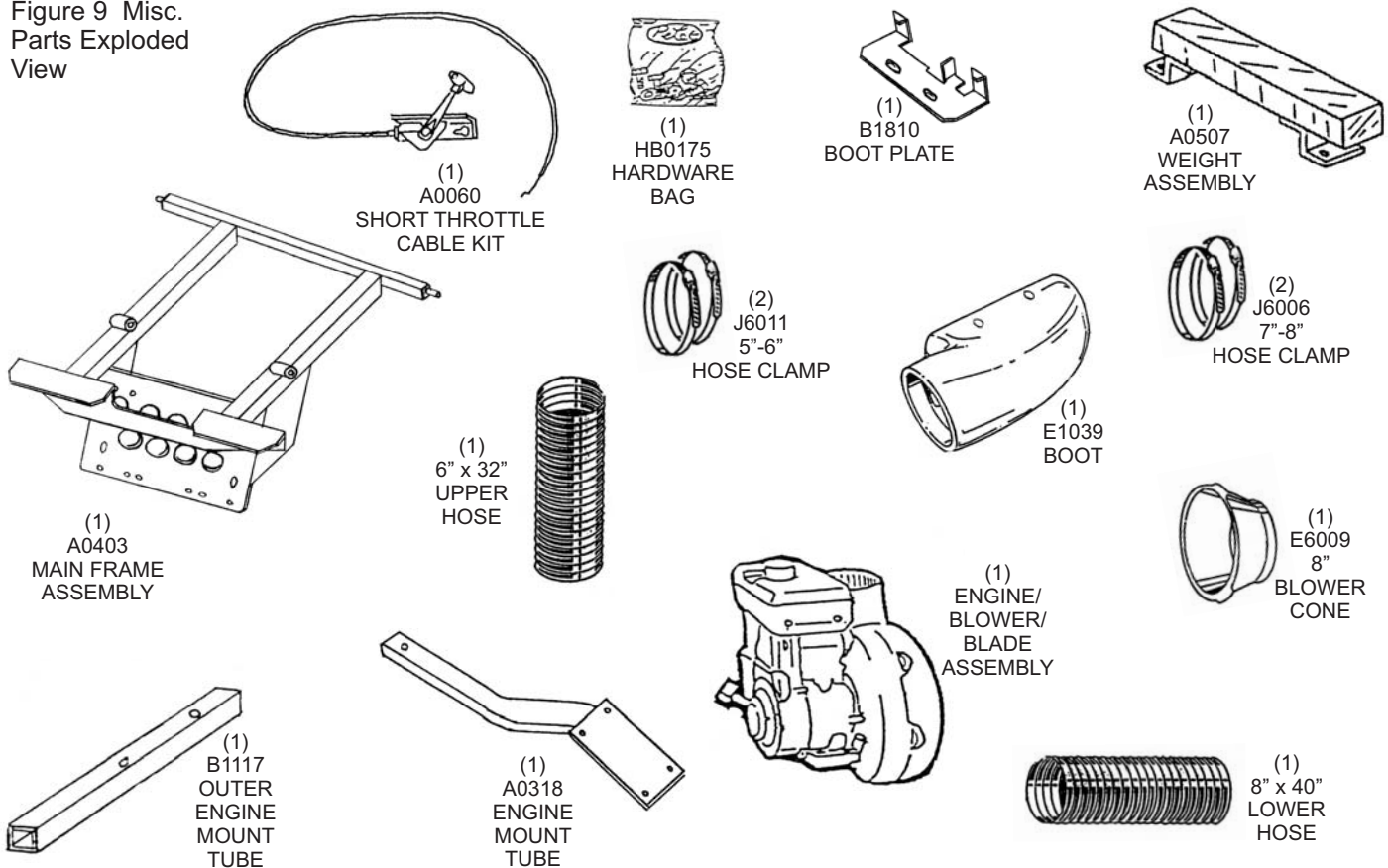

Figure 9 Misc. Parts Exploded View



2-8 Engine Mount Arm Installation

Slide the engine mount arm assembly (Figure 10) into the outer engine mount tube. Secure the engine mount arm assembly using (1) detent pin P#(J0248).

Figure 10 Engine Mount Arm

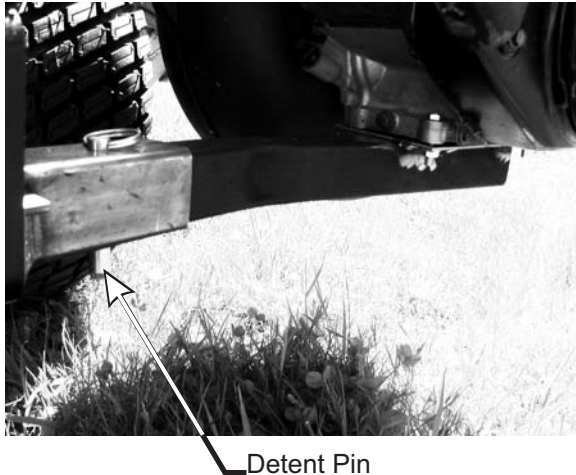

Detent Pin

2-9 Engine/Blower/Blade Assembly Installation

Place the engine/blower/blade assembly onto the engine mount arm assembly (Figure 11). Secure the engine/blower blade assembly to the engine mount arm assembly using (4) 5/16"-18 x 1-1/2" hex bolts P#(K1157) and (4) 5/16"-18 flange nuts P#(K1178).

Figure 11 Engine/Blower/Blade Installation



5/16" x 1-1/2" Bolt

2-10 Adjustment Of The Hose Length

THE HOSES IN STEPS 2-11 AND 2-12 MUST BE CUT TO FIT YOUR MACHINE. FOLLOW STEPS 2-11 AND 2-12. DO NOT CUT THE HOSES UNTIL YOU HAVE TRIED TO FIT THEM ON YOUR MACHINE. REMEMBER THAT THE HOSES HAVE TO BE LONG ENOUGH TO ALLOW FOR ENOUGH CLAMPING SURFACE BETWEEN THE INLET, BLOWER ASSEMBLY, AND THE DECK BOOT.

2-11 Attachment Of The Upper Hose

Slide a 5"-6" upper hose clamp P#(J6011) onto both ends of the 6" upper hose (Figure 12). Then slide one end of the 6" hose onto the inlet. Make sure there is about a two-inch overlap between the hose end and the container inlet. Proceed to slide the opposite end of the 6" hose onto the outlet of the blower assembly. See (Figure 12) for details. Make sure both ends of the hose are clearly attached to the inlet and the blower assembly inlet. Tighten the hose clamps.

2-12 Attachment Of The Lower Hose To The Engine/Blower/Blade Assembly

Slide a 7"-8" hose clamp P#(J6006) over both ends of the lower hose. Then proceed to slide the lower hose onto the blower cone. Tighten the hose clamp. The assembly should look like (Figure 12).

Figure 12 Hose Assembly

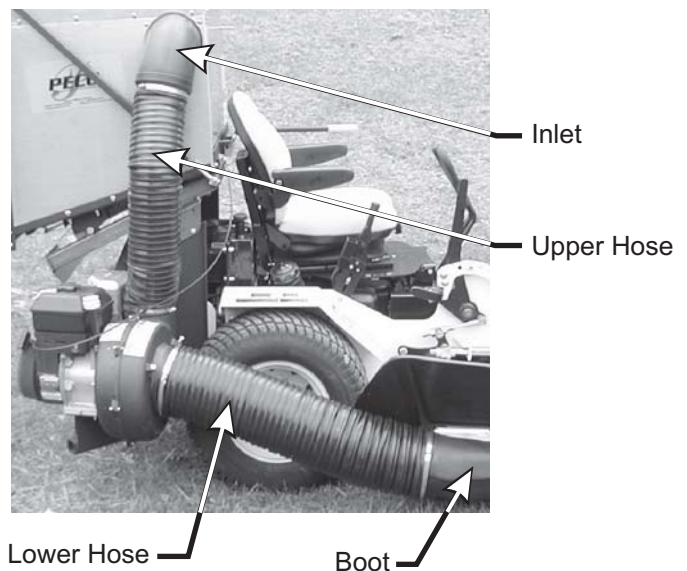

Inlet

Upper Hose

Lower Hose

Boot

2-13 Attachment Of The Boot To The ZT Mower Deck

To mount the boot plate P#(B1810) to the boot P#(E1039), use (2) 3/8" x 1" carriage bolts P#(K1182) and (2) 3/8" flange nuts P#(K1215). Be sure that, when fastening the boot and boot plate together, the head of the bolt is placed from the inside of the boot. This will prevent grass from collecting on the bolts. Hang the boot onto the mower deck (Figure 13). The slots in the boot plate will allow for adjustment left or right to achieve the proper fit for different size cutting decks. Once the boot is in place tighten the bolts and, if applicable, tighten the bolts of the mower's deflector shield and rotate the deflector towards the boot.

Figure 13

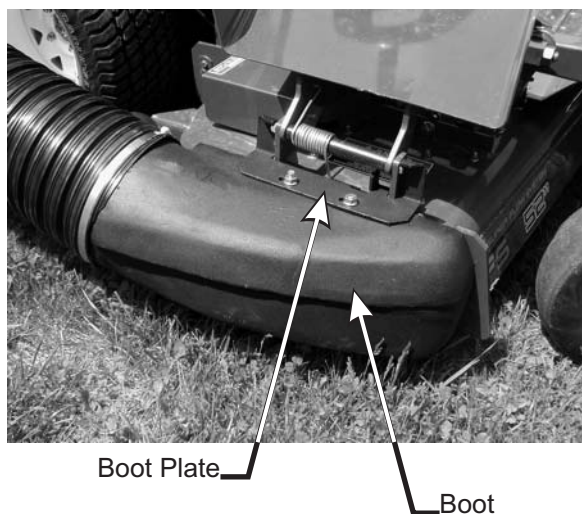

2-14 Attachment Of The Lower Hose To The Boot

Take the unattached end of the lower hose and slide it over the circular end of the boot. Use the lower hose clamp to secure the hose to the boot. (Figure 12).

2-15 Front Weight Assembly

Remove the (4) bolts from the front left and front right of the mower, near the casters (Figure 14). Once removed, place the weight assembly P#(A0507) where the bolts were removed and align the holes. NOTE: Have at least two people for lifting the weight into place. Fasten the weight assembly to the mower by using (2) 3/8" x 1" hex

Figure 14 Front Weight Assembly



2-16 Exhaust Diverter Installation

Attach the exhaust diverter provided P#(J0270) to the end of the mower's exhaust pointing downward to direct the exhaust fumes away from the vac engine. Once in position fasten by using (1) exhaust clamp kit P#(X1064).

2-17 Tips On Mowing With The Collection System

To obtain the maximum effectiveness from your collection system the tips listed below should be followed:

- * Watch your speed- Normal conditions will allow a speed of up to approximately 5 mph, but thick, heavy damp conditions will require reduced ground speed.
- * Mow with sharp blades- A sharp blade cuts cleaner.
- * Wet grass and leaves will decrease effectiveness and will increase horsepower requirements.
- * Mow at higher cutting heights- Remove and mulch no more than 2" of grass length with each mowing. (Experts recommend not cutting off more than 1/3 of the grass blade length at any given time.)
- * Mow twice, at different height settings, (high, then low), if grass is extra tall.
- * Remember that horsepower requirements will vary with the mowing conditions such as type and height of turf grass, moisture content, amount of leaves, whether the terrain is flat or hilly, etc.

SECTION III OPERATING INSTRUCTIONS

3-1 General Safety

Only qualified people familiar with this operator's manual and the ZT operator's manual should operate this machine.

3-2 Operation

- A. Perform BEFORE EACH USE maintenance list in paragraph 4-1.
- B. Start the engine/blower/blade assembly.
- B. Start ZT mower.
- C. With the ZT mower at high idle speed, engage the cutter deck.
- D. Proceed to operate the control levers of the ZT.

NOTE: If the collection system does not appear to be collecting the grass clippings; Disengage the deck, turn off the engine/blower/blade assembly and check the upper hose, lower hose, top screen, and boot for clogs.

3-3 Unloading The Collection System

NOTE: Press the tab, located behind the operator's left side, downward to feel if the collection system is full. If the container is full there will be resistance when depressing the tab.

- A. Stop the forward movement of the ZT mower.
- B. Disengage the cutter deck.
- C. Using the throttle cable slow the engine down to idle.
- D. Push the dump handle, on the left of the operator, away from the unit. While holding the handle pushed away, move the handle upward. The container door will swing upward and the container will rotate downward. The container will release it's contents.
- E. Once the contents of the container have fallen out, the container is ready to move back into it's normal operating position. With the handle in the 'away' position, pull the handle downward until it stops. Move the handle towards the center of the mower. This motion will allow the latch to lock back into collection position.

NOTE: If you do not hold the handle away from the mower as you pull the handle downward, the latch will not lock and the container can unexpectedly release the contents collected.

SECTION IV MAINTENANCE

4-1 Maintenance Checklist

Before each use:

1. Check blades and spindles to be sure that no foreign objects, such as wire or steel strapping bands, are wrapped around them.
2. Inspect blades for wear. Replace if necessary. If it is necessary to sharpen the blades, remove the blades from the spindles before sharpening. DO NOT sharpen blades while still attached to the mower.
3. Make sure all shields are in place and in good condition. Repair or replace any missing or damaged shields.
4. Listen for abnormal sounds, which might indicate loose parts, damaged bearings, or other damage. Correct any deficiency before continuing operation.
5. Check for wear or deterioration of the upper or lower hoses. If there are any portions of the hose that have been torn or worn through, replace with genuine PeCo parts.

After Each Use:

1. Clean all debris from machine especially from the container, and off of safety decals. Replace any missing or illegible decals
2. Inspect unit for worn or damaged components. Repair or replace before the next use. Any replacement component installed during repair shall include the components current safety decal specified by the manufacturers to be affixed to the component.

SECTION V

PARTS AND SERVICE

5-1 Parts And Service Information

PeCo collection system owners should record the name and telephone number of their Service Center. Your Service Center will be happy to supply replacement parts, accessories, and do any service or repairs to your collection system. If for any reason your Service Center is unable to service your collection system or supply replacement parts, contact PeCo and include the following information on the chart below.

THE SERIAL NUMBER PLATE IS LOCATED ON THE ALUMINUM BOX NEAR THE DUMP HANDLE

PECO	
OUTDOOR POWER EQUIPMENT	
Model Number	<input type="text"/>
Serial Number	<input type="text"/>
Arden, North Carolina 28704	

WRITE THE MODEL AND SERIAL NUMBER IN THE BOX ABOVE FOR FUTURE REFERENCE.

Tractor Model: _____

Engine Size: _____

Peco Vac Serial Number: _____

Date of purchase: ____/____/____

Dealer/Distributor Name: _____

Dealer's/Distributor's: _____ **State:** _____ **Zip:** _____

Phone Number: _____

Address: PeCo Inc.

P.O. Box 1197

Arden, NC 28704

Phone #: (828) 684-1234 or Toll Free: (800) 438-5823

Email: pecoinc1@bellsouth.net

TORQUE SPECIFICATIONS

Proper torque for American fasteners used on **Peco** equipment.
Recommended Torque in Foot Pounds (Newton Meters).*

AMERICAN Bolt Head Markings

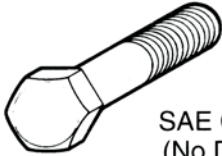

SAE Grade 2
(No Dashes)

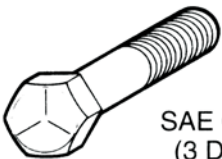

SAE Grade 5
(3 Dashes)

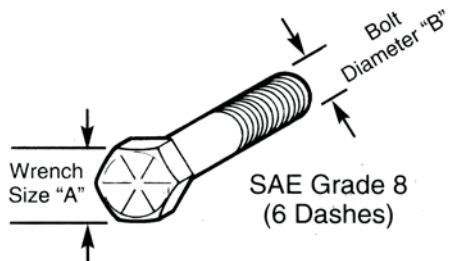

SAE Grade 8
(6 Dashes)

WRENCH SIZE (IN.) "A"	BOLT DIAMETER (IN.) "B" AND THREAD SIZE	SAE GRADE 2	SAE GRADE 5	SAE GRADE 8
7/16	1/4 - 20 UNC	6 (7)	8 (11)	12 (16)
7/16	1/4 - 28 UNF	6 (8)	10 (13)	14 (18)
1/2	5/16 - 18 UNC	11 (15)	17 (23)	25 (33)
1/2	5/16 - 24 UNF	13 (17)	19 (26)	27 (37)
9/16	3/8 - 16 UNC	20 (27)	31 (42)	44 (60)
9/16	3/8 - 24 UNF	23 (31)	35 (47)	49 (66)
5/8	7/16 - 14 UNC	32 (43)	49 (66)	70 (95)
5/8	7/16 - 20 UNF	36 (49)	55 (75)	78 (106)
3/4	1/2 - 13 UNC	49 (66)	76 (103)	106 (144)
3/4	1/2 - 20 UNF	55 (75)	85 (115)	120 (163)
7/8	9/16 - 12 UNC	70 (95)	109 (148)	153 (207)
7/8	9/16 - 18 UNF	79 (107)	122 (165)	172 (233)
15/16	5/8 - 11 UNC	97 (131)	150 (203)	212 (287)
15/16	5/8 - 18 UNF	110 (149)	170 (230)	240 (325)
1-1/8	3/4 - 10 UNC	144 (195)	266 (360)	376 (509)
1-1/8	3/4 - 16 UNF	192 (260)	297 (402)	420 (569)
1-5/16	7/8 - 9 UNC	166 (225)	430 (583)	606 (821)
1-5/16	7/8 - 14 UNF	184 (249)	474 (642)	668 (905)
1-1/2	1 - 8 UNC	250 (339)	644 (873)	909 (1232)
1-1/2	1 - 12 UNF	274 (371)	705 (955)	995 (1348)
1-1/2	1 - 14 UNF	280 (379)	721 (977)	1019 (1381)
1-11/16	1-1/8 - 7 UNC	354 (480)	795 (1077)	1288(1745)
1-11/16	1-1/8 - 12 UNF	397 (538)	890 (1206)	1444 (1957)
1-7/8	1-1/4 - 7 UNC	500 (678)	1120 (1518)	1817 (2462)
1-7/8	1-1/4 - 12 UNF	553 (749)	1241 (1682)	2013 (2728)
2-1/16	1-3/8 - 6 UNC	655 (887)	1470 (1992)	2382 (3228)
2-1/16	1-3/8 - 12 UNF	746 (1011)	1672 (2266)	2712 (3675)
2-1/4	1-1/2 - 6 UNC	870 (1179)	1950 (2642)	3161 (4283)
2-1/4	1-1/2 - 12 UNF	979 (1327)	2194 (2973)	3557 (4820)

METRIC

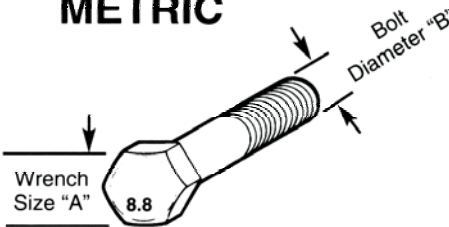

Numbers appearing on bolt heads indicate ASTM class.

Proper torque for metric fasteners used on **Peco** equipment.
Recommended torque in foot pounds (newton Meters).*

WRENCH SIZE (mm) "A"	BOLT DIA. (mm) "B"	ASTM 4.6	ASTM 8.8	ASTM 9.8	ASTM 10.9
8	5	1.8 (2.4)		5.1 (6.9)	6.5 (8.8)
10	6	3 (4)		8.7 (12)	11.1 (15)
13	8	7.3 (10)		21.1 (29)	27 (37)
16	10	14.5 (20)		42 (57)	53 (72)
18	12	25 (34)	74 (100)	73 (99)	93 (126)
21	14	40 (54)	118 (160)	116 (157)	148 (201)
24	16	62 (84)	167 (226)	181 (245)	230 (312)
30	20	122 (165)	325 (440)		449 (608)
33	22		443 (600)		611 (828)
36	24	211 (286)	563 (763)		778 (1054)
41	27		821 (1112)		1138 (1542)
46	30	418 (566)	1119 (1516)		1547 (2096)

*Use 75% of the specified torque value for plated fasteners. Use 85% of the specified torque values for lubricated fasteners.

NOTES

NOTES



**P.O. BOX 1197
ARDEN, NORTH CAROLINA 28704
(800) 438-5823 OR (828) 684-1234 FAX: (828) 684-0858
EMAIL: pecoinc1@bellsouth.net
WEBSITE: WWW.LAWNVC.COM**

Free Manuals Download Website

<http://myh66.com>

<http://usermanuals.us>

<http://www.somanuals.com>

<http://www.4manuals.cc>

<http://www.manual-lib.com>

<http://www.404manual.com>

<http://www.luxmanual.com>

<http://aubethermostatmanual.com>

Golf course search by state

<http://golfingnear.com>

Email search by domain

<http://emailbydomain.com>

Auto manuals search

<http://auto.somanuals.com>

TV manuals search

<http://tv.somanuals.com>