

# TOSHIBA

FILE NO. A04-015

## SERVICE MANUAL

# AIR-CONDITIONER

## SPLIT TYPE

***RAS-B10EKVP-E, RAS-B13EKVP-E  
/RAS-M14EAV-E***

***RAS-M10EKCVP-E, RAS-M13EKCVP-E  
/RAS-M14EACV-E***

***RAS-B10EKVP-E, RAS-B13EKVP-E,  
RAS-B16EKVP-E/RAS-M18EAV-E***

***RAS-M10EKCVP-E, RAS-M13EKCVP-E,  
RAS-M16EKCVP-E/RAS-M18EACV-E***

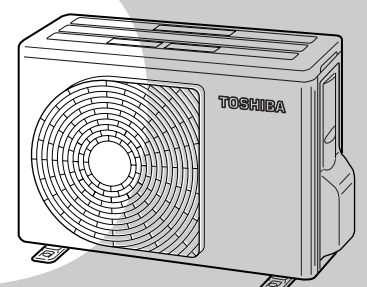
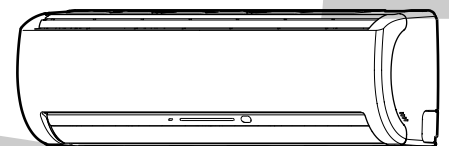

# CONTENTS

1. SAFETY PRECAUTIONS .....	3
2. SPECIFICATIONS.....	5
3. REFRIGERANT R410A .....	12
4. CONSTRUCTION VIEWS .....	20
5. WIRING DIAGRAM .....	22
6. SPECIFICATIONS OF ELECTRICAL PARTS .....	24
7. REFRIGERANT CYCLE DIAGRAM .....	26
8. CONTROL BLOCK DIAGRAM .....	31
9. OPERATION DESCRIPTION .....	34
10. INSTALLATION PROCEDURE .....	60
11. HOW TO DIAGNOSE THE TROUBLE.....	78
12. HOW TO REPLACE THE MAIN PARTS.....	101
13. EXPLODED VIEWS AND PARTS LIST .....	122
14. APPENDIX .....	Appendix-1

# 1. SAFETY PRECAUTIONS

## For general public use

Power supply cord of outdoor unit shall be more than 1.5 mm<sup>2</sup> (H07RN-F or 245IEC66) polychloroprene sheathed flexible cord.

- Read this "SAFETY PRECAUTIONS" carefully before servicing.
- The precautions described below include the important items regarding safety. Observe them without fail.
- After the servicing work, perform a trial operation to check for any problem.
- Turn off the main power supply switch (or breaker) before the unit maintenance.

## CAUTION

### New Refrigerant Air Conditioner Installation

#### • THIS AIR CONDITIONER ADOPTS THE NEW HFC REFRIGERANT (R410A) WHICH DOES NOT DESTROY OZONE LAYER.

R410A refrigerant is apt to be affected by impurities such as water, oxidizing membrane, and oils because the working pressure of R410A refrigerant is approx. 1.6 times of refrigerant R22. Accompanied with the adoption of the new refrigerant, the refrigeration machine oil has also been changed. Therefore, during installation work, be sure that water, dust, former refrigerant, or refrigeration machine oil does not enter into the new type refrigerant R410A air conditioner circuit.

To prevent mixing of refrigerant or refrigerating machine oil, the sizes of connecting sections of charging port on main unit and installation tools are different from those used for the conventional refrigerant units. Accordingly, special tools are required for the new refrigerant (R410A) units. For connecting pipes, use new and clean piping materials with high pressure fittings made for R410A only, so that water and/or dust does not enter. Moreover, do not use the existing piping because there are some problems with pressure fittings and possible impurities in existing piping.

## CAUTION

### TO DISCONNECT THE APPLIANCE FROM THE MAIN POWER SUPPLY

This appliance must be connected to the main power supply by a circuit breaker or a switch with a contact separation of at least 3 mm.

The installation fuse (25A D type ) must be used for the power supply line of this air conditioner.

## DANGER

#### • Ask an authorized dealer or qualified installation professional to install/maintain the air conditioner.

Inappropriate servicing may result in water leakage, electric shock or fire.

#### • TURN OFF MAIN POWER SUPPLY BEFORE ATTEMPTING ANY ELECTRICAL WORK. MAKE SURE ALL POWER SWITCHES ARE OFF. FAILURE TO DO SO MAY CAUSE ELECTRIC SHOCK.



#### DANGER: HIGH VOLTAGE

The high voltage circuit is incorporated.

Be careful to do the check service, as the electric shock may be caused in case of touching parts on the P.C. board by hand.

- CORRECTLY CONNECT THE CONNECTING CABLE. IF THE CONNECTING CABLE IS INCORRECTLY CONNECTED, ELECTRIC PARTS MAY BE DAMAGED.
- CHECK THAT THE EARTH WIRE IS NOT BROKEN OR DISCONNECTED BEFORE SERVICE AND INSTALLATION. FAILURE TO DO SO MAY CAUSE ELECTRIC SHOCK.
- DO NOT INSTALL NEAR CONCENTRATIONS OF COMBUSTIBLE GAS OR GAS VAPORS. FAILURE TO FOLLOW THIS INSTRUCTION CAN RESULT IN FIRE OR EXPLOSION.
- TO PREVENT THE INDOOR UNIT FROM OVERHEATING AND CAUSING A FIRE HAZARD, PLACE THE UNIT WELL AWAY (MORE THAN 2 M) FROM HEAT SOURCES SUCH AS RADIATORS, HEAT REGISTORS, FURNACE, STOVES, ETC.
- WHEN MOVING THE AIR-CONDITIONER FOR INSTALLATION IN ANOTHER PLACE, BE VERY CAREFUL NOT TO ALLOW THE SPECIFIED REFRIGERANT (R410A) TO BECOME MIXED WITH ANY OTHER GASEOUS BODY INTO THE REFRIGERATION CIRCUIT. IF AIR OR ANY OTHER GAS IS MIXED IN THE REFRIGERANT, THE GAS PRESSURE IN THE REFRIGERATION CIRCUIT WILL BECOME ABNORMALLY HIGH AND IT MAY RESULT IN THE PIPE BURSTING AND POSSIBLE PERSONNEL INJURIES.
- IN THE EVENT THAT THE REFRIGERANT GAS LEAKS OUT OF THE PIPE DURING THE SERVICE WORK AND THE INSTALLATION WORK, IMMEDIATELY LET FRESH AIR INTO THE ROOM. IF THE REFRIGERANT GAS IS HEATED, SUCH AS BY FIRE, GENERATION OF POISONOUS GAS MAY RESULT.

## WARNING

- Never modify this unit by removing any of the safety guards or by-pass any of the safety interlock switches.
- Do not install in a place which cannot bear the weight of the unit. Personal injury and property damage can result if the unit falls.
- **After the installation work, confirm that refrigerant gas does not leak.**  
If refrigerant gas leaks into the room and flows near a fire source, such as a cooking range, noxious gas may generate.
- **The electrical work must be performed by a qualified electrician in accordance with the Installation Manual. Make sure the air conditioner uses an exclusive circuit.**  
An insufficient circuit capacity or inappropriate installation may cause fire.
- **When wiring, use the specified cables and connect the terminals securely to prevent external forces applied to the cable from affecting the terminals.**
- **Be sure to provide grounding.**  
Do not connect ground wires to gas pipes, water pipes, lightning rods or ground wires for telephone cables.
- **Conform to the regulations of the local electric company when wiring the power supply.**  
Inappropriate grounding may cause electric shock.

## CAUTION

- Exposure of unit to water or other moisture before installation may result in an electrical short. Do not store in a wet basement or expose to rain or water.
- Do not install in a place that can increase the vibration of the unit. Do not install in a place that can amplify the noise level of the unit or where noise or discharged air might disturb neighbors.
- To avoid personal injury, be careful when handling parts with sharp edges.
- **Perform the specified installation work to guard against an earthquake.**  
If the air conditioner is not installed appropriately, accidents may occur due to the falling unit.

## For Reference:

If a heating operation would be continuously performed for a long time under the condition that the outdoor temperature is 0°C or lower, drainage of defrosted water may be difficult due to freezing of the bottom plate, resulting in a trouble of the cabinet or fan.

It is recommended to procure an anti freeze heater locally for a safety installation of the air conditioner.

For details, contact the dealer.

## 2. SPECIFICATIONS

The indoor and outdoor units that can be used in combination are shown in the tables below.

**Table of models that can be connected**

Type	Outdoor unit	Indoor unit		
Heat pump	RAS-M14EAV-E	RAS-B10EKVP-E	RAS-B13EKVP-E	
		RAS-M10UKV-E3	RAS-M13UKV-E3	
		RAS-M10YDV-E	RAS-M13YDV-E	
	RAS-M18EAV-E	RAS-B10EKVP-E	RAS-B13EKVP-E	RAS-B16EKVP-E
		RAS-M10UKV-E3	RAS-M13UKV-E3	RAS-M16UKV-E3
		RAS-M10YDV-E	RAS-M13YDV-E	RAS-M16YDV-E
Cooling-only	RAS-M14EACV-E	RAS-M10EKCV-E	RAS-M13EKCV-E	
		RAS-M10UKCV-E3	RAS-M13UKCV-E3	
		RAS-M10YDCV-E	RAS-M13YDCV-E	
	RAS-M18EACV-E	RAS-M10EKCV-E	RAS-M13EKCV-E	RAS-M16EKCV-E
		RAS-M10UKCV-E3	RAS-M13UKCV-E3	RAS-M16UKCV-E3
		RAS-M10YDCV-E	RAS-M13YDCV-E	RAS-M16YDCV-E

**Table of models that can be used in combination**

Type	Outdoor unit	Combinations of indoor unit models that can be connected
Heat pump	RAS-M14EAV-E	10+10, 10+13
	RAS-M18EAV-E	10+10, 10+13, 10+16, 13+13
Cooling-only	RAS-M14EACV-E	10+10, 10+13
	RAS-M18EACV-E	10+10, 10+13, 10+16, 13+13

### NOTES

A 1-room connection is not an option for the indoor units (you cannot connect only one indoor unit). A 2-room connection must always be used for the indoor units (you must connect two indoor units).

With the RAS-M14EAV-E and RAS-M14EACV-E outdoor unit models, the 13 + 13 combination is not an option.

With the RAS-M18EAV-E and RAS-M18EACV-E outdoor unit models, the 13 + 16 or 16 + 16 combination is not an option.

The contents noted in this service manual limit the indoor units to the RAS-B10EKVP-E, RAS-B13EKVP-E, RAS-B16EKVP-E, RAS-M10EKCV-E, RAS-M13EKCV-E and RAS-M16EKCV-E. For other indoor units that can also be used in combination, see the service manual of each indoor unit.

Indoor Unit		File No.
RAS-M10UKV-E3	RAS-M10UKCV-E3	SVM-04015
RAS-M13UKV-E3	RAS-M13UKCV-E3	
RAS-M16UKV-E3	RAS-M16UKCV-E3	
RAS-M10YDV-E	RAS-M10YDCV-E	A02-010
RAS-M13YDV-E	RAS-M13YDCV-E	
RAS-M16YDV-E	RAS-M16YDCV-E	

## 2-1-1 Specifications

### Heat pump models

Unit model	Indoor		RAS-B10EKVP-E, RAS-B13EKVP-E, RAS-B16EKVP-E					
	Outdoor		RAS-M14EAV-E		RAS-M18EAV-E			
Cooling Capacity (kW)			4.0		5.2			
Cooling Capacity range (kW)			1.4 - 4.5		1.4 - 6.2			
Heating Capacity (kW)			4.4		6.7			
Heating Capacity range (kW)			0.9 - 5.2		0.9 - 8.5			
Power supply			220~240V-1Ph-50Hz / 220V-1Ph-60Hz					
Electric characteristics	Indoor (220V/230V/240V)	Unit model	RAS-B10EKVP-E		RAS-B13EKVP-E		RAS-B16EKVP-E(*1)	
		Running Current (A)	0.15		0.15		0.15	
		Power Consumption (W)	30		30		30	
		Power factor (%)	91/87/83		91/87/83		91/87/83	
	Outdoor (220V/230V/240V)	Unit model	RAS-M14EAV-E		RAS-M18EAV-E			
		Operation mode	Cooling		Heating		Cooling	Heating
		Running current (A)	4.87/4.64/4.44		4.43/4.23/4.04		7.12/6.80/6.50	8.28/7.91/7.57
		Power Consumption (W)	1020		950		1540	1790
		Power factor (%)	95		97		98	98
		Starting current (A)	5.17/4.94/4.74				7.42/7.10/6.80	
COP(Cooling/Heating)			3.70/4.36		3.25/3.62			
Operating noise dB(A)	Indoor (Cooling/Heating)	Unit model	RAS-B10EKVP-E		RAS-B13EKVP-E		RAS-B16EKVP-E(*1)	
		High	42/43		43/44		45/45	
		Medium	33/34		34/35		36/36	
		Low	27/27		27/27		29/29	
	Outdoor (Cooling/Heating)	Unit model	RAS-M14EAV-E		RAS-M18EAV-E			
		2 indoor units operating	46/48		48/50			
Indoor unit	Unit model	RAS-B10EKVP-E		RAS-B13EKVP-E		RAS-B16EKVP-E(*1)		
	Dimension (mm)	Hight	250		250		250	
		Width	790		790		790	
		Depth	215		215		215	
	Net weight (kg)	9		9		9		
	Fan motor output (W)	30		30		30		
	Air flow rate (m³/h) (Cooling/Heating)	550/610		560/640		640/660		
Outdoor unit	Unit model	RAS-M14EAV-E		RAS-M18EAV-E				
	Dimension (mm)	Hight	550		550			
		Width	780		780			
		Depth	290		290			
	Net weight (kg)	36		40				
	Compressor	Motor output (W)	750		1100			
		Type	Twin rotary type with DC-inverter variable speed control					
		Model	DA111A1F-20F1		DA130A1F-25F			
	Fan motor output (W)	43		43				
	Air flow rate (m³/h)	1820		2100				
Type	Flare connection		Flare connection					
Piping connection	Indoor unit	Unit model	RAS-B10EKVP-E		RAS-B13EKVP-E		RAS-B16EKVP-E (*1)	
		Liquid side	Ø6.35		Ø6.35		Ø6.35	
		Gas side	Ø9.52		Ø9.52		Ø12.7	
	Outdoor unit	Unit model	RAS-M14EAV-E		RAS-M18EAV-E			
		Liquid side/gas side	Ø6.35 / 9.52		Ø6.35 / 9.52			
	Maximum length (per unit) (m)	20		20				
	Maximum length (total) (m)	30		30				
	Maximum chargeless length(total) (m)	20		20				
	Maximum height difference (m)	10		10				
	Additional refrigerant	20g/m (pipe length 21m to 30m)		20g/m (pipe length 21m to 30m)				
	Name of refrigerant	R410A		R410A				
	Weight (kg)	0.90		1.20				
	Wiring connection	Power supply	3 Wires : includes earth					
Interconnection		4 Wires : includes earth						
Usable temperature range (°C)	Indoor (Cooling/Heating)	21 to 32/0 to 27						
	Outdoor (Cooling/Heating)	5 to 43/-10 to 24						
Accessory	Indoor unit	Unit model	RAS-B10EKVP-E		RAS-B13EKVP-E		RAS-B16EKVP-E(*1)	
		Installation plate	1		1		1	
		Wireless remote controller	1		1		1	
		Batteries	2		2		2	
		Remote control holder	1		1		1	
		Zeolite-plus filter	1		1		1	
		Plasma Pure filter	1		1		1	
		Remote controller holder mounting screw	2 (Ø3.1x16L)		2 (Ø3.1x16L)		2 (Ø3.1x16L)	
		Owner's manual	1		1		1	
		Mounting screw	6 (Ø4x25L)		6 (Ø4x25L)		6 (Ø4x25L)	
		Installation manual	1		1		1	
		Outdoor unit	Unit model	RAS-M14EAV-E		RAS-M18EAV-E		
	Installation manual		1		1			
	Specifications		1		1			
	Drain nipple		1		1			
	Water-proof rubber cap	2		2				

- (\*1) The RAS-B16EKVP-E cannot be used in combination with the RAS-M14EAV-E.
- For performance when each indoor unit is combined with other unit, refer to the separate table.
- The specifications may be subject to change without notice for purpose of improvement.

## 2-1-2 Specifications

### Cooling-only models

Unit model	Indoor		RAS-M10EKCVP-E, RAS-M13EKCVP-E, RAS-M16EKCVP-E							
	Outdoor		RAS-M14EACV-E		RAS-M18EACV-E					
Cooling Capacity (kW)			4.0		5.2					
Cooling Capacity range (kW)			1.4 - 4.5		1.4 - 6.2					
Heating Capacity (kW)			-		-					
Heating Capacity range (kW)			-		-					
Power supply			220-240V-1Ph-50Hz / 220V-1Ph-60Hz							
Electric characteristics	Indoor (220V/230V/240V)	Unit model	RAS-M10EKCVP-E		RAS-M13EKCVP-E		RAS-M16EKCVP-E(*1)			
		Running Current (A)	0.15		0.15		0.15			
		Power Consumption (W)	30		30		30			
		Power factor (%)	91/87/83		91/87/83		91/87/83			
	Outdoor (220V/230V/240V)	Unit model	RAS-M14EACV-E			RAS-M18EACV-E				
		Operation mode	Cooling		Heating		Cooling		Heating	
		Running current (A)	4.87/4.64/4.44		-		7.12/6.80/6.50		-	
		Power Consumption (W)	1020		-		1540		-	
		Power factor (%)	95		-		98		-	
		Starting current (A)	5.17/4.94/4.74			7.42/7.10/6.80				
COP(Cooling/Heating)				3.70/-		3.25/-				
Operating noise dB(A)	Indoor (Cooling/Heating)	Unit model	RAS-M10EKCVP-E		RAS-M13EKCVP-E		RAS-M16EKCVP-E(*1)			
		High	42/-		43/-		45/-			
		Medium	33/-		34/-		36/-			
		Low	27/-		27/-		29/-			
	Outdoor (Cooling/Heating)	Unit model	RAS-M14EACV-E			RAS-M18EACV-E				
		2 indoor units operating	46/-			48/-				
Indoor unit	Unit model	RAS-M10EKCVP-E		RAS-M13EKCVP-E		RAS-M16EKCVP-E(*1)				
	Dimension (mm)	Hight	250		250		250			
		Width	790		790		790			
		Depth	215		215		215			
	Net weight (kg)	9		9		9				
	Fan motor output (W)	30		30		30				
	Air flow rate (m³/h) (Cooling/Heating)	550/-		560/-		640/-				
Outdoor unit	Unit model	RAS-M14EACV-E			RAS-M18EACV-E					
	Dimension (mm)	Hight	550			550				
		Width	780			780				
		Depth	290			290				
	Net weight (kg)	36			40					
	Compressor	Motor output (W)	750			1100				
		Type	Twin rotary type with DC-inverter variable speed control							
		Model	DA111A1F-20F1			DA130A1F-25F				
	Fan motor output (W)	43			43					
	Air flow rate (m³/h)	1820			2100					
Type	Flare connection			Flare connection						
Piping connection	Indoor unit	Unit model	RAS-M10EKCVP-E		RAS-M13EKCVP-E		RAS-M16EKCVP-E (*1)			
		Liquid side	Ø6.35		Ø6.35		Ø6.35			
		Gas side	Ø9.52		Ø9.52		Ø12.7			
	Outdoor unit	Unit model	RAS-M14EACV-E			RAS-M18EACV-E				
		Liquid side/gas side	Ø6.35 / 9.52			Ø6.35 / 9.52				
		Maximum length (per unit) (m)	20			20				
	Maximum length (total) (m)	30			30					
	Maximum chargeless length(total) (m)	20			20					
	Maximum height difference (m)	10			10					
	Additional refrigerant	20g/m (pipe length 21m to 30m)			20g/m (pipe length 21m to 30m)					
	Name of refrigerant	R410A			R410A					
	Weight (kg)	0.90			1.20					
	Wiring connection	Power supply	3 Wires : includes earth							
Interconnection		4 Wires : includes earth								
Usable temperature range (°C)	Indoor (Cooling/Heating)	21 to 32/0 to 27								
	Outdoor (Cooling/Heating)	5 to 43/-10 to 24								
Accessory	Indoor unit	Unit model	RAS-M10EKCVP-E		RAS-M13EKCVP-E		RAS-M16EKCVP-E(*1)			
		Installation plate	1		1		1			
		Wireless remote controller	1		1		1			
		Batteries	2		2		2			
		Remote control holder	1		1		1			
		Zeolite-plus filter	1		1		1			
		Plasma Pure filter	1		1		1			
		Remote controller holder mounting screw	2 (Ø3.1x16L)		2 (Ø3.1x16L)		2 (Ø3.1x16L)			
		Owner's manual	1		1		1			
		Mounting screw	6 (Ø4x25L)		6 (Ø4x25L)		6 (Ø4x25L)			
		Installation manual	1		1		1			
		Outdoor unit	Unit model	RAS-M14EACV-E			RAS-M18EACV-E			
	Installation manual		1			1				
	Specifications		1			1				
	Drain nipple		0			0				
Water-proof rubber cap	0			0						

- (\*1) The RAS-M16EKCVP-E cannot be used in combination with the RAS-M14EACV-E.
- For performance when each indoor unit is combined with other unit, refer to the separate table.
- The specifications may be subject to change without notice for purpose of improvement.

## 2-2 Performance specifications combinations of indoor unit

<Cooling> RAS-M14EAV-E, RAS-M14EACV-E

Operation Mode	Volts	Operation Status	Operating indoor unit		Unit capacity (kW)		Capacity (kW)	Running current	Power Consumption
	V		A	B	A	B	kW	A	W
Cooling	220	1 unit	10	–	2.5	–	2.5 (1.1 to 3.2)	3.05 (1.10 to 4.30)	570 (170 to 880)
			13	–	3.5	–	3.5 (1.1 to 3.8)	5.26 (1.10 to 6.06)	1100 (170 to 1280)
		2 units	10	10	1.95	1.95	3.9 (1.4 to 4.4)	5.12 (1.49 to 6.11)	1070 (230 to 1290)
			13	10	2.33	1.67	4.0 (1.4 to 4.5)	5.17 (1.49 to 6.16)	1080 (230 to 1300)
	230	1 unit	10	–	2.5	–	2.5 (1.1 to 3.2)	2.92 (1.06 to 4.11)	570 (170 to 880)
			13	–	3.5	–	3.5 (1.1 to 3.8)	5.03 (1.06 to 5.80)	1100 (170 to 1280)
		2 units	10	10	1.95	1.95	3.9 (1.4 to 4.4)	4.90 (1.43 to 5.84)	1070 (230 to 1290)
			13	10	2.33	1.67	4.0 (1.4 to 4.5)	4.94 (1.43 to 5.89)	1080 (230 to 1300)
	240	1 unit	10	–	2.5	–	2.5 (1.1 to 3.2)	2.79 (1.01 to 3.94)	570 (170 to 880)
			13	–	3.5	–	3.5 (1.1 to 3.8)	4.82 (1.01 to 5.56)	1100 (170 to 1280)
		2 units	10	10	1.95	1.95	3.9 (1.4 to 4.4)	4.69 (1.37 to 5.60)	1070 (230 to 1290)
			13	10	2.33	1.67	4.0 (1.4 to 4.5)	4.74 (1.37 to 5.64)	1080 (230 to 1300)

<Heating> RAS-M14EAV-E

Operation Mode	Volts	Operation Status	Operating indoor unit		Unit capacity (kW)		Capacity (kW)	Running current	Power Consumption
	V		A	B	A	B	kW	A	W
Heating	220	1 unit	10	–	3.2	–	3.2 (0.5 to 4.4)	4.07 (0.84 to 6.00)	850 (130 to 1280)
			13	–	4.2	–	4.2 (0.5 to 4.7)	5.86 (0.84 to 6.33)	1250 (130 to 1350)
		2 units	10	10	2.15	2.15	4.3 (0.9 to 5.1)	4.59 (1.10 to 5.76)	980 (170 to 1230)
			13	10	2.50	1.90	4.4 (0.9 to 5.2)	4.73 (1.10 to 5.86)	1010 (170 to 1250)
	230	1 unit	10	–	3.2	–	3.2 (0.5 to 4.4)	3.89 (0.81 to 5.74)	850 (130 to 1280)
			13	–	4.2	–	4.2 (0.5 to 4.7)	5.60 (0.81 to 6.05)	1250 (130 to 1350)
		2 units	10	10	2.15	2.15	4.3 (0.9 to 5.1)	4.39 (1.06 to 5.51)	980 (170 to 1230)
			13	10	2.50	1.90	4.4 (0.9 to 5.2)	4.53 (1.06 to 5.60)	1010 (170 to 1250)
	240	1 unit	10	–	3.2	–	3.2 (0.5 to 4.4)	3.73 (0.77 to 5.50)	850 (130 to 1280)
			13	–	4.2	–	4.2 (0.5 to 4.7)	5.37 (0.77 to 5.80)	1250 (130 to 1350)
		2 units	10	10	2.15	2.15	4.3 (0.9 to 5.1)	4.21 (1.01 to 5.28)	980 (170 to 1230)
			13	10	2.50	1.90	4.4 (0.9 to 5.2)	4.34 (1.01 to 5.37)	1010 (170 to 1250)

The above specification values are those under the conditions

Cooling Indoor: DB/WB=27/19°C

Outdoor: DB=35°C

Heating Indoor: DB=20°C

Outdoor: DB/WB=7/6°C



<Cooling> RAS-M18EAV-E , RAS-M18EACV-E

Operation mode	Volts	Operation Status	Operating indoor unit		Unit capacity (kW)		Capacity (kW)	Running current	Power Consumption
	V		A	B	A	B	kW	A	W
Cooling	220	1 unit	10	-	2.7	-	2.7 (1.1 to 3.2)	3.03 (1.43 to 3.83)	600 (220 to 800)
			13	-	3.7	-	3.7 (1.1 to 4.2)	5.10 (1.43 to 6.49)	1100 (220 to 1400)
			16	-	4.5	-	4.5 (1.1 to 4.9)	6.96 (1.43 to 7.88)	1500 (220 to 1700)
		2 units	10	10	2.55	2.55	5.1 (1.4 to 6.1)	7.19 (1.69 to 9.97)	1550 (260 to 2150)
			13	10	2.85	2.35	5.2 (1.4 to 6.2)	7.42 (1.69 to 10.06)	1600 (260 to 2170)
			13	13	2.60	2.60	5.2 (1.4 to 6.2)	7.42 (1.69 to 10.06)	1600 (260 to 2170)
	230	1 unit	10	-	2.7	-	2.7 (1.1 to 3.2)	2.90 (1.37 to 3.66)	600 (220 to 800)
			13	-	3.7	-	3.7 (1.1 to 4.2)	4.88 (1.37 to 6.21)	1100 (220 to 1400)
			16	-	4.5	-	4.5 (1.1 to 4.9)	6.65 (1.37 to 7.54)	1500 (220 to 1700)
		2 units	10	10	2.55	2.55	5.1 (1.4 to 6.1)	6.88 (1.61 to 9.54)	1550 (260 to 2150)
			13	10	2.85	2.35	5.2 (1.4 to 6.2)	7.10 (1.61 to 9.63)	1600 (260 to 2170)
			13	13	2.60	2.60	5.2 (1.4 to 6.2)	7.10 (1.61 to 9.63)	1600 (260 to 2170)
	240	1 unit	10	-	2.7	-	2.7 (1.1 to 3.2)	2.78 (1.31 to 3.51)	600 (220 to 800)
			13	-	3.7	-	3.7 (1.1 to 4.2)	4.68 (1.31 to 5.95)	1100 (220 to 1400)
			16	-	4.5	-	4.5 (1.1 to 4.9)	6.38 (1.31 to 7.23)	1500 (220 to 1700)
		2 units	10	10	2.55	2.55	5.1 (1.4 to 6.1)	6.59 (1.55 to 9.14)	1550 (260 to 2150)
			13	10	2.85	2.35	5.2 (1.4 to 6.2)	6.80 (1.55 to 9.23)	1600 (260 to 2170)
			13	13	2.60	2.60	5.2 (1.4 to 6.2)	6.80 (1.55 to 9.23)	1600 (260 to 2170)
	240	2 units	16	10	3.25	1.95	5.2 (1.4 to 6.2)	6.80 (1.55 to 9.23)	1600 (260 to 2170)

<Heating>RAS-M18EAV-E

Operation mode	Volts	Operation Status	Operating indoor unit		Unit capacity (kW)		Capacity (kW)	Running current	Power Consumption
	V		A	B	A	B	kW	A	W
Heating	220	1 unit	10	-	4.0	-	4.0 (0.7 to 5.2)	5.57 (1.10 to 7.88)	1200 (170 to 1700)
			13	-	5.0	-	5.0 (0.7 to 6.5)	8.35 (1.10 to 11.73)	1800 (170 to 2530)
			16	-	5.5	-	5.5 (0.7 to 6.9)	8.81 (1.10 to 11.73)	1900 (170 to 2530)
		2 units	10	10	3.25	3.25	6.5 (0.9 to 8.2)	8.35 (1.30 to 11.09)	1800 (200 to 2390)
			13	10	3.51	3.19	6.7 (0.9 to 8.5)	8.58 (1.30 to 11.36)	1850 (200 to 2450)
			13	13	3.35	3.35	6.7 (0.9 to 8.5)	8.58 (1.30 to 11.36)	1850 (200 to 2450)
	230	1 unit	10	-	4.0	-	4.0 (0.7 to 5.2)	5.32 (1.06 to 7.54)	1200 (170 to 1700)
			13	-	5.0	-	5.0 (0.7 to 6.5)	7.99 (1.06 to 11.22)	1800 (170 to 2530)
			16	-	5.5	-	5.5 (0.7 to 6.9)	8.43 (1.06 to 11.22)	1900 (170 to 2530)
		2 units	10	10	3.25	3.25	6.5 (0.9 to 8.2)	7.99 (1.24 to 10.60)	1800 (200 to 2390)
			13	10	3.51	3.19	6.7 (0.9 to 8.5)	8.21 (1.24 to 10.87)	1850 (200 to 2450)
			13	13	3.35	3.35	6.7 (0.9 to 8.5)	8.21 (1.24 to 10.87)	1850 (200 to 2450)
	240	1 unit	10	-	4.0	-	4.0 (0.7 to 5.2)	5.10 (1.01 to 7.23)	1200 (170 to 1700)
			13	-	5.0	-	5.0 (0.7 to 6.5)	7.65 (1.01 to 10.76)	1800 (170 to 2530)
			16	-	5.5	-	5.5 (0.7 to 6.9)	8.08 (1.01 to 10.76)	1900 (170 to 2530)
		2 units	10	10	3.25	3.25	6.5 (0.9 to 8.2)	7.65 (1.19 to 10.16)	1800 (200 to 2390)
			13	10	3.51	3.19	6.7 (0.9 to 8.5)	7.87 (1.19 to 10.42)	1850 (200 to 2450)
			13	13	3.35	3.35	6.7 (0.9 to 8.5)	7.87 (1.19 to 10.42)	1850 (200 to 2450)
	240	2 units	16	10	3.88	2.82	6.7 (0.9 to 8.5)	7.87 (1.19 to 10.42)	1850 (200 to 2450)

The above specification values are those under the conditions

Cooling Indoor: DB/WB=27/19°C

Outdoor: DB=35°C

Heating Indoor: DB=20°C

Outdoor: DB/WB=7/6°C

## 2-2-1. Operation Characteristic Curve

### <Cooling> RAS-M14EAV-E, RAS-M14EACV-E

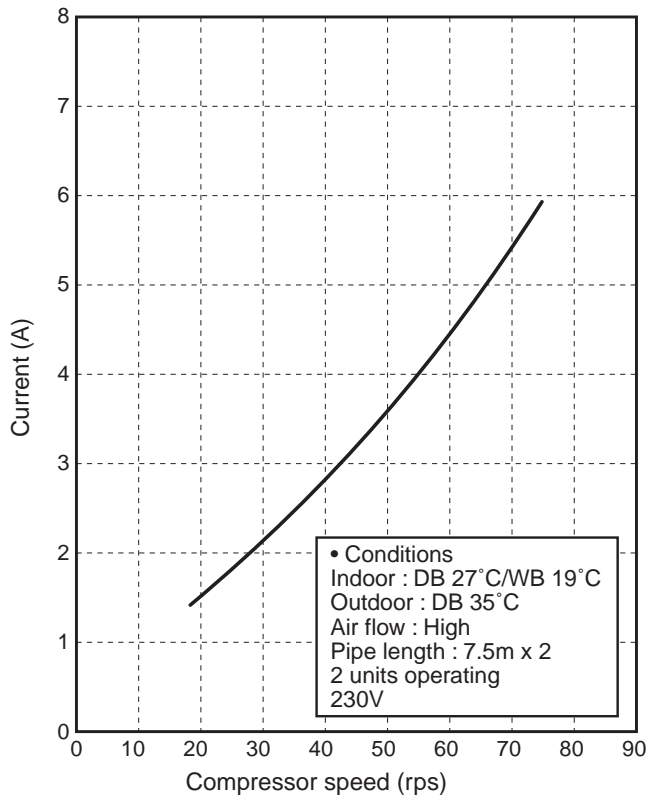

### <Heating> RAS-M14EAV-E

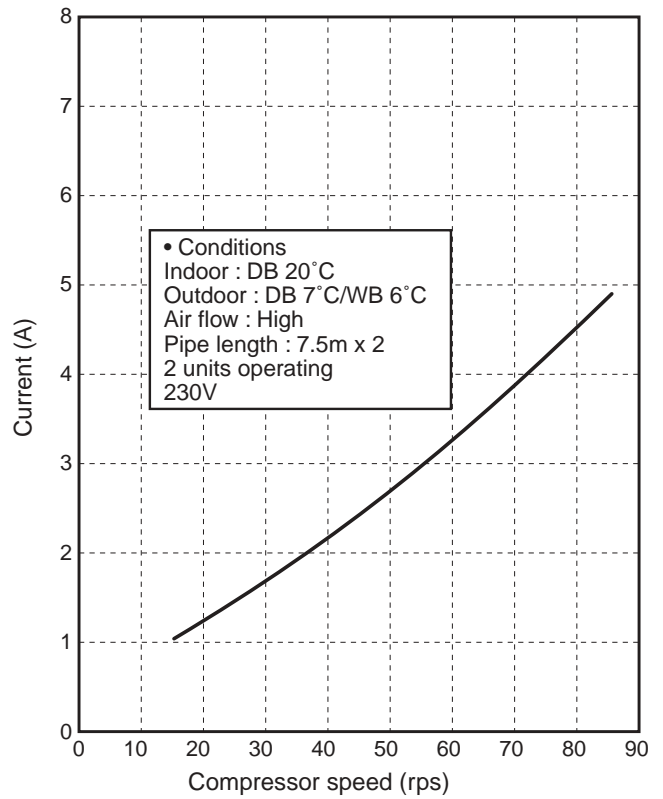

## 2-2-2. Capacity Variation Ratio According to Temperature

### RAS-M14EAV-E, RAS-M14EACV-E

#### <Cooling>

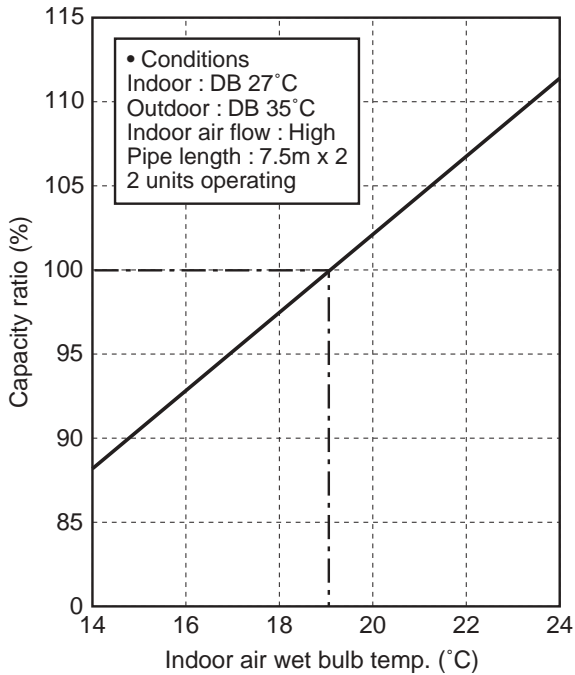

#### <Cooling>

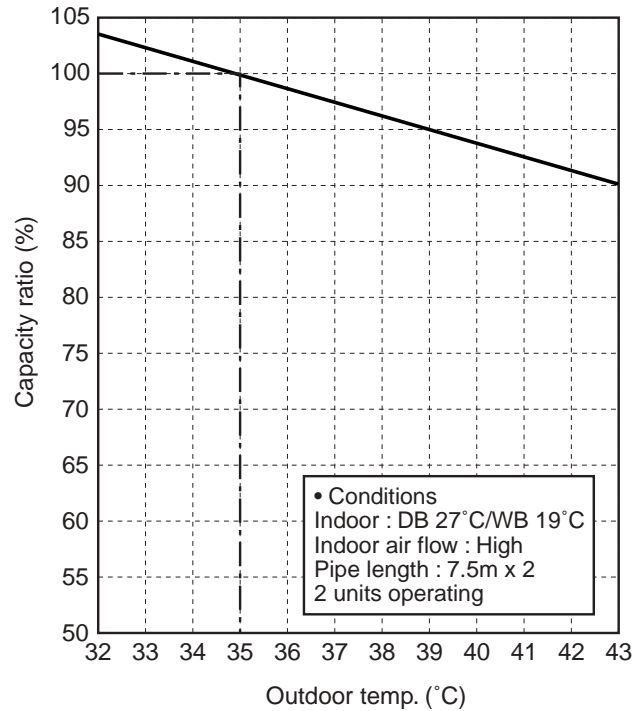

\* Capacity ratio : 100% = 4.0 kW

### 2-2-3. Operation Characteristic Curve

<Cooling> RAS-M18EAV-E, RAS-M18EACV-E

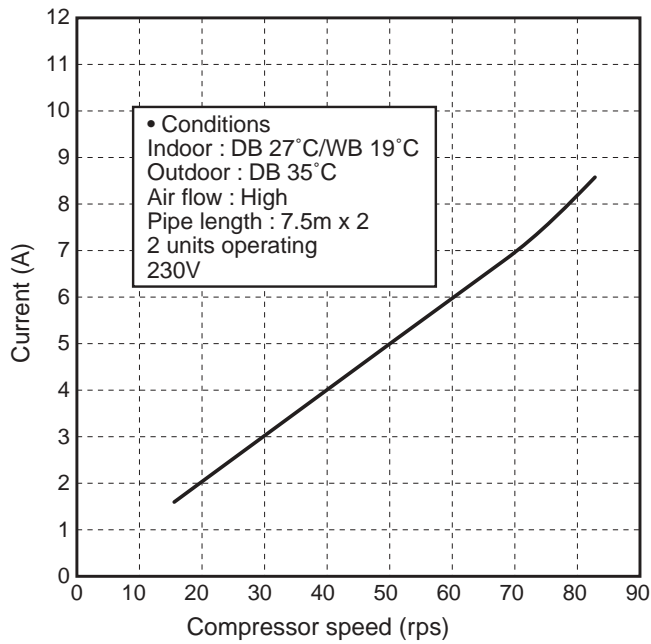

<Heating> RAS-M18EAV-E

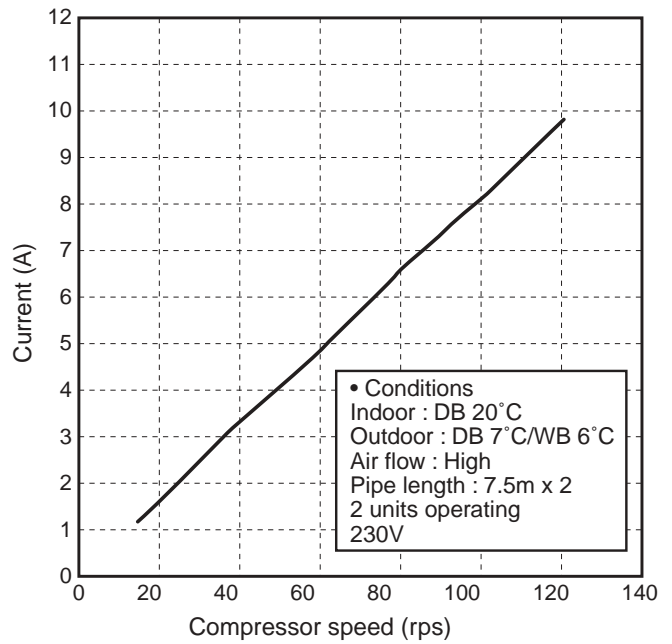

### 2-2-4. Capacity Variation Ratio According to Temperature

RAS-M18EAV-E, RAS-M18EACV-E

<Cooling>

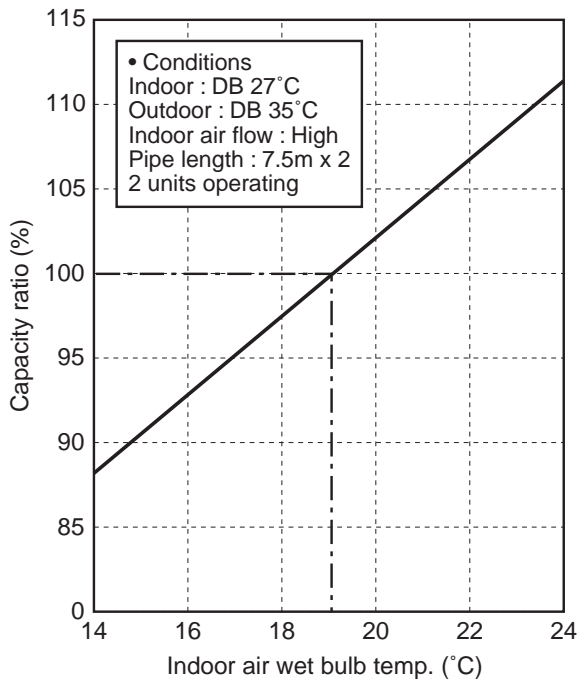

<Cooling>

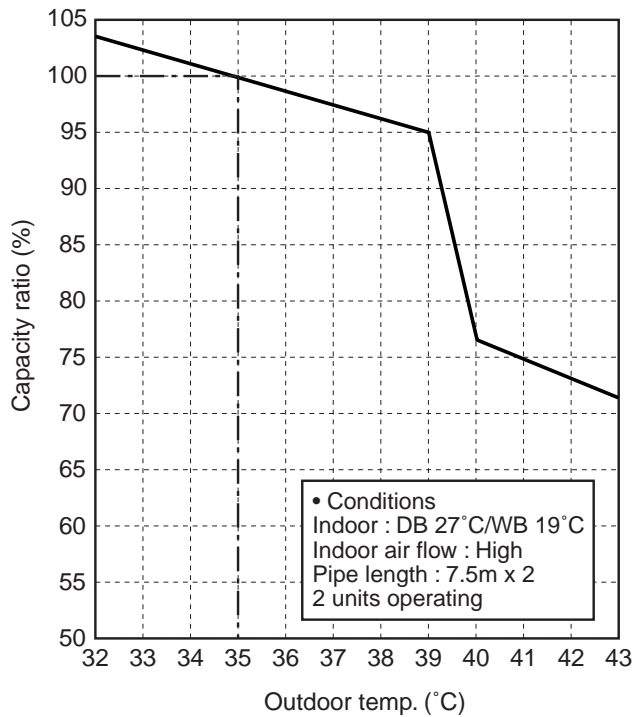

\* Capacity ratio : 100% = 5.2 kW

### 3. REFRIGERANT R410A

This air conditioner adopts the new refrigerant HFC (R410A) which does not damage the ozone layer.

The working pressure of the new refrigerant R410A is 1.6 times higher than conventional refrigerant (R22). The refrigerating oil is also changed in accordance with change of refrigerant, so be careful that water, dust, and existing refrigerant or refrigerating oil are not entered in the refrigerant cycle of the air conditioner using the new refrigerant during installation work or servicing time.

The next section describes the precautions for air conditioner using the new refrigerant. Conforming to contents of the next section together with the general cautions included in this manual, perform the correct and safe work.

#### 3-1. Safety During Installation/Serviceing

As R410A's pressure is about 1.6 times higher than that of R22, improper installation/servicing may cause a serious trouble. By using tools and materials exclusive for R410A, it is necessary to carry out installation/servicing safely while taking the following precautions into consideration.

- (1) Never use refrigerant other than R410A in an air conditioner which is designed to operate with R410A.

If other refrigerant than R410A is mixed, pressure in the refrigeration cycle becomes abnormally high, and it may cause personal injury, etc. by a rupture.

- (2) Confirm the used refrigerant name, and use tools and materials exclusive for the refrigerant R410A.

The refrigerant name R410A is indicated on the visible place of the outdoor unit of the air conditioner using R410A as refrigerant. To prevent mischarging, the diameter of the service port differs from that of R22.

- (3) If a refrigeration gas leakage occurs during installation/servicing, be sure to ventilate fully.  
If the refrigerant gas comes into contact with fire, a poisonous gas may occur.
- (4) When installing or removing an air conditioner, do not allow air or moisture to remain in the refrigeration cycle. Otherwise, pressure in the refrigeration cycle may become abnormally high so that a rupture or personal injury may be caused.
- (5) After completion of installation work, check to make sure that there is no refrigeration gas leakage.

If the refrigerant gas leaks into the room, coming into contact with fire in the fan-driven heater, space heater, etc., a poisonous gas may occur.

- (6) When an air conditioning system charged with a large volume of refrigerant is installed in a small room, it is necessary to exercise care so that, even when refrigerant leaks, its concentration does not exceed the marginal level.

If the refrigerant gas leakage occurs and its concentration exceeds the marginal level, an oxygen starvation accident may result.

- (7) Be sure to carry out installation or removal according to the installation manual.  
Improper installation may cause refrigeration trouble, water leakage, electric shock, fire, etc.
- (8) Unauthorized modifications to the air conditioner may be dangerous. If a breakdown occurs please call a qualified air conditioner technician or electrician.

Improper repair's may result in water leakage, electric shock and fire, etc.

#### 3-2. Refrigerant Piping Installation

##### 3-2-1. Piping Materials and Joints Used

For the refrigerant piping installation, copper pipes and joints are mainly used. Copper pipes and joints suitable for the refrigerant must be chosen and installed. Furthermore, it is necessary to use clean copper pipes and joints whose interior surfaces are less affected by contaminants.

- (1) Copper Pipes

It is necessary to use seamless copper pipes which are made of either copper or copper alloy and it is desirable that the amount of residual oil is less than 40 mg/10 m. Do not use copper pipes having a collapsed, deformed or discolored portion (especially on the interior surface).

Otherwise, the expansion valve or capillary tube may become blocked with contaminants.

As an air conditioner using R410A incurs pressure higher than when using R22, it is necessary to choose adequate materials.

Thicknesses of copper pipes used with R410A are as shown in Table 3-2-1. Never use copper pipes thinner than 0.8 mm even when it is available on the market.

**Table 3-2-1 Thicknesses of annealed copper pipes**

		Thickness (mm)	
Nominal diameter	Outer diameter (mm)	R410A	R22
1/4	6.35	0.80	0.80
3/8	9.52	0.80	0.80
1/2	12.70	0.80	0.80
5/8	15.88	1.00	1.00

(2) Joints

For copper pipes, flare joints or socket joints are used. Prior to use, be sure to remove all contaminants.

a) Flare Joints

Flare joints used to connect the copper pipes cannot be used for pipings whose outer diameter exceeds 20 mm. In such a case, socket joints can be used.

Sizes of flare pipe ends, flare joint ends and flare nuts are as shown in Tables 3-2-3 to 3-2-6 below.

b) Socket Joints

Socket joints are such that they are brazed for connections, and used mainly for thick pipings whose diameter is larger than 20 mm. Thicknesses of socket joints are as shown in Table 3-2-2.

**Table 3-2-2 Minimum thicknesses of socket joints**

Nominal diameter	Reference outer diameter of copper pipe jointed (mm)	Minimum joint thickness (mm)
1/4	6.35	0.50
3/8	9.52	0.60
1/2	12.70	0.70
5/8	15.88	0.80

**3-2-2. Processing of Piping Materials**

When performing the refrigerant piping installation, care should be taken to ensure that water or dust does not enter the pipe interior, that no other oil other than lubricating oils used in the installed air conditioner is used, and that refrigerant does not leak. When using lubricating oils in the piping processing, use such lubricating oils whose water content has been removed. When stored, be sure to seal the container with an airtight cap or any other cover.

(1) Flare Processing Procedures and Precautions

a) Cutting the Pipe

By means of a pipe cutter, slowly cut the pipe so that it is not deformed.

b) Removing Burrs and Chips

If the flared section has chips or burrs, refrigerant leakage may occur. Carefully remove all burrs and clean the cut surface before installation.

c) Insertion of Flare Nut

d) Flare Processing

Make certain that a clamp bar and copper pipe have been cleaned.

By means of the clamp bar, perform the flare processing correctly.

Use either a flare tool for R410A or conventional flare tool.

Flare processing dimensions differ according to the type of flare tool. When using a conventional flare tool, be sure to secure "dimension A" by using a gauge for size adjustment.

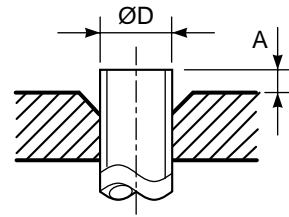

Fig. 3-2-1 Flare processing dimensions

Table 3-2-3 Dimensions related to flare processing for R410A

Nominal diameter	Outer diameter (mm)	Thickness (mm)	A (mm)		
			Flare tool for R410A clutch type	Conventional flare tool	
				Clutch type	Wing nut type
1/4	6.35	0.8	0 to 0.5	1.0 to 1.5	1.5 to 2.0
3/8	9.52	0.8	0 to 0.5	1.0 to 1.5	1.5 to 2.0
1/2	12.70	0.8	0 to 0.5	1.0 to 1.5	2.0 to 2.5
5/8	15.88	1.0	0 to 0.5	1.0 to 1.5	2.0 to 2.5

Table 3-2-4 Dimensions related to flare processing for R22

Nominal diameter	Outer diameter (mm)	Thickness (mm)	A (mm)		
			Flare tool for R410A clutch type	Conventional flare tool	
				Clutch type	Wing nut type
1/4	6.35	0.8	0 to 0.5	0.5 to 1.0	1.0 to 1.5
3/8	9.52	0.8	0 to 0.5	0.5 to 1.0	1.0 to 1.5
1/2	12.70	0.8	0 to 0.5	0.5 to 1.0	1.5 to 2.0
5/8	15.88	1.0	0 to 0.5	0.5 to 1.0	1.5 to 2.0

Table 3-2-5 Flare and flare nut dimensions for R410A

Nominal diameter	Outer diameter (mm)	Thickness (mm)	Dimension (mm)				Flare nut width (mm)
			A	B	C	D	
1/4	6.35	0.8	9.1	9.2	6.5	13	17
3/8	9.52	0.8	13.2	13.5	9.7	20	22
1/2	12.70	0.8	16.6	16.0	12.9	23	26
5/8	15.88	1.0	19.7	19.0	16.0	25	29

**Table 3-2-6 Flare and flare nut dimensions for R22**

Nominal diameter	Outer diameter (mm)	Thickness (mm)	Dimension (mm)				Flare nut width (mm)
			A	B	C	D	
1/4	6.35	0.8	9.0	9.2	6.5	13	17
3/8	9.52	0.8	13.0	13.5	9.7	20	22
1/2	12.70	0.8	16.2	16.0	12.9	20	24
5/8	15.88	1.0	19.7	19.0	16.0	23	27
3/4	19.05	1.0	23.3	24.0	19.2	34	36

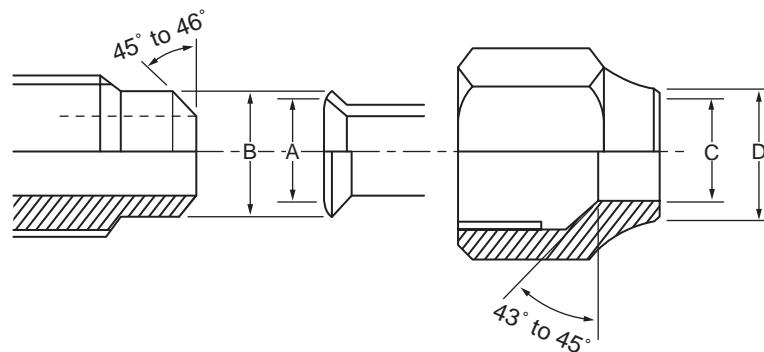

**Fig. 3-2-2 Relations between flare nut and flare seal surface**

- (2) Flare Connecting Procedures and Precautions
- Make sure that the flare and union portions do not have any scar or dust, etc.
  - Correctly align the processed flare surface with the union axis.
  - Tighten the flare with designated torque by means of a torque wrench. The tightening torque for R410A is the same as that for conventional R22. Incidentally, when the torque is weak, the gas leakage may occur.

When it is strong, the flare nut may crack and may be made non-removable. When choosing the tightening torque, comply with values designated by manufacturers. Table 3-2-7 shows reference values.

**NOTE :**

When applying oil to the flare surface, be sure to use oil designated by the manufacturer. If any other oil is used, the lubricating oils may deteriorate and cause the compressor to burn out.

**Table 3-2-7 Tightening torque of flare for R410A [Reference values]**

Nominal diameter	Outer diameter (mm)	Tightening torque N•m (kgf•cm)	Tightening torque of torque wrenches available on the market N•m (kgf•cm)
1/4	6.35	14 to 18 (140 to 180)	16 (160), 18 (180)
3/8	9.52	33 to 42 (330 to 420)	42 (420)
1/2	12.70	50 to 62 (500 to 620)	55 (550)
5/8	15.88	63 to 77 (630 to 770)	65 (650)

### 3-3. Tools

#### 3-3-1. Required Tools

The service port diameter of packed valve of the outdoor unit in the air conditioner using R410A is changed to prevent mixing of other refrigerant. To reinforce the pressure-resisting strength, flare processing dimensions and opposite side dimension of flare nut (For Ø12.7 copper pipe) of the refrigerant piping are lengthened.

The used refrigerating oil is changed, and mixing of oil may cause a trouble such as generation of sludge, clogging of capillary, etc. Accordingly, the tools to be used are classified into the following three types.

- (1) Tools exclusive for R410A (Those which cannot be used for conventional refrigerant (R22))
- (2) Tools exclusive for R410A, but can be also used for conventional refrigerant (R22)
- (3) Tools commonly used for R410A and for conventional refrigerant (R22)

The table below shows the tools exclusive for R410A and their interchangeability.

#### Tools exclusive for R410A (The following tools for R410A are required.)

Tools whose specifications are changed for R410A and their interchangeability

No.	Used tool	Usage	R410A air conditioner installation		Conventional air conditioner installation
			Existence of new equipment for R410A	Whether conventional equipment can be used	Whether new equipment can be used with conventional refrigerant
1	Flare tool	Pipe flaring	Yes	*(Note 1)	○
2	Copper pipe gauge for adjusting projection margin	Flaring by conventional flare tool	Yes	*(Note 1)	*(Note 1)
3	Torque wrench (For Ø12.7)	Connection of flare nut	Yes	×	×
4	Gauge manifold	Evacuating, refrigerant charge, run check, etc.	Yes	×	×
5	Charge hose				
6	Vacuum pump adapter	Vacuum evacuating	Yes	×	○
7	Electronic balance for refrigerant charging	Refrigerant charge	Yes	×	○
8	Refrigerant cylinder	Refrigerant charge	Yes	×	×
9	Leakage detector	Gas leakage check	Yes	×	○
10	Charging cylinder	Refrigerant charge	(Note 2)	×	×

**(Note 1)** When flaring is carried out for R410A using the conventional flare tools, adjustment of projection margin is necessary. For this adjustment, a copper pipe gauge, etc. are necessary.

**(Note 2)** Charging cylinder for R410A is being currently developed.

#### General tools (Conventional tools can be used.)

In addition to the above exclusive tools, the following equipments which serve also for R22 are necessary as the general tools.

- |   |                              |  |
|---|------------------------------|--|
| (1) Vacuum pump<br>Use vacuum pump by<br>attaching vacuum pump adapter. | (5) Pipe bender              | (10) Hexagon wrench<br>(Opposite side 4mm) |
| (2) Torque wrench (For Ø6.35, Ø9.52)                                    | (6) Level vial               | (11) Tape measure                          |
| (3) Pipe cutter   | (7) Screwdriver (+, -)       | (12) Metal saw                             |
| (4) Reamer  | (8) Spanner or Monkey wrench |  |
|   | (9) Hole core drill (Ø65)    |  |

Also prepare the following equipments for other installation method and run check.

- |                 |                                  |
|-----------------|----------------------------------|
| (1) Clamp meter | (3) Insulation resistance tester |
| (2) Thermometer | (4) Electro-scope                |



### 3-4. Recharging of Refrigerant

When it is necessary to recharge refrigerant, charge the specified amount of new refrigerant according to the following steps.

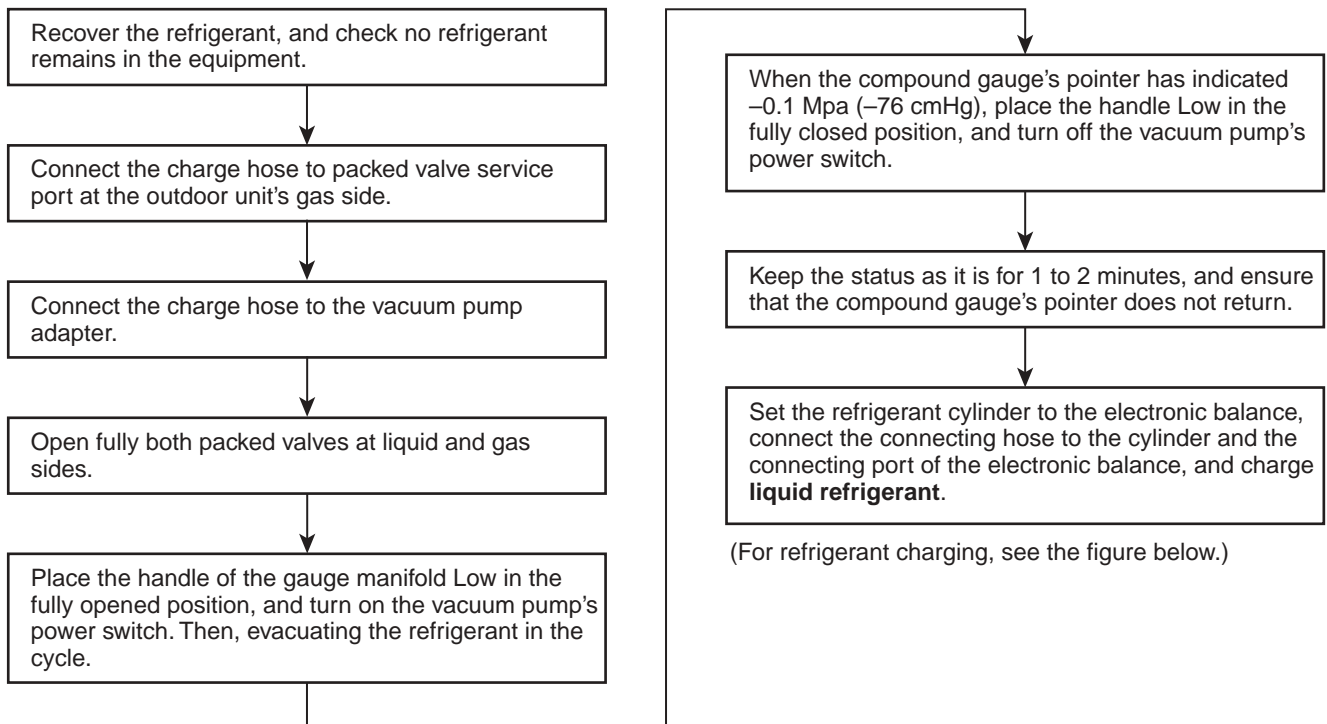

- (1) Never charge refrigerant exceeding the specified amount.
- (2) If the specified amount of refrigerant cannot be charged, charge refrigerant **bit by bit** in COOL mode.
- (3) Do not carry out additional charging.

When additional charging is carried out if refrigerant leaks, the refrigerant composition changes in the refrigeration cycle, that is characteristics of the air conditioner changes, refrigerant exceeding the specified amount is charged, and working pressure in the refrigeration cycle becomes abnormally high pressure, and may cause a rupture or personal injury.

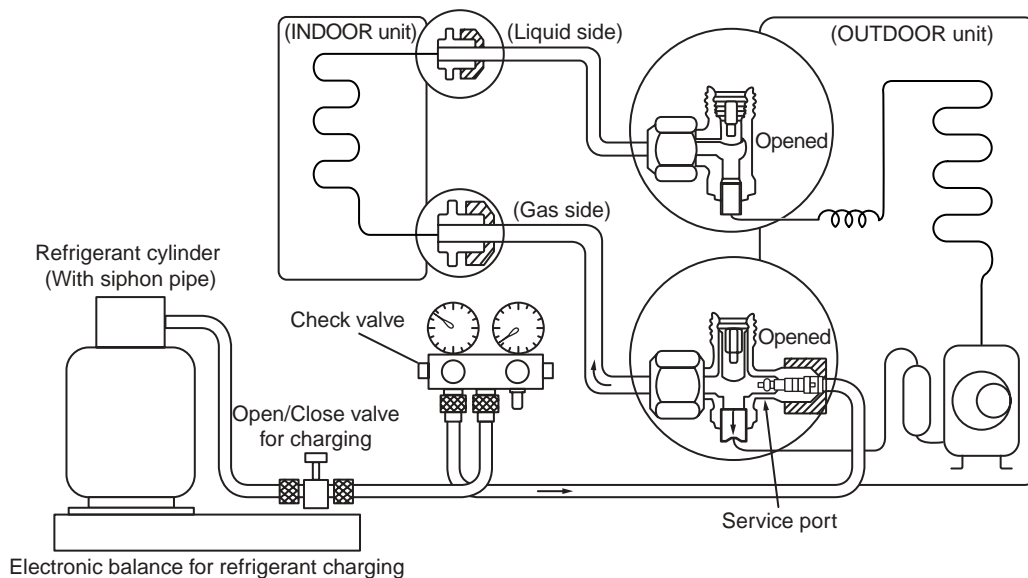

**Fig. 3-4-1 Configuration of refrigerant charging**

- (1) Be sure to make setting so that **liquid** can be charged.
- (2) When using a cylinder equipped with a siphon, liquid can be charged without turning it upside down.

It is necessary for charging refrigerant under condition of liquid because R410A is mixed type of refrigerant. Accordingly, when charging refrigerant from the refrigerant cylinder to the equipment, charge it turning the cylinder upside down if cylinder is not equipped with siphon.

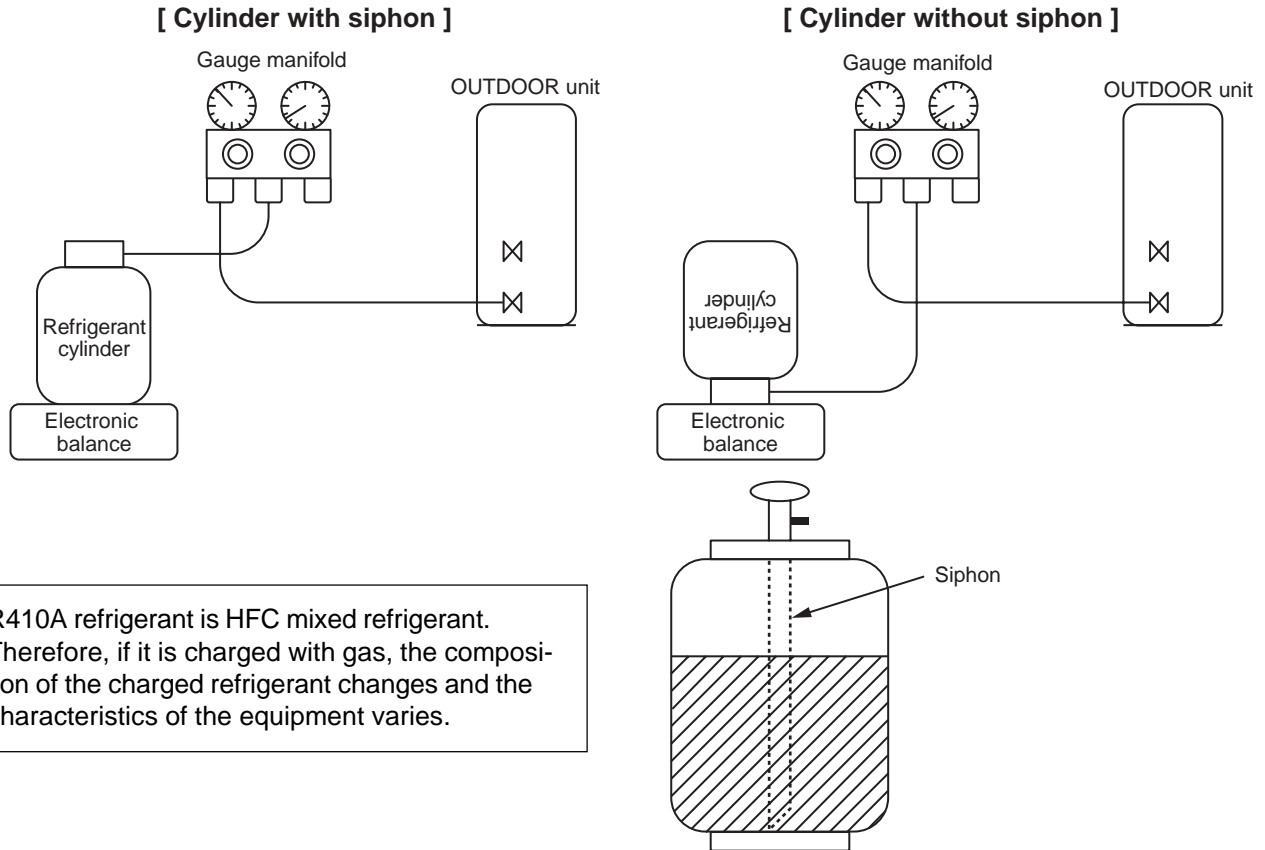

R410A refrigerant is HFC mixed refrigerant. Therefore, if it is charged with gas, the composition of the charged refrigerant changes and the characteristics of the equipment varies.

Fig. 3-4-2

### 3-5. Brazing of Pipes

#### 3-5-1. Materials for Brazing

##### (1) Silver brazing filler

Silver brazing filler is an alloy mainly composed of silver and copper. It is used to join iron, copper or copper alloy, and is relatively expensive though it excels in solderability.

##### (2) Phosphor bronze brazing filler

Phosphor bronze brazing filler is generally used to join copper or copper alloy.

##### (3) Low temperature brazing filler

Low temperature brazing filler is generally called solder, and is an alloy of tin and lead. Since it is weak in adhesive strength, do not use it for refrigerant pipes.

- (1) Phosphor bronze brazing filler tends to react with sulfur and produce a fragile compound water solution, which may cause a gas leakage. Therefore, use any other type of brazing filler at a hot spring resort, etc., and coat the surface with a paint.
- (2) When performing brazing again at time of servicing, use the same type of brazing filler.

#### 3-5-2. Flux

##### (1) Reason why flux is necessary

- By removing the oxide film and any foreign matter on the metal surface, it assists the flow of brazing filler.
- In the brazing process, it prevents the metal surface from being oxidized.
- By reducing the brazing filler's surface tension, the brazing filler adheres better to the treated metal.

## (2) Characteristics required for flux

- Activated temperature of flux coincides with the brazing temperature.
- Due to a wide effective temperature range, flux is hard to carbonize.
- It is easy to remove slag after brazing.
- The corrosive action to the treated metal and brazing filler is minimum.
- It excels in coating performance and is harmless to the human body.

As the flux works in a complicated manner as described above, it is necessary to select an adequate type of flux according to the type and shape of treated metal, type of brazing filler and brazing method, etc.

## (3) Types of flux

### • Noncorrosive flux

Generally, it is a compound of borax and boric acid.

It is effective in case where the brazing temperature is higher than 800°C.

### • Activated flux

Most of fluxes generally used for silver brazing are this type.

It features an increased oxide film removing capability due to the addition of compounds such as potassium fluoride, potassium chloride and sodium fluoride to the borax-boric acid compound.

## (4) Piping materials for brazing and used brazing filler/flux

Piping material	Used brazing filler	Used flux
Copper - Copper	Phosphor copper	Do not use
Copper - Iron	Silver	Paste flux
Iron - Iron	Silver	Vapor flux

- (1) Do not enter flux into the refrigeration cycle.
- (2) When chlorine contained in the flux remains within the pipe, the lubricating oil deteriorates. Therefore, use a flux which does not contain chlorine.
- (3) When adding water to the flux, use water which does not contain chlorine (e.g. distilled water or ion-exchange water).
- (4) Remove the flux after brazing.

## 3-5-3. Brazing

As brazing work requires sophisticated techniques, experiences based upon a theoretical knowledge, it must be performed by a person qualified.

In order to prevent the oxide film from occurring in the pipe interior during brazing, it is effective to proceed with brazing while letting dry Nitrogen gas (N<sub>2</sub>) flow.

**Never use gas other than Nitrogen gas.**

### (1) Brazing method to prevent oxidation

- 1) Attach a reducing valve and a flow-meter to the Nitrogen gas cylinder.
- 2) Use a copper pipe to direct the piping material, and attach a flow-meter to the cylinder.
- 3) Apply a seal onto the clearance between the piping material and inserted copper pipe for Nitrogen in order to prevent backflow of the Nitrogen gas.
- 4) When the Nitrogen gas is flowing, be sure to keep the piping end open.
- 5) Adjust the flow rate of Nitrogen gas so that it is lower than 0.05 m<sup>3</sup>/Hr or 0.02 MPa (0.2kgf/cm<sup>2</sup>) by means of the reducing valve.
- 6) After performing the steps above, keep the Nitrogen gas flowing until the pipe cools down to a certain extent (temperature at which pipes are touchable with hands).
- 7) Remove the flux completely after brazing.

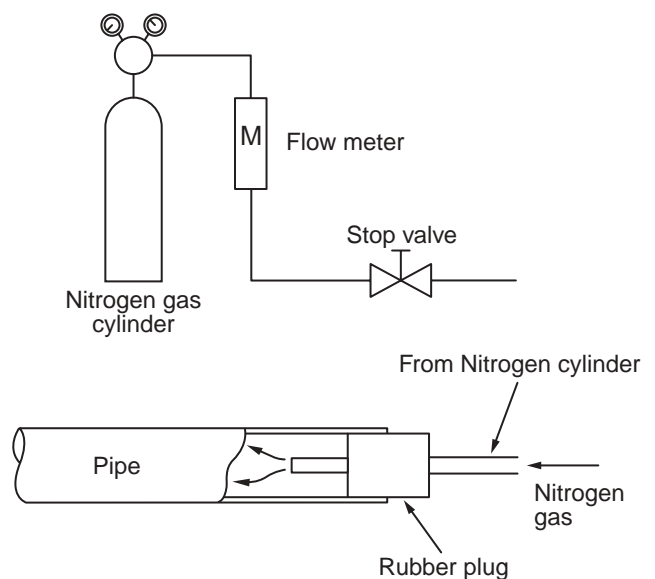
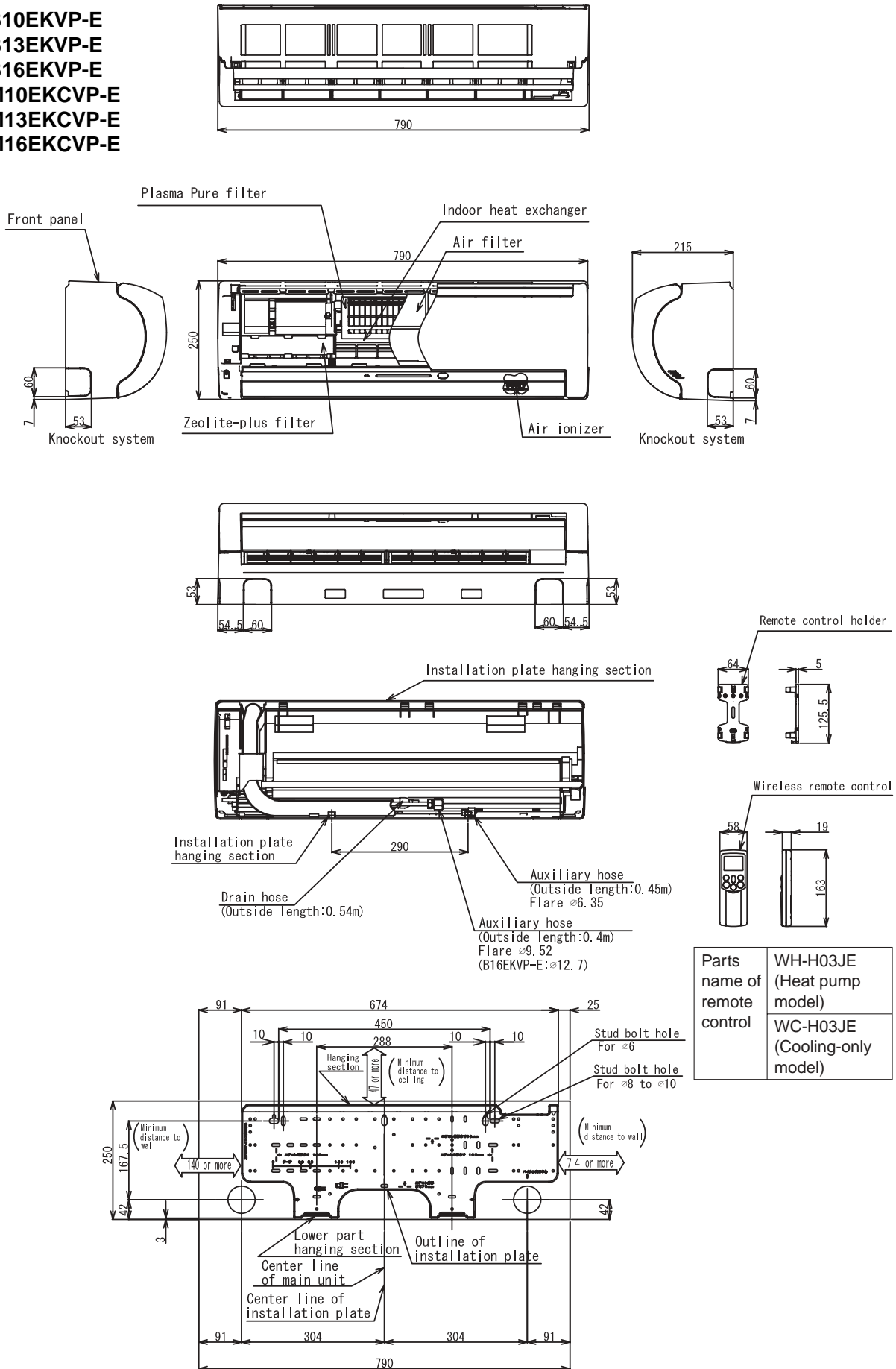

**Fig. 3-5-1 Prevention of oxidation during brazing**

## 4. CONSTRUCTION VIEWS

### 4-1. Indoor Unit

RAS-B10EKVP-E  
RAS-B13EKVP-E  
RAS-B16EKVP-E  
RAS-M10EKCV-P-E  
RAS-M13EKCV-P-E  
RAS-M16EKCV-P-E



## 4-2. Outdoor Unit

RAS-M14EAV-E, RAS-M18EAV-E (Heat pump models)  
 RAS-M14EACV-E, RAS-M18EACV-E (Cooling-only models)

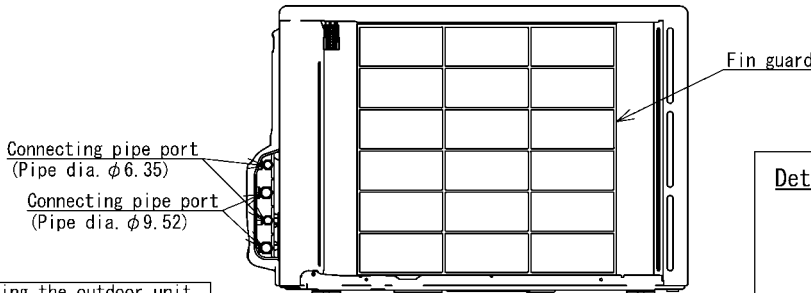
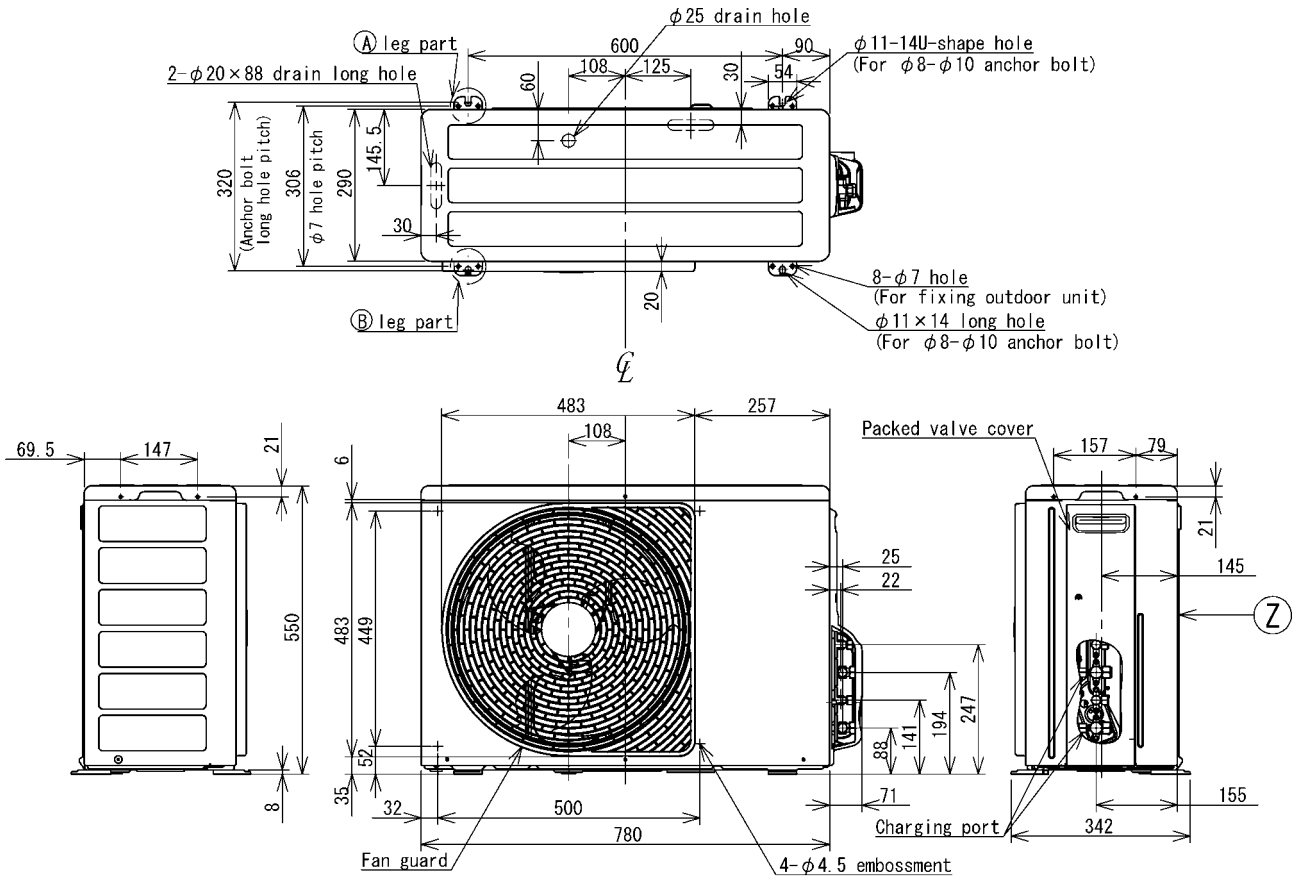

When installing the outdoor unit, leave open in at least two of directions (A), (B), (C) and (D) shown in the figure below.

Mounting dimensions of anchor bolt

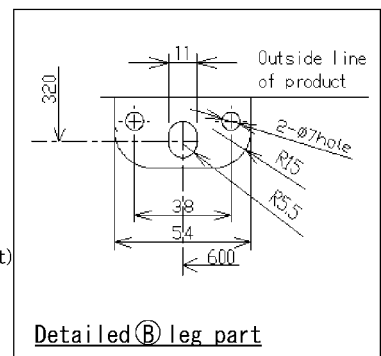
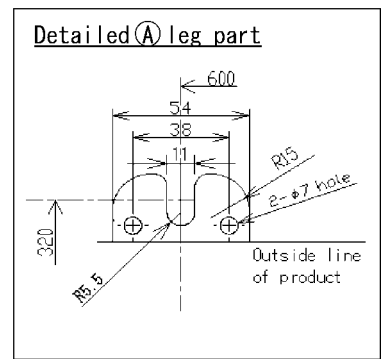
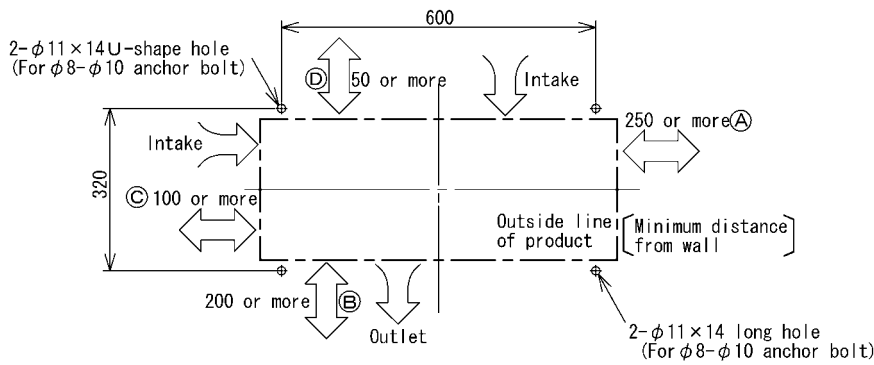

## 5. WIRING DIAGRAM

### 5-1. Indoor Unit

RAS-B10EKVP-E, RAS-B13EKVP-E, RAS-B16EKVP-E (Heat pump models)

RAS-M10EKCV, RAS-M13EKCV-E, RAS-M16EKCV-E (Cooling-only models)

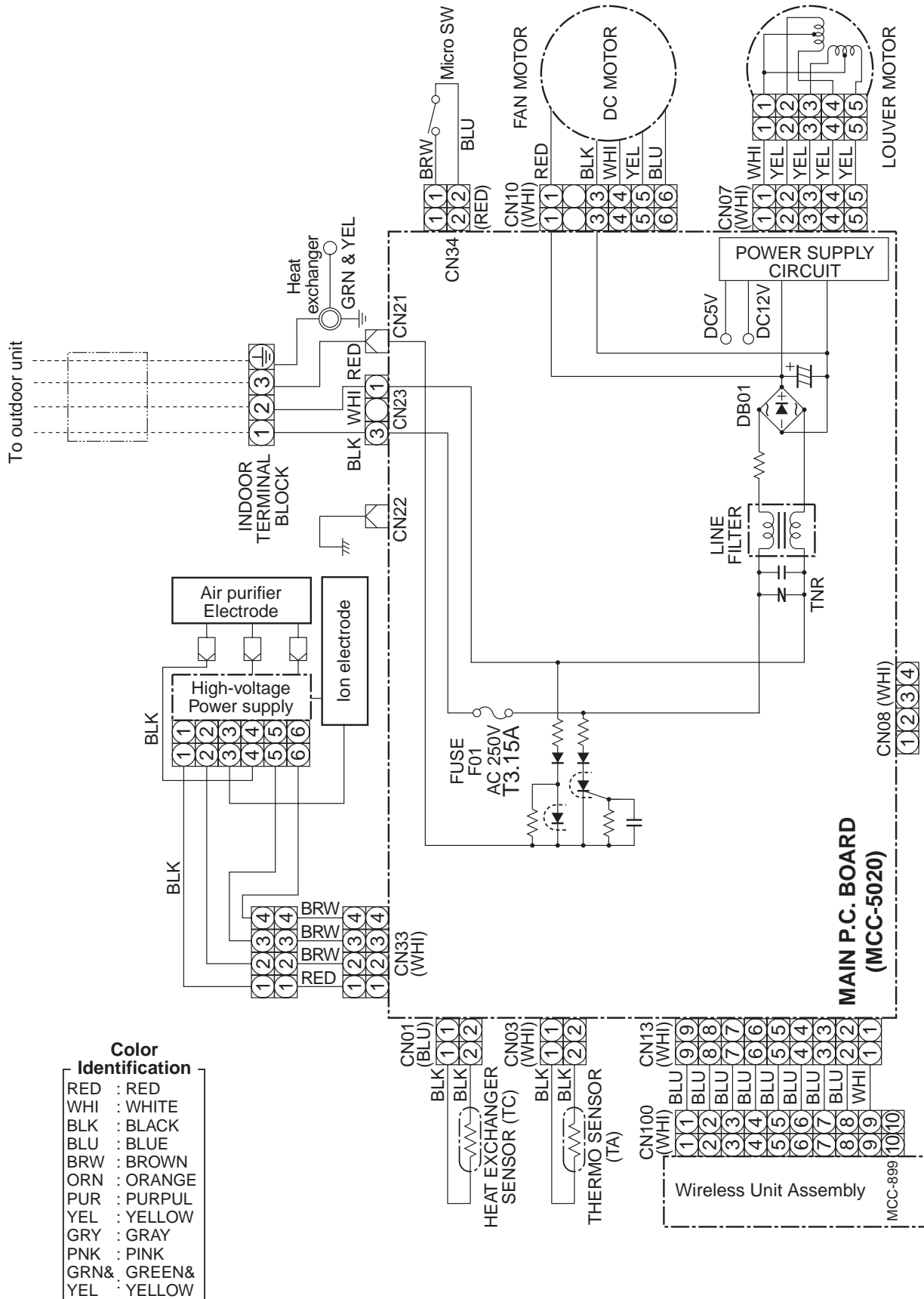

## 5-2. Outdoor Unit

RAS-M14EAV-E, RAS-M18EAV-E (Heat pump models)

RAS-M14EACV-E, RAS-M18EACV-E (Cooling-only models)

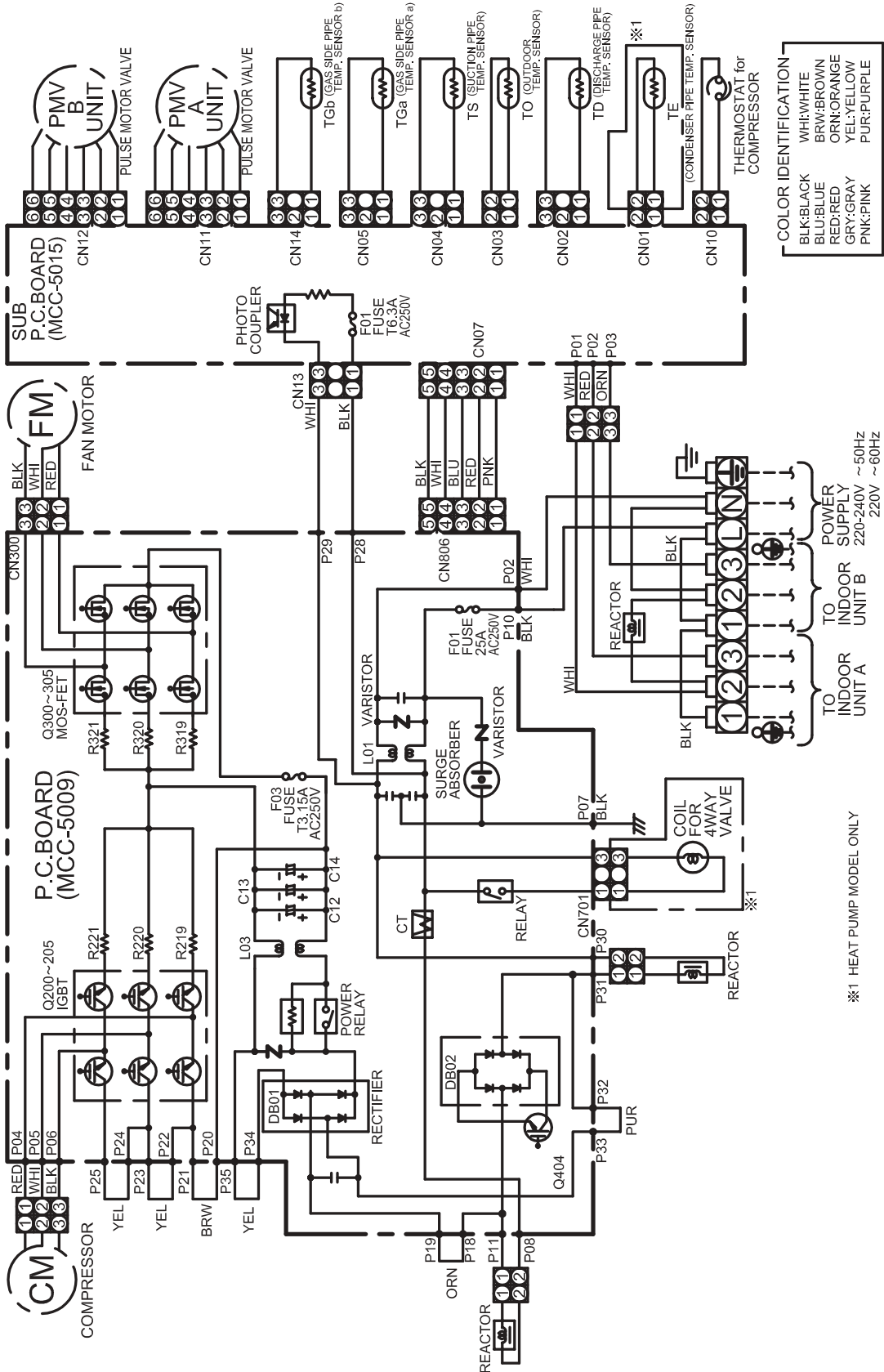

## 6. SPECIFICATIONS OF ELECTRICAL PARTS

### 6-1. Indoor Unit

RAS-B16EKVP-E, RAS-B13EKVP-E, RAS-B10EKVP-E  
RAS-M16EKCV-P-E, RAS-M13EKCV-P-E, RAS-M10EKCV-P-E

No.	Parts name	Type	Specifications
1	Fan motor (for indoor)	MF-280-30-5	DC280-340V, 30W
2	Room temp. sensor (TA-sensor)	(-)	10k $\Omega$ at 25°C
3	Heat exchanger temp. sensor (TC-sensor)	(-)	10k $\Omega$ at 25°C
4	Louver motor	MP24GA	Output (Rated) 1W, 16poles, 1phase DC12V



## 6-2. Outdoor Unit

### RAS-M14EAV-E, RAS-M14EACV-E, RAS-M18EAV-E, RAS-M18EACV-E

No.	Parts name	Model name	Rating
1	SC coil (Noise filter) (L03)	ADR2520-R15TB or SC-20-01J-A	AC 250V, 20A, 0.15mH
	SC coil (Noise filter) (L01)	ADR25H-200R8TB	AC 250V, 20A, 0.88mH
2	DC-DC transformer	SWT-72 or SWT-83	Primary side DC 280V Secondary side: 7.5V x 1, 13V x 126.5V x 3, 16V x 1, 15V x 1
3	Outside fan motor	ICF-140-43-4	DC 140V, 43W
*1 4	Relay (4-way valve)	G5N-1A	Coil: DC 12V, Contact: 2A, AC250V
5	Relay (Power relay)	DI12D1-O or G4A-1A-PE	Coil: DC 12V, Contact: 20A, AC250V
6	Discharge temp. sensor (TD-sensor)	(Inverter attached)	64kΩ (20°C)
7	Outside air temp. sensor (TO-sensor)	(Inverter attached)	10kΩ (25°C)
8	TGa-sensor (Heat pump models)	(Inverter attached)	64kΩ (25°C)
9	TGb-sensor (Heat pump models)	(Inverter attached)	64kΩ (25°C)
10	TGa-sensor (Cooling-only models)	(Inverter attached)	10kΩ (25°C)
11	TGb-sensor (Cooling-only models)	(Inverter attached)	10kΩ (25°C)
*1 12	Evaporator temp. sensor (TE-sensor)	(Inverter attached)	10kΩ (25°C)
13	Suction temp. sensor (TS-sensor)	(Inverter attached)	10kΩ (25°C)
14	Terminal block (9P)	—	20A, AC 250V
15	Fuse	For protection of switching power source (F03)	3.15A, AC 250V
		For protection of inverter input overcurrent	25A, AC 25V
		For protection of power source	6.3A, AC 250V
16	Electrolytic capacitor	LLQ2G761KHU	DC 400V, 760μF
17	IGBT (Q200~Q205)	GT20J321	600V, 20A
18	Compressor (M18)	DA130A1F-25F	3 phases, 4 poles, 1,100W
19	Compressor (M14)	DA111A1F-20F1	3 phases, 4 poles, 750W
20	Compressor thermo.	US622KXTMQO	OFF: 125±4°C, ON: 90±5°C
21	Rectifier (DB01, DB02)	D25 X B60	Diode: 600V, 25A
22	IGBT (Q404)	GT40Q321 or GT30J121	IGBT: 600V, 40A
23	Reactor (Main)	CH-57	L = 10mH, 16A
24	Reactor (Sub)	CH-43-Z-K	L = 10mH, 1A

**NOTE:** \*1 Heat pump models only.

## 7. REFRIGERANT CYCLE DIAGRAM

### 7-1. Refrigerant Cycle Diagram

RAS-B13EKVP-E, RAS-B10EKVP-E  
RAS-M14EAV-E

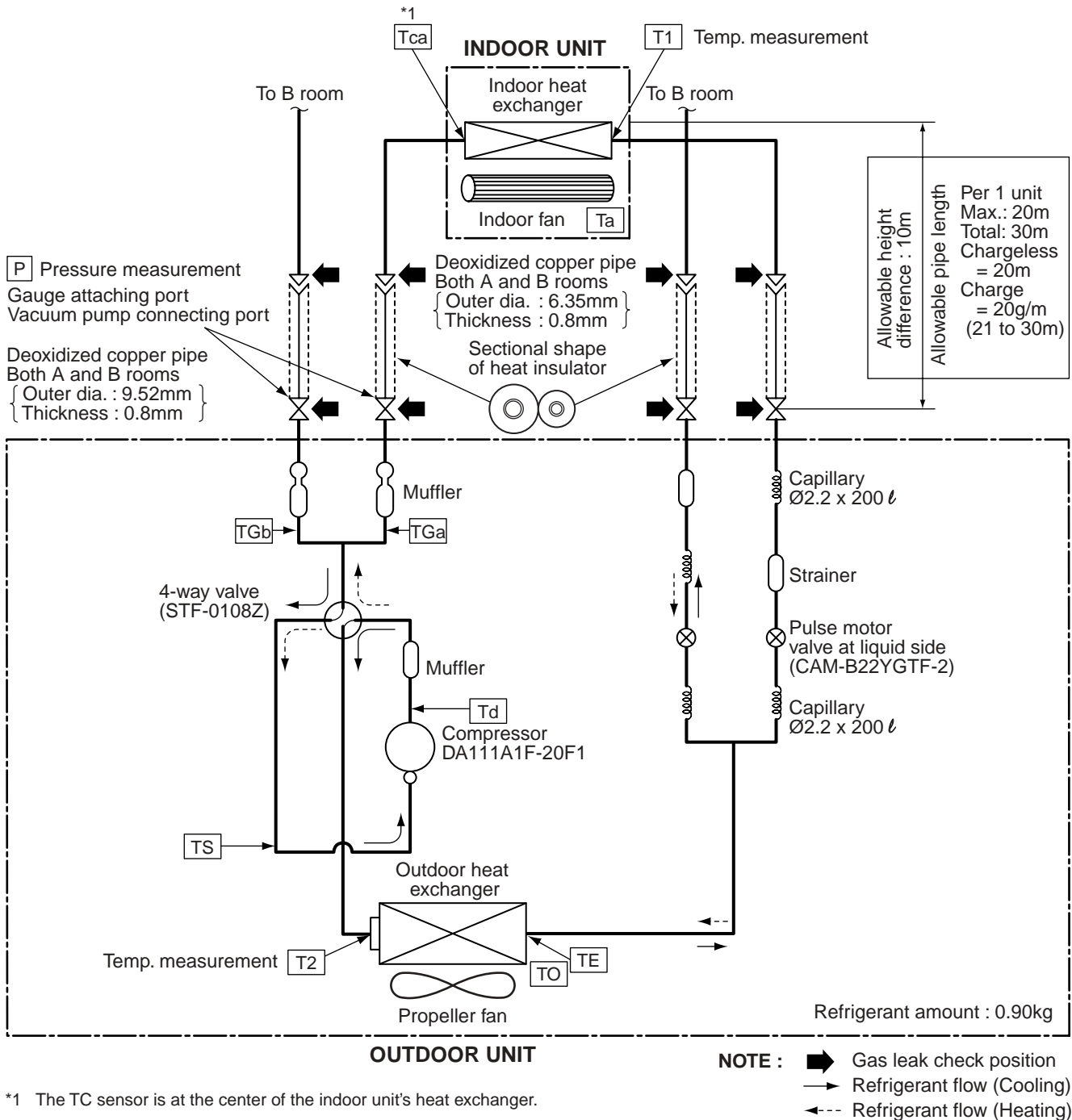

\*1 The TC sensor is at the center of the indoor unit's heat exchanger.

#### NOTE :

- The maximum pipe length of this air conditioner is 30m. When the pipe length exceeds 20m, the additional charge of refrigerant, 20g per 1m for the part of pipe exceeded 20m is required (Max. 200g)

**RAS-M13EKCVP-E, RAS-M10EKCVP-E  
RAS- M14EACV-E**

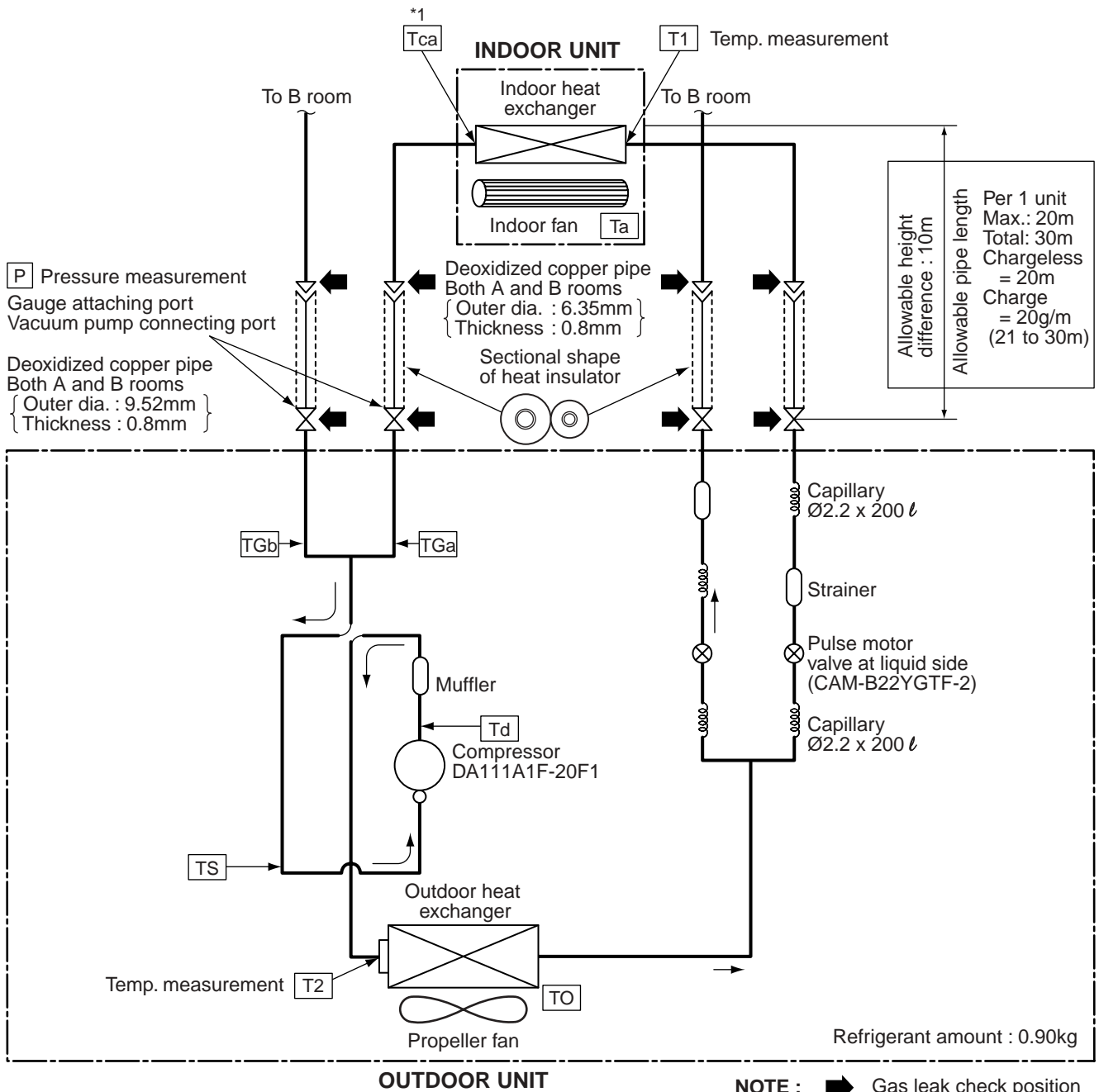

\*1 The TC sensor is at the center of the indoor unit's heat exchanger.

**NOTE :**

- The maximum pipe length of this air conditioner is 30m. When the pipe length exceeds 20m, the additional charge of refrigerant, 20g per 1m for the part of pipe exceeded 20m is required (Max. 200g)

**RAS-B16EKVP-E, RAS-B13EKVP-E, RAS-B10KVP-E  
RAS-M18EAV-E**

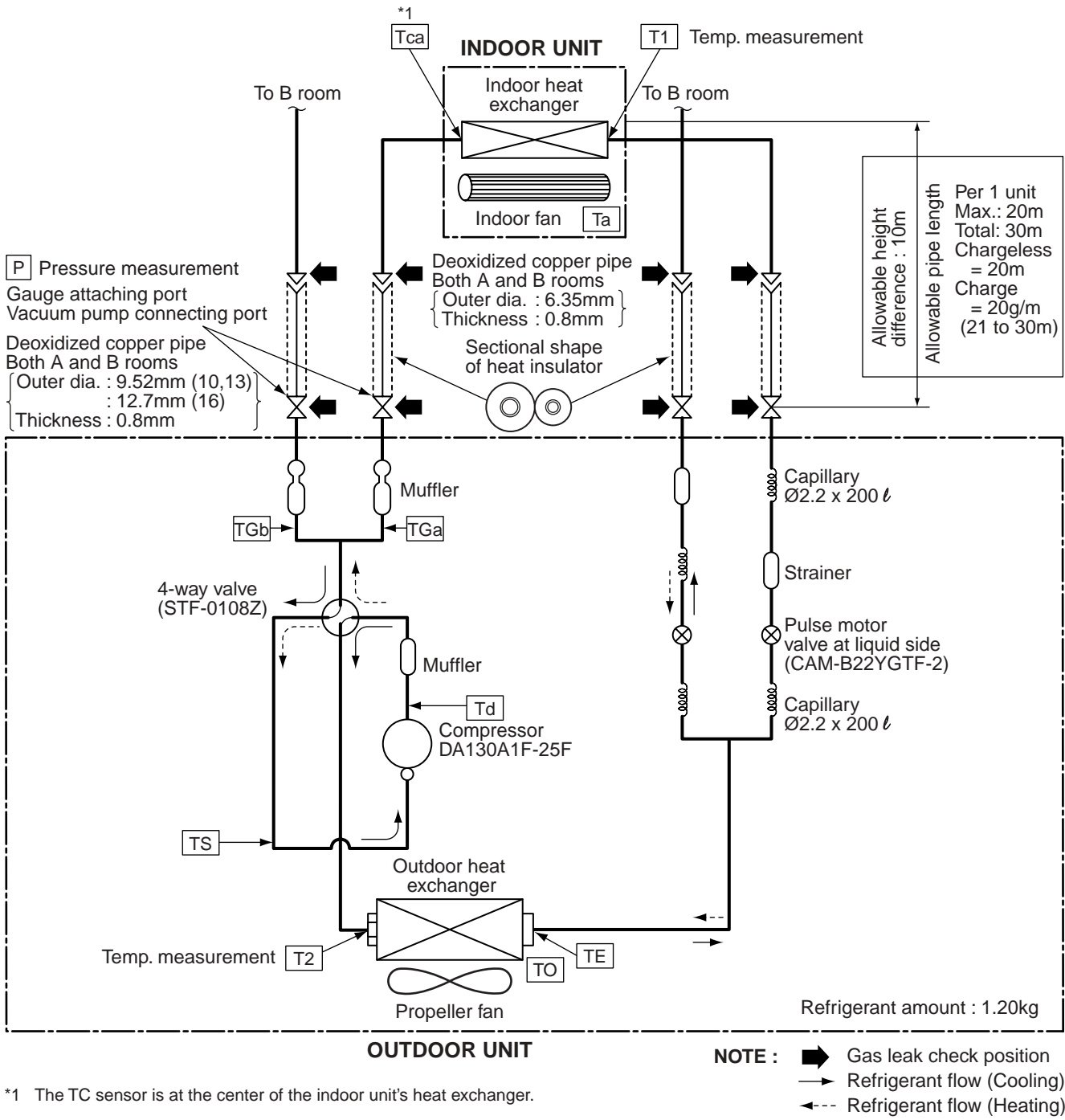

\*1 The TC sensor is at the center of the indoor unit's heat exchanger.

**NOTE :**

- The maximum pipe length of this air conditioner is 30m. When the pipe length exceeds 20m, the additional charge of refrigerant, 20g per 1m for the part of pipe exceeded 20m is required (Max. 200g)

**RAS-M16EKCVP-E, RAS-M13EKCVP-E, RAS-M10EKCVP-E  
RAS-M18EACV-E**

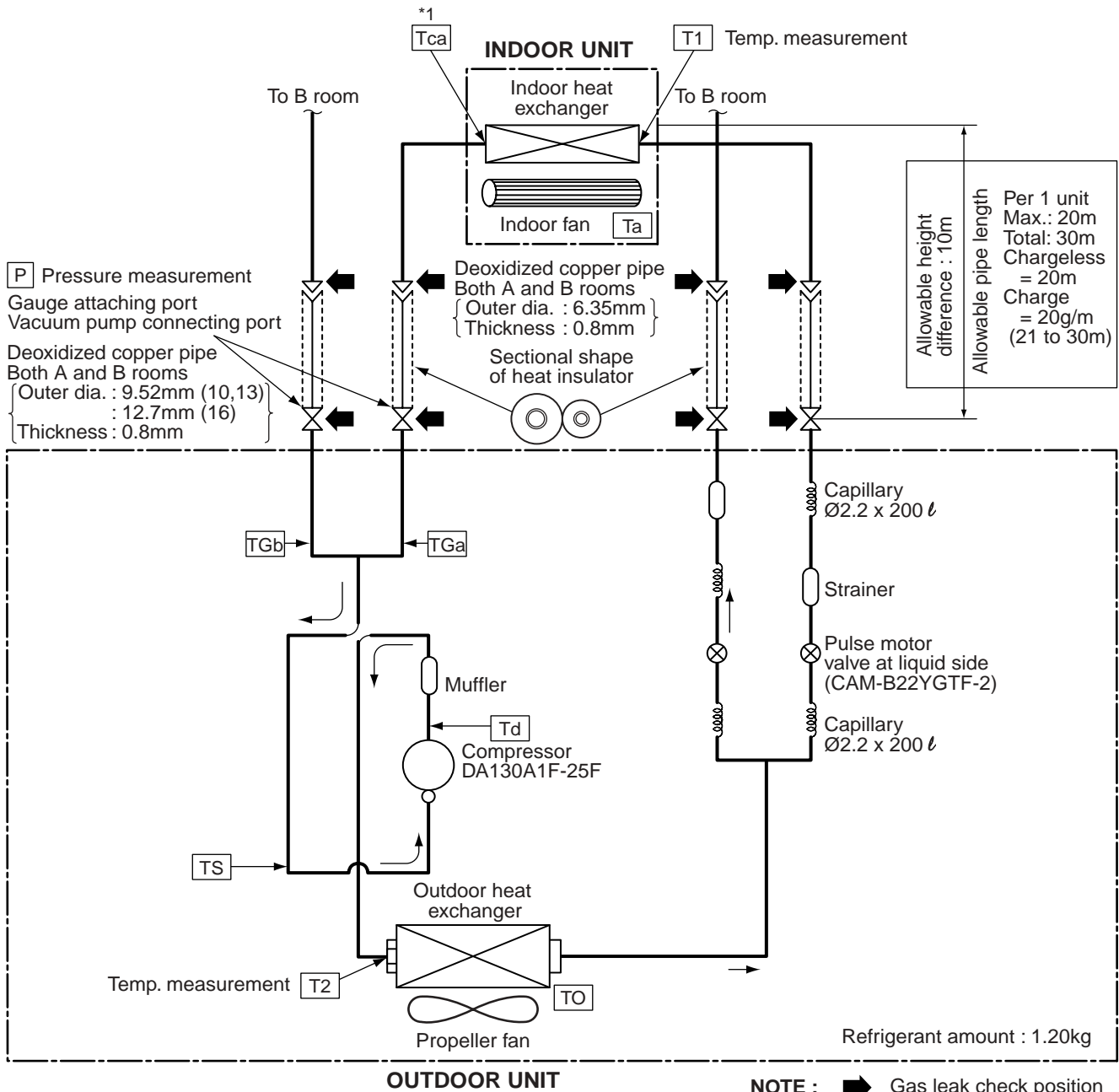

\*1 The TC sensor is at the center of the indoor unit's heat exchanger.

**NOTE :**

- The maximum pipe length of this air conditioner is 30m. When the pipe length exceeds 20m, the additional charge of refrigerant, 20g per 1m for the part of pipe exceeded 20m is required (Max. 200g)

## 7-2. Operation Data

<Cooling> RAS-M14EAV-E, RAS-M14EACV-E

Temperature condition		No. of operating units	Operating combination (Unit)		Standard pressure P (Mpa)	Heat exchanger pipe temp.		In-door fan	Out-door fan	compressor revolution (rps)
indoor	outdoor		A	B		T1 (°C)	T2 (°C)			
27 / 19	35 / -	1 unit	10		0.7 to 0.9	11 to 13	43 to 45	High	700rpm	39
			13		0.9 to 1.1	8 to 11	47 to 49	High	750rpm	66
		2 units	10	10	0.9 to 1.1	14 to 16	47 to 49	High	750rpm	64
			13	10	0.9 to 1.1	14 to 16	47 to 49	High	750rpm	65

<Heating> RAS-M14EAV-E

Temperature condition		No. of operating units	Operating combination (Unit)		Standard pressure P (Mpa)	Heat exchanger pipe temp.		In-door fan	Out-door fan	compressor revolution (rps)
indoor	outdoor		A	B		T1 (°C)	T2 (°C)			
20/-	7/6	1 unit	10		2.2 to 2.4	36 to 38	0 to 2	High	750rpm	60
			13		2.5 to 2.7	41 to 43	-1 to 1	High	750rpm	76
		2 units	10	10	1.9 to 2.1	30 to 32	-1 to 1	High	750rpm	78
			13	10	1.9 to 2.1	30 to 32	-1 to 1	High	750rpm	80

<Cooling> RAS-M18EAV-E, RAS-M18EACV-E

Temperature condition		No. of operating units	Operating combination (Unit)		Standard pressure P (Mpa)	Heat exchanger pipe temp.		In-door fan	Out-door fan	compressor revolution (rps)
indoor	outdoor		A	B		T1 (°C)	T2 (°C)			
27/19	35/-	1 unit	10		0.9 to 1.1	11 to 13	41 to 43	High	700rpm	35
			13		0.8 to 1.0	8 to 10	45 to 47	High	750rpm	58
			16		0.8 to 1.0	7 to 9	47 to 49	High	750rpm	75
		2 units	10	10	0.9 to 1.1	11 to 13	48 to 50	High	750rpm	71
			13	10	0.9 to 1.1	11 to 13	48 to 50	High	750rpm	71
			13	13	0.9 to 1.1	11 to 13	48 to 50	High	750rpm	71
		16	10	0.9 to 1.1	11 to 13	48 to 50	High	750rpm	71	

<Heating> RAS-M18EAV-E

Temperature condition		No. of operating units	Operating combination (Unit)		Standard pressure P (Mpa)	Heat exchanger pipe temp.		In-door fan	Out-door fan	compressor revolution (rps)
indoor	outdoor		A	B		T1 (°C)	T2 (°C)			
20/-	7/6	1 unit	10		3.2 to 3.4	44 to 46	0 to 2	High	750rpm	62
			13		3.4 to 3.6	50 to 53	0 to 2	High	750rpm	81
			16		3.4 to 3.6	51 to 53	0 to 2	High	750rpm	85
		2 units	10	10	2.6 to 2.8	37 to 39	-1 to 1	High	750rpm	93
			13	10	2.6 to 2.8	38 to 40	-1 to 1	High	750rpm	101
			13	13	2.6 to 2.8	38 to 40	-1 to 1	High	750rpm	101
		16	10	2.6 to 2.8	38 to 40	-1 to 1	High	750rpm	101	

### NOTES :

- (1) Measure surface temperature of heat exchanger pipe around center of heat exchanger path U bent.  
(Thermistor thermometer)
- (2) Connecting piping condition : 7.5meters · 2 units

## 8. CONTROL BLOCK DIAGRAM

### 8-1. Indoor Unit

RAS-B10EKVP-E, RAS-B13EKVP-E, RAS-B16EKVP-E

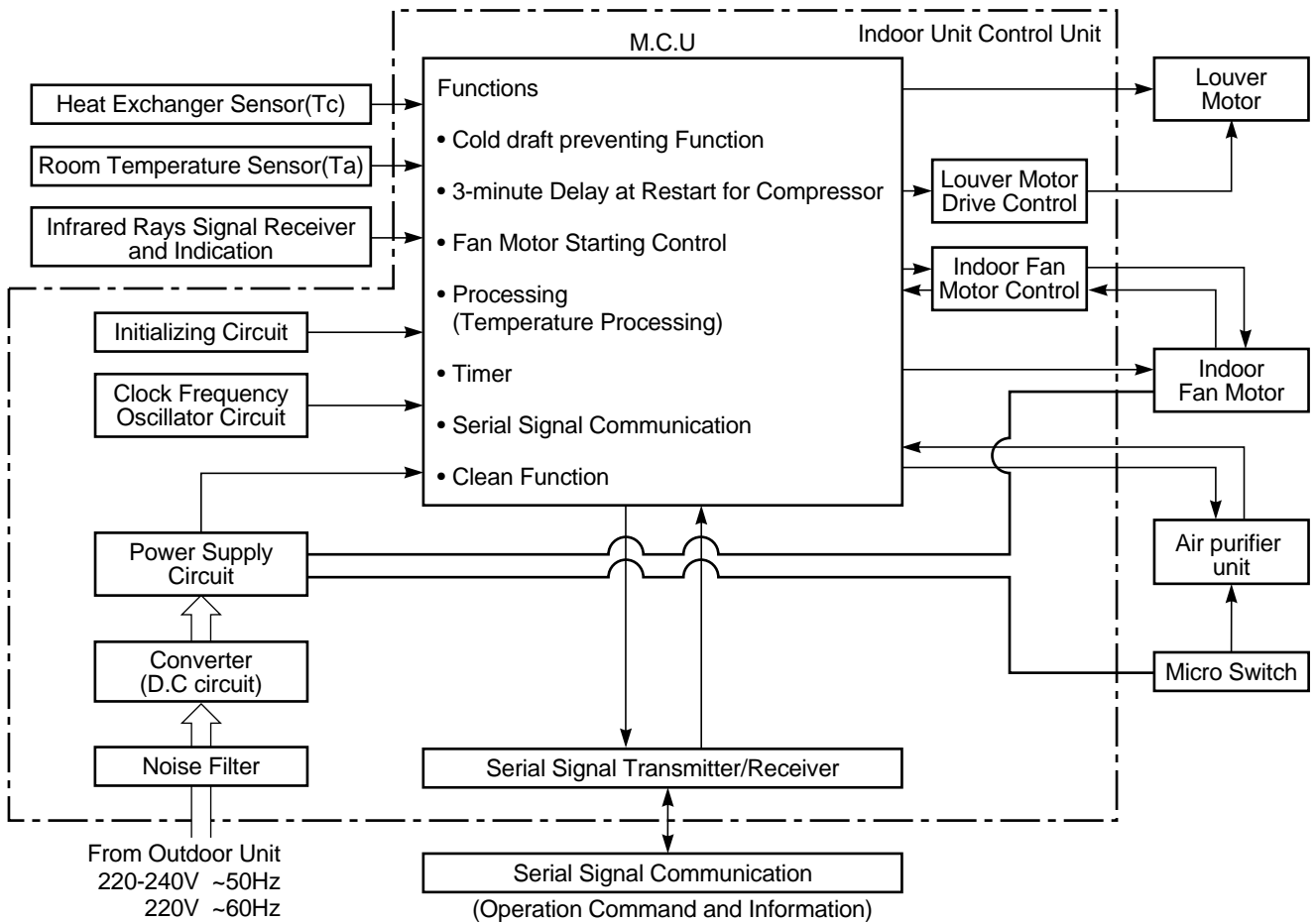

### REMOTE CONTROLLER

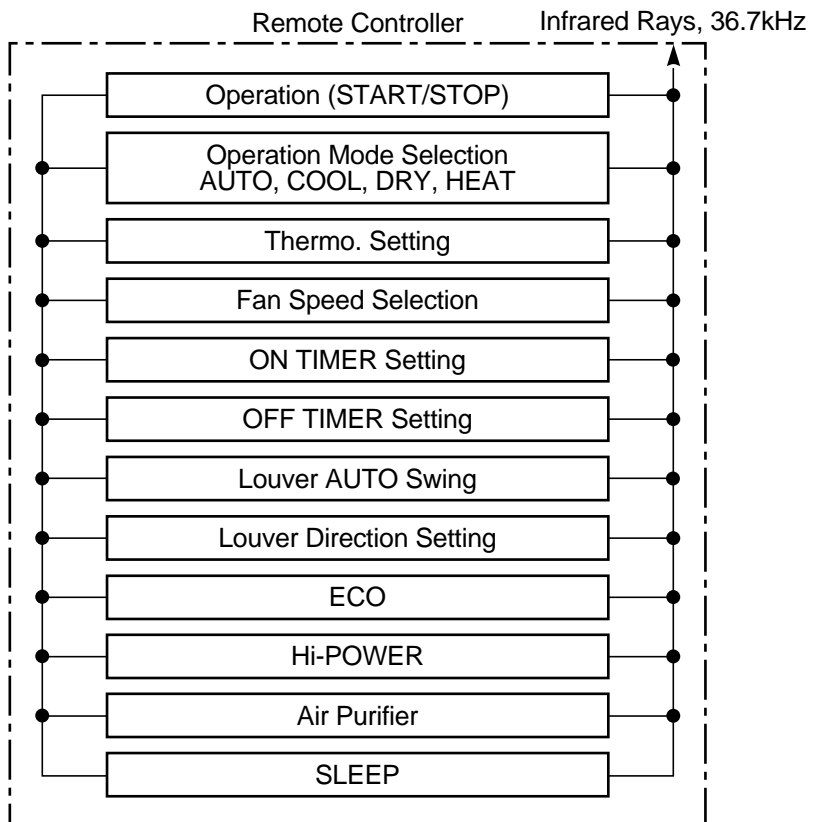

**RAS-M10EKCV-E, RAS-M13EKCV-E, RAS-M16EKCV-E**

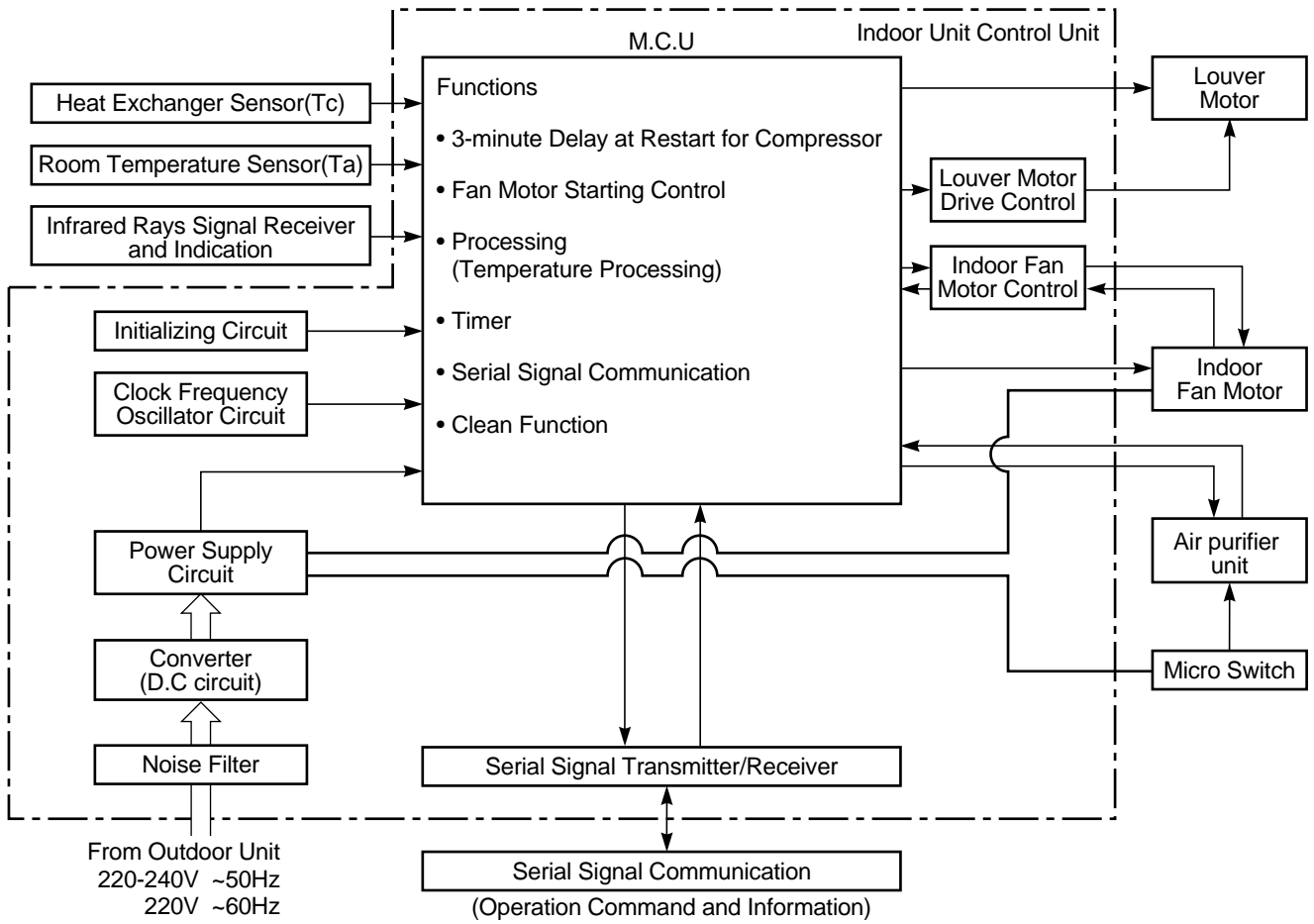

**REMOTE CONTROLLER**

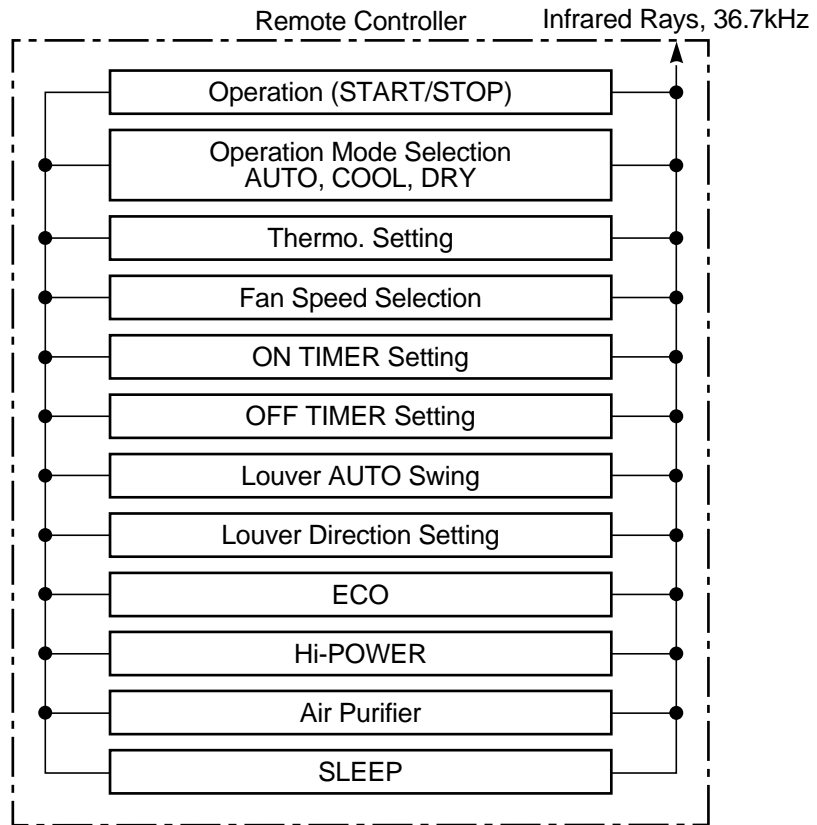



# CONTROL BLOK DIAGRAM (Outdoor unit)

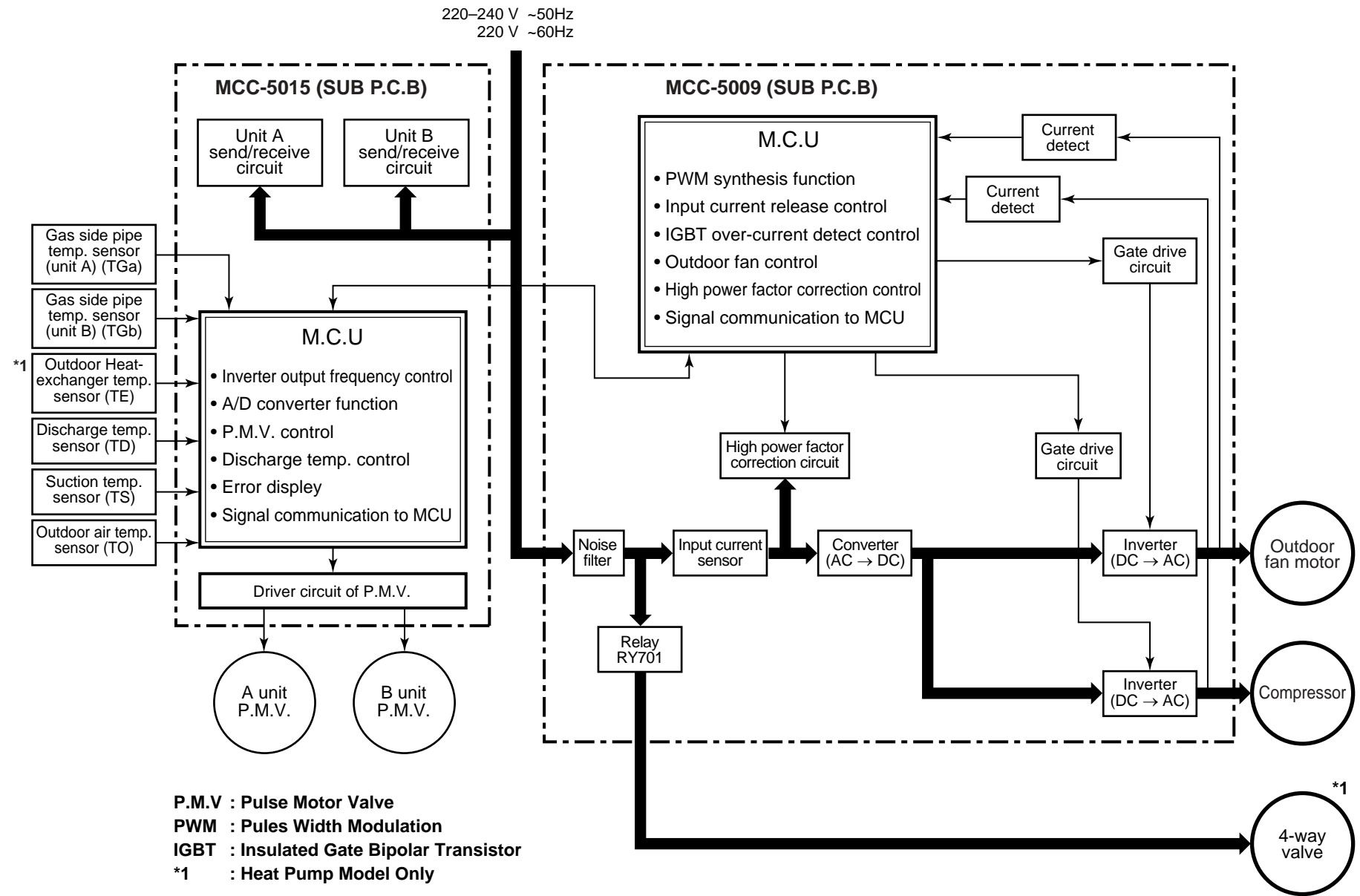

**P.M.V** : Pulse Motor Valve  
**PWM** : Pules Width Modulation  
**IGBT** : Insulated Gate Bipolar Transistor  
**\*1** : Heat Pump Model Only

**8-2. Outdoor Unit (Inverter Assembly)**  
 RAS-M14EAV-E, RAS-M18EAV-E (Heat pump models)  
 RAS-M14EACV-E, RAS-M18EACV-E (Cooling-only models)

## 9. OPERATION DESCRIPTION

### 9-1. Outline of Air Conditioner Control

This air conditioner is a capacity-variable type air conditioner, which uses DC motor for the indoor fan motor and the outdoor fan motor. And the capacity-proportional control compressor which can change the motor speed in the range from 9 to 120 rps is mounted. The DC motor drive circuit is mounted to the indoor unit. The compressor and the inverter to control fan motor are mounted to the outdoor unit. The entire air conditioner is mainly controlled by the indoor unit controller.

The indoor unit controller drives the indoor fan motor based upon command sent from the remote controller, and transfers the operation command to the outdoor unit controller.

The outdoor unit controller receives operation command from the indoor unit side, and controls the outdoor fan and the pulse motor valve. (P.M.V) Besides, detecting revolution position of the compressor motor, the outdoor unit controller controls speed of the compressor motor by controlling output voltage of the inverter and switching timing of the supply power (current transfer timing) so that motors drive according to the operation command.

And then, the outdoor unit controller transfers reversely the operating status information of the outdoor unit to control the indoor unit controller.

**As the compressor adopts four-pole brushless DC motor, the frequency of the supply power from inverter to compressor is two-times cycles of the actual number of revolution.**

#### (1) Role of indoor unit controller

The indoor unit controller judges the operation commands from the remote controller and assumes the following functions.

- Judgment of suction air temperature of the indoor heat exchanger by using the indoor temp. sensor. (TA sensor)
- Judgment of the indoor heat exchanger temperature by using heat exchanger sensor (TC sensor) (Prevent-freezing control, etc.)
- Louver motor control
- Indoor fan motor operation control
- LED (Light Emitting Diode) display control
- Transferring of operation command signal (Serial signal) to the outdoor unit
- Reception of information of operation status (Serial signal including outside temp. data) to the outdoor unit and judgment/display of error
- Air purifier operation control

#### (2) Role of outdoor unit controller

Receiving the operation command signal (Serial signal) from the indoor unit controller, the outdoor unit performs its role.

- Compressor operation control
  - Operation control of outdoor fan motor
  - P.M.V. control
  - 4-way valve control
- } Operations followed to judgment of serial signal from indoor side.

- Detection of inverter input current and current release operation
- Over-current detection and prevention operation to IGBT module (Compressor stop function)
- Compressor and outdoor fan stop function when serial signal is off (when the serial signal does not reach the board assembly of outdoor control by trouble of the signal system)
- Transferring of operation information (Serial signal) from outdoor unit controller to indoor unit controller
- Detection of outdoor temperature and operation revolution control
- Defrost control in heating operation (Temp. measurement by outdoor heat exchanger and control for four-way valve and outdoor fan)

#### (3) Contents of operation command signal (Serial signal) from indoor unit controller to outdoor unit controller

The following three types of signals are sent from the indoor unit controller.

- Operation mode set on the remote control
- Compressor revolution command signal defined by indoor temperature and set temperature (Correction along with variation of room temperature and correction of indoor heat exchanger temperature are added.)
- Temperature of indoor heat exchanger
- For these signals ([Operation mode] and [Compressor revolution] indoor heat exchanger temperature), the outdoor unit controller monitors the input current to the inverter, and performs the followed operation within the range that current does not exceed the allowable value.

#### (4) Contents of operation command signal (Serial signal) from outdoor unit controller to indoor unit controller

The following signals are sent from the outdoor unit controller.

- The current operation mode
  - The current compressor revolution
  - Outdoor temperature
  - Existence of protective circuit operation
- For transferring of these signals, the indoor unit controller monitors the contents of signals, and judges existence of trouble occurrence. Contents of judgment are described below.
- Whether distinction of the current operation status meets to the operation command signal
  - Whether protective circuit operates
- When no signal is received from the outdoor unit controller, it is assumed as a trouble.







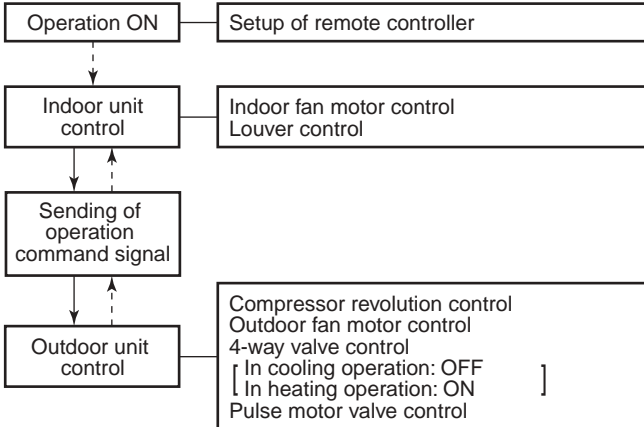

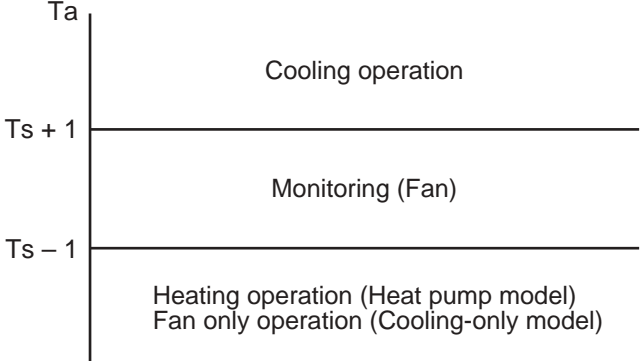
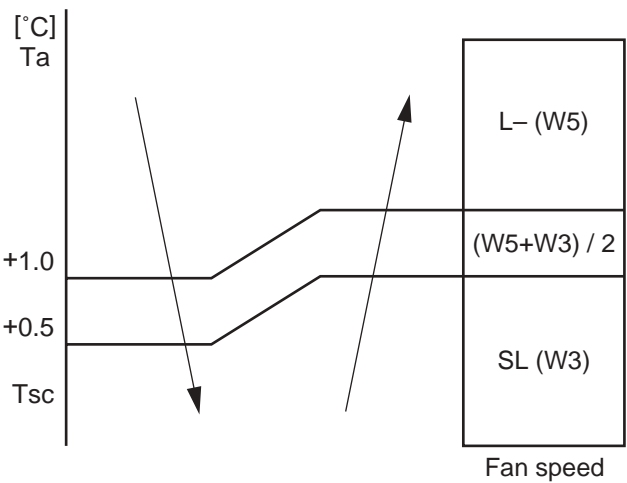

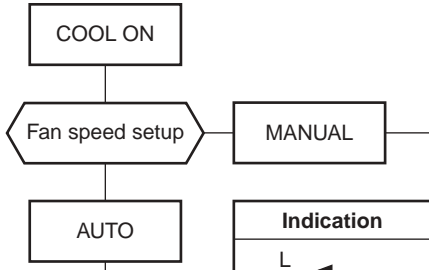



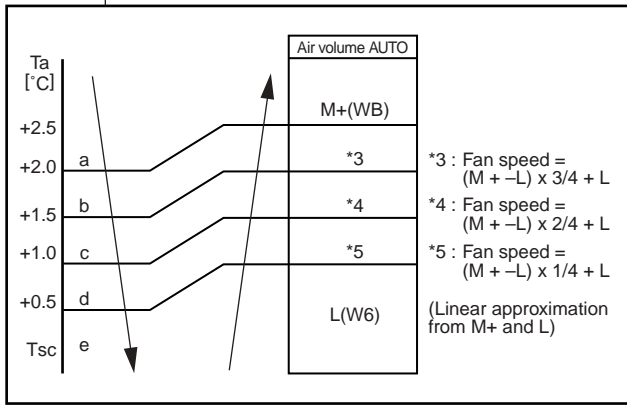

## 9-2. Operation Description

No.	Contents	Page
9-2	1 Basic operation .....	36
	1) Operation control .....	36
	2) Operating mode selection .....	37
	3) Cooling/Heating operation .....	37
	4) AUTO operation .....	38
	5) DRY operation .....	38
	2 Indoor fan motor control .....	39
	<In cooling operation> .....	39
	<In heating operation> .....	40
	3 Outdoor fan motor control .....	41
	4 Capacity control.....	43
	5 Current release control .....	43
	6 Release protective control .....	44
	<In cooling/dry operation> .....	44
	<In heating operation> .....	44
	7 Winding/Coil heating control .....	45
	8 Defrost control (Only in heating operation) .....	45
9 Louver control .....	1) Louver position .....	46
	2) Air direction adjustment .....	46
	3) Swing .....	46
10 ECO operation .....	47	
11 Temporary operation .....	48	
12 Air purifying control.....	Air purifying control .....	49
	Air purifying control [Detection of abnormality] .....	50
13 Discharge temperature control .....	50	
14 Pulse Motor valve (PMV) control .....	51	
15 Clean operation .....	52	
16 Clean operation release .....	53	
17 Select switch on remote controller .....	54	
9-3	Auto Restart Function .....	55
	1 How to Set the Auto Restart Function .....	55
	2 How to Cancel the Auto Restart Function .....	56
	3 Power Failure During Timer Operation .....	56
9-4	FILTER Indicator .....	56
	1 How to Turn Off FILTER Indicator .....	56
9-5	Remote Controller and Its Functions .....	57
	1 Parts Name of Remote Controller .....	57
	2 Name and Functions of Indications on Remote Controller .....	58
9-6	Hi-POWER Mode .....	59

Item	Operation flow and applicable data, etc.	Description
<p>1. Basic operation</p>	<p>1) Operation control Receiving the user's operation condition setup, the operation statuses of indoor/outdoor units are controlled.</p> <p style="text-align: center;"><b>Remote controller</b></p> <div style="border: 1px solid black; padding: 5px; margin-bottom: 10px;"> <div style="display: flex; justify-content: space-between;"> <div style="border: 1px solid black; padding: 2px;">Selection of operation conditions</div> <div style="border: 1px solid black; padding: 2px;">Control contents of remote controller</div> </div> <div style="display: flex; justify-content: space-between; margin-top: 5px;"> <div style="border: 1px solid black; padding: 2px;">ON/OFF</div> <div> <ul style="list-style-type: none"> <li>• ON/OFF (Air conditioner/Air purifier)</li> <li>• Operation select (COOL/HEAT/AUTO/DRY)</li> <li>• Temperature setup</li> <li>• Air direction</li> <li>• Swing</li> <li>• Air volume select (AUTO/LOW/LOW+/MED/MED+/HIGH)</li> <li>• ECO</li> <li>• ON timer setup</li> <li>• OFF timer setup</li> <li>• High power</li> </ul> </div> </div> </div> <p style="text-align: center;"><b>Indoor unit</b></p> <div style="border: 1px solid black; padding: 5px; margin-bottom: 10px;"> <div style="display: flex; justify-content: space-between;"> <div style="border: 1px solid black; padding: 2px;">Signal receiving</div> <div style="border: 1px solid black; padding: 2px;">Indoor unit control</div> </div> <div style="display: flex; justify-content: space-between; margin-top: 5px;"> <div style="border: 1px solid black; padding: 2px;">Indoor unit control</div> <div> <ul style="list-style-type: none"> <li>• Command signal generating function of indoor unit operation</li> <li>• Calculation function (temperature calculation)</li> <li>• Activation compensation function of indoor fan</li> <li>• Cold draft preventive function</li> <li>• Timer function</li> <li>• Indoor heat exchanger release control</li> <li>• Clean function</li> </ul> </div> </div> <div style="display: flex; justify-content: space-between; margin-top: 5px;"> <div style="border: 1px solid black; padding: 2px;">Operation command</div> <div style="border: 1px solid black; padding: 2px;">Serial signal send/receive</div> </div> </div> <p style="text-align: center;"><b>Outdoor unit</b></p> <div style="border: 1px solid black; padding: 5px;"> <div style="display: flex; justify-content: space-between;"> <div style="border: 1px solid black; padding: 2px;">Serial signal send/receive</div> <div style="border: 1px solid black; padding: 2px;">Outdoor unit control</div> </div> <div style="display: flex; justify-content: space-between; margin-top: 5px;"> <div style="border: 1px solid black; padding: 2px;">Outdoor unit control</div> <div> <ul style="list-style-type: none"> <li>• Frequency control of inverter output</li> <li>• Waveform composite function</li> <li>• Calculation function (Temperature calculation)</li> <li>• AD conversion function</li> <li>• Quick heating function</li> <li>• Delay function of compressor reactivation</li> <li>• Current release function</li> <li>• GTr over-current preventive function</li> <li>• Defrost operation function</li> </ul> </div> </div> <div style="display: flex; justify-content: space-between; margin-top: 5px;"> <div style="border: 1px solid black; padding: 2px;">Inverter</div> <div> <ul style="list-style-type: none"> <li>• Compressor</li> <li>• Outdoor fan motor</li> <li>• 4-way valve</li> <li>• Pulse motor valve (PMV)</li> </ul> </div> </div> </div>	<p>1) The operation conditions are selected by the remote controller as shown in the left.</p> <p>2) A signal is sent by ON button of the remote controller.</p> <p>3) The signal is received by a sensor of the indoor unit and processed by the indoor controllers as shown in the left.</p> <p>4) The indoor controller controls the indoor fan motor and louver motor.</p> <p>5) The indoor controller sends the operation command to the outdoor controller, and sends/receives the control status with a serial signal.</p> <p>6) The outdoor controller controls the operation as shown in the left, and also controls the compressor, outdoor fan motor, 4-way valve and pulse motor valve.</p> <ul style="list-style-type: none"> <li>• Indoor fan motor</li> <li>• Louver motor</li> </ul>

Item	Operation flow and applicable data, etc.	Description																																																																																																																																					
1. Basic operation	<p>2) Operating mode selection when performing 2-room operation</p> <table border="1" data-bbox="323 342 970 1391"> <thead> <tr> <th>No.</th> <th>Indoor unit</th> <th>Set operating mode</th> <th>Actual indoor unit operation</th> <th>Actual outdoor unit operation</th> </tr> </thead> <tbody> <tr> <td rowspan="2">1</td> <td>Indoor unit pressed</td> <td>Cooling (dry)</td> <td>Cooling (dry)</td> <td rowspan="2">Cooling</td> </tr> <tr> <td>Indoor unit pressed last</td> <td>Cooling (dry)</td> <td>Cooling (dry)</td> </tr> <tr> <td rowspan="2">2</td> <td>Indoor unit pressed</td> <td>Heating</td> <td>Heating</td> <td rowspan="2">Heating</td> </tr> <tr> <td>Indoor unit pressed last</td> <td>Heating</td> <td>Heating</td> </tr> <tr> <td rowspan="2">3</td> <td>Indoor unit pressed</td> <td>Fan (solo air purification)</td> <td>Fan (solo air purification)</td> <td rowspan="2">Stopped</td> </tr> <tr> <td>Indoor unit pressed last</td> <td>Fan (solo air purification)</td> <td>Fan (solo air purification)</td> </tr> <tr> <td rowspan="2">4</td> <td>Indoor unit pressed</td> <td>Fan (solo air purification)</td> <td>Fan (solo air purification)</td> <td rowspan="2">Cooling</td> </tr> <tr> <td>Indoor unit pressed last</td> <td>Cooling (dry)</td> <td>Cooling (dry)</td> </tr> <tr> <td rowspan="2">5</td> <td>Indoor unit pressed</td> <td>Cooling (dry)</td> <td>Cooling (dry)</td> <td rowspan="2">Cooling</td> </tr> <tr> <td>Indoor unit pressed last</td> <td>Fan (solo air purification)</td> <td>Fan (solo air purification)</td> </tr> <tr> <td rowspan="2">6</td> <td>Indoor unit pressed</td> <td>Cooling (dry)</td> <td>Cooling (dry)</td> <td rowspan="2">Cooling</td> </tr> <tr> <td>Indoor unit pressed last</td> <td>Heating</td> <td>Fan stopped</td> </tr> <tr> <td rowspan="2">7</td> <td>Indoor unit pressed</td> <td>Heating</td> <td>Heating</td> <td rowspan="2">Heating</td> </tr> <tr> <td>Indoor unit pressed last</td> <td>Cooling (dry)</td> <td>Fan stopped</td> </tr> <tr> <td rowspan="2">8</td> <td>Indoor unit pressed</td> <td>Fan (solo air purification)</td> <td>Fan (solo air purification)</td> <td rowspan="2">Stopped</td> </tr> <tr> <td>Indoor unit pressed last</td> <td>Heating</td> <td>Fan stopped</td> </tr> <tr> <td rowspan="2">9</td> <td>Indoor unit pressed</td> <td>Heating</td> <td>Heating</td> <td rowspan="2">Heating</td> </tr> <tr> <td>Indoor unit pressed last</td> <td>Fan (solo air purification)</td> <td>Fan stopped</td> </tr> <tr> <td rowspan="2">10</td> <td>Indoor unit pressed</td> <td>Cleaning operation</td> <td>Cleaning operation</td> <td rowspan="2">Stopped</td> </tr> <tr> <td>Indoor unit pressed last</td> <td>Cleaning operation</td> <td>Cleaning operation</td> </tr> <tr> <td rowspan="2">11</td> <td>Indoor unit pressed</td> <td>Cleaning operation</td> <td>Cleaning operation</td> <td rowspan="2">Cooling</td> </tr> <tr> <td>Indoor unit pressed last</td> <td>Cooling (dry)</td> <td>Cooling (dry)</td> </tr> <tr> <td rowspan="2">12</td> <td>Indoor unit pressed</td> <td>Cooling (dry)</td> <td>Cooling (dry)</td> <td rowspan="2">Cooling</td> </tr> <tr> <td>Indoor unit pressed last</td> <td>Cleaning operation</td> <td>Cleaning operation</td> </tr> <tr> <td rowspan="2">13</td> <td>Indoor unit pressed</td> <td>Cleaning operation</td> <td>Cleaning operation</td> <td rowspan="2">Stopped</td> </tr> <tr> <td>Indoor unit pressed last</td> <td>Fan (solo air purification)</td> <td>Fan (solo air purification)</td> </tr> <tr> <td rowspan="2">14</td> <td>Indoor unit pressed</td> <td>Fan (solo air purification)</td> <td>Fan (solo air purification)</td> <td rowspan="2">Stopped</td> </tr> <tr> <td>Indoor unit pressed last</td> <td>Cleaning operation</td> <td>Cleaning operation</td> </tr> <tr> <td rowspan="2">15</td> <td>Indoor unit pressed</td> <td>Cleaning operation</td> <td>Cleaning operation</td> <td rowspan="2">Stopped</td> </tr> <tr> <td>Indoor unit pressed last</td> <td>Heating</td> <td>Fan stopped</td> </tr> <tr> <td rowspan="2">16</td> <td>Indoor unit pressed</td> <td>Heating</td> <td>Heating</td> <td rowspan="2">Heating</td> </tr> <tr> <td>Indoor unit pressed last</td> <td>Cleaning operation</td> <td>Fan stopped</td> </tr> </tbody> </table>	No.	Indoor unit	Set operating mode	Actual indoor unit operation	Actual outdoor unit operation	1	Indoor unit pressed	Cooling (dry)	Cooling (dry)	Cooling	Indoor unit pressed last	Cooling (dry)	Cooling (dry)	2	Indoor unit pressed	Heating	Heating	Heating	Indoor unit pressed last	Heating	Heating	3	Indoor unit pressed	Fan (solo air purification)	Fan (solo air purification)	Stopped	Indoor unit pressed last	Fan (solo air purification)	Fan (solo air purification)	4	Indoor unit pressed	Fan (solo air purification)	Fan (solo air purification)	Cooling	Indoor unit pressed last	Cooling (dry)	Cooling (dry)	5	Indoor unit pressed	Cooling (dry)	Cooling (dry)	Cooling	Indoor unit pressed last	Fan (solo air purification)	Fan (solo air purification)	6	Indoor unit pressed	Cooling (dry)	Cooling (dry)	Cooling	Indoor unit pressed last	Heating	Fan stopped	7	Indoor unit pressed	Heating	Heating	Heating	Indoor unit pressed last	Cooling (dry)	Fan stopped	8	Indoor unit pressed	Fan (solo air purification)	Fan (solo air purification)	Stopped	Indoor unit pressed last	Heating	Fan stopped	9	Indoor unit pressed	Heating	Heating	Heating	Indoor unit pressed last	Fan (solo air purification)	Fan stopped	10	Indoor unit pressed	Cleaning operation	Cleaning operation	Stopped	Indoor unit pressed last	Cleaning operation	Cleaning operation	11	Indoor unit pressed	Cleaning operation	Cleaning operation	Cooling	Indoor unit pressed last	Cooling (dry)	Cooling (dry)	12	Indoor unit pressed	Cooling (dry)	Cooling (dry)	Cooling	Indoor unit pressed last	Cleaning operation	Cleaning operation	13	Indoor unit pressed	Cleaning operation	Cleaning operation	Stopped	Indoor unit pressed last	Fan (solo air purification)	Fan (solo air purification)	14	Indoor unit pressed	Fan (solo air purification)	Fan (solo air purification)	Stopped	Indoor unit pressed last	Cleaning operation	Cleaning operation	15	Indoor unit pressed	Cleaning operation	Cleaning operation	Stopped	Indoor unit pressed last	Heating	Fan stopped	16	Indoor unit pressed	Heating	Heating	Heating	Indoor unit pressed last	Cleaning operation	Fan stopped	<p>1) The outdoor unit operating mode conforms to the instructions of the indoor unit that was pressed first.</p> <p>2) When combined operation consisting of cooling (dry) and heating, fan (air purification) and heating, or cleaning operation and heating is performed, operation conforms to the instructions of the indoor unit that was pressed first as shown in the left table.</p> <p>3) The indoor fan stops for the indoor unit that was pressed last and which instructions are ignored.</p>
No.	Indoor unit	Set operating mode	Actual indoor unit operation	Actual outdoor unit operation																																																																																																																																			
1	Indoor unit pressed	Cooling (dry)	Cooling (dry)	Cooling																																																																																																																																			
	Indoor unit pressed last	Cooling (dry)	Cooling (dry)																																																																																																																																				
2	Indoor unit pressed	Heating	Heating	Heating																																																																																																																																			
	Indoor unit pressed last	Heating	Heating																																																																																																																																				
3	Indoor unit pressed	Fan (solo air purification)	Fan (solo air purification)	Stopped																																																																																																																																			
	Indoor unit pressed last	Fan (solo air purification)	Fan (solo air purification)																																																																																																																																				
4	Indoor unit pressed	Fan (solo air purification)	Fan (solo air purification)	Cooling																																																																																																																																			
	Indoor unit pressed last	Cooling (dry)	Cooling (dry)																																																																																																																																				
5	Indoor unit pressed	Cooling (dry)	Cooling (dry)	Cooling																																																																																																																																			
	Indoor unit pressed last	Fan (solo air purification)	Fan (solo air purification)																																																																																																																																				
6	Indoor unit pressed	Cooling (dry)	Cooling (dry)	Cooling																																																																																																																																			
	Indoor unit pressed last	Heating	Fan stopped																																																																																																																																				
7	Indoor unit pressed	Heating	Heating	Heating																																																																																																																																			
	Indoor unit pressed last	Cooling (dry)	Fan stopped																																																																																																																																				
8	Indoor unit pressed	Fan (solo air purification)	Fan (solo air purification)	Stopped																																																																																																																																			
	Indoor unit pressed last	Heating	Fan stopped																																																																																																																																				
9	Indoor unit pressed	Heating	Heating	Heating																																																																																																																																			
	Indoor unit pressed last	Fan (solo air purification)	Fan stopped																																																																																																																																				
10	Indoor unit pressed	Cleaning operation	Cleaning operation	Stopped																																																																																																																																			
	Indoor unit pressed last	Cleaning operation	Cleaning operation																																																																																																																																				
11	Indoor unit pressed	Cleaning operation	Cleaning operation	Cooling																																																																																																																																			
	Indoor unit pressed last	Cooling (dry)	Cooling (dry)																																																																																																																																				
12	Indoor unit pressed	Cooling (dry)	Cooling (dry)	Cooling																																																																																																																																			
	Indoor unit pressed last	Cleaning operation	Cleaning operation																																																																																																																																				
13	Indoor unit pressed	Cleaning operation	Cleaning operation	Stopped																																																																																																																																			
	Indoor unit pressed last	Fan (solo air purification)	Fan (solo air purification)																																																																																																																																				
14	Indoor unit pressed	Fan (solo air purification)	Fan (solo air purification)	Stopped																																																																																																																																			
	Indoor unit pressed last	Cleaning operation	Cleaning operation																																																																																																																																				
15	Indoor unit pressed	Cleaning operation	Cleaning operation	Stopped																																																																																																																																			
	Indoor unit pressed last	Heating	Fan stopped																																																																																																																																				
16	Indoor unit pressed	Heating	Heating	Heating																																																																																																																																			
	Indoor unit pressed last	Cleaning operation	Fan stopped																																																																																																																																				
	<p>3) Cooling/Heating operation</p> <p>The operations are performed in the following parts by controls according to cooling/heating conditions.</p>  <pre> graph TD     A[Operation ON] --&gt; B[Indoor unit control]     C[Setup of remote controller] --&gt; B     B --&gt; D[Sending of operation command signal]     D --&gt; E[Outdoor unit control]     E --&gt; B     E --&gt; F["Compressor revolution control Outdoor fan motor control 4-way valve control In cooling operation: OFF In heating operation: ON Pulse motor valve control"]   </pre>	<p>1) Receiving the operation ON signal of the remote controller, the cooling or heating operation signal starts being transferred from the indoor controller to the outdoor unit.</p> <p>2) At the indoor unit side, the indoor fan is operated according to the contents of "2. Indoor fan motor control" and the louver according to the contents of "9. Louver control", respectively.</p> <p>3) The outdoor unit controls the outdoor fan motor, compressor, pulse motor valve and 4-way valve according to the operation signal sent from the indoor unit.</p> <p>*1. The power coupler of 4-way valve is usually turned on, and it is turned off during defrost operation. (Only in heating)</p>																																																																																																																																					

Item	Operation flow and applicable data, etc.	Description
1. Basic operation	<p>4) AUTO operation</p> <p>Selection of operation mode</p> <p>As shown in the following figure, the operation starts by selecting automatically the status of room temperature (Ta) when starting AUTO operation.</p>  <p>*1. When reselecting the operation mode, the fan speed is controlled by the previous operation mode.</p>	<ol style="list-style-type: none"> <li>1) Detects the room temperature (Ta) when the operation started.</li> <li>2) Selects an operation mode from Ta in the left figure.</li> <li>3) Fan operation continues until an operation mode is selected.</li> <li>4) When AUTO operation has started within 2 hours after heating operation stopped and if the room temperature is 20°C or more, the fan operation is performed with "Super Ultra LOW" mode for 3 minutes. Then, select an operation mode.</li> <li>5) If the status of compressor-OFF continues for 15 minutes the room temperature after selecting an operation mode (COOL/HEAT), reselect an operation mode.</li> </ol>
	<p>5) DRY operation</p> <p>DRY operation is performed according to the difference between room temperature and the setup temperature as shown below.</p> <p>In DRY operation, fan speed is controlled in order to prevent lowering of the room temperature and to avoid air flow from blowing directly to persons.</p> 	<ol style="list-style-type: none"> <li>1) Detects the room temperature (Ta) when the DRY operation started.</li> <li>2) Starts operation under conditions in the left figure according to the temperature difference between the room temperature and the setup temperature (Tsc). Setup temperature (Tsc) = Set temperature on remote controller (Ts) + (0.0 to 1.0)</li> <li>3) When the room temperature is lower 1°C or less than the setup temperature, turn off the compressor.</li> </ol>

Item	Operation flow and applicable data, etc.	Description												
2. Indoor fan motor control	<p><b>&lt;In cooling operation&gt;</b> (This operation controls the fan speed at indoor unit side.)</p> <p>The indoor fan (cross flow fan) is operated by the phase-control induction motor. The fan rotates in 5 stages in MANUAL mode, and in 5 stages in AUTO mode, respectively. (Table 1)</p> <div style="text-align: center;">  <p><b>(Fig. 1)</b></p> <table border="1" style="margin-left: auto; margin-right: auto;"> <thead> <tr> <th>Indication</th> <th>Fan speed</th> </tr> </thead> <tbody> <tr> <td>L </td> <td>W6</td> </tr> <tr> <td>L+ </td> <td>(L + M) / 2</td> </tr> <tr> <td>M </td> <td>W9</td> </tr> <tr> <td>M+ </td> <td>(M + H) / 2</td> </tr> <tr> <td>H </td> <td>WC</td> </tr> </tbody> </table> <p><b>(Fig. 2)</b></p>  </div>	Indication	Fan speed	L 	W6	L+ 	(L + M) / 2	M 	W9	M+ 	(M + H) / 2	H 	WC	<div style="border: 1px solid black; padding: 5px; margin-bottom: 10px;"> <p><b>* Symbols</b></p> <p>UH : Ultra High  H : High  M+ : Medium+  M : Medium  L+ : Low+  L : Low  L- : Low-  UL : Ultra Low  SUL : Super Ultra Low</p> </div> <p>* The fan speed broadly varies due to position of the louver, etc. The described value indicates one under condition of inclining downward blowing.</p> <ol style="list-style-type: none"> <li>When setting the fan speed to L, L+, M, M+ or H on the remote controller, the operation is performed with the constant speed shown in Fig. 1.</li> <li>When setting the fan speed to AUTO on the remote controller, revolution of the fan motor is controlled to the fan speed level shown in Fig. 2 and Table 1 according to the setup temperature, room temperature, and heat exchanger temperature.</li> </ol>
Indication	Fan speed													
L 	W6													
L+ 	(L + M) / 2													
M 	W9													
M+ 	(M + H) / 2													
H 	WC													

(Table 1) Indoor fan air flow rate

Fan speed level	COOL FAN ONLY	HEAT	DRY	RAS-B10EKVP-E, RAS-M10EKVP-E		RAS-B13EKVP-E, RAS-M13EKVP-E		RAS-B16EKVP-E, RAS-M16EKVP-E	
				Fan speed (rpm)	Air flow rate (m <sup>3</sup> /h)	Fan speed (rpm)	Air flow rate (m <sup>3</sup> /h)	Fan speed (rpm)	Air flow rate (m <sup>3</sup> /h)
WF		UH		1630	684	1650	694	1650	694
WE		H		1480	609	1530	634	1580	659
WD	UH	M+	UH	1400	569	1440	589	1550	644
WC	H		H	1350	544	1390	564	1530	634
WB	M+	M	M+	1200	468	1240	488	1380	559
WA			M	1110	423	1150	443	1230	483
W9	M	L+		980	358	1010	373	1080	408
W8		L		910	323	910	323	970	353
W7	L+	L-	L+	900	318	900	318	960	348
W6	L		L	890	313	890	313	950	343
W5	L-	UL	L-	880	308	880	308	940	338
W4	UL		UL	730	232	730	232	790	263
W3	SUL		SUL	580	157	580	157	640	187
W2		SUL		430	82	430	82	490	112
W1				400	67	400	67	400	67

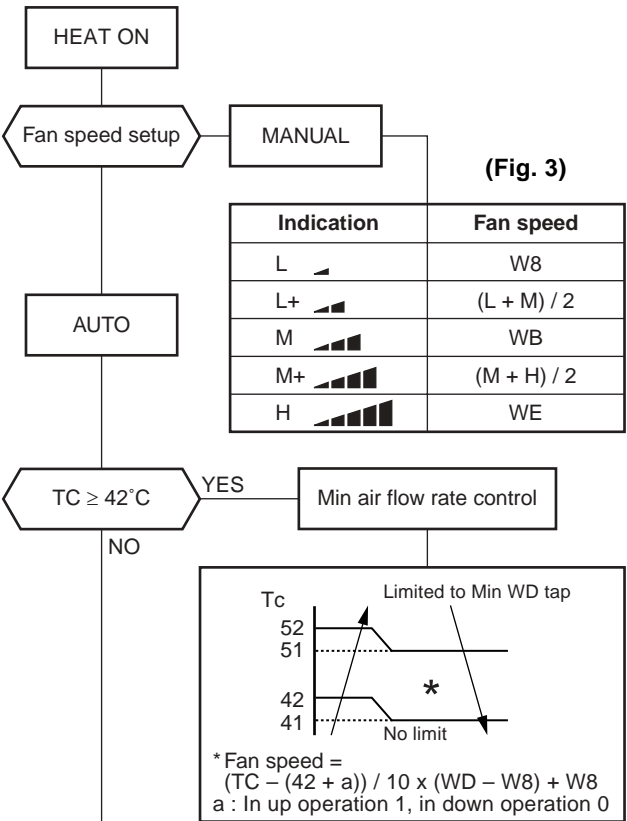
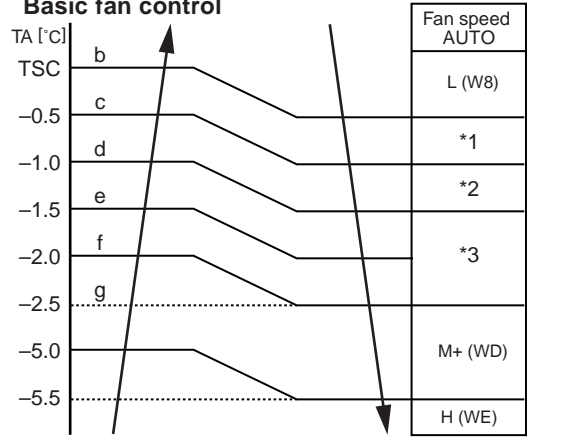
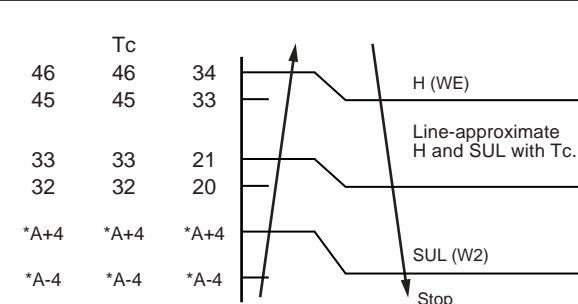
Item	Operation flow and applicable data, etc.	Description													
2. Indoor fan motor control	<p><b>&lt;In heating operation&gt; (Heat pump model)</b></p>  <table border="1" data-bbox="619 470 1018 698"> <thead> <tr> <th>Indication</th> <th>Fan speed</th> </tr> </thead> <tbody> <tr> <td>L</td> <td>W8</td> </tr> <tr> <td>L+</td> <td>(L + M) / 2</td> </tr> <tr> <td>M</td> <td>WB</td> </tr> <tr> <td>M+</td> <td>(M + H) / 2</td> </tr> <tr> <td>H</td> <td>WE</td> </tr> </tbody> </table> <p><b>(Fig. 3)</b></p> <p><b>(Fig. 4)</b></p>	Indication	Fan speed	L	W8	L+	(L + M) / 2	M	WB	M+	(M + H) / 2	H	WE	<ol style="list-style-type: none"> <li>When setting the fan speed to L, L+, M, M+ or H on the remote controller, the operation is performed with the constant speed shown in Fig. 3 and Table 1.</li> <li>When setting the fan speed to AUTO on the remote controller, revolution of the fan motor is controlled to the fan speed level shown in Fig. 5 according to the set temperature and room temperature.</li> <li>Min air flow rate is controlled by temperature of the indoor heat exchanger (Tc) as shown in Fig. 4.</li> <li>Cold draft prevention, the fan speed is controlled by temperature of the indoor heat exchanger (Tc) as shown in Fig. 6.</li> </ol>	
Indication	Fan speed														
L	W8														
L+	(L + M) / 2														
M	WB														
M+	(M + H) / 2														
H	WE														
<p><b>Basic fan control</b></p>  <table border="1" data-bbox="590 1176 710 1612"> <thead> <tr> <th>Fan speed</th> <th>AUTO</th> </tr> </thead> <tbody> <tr> <td>L</td> <td>(W8)</td> </tr> <tr> <td>*1</td> <td></td> </tr> <tr> <td>*2</td> <td></td> </tr> <tr> <td>*3</td> <td></td> </tr> <tr> <td>M+</td> <td>(WD)</td> </tr> <tr> <td>H</td> <td>(WE)</td> </tr> </tbody> </table> <p>*1: Fan speed = (M + -L) x 1 ÷ 4 + L  *2: Fan speed = (M + -L) x 2 ÷ 4 + L  *3: Fan speed = (M + -L) x 3 ÷ 4 + L  (Calculated with linear approximation from M+ and L)</p> <p><b>(Fig. 5)</b></p>	Fan speed	AUTO	L	(W8)	*1		*2		*3		M+	(WD)	H	(WE)	<p><b>Cold draft preventive control</b></p>  <p>Fan speed Fan speed Fan speed  AUTO AUTO MANUAL  in starting in stability in starting</p> <p>* No limitation while fan speed MANUAL mode is in stability.  * A: When Tsc ≥ 24, A is 24, and when Tsc &lt; 24, A is Tsc  Tsc: Set value</p> <p><b>(Fig. 6)</b></p>
Fan speed	AUTO														
L	(W8)														
*1															
*2															
*3															
M+	(WD)														
H	(WE)														
[In starting and in stability]	<table border="1" data-bbox="172 1865 1428 2049"> <thead> <tr> <th></th> <th>In starting</th> <th>In stability</th> </tr> </thead> <tbody> <tr> <td>FAN AUTO</td> <td> <ul style="list-style-type: none"> <li>Until 12 minutes passed after operation start</li> <li>When 12 to 25 minutes passed after operation start and room temp. is 3°C or lower than set temp.</li> </ul> </td> <td> <ul style="list-style-type: none"> <li>When 12 to 25 minutes passed after operation start and room temp. is higher than (set temp. -3°C)</li> <li>When 25 minutes or more passed after operation start</li> </ul> </td> </tr> <tr> <td>FAN Manual</td> <td>Room temp. &lt; Set temp. -4°C</td> <td>Room temp. ≥ Set temp. -3.5°C</td> </tr> </tbody> </table>		In starting	In stability	FAN AUTO	<ul style="list-style-type: none"> <li>Until 12 minutes passed after operation start</li> <li>When 12 to 25 minutes passed after operation start and room temp. is 3°C or lower than set temp.</li> </ul>	<ul style="list-style-type: none"> <li>When 12 to 25 minutes passed after operation start and room temp. is higher than (set temp. -3°C)</li> <li>When 25 minutes or more passed after operation start</li> </ul>	FAN Manual	Room temp. < Set temp. -4°C	Room temp. ≥ Set temp. -3.5°C					
	In starting	In stability													
FAN AUTO	<ul style="list-style-type: none"> <li>Until 12 minutes passed after operation start</li> <li>When 12 to 25 minutes passed after operation start and room temp. is 3°C or lower than set temp.</li> </ul>	<ul style="list-style-type: none"> <li>When 12 to 25 minutes passed after operation start and room temp. is higher than (set temp. -3°C)</li> <li>When 25 minutes or more passed after operation start</li> </ul>													
FAN Manual	Room temp. < Set temp. -4°C	Room temp. ≥ Set temp. -3.5°C													







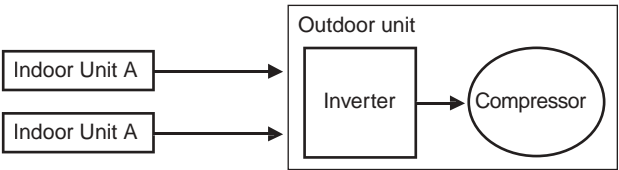
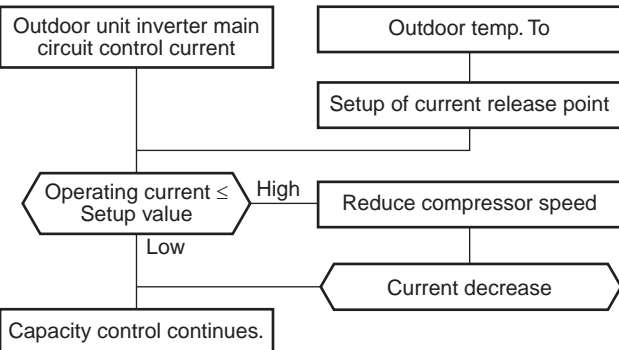

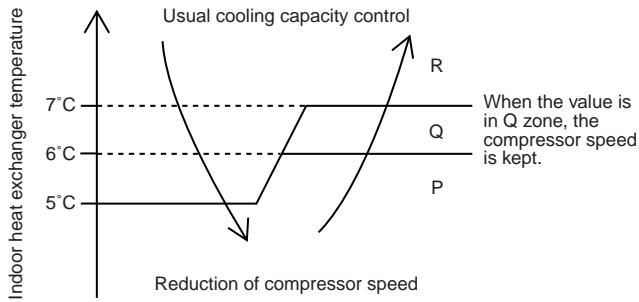
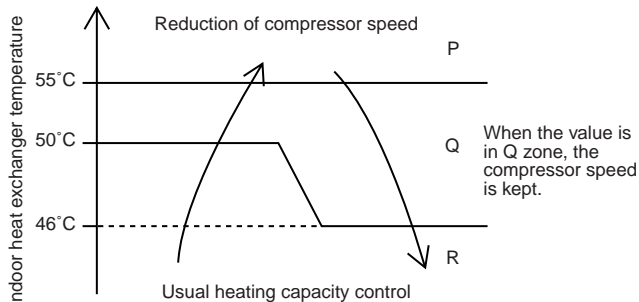

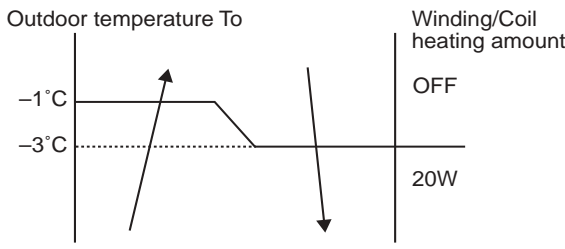
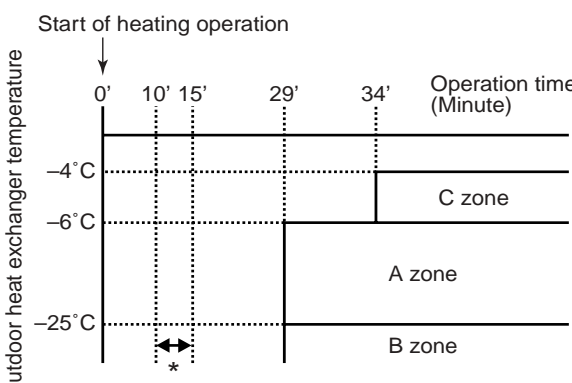

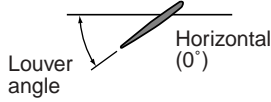











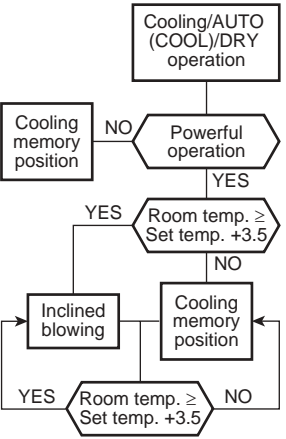
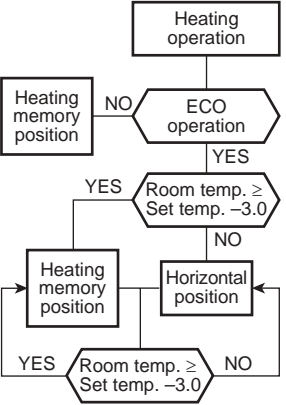











Item	Operation flow and applicable data, etc.	Description																																																																																																		
<p>3. Outdoor fan motor control</p>	<p>The blowing air volume at the outdoor unit side is controlled.</p> <p>Receiving the operation command from the controller of indoor unit, the controller of outdoor unit controls fan speed.</p> <p>* For the fan motor, a DC motor with non-stage variable speed system is used. However, it is limited to 8 stages for reasons of controlling.</p> <pre> graph TD     A[Air conditioner ON (Remote controller)] --&gt; B[Indoor unit controller]     B --&gt; C[1) Outdoor unit operation command (Outdoor fan control)]     C --&gt; D{2) Fan speed ≥ 400 when the motor stopped.}     D -- YES --&gt; E[OFF status of fan motor continues.]     D -- NO --&gt; F[Fan motor ON]     F --&gt; G{3) Fan lock}     G -- YES --&gt; H[Air conditioner OFF]     G -- NO --&gt; I[4) Motor operates as shown in the table below.]     H --&gt; J[Alarm display] </pre>	<ol style="list-style-type: none"> <li>1) The operation command sent from the remote controller is processed by the indoor unit controller and transferred to the controller of the outdoor unit.</li> <li>2) When strong wind blows at outdoor side, the operation of air conditioner continues with the fan motor stopped.</li> <li>3) Whether the fan is locked or not is detected, and the operation of air conditioner stops and an alarm is displayed if the fan is locked.</li> <li>4) According to each operation mode, by the conditions of outdoor temperature(<math>T_o</math>) and compressor revolution, the speed of the outdoor fan shown in the table is selected.</li> </ol>																																																																																																		
	<p>Cooling operation, dry operation</p> <p>RAS-M18EAV-E, RAS-M18EACV-E</p> <table border="1" data-bbox="383 1153 1021 1400"> <thead> <tr> <th colspan="2">Compressor revolution(rps)</th> <th>~20</th> <th>~30</th> <th>~46</th> <th>46~</th> </tr> </thead> <tbody> <tr> <td rowspan="5">Normal operation</td> <td><math>T_o &gt; 38^{\circ}\text{C}</math></td> <td>450</td> <td>700</td> <td>750</td> <td>850</td> </tr> <tr> <td><math>28 &lt; T_o \leq 38</math></td> <td>450</td> <td>650</td> <td>700</td> <td>750</td> </tr> <tr> <td><math>15 &lt; T_o \leq 28</math></td> <td>350</td> <td>550</td> <td>650</td> <td>700</td> </tr> <tr> <td><math>10 &lt; T_o \leq 15</math></td> <td>350</td> <td>550</td> <td>550</td> <td>550</td> </tr> <tr> <td><math>5.5 &lt; T_o \leq 10</math></td> <td>300</td> <td>450</td> <td>450</td> <td>550</td> </tr> <tr> <td rowspan="2">econo operation</td> <td><math>T_o &gt; 38^{\circ}\text{C}</math></td> <td>450</td> <td>650</td> <td>700</td> <td>750</td> </tr> <tr> <td><math>T_o \leq 38^{\circ}\text{C}</math></td> <td>450</td> <td>550</td> <td>650</td> <td>700</td> </tr> <tr> <td>To is abnormal</td> <td>-</td> <td>450</td> <td>650</td> <td>700</td> <td>750</td> </tr> </tbody> </table> <p style="text-align: center;">To: outdoor sensor temp. (°C) (rpm)</p> <p>RAS-M14EAV-E, RAS-M14EACV-E</p> <table border="1" data-bbox="383 1489 1021 1736"> <thead> <tr> <th colspan="2">Compressor revolution(rps)</th> <th>~20</th> <th>~30</th> <th>~60</th> <th>60~</th> </tr> </thead> <tbody> <tr> <td rowspan="5">Normal operation</td> <td><math>T_o &gt; 38^{\circ}\text{C}</math></td> <td>450</td> <td>700</td> <td>750</td> <td>850</td> </tr> <tr> <td><math>28 &lt; T_o \leq 38</math></td> <td>450</td> <td>650</td> <td>700</td> <td>750</td> </tr> <tr> <td><math>15 &lt; T_o \leq 28</math></td> <td>350</td> <td>550</td> <td>650</td> <td>700</td> </tr> <tr> <td><math>10 &lt; T_o \leq 15</math></td> <td>350</td> <td>550</td> <td>550</td> <td>650</td> </tr> <tr> <td><math>5.5 &lt; T_o \leq 10</math></td> <td>300</td> <td>450</td> <td>450</td> <td>550</td> </tr> <tr> <td rowspan="2">econo operation</td> <td><math>T_o &gt; 38^{\circ}\text{C}</math></td> <td>450</td> <td>650</td> <td>700</td> <td>750</td> </tr> <tr> <td><math>T_o \leq 38^{\circ}\text{C}</math></td> <td>450</td> <td>550</td> <td>650</td> <td>700</td> </tr> <tr> <td>To is abnormal</td> <td>-</td> <td>450</td> <td>650</td> <td>700</td> <td>750</td> </tr> </tbody> </table> <p style="text-align: center;">To: outdoor sensor temp. (°C) (rpm)</p>	Compressor revolution(rps)		~20	~30	~46	46~	Normal operation	$T_o > 38^{\circ}\text{C}$	450	700	750	850	$28 < T_o \leq 38$	450	650	700	750	$15 < T_o \leq 28$	350	550	650	700	$10 < T_o \leq 15$	350	550	550	550	$5.5 < T_o \leq 10$	300	450	450	550	econo operation	$T_o > 38^{\circ}\text{C}$	450	650	700	750	$T_o \leq 38^{\circ}\text{C}$	450	550	650	700	To is abnormal	-	450	650	700	750	Compressor revolution(rps)		~20	~30	~60	60~	Normal operation	$T_o > 38^{\circ}\text{C}$	450	700	750	850	$28 < T_o \leq 38$	450	650	700	750	$15 < T_o \leq 28$	350	550	650	700	$10 < T_o \leq 15$	350	550	550	650	$5.5 < T_o \leq 10$	300	450	450	550	econo operation	$T_o > 38^{\circ}\text{C}$	450	650	700	750	$T_o \leq 38^{\circ}\text{C}$	450	550	650	700	To is abnormal	-	450	650	700	750	
Compressor revolution(rps)		~20	~30	~46	46~																																																																																															
Normal operation	$T_o > 38^{\circ}\text{C}$	450	700	750	850																																																																																															
	$28 < T_o \leq 38$	450	650	700	750																																																																																															
	$15 < T_o \leq 28$	350	550	650	700																																																																																															
	$10 < T_o \leq 15$	350	550	550	550																																																																																															
	$5.5 < T_o \leq 10$	300	450	450	550																																																																																															
econo operation	$T_o > 38^{\circ}\text{C}$	450	650	700	750																																																																																															
	$T_o \leq 38^{\circ}\text{C}$	450	550	650	700																																																																																															
To is abnormal	-	450	650	700	750																																																																																															
Compressor revolution(rps)		~20	~30	~60	60~																																																																																															
Normal operation	$T_o > 38^{\circ}\text{C}$	450	700	750	850																																																																																															
	$28 < T_o \leq 38$	450	650	700	750																																																																																															
	$15 < T_o \leq 28$	350	550	650	700																																																																																															
	$10 < T_o \leq 15$	350	550	550	650																																																																																															
	$5.5 < T_o \leq 10$	300	450	450	550																																																																																															
econo operation	$T_o > 38^{\circ}\text{C}$	450	650	700	750																																																																																															
	$T_o \leq 38^{\circ}\text{C}$	450	550	650	700																																																																																															
To is abnormal	-	450	650	700	750																																																																																															

Item	Operation flow and applicable data, etc.	Description																																																																																		
	<p>Heating operation</p> <p>TE</p> <p>Zone A: Zone A: The fan revolutions are decreased by 100 rpm every 20 seconds (to the MIN revolutions). When Zone A operation continues for 5 minutes, the compressor is stopped and then restarted.</p> <p>24°C</p> <p>Zone B: Zone B: The fan revolutions are decreased by 100 rpm every 20 seconds (to the MIN revolutions).</p> <p>21°C</p> <p>Zone C: Zone C: The fan revolutions are decreased by 50 rpm every 20 seconds (to the MIN revolutions).</p> <p>18°C</p> <p>Zone D: Zone D: The fan revolutions are maintained at the current revolutions.</p> <p>15°C</p> <p>Zone E: Zone E: The fan revolutions are increased by 50 rpm every 20 seconds (to the MAX revolutions).</p>	<p>1) Operation is performed at the MAX revolutions shown in the left tables for 3 minutes after compressor operation starts and for 1 minute after defrosting operation ends.</p> <p>2) Following 1) above, operation is performed at the outdoor unit fan revolutions shown in the left tables according to the outdoor heatexchanger sensor (TE sensor) temperature.</p>																																																																																		
	<p>RAS-M18EAV-E</p> <table border="1" data-bbox="379 1025 1010 1335"> <thead> <tr> <th colspan="2">Compressor revolution(rps)</th> <th colspan="2">~20</th> <th colspan="2">~48</th> <th colspan="2">48~</th> </tr> <tr> <th></th> <th>Fan revolution</th> <th>MIN</th> <th>MAX</th> <th>MIN</th> <th>MAX</th> <th>MIN</th> <th>MAX</th> </tr> </thead> <tbody> <tr> <td rowspan="4">Normal operation</td> <td>To&gt;10°C</td> <td>250</td> <td>400</td> <td>250</td> <td>600</td> <td>250</td> <td>700</td> </tr> <tr> <td>5.5&lt;To≤10</td> <td>250</td> <td>400</td> <td>250</td> <td>700</td> <td>250</td> <td>750</td> </tr> <tr> <td>-5&lt;To≤5.5</td> <td>250</td> <td>600</td> <td>250</td> <td>750</td> <td>250</td> <td>800</td> </tr> <tr> <td>To≤-5</td> <td>250</td> <td>600</td> <td>250</td> <td>750</td> <td>250</td> <td>800</td> </tr> <tr> <td rowspan="4">econo operation</td> <td>To&gt;10°C</td> <td>250</td> <td>400</td> <td>250</td> <td>500</td> <td>250</td> <td>600</td> </tr> <tr> <td>5.5&lt;To≤10</td> <td>250</td> <td>400</td> <td>250</td> <td>600</td> <td>250</td> <td>700</td> </tr> <tr> <td>-5&lt;To≤5.5</td> <td>250</td> <td>600</td> <td>250</td> <td>700</td> <td>250</td> <td>700</td> </tr> <tr> <td>To≤-5</td> <td>250</td> <td>600</td> <td>250</td> <td>700</td> <td>250</td> <td>700</td> </tr> <tr> <td>To is abnormal</td> <td>-</td> <td>250</td> <td>400</td> <td>250</td> <td>700</td> <td>250</td> <td>750</td> </tr> </tbody> </table> <p>To:outdoor sensor temp. (°C)</p>	Compressor revolution(rps)		~20		~48		48~			Fan revolution	MIN	MAX	MIN	MAX	MIN	MAX	Normal operation	To>10°C	250	400	250	600	250	700	5.5<To≤10	250	400	250	700	250	750	-5<To≤5.5	250	600	250	750	250	800	To≤-5	250	600	250	750	250	800	econo operation	To>10°C	250	400	250	500	250	600	5.5<To≤10	250	400	250	600	250	700	-5<To≤5.5	250	600	250	700	250	700	To≤-5	250	600	250	700	250	700	To is abnormal	-	250	400	250	700	250	750	
Compressor revolution(rps)		~20		~48		48~																																																																														
	Fan revolution	MIN	MAX	MIN	MAX	MIN	MAX																																																																													
Normal operation	To>10°C	250	400	250	600	250	700																																																																													
	5.5<To≤10	250	400	250	700	250	750																																																																													
	-5<To≤5.5	250	600	250	750	250	800																																																																													
	To≤-5	250	600	250	750	250	800																																																																													
econo operation	To>10°C	250	400	250	500	250	600																																																																													
	5.5<To≤10	250	400	250	600	250	700																																																																													
	-5<To≤5.5	250	600	250	700	250	700																																																																													
	To≤-5	250	600	250	700	250	700																																																																													
To is abnormal	-	250	400	250	700	250	750																																																																													
	<p>RAS-M14EAV-E</p> <table border="1" data-bbox="379 1451 1010 1760"> <thead> <tr> <th colspan="2">Compressor revolution(rps)</th> <th colspan="2">~20</th> <th colspan="2">~60</th> <th colspan="2">60~</th> </tr> <tr> <th></th> <th>Fan revolution</th> <th>MIN</th> <th>MAX</th> <th>MIN</th> <th>MAX</th> <th>MIN</th> <th>MAX</th> </tr> </thead> <tbody> <tr> <td rowspan="4">Normal operation</td> <td>To&gt;10°C</td> <td>250</td> <td>400</td> <td>250</td> <td>600</td> <td>250</td> <td>700</td> </tr> <tr> <td>5.5&lt;To≤10</td> <td>250</td> <td>400</td> <td>250</td> <td>700</td> <td>250</td> <td>750</td> </tr> <tr> <td>-5&lt;To≤5.5</td> <td>250</td> <td>600</td> <td>250</td> <td>750</td> <td>250</td> <td>800</td> </tr> <tr> <td>To≤-5</td> <td>250</td> <td>600</td> <td>250</td> <td>750</td> <td>250</td> <td>800</td> </tr> <tr> <td rowspan="4">econo operation</td> <td>To&gt;10°C</td> <td>250</td> <td>400</td> <td>250</td> <td>500</td> <td>250</td> <td>600</td> </tr> <tr> <td>5.5&lt;To≤10</td> <td>250</td> <td>400</td> <td>250</td> <td>600</td> <td>250</td> <td>700</td> </tr> <tr> <td>-5&lt;To≤5.5</td> <td>250</td> <td>600</td> <td>250</td> <td>700</td> <td>250</td> <td>700</td> </tr> <tr> <td>To≤-5</td> <td>250</td> <td>600</td> <td>250</td> <td>700</td> <td>250</td> <td>700</td> </tr> <tr> <td>To is abnormal</td> <td>-</td> <td>250</td> <td>400</td> <td>250</td> <td>700</td> <td>250</td> <td>750</td> </tr> </tbody> </table> <p>To:outdoor sensor temp. (°C)</p>	Compressor revolution(rps)		~20		~60		60~			Fan revolution	MIN	MAX	MIN	MAX	MIN	MAX	Normal operation	To>10°C	250	400	250	600	250	700	5.5<To≤10	250	400	250	700	250	750	-5<To≤5.5	250	600	250	750	250	800	To≤-5	250	600	250	750	250	800	econo operation	To>10°C	250	400	250	500	250	600	5.5<To≤10	250	400	250	600	250	700	-5<To≤5.5	250	600	250	700	250	700	To≤-5	250	600	250	700	250	700	To is abnormal	-	250	400	250	700	250	750	
Compressor revolution(rps)		~20		~60		60~																																																																														
	Fan revolution	MIN	MAX	MIN	MAX	MIN	MAX																																																																													
Normal operation	To>10°C	250	400	250	600	250	700																																																																													
	5.5<To≤10	250	400	250	700	250	750																																																																													
	-5<To≤5.5	250	600	250	750	250	800																																																																													
	To≤-5	250	600	250	750	250	800																																																																													
econo operation	To>10°C	250	400	250	500	250	600																																																																													
	5.5<To≤10	250	400	250	600	250	700																																																																													
	-5<To≤5.5	250	600	250	700	250	700																																																																													
	To≤-5	250	600	250	700	250	700																																																																													
To is abnormal	-	250	400	250	700	250	750																																																																													

Item	Operation flow and applicable data, etc.	Description																																																																																		
<p>4. Capacity control</p>	 <table border="1" data-bbox="375 436 1013 952"> <thead> <tr> <th>Outdoor unit</th> <th>Operation mode</th> <th>No. of operating unit</th> <th colspan="2">Combination of indoor units</th> <th>Compressor revolution (ps)</th> </tr> </thead> <tbody> <tr> <td rowspan="6">M18EAV-E M18EACV-E</td> <td rowspan="6">Cooling</td> <td rowspan="3">1 unit</td> <td>10</td> <td>–</td> <td>13 to 45</td> </tr> <tr> <td>13</td> <td>–</td> <td>13 to 71</td> </tr> <tr> <td>16</td> <td>–</td> <td>13 to 79</td> </tr> <tr> <td rowspan="3">2 units</td> <td>10</td> <td>10</td> <td>15 to 83</td> </tr> <tr> <td>13</td> <td>10</td> <td>15 to 83</td> </tr> <tr> <td>13</td> <td>13</td> <td>15 to 83</td> </tr> <tr> <td rowspan="6">M18EAV-E</td> <td rowspan="6">Heating</td> <td rowspan="3">1 unit</td> <td>10</td> <td>–</td> <td>13 to 76</td> </tr> <tr> <td>13</td> <td>–</td> <td>13 to 99</td> </tr> <tr> <td>16</td> <td>–</td> <td>13 to 102</td> </tr> <tr> <td rowspan="3">2 units</td> <td>10</td> <td>10</td> <td>15 to 120</td> </tr> <tr> <td>13</td> <td>10</td> <td>15 to 120</td> </tr> <tr> <td>13</td> <td>13</td> <td>15 to 120</td> </tr> <tr> <td rowspan="4">M14EAV-E M14EACV-E</td> <td rowspan="4">Cooling</td> <td rowspan="2">1 unit</td> <td>10</td> <td>–</td> <td>13 to 56</td> </tr> <tr> <td>13</td> <td>–</td> <td>13 to 74</td> </tr> <tr> <td rowspan="2">2 units</td> <td>10</td> <td>10</td> <td>18 to 74</td> </tr> <tr> <td>13</td> <td>10</td> <td>18 to 75</td> </tr> <tr> <td rowspan="4">M14EAV-E</td> <td rowspan="4">Heating</td> <td rowspan="2">1 unit</td> <td>10</td> <td>–</td> <td>13 to 75</td> </tr> <tr> <td>13</td> <td>–</td> <td>13 to 80</td> </tr> <tr> <td rowspan="2">2 units</td> <td>10</td> <td>10</td> <td>16 to 84</td> </tr> <tr> <td>13</td> <td>10</td> <td>16 to 85</td> </tr> </tbody> </table>	Outdoor unit	Operation mode	No. of operating unit	Combination of indoor units		Compressor revolution (ps)	M18EAV-E M18EACV-E	Cooling	1 unit	10	–	13 to 45	13	–	13 to 71	16	–	13 to 79	2 units	10	10	15 to 83	13	10	15 to 83	13	13	15 to 83	M18EAV-E	Heating	1 unit	10	–	13 to 76	13	–	13 to 99	16	–	13 to 102	2 units	10	10	15 to 120	13	10	15 to 120	13	13	15 to 120	M14EAV-E M14EACV-E	Cooling	1 unit	10	–	13 to 56	13	–	13 to 74	2 units	10	10	18 to 74	13	10	18 to 75	M14EAV-E	Heating	1 unit	10	–	13 to 75	13	–	13 to 80	2 units	10	10	16 to 84	13	10	16 to 85	<ol style="list-style-type: none"> <li>Indoor unit A and Indoor unit B determine the respective instruction revolutions from the difference between the remote controller setting temperature (Ts) and the indoor temperature (Ta), and transmit this to the outdoor unit.</li> <li>The outdoor unit receives the instructions from the indoor units, and the inverter operates the compressor at the calculated revolutions.</li> <li>The compressor operation range in each operating mode is shown in the left table.</li> </ol>
Outdoor unit	Operation mode	No. of operating unit	Combination of indoor units		Compressor revolution (ps)																																																																															
M18EAV-E M18EACV-E	Cooling	1 unit	10	–	13 to 45																																																																															
			13	–	13 to 71																																																																															
			16	–	13 to 79																																																																															
		2 units	10	10	15 to 83																																																																															
			13	10	15 to 83																																																																															
			13	13	15 to 83																																																																															
M18EAV-E	Heating	1 unit	10	–	13 to 76																																																																															
			13	–	13 to 99																																																																															
			16	–	13 to 102																																																																															
		2 units	10	10	15 to 120																																																																															
			13	10	15 to 120																																																																															
			13	13	15 to 120																																																																															
M14EAV-E M14EACV-E	Cooling	1 unit	10	–	13 to 56																																																																															
			13	–	13 to 74																																																																															
		2 units	10	10	18 to 74																																																																															
			13	10	18 to 75																																																																															
M14EAV-E	Heating	1 unit	10	–	13 to 75																																																																															
			13	–	13 to 80																																																																															
		2 units	10	10	16 to 84																																																																															
			13	10	16 to 85																																																																															
<p>5. Current release control</p>	<p>This function prevents troubles on the electronic parts of the compressor driving inverter.</p> <p>This function also controls drive circuit of the compressor speed so that electric power of the compressor drive circuit does not exceed the specified value.</p>  <table border="1" data-bbox="391 1668 1013 1960"> <thead> <tr> <th>Outdoor temp.</th> <th>Cooling current release value</th> <th>Heating current release value</th> </tr> </thead> <tbody> <tr> <td>40°C</td> <td rowspan="2">7.5A</td> <td></td> </tr> <tr> <td>16°C</td> <td></td> </tr> <tr> <td>11°C</td> <td rowspan="3">12.0A</td> <td>10.1A</td> </tr> <tr> <td>15.5°C</td> <td>10.3A</td> </tr> <tr> <td>10.5°C</td> <td>10.5A</td> </tr> </tbody> </table>	Outdoor temp.	Cooling current release value	Heating current release value	40°C	7.5A		16°C		11°C	12.0A	10.1A	15.5°C	10.3A	10.5°C	10.5A	<ol style="list-style-type: none"> <li>The input current of the outdoor unit is detected in the inverter section of the outdoor unit.</li> <li>According to the detected outdoor temperature, the specified value of the current is selected.</li> <li>Whether the current value exceeds the specified value or not is judged.</li> <li>If the current value exceeds the specified value, this function reduces the compressor speed and controls speed up to the closest one commanded from the indoor unit within the range which does not exceed the specified value.</li> </ol>																																																																			
Outdoor temp.	Cooling current release value	Heating current release value																																																																																		
40°C	7.5A																																																																																			
16°C																																																																																				
11°C	12.0A	10.1A																																																																																		
15.5°C		10.3A																																																																																		
10.5°C		10.5A																																																																																		

Item	Operation flow and applicable data, etc.	Description
<p>6. Release protective control by temperature of indoor heat exchanger</p>	<p><b>&lt;In cooling/dry operation&gt;</b>            (Prevent-freezing control for indoor heat exchanger)            In cooling/dry operation, the sensor of indoor heat exchanger detects evaporation temperature and controls the compressor speed so that temperature of the heat exchanger does not exceed the specified value.</p> 	<ol style="list-style-type: none"> <li>1) When temperature of the indoor heat exchanger drops below 5°C, the compressor speed is reduced. (P zone)</li> <li>2) When temperature of the indoor heat exchanger rises in the range from 6°C to under 7°C, the compressor speed is kept. (Q zone)</li> <li>3) When temperature of the indoor heat exchanger rises to 7°C or higher, the capacity control operation returns to the usual control in cooling operation. (R zone)</li> </ol>
	<p><b>&lt;In heating operation&gt; (Heat pump model)</b>            (Prevent-overpressure control for refrigerating cycle)            In heating operation, the sensor of indoor heat exchanger detects condensation temperature and controls the compressor speed so that temperature of the heat exchanger does not exceed the specified value.</p> 	<ol style="list-style-type: none"> <li>1) When temperature of the indoor heat exchanger rises in the range from 50°C to 55°C, the compressor speed is kept. (Q zone)            When temperature of the indoor heat exchanger drops in the range from 46°C to under 55°C, the compressor speed is kept. (Q zone)</li> <li>2) When temperature of the indoor heat exchanger rises to 55°C or higher, the compressor speed is reduced. (P zone)</li> <li>3) When temperature of the indoor heat exchanger does not rise to 50°C, or when it drops below to 46°C, the capacity control operation returns to the usual control in heating operation. (R zone)</li> </ol>

Item	Operation flow and applicable data, etc.	Description						
7. Winding/Coil heating control	<p>When the outdoor temperature is low, the windings/coils are heated to ensure compressor reliability.</p> 	<p>Winding/Coil heating is performed when the following conditions are met.</p> <p><b>Condition 1 :</b> When the discharge sensor temperature (Td) is less than 30°C.</p> <p><b>Condition 2 :</b> When 2 hours or more have elapsed after cooling, dry or heating operation stops.</p> <p><b>Condition 3 :</b> When the outdoor sensor temperature (To) is as shown in the left figure.</p>						
8. Defrost control (Only in heating operation)	<p>(This function removes frost adhered to the outdoor heat exchanger.)</p> <p>The temperature sensor of the outdoor heat exchanger (Te sensor) judges the frosting status of the outdoor heat exchanger and the defrost operation is performed with 4-way valve reverse defrost system.</p>  <p>* The minimum value of Te sensor 10 to 15 minutes after start of operation is stored in memory as Te0.</p> <p style="text-align: center;"><b>Table 1</b></p> <table border="1" data-bbox="395 1713 989 1915"> <tr> <td>A zone</td> <td>When <math>Te_0 - TE \geq 2.5</math> continued for 2 minutes in A zone, defrost operation starts.</td> </tr> <tr> <td>B zone</td> <td>When the operation continued for 2 minutes in B zone, defrost operation starts.</td> </tr> <tr> <td>C zone</td> <td>When <math>Te_0 - TE \geq 3</math> continued for 2 minutes in C zone, defrost operation starts.</td> </tr> </table>	A zone	When $Te_0 - TE \geq 2.5$ continued for 2 minutes in A zone, defrost operation starts.	B zone	When the operation continued for 2 minutes in B zone, defrost operation starts.	C zone	When $Te_0 - TE \geq 3$ continued for 2 minutes in C zone, defrost operation starts.	<p>The necessity of defrost operation is detected by the outdoor heat exchanger temperature. The conditions to detect the necessity of defrost operation differ in A, B, or C zone each. (Table 1)</p> <p><b>&lt;Defrost operation&gt;</b></p> <ul style="list-style-type: none"> <li>Defrost operation in A to C zones</li> </ul> <ol style="list-style-type: none"> <li>Stop operation of the compressor for 20 seconds.</li> <li>Invert (ON) 4-way valve 10 seconds after stop of the compressor.</li> <li>The outdoor fan stops at the same time when the compressor stops.</li> <li>When temperature of the indoor heat exchanger becomes 38°C or lower, stop the indoor fan.</li> </ol> <p><b>&lt;Finish of defrost operation&gt;</b></p> <ul style="list-style-type: none"> <li>Returning conditions from defrost operation to heating operation</li> </ul> <ol style="list-style-type: none"> <li>Temperature of outdoor heat exchanger rises to +8°C or higher.</li> <li>Temperature of outdoor heat exchanger is kept at +5°C or higher for 80 seconds.</li> <li>Defrost operation continues for 15 minutes.</li> </ol> <p><b>&lt;Returning from defrost operation&gt;</b></p> <ol style="list-style-type: none"> <li>Stop operation of the compressor for approx. 50 seconds.</li> <li>Invert (OFF) 4-way valve approx. 40 seconds after stop of the compressor.</li> <li>The outdoor fan starts rotating at the same time when the compressor starts.</li> </ol>
A zone	When $Te_0 - TE \geq 2.5$ continued for 2 minutes in A zone, defrost operation starts.							
B zone	When the operation continued for 2 minutes in B zone, defrost operation starts.							
C zone	When $Te_0 - TE \geq 3$ continued for 2 minutes in C zone, defrost operation starts.							

Item	Operation flow and applicable data, etc.	Description																						
<p>9. Louver control</p> <p>1) Louver position</p>	<p>This function controls the air direction of the indoor unit.</p> <ul style="list-style-type: none"> <li>The position is automatically controlled according to the operation mode (COOL/HEAT).</li> <li>The set louver position is stored in memory by the microcomputer, and the louver returns to the stored position when the next operation is performed. (Cooling/heating memory position)</li> </ul> <p>The angle of the louver is indicated as the horizontal angle is 0°.</p> <p>When the louver closes fully, it directs approx. 49° upward.</p> <p>1) Louver position in cooling operation</p>  <table border="1" data-bbox="375 616 1101 929"> <thead> <tr> <th rowspan="2">Cooling operation/ AUTO (COOL)/Dry</th> <th colspan="2">Hi Power</th> </tr> <tr> <th>Room temp. (Ta) &lt; Set temp. (Tsc) + 3.5</th> <th>Room temp. (Ta) ≥ Set temp. (Tsc) + 3.5</th> </tr> </thead> <tbody> <tr> <td></td> <td></td> <td></td> </tr> <tr> <td>Initial setting of "Cooling storage position" Louver : Directs downward (9°)</td> <td>Initial setting of "Cooling storage position" Louver : Directs downward (9°)</td> <td>"Inclined blowing" Louver : Directs downward (14°)</td> </tr> </tbody> </table> <p>2) Louver position in heating operation</p> <table border="1" data-bbox="375 1064 1101 1444"> <thead> <tr> <th rowspan="2">Heating operation/ AUTO (HEAT)</th> <th colspan="2">ECO operation</th> </tr> <tr> <th>Room temp. (Ta) &lt; Set temp. (Tsc) - 3 or 25 minutes after start of operation</th> <th>Room temp. (Ta) ≥ Set temp. (Tsc) - 3</th> </tr> </thead> <tbody> <tr> <td></td> <td></td> <td></td> </tr> <tr> <td>Initial setting of "Heating storage position" Louver : Directs downward (76°)</td> <td>"Heating storage position" Louver : Directs downward (76°)</td> <td>"Cooling storage position" Louver : Directs downward (9°)</td> </tr> </tbody> </table>	Cooling operation/ AUTO (COOL)/Dry	Hi Power		Room temp. (Ta) < Set temp. (Tsc) + 3.5	Room temp. (Ta) ≥ Set temp. (Tsc) + 3.5				Initial setting of "Cooling storage position" Louver : Directs downward (9°)	Initial setting of "Cooling storage position" Louver : Directs downward (9°)	"Inclined blowing" Louver : Directs downward (14°)	Heating operation/ AUTO (HEAT)	ECO operation		Room temp. (Ta) < Set temp. (Tsc) - 3 or 25 minutes after start of operation	Room temp. (Ta) ≥ Set temp. (Tsc) - 3				Initial setting of "Heating storage position" Louver : Directs downward (76°)	"Heating storage position" Louver : Directs downward (76°)	"Cooling storage position" Louver : Directs downward (9°)	 
Cooling operation/ AUTO (COOL)/Dry	Hi Power																							
	Room temp. (Ta) < Set temp. (Tsc) + 3.5	Room temp. (Ta) ≥ Set temp. (Tsc) + 3.5																						
																								
Initial setting of "Cooling storage position" Louver : Directs downward (9°)	Initial setting of "Cooling storage position" Louver : Directs downward (9°)	"Inclined blowing" Louver : Directs downward (14°)																						
Heating operation/ AUTO (HEAT)	ECO operation																							
	Room temp. (Ta) < Set temp. (Tsc) - 3 or 25 minutes after start of operation	Room temp. (Ta) ≥ Set temp. (Tsc) - 3																						
																								
Initial setting of "Heating storage position" Louver : Directs downward (76°)	"Heating storage position" Louver : Directs downward (76°)	"Cooling storage position" Louver : Directs downward (9°)																						
<p>2) Air direction adjustment</p>	<p style="text-align: center;"><b>Air direction</b></p> <table border="1" data-bbox="375 1601 1101 1803"> <thead> <tr> <th>Horizontal blowing</th> <th>Inclined blowing</th> <th>Blowing downward</th> <th>Inclined blowing</th> <th>Horizontal blowing</th> </tr> </thead> <tbody> <tr> <td></td> <td></td> <td></td> <td></td> <td></td> </tr> </tbody> </table>	Horizontal blowing	Inclined blowing	Blowing downward	Inclined blowing	Horizontal blowing						<ul style="list-style-type: none"> <li>The louver position can be arbitrarily set up by pushing [FIX] button.</li> </ul>												
Horizontal blowing	Inclined blowing	Blowing downward	Inclined blowing	Horizontal blowing																				
																								
<p>3) Swing</p>	<ul style="list-style-type: none"> <li>Swing operation is performed in width 35° with the stop position as the center.</li> <li>If the stop position exceeds either upper or lower limit position, swing operation is performed in width 35° from the limit which the stop position exceeded.</li> </ul>	<ul style="list-style-type: none"> <li>Swing When pushing [SWING] button during operation, the louver starts swinging.</li> </ul>																						

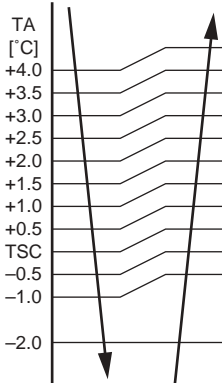
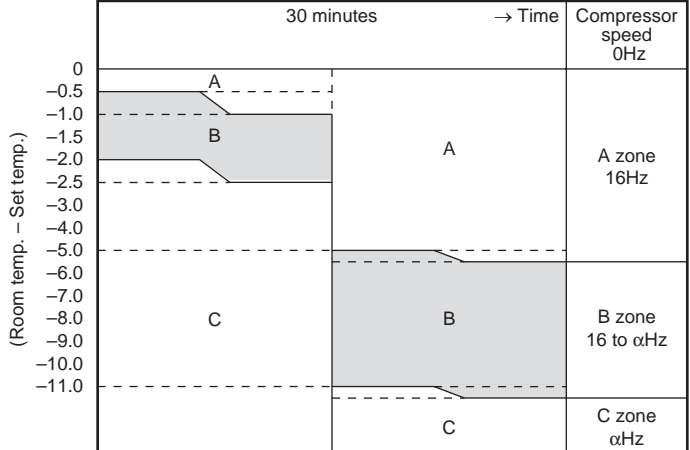
Item	Operation flow and applicable data, etc.	Description																																																														
<p>10. ECO operation</p>	<p>When pushing [ECO] button on the remote controller, a quiet and mild operation is performed by reducing the fan speed and the compressor speed.</p> <p><b>&lt;Cooling operation&gt;</b>  This function operates the air conditioner with the difference between the set and the room temperature as shown in the following figure.  The time correction is performed for 8 minutes each. (However, the first correction is performed 150 seconds after start of the operation.)</p>  <table border="1" data-bbox="558 593 1021 974"> <thead> <tr> <th>Zone</th> <th>Frequency</th> <th>Fan</th> <th>Time correction</th> </tr> </thead> <tbody> <tr> <td>12</td> <td>DRY max</td> <td>L+ (W7)</td> <td rowspan="6">+ 1</td> </tr> <tr> <td>11</td> <td>*12</td> <td rowspan="6">L (W6)</td> </tr> <tr> <td>10</td> <td>*11</td> </tr> <tr> <td>9</td> <td>*10</td> </tr> <tr> <td>8</td> <td>*9</td> </tr> <tr> <td>7</td> <td>*8</td> </tr> <tr> <td>6</td> <td>COOL min</td> <td>L- (W5)</td> <td rowspan="3">± 0</td> </tr> <tr> <td>5</td> <td></td> <td rowspan="3">UL (W4)</td> </tr> <tr> <td>4</td> <td></td> </tr> <tr> <td>3</td> <td></td> <td rowspan="2">-1 zone: min 1</td> </tr> <tr> <td>2</td> <td></td> </tr> <tr> <td>1</td> <td></td> <td></td> <td></td> </tr> <tr> <td>0</td> <td>OFF</td> <td></td> <td></td> </tr> </tbody> </table> <p>* 12 (DRY max - COOL min) / 6 x 5 + COOL min  * 11 (DRY max - COOL min) / 6 x 4 + COOL min  * 10 (DRY max - COOL min) / 6 x 3 + COOL min  * 9 (DRY max - COOL min) / 6 x 2 + COOL min  * 8 (DRY max - COOL min) / 6 x 1 + COOL min</p> <p><b>&lt;Heating operation&gt;</b></p>  <table border="1" data-bbox="327 1288 1021 1736"> <thead> <tr> <th>Room temp. - Set temp.</th> <th>Zone</th> <th>Compressor speed</th> </tr> </thead> <tbody> <tr> <td>0 to -0.5</td> <td>A</td> <td>0Hz</td> </tr> <tr> <td>-0.5 to -2.5</td> <td>A zone</td> <td>16Hz</td> </tr> <tr> <td>-2.5 to -6.0</td> <td>B zone</td> <td>16 to αHz</td> </tr> <tr> <td>-6.0 to -11.0</td> <td>C zone</td> <td>αHz</td> </tr> </tbody> </table> <table border="1" data-bbox="702 1769 1021 1848"> <thead> <tr> <th>α</th> <th>M14EAV-E</th> <th>M18EAV-E</th> </tr> </thead> <tbody> <tr> <td></td> <td>60 Hz</td> <td>50 Hz</td> </tr> </tbody> </table>	Zone	Frequency	Fan	Time correction	12	DRY max	L+ (W7)	+ 1	11	*12	L (W6)	10	*11	9	*10	8	*9	7	*8	6	COOL min	L- (W5)	± 0	5		UL (W4)	4		3		-1 zone: min 1	2		1				0	OFF			Room temp. - Set temp.	Zone	Compressor speed	0 to -0.5	A	0Hz	-0.5 to -2.5	A zone	16Hz	-2.5 to -6.0	B zone	16 to αHz	-6.0 to -11.0	C zone	αHz	α	M14EAV-E	M18EAV-E		60 Hz	50 Hz	<p><b>&lt;Cooling operation&gt;</b></p> <ol style="list-style-type: none"> <li>1) The room temperature (Tao) at the start time of DRY operation is detected.</li> <li>2) According to difference between the room temperature and the set temperature (Tsc), the operation starts with the conditions shown in the left figure. Set temp. (Tsc) = Set temp. on remote controller (Ts) + (0.0 to 1.0)</li> <li>3) If the room temperature is down by 2°C or more, turn off the compressor.</li> </ol> <p><b>&lt;Heating operation&gt;</b></p> <ol style="list-style-type: none"> <li>1) The indoor fan speed is controlled within W7 as maximum value.</li> <li>2) Setting the compressor speed to Max. αHz, the temperature zone in which the operation can be performed with Max. 16Hz is gradually widened after 30 minutes passed when starting ECO operation.</li> <li>3) The lower position is set horizontally (Standard cooling position) when the room temperature comes close to the set temperature or when 25 minutes passed after starting ECO operation.</li> </ol>
Zone	Frequency	Fan	Time correction																																																													
12	DRY max	L+ (W7)	+ 1																																																													
11	*12	L (W6)																																																														
10	*11																																																															
9	*10																																																															
8	*9																																																															
7	*8																																																															
6	COOL min		L- (W5)	± 0																																																												
5		UL (W4)																																																														
4																																																																
3			-1 zone: min 1																																																													
2																																																																
1																																																																
0	OFF																																																															
Room temp. - Set temp.	Zone	Compressor speed																																																														
0 to -0.5	A	0Hz																																																														
-0.5 to -2.5	A zone	16Hz																																																														
-2.5 to -6.0	B zone	16 to αHz																																																														
-6.0 to -11.0	C zone	αHz																																																														
α	M14EAV-E	M18EAV-E																																																														
	60 Hz	50 Hz																																																														

Item	Operation flow and applicable data, etc.	Description
<p>11. Temporary operation</p>	<p>Pushing [RESET] button starts the temporary operation of [AUTO] operation. When keeping [RESET] button pushed for 10 seconds or more, the temporary [COOL] operation is performed.</p> <pre> graph TD     A{FILTER indicator ON} -- YES --&gt; B[Push RESET button.]     A -- NO --&gt; C{Did you push [RESET] button for 3 seconds or more?}     C -- NO --&gt; D[Temporary [AUTO] operation]     C -- YES --&gt; E{Did you push [RESET] button for 10 seconds or more?}     E -- YES --&gt; F[Temporary [COOL] Operation]     E -- NO --&gt; G[Switch to [AUTO RESTART] control.]     B --&gt; A   </pre>	<ol style="list-style-type: none"> <li>1) When pushing [RESET] button, the temporary [AUTO] operation starts.</li> <li>2) When keeping [RESET] button pushed for 3 seconds or more, Pi, Pi, Pi sound is heard and [AUTO RESTART] control is changed.</li> <li>3) When keeping [RESET] button pushed for 10 seconds or more, "Pi" sound is heard and the temporary [COOL] operation starts.</li> <li>4) If the FILTER indicator goes on, push [RESET] button to go off the FILTER indicator, and then push [RESET] button again.</li> <li>5) To stop the temporary operation, push the button again.</li> </ol>

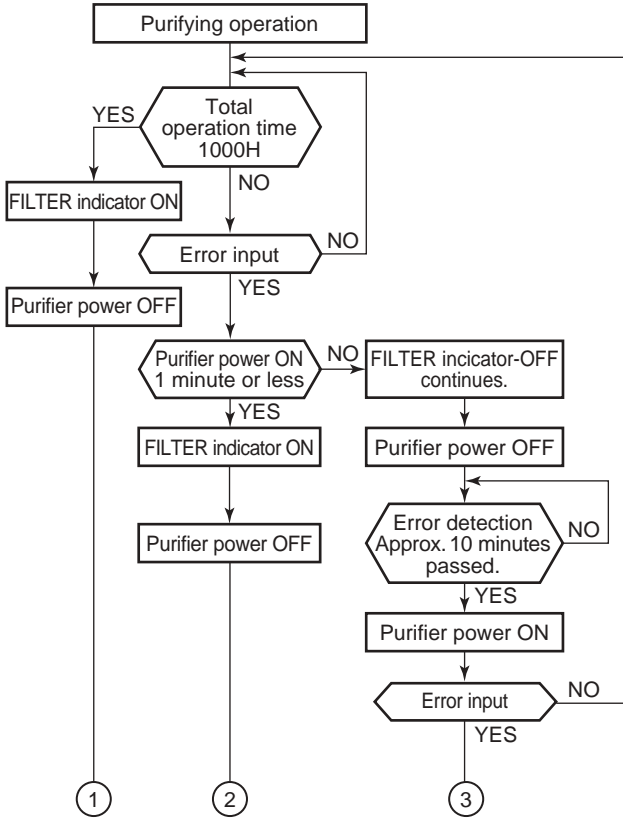

Item	Operation flow and applicable data, etc.	Description																										
12. Air purifying control	<p>This function generates negative ion while cleaning the air in the room.</p> <p>If air purifier-ON signal is received while the air conditioner stops, the air purifier starts operation, and if it is received while the air conditioner operates, the air conditioner and the air purifier start operation.</p> <p>The air ion generator operates linked with the air purifying operation.</p> <div style="text-align: center;"> <pre> graph TD     Start[Sending air purifier-ON] --&gt; C1((1))     Start --&gt; C2((1, 2))     Start --&gt; C3((2))          C1 --&gt; AC1[Air conditioner stops]     AC1 --&gt; IO1[OPERATION indicator ON]     IO1 --&gt; MP1[Memory position of louver/COOL]     MP1 --&gt; FO1[Fan ON]     FO1 --&gt; AP1[Air purifier ON]     AP1 --&gt; PO1[Air purifying operation]          C2 --&gt; IO1     C2 --&gt; S1[Start of air purifier-ON]     S1 --&gt; APO1[Air conditioner + air purifier operate]          C3 --&gt; S1          End1[Sending air purifier-OFF] --&gt; C4((3))     End1 --&gt; C5((3, 4))     End1 --&gt; C6((4))          C4 --&gt; AP2[Air purifier operates]     AP2 --&gt; IO2[OPERATION indicator OFF]     IO2 --&gt; FS[Fan stop]     FS --&gt; APO2[Air purifier-OFF]     APO2 --&gt; LC[Louver close]     LC --&gt; AS1[All stop]          C5 --&gt; IO2     C5 --&gt; FO2[Filter-OFF]     FO2 --&gt; ACO2[Air conditioner operates]          C6 --&gt; ACO2           </pre> </div>	<table border="1" data-bbox="981 224 1441 499"> <thead> <tr> <th rowspan="2">Present status</th> <th colspan="2">Operation button</th> </tr> <tr> <th>PURE button</th> <th>Air conditioner</th> </tr> </thead> <tbody> <tr> <td>Stop</td> <td>Air purifier</td> <td>AC operation*</td> </tr> <tr> <td>Air purifier only</td> <td>Stop (All)</td> <td>AC + Air purifier</td> </tr> <tr> <td>Air conditioner</td> <td>AC + Air purifier</td> <td>All stop</td> </tr> <tr> <td>Joint use of AC and air purifier</td> <td>AC operation</td> <td>All stop</td> </tr> </tbody> </table> <p>* When the previous operation was the operation of air conditioner + air purifier, an operation of air conditioner + air purifier starts by pushing AC button on the remote controller. (Operation of air conditioner + air purifier is stored in memory.)</p> <table border="1" data-bbox="981 745 1441 913"> <thead> <tr> <th></th> <th>Louver*1</th> <th>Fan speed *2</th> </tr> </thead> <tbody> <tr> <td>Air purifying operation</td> <td>Cooling position</td> <td>AUTO, L, L+, M, M+, H</td> </tr> <tr> <td>AC + Air purifying operation</td> <td>Follows to AC operation</td> <td>Follows to AC operation</td> </tr> </tbody> </table> <p>*1 Swing is available</p> <p>*2 Fan speed is Fan Auto mode varies in order, (M + 1) → (L) → (L-) → (SL).</p>	Present status	Operation button		PURE button	Air conditioner	Stop	Air purifier	AC operation*	Air purifier only	Stop (All)	AC + Air purifier	Air conditioner	AC + Air purifier	All stop	Joint use of AC and air purifier	AC operation	All stop		Louver*1	Fan speed *2	Air purifying operation	Cooling position	AUTO, L, L+, M, M+, H	AC + Air purifying operation	Follows to AC operation	Follows to AC operation
Present status	Operation button																											
	PURE button	Air conditioner																										
Stop	Air purifier	AC operation*																										
Air purifier only	Stop (All)	AC + Air purifier																										
Air conditioner	AC + Air purifier	All stop																										
Joint use of AC and air purifier	AC operation	All stop																										
	Louver*1	Fan speed *2																										
Air purifying operation	Cooling position	AUTO, L, L+, M, M+, H																										
AC + Air purifying operation	Follows to AC operation	Follows to AC operation																										

Item	Operation flow and applicable data, etc.	Description														
<p>12. Air purifying control [Detection of abnormality]</p>	 <p>1) Reset by RESET button.  2) Reset by RESET button or by the stop direction from the remote controller.  * When the breaker is turned [ON] (In restart time after power failure) or RESET button is pushed while the FILTER indicator is turned on, the air purifier is not turned on until the integrated operation time of the indoor fan exceeds 1 hour after operation start (It is not the air purifier operation time).  It is the safety measures considering an incomplete drain when electric dust collector has been cleaned with water.</p>	<p><b>1. Purpose</b>  The air purifying control function is to alert the user to trouble in the ionizing or air purifying operation.</p> <p><b>2. Description</b>  Trouble is determined to have occurred (indicated by the FILTER indicator) in the following four cases.  1) When a count of 1000H has been reached on the timer  2) When the panel switch has been set to OFF by the opening of the air inlet grille, etc.  3) When an abnormal discharge caused by a symptom such as the build-up of dirt has been detected while the air purifier is ON  4) When the electric dust collector has not been installed correctly  * Trouble case (2) or (3) is deemed to have occurred when the action concerned continues for more than one second.</p> <p><b>3. Operation</b>  The sequence that FILTER indicator is turned on are described in the left flow-chart.  ① When 1000H timer counts up, the FILTER indicator keeps lighting even if the operation is stopped by the remote controller.  The timer is stored in memory of the microcomputer, and the operation time is cleared by filter RESET button on the indoor unit or a power failure. (FILTER indicator goes off.)  ② A trouble detected within 1 minute after activation of the air is immediately judged as an error and the FILTER indicator goes on.  ③ In case that 1 minute passed after activation of the purifier, the purifier is turned off while the PURE indicator keeps ON. After 10 minutes passed, restart the purifier and an error is judged again.</p>														
<p>13. Discharge temperature control</p>	<table border="1" data-bbox="343 1724 917 2049"> <thead> <tr> <th>Td value</th> <th>Control operation</th> </tr> </thead> <tbody> <tr> <td>120°C</td> <td>Judges as an error and stops the compressor.</td> </tr> <tr> <td>115°C</td> <td>Reduce the compressor speed.</td> </tr> <tr> <td>111°C</td> <td>Reduce slowly compressor speed.</td> </tr> <tr> <td>108°C</td> <td>Keeps the compressor speed.</td> </tr> <tr> <td>101°C</td> <td>If the operation is performed with lower speed than one commanded by the serial signal, speed is slowly raised up to the commanded speed.</td> </tr> <tr> <td></td> <td>Operates with speed commanded by the serial signal.</td> </tr> </tbody> </table>	Td value	Control operation	120°C	Judges as an error and stops the compressor.	115°C	Reduce the compressor speed.	111°C	Reduce slowly compressor speed.	108°C	Keeps the compressor speed.	101°C	If the operation is performed with lower speed than one commanded by the serial signal, speed is slowly raised up to the commanded speed.		Operates with speed commanded by the serial signal.	<p><b>1. Purpose</b>  This function detects error on the refrigerating cycle or error on the compressor, and performs protective control.</p> <p><b>2. Operation</b></p> <ul style="list-style-type: none"> <li>Control of the compressor speed  The speed control is performed as described in the left table based upon the discharge temperature.</li> </ul>
Td value	Control operation															
120°C	Judges as an error and stops the compressor.															
115°C	Reduce the compressor speed.															
111°C	Reduce slowly compressor speed.															
108°C	Keeps the compressor speed.															
101°C	If the operation is performed with lower speed than one commanded by the serial signal, speed is slowly raised up to the commanded speed.															
	Operates with speed commanded by the serial signal.															

Item	Operation flow and applicable data, etc.	Description
<p>14. Pulse Motor valve (PMV) control</p>	<p>This function controls throttle amount of the refrigerant in the refrigerating cycle.</p> <p>According to operating status of the air conditioner, this function also controls the open degree of valve with an expansion valve with pulse motor.</p> <pre> graph TD     Start[Starting up] --&gt; Init[Initialize]     Init --&gt; Move[Move to initial position]     Move --&gt; Comp[Compressor ON]     Comp --&gt; SH[SH control]     Comp --&gt; Td[Td release control]     SH --&gt; PMV[PMV open degree control]     Td --&gt; PMV     PMV --&gt; Remote[Stop by remote controller]     PMV --&gt; Room[Room temp. sensor (Ta sensor) control]     Remote --&gt; Power[Power OFF]     Room --&gt; Defrost[Defrost]     Defrost --&gt; Move   </pre> <p>* SH (Super Heat amount, cooling operation) = <math>T_g</math> (Temperature of gas pipe) – <math>T_c</math> (Heat exchanger temperature of indoor unit)</p> <p>* SH (Super Heat amount, heating operation) = <math>T_s</math> (Temperature of suction pipe of the compressor) – <math>T_e</math> (Heat exchanger temperature of outdoor unit)</p> <p>* PMV: Pulse Motor Valve</p>	<ol style="list-style-type: none"> <li>1) When starting the operation, move the valve once until it fits to the stopper. (Initialize) * In this time, "Click" sound may be heard.</li> <li>2) Adjust the open degree of valve by super heat amount. (SH control)</li> <li>3) If the discharge temperature was excessively up, adjust the open degree of valve so that it is in the range of set temperature. (Discharge temp. control)</li> <li>4) When defrost operation is performed, the open degree of valve is adjusted according to each setup conditions during preparation for defrost and during defrost operation (4-way valve is inversed.).</li> <li>5) To turn off the compressor while the air conditioner stops by control of the thermostat or by remote controller, adjust the open degree of valve to the setup value before stop of the compressor.</li> </ol>

Item	Operation flow and applicable data, etc.	Description															
<p>15. Clean operation</p>	<div style="text-align: center;"> <pre> graph TD     A[Unit now performing cooling or dry operation] --&gt; B[Push "stop" button]     B --&gt; C[Only S.CLEAN indicator lights, and clean operation starts]     C --&gt; D[Time set now elapses]     D --&gt; E[Operation stops]           </pre> </div> <ul style="list-style-type: none"> <li>• During clean operations: The louver opens slightly. The indoor fan operates continuously at a speed of 260 rpm.</li> </ul> <p>Clean operation times</p> <table border="1" data-bbox="363 882 995 1326"> <thead> <tr> <th>Operation mode</th> <th>Operation time</th> <th>Clean operation time</th> </tr> </thead> <tbody> <tr> <td rowspan="3">Cooling: Auto (cooling) Dry</td> <td>Up to 10 minutes</td> <td>No clean operation performed (0 minutes)</td> </tr> <tr> <td>From 10 minutes up to 1 hour</td> <td>2 hours</td> </tr> <tr> <td>1 hour or longer</td> <td>4 hours</td> </tr> <tr> <td>Heating: Auto (heating)</td> <td colspan="2" rowspan="3">No clean operation performed</td> </tr> <tr> <td>Auto (fan only)</td> </tr> <tr> <td>Shutdown</td> </tr> </tbody> </table> <ul style="list-style-type: none"> <li>• To stop an ongoing clean operation at any time Press the start/stop button on the remote controller twice during the clean operation. (After pressing the button for the first time, press it for the second time without delay (within 10 minutes).)</li> </ul>	Operation mode	Operation time	Clean operation time	Cooling: Auto (cooling) Dry	Up to 10 minutes	No clean operation performed (0 minutes)	From 10 minutes up to 1 hour	2 hours	1 hour or longer	4 hours	Heating: Auto (heating)	No clean operation performed		Auto (fan only)	Shutdown	<p><b>1. Purpose</b></p> <p>The clean operation is to minimize the growth of mold, bacteria etc. by running the fan and drying so as to keep the inside of the air conditioner clean.</p> <p><b>Clean operation</b></p> <p>When the cooling or dry operation shuts down, the unit automatically starts the clean operation which is then performed for the specified period based on duration of the operation which was performed prior to the shutdown, after which the clean operation stops. (The clean operation is not performed after a heating operation.)</p> <p><b>2. Operation</b></p> <ol style="list-style-type: none"> <li>1) When the stop signal from the remote controller is received, the S.CLEAN indicator (green) on the main body lights, and the clean operation starts. (Neither the OPERATION indicator nor the TIMER indicator light.)</li> <li>2) The period of the clean operation is determined by the duration of the operation performed prior to the reception of the stop code.</li> <li>3) After the clean operation has been performed for the specified period, the unit stops operating.</li> </ol>
Operation mode	Operation time	Clean operation time															
Cooling: Auto (cooling) Dry	Up to 10 minutes	No clean operation performed (0 minutes)															
	From 10 minutes up to 1 hour	2 hours															
	1 hour or longer	4 hours															
Heating: Auto (heating)	No clean operation performed																
Auto (fan only)																	
Shutdown																	

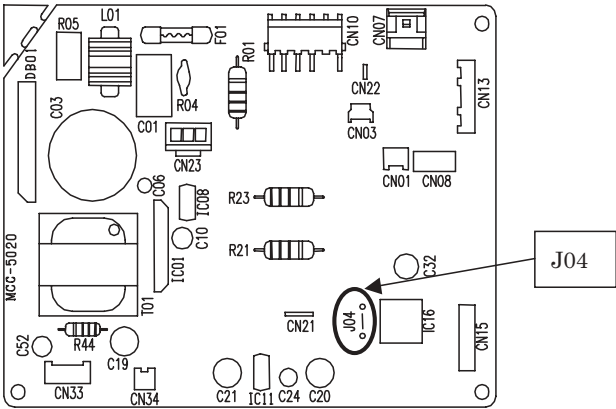
Item	Operation flow and applicable data, etc.	Description
<p>16. Clean operation release</p>	<p><b>Setting the clean operation release</b></p> <div style="display: flex; justify-content: space-between;"> <div style="width: 45%;"> <p>Add J04 of the indoor P.C. board assembly. * This cancels the auto restart function.</p> <p>Hold down the auto operation switch on the indoor unit for at least 3 seconds but not more than 10 seconds.</p> <p>The indoor unit's buzzer emits three beeps, and the OPERATION indicator flashes at 5 Hz intervals.</p> <p>This completes the clean operation release setting.</p> </div> <div style="width: 45%; font-size: small;"> <p>* J04 will be near the MUC so take steps to ensure that it will not be exposed to excessive levels of heat. Also take care to avoid solder bridging with the surrounding components.</p> </div> </div> <p><b>Setting the clean operation</b></p> <div style="display: flex; justify-content: space-between;"> <div style="width: 45%;"> <p>Cut J04 of the indoor P.C. board * This step may be skipped if the auto restart function is not required.</p> <p>Hold down the auto operation switch on the indoor unit for at least 3 seconds but not more than 10 seconds.</p> <p>The indoor unit's buzzer emits three beeps, and the OPERATION indicator flashes at 5 Hz intervals.</p> <p>This completes the clean operation setting.</p> </div> </div> <p><b>Outline diagram of P.C. board</b></p> 	

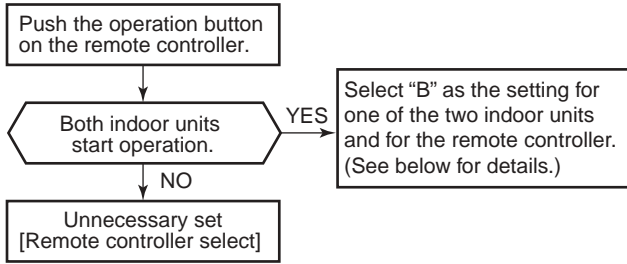
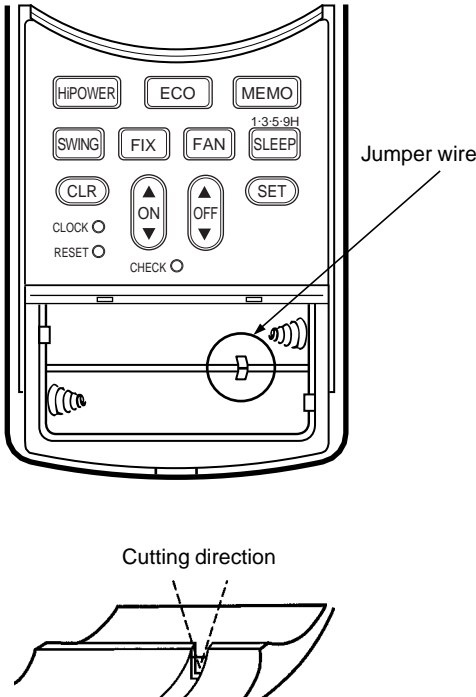
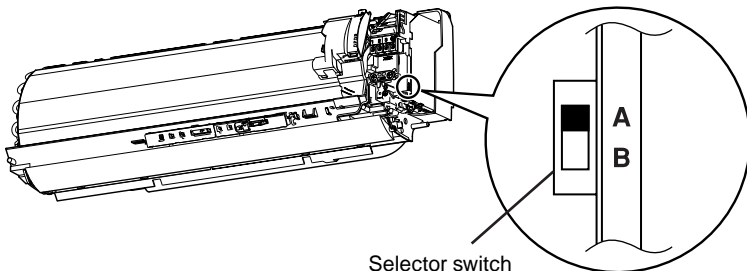
Item	Operation flow and applicable data, etc.	Description
<p>17. Select switch on remote controller</p>		<p><b>1. Purpose</b> This operation is to operate only one indoor unit using one remote controller.</p> <p><b>2. Description</b> When operating one indoor unit in a situation where two indoor units have been installed in the same room or nearby rooms, this operation prevents the remote controller signal from being received simultaneously by both units, thus preventing both units from operating.</p> <p><b>3. Operation</b> The indoor unit on which the remote controller selection has been set to B receives the signal of the remote controller also set to B. (At the factory the remote controller selection is set to A on all the indoor units. There is no A setting display.)</p>
	 <p><b>Setting the remote controller</b> Switching between A and B is enabled by cutting the jumper wire inside the battery box using pliers.</p> <ol style="list-style-type: none"> <li>Slide open the remote controller cover and remove the batteries.</li> <li>Cut the jumper wire inside the battery compartment using nippers. <ul style="list-style-type: none"> <li>The jumper wire should not remain in contact after being cut. Also, be careful not to let plastic scraps, jumper wire cuttings or other debris enter the inside of the remote controller.</li> </ul> </li> <li>Insert the batteries. "B" appears in the remote controller display.</li> </ol> <p>* Even after the jumper wire has been cut, switching between A and B is still possible by pressing the CHECK button and FIX button together. The A or B setting, which was switched by pressing the CHECK button and FIX button together, is restored to the setting established prior to the switching when the battery is replaced or the RESET button is pressed.</p> <p><b>Setting the selector switch on the main unit</b></p> <ul style="list-style-type: none"> <li>Remove the front panel, and then set the selector switch to "B".</li> <li>After making the switch setting, remount the front panel.</li> </ul> <p>When switching between settings "A" and "B", always switch the indoor unit board and the remote controller as a pair. (Otherwise, the indoor unit will not accept the remote controller's signals.)</p> <p>Position of remote controller selector switch</p> 	

### 9-3. Auto Restart Function

This indoor unit is equipped with an automatic restarting function which allows the unit to restart operating with the set operating conditions in the event of a power supply being accidentally shut down. The operation will resume without warning three minutes after power is restored.

This function is not set to work when shipped from the factory. Therefore it is necessary to set it to work.

#### 9-3-1. How to Set the Auto Restart Function

To set the auto restart function, proceed as follows:  
The power supply to the unit must be on ; the function will not set if the power is off.

Push the [RESET] button located in the center of the front panel continuously for three seconds.

The unit receives the signal and beeps three times.

The unit then restarts operating automatically in the event of power supply being accidentally shut down.

#### • When the unit is standby (Not operating)

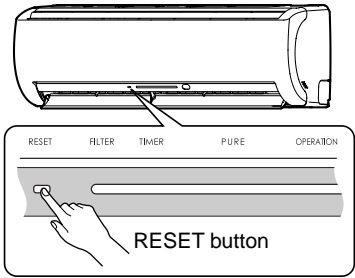
Operation	Motions
<p>Push [RESET] button for more than three seconds. (Less than 10 seconds)</p> 	<p>The unit is on standby.</p> <p style="text-align: center;">↓</p> <p>The unit starts to operate.                      The green indicator is on.</p> <p style="text-align: center;">↓    After approx. three seconds,</p> <p>The unit beeps three times and continues to operate.                      <b>The green indicator flashes for 5 seconds</b></p> <p>If the unit is not required to operate at this time, push [RESET] button once more or use the remote controller to turn it off.</p>

#### • When the unit is in operation

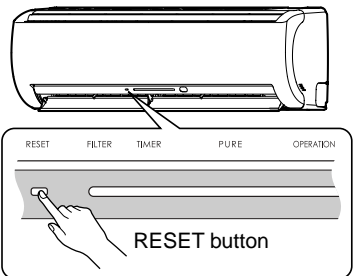
Operation	Motions
<p>Push [RESET] button for more than three seconds. (Less than 10 seconds)</p> 	<p>The unit is in operation.                      The green indicator is on.</p> <p style="text-align: center;">↓</p> <p>The unit stops operating.                      The green indicator is turned off.</p> <p style="text-align: center;">↓    After approx. three seconds,</p> <p>The unit beeps three times.                      <b>The green indicator flashes for 5 seconds</b></p> <p>If the unit is required to operate at this time, push [RESET] button once more or use the remote controller to turn it on.</p>

- When the unit is turned on by this function, the louver will not swing even though it was swinging automatically before shutting down.
- While the filter check indicator is on, the RESET button has the function of filter reset button.

### 9-3-2. How to Cancel the Auto Restart Function

To cancel auto restart function, proceed as follows :

Repeat the setting procedure : the unit receives the signal and beeps three times.

The unit will be required to be turned on with the remote controller after the main power supply is turned off.

#### • When the system is on stand-by (not operating)

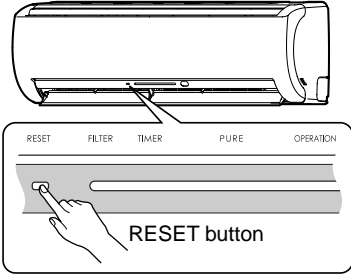
Operation	Motions
<p>Push [RESET] button for more than three seconds. (Less than 10 seconds)</p> 	<p>The unit is on standby.</p> <p style="text-align: center;">↓</p> <p>The unit starts to operate.                      The green indicator is on.</p> <p style="text-align: center;">↓    After approx. three seconds,</p> <p>The unit beeps three times and continues to operate.</p> <p>If the unit is not required to operate at this time, push [RESET] button once more or use the remote controller to turn it off.</p>

#### • When the system is operating

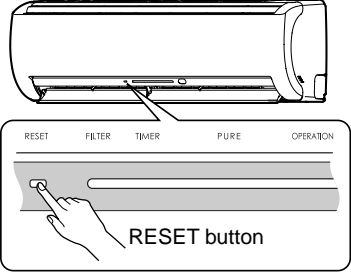
Operation	Motions
<p>Push [RESET] button for more than three seconds. (Less than 10 seconds)</p> 	<p>The unit is in operation.                      The green indicator is on.</p> <p style="text-align: center;">↓</p> <p>The unit stops operating.                      The green indicator is turned off.</p> <p style="text-align: center;">↓    After approx. three seconds,</p> <p>The unit beeps three times.</p> <p>If the unit is required to operate at this time, push [RESET] button once more or use the remote controller to turn it on.</p>

### 9-3-3. Power Failure During Timer Operation

When the unit is turned off because of power failure during timer operation, the timer operation is cancelled. In that case, set the timer operation again.

#### NOTE :

The Everyday Timer is reset while a command signal can be received from the remote controller even if it stopped due to a power failure.

### 9-4. FILTER Indicator

When the elapsed time reaches 1000 hours after air purifier operation, the FILTER indicator lights. After cleaning the filters, turn off the FILTER indicator.

#### 9-4-1. How to Turn Off FILTER Indicator

Push [RESET] button on the indoor unit.

#### NOTE :





If [RESET] button is pushed while the FILTER indicator is not lit, the indoor unit will start the automatic operation.

When you want a temporary operation while the FILTER indicator lights, push [RESET] button to turn off the FILTER indicator. (See page 48)



## 9-5. Remote Controller and Its Functions

### 9-5-1. Parts Name of Remote Controller



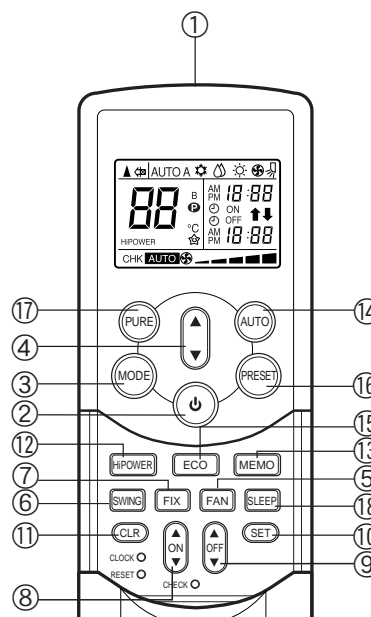











- ① **Infrared signal transmitter**  
Transmits signals to the indoor unit.
- ② **⏻ button**  
Press the button to start operation. (A receiving beep is heard.) Press the button again to stop operation. (A receiving beep is heard.)  
If no receiving sound is heard from the indoor unit, press the button twice.
- ③ **Mode select button (MODE)**  
Press this button to select a mode. Each time you press the button, the modes cycle in order from A: Auto changeover control, ❄️: COOL, ☀️: DRY, 🔥: HEAT (heat pump models only), 🌀: FAN ONLY (cooling-only models only) and back to A.  
(A receiving beep is heard.)
- ④ **Temperature button (TEMP)**  
▲ ... The temperature setting is increased to 30°C.  
▼ ... The temperature setting is reduced to 17°C.  
(A receiving beep is heard.)
- ⑤ **Fan speed button (FAN)**  
Press this button to select the fan speed. When you select AUTO, the fan speed is automatically adjusted according to the room temperature. You can also manually select the desired fan speed from five available settings.  
(LOW —, LOW+ —■, MED —■■, MED+ —■■■, HIGH —■■■■) (A receiving beep is heard.)
- ⑥ **Auto louver button (SWING)**  
Press this button to swing the louver. (A receiving beep is heard.)  
Press the button again to stop the louver from swinging. (A receiving beep is heard.)
- ⑦ **Set louver button (FIX)**  
Press this button to adjust the air flow direction. (A receiving beep is heard.)
- ⑧ **ON timer button (ON)**  
Use this button to change the clock and ON timer times.  
  
To move up the time, press ▲ of the ON  button.  
  
To move down the time, press ▼ of the ON  button.
- ⑨ **OFF timer button (OFF)**  
Use this button to change the OFF timer times.  
  
To move up the time, press ▲ of the OFF  button.  
  
To move down the time, press ▼ of the OFF  button.
- ⑩ **Reserve button (SET)**  
Press this button to store the time settings. (A receiving beep is heard.)
- ⑪ **Cancel button (CLR)**  
Press this button to cancel the ON timer and OFF timer. (A receiving beep is heard.)
- ⑫ **High power button (Hi POWER)**  
Press this button to start high power operation.
- ⑬ **Memory button (MEMO)**  
Press this button to ready for storing the settings.  
Hold down the button for more than 3 seconds to store the setting indicated on the remote control and until the  mark is displayed.
- ⑭ **Automatic operation button (AUTO)**  
Press this button to operate the air conditioner automatically.  
(A receiving beep is heard.)
- ⑮ **Economy button (ECO)**  
Press this button to operate the air conditioner economically.
- ⑯ **PRESET button**  
Press this button to operate the air conditioner according to the settings stored using the MEMO button.
- ⑰ **PURE button (PURE)**  
Press this button to start the electrical air purifying operation.  
Press the button again to stop operation.
- ⑱ **Sleep timer button (SLEEP)**  
Press this button to start the sleep timer (OFF timer) operation.  
You can select the OFF timer time from among four settings (1, 3, 5 or 9 hours).



## 9-5-2. Name and Functions of Indications on Remote Controller

### [Display]

All indicators, except for the clock time indicator, are displayed by pressing the  button.

- ① **Transmission mark**  
This transmission mark () indicates when the remote control transmits signals to the indoor unit.
- ② **Mode indicator**  
Indicates the current operation mode.
  - Heat pump models  
(AUTO: Automatic control, A: Auto changeover control, : COOL, : DRY, : HEAT)
  - Cooling-only models  
(AUTO: Automatic control, A: Auto changeover control, : COOL, : DRY, : FAN ONLY)
- ③ **Temperature indicator**  
Indicates the temperature setting (17°C to 30°C).
- ④ **PURE indicator**  
Shows that the electrical air purifying operation is in progress.
- ⑤ **FAN speed indicator**  
Indicates the selected fan speed. AUTO or one of five fan speed levels (LOW , LOW+ , MED , MED+ , HIGH ) can be shown.
- ⑥ **TIMER and clock time indicator**  
The time setting for timer operation or the clock time is indicated.  
The current time is always indicated except during TIMER operation.
- ⑦ **Hi POWER indicator**  
Indicates when Hi POWER operation starts.  
Press the Hi POWER button to start and press it again to stop operation.
- ⑧ ** (MEMORY) indicator**  
Flashes for 3 seconds when the MEMO button is pressed during operation.  
The  mark is shown when holding down the button for more than 3 seconds while the mark is flashing.  
Press another button to turn off the mark.
- ⑨ **ECO indicator**  
Indicates when the ECO is activated.  
Press the ECO button to start and press it again to stop operation.
- ⑩ **A. B change indicator remote control**
  - When the remote control switching function is set, "B" appears in the remote control display. (When the remote control setting is "A", there is no indication at this position.)

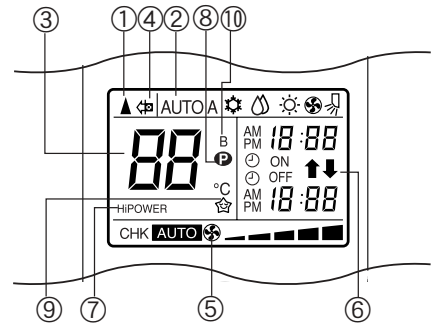

In the illustration, all indicators are shown for purposes of explanation. During operation, only the relevant indicators are shown on the remote control.

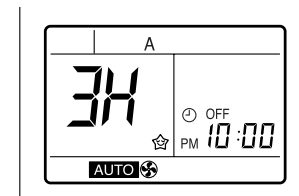

## **9-6. Hi-POWER Mode ([Hi-POWER] button on the remote controller is pushed.)**

When [Hi-POWER] button is pushed while the indoor unit is in Auto, Cooling or Heating operation, Hi-POWER mark is indicated on the display of the remote controller and the unit operates as follows.

- (1) Automatic operation
  - The indoor unit operates in according to the current operation.
- (2) Cooling operation
  - The preset temperature drops 1°C.  
(The value of the preset temperature on the remote controller does not change.)
  - If the difference between the preset temperature and the room temperature is big, the horizontal louver moves to the Hi-POWER position automatically. Then when the difference between them gets smaller, the horizontal louver returns automatically.
- (3) Heating operation
  - The preset temperature increases 2°C.  
(The value of the preset temperature on the remote controller does not change.)
- (4) The Hi-POWER mode can not be set in Dry operation

# 10. INSTALLATION PROCEDURE

## 10-1. Installation Diagram of Indoor and Outdoor Units

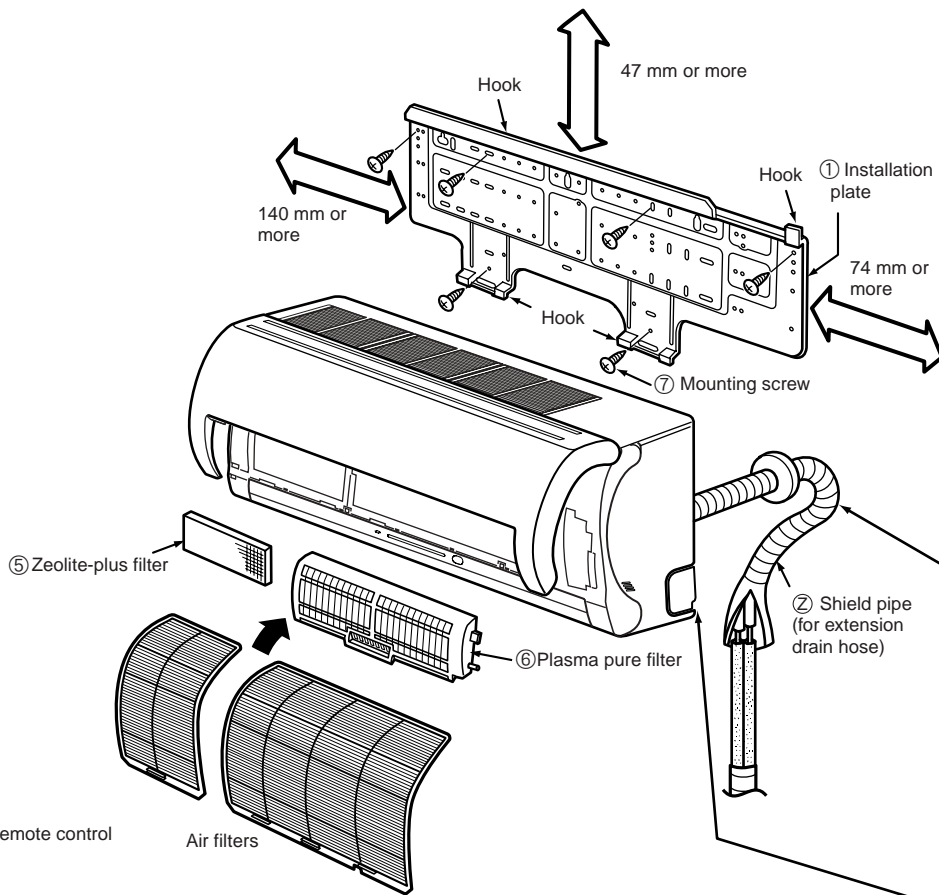

For the rear left and left piping

Insert the cushion between the indoor unit and wall, and tilt the indoor unit for better installation work.

Do not allow the drain hose to become slack.

Cut the piping hole slightly sloped

Make sure the drain hose is sloped downward.

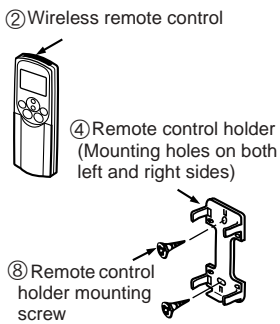

The auxiliary piping can be connected at the left, rear left, rear right, right, bottom right or bottom left as shown below.

**Before installing the wireless remote control**

- With the remote control cover removed, correctly load the supplied batteries while observing their polarity.

2 Wireless remote control

3 Batteries

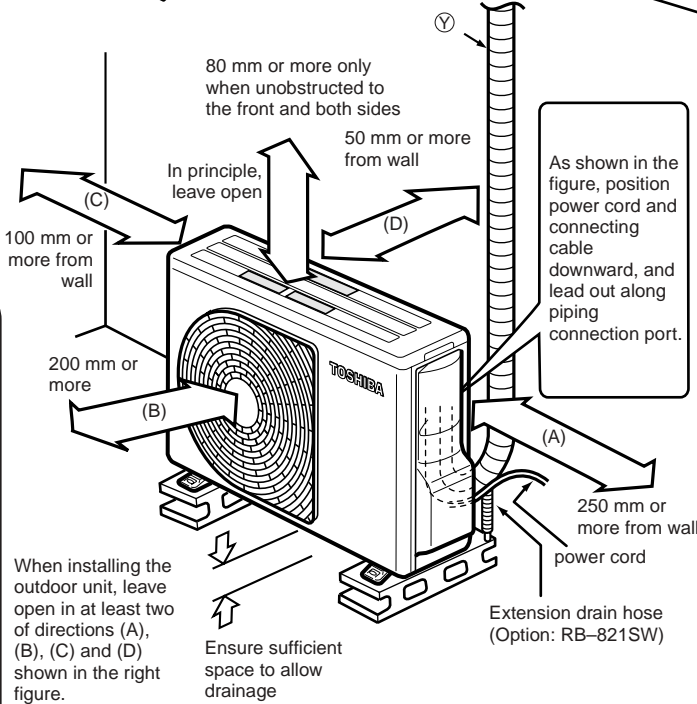

Insulate the refrigerant pipes separately, not together.

6 mm thick heat resisting polyethylene foam

In case the piping is installed above the ceiling, it shall be covered with thicker insulating material (polyethylene form, 10 mm-thick)

## 10-2.Optional Parts, Accesories and Tools

### Optional Installation Parts





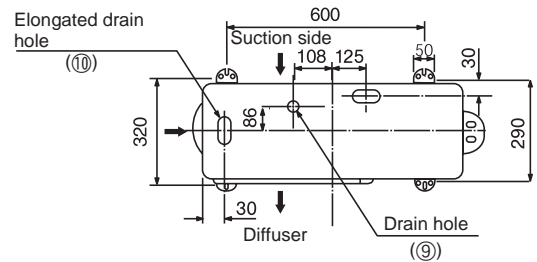

Part Code	Parts name			Q'ty
㉞	Refrigerant piping			1 ea.
	Indoor unit name	Liquid side (Outer diameter)	Gas side (Outer diameter)	
	10, 13	6.35 mm	9.52 mm	
	16	6.35 mm	12.7 mm	
㉟	Shield pipe (for extension drain hose) (polyethylene foam, 6 mm thick)			1

#### Attachment bolt arrangement of outdoor unit

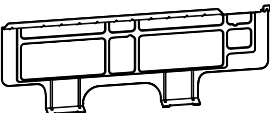
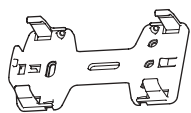
- Secure the outdoor unit with the attachment bolts and nuts if the unit is likely to be exposed to a strong wind.
- Use  $\phi 8$  mm or  $\phi 10$  mm anchor bolts and nuts.  
If it is necessary to drain the defrost water, attach drain nipple to the base plate of the outdoor unit before installing it.

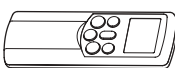
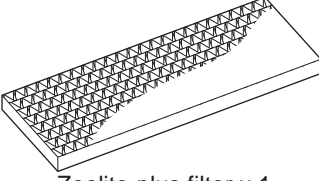

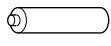
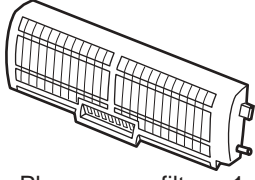
### Accessory and Installation Parts

Part No.	Part name (Q'ty)	Part No.	Part name (Q'ty)	Part No.	Part name (Q'ty)
①	 Installation plate x 1	④	 Remote control holder x 1	⑦	 Mounting screw $\phi 4 \times 25L \times 6$
②	 Wireless remote control x 1	⑤	 Zeolite-plus filter x 1	⑧	 Remote control holder mounting screw $\phi 3.1 \times 16L \times 2$
③	 Battery x 2	⑥	 Plasma pure filter x 1	⑨	 Drain nipple* x 1 (Heat pump models only)

#### Others

Name
Owner's manual (Indoor unit)
Installation manual (Indoor unit)
Installation manual (Outdoor unit)
Specifications (Outdoor unit)

This model is not equipped with an extension drain hose.

#### Option:

- For the extension drain hose, use the optionally available RB-821SW or a commercially available one.
- Use the following parts for installaion of B16EKVP-E, M16EKVP-E.

⑩



Water-proof rubber cap\* x 2  
(Heat pump models only)

Parts marked with asterisk (\*) are packaged with the outdoor unit.

Parts name
RB-M34EE Expander ( $\phi 9.52 \rightarrow \phi 12.7$ )







## Installation/Service Tools

### Changes in the product and components

In air conditioners using R410A, in order to prevent any other refrigerant from being accidentally charged, the service port diameter size of the outdoor unit control valve (3 way valve) has been changed. (1/2 UNF 20 threads per inch)

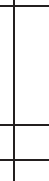
- In order to increase the pressure resisting strength of the refrigerant piping, flare processing diameter and opposing flare nuts sizes have been changed. (for copper pipes with nominal dimensions 1/2 and 5/8)

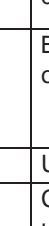
### New tools for R410A

New tools for R410A	Applicable to R22 model		Changes
Gauge manifold	×		As the working pressure is high, it is impossible to measure the working pressure using conventional gauges. In order to prevent any other refrigerant from being charged, the port diameters have been changed.
Charge hose	×		In order to increase pressure resisting strength, hose materials and port sizes have been changed (to 1/2 UNF 20 threads per inch). When purchasing a charge hose, be sure to confirm the port size.
Electronic balance for refrigerant charging	○		As working pressure is high and gasification speed is fast, it is difficult to read the indicated value by means of charging cylinder, as air bubbles occur.
Torque wrench (nominal dia. 1/2, 5/8)	×		The size of opposing flare nuts have been increased. Incidentally, a common wrench is used for nominal diameters 1/4 and 3/8.
Flare tool (clutch type)	○		By increasing the clamp bar's receiving hole size, strength of spring in the tool has been improved.
Gauge for projection adjustment	—		Used when flare is made by using conventional flare tool.
Vacuum pump adapter	○		Connected to conventional vacuum pump. It is necessary to use an adapter to prevent vacuum pump oil from flowing back into the charge hose. The charge hose connecting part has two ports — one for conventional refrigerant (7/16 UNF 20 threads per inch) and one for R410A. If the vacuum pump oil (mineral) mixes with R410A a sludge may occur and damage the equipment.
Gas leakage detector	×		Exclusive for HFC refrigerant.

- Incidentally, the “refrigerant cylinder” comes with the refrigerant designation (R410A) and protector coating in the U.S's ARI specified rose color (ARI color code: PMS 507).
- Also, the “charge port and packing for refrigerant cylinder” requires 1/2 UNF 20 threads per inch corresponding to the charge hose's port size.

## 10-3. Installation of Indoor Unit

### Installation Location

- A place which provides enough space around the indoor unit as shown in the diagram.
- A place where there are no obstacles near the air inlet and outlet.
- A place which allows easy installation of the piping to the outdoor unit.
- A place which allows the front panel to be opened.
- The indoor unit shall be installed so that the top of the indoor unit is positioned at least 2 m high.
- Also, avoid putting anything on the top of the indoor unit.

### CAUTION

- Direct sunlight on the indoor unit wireless receiver should be avoided.
- The microprocessor in the indoor unit should not be too close to r-f sources.  
(For details, see the owner's manual.)

### Remote control

- Should be placed where there are no obstacles, such as curtains, that may block the signal.
- Do not install the remote control in a place exposed to direct sunlight or close to a heating source, such as a stove.
- Keep the remote control at least 1 m away from the nearest TV set or stereo equipment. (This is necessary to prevent image disturbance or noise interference.)
- The location of the remote control should be determined as shown below.

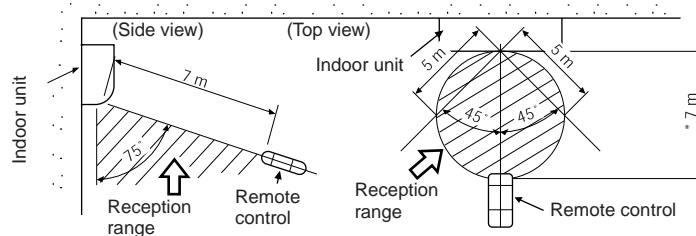

\*: Axial distance

### Drilling a Hole and Mounting Installation Plate

#### Drilling a hole

When installing the refrigerant pipes from the rear.

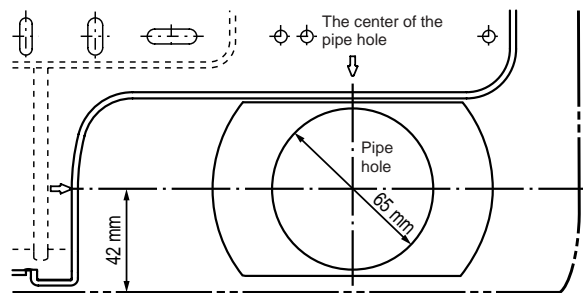

1. After determining the pipe hole position on the installation plate (⇔) drill the pipe hole ( $\phi 65$  mm) at a slight downward slant to the out door side.

### NOTE

- When drilling into a wall that contains a metal lath, wire lath or metal plate, be sure to use a pipe hole brim ring sold separately.

## Mounting the installation plate

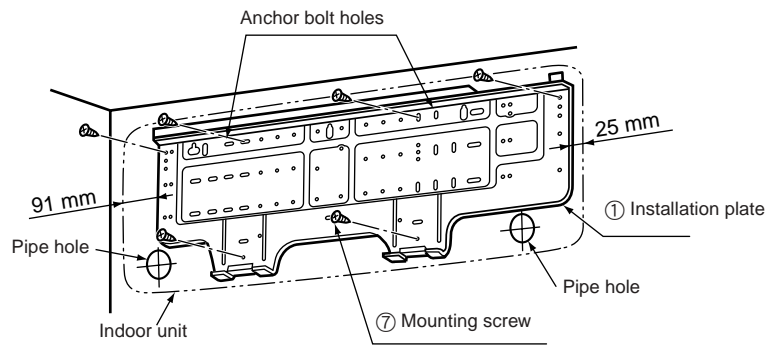

### When the installation plate is directly mounted on the wall

1. Securely fit the installation plate onto the wall by screws with the upper and lower catches, that hold the indoor unit, facing out.
2. To mount the installation plate on a concrete wall use anchor bolts. Drill the anchor bolt holes as illustrated in the above figure.
3. Install the installation plate horizontally and level.

#### CAUTION

When installing the installation plate with mounting screws, do not use anchor bolt holes. Otherwise the unit may fall down and result in personal injury and property damage.

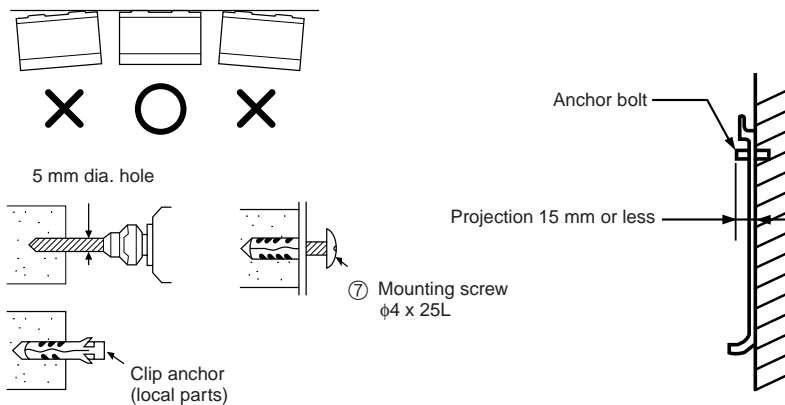

#### CAUTION

Failure to securely install the unit may result in personal injury and/or property damage if the unit falls.

- In case of block, brick, concrete or similar type walls, drill 5 mm dia. holes in the wall.
- Insert clip anchors for the ⑦ mounting screws.

#### NOTE

- Install the installation plate using between 4 to 6 mounting screws, being sure to secure all four corners.

### Electrical Work

1. The supply voltage must be the same as the rated voltage of the air conditioner.
2. Prepare a power source for the exclusive use of the air conditioner.

#### NOTE

- Wire type: More than H07RN-F or 245IEC66 (1.0 mm<sup>2</sup> or more)



## CAUTION

- This appliance can be connected to a main circuit breaker in either of the following two ways.
  - (1) Connection to fixed wiring:  
A switch or circuit breaker which disconnects all poles and has a contact separation of at least 3 mm must be incorporated in the fixed wiring. An approved circuit breaker or switch must be used.
  - (2) Connection with power supply plug:  
Attach power supply plug with power cord and plug it into wall outlet. An approved power supply cord and plug must be used.

## NOTE

- Perform wiring work being sure the wire length is long enough.

## Wiring Connection

### How to connect the connecting cable

Wiring the connecting cable can be carried out without removing the front panel.

1. Remove the air inlet grille. Open the air inlet grille upward and pull it toward you.
2. Remove the terminal cover and cord clamp.
3. Insert the connecting cable (or as according to local regulations/codes) into the pipe hole on the wall.
4. Pull the connecting cable through the cable slot on the rear panel so that it protrudes about 15 cm out of the front.
5. Insert the connecting cable fully into the terminal block and secure it tightly with screws.
6. Tightening torque: 1.2 N·m (0.12 kgf·m)
7. Secure the connecting cable with the cord clamp.
8. Attach the terminal cover, rear plate bushing and air inlet grille on the indoor unit.

## CAUTION

- Be sure to refer to the wiring system diagram labeled inside the front panel.
- Check local electrical regulations for any specific wiring instructions or limitations.

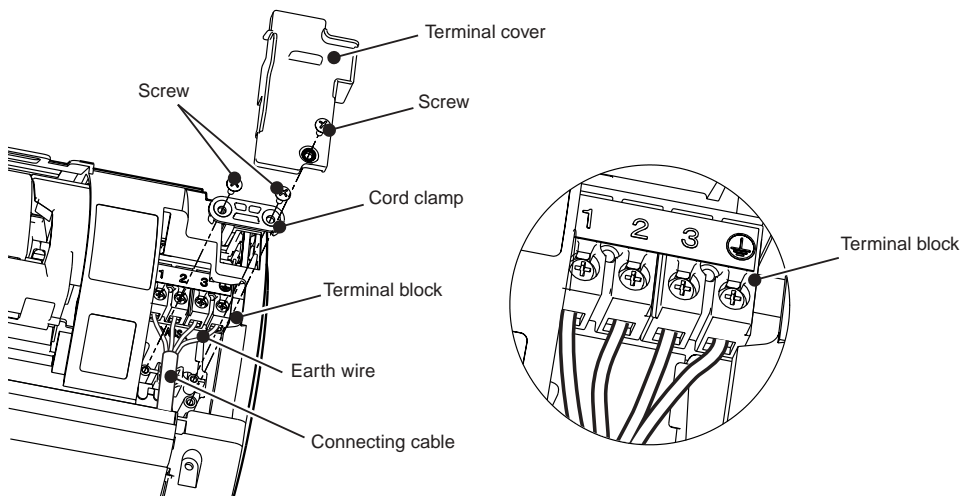

## NOTE

Wire type: More than H07RN-F or 245IEC66 (1.0 mm<sup>2</sup> or more)

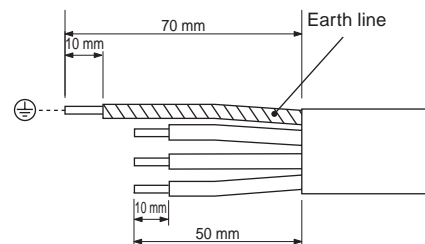
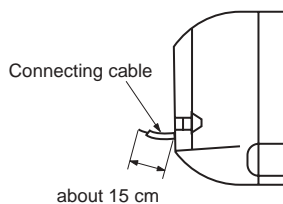

## Piping and Drain Hose Installation

### Piping and drain hose forming

- Since condensation results in machine trouble, make sure to insulate both the connecting pipes separately. (Use polyethylene foam as insulating material.)

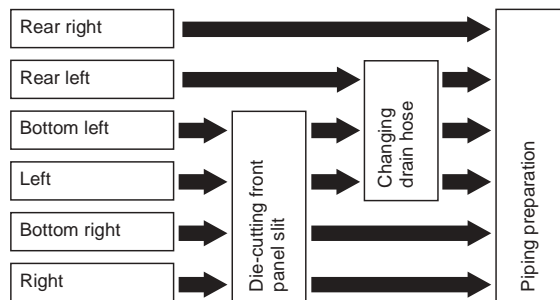

#### 1. Die-cutting front panel slit

Cut out the slit on the left or right side of the front panel for the left or right connection and the slit on the bottom left or right side of the front panel for the bottom left or right connection with a pair of nippers.

#### 2. Changing drain hose

For left connection, left-bottom connection and rear-left connection's piping, it is necessary to relocate the drain hose and drain cap.

##### • How to remove the drain cap

Clamp drain cap with needle-nose pliers, and pull out.

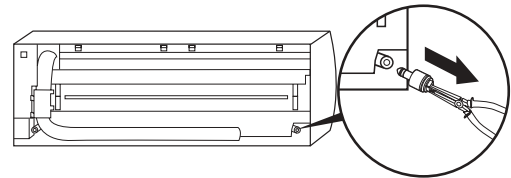

##### • How to remove the drain hose

The drain hose is secured in place by a screw.

Remove the screw securing the drain hose, then pull out the drain hose.

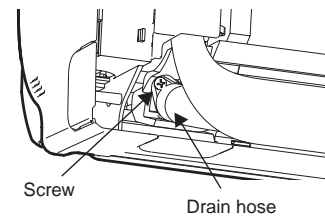

##### • How to attach the drain cap

1. Insert hexagonal wrench (4 mm).

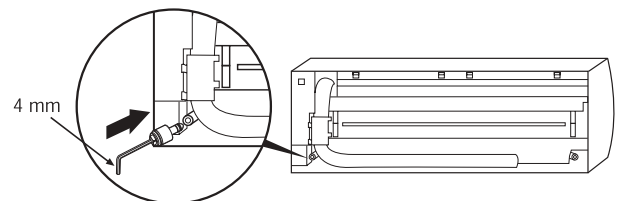

2. Firmly insert drain cap.

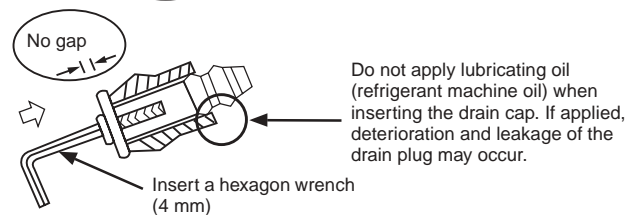

##### • How to attach the drain hose

Always use the original screw that secured the drain hose to the unit. Using a different screw may cause water to leak.

Insert the drain hose firmly until the connector contacts the insulation, then secure it in place using the original screw.

### CAUTION

Securely insert the drain hose and drain cap; otherwise, water may leak.

### In case of right or left piping

- After making slits on the front panel with a knife or similar tool, cut them out with a pair of nippers or an equivalent tool.

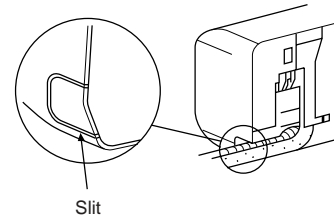

### In case of bottom right or bottom left piping

- After making slits on the front panel with a knife or similar tool, cut them out with a pair of nippers or an equivalent tool.

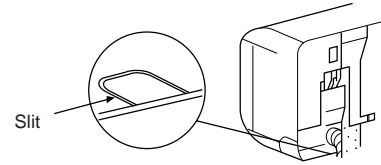

### Left-hand connection with piping

Bend the connecting pipes so that they are positioned within 43 mm above the wall surface. If the connecting pipes are positioned more than 43 mm above the wall surface, the indoor unit may be unstable. When bending the connecting pipe, make sure to use a spring bender to avoid crushing the pipe.

Refer to the table below for the bending radius of each connection pipe.

Outer diameter	Bending radius
6.35 mm	30 mm
9.52 mm	40 mm
12.7 mm	50 mm

To connect the pipe after installation of the unit (figure)

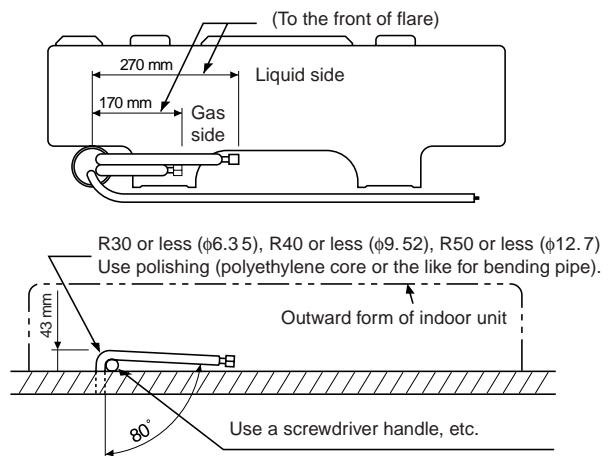

### NOTE

If the pipe is incorrectly bent, the indoor unit may be unstable on the wall.

After passing the connecting pipe through the pipe hole, connect the connecting pipe to the auxiliary pipes and wrap the facing tape around them.

### CAUTION

- Bind the auxiliary pipes (two) and connecting cable with facing tape tightly. In case of leftward piping and rear-leftward piping, bind the auxiliary pipes (two) only with facing tape.

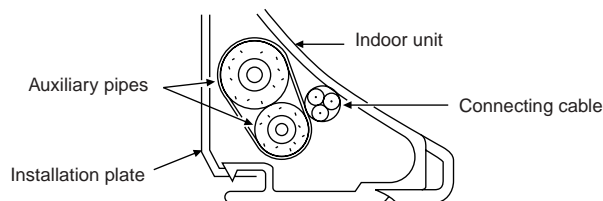

- Carefully arrange the pipes so that none of the pipes stick out of the rear plate of the indoor unit.
- Carefully connect the auxiliary pipes and connecting pipes to each other and cut off the insulating tape wound on the connecting pipe to avoid double-taping at the joint, moreover, seal the joint with the vinyl tape, etc.
- Since condensation can result in machine performance trouble, be sure to insulate both connecting pipes. (Use polyethylene foam as insulating material.)
- When bending a pipe, be careful not to crush it.

## Indoor Unit Installation

1. Pass the pipe through the hole in the wall, and hook the indoor unit on the installation plate at the upper hooks.
2. Swing the indoor unit to right and left to confirm that it is firmly hooked on the installation plate.
3. While pressing the indoor unit onto the wall, hook it at the lower part on the installation plate. Pull the indoor unit toward you to confirm that it is firmly hooked on the installation plate.

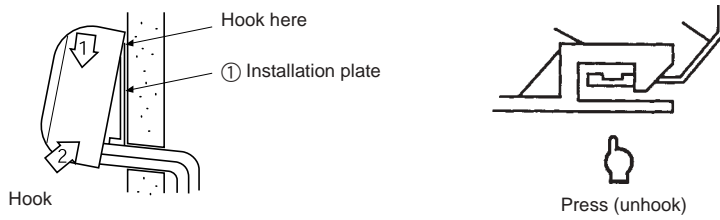

- For detaching the indoor unit from the installation plate pull the indoor unit toward you while pushing the bottom up at the specified places.

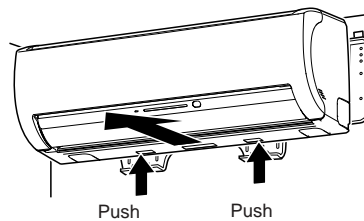

## Drainage

1. Run the drain hose at a downward sloped angle.

### NOTE

- Hole should be made at a slight downward slant on the outdoor side.

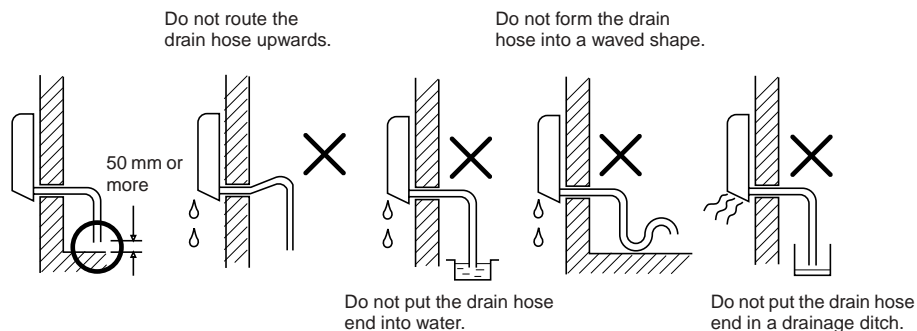

2. Put water in the drain pan and make sure that the water is being drained outside.
3. When connecting extension drain hose, insulate the connection part of extension drain hose with shield pipe.

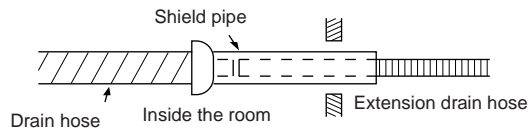

### CAUTION

Install the drain pipe for proper drainage. Improper drainage can result in water dripping inside the room.

This air conditioner has been designed to drain water collected from condensation which forms on the back of the indoor unit, to the drain pan. Therefore, do not locate the power cord and other parts at a height above the drain guide.

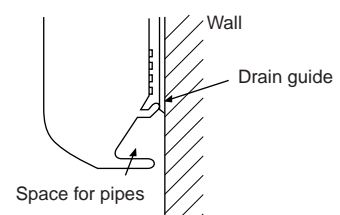

**10-4. Which Models Can Be Combined**  
**Table of models that can be connected**

Type	Outdoor unit	Indoor unit		
Heat pump	RAS-M14EAV-E	RAS-B10EKVP-E	RAS-B13EKVP-E	
		RAS-M10UKV-E3	RAS-M13UKV-E3	
		RAS-M10YDV-E	RAS-M13YDV-E	
	RAS-M18EAV-E	RAS-B10EKVP-E	RAS-B13EKVP-E	RAS-B16EKVP-E
		RAS-M10UKV-E3	RAS-M13UKV-E3	RAS-M16UKV-E3
		RAS-M10YDV-E	RAS-M13YDV-E	RAS-M16YDV-E
Cooling-only	RAS-M14EACV-E	RAS-M10EKCV-E	RAS-M13EKCV-E	
		RAS-M10UKCV-E3	RAS-M13UKCV-E3	
		RAS-M10YDCV-E	RAS-M13YDCV-E	
	RAS-M18EACV-E	RAS-M10EKCV-E	RAS-M13EKCV-E	RAS-M16EKCV-E
		RAS-M10UKCV-E3	RAS-M13UKCV-E3	RAS-M16UKCV-E3
		RAS-M10YDCV-E	RAS-M13YDCV-E	RAS-M16YDCV-E

**Table of models that can be used in combination**

Type	Outdoor unit	Combinations of indoor unit models that can be connected
Heat pump	RAS-M14EAV-E	10+10, 10+13
	RAS-M18EAV-E	10+10, 10+13, 10+16, 13+13
Cooling-only	RAS-M14EACV-E	10+10, 10+13
	RAS-M18EACV-E	10+10, 10+13, 10+16, 13+13

**NOTES**

A 1-room connection is not an option for the indoor units (you cannot connect only one indoor unit). A 2-room connection must always be used for the indoor units (you must connect two indoor units).

With the RAS-M14EAV-E and RAS-M14EACV-E outdoor unit models, the 13 + 13 combination is not an option.

With the RAS-M18EAV-E and RAS-M18EACV-E outdoor unit models, the 13 + 16 or 16 + 16 combination is not an option.

## 10-5. Installation of Outdoor Unit

### 10-5-1. Installation Location

- A place which provides enough space around the outdoor unit as shown in the diagram.
- A place which can bear the weight of the outdoor unit and does not allow an increase in noise level and vibration.
- A place where the operation noise and discharged air do not disturb neighbors.
- A place which is not exposed to a strong wind.
- A place free of combustible gases.
- A place which does not block a passageway.
- When the outdoor unit is to be installed in an elevated position, be sure to secure its feet.
- Piping connections to the outdoor unit should be arranged in the sequence A, then B, starting from the bottom. (For each piping connection, the gas pipe is on the bottom and the liquid pipe on top.)
- When multiple indoor units are to be connected to the outdoor unit, make sure the ends of the pipes and wires from each indoor unit are connected to the outdoor unit correctly. (Problems caused by indoor units being connected to the outdoor unit incorrectly are very common in multiple-unit installations.)
- The length and height differences of the connecting pipes, between the indoor and outdoor units, must be within the ranges indicated below.

- Total piping length: Two room (A+B) Multi

- This air conditioner accepts a connection piping length of up to 30 m.
  - There is no need to add refrigerant as long as the length of the connection piping is 20 m or less.
  - You will need to add 20 g of refrigerant per meter of added connection piping for installations requiring connection piping to be between 21 m to 30 m.

- Minimum piping length:

A or B = 2 m or more

- Maximum indoor piping length:

A or B = 20 m or less

- Maximum piping height difference:

A or B = 10 m or less

- Maximum piping / height difference between two rooms = 10 m or less

- If the outdoor unit is to be mounted on a wall, make sure the platform supporting it is sturdy enough. The platform should be designed and manufactured to maintain its strength over a long period of time, and sufficient consideration should be given to ensuring that the outdoor unit will not fall.
- When the outdoor unit is to be mounted high on a wall, take particular care to ensure that parts do not fall, and that the installer is protected.
- When doing installation work at ground level, it is usual to make wiring and pipe connections to the indoor units, first, and then to make connections to the outdoor unit. However, if outdoor work is difficult it is possible, instead, to make changes to the procedure. For example, by making adjustments to the wiring and piping lengths on the inside (rather than the outside).
- A place where the drain water does not cause any problems.
- The outdoor unit should not be installed with one indoor unit only. Be sure the (outdoor) unit is installed with at least two indoor units.

### Precautions for Adding Refrigerant

- Use a scale having a precision with at least 10 g per index line when adding the refrigerant. Do not use a bathroom scale or similar instrument.
- Use liquid refrigerant when refilling the refrigerant. Since the refrigerant is in liquid form, it can fill quickly. Therefore, perform the filling operation carefully and insert the refrigerant gradually.

Installation diagram of outdoor units

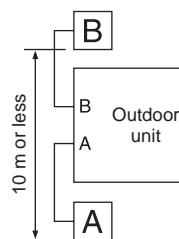
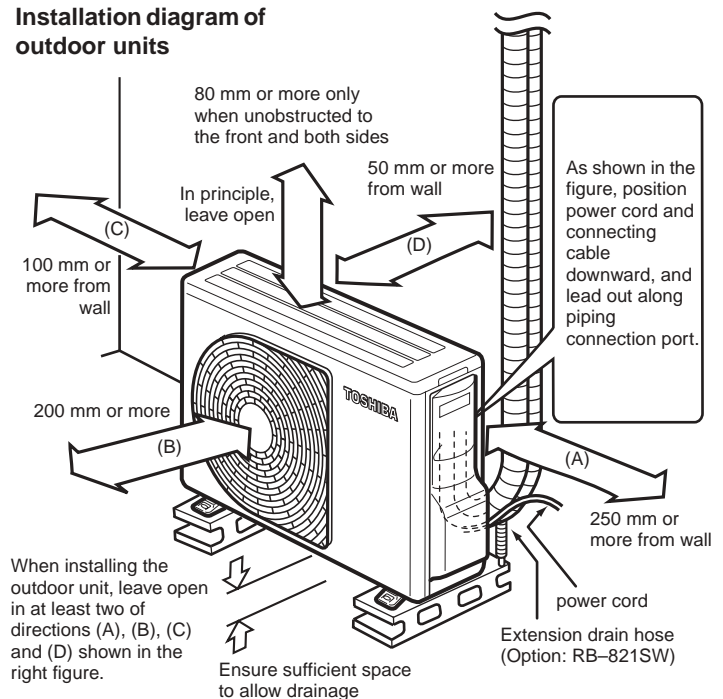

## CAUTION

1. Install the outdoor unit without anything blocking the discharging air.
2. When the outdoor unit is installed in a place always exposed to strong winds like on the coast or on a high story of a building, secure the normal fan operation using a duct or a wind shield.
3. Especially in windy areas, install the unit to prevent the admission of wind.
4. Installation in the following places may result in trouble. Do not install the unit in such places.
  - A place full of machine oil.
  - A saline-place such as the coast.
  - A place full of sulfide gas.
  - A place where high-frequency waves are likely to be generated, such as from audio equipment, welders, and medical equipment.

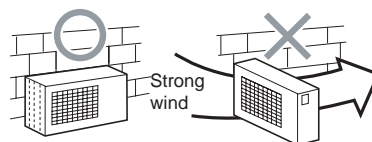

## Draining the water

- Holes are provided on the base plate of the outdoor unit to ensure that the defrost water produced during heating operations is drained off efficiently. If a centralized drain is required when installing the unit on a balcony or wall, follow the steps below to drain off the water.
1. Proceed with water-proofing by installing the water-proof rubber caps ④ in the 2 elongated holes on the base plate of the outdoor unit.  
[How to install the water-proof rubber caps]
    - 1) Place four fingers into each cap, and insert the caps into the water drain holes by pushing them into place from the underside of the base plate.
    - 2) Press down on the outer circumferences of the caps to ensure that they have been inserted tightly.  
(Water leaks may result if the caps have not been inserted properly, if their outer circumferences lift up or the caps catch on or wedge against something.)
  2. Install the drain nipple ③ and a commercially available drain hose (with 16 mm inside diameter), and drain off the water.  
(For the position where the drain nipple ③ is installed, refer to the installation diagram of the indoor and outdoor units.)
- Check that the outdoor unit is horizontal, and route the drain hose at a downward sloped angle while ensuring that it is connected tautly.

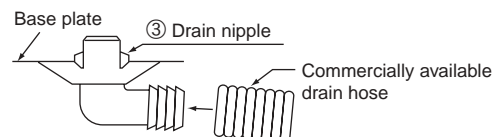
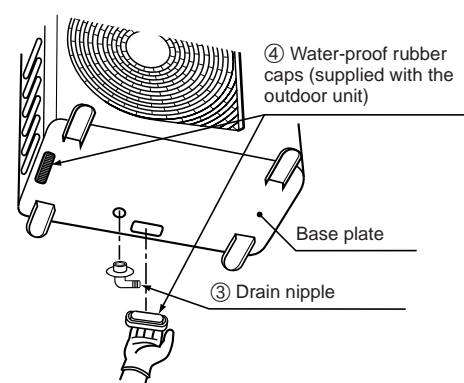

Do not use ordinary garden hose, which can flatten and prevent water from draining.

## 10-5-2. Refrigerant Piping Connection

### Flaring

- Cut the pipe with a pipe cutter.

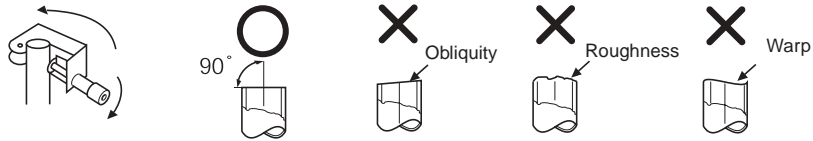

- Insert a flare nut into the pipe, and flare the pipe.
  - Projection margin in flaring: A (Unit: mm)

#### Rigid (Clutch type)

Outer diameter of copper pipe	R410A tool used	Conventional tool used
6.35	0 to 0.5	1.0 to 1.5
9.52	0 to 0.5	1.0 to 1.5
12.7	0 to 0.5	1.0 to 1.5

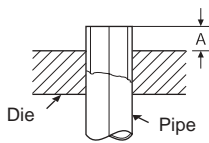

#### Imperial (Wing nut type)

Outer diameter of copper pipe	R410A
6.35	1.5 to 2.0
9.52	1.5 to 2.0
12.7	2.0 to 2.5

- Flaring size : B (Unit : mm)

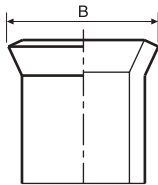

Outer diameter of copper pipe	B $\begin{smallmatrix} +0 \\ -0.4 \end{smallmatrix}$	
	R410A	R22
6.35	9.1	9.0
9.52	13.2	13.0
12.7	16.6	16.2

- In case of flaring for R410A with the conventional flare tool, pull it out approx. 0.5 mm more than that of R22 to adjust to the specified flare size. The copper pipe gauge is useful for adjusting projection margin size.

### Tighten the connection

Align the centers of the connecting pipes and tighten the flare nut as much as possible with your fingers. Then tighten the nut with a wrench and torque wrench as shown in the figure.

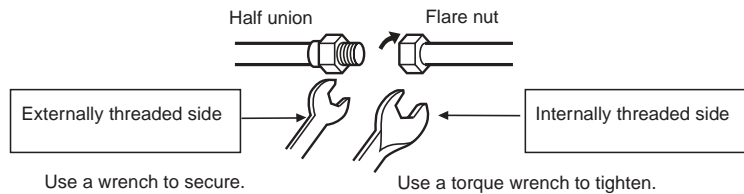

### CAUTION

- Do not apply excessive force. Otherwise, the nut may break.

(Unit: N·m)

Outer diameter of copper pipe	Tightening torque
φ6.35 mm	14 to 18 (1.4 to 1.8 kgf·m)
φ9.52 mm	33 to 42 (3.3 to 4.2 kgf·m)
φ12.7 mm	50 to 62 (5.0 to 6.2 kgf·m)

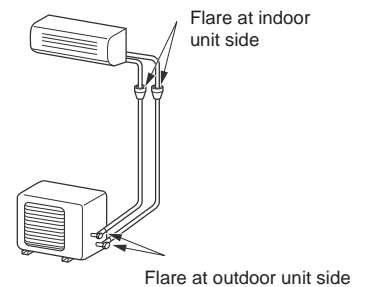



- Tightening torque for connection of flare pipe

The pressure of R410A is higher than R22. (Approx. 1.6 times.) Therefore securely tighten the flare pipes which connect the outdoor unit and the indoor unit with the specified tightening torque using a torque wrench.

If any flare pipe is incorrectly connected, it may cause not only a gas leakage but also trouble in the refrigeration cycle.

	Connectable capacity class		
	A	B	Total
M14	10, 13	10, 13	23
M18	10, 13, 16*1	10, 13, 16*1	26

\*1 When connecting a capacity class 16 pipe to the indoor unit, attach the expander which is available as an optional accessory to the 9.52 mm diameter packed valve of the outdoor unit.

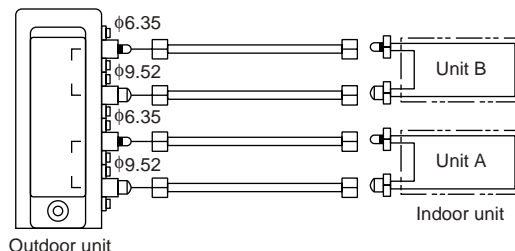

### 10-5-3. Evacuating

After the piping has been connected to the indoor unit, perform the air purge.

#### AIR PURGE

Evacuate the air in the connecting pipes and in the indoor unit using a vacuum pump. Do not use the refrigerant in the outdoor unit. For details, see the vacuum pump manual.

#### Use a vacuum pump

Be sure to use a vacuum pump with counter-flow prevention function so that oil inside the pump does not flow back into the air conditioner pipes when the pump stops. (If oil inside the vacuum pump enters into the air conditioner circuit which uses R410A, trouble with the refrigeration system may develop.)

1. Connect the charge hose from the manifold valve to the service port of the gas side packed valve.
2. Connect the charge hose to the port of the vacuum pump.
3. Open fully the low pressure side handle of the gauge manifold valve.
4. Operate the vacuum pump to begin evacuating. Perform evacuating for about 15 minutes if the piping length is 20 meters (15 minutes for 20 meters) (assuming a pump capacity of 27 liters per minute). Confirm that the compound pressure gauge reading is  $-101 \text{ kPa}$  ( $-76 \text{ cmHg}$ ).
5. Close the low pressure valve handle of gauge manifold.
6. Open fully the valve stem of the packed valves (both sides of Gas and Liquid).
7. Remove the charging hose from the service port.
8. Securely tighten the caps on the packed valves.
9. Perform steps 1 through 8 above on each connected indoor unit.

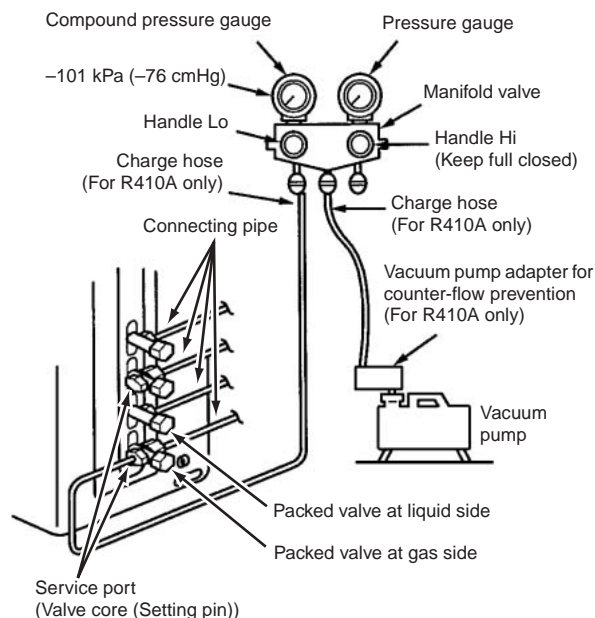

#### CAUTION

##### • IMPORTANT POINTS FOR PIPING WORK

- (1) Keep dust and moisture from entering the pipes.
- (2) Tighten connections carefully (between pipes and unit).
- (3) Evacuate the air in the connecting pipes using a VACUUM PUMP.
- (4) Check for gas leaks at all connections.

### Packed valve handling precautions

- Open the valve stem all the way; but do not try to open it beyond the stopper.  
Securely tighten the valve stem cap with torque in the following table:

Gas side ( $\Phi$ 12.7 mm)	50 to 62 N·m (5.0 to 6.2 kgf·m)
Gas side ( $\Phi$ 9.52 mm)	33 to 42 N·m (3.3 to 4.2 kgf·m)
Liquid side ( $\Phi$ 6.35 mm)	14 to 18 N·m (1.4 to 1.8 kgf·m)
Service port	14 to 18 N·m (1.4 to 1.8 kgf·m)

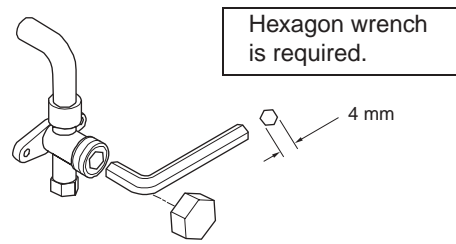

### 10-5-4. Wiring Connection

1. Remove the valve cover, the electric parts cover and the cord clamp from the outdoor unit.
2. Connect the connecting cable to the terminal as identified by the matching numbers on the terminal block of indoor and outdoor unit.
3. Insert the power cord and the connecting cable fully into the terminal block and secure it tightly with screws.
4. Insulate the unused cords (conductors) from water entering in the outdoor unit. Locate them so that they do not touch any electrical or metal parts.
5. Secure the power cord and the connecting cable with the cord clamp.
6. Attach the electric parts cover and the valve cover on the outdoor unit.

### Stripping length of connecting cable

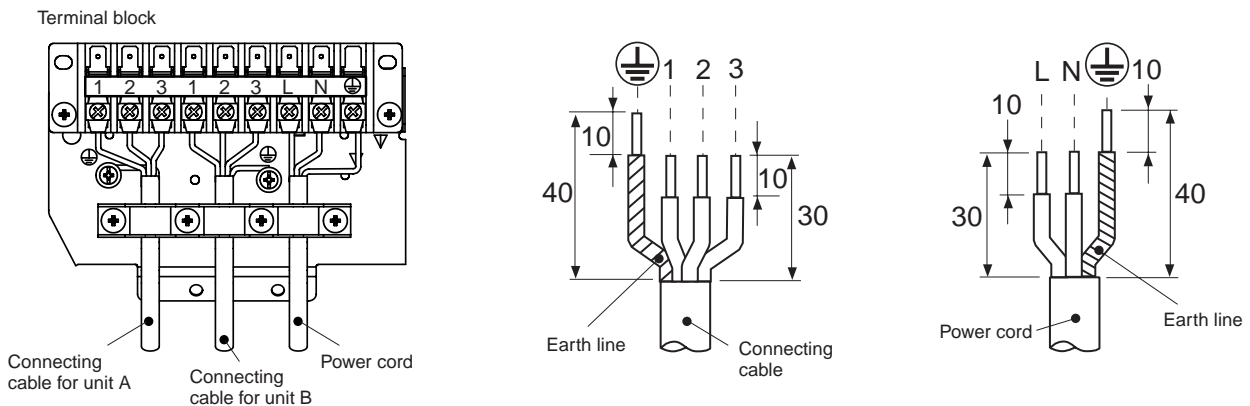

Model	RAS-M14EAV-E	RAS-M18EAV-E	RAS-M14EACV-E	RAS-M18EACV-E
Power source	220–240V ~50Hz 220V ~60Hz			
Maximum running current	10.0A	15.0A	8.0A	11.0A
Installation fuse rating	25A (D type  )			
Power cord	H07RN-F or 245IEC66 (1.5 mm <sup>2</sup> or more)			
Connecting cable	H07RN-F or 245IEC66 (1.0 mm <sup>2</sup> or more)			

### CAUTION

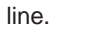
- Incorrect wiring connection may cause electrical parts to burn out.
- Be sure to comply with local regulations/codes when running the wire from outdoor unit to indoor unit. (Size of wire and wiring method etc.)
- Every wire must be securely connected.
- This installation fuse (25A D type ) must be used for the power supply line.
- If incorrect or incomplete wiring is carried out, fire or smoke may result.
- Prepare the power supply for the exclusive use of the air conditioner.
- This product can be connected to the main breaker.  
Connection to fixed wiring: A switch which disconnects all poles and has a contact separation of at least 3 mm must be incorporated in the fixed wiring when connecting to a main breaker circuit.

## 10-6. Grounding

### This air conditioner must be grounded without fail.

Grounding is necessary not only to safeguard against the possibility of receiving an electric shock but also to absorb both the static, which is generated by high frequencies and held in the surface of the outdoor unit, and noise since the air conditioner incorporates a frequency conversion device (called an inverter) in the outdoor unit. If the air conditioner is not grounded, users may receive an electric shock if they touch the surface of the outdoor unit and that unit is charged with static.

## 10-7. Check and Test Operation

For R410A, use the leak detector exclusively manufactured for HFC refrigerant (R410A, R134a, etc.)

- \* The conventional leak detector for HCFC refrigerant (R22, etc.) cannot be used because its sensitivity for HFC refrigerant lowers to approx. 1/40 of that manufactured exclusively for HFC refrigerant.
- Pressure of R410A becomes approx. 1.6 times that of R22. If installation work has not completely finished, gas leaks may occur in cases such as when pressure rises during operation.
- Check the flare nut connections, valve stem cap connections and service port cap connections for gas leaks with a leak detector or soap water.

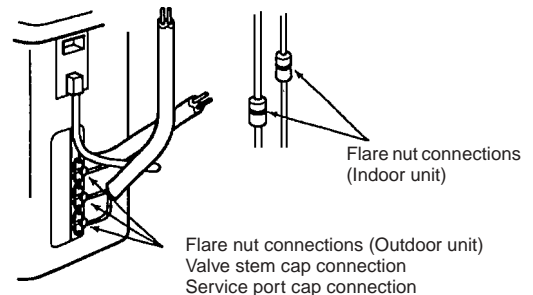

### CAUTION

- Use a circuit breaker of a type that is not tripped by shock waves.
- Incorrect/incomplete wiring will cause electrical fires or smoke.
- Prepare the power source for exclusive use with the air conditioner.
- Proceed as follows when connecting the product to the mains power.
  - Connection to fixed wiring:
    - A switch or circuit breaker which disconnects all poles and has a contact separation of at least 3 mm must be incorporated into the fixed wiring.
    - Utilize only approved short circuit breakers and switches.
    - \* (A breaker having sensitivity of approximately 0.1 second or less and capacity of approximately 30 mA is usually used.)

### Miswiring (Mis-piping) Check

Make sure that the wiring and piping for each room have the same alphabetical code (A, B).

Connect and secure the power cord.

Use the power cord/cables with thickness, type, and protective devices specified in this manual.

Insulate the unused cords (conductors) with PVC tape.

1. Turn on the electrical power breaker.
2. Operate the indoor unit in cooling mode.
3. Start checks.
  - Run the indoor unit in room A, and confirm cool air blows out.
  - Confirm the indoor unit in room B is not running. (Also check at this time that refrigerant, which can be heard, is not flowing.)
  - Stop operation of the indoor unit in room A and execute the same checks on the indoor unit in room B.

## 10-8. Test Operation

### Gas Leak Test

- Check the flare nut connections for gas leaks with a gas leak detector and/or soapy water.

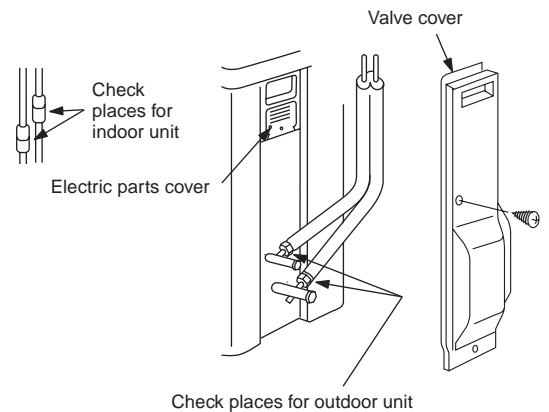

### Test Operation

To test the system, press and hold RESET button for 10 sec. (There will be one short beep.)

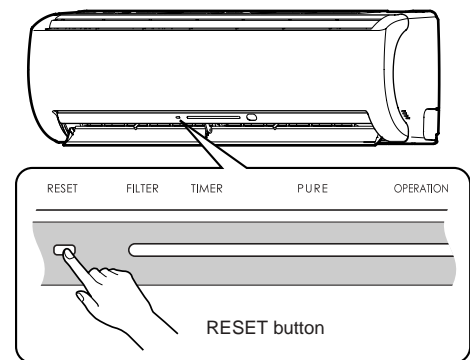

### Auto Restart Setting

This product is designed so that, after a power failure, it can restart automatically in the same operating mode as before the power failure.

### INFORMATION

The product was shipped with Auto Restart function in the OFF position. Turn it ON as required.

#### How to set the Auto Restart

- Press and hold the RESET button for about 3 seconds. After 3 seconds, three short electric beeps will be heard to inform you that the Auto Restart has been selected.
- To cancel the Auto Restart, follow the steps described in the section Auto Restart Function on page 56.

### Remote Control Selector Switch Setting

#### Remote control selector switch

- If two indoor units are installed in the same room or adjoining rooms, the second unit can inadvertently receive a remote control signal and start operation when operating the first unit. This can be prevented by setting one of the indoor units and the corresponding remote control to the B setting (the A setting is the default setting).

1. Setting the selector switch on the main unit
  - Remove the front panel, and then set the selector switch to "B".
  - After making the switch setting, remount the front panel.
2. Setting the remote control
  - ① Slide open the remote control cover and remove the batteries.
  - ② Cut the jumper wire inside the battery compartment using nippers.
    - The jumper wire should not remain in contact after being cut. Also, be careful not to let plastic scraps, jumper wire cuttings or other debris enter the inside of the remote control.
  - ③ Insert the batteries. "B" appears in the remote control display.
3. Check that the indoor unit can be operated by the modified remote control.

Position of remote control selector switch

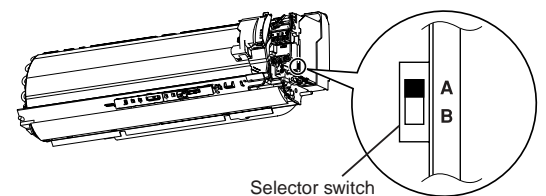

Selector switch

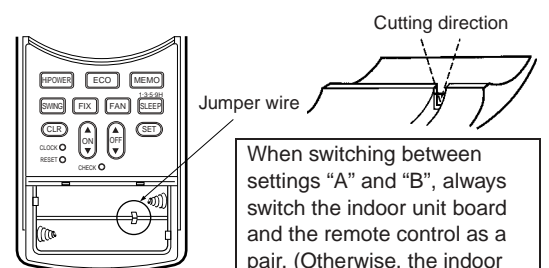

Cutting direction

Jumper wire

When switching between settings "A" and "B", always switch the indoor unit board and the remote control as a pair. (Otherwise, the indoor unit will not accept the remote control's signals.)

## 10-9. USEFUL FUNCTIONS

### Self-Diagnosis by LED Indication

- For this outdoor unit, by referring to the 5 LED (Red) indicator lights, self-diagnosis is possible.
- LEDS (Red, D09 to D13) are located on the sub-control board underneath the inverter.

Contents	Indoor alarm code	LED indication				
		D09	D10	D11	D12	D13
Normal running	None	●	●	●	●	●
IGBT short circuit, Compressor motor rear short	14	●	○	●	●	●
Trouble on position detecting circuit	16	○	○	●	●	●
Trouble on current detecting circuit	17	●	●	○	●	●
CONDENSOR PIPE TEMP. SENSOR(TE) fault	18	○	●	○	○	●
SUCTION PIPE TEMP. SENSOR(TS) fault	18	●	●	○	○	●
DISCHARGE PIPE TEMP. SENSOR(TD) fault	19	●	○	○	●	●
Trouble on outdoor fan	1A	○	○	○	●	●
OUTDOOR TEMP. SENSOR(TO) fault	1B	●	●	●	○	●
Trouble on compressor system	1C	○	●	○	●	●
GAS SIDE PIPE TEMP. SENSOR a (TGa) fault	1C	○	○	○	○	●
GAS SIDE PIPE TEMP. SENSOR b (TGb) fault	1C	○	●	●	●	○
TGa, TGb sensor out of place, PMV fault	1C	○	○	○	●	○
Communication trouble between MCU	1C	○	○	●	○	○
Compressor lock	1D	○	●	●	○	●
Trouble on discharge temp. Gas leakage	1E	●	○	●	○	●
Compressor break down	1F	○	○	●	○	●

○ : LED ON, ● : LED OFF

- These LEDs do not normally light.
1. If trouble occurs, LED (Red) goes on according to the contents of trouble as shown in the table above.
  2. When two or more troubles occur, LEDs go on cyclically (alternately).
  3. When the trouble is eliminated, LEDs (Red) go off.

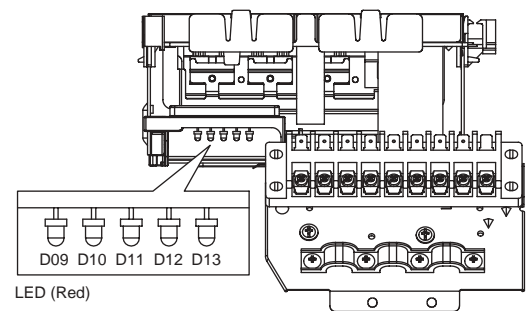

**This product is compliant with Directive 2002/96/EC, and cannot be disposed as unsorted municipal waste.**

**This product must be returned to the appropriate collection facility, as specified by your municipality.**

# 11. HOW TO DIAGNOSE THE TROUBLE

The pulse motor circuits are mounted to both indoor and outdoor units. Therefore, diagnose troubles according to the trouble diagnosis procedure as described below. (Refer to the check points in servicing written on the wiring diagrams attached to the indoor/outdoor units.)

Table 11-1

No.	Troubleshooting Procedure	Page
1	First Confirmation	80
2	Primary Judgment	81
3	Judgment by Flashing LED of Indoor Unit	81
4	Self-Diagnosis by Remote Controller	82
5	Judgment of Trouble by Every Symptom	85
6	How to Check Simply the Main Parts	95

## Precautions when handling the new inverter (3DV Inverter)

### ⚠ CAUTION: HIGH VOLTAGE

The high voltage circuit is incorporated.

Be careful to do the check service, as the electric shock may be caused in case of touching parts on the P.C. board by hand.

The new inverter (3DV inverter) will be incorporated starting with this unit.

(3DV: 3-shunt Discrete Vector control)

### ● The control circuitry has an uninsulated construction.

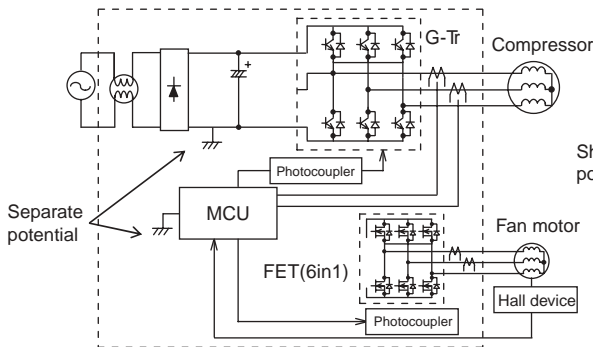

M18YAV-E, M18YACV-E (insulated type)

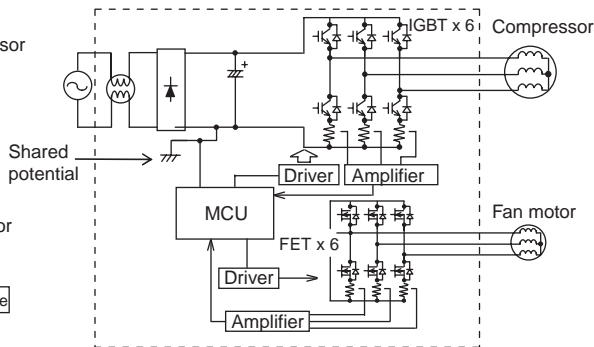

EAV-E, EACV-E series (uninsulated type)

### CAUTION!!

A high voltage (equivalent to the supply voltage) is also energized to ground through the sensors, PMV and other low-voltage circuits. The sensor leads and other wires are covered with insulated tubes for protection. Nevertheless, care must be taken to ensure that these wires are not pinched.



### CAUTION!!

Take sufficient care to avoid directly touching any of the circuit parts without first turning off the power.

### CAUTION!!

At times such as when the circuit board is to be replaced, place the circuit board assembly in a vertical position.

Laying the board flat on an electrically conductive object (such as the top panel of the air conditioner's outdoor unit) while a charge is still retained by the electrolytic capacitors of the inverter's main circuit may cause short-circuiting between the electrolytic capacitors and secondary circuit components and result in damage to the components.

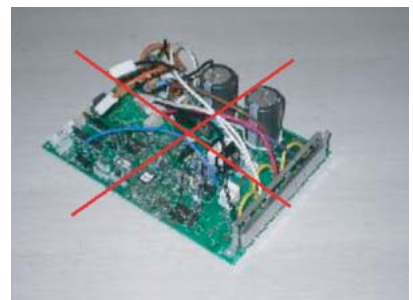

**Do NOT lay the circuit board assembly flat.**

## Precautions when inspecting the control section of the outdoor unit

### NOTE :

A large-capacity electrolytic capacitor is used in the outdoor unit controller (inverter). Therefore, if the power supply is turned off, charge (charging voltage DC280 to 380V) remains and discharging takes a lot of time. After turning off the power source, if touching the charging section before discharging, an electrical shock may be caused. Discharge the electrolytic capacitor completely by using soldering iron, etc.

### < Discharging method >

- (1) Remove the inverter cover (plating) by opening four mounting claws.
- (2) As shown below, connect the discharge resistance (approx.  $100\Omega/40W$ ) or plug of the soldering iron to voltage between + – terminals of the C14 (“CAUTION HIGH VOLTAGE” is indicated.) electrolytic capacitor ( $760\mu F/400V$ ) on P.C. board, and then perform discharging.

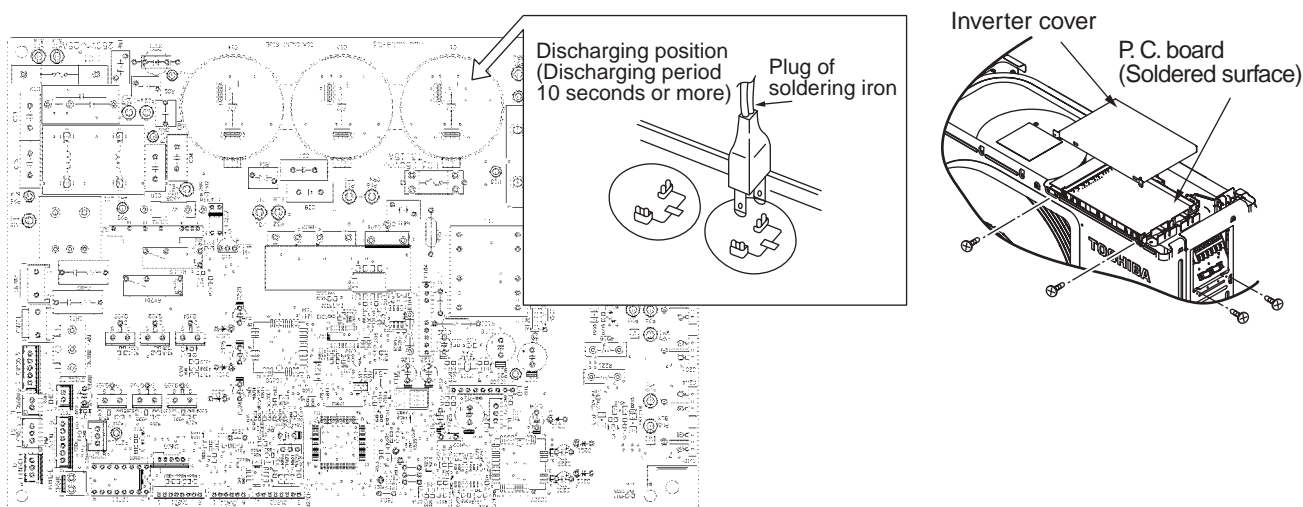

Fig. 11-1



## 11-1. First Confirmation

### 11-1-1. Confirmation of Power Supply

Confirm that the power breaker operates (ON) normally.

### 11-1-2. Confirmation of Power Voltage

Confirm that power voltage is AC 220–230–240 ± 10%. If power voltage is not in this range, the unit may not operate normally.

### 11-1-3. Operation Which is not a Trouble (Program Operation)

For controlling the air conditioner, the program operations are built in the microcomputer as described in the following table. If a claim is made for running operation, check whether or not it meets to the contents in the following table. When it does, we inform you that it is not trouble of equipment, but it is indispensable for controlling and maintaining of air conditioner.

Table 11-1-1

No.	Operation of air conditioner	Description
1	When power breaker is turned "ON", the OPERATION indicator (Green) of the indoor unit flashes.	The OPERATION indicator of the indoor unit flashes when power source is turned on. If [START/STOP] button is operated once, flashing stops. (Flashes also in power failure)
2	Compressor may not operate even if the room temperature is within range of compressor-ON.	The compressor does not operate while compressor restart delay timer (3-minutes timer) operates. The same phenomenon is found after power source has been turned on because 3-minutes timer operates.
3	In Dry and ECO mode, FAN (air flow) display does not change even though FAN (air flow select) button is operated.	The air flow indication is fixed to [AUTO].
4	Increasing of compressor motor speed stops approx. 30 seconds after operation started, and then compressor motor speed increases again approx. 30 seconds after.	For smooth operation of the compressor, the compressor motor speed is restricted to Max. 41 rps for 2 minutes, and Max.91 rps for 2 minutes to 3 minutes, respectively after the operation has started.
5	The set value of the remote control should be below the room temperature.	If the set value is above the room temperature, Cooling operation is not performed. And check whether battery of the remote control is consumed or not.
6	In AUTO mode, the operation mode is changed.	After selecting Cool or Heat mode, select an operation mode again if the compressor keeps stop status for 15 minutes.
7	In HEAT mode, the compressor motor speed does not increase up to the maximum speed or decreases before the temperature arrives at the set temperature.	The compressor motor speed may decrease by high-temp. release control (Release protective operation by temp.-up of the indoor heat exchanger) or current release control.
8	Cool, Dry, or Heat operation cannot be performed.	When the unit in other room operates previously in different mode, Fan Only operation is performed because of first-push priority control. (Cool operation and Dry operation can be concurrently performed.)



## 11-2. Primary Judgment

To diagnose the troubles, use the following methods.

- (1) Judgment by flashing LED of indoor unit
- (2) Self-diagnosis by service check remote controller
- (3) Judgment of trouble by every symptom

Firstly use the method (1) for diagnosis. Then, use the method (2) or (3) to diagnose the details of troubles.

For any trouble occurred at the outdoor unit side, detailed diagnosis is possible by 5-serial LED on the inverter P.C. board.

## 11-3. Judgment by Flashing LED of Indoor Unit

While the indoor unit monitors the operation status of the air conditioner, if the protective circuit operates, the contents of self-diagnosis are displayed with block on the indoor unit indication section.

**Table 11-3-1**

	Item	Check code	Block display	Description for self-diagnosis
<div style="border: 1px solid black; padding: 5px; width: fit-content;">Indoor indication lamp flashes.</div> <div style="margin: 5px 0;">↓</div> <div style="border: 1px solid black; padding: 5px; width: fit-content;">Which lamp does flash?</div> <div style="margin: 5px 0;">↓</div> <div style="border: 1px solid black; padding: 5px; width: fit-content;">→</div>	A	—	OPERATION (Green) Flashing display (1 Hz)	Power failure (when power is ON)
	B	00	OPERATION (Green) Flashing display (5 Hz)	Protective circuit operation for indoor P.C. board
	C	01	OPERATION (Green) TIMER (Yellow) Flashing display (5 Hz)	Protective circuit operation for connecting cable and serial signal system
	D	02	OPERATION (Green) FILTER (Orange) Flashing display (5 Hz)	Protective circuit operation for outdoor P.C. board
	E	03	OPERATION (Green) TIMER (Yellow) FILTER (Orange) Flashing display (5 Hz)	Protective circuit operation for others (including compressor)

### NOTES :

- (1) The contents of items B and C and a part of item E are displayed when air conditioner operates.
- (2) When item B and C, and item B and a part of item E occur concurrently, priority is given to the block of item B.
- (3) The check codes can be confirmed on the remote controller for servicing.

## 11-4. Self-Diagnosis by Remote Controller (Check Code)

- (1) If the indicators light as shown B to E in Table 11-3-1, excute the self-diagnosis by the remote controller.
- (2) When the remote controller is set to the service mode, the indoor controller diagnoses the operation condition and indicate the information of the self-diagnosis on the display of the remote controller with the check codes. If a fault is detected, all indicators on the indoor unit will flash at 5Hz and it will beep for 10 seconds (Pi, Pi, Pi ...). The TIMER indicator usually flashes (5Hz) during self-diagnosis.

### 11-4-1. How to Use Remote Controller in Service Mode

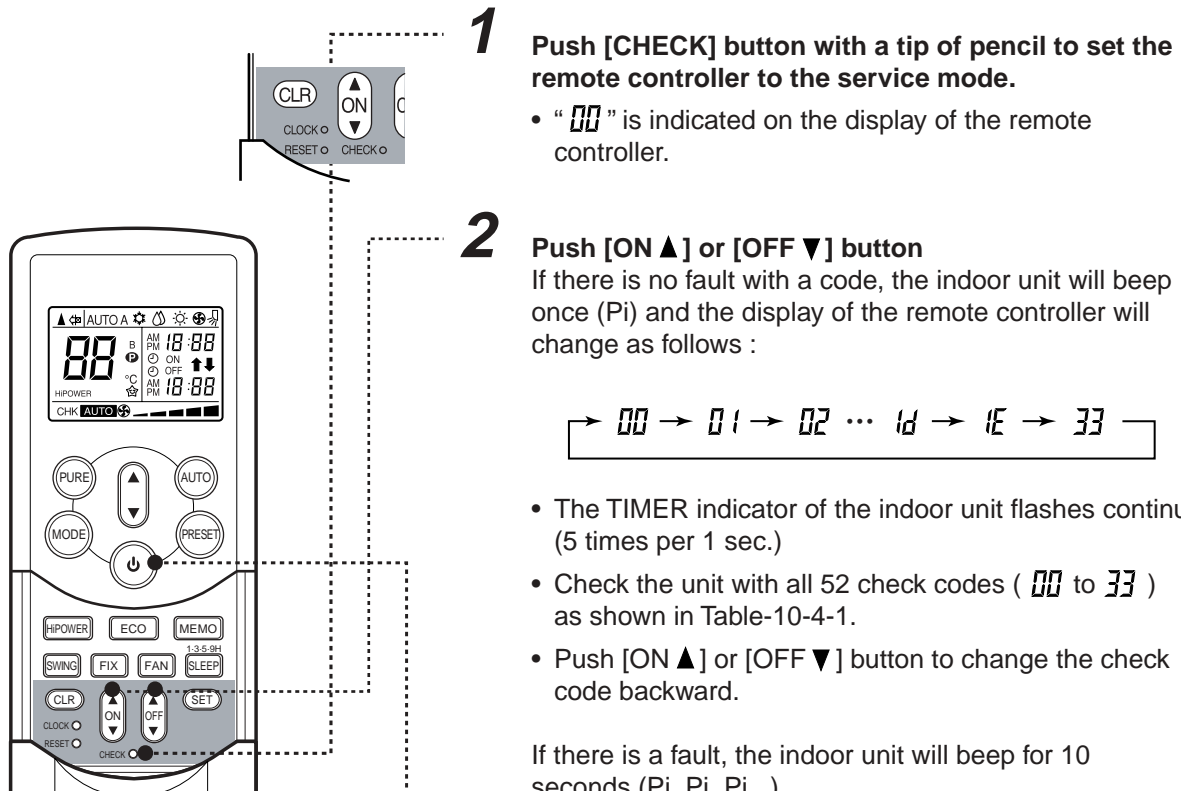

**1** Push [CHECK] button with a tip of pencil to set the remote controller to the service mode.

- “00” is indicated on the display of the remote controller.

**2** Push [ON ▲] or [OFF ▼] button  
If there is no fault with a code, the indoor unit will beep once (Pi) and the display of the remote controller will change as follows :

→ 00 → 01 → 02 ... 1d → 1E → 33

- The TIMER indicator of the indoor unit flashes continuously. (5 times per 1 sec.)
- Check the unit with all 52 check codes ( 00 to 33 ) as shown in Table-10-4-1.
- Push [ON ▲] or [OFF ▼] button to change the check code backward.

If there is a fault, the indoor unit will beep for 10 seconds (Pi, Pi, Pi...).

Note the check code on the display of the remote controller.

- 2-digits alphanumeric will be indicated on the display.
- All indicators on the indoor unit will flash. (5 times per 1 sec.)

**3** Push [START/STOP] button to release the service mode.

- The display of the remote controller returns to as it was before service mode was engaged.

**4** Time shortening method.

1. Push SET button while pushing CHECK button.
2. Push [START/STOP] button.

Alphanumeric characters are used for the check codes.

5 is 5.	6 is 6.
A is A.	B is B.
C is C.	D is D.

Fig. 11-4-1

## 11-4-2. Caution at Servicing

- (1) After servicing, push the START/STOP button to return to the normal mode.
- (2) After servicing by the check code, turn off breaker of the power supply, and turn on breaker of the power supply again so that memory in the microcomputer returns the initial status. However, the check codes are not deleted even if the power supply is turned off because they are stored in the fixed memory.
- (3) After servicing, push [CLR] button under check mode status and then send the check code "7F" to the indoor unit. The error code stored in memory is cleared.

Table 11-4-1

Block distinction		Operation of diagnosis function				Judgment and action
Check code	Block	Check code	Cause of operation	Air conditioner status	Remarks	
00	Indoor P.C. board etc.	01	Short-circuit or disconnection of the room temperature sensor (TA sensor).	Operation continues.	Displayed when error is detected.	1. Check the room temp. sensor. 2. When the room temp. sensor is normal, check P.C. board.
		02	Being out of place, disconnection, short-circuit, or migration of heat exchanger sensor (TC sensor)	Operation continues.	Displayed when error is detected.	1. Check heat exchanger sensor. 2. When heat exchanger sensor is normal, check P.C. board.
		11	Lock of indoor fan or trouble on the indoor fan circuit	All off	Displayed when error is detected.	1. Check the motor. 2. When the motor is normal, check P.C. board.
	Not displayed	12	Trouble on other indoor P.C. boards	Operation continues.	Displayed when error is detected.	Replace P.C. board.
01	Connecting cable and serial signal	04	Return serial signal is not sent to indoor side from operation started. (1) Defective wiring of connecting cable (2) Operation of compressor thermo. Gas shortage Gas leak	Operation continues.	Flashes when trouble is detected on Return serial signal, and normal status when signal is reset.	1. When the outdoor unit never operate: (1) Check connecting cable, and correct if defective wiring. (2) Check 25A fuse of inverter P.C. board. (3) Check 3.15A of inverter P.C. board. 2. To display [Other] block during operation, check compressor thermo. operation and supply gas (check gas leak also). 3. Unit operates normally during check. If Return serial signal does not stop between indoor terminal board 2 and 3, replace inverter P.C. board. If signal stops between indoor terminal board 2 and 3, replace indoor P.C. board.
02	Outdoor P.C. board	14	Inverter over-current protective circuit operates. (Short time)	All off	Displayed when error is detected.	Even if trying operation again, all operations stop immediately. : Replace P.C. board.
		15	Position-detect circuit error or short-circuit between windings of compressor	All off	Displayed when error is detected.	1. Even if connecting lead wire of compressor is removed, position-detect circuit error occurred. : Replace P.C. board. 2. Measure resistance between wires of compressor, and perform short-circuit. : Replace compressor.

Block distinction		Operation of diagnosis function				Judgment and action
Check code	Block	Check code	Cause of operation	Air conditioner status	Remarks	
02	Outdoor P.C. board	17	Current-detect circuit error	All off	Displayed when error is detected.	Even if trying operation again, all operations stop immediately. : Replace P.C. board.
		18	Being out of place, disconnection or short-circuit of outdoor temp. sensor (Ts)	All off	Displayed when error is detected.	Check 5-serial LED. 1. Check outdoor temp. sensors (TE, TS). 2. Check P.C. board.
		19	Disconnection or short-circuit of discharge temp. sensor	All off	Displayed when error is detected.	1. Check discharge temp. sensor (TD). 2. Check P.C. board
		1A	Outdoor fan drive system error	All off	Displayed when error is detected.	Position-detect error, over-current protective operation of outdoor fan drive system, fan lock, etc. : Replace P.C. board or fan motor.
	Not displayed	1b	Outdoor temp. sensor error	Operation continues	—	1. Check outdoor temp. sensor (TO). 2. Check P.C. board.
	Outdoor P.C. board	1c	Compressor drive output error, Compressor error (lock, missing, etc.), Break down	All off	Displayed when error is detected.	Check 5-serial LED. When 20 seconds passed after start-up, position-detect circuit error occurred. : Replace compressor.
Error exclusive for multiple type			All off	Displayed when error is detected.	Check 5-serial LED. 1. Miswiring of connecting wire of A/B rooms in indoor/outdoor units 2. Check gas leakage. 3. Check disconnection of sensor. 4. Electronic control valve error	
03	Others (including compressor)	07	Return serial signal has been sent when operation started, but it is not sent from halfway. (1) Compressor thermo. operation Gas shortage Gas leak (2) Instantaneous power failure	Operation continues	Flashes when trouble is detected on return serial signal, and normal status when signal is reset.	1. Repeat Start and Stop with interval of approx. 10 to 40 minutes. (Code is not displayed during operation.) Supply gas. (Check also gas leak). 2. Unit operates normally during check. If return serial signal does not stop between indoor terminal block 2 and 3, replace inverter P.C. board. If signal stops between indoor terminal block 2 and 3, replace indoor P.C. board.
		1d	Compressor does not rotate. (Current protective circuit does not operate when a specified time passed after compressor had been activated.)	All off	Displayed when error is detected.	1. Trouble on compressor 2. Trouble on wiring of compressor (Missed phase)
		1E	Discharge temp. exceeded 117°C	All off	Displayed when error is detected.	1. Check discharge temp. sensor (TD). 2. Gas leakage 3. Trouble on P.M.V.
		1F	Break down of compressor	All off	Displayed when error is detected.	1. Check power voltage. (220–230–240 V +10%) 2. Overload operation of refrigeration cycle Check installation condition (Short-circuit of outdoor diffuser).

## 11-5. Judgment of Trouble by Every Symptom

### 11-5-1. Indoor Unit (Including Remote Controller)

#### (1) Power is not turned on (Does not operate entirely)

##### <Primary check>

1. Is the supply voltage normal?
2. Is the normal voltage provided to the outdoor unit?
3. Is the crossover cable connected properly?
4. Is the fuse (F01) blown?

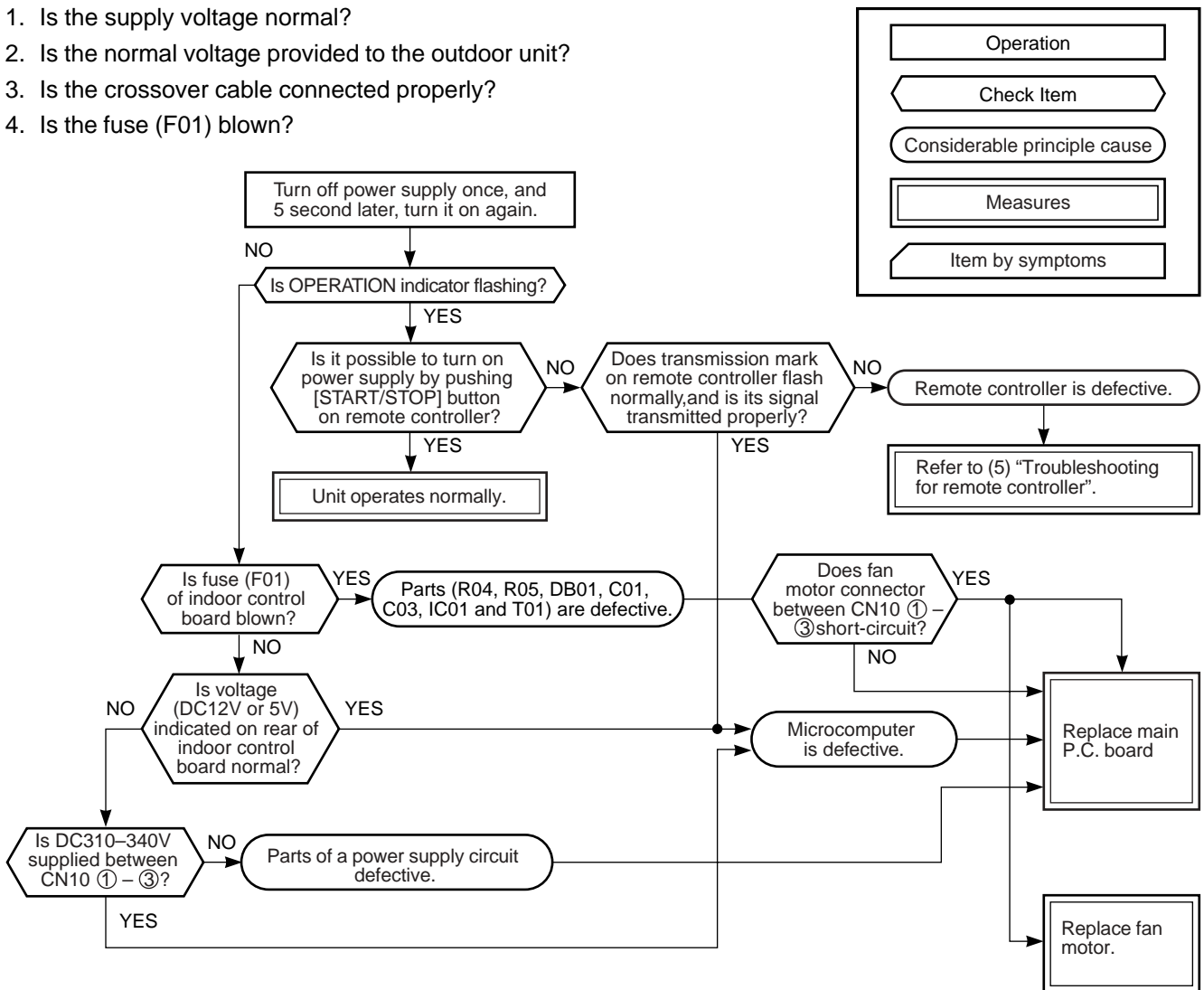

- Be sure to disconnect the motor connector CN10 after shut off the power supply, or it will be a cause of damage of the motor.

#### (2) Power is not turned on though Indoor P.C. board is replaced

##### <Confirmation procedure>

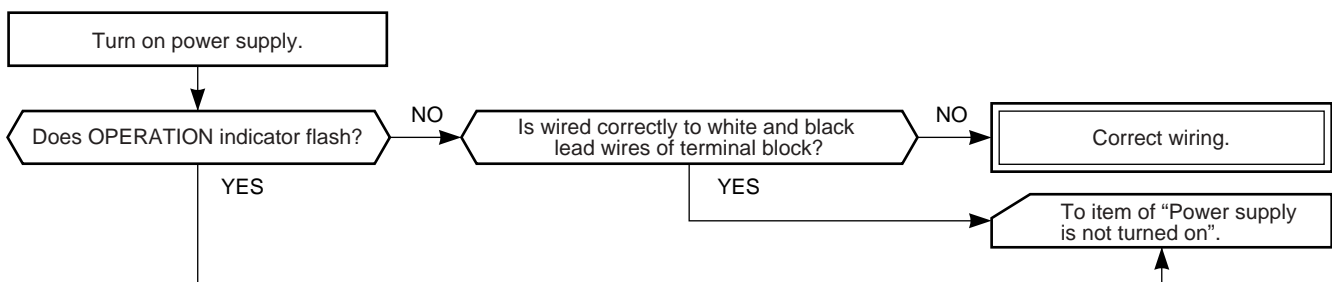

### (3) Only the indoor motor fan does not operate

#### <Primary check>

1. Is it possible to detect the power supply voltage (AC220–240V) between ① and ② on the terminal block?
2. Does the indoor fan motor operate in cooling operation?  
(In heating operation, the indoor fan motor does not operate for approximately 10 minutes after it is turned on, to prevent a cold air from blowing in.)

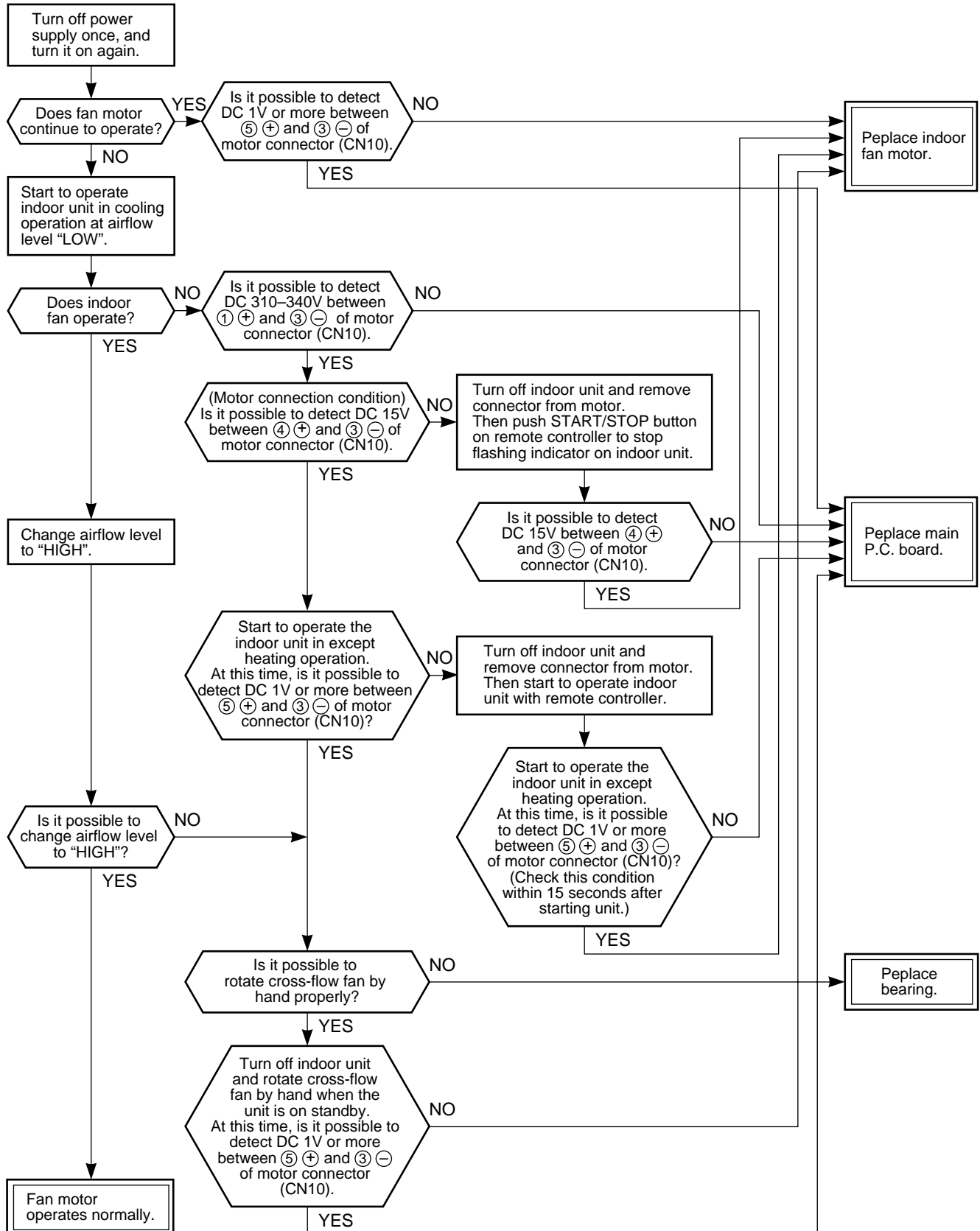

#### (4) Indoor fan motor automatically starts to rotate by turning on power supply

##### <Cause>

The IC is built in the indoor fan motor. Therefore the P.C. board is also mounted to inside of the motor.

If the P.C. board is soldered imperfectly or the IC is defective, the fan motor may automatically rotate by turning on power supply.

##### <Inspection procedure>

1. Remove the front panel. (Remove 2 screws.)
2. Remove the cover of the fan motor lead wires.
3. Check DC voltage with CN10 connector while the fan motor is rotating.

##### NOTE :

- Do not disconnect the connector while the fan motor is rotating.
- Use a thin test rod.

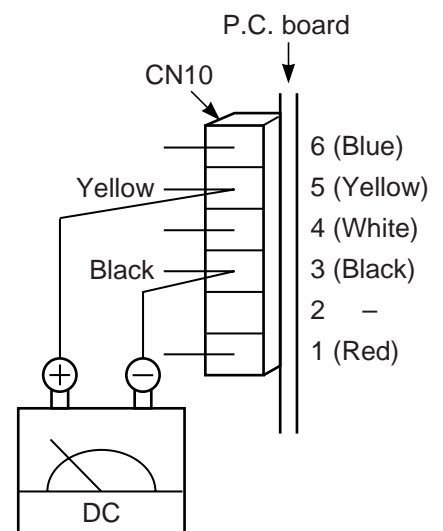
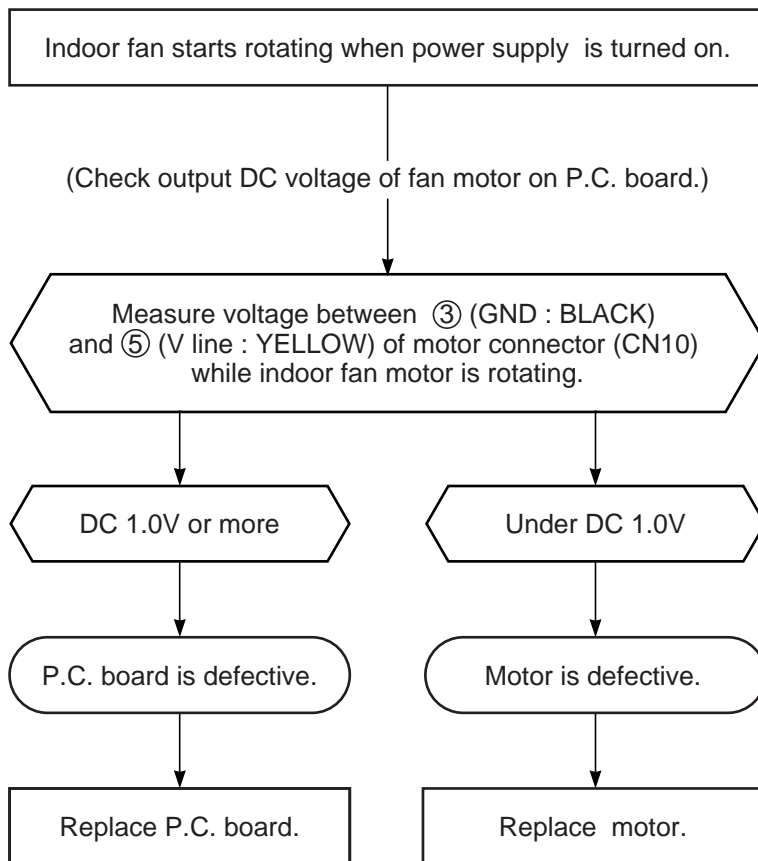

**(5) Troubleshooting for remote controller**

**<Primary check>**

Check that A or B selected on the main unit is matched with A or B selected on the remote controller.

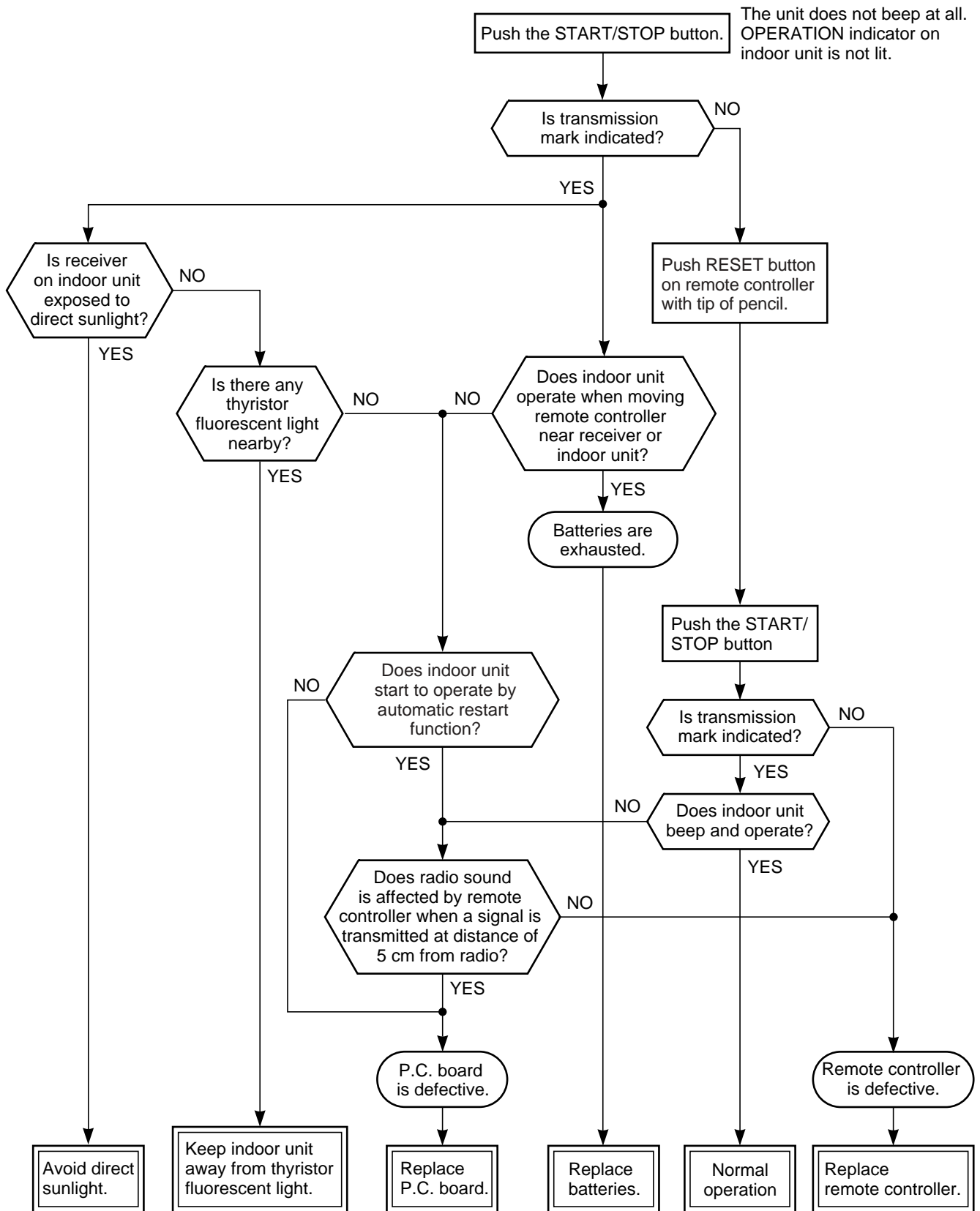

**NOTE :** After replacing batteries, push the RESET button with a tip of a pencil.



## 11-5-2. Wiring Failure (Interconnecting and Serial Signal Wire)

### (1) Outdoor unit does not operate

1) Is the voltage between ② and ③ of the indoor terminal block varied?

Confirm that transmission from indoor unit to outdoor unit is correctly performed based upon the following diagram.

#### NOTE:

- Measurement should be performed 2 minutes and 30 seconds after starting of the operation.
- Be sure to prepare a diode for judgment.

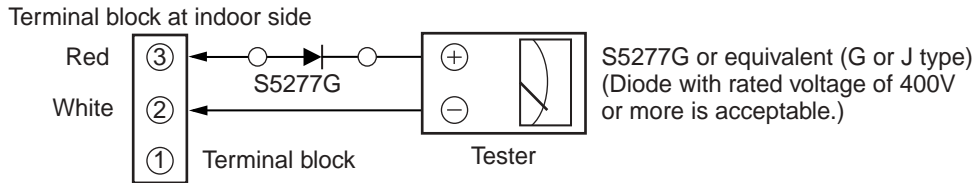

Normal time : Voltage swings between DC15 and 60V. ....Inverter Assembly check (11-8-1)

Abnormal time : Voltage does not vary.

### (2) Outdoor unit stops in a little while after operation started

#### <Check procedure> Select phenomena described below.

(1) The outdoor unit stops 10 to 20 minutes after operation started, and 10 minutes or more are required to restart the unit.

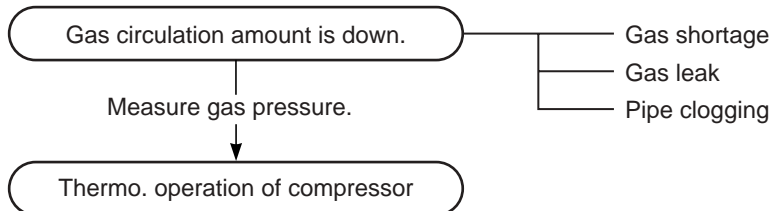

(2) If the unit stops once, it does not operate until the power will be turned on again.

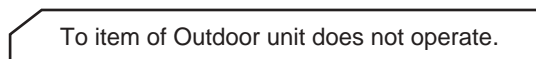

(3) The outdoor unit stops 10 minutes to 1 hour after operation started, and an alarm is displayed. (Discharge temp. error check code 03, 1E Sensor temp. error check code 02, 1C)

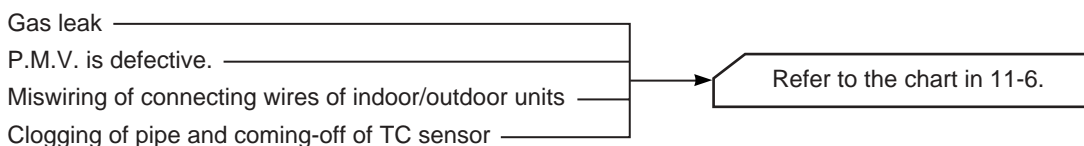

## 11-6. Check Code 1C (Miswiring in indoor/outdoor units) and 1E

<Check procedure>

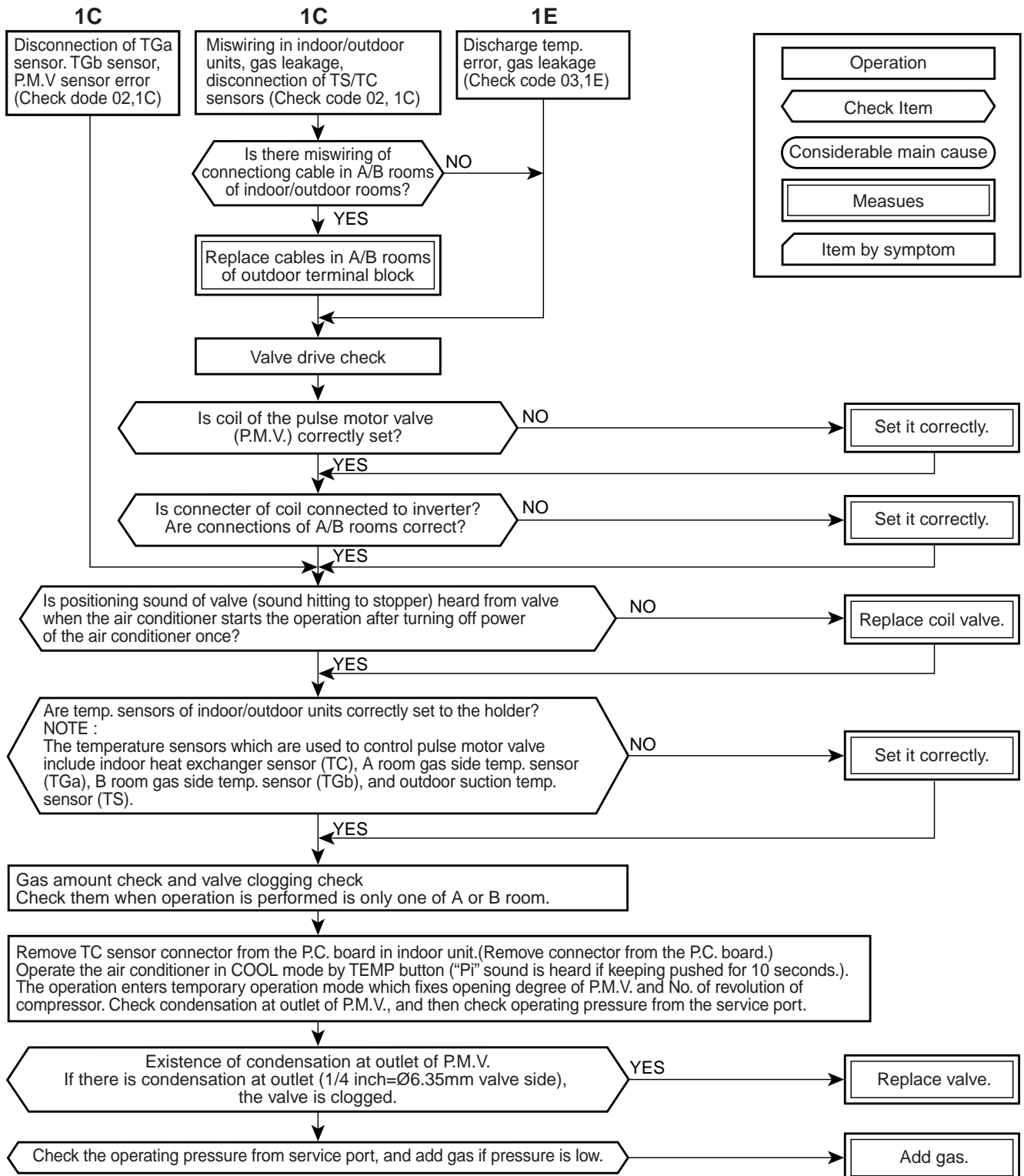

## 11-7. Trouble Diagnosis by Outdoor LED

For the outdoor unit, the self-diagnosis is possible by five LEDs (Red).

- LEDs (Red) (D11 to D15) are provided on the sub-control board under surface of the inverter, and as shown below, they are checked from the wiring port when removing the wiring cover.
- If a trouble occurs, LED (Red) goes on according to the trouble as described in the table below.
  - When two or more troubles occur, LEDs go on cyclically.
  - Usually, LEDs (Red) go off.

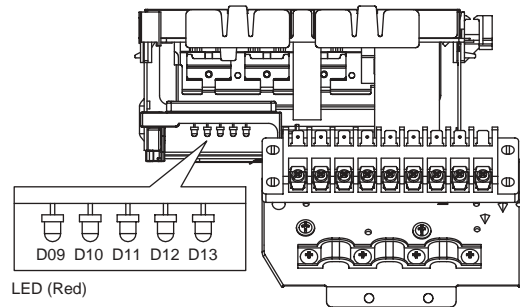

Contents	Indoor alarm code	LED indication				
		D09	D10	D11	D12	D13
Normal running	None	●	●	●	●	●
IGBT short circuit, Compressor motor rear short	14	●	○	●	●	●
Trouble on position detecting circuit	16	○	○	●	●	●
Trouble on current detecting circuit	17	●	●	○	●	●
CONDENSOR PIPE TEMP. SENSOR(TE) fault	18	○	●	○	○	●
SUCTION PIPE TEMP. SENSOR(TS) fault	18	●	●	○	○	●
DISCHARGE PIPE TEMP. SENSOR(TD) fault	19	●	○	○	●	●
Trouble on outdoor fan	1A	○	○	○	●	●
OUTDOOR TEMP. SENSOR(TO) fault	1B	●	●	●	○	●
Trouble on compressor system	1C	○	●	○	●	●
GAS SIDE PIPE TEMP. SENSOR a (TGa) fault	1C	○	○	○	○	●
GAS SIDE PIPE TEMP. SENSOR b (TGb) fault	1C	○	●	●	●	○
TGa, TGb sensor out of place, PMV fault	1C	○	○	○	●	○
Communication trouble between MCU	1C	○	○	●	○	○
Compressor lock	1D	○	●	●	○	●
Trouble on discharge temp. Gas leakage	1E	●	○	●	○	●
Compressor break down	1F	○	○	●	○	●

○ : LED ON, ● : LED OFF

# 11-7. Troubleshooting

## 11-7-1. How to Check Whether the Air Purifier is Good or Not

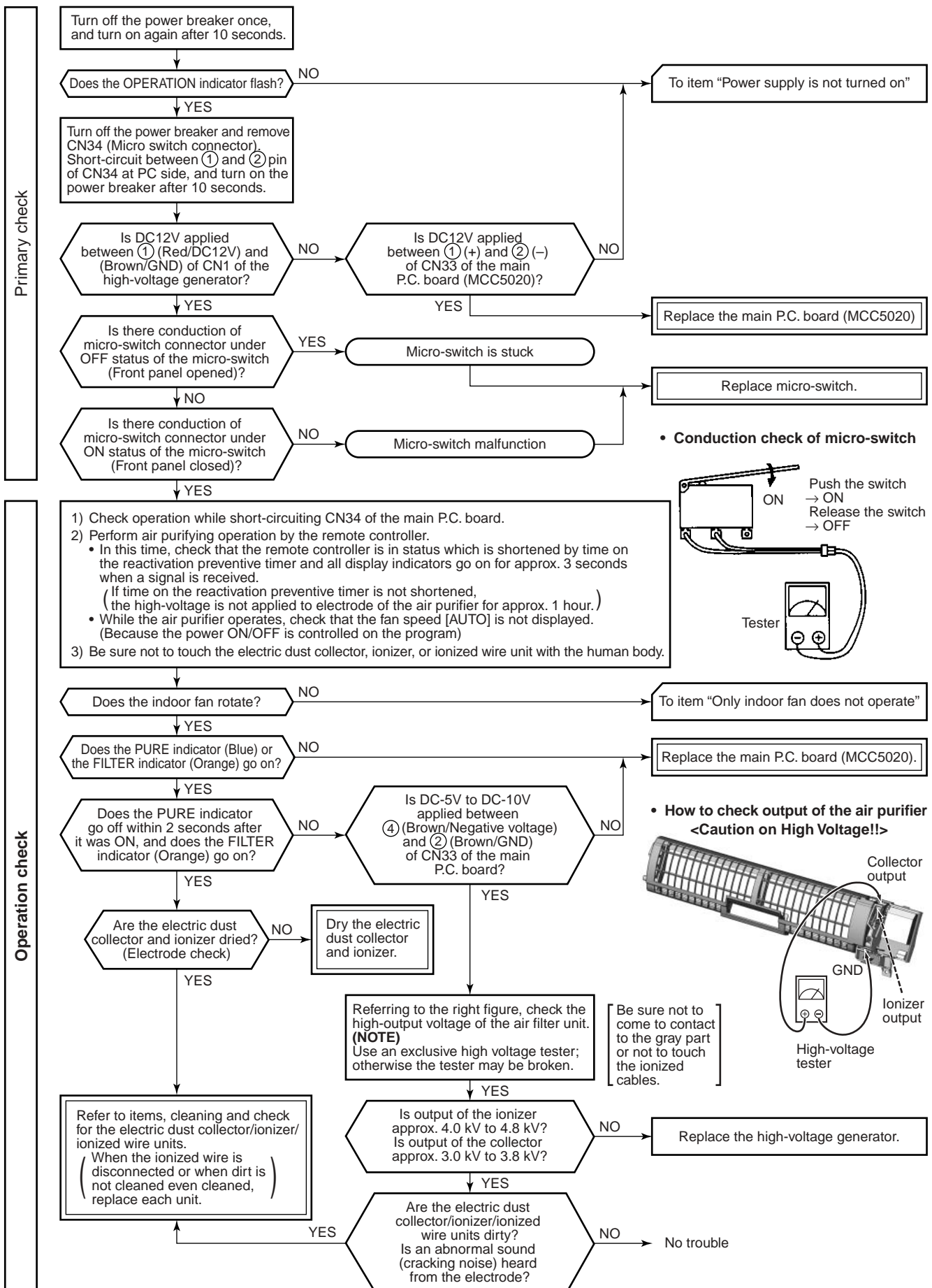

## 11-7-2. How to Check Whether the Minus Ion Generator is Good or Not

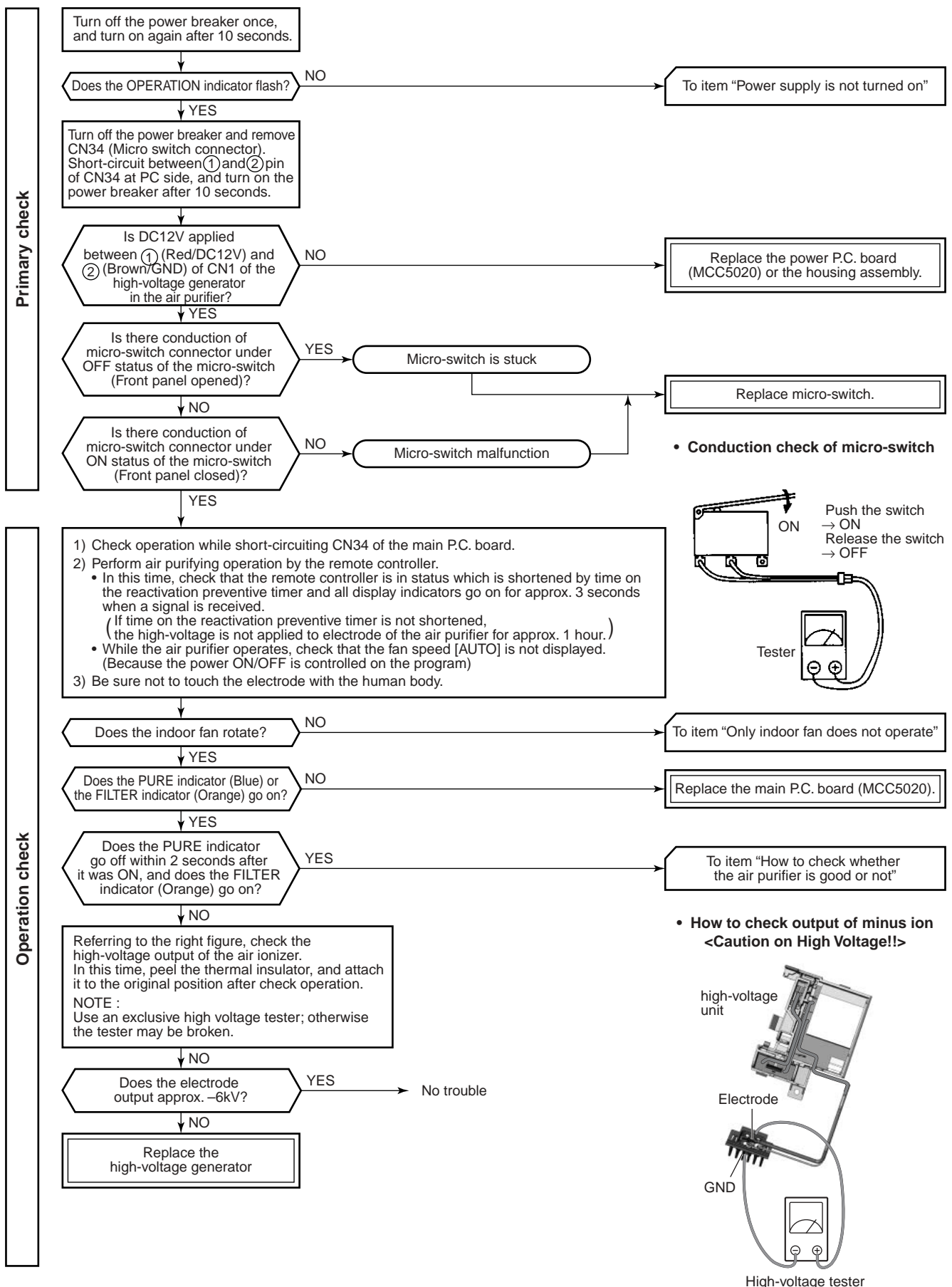

## 11-8. How to Diagnose Trouble in Outdoor Unit

### 11-8-1. Summarized Inner Diagnosis of Inverter Assembly

Table 11-8-1

Diagnosis/Process flowchart	Item	Contents	Summary
<pre> graph TD     Start[Remove connector of compressor.] --&gt; F01{Check 25A fuse (Part No.F01).}     F01 -- NG --&gt; Replace[Replace fuse.]     Replace --&gt; DB01_1{{Check electrolytic capacitor, diode block (DB01), etc.}}     DB01_1 -.-&gt; F01     F01 -- OK --&gt; Voltage{Check terminal voltage of electrolytic capacitor.}     Voltage -- NG --&gt; DB01_2{{Check electrolytic capacitor, diode (DB01), etc.}}     DB01_2 -.-&gt; Voltage     Voltage -- OK --&gt; Fan{Does outdoor fan rotate?}     Fan -- YES --&gt; A((A))     Fan -- NO --&gt; CN300{{Remove connector CN300 of outdoor fan motor, and using a tester, check resistance value between every phases at motor side.}}     CN300 -- NG --&gt; ReplaceFan[Replace outdoor fan motor.]     ReplaceFan --&gt; A     CN300 -- OK --&gt; B((B))     </pre>	<p>Preparation</p> <p>Check</p> <p>Check</p> <p>Operation</p> <p>Measurement</p> <p>Check</p> <p>Stop</p> <p>Check Measurement</p>	<p>Turn "OFF" the power supply breaker, and remove 3P connector which connects inverter and compressor.</p> <ul style="list-style-type: none"> <li>Check whether 25A fuse on the control board assembly is blown or not. (F01)</li> </ul> <p>Replace fuse.</p> <p>Check electrolytic capacitor, diode block (DB01), etc.</p> <p>Check terminal voltage of electrolytic capacitor.</p> <p>Check electrolytic capacitor, diode (DB01), etc.</p> <p>Turn on the power breaker, and operate the air conditioner in COOL mode by time shortening.</p> <p>Measure terminal voltage of the electrolytic capacity.</p> <p><b>760μF:400WV x 3</b></p> <p>After operation, turn off the power breaker after 2 minutes 20 seconds passed, and discharge the electrolytic capacitor by soldering iron. Check voltage between motor phases.</p> <ul style="list-style-type: none"> <li>Is not winding between ①-②, ②-③, or ①-③ opened or short-circuited?</li> <li>Is not frame grounded with ①, ②, or ③?</li> </ul>	<p>If fuse was blown, be sure to check the electrolytic capacitor and diode block. (DB01)</p> <ul style="list-style-type: none"> <li>Connect discharge resistance (approx. 100Ω40W) or soldering iron (plug) between +, - terminals of the electrolytic capacitor (760μF) of C-14 (with printed CAUTION HIGH VOLTAGE) on P.C. board.</li> </ul> <p>Discharging position (Discharging period 10 seconds or more)</p> <p>OK if 760μF → DC280 to 380V</p> <p>Remove CN300 while pushing the part indicated by an arrow because CN300 is a connector with lock.</p> <p>→ Resistance between phases should be approx. 55 to 77Ω</p> <p>→ Should be 10MΩ or more.</p>

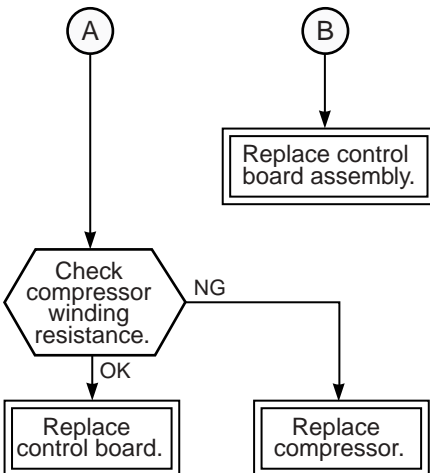
Diagnosis/Process flowchart	Item	Contents	Summary
 <pre> graph TD     A((A)) --&gt; D{Check compressor winding resistance.}     B((B)) --&gt; R1[Replace control board assembly.]     D -- OK --&gt; R2[Replace control board.]     D -- NG --&gt; R3[Replace compressor.] </pre>	<p>Check</p> <p>Operation</p>	<p>Check winding resistance between phases of compressor, and resistance between outdoor frames by using a tester.</p> <ul style="list-style-type: none"> <li>• Is not grounded.</li> <li>• Is not short-circuited between windings.</li> <li>• Winding is not opened.</li> </ul> <p>Remove connector CN300 of the outdoor fan motor, turn on the power supply breaker, and perform the operation. (Stops though activation is prompted.)</p> <p>Check operation within 2 minutes 20 seconds after activation stopped.</p>	<p>→ OK if 10MΩ or more</p> <p>} → OK if 0.51Ω → 0.57Ω (Check by a digital tester.)</p>

## 11-9. How to Check Simply the Main Parts

### 11-9-1. How to Check the P.C. Board (Indoor Unit)

#### (1) Operating precautions

- 1) When removing the front panel or the P.C. board, be sure to shut off the power supply breaker.
- 2) When removing the P.C. board, hold the edge of the P.C. board and do not apply force to the parts.
- 3) When connecting or disconnecting the connectors on the P.C. board, hold the whole housing. Do not pull at the lead wire.

#### (2) Inspection procedures

- 1) When a P.C. board is judged to be defective, check for disconnection, burning, or discoloration of the copper foil pattern on this P.C. board.
- 2) The P.C. board consists of the following 2 parts
  - a. **Main P.C. board part :**  
DC power supply circuit (5V, 12V, 15V), Indoor fan motor control circuit, CPU and peripheral circuits, buzzer, and Driving circuit of louver.
  - b. **Indication unit of infrared ray receiving Infrared ray receiving circuit, LED :**  
To check defect of the P.C. board, follow the procedure described below.

### (3) Check procedures

Table 11-9-1

No.	Procedure	Check points	Causes
1	Turn off the power supply breaker and remove the P.C. board assembly from electronic parts base. Remove the connecting cables from the terminal block.	Check whether or not the fuse (F01) is blown.	Impulse voltage was applied or the indoor fan motor short-circuited.
2	Remove the connector of the motor and turn on the power supply breaker. If OPERATION indicator flashes (once per second), it is not necessary to check steps (1 to 3) in the right next column.	Check power supply voltage : 1. Between No. 1 and No. 3 of CN23 (AC 220–240V) 2. Between ⊕ and ⊖ of C03 (DC 310–340V) 3. Between ⊖ of C10 and output side of IC08 (DC 15V) 4. Between 12V and GND 5. Between 5V and GND	1. The terminal block or the crossover cable is connected wrongly. 2. The capacitor (C01), line filter (L01), resistor (R05), or the diode (DB01) is defective. 3. IC01, IC08 and T01 are defective. 4. IC01, IC08 and T01 are defective. 5. IC01, IC08, IC07 and T01 are defective.
3	Push [START/STOP] button once to start the unit. (Do not set the mode to On-Timer operation.)	Check power supply voltage : 1. Between CN21 and No. 1 of CN23 (DC 15–60V)	IC03 and IC04 are defective.
4	Shorten the restart delay timer and start unit.	Check whether or not all indicators (OPERATION, TIMER, FILTER, Plasma) are lit for 3 seconds and they return to normal 3 seconds later.	The indicators are defective or the housing assembly (CN13) is defective.
5	Push [START/STOP] button once to start the unit, • Shorten the restart delay timer. • Set the operation mode to COOL. • Set the fan speed level to AUTO. • Set the preset temperature much lower than the room temperature. (The unit (compressor) operates continuously in the above condition.)	1. Check whether or not the compressor operates. 2. Check whether or not the OPERATION indicator flashes.	1. The temperature of the indoor heat exchanger is extremely low. 2. The connection of the heat exchanger sensor is loose. (The connector is disconnected.) (CN01) 3. The heat exchanger sensor and the P.C. board are defective. (Refer to Table 11-4-1.) 4. The main P.C. board is defective.
6	If the above condition (No. 5) still continues, start the unit in the following condition. • Set the operation mode to HEAT. • Set the preset temperature much higher than room temperature.	1. Check whether or not the compressor operates. 2. Check whether or not the OPERATION indicator flashes.	1. The temperature of the indoor heat exchanger is extremely high. 2. The connection of the heat exchanger sensor short-circuited. (CN01) 3. The heat exchanger sensor and the P.C. board are defective. (Refer to Table 11-4-1.) 4. The main P.C. board is defective
7	Connect the motor connector to the motor and turn on the power supply. Start the unit the following condition. • Set the fan speed level to HIGH. (The unit (compressor) operates continuously in the above condition in No. 5.)	1. Check it is impossible to detect the voltage (DC 15V) between 3 and 4 of the motor terminals. 2. The motor does not operate or the fan motor does not rotate with high speed. (But it is possible to receive the signal from the remote controller.) 3. The motor rotates but vibrates strongly.	1. The indoor fan motor is defective. (Protected operation of P.C. board.) 2. The P.C. board is defective. 3. The connection of the motor connector is loose.



## 11-9-2. P.C. Board Layout

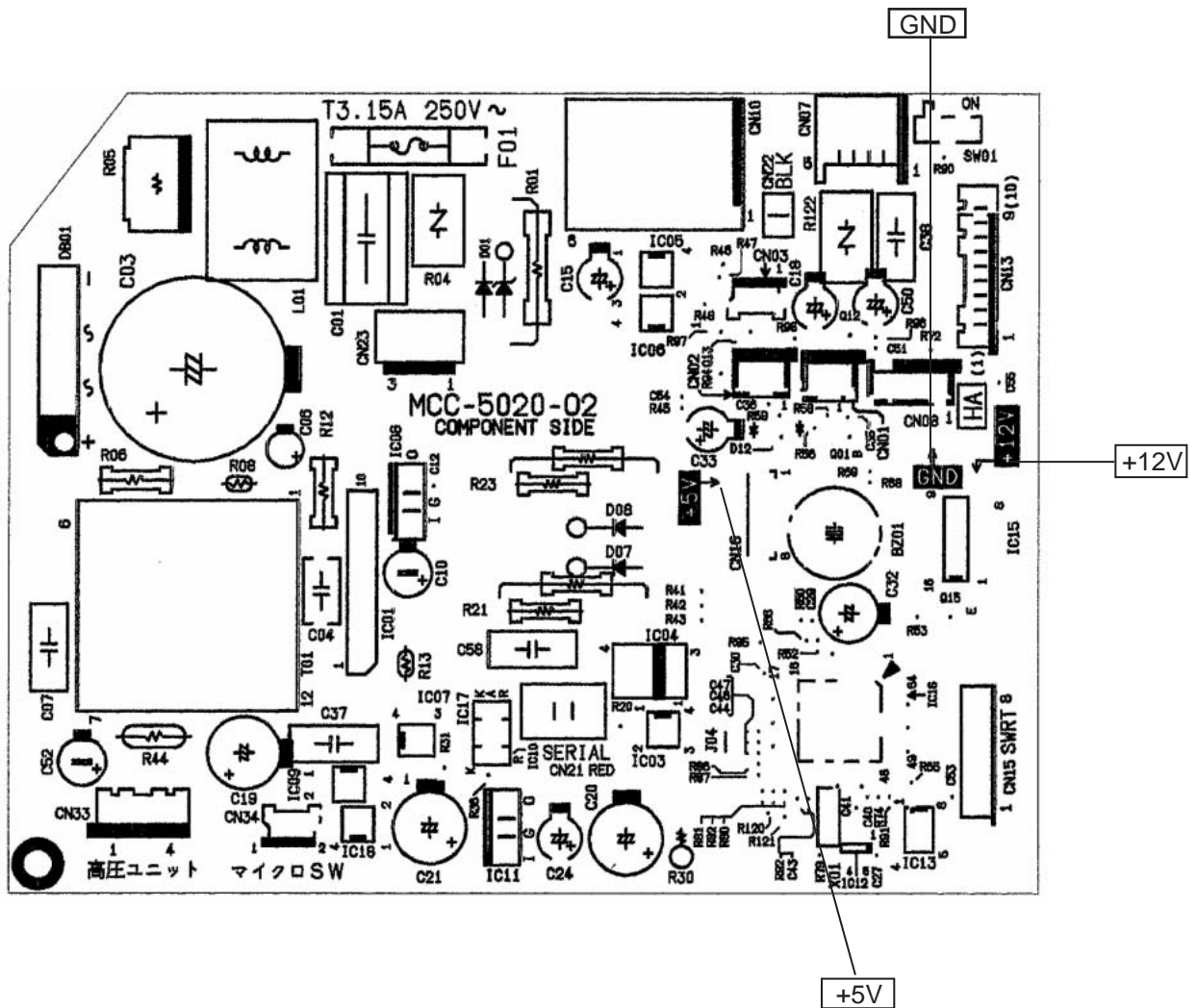

[1] Sensor characteristic table

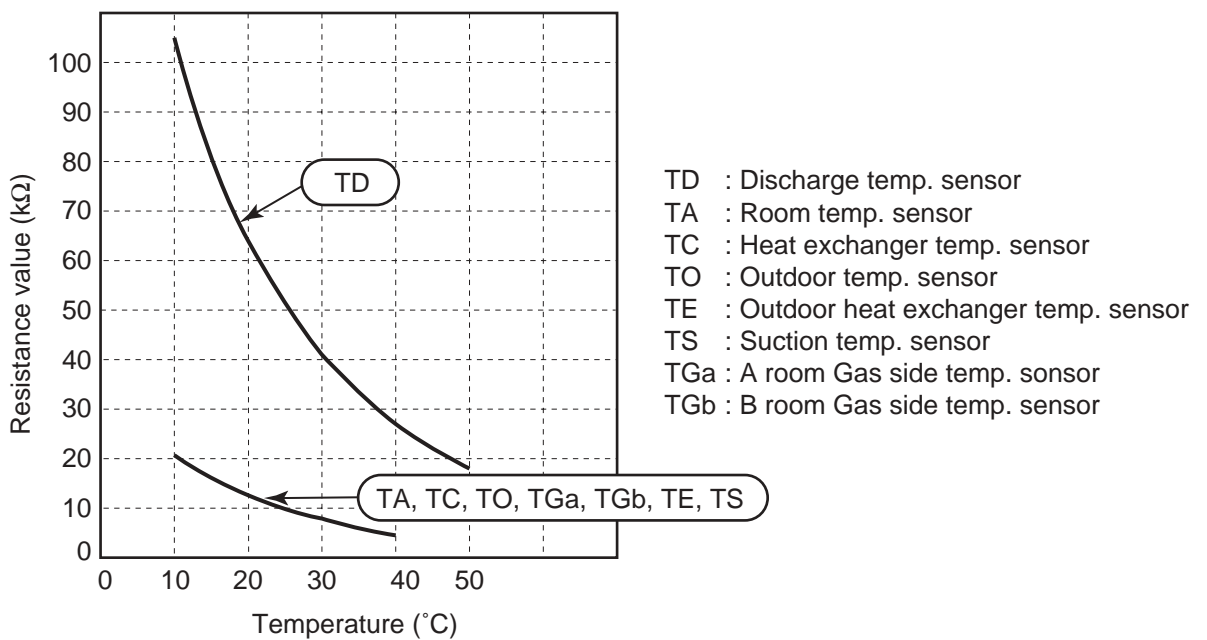

### 11-9-3. Indoor Unit (Other Parts)

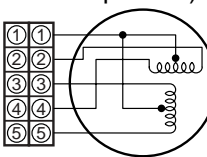
No.	Part name	Checking procedure																		
1	Room temp. (TA) sensor Heat exchanger (TC) sensor	Disconnect the connector and measure the resistance value with tester. (Normal temp.) <table border="1" style="margin-top: 10px;"> <thead> <tr> <th style="text-align: center;">Temperature</th> <th>10°C</th> <th>20°C</th> <th>25°C</th> <th>30°C</th> <th>40°C</th> </tr> </thead> <tbody> <tr> <td style="text-align: center;">Sensor</td> <td></td> <td></td> <td></td> <td></td> <td></td> </tr> <tr> <td style="text-align: center;">TA, TC (kΩ)</td> <td>20.7</td> <td>12.6</td> <td>10.0</td> <td>7.9</td> <td>4.5</td> </tr> </tbody> </table>	Temperature	10°C	20°C	25°C	30°C	40°C	Sensor						TA, TC (kΩ)	20.7	12.6	10.0	7.9	4.5
Temperature	10°C	20°C	25°C	30°C	40°C															
Sensor																				
TA, TC (kΩ)	20.7	12.6	10.0	7.9	4.5															
2	Remote controller	Refer to 11-5-1. (5).																		
3	Louver motor MP24GA	Measure the resistance value of each winding coil by using the tester. (Under normal temp. 25°C) <div style="display: flex; align-items: center; margin-top: 10px;"> <div style="margin-right: 20px;">             White ①①              Yellow ②②              Yellow ③③              Yellow ④④              Yellow ⑤⑤           </div>  <table border="1" style="margin-left: 20px;"> <thead> <tr> <th>Position</th> <th>Resistance value</th> </tr> </thead> <tbody> <tr> <td>1 to 2</td> <td rowspan="5" style="text-align: center; vertical-align: middle;">380 ± 40 Ω</td> </tr> <tr> <td>1 to 3</td> </tr> <tr> <td>1 to 4</td> </tr> <tr> <td>1 to 5</td> </tr> <tr> <td>1 to 5</td> </tr> </tbody> </table> </div>	Position	Resistance value	1 to 2	380 ± 40 Ω	1 to 3	1 to 4	1 to 5	1 to 5										
Position	Resistance value																			
1 to 2	380 ± 40 Ω																			
1 to 3																				
1 to 4																				
1 to 5																				
1 to 5																				
4	Indoor fan motor	Refer to 11-5-1. (3) and (4).																		

### 11-9-4. Outdoor Unit

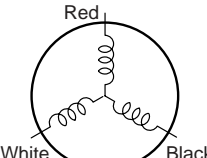
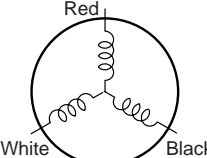
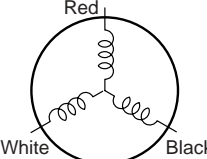
No.	Part name	Checking procedure								
1	Compressor (Model : DA111A1F-20F)	Measure the resistance value of each winding by using the tester. <div style="display: flex; align-items: center; margin-top: 10px;">  <table border="1" style="margin-left: 20px;"> <thead> <tr> <th>Position</th> <th>Resistance value</th> </tr> </thead> <tbody> <tr> <td>Red - White</td> <td>0.88 to 0.98Ω</td> </tr> <tr> <td>White - Black</td> <td>0.88 to 0.98Ω</td> </tr> <tr> <td>Black - Red</td> <td>0.88 to 0.98Ω</td> </tr> </tbody> </table> </div> <p style="text-align: right; margin-top: 10px;">Under 20°C</p>	Position	Resistance value	Red - White	0.88 to 0.98Ω	White - Black	0.88 to 0.98Ω	Black - Red	0.88 to 0.98Ω
Position	Resistance value									
Red - White	0.88 to 0.98Ω									
White - Black	0.88 to 0.98Ω									
Black - Red	0.88 to 0.98Ω									
2	Compressor (Model : DA130A1F-25F)	Measure the resistance value of each winding by using the tester. <div style="display: flex; align-items: center; margin-top: 10px;">  <table border="1" style="margin-left: 20px;"> <thead> <tr> <th>Position</th> <th>Resistance value</th> </tr> </thead> <tbody> <tr> <td>Red - White</td> <td rowspan="3" style="text-align: center; vertical-align: middle;">0.69 to 0.77Ω</td> </tr> <tr> <td>White - Black</td> </tr> <tr> <td>Black - Red</td> </tr> </tbody> </table> </div> <p style="text-align: right; margin-top: 10px;">Under 20°C</p>	Position	Resistance value	Red - White	0.69 to 0.77Ω	White - Black	Black - Red		
Position	Resistance value									
Red - White	0.69 to 0.77Ω									
White - Black										
Black - Red										
3	Outdoor fan motor (Model : ICF-140-43-4)	Measure the resistance value of each winding by using the tester. <div style="display: flex; align-items: center; margin-top: 10px;">  <table border="1" style="margin-left: 20px;"> <thead> <tr> <th>Position</th> <th>Resistance value</th> </tr> </thead> <tbody> <tr> <td>Red - White</td> <td>17 to 25kΩ</td> </tr> <tr> <td>White - Black</td> <td>17 to 25kΩ</td> </tr> <tr> <td>Black - Red</td> <td>17 to 25kΩ</td> </tr> </tbody> </table> </div>	Position	Resistance value	Red - White	17 to 25kΩ	White - Black	17 to 25kΩ	Black - Red	17 to 25kΩ
Position	Resistance value									
Red - White	17 to 25kΩ									
White - Black	17 to 25kΩ									
Black - Red	17 to 25kΩ									
4	Compressor thermo. Bimetal type (Model : US-622KXTMQO-SS)	Check conduction by using the tester.								

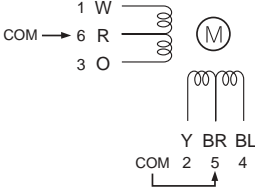
No.	Part name	Checking procedure																													
5	Outdoor temperature sensor (TO), discharge temperature sensor (TD), suction temperature sensor (TS), outdoor heat exchanger temperature sensor (TE), A room gas side temperature sensor (TGa), B room gas side temperature sensor (TGb)	<p>Disconnect the connector, and measure resistance value with the tester. (Normal temperature)</p> <table border="1"> <thead> <tr> <th rowspan="2">Sensor</th> <th colspan="5">Temperature</th> </tr> <tr> <th>10°C</th> <th>20°C</th> <th>30°C</th> <th>40°C</th> <th>50°C</th> </tr> </thead> <tbody> <tr> <td>TD (kΩ)</td> <td>100</td> <td>64</td> <td>41</td> <td>27</td> <td>18</td> </tr> <tr> <td>TGa, TGb (Cooling only) TO, TE, TS (kΩ)</td> <td>20.6</td> <td>12.6</td> <td>10.0</td> <td>5.1</td> <td>3.4</td> </tr> <tr> <td>TGa, TGb (Heat Pump) (kΩ)</td> <td>20.5</td> <td>12.5</td> <td>10.0</td> <td>5.3</td> <td>3.6</td> </tr> </tbody> </table>	Sensor	Temperature					10°C	20°C	30°C	40°C	50°C	TD (kΩ)	100	64	41	27	18	TGa, TGb (Cooling only) TO, TE, TS (kΩ)	20.6	12.6	10.0	5.1	3.4	TGa, TGb (Heat Pump) (kΩ)	20.5	12.5	10.0	5.3	3.6
Sensor	Temperature																														
	10°C	20°C	30°C	40°C	50°C																										
TD (kΩ)	100	64	41	27	18																										
TGa, TGb (Cooling only) TO, TE, TS (kΩ)	20.6	12.6	10.0	5.1	3.4																										
TGa, TGb (Heat Pump) (kΩ)	20.5	12.5	10.0	5.3	3.6																										
6	4-way valve coil (Model : VHV)	<p>Measure the resistance value of winding by using the tester.</p>  <table border="1"> <thead> <tr> <th>Resistance value</th> </tr> </thead> <tbody> <tr> <td>1435±144 Ω</td> </tr> </tbody> </table> <p>Under 20°C</p>	Resistance value	1435±144 Ω																											
Resistance value																															
1435±144 Ω																															
7	Electronic control valve coil (Model : CAM-MD12TF-1)	<p>Measure the resistance value of winding by using the tester.</p>  <table border="1"> <thead> <tr> <th>Position</th> <th>Resistance value</th> </tr> </thead> <tbody> <tr> <td>Red - White</td> <td>42 to 50kΩ</td> </tr> <tr> <td>White - Orange</td> <td>42 to 50kΩ</td> </tr> <tr> <td>Brown- Yellow</td> <td>42 to 50kΩ</td> </tr> <tr> <td>Brown- Blue</td> <td>42 to 50kΩ</td> </tr> </tbody> </table> <p>Under 20°C</p>	Position	Resistance value	Red - White	42 to 50kΩ	White - Orange	42 to 50kΩ	Brown- Yellow	42 to 50kΩ	Brown- Blue	42 to 50kΩ																			
Position	Resistance value																														
Red - White	42 to 50kΩ																														
White - Orange	42 to 50kΩ																														
Brown- Yellow	42 to 50kΩ																														
Brown- Blue	42 to 50kΩ																														

### 11-9-5. Checking Method for Each Part

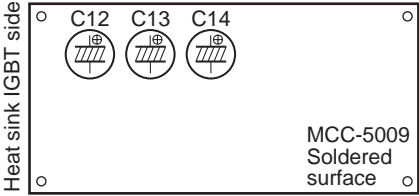
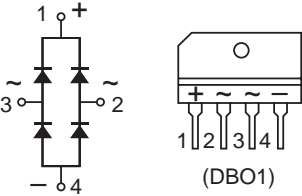
No.	Part name	Checking procedure						
1	Electrolytic capacitor (For boost, smoothing)	<ol style="list-style-type: none"> <li>Turn OFF the power supply breaker.</li> <li>Discharge all three capacitors completely.</li> <li>Check that safety valve at the bottom of capacitor is not broken.</li> <li>Check that vessel is not swollen or exploded.</li> <li>Check that electrolytic liquid does not blow off.</li> <li>Check that the normal charging characteristics are shown in continuity test by the tester.</li> </ol>  <table border="1"> <thead> <tr> <th colspan="2">Case that product is good</th> </tr> </thead> <tbody> <tr> <td colspan="2">Pointer swings once, and returns slowly. When performing test once again under another polarity, the pointer should return.</td> </tr> </tbody> </table> <p>C12, C13, C14 → 760μF/400V</p>	Case that product is good		Pointer swings once, and returns slowly. When performing test once again under another polarity, the pointer should return.			
Case that product is good								
Pointer swings once, and returns slowly. When performing test once again under another polarity, the pointer should return.								
2	Diode block	<ol style="list-style-type: none"> <li>Turn OFF the power supply breaker.</li> <li>Completely discharge the four electrolytic capacitors.</li> <li>Remove the diode block from the PCB (which is soldered in place).</li> <li>Use a multimeter with a pointer to test the continuity, and check that the diode block has the proper rectification characteristics.</li> </ol>  <table border="1"> <thead> <tr> <th>Tester rod</th> <th>Resistance value in good product</th> </tr> </thead> <tbody> <tr> <td>+</td> <td>∞</td> </tr> <tr> <td>-</td> <td>∞</td> </tr> </tbody> </table> <p>10 to 20 Ω when the multimeter probe is reversed</p>	Tester rod	Resistance value in good product	+	∞	-	∞
Tester rod	Resistance value in good product							
+	∞							
-	∞							

## 11-10. How to Simply Judge Whether Outdoor Fan Motor is Good or Bad

### 1. Symptom

- Outdoor fan motor does not rotate.
- Outdoor fan motor stops within several tens seconds though it started rotating.
- Outdoor fan motor rotates or does not rotate according to the position where the fan stopped, etc.

Remote controller check code "02 : Outdoor block, 1A : Outdoor fan drive system error"

### 2. Cause

The following causes are considered when the outdoor fan motor does not normally rotate.

- 1) Mechanical lock of the outdoor fan motor
- 2) Winding failure of the outdoor fan motor
- 3) Position-detect circuit failure inside of the outdoor fan motor
- 4) Motor drive circuit failure of the outdoor P.C. board

### 3. How to simply judge whether outdoor fan motor is good or bad

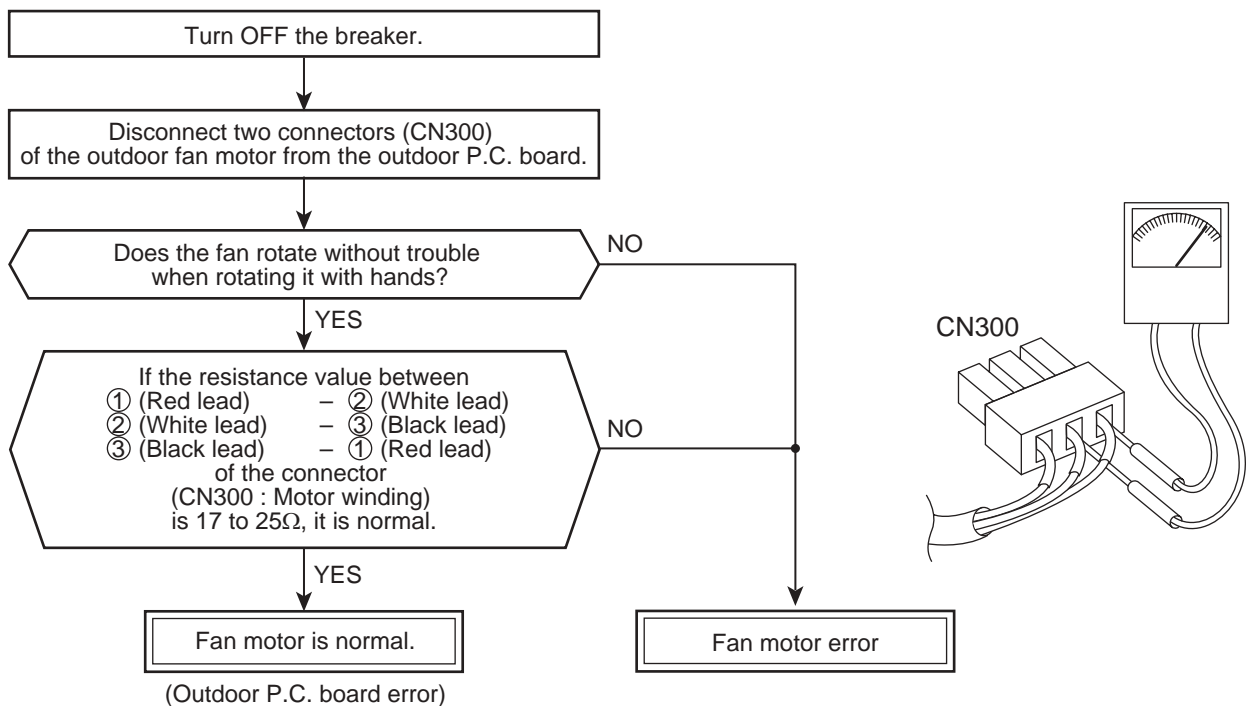

### NOTE :

However, GND circuit error inside of the motor may be accepted in some cases when the above check is performed.

When the fan motor does not become normal even if P.C. board is replaced, replace the outdoor fan motor.

## 12. HOW TO REPLACE THE MAIN PARTS

### WARNING

- Since high voltages pass through the electrical parts, turn off the power without fail before proceeding with the repairs.  
Electric shocks may occur if the power plug is not disconnected.
- After the repairs have been completed (after the front panel and cabinet have been installed), perform a test run, and check for smoking, unusual sounds and other abnormalities.  
If this check is omitted, a fire and/or electric shocks may occur.  
Before proceeding with the test run, install the front panel and cabinet.
- Ensure that the following steps are taken when doing repairs on the refrigerating cycle.

- (1) Do not allow any naked flames in the surrounding area. If a gas stove or other appliance is being used, extinguish the flames before proceeding. If the flames are not extinguished, they may ignite any oil mixed with the refrigerant gas.
- (2) Do not use welding equipment in an airtight room. Carbon monoxide poisoning may result if the room is not properly ventilated.
- (3) Do not bring welding equipment near flammable objects.



Flames from the equipment may cause the flammable objects to catch fire.

- **If keeping the power on is absolutely unavoidable while doing a job such as inspecting the circuitry, wear rubber gloves to avoid contact with the live parts.**

Electric shocks may be received if the live parts are touched.

High-voltage circuits are contained inside this unit. Proceed very carefully when conducting checks since directly touching the parts on the control circuit board may result in electric shocks.

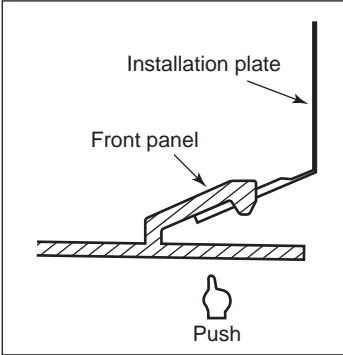
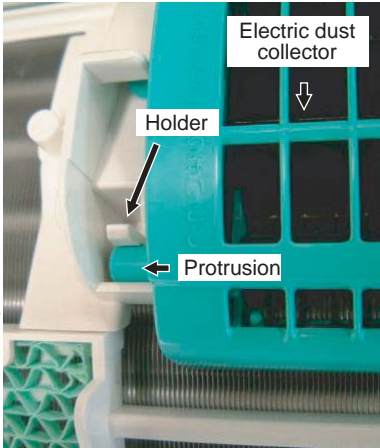
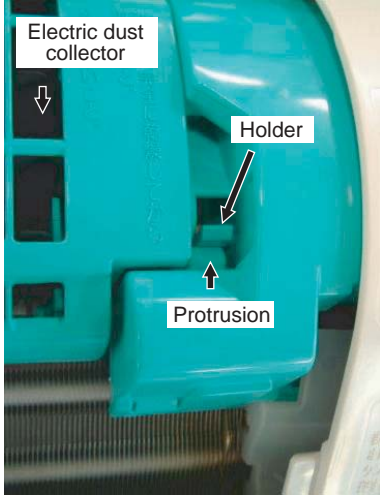
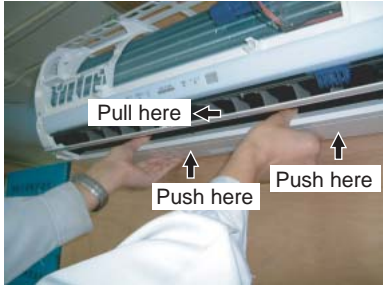
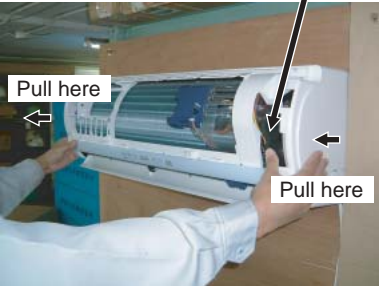

### 12-1. Indoor Unit

No.	Part name	Procedures	Remarks
①	Front panel	<ol style="list-style-type: none"> <li>1) Stop operation of the air conditioner and turn off its main power supply.</li> <li>2) Open the air inlet grille, push the arm toward the outside, and remove the grille.</li> <li>3) Remove the left and right air filters, and remove the electric dust collector.</li> </ol>	  

No.	Part name	Procedures	Remarks
①	Front panel	<p>4) Push “押す” part under the front panel and remove hooks of the front panel from the installation plate.</p>  <p>5) Remove the front panel fixing screws (2 pcs.).</p> <p>6) Push the electric parts box with the right thumb while pulling the both sides of the front panel toward you.</p> <p><b>&lt;How to assemble the front panel&gt;</b></p> <p>1) Push three center positions and two lower center positions of the air outlet, and then hang the hanging hooks (4 pcs.) at the top side of the front panel to the rear plate.</p>  <p>2) Insert the electric dust collector and left and right air filters.</p>  <p>Push in the electric dust collector until the protrusions on both sides are completely inserted into the holders. If installation is incomplete, the FILTER indicator (orange) may light.</p> <p>3) Tighten two screws.</p> <ul style="list-style-type: none"> <li>• Incomplete hanging or incomplete pushing may cause a dewdrops or generation of a fluttering sound.</li> </ul>	 

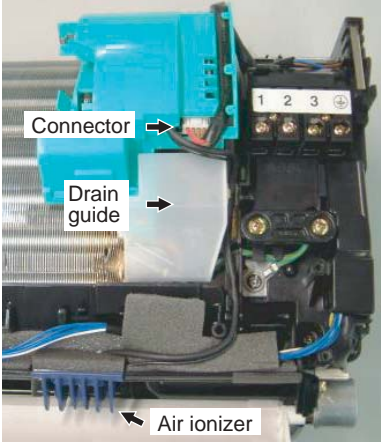
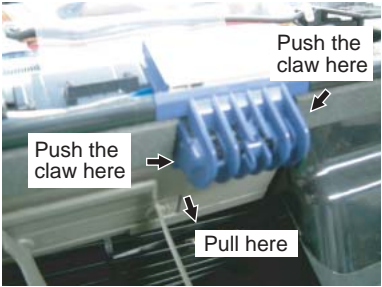
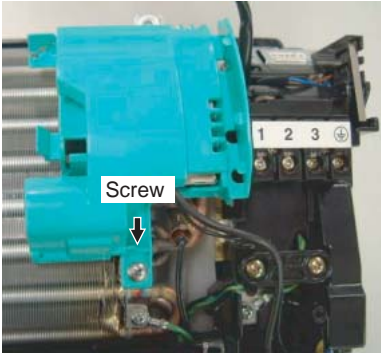

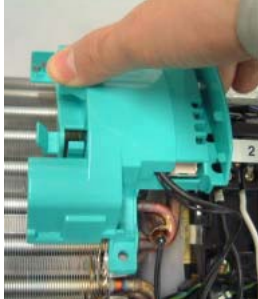

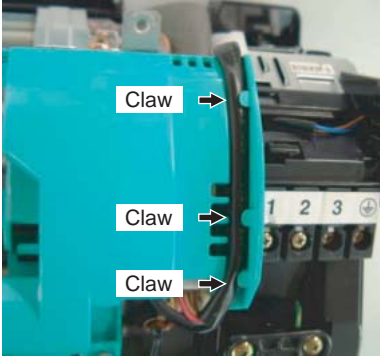
No.	Part name	Procedures	Remarks
②	High voltage generator	<p>1) Follow to the procedure in the item ①.</p> <p>2) Remove the drain guide.</p> <p>3) To remove the air ionizer from the back body, pull it toward you while pressing down on its left and right claws. Disconnect the two leads (black) connected to the air ionizer from where they are fitted into the other components. (Caution: do not remove the Faston.)</p> <p>4) Disconnect the connectors of the high-voltage generator, and disconnect the four leads from where they are fitted into the other components.</p> <p>5) Remove the fixing screw which secures the high voltage generator, and remove the high voltage generator from the evaporator.</p>	  

No.	Part name	Procedures	Remarks
②	High voltage generator	<p><b>&lt;How to assemble the high voltage generator&gt;</b></p> <p>1) Insert the high voltage generator straight into the evaporator, and secure it using the fixing screw.</p>  <p>2) Pass the leads of the high voltage generator through the area designated and insert them into its connectors.</p> <p>3) Attach the air ionizer to the back body, and pass the two leads (black) through the area designated on the electric parts box assembly.</p> <p>4) Attach the drain guide.</p>	 

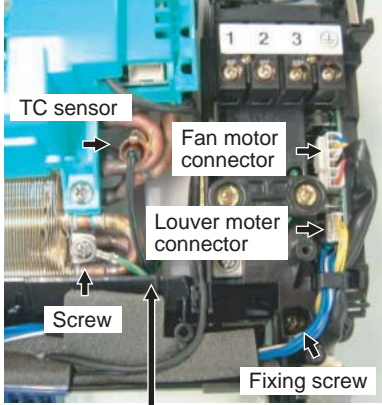
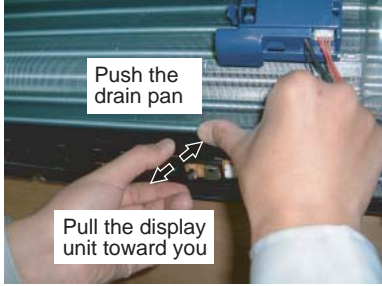

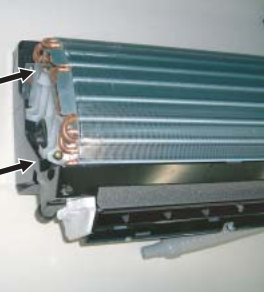
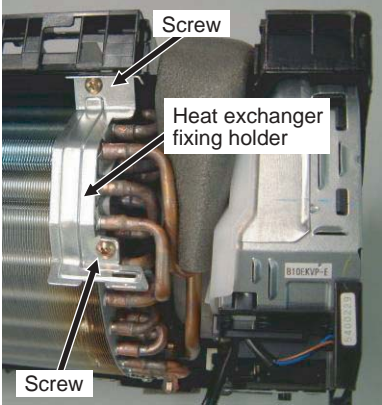
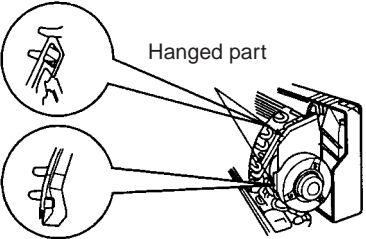

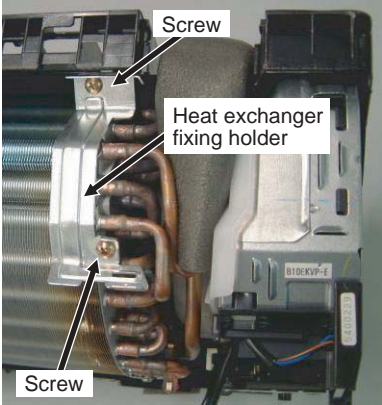
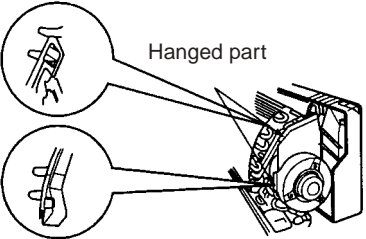

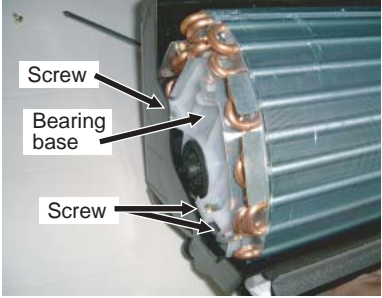
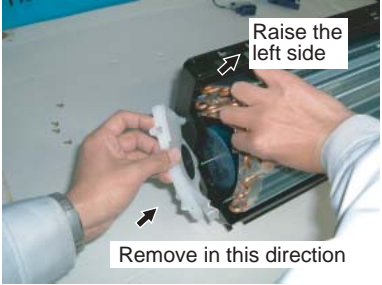
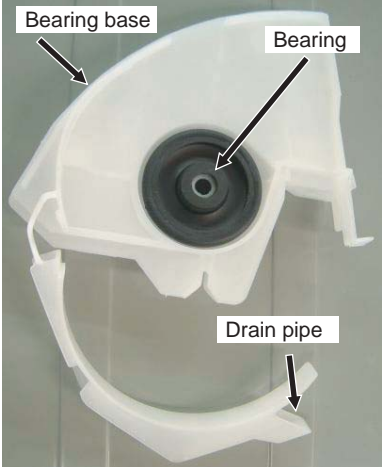
No.	Part name	Procedures	Remarks
③	Electric parts box assembly	<p>1) Follow the procedure up to 4) in ② above.</p> <p>2) Remove screw of earth lead attached to the end plate of the evaporator.</p> <p>3) Remove the lead wire cover, and remove connector (5P) for the fan motor and connector (5P) for the louver motor from the electric parts box assembly.</p> <p>4) Pull out TC sensor from sensor holder of the evaporator.</p> <p>5) Disengage the two claws at the top of the display unit. (They can be easily disengaged by pressing the drain pan above the claws and at the same time pulling the display unit toward you.)</p> <p>6) Remove the fixing screw that secures the electric parts box assembly, and remove the assembly.</p> <p><b>&lt;How to assemble the electric parts assembly&gt;</b></p> <p>1) Hook the top part of the electric parts box assembly onto the claws on the back body, and secure it using the fixing screw. Now attach the display unit. Connect the connectors for the fan motor and louver motor.</p> <p>2) Secure the grounding wire using the fixing screw. Insert the TC sensor into the sensor holder.</p> <p>* Be absolutely sure to loop the grounding wire and TC sensor leads once at the bottom.</p>	 <p>Lead wire cover</p>  <p>TC sensor</p> <p>Fan motor connector</p> <p>Louver motor connector</p> <p>Screw</p> <p>Fixing screw</p> <p>Make absolutely sure that the leads form a loop</p>  <p>Push the drain pan</p> <p>Pull the display unit toward you</p>

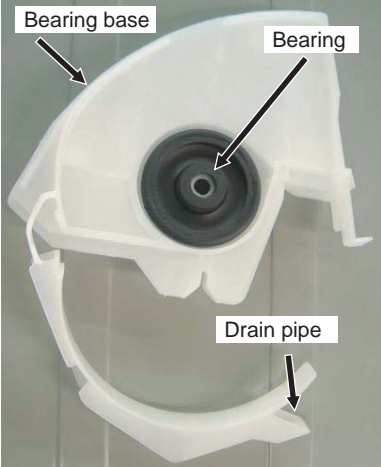
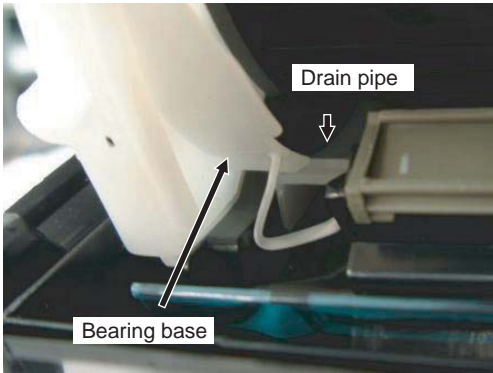
No.	Part name	Procedures	Remarks
④	Horizontal louver	1) Remove shaft of the horizontal louver from the back body. (First remove the left shaft, and then remove other shafts while sliding the horizontal louver leftward.)	
⑤	Evaporator (Heat exchanger)	1) Follow to the procedure in the item ③. 2) Remove the pipe holder from the rear side of the main unit. 3) Remove two fixing screws at the left side of the end plate of the heat exchanger.  4) Remove the heat exchanger fixing holder by removing the two fixing screws used to secure it.  5) Remove right side of the end plate from two fixing ribs while sliding slightly the heat exchanger rightward. 	  

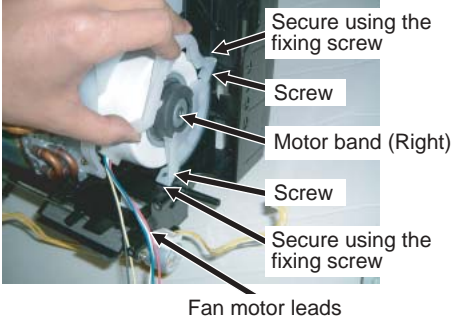
No.	Part name	Procedures	Remarks
⑥	Bearing	<p>1) Follow to the procedure in the items ①.</p> <p>2) Remove the two fixing screws used to secure the left edge panel of the heat exchanger, and remove the two screws used to secure the bearing base.</p> <p>3) Raise the left side of the heat exchanger slightly, and remove the bearing base.</p> <p><b>&lt;Caution at assembling&gt;</b></p> <ul style="list-style-type: none"> <li>• If the bearing is out from the housing, push it into the specified position and then incorporate it in the main body.</li> <li>• After assembling the bearing base, check that it is fitted into the stepped part of the drain pipe.</li> </ul>	 <p>Screw</p> <p>Bearing base</p> <p>Screw</p>  <p>Raise the left side</p> <p>Remove in this direction</p>  <p>Bearing base</p> <p>Bearing</p> <p>Drain pipe</p>

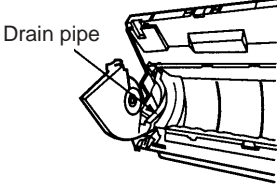
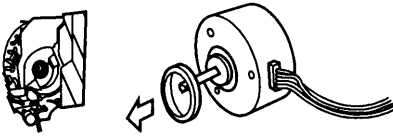
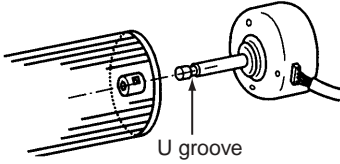
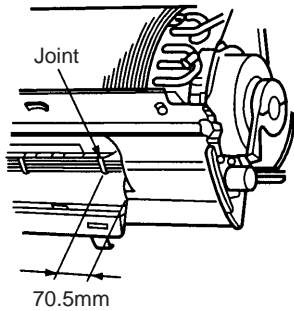
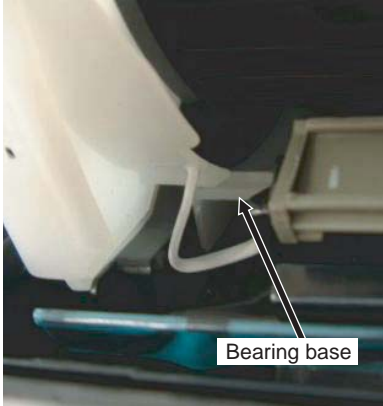
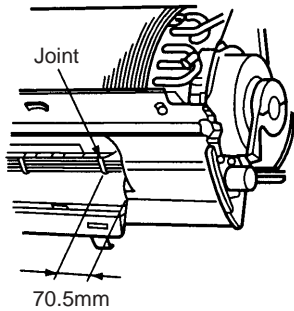

No.	Part name	Procedures	Remarks
⑦	Fan motor	<p>1) Follow to the procedure in the item ③.</p> <p>2) Loosen the set screw of the cross flow fan.</p> <p>3) Remove two fixing screws of the motor band (Right), and then remove the motor band (Right).</p> <p>4) Pull the fan motor outward.</p> <p>In assembling work, install the fan motor as follows.</p> <ul style="list-style-type: none"> <li>• When assembling the fan motor, the fan motor must be installed in such a way that the fan motor leads will be taken out is positioned at the bottom front.</li> <li>• After assembling the two hooking claws of the motor band (right) into the main body, position the fan motor, insert it, and then secure the motor band (right) using the two fixing screws.</li> </ul> 	 
⑧	Cross flow fan	<p>1) Follow to the procedure in the item ⑥.</p> <p>2) Remove the heat exchanger fixing holder by removing the two fixing screws used to secure it.</p> <p>3) Loosen the set screw of the cross flow fan.</p> <p>4) Lift the left side of the heat exchanger, and pull out the cross flow fan.</p>	

No.	Part name	Procedures	Remarks
⑧	Cross flow fan	<p><b>&lt;Caution at reassembling&gt;</b></p> <p>a) At assembling work of the bearing base, check that the drain pipe is surely incorporated in the back body. (Otherwise, water leak is caused.)</p>  <p>b) To incorporate the fan motor, remove the fan motor rubber (at shaft core side), incorporate the motor into the position in the following figure, and then install the fan motor.</p>  <ul style="list-style-type: none"> <li>• Install the cross flow fan so that the right end of the 1st joint from the right of the cross flow fan is set keeping 70.5mm from wall of rear plate of the main unit.</li> <li>• Holding the set screw, install the cross flow fan so that U-groove of the fan motor comes to the mounting hole of the set screw.</li> </ul>  <ul style="list-style-type: none"> <li>• Perform positioning of the fan motor as follows:</li> <li>• When assembling the fan motor, the fan motor must be installed in such a way that the fan motor leads will be taken out is positioned at the bottom front.</li> <li>• After assembling the two hooking claws of the motor band (right) into the main body, position the fan motor, insert it, and then secure the motor band (right) using the two fixing screws.</li> </ul> 	 <p>Bearing base</p> 



## 12-2. Microcomputer

No.	Part name	Procedure	Remarks
①	Common procedure	1) Turn the power supply off to stop the operation of air-conditioner. 2) Remove the front panel. • Remove the 2 fixing screws. 3) Remove the electrical part base.	Replace terminal block, microcomputer assembly and the P.C. board assembly.

### <P.C. board layout>

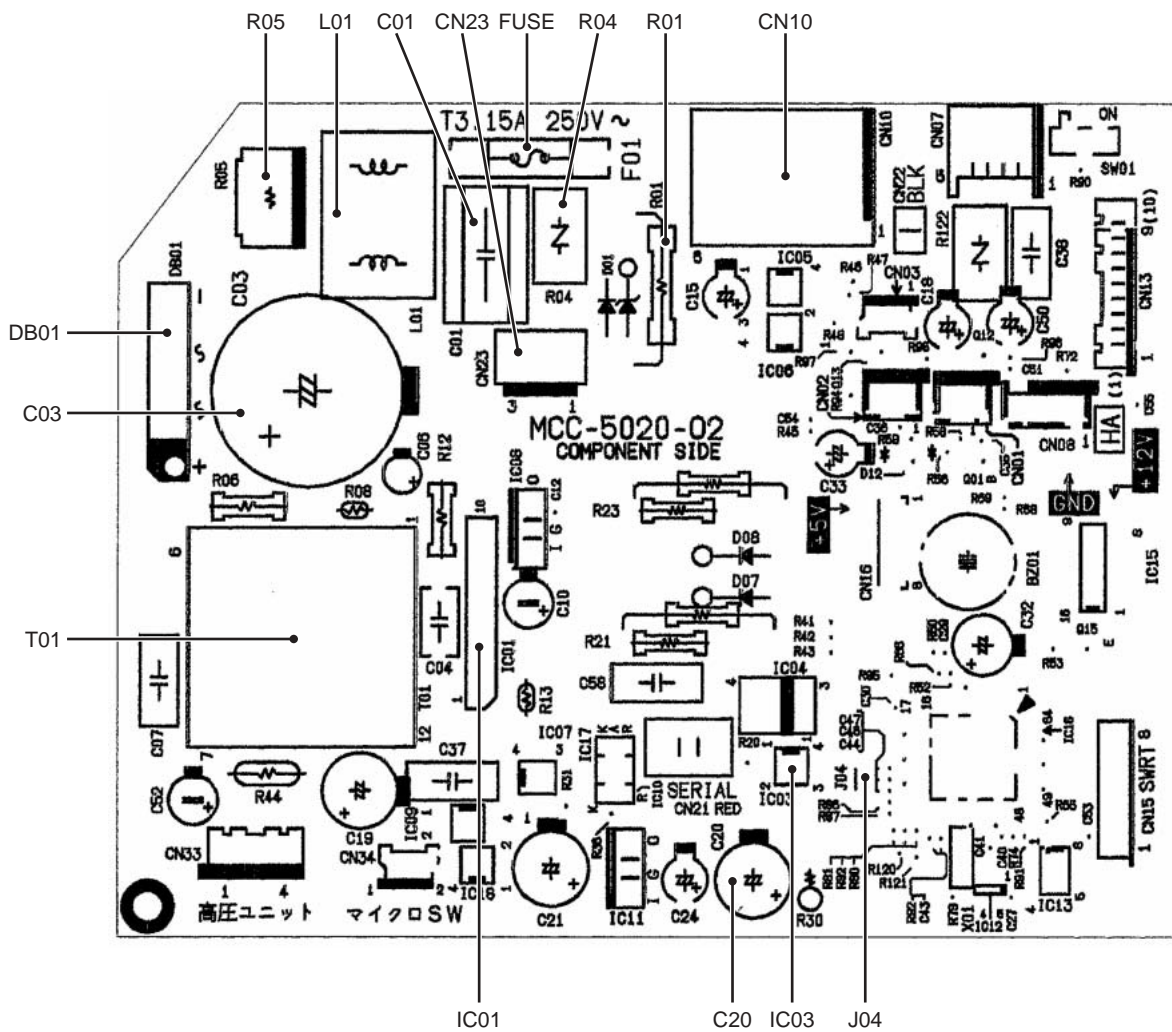

## 12-3. Outdoor Unit

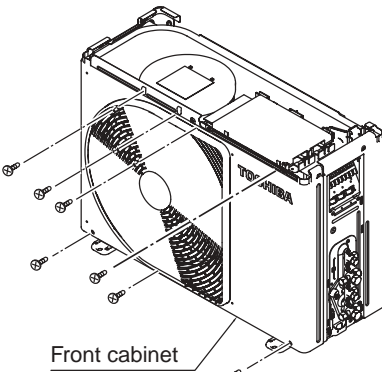
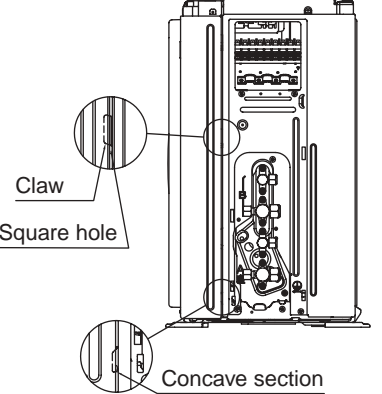

No.	Part name	Procedures	Remarks
①	Common procedure	<p><b>1. Detachment</b></p> <div data-bbox="443 398 1013 555" style="border: 1px solid black; padding: 5px;"> <p><b>NOTE :</b>  <b>Wear gloves for this job.</b>  <b>Otherwise, you may injure your hands on the parts, etc.</b></p> </div> <ol style="list-style-type: none"> <li>1) Stop operation of the air conditioner, and turn off the main switch of the breaker for air conditioner.</li> <li>2) Remove the valve cover. (ST1TØ4 x 8l 1 pc.) <ul style="list-style-type: none"> <li>• After removing screw, remove the valve cover pulling it downward.</li> </ul> </li> <li>3) Remove wiring cover (ST1TØ4 x 8l 2 pcs.), and then remove connecting cable.</li> <li>4) Remove the upper cabinet. (ST1TØ4 x 8l 5 pcs.) <ul style="list-style-type: none"> <li>• After removing screws, remove the upper cabinet pulling it upward.</li> </ul> </li> </ol> <p><b>2. Attachment</b></p> <ol style="list-style-type: none"> <li>1) Attach the water-proof cover. <div data-bbox="443 1108 1013 1265" style="border: 1px solid black; padding: 5px;"> <p><b>NOTE :</b>  <b>The water-proof cover must be attached without fail in order to prevent rain water, etc. from entering inside the indoor unit.</b></p> </div> </li> <li>2) Attach the upper cabinet. (ST1TØ4 x 8l 5 pcs.)</li> <li>3) Perform cabling of connecting cable, and attach the wiring cover. <ul style="list-style-type: none"> <li>• Place the wiring cover over the opening used to work on the connecting wires of the side cabinet, and secure it using the two fixing screws (ST1TØ4 x 8l 2 pcs.). At this point, the top cushion of the wiring cover must be on the inside of the opening.</li> </ul> </li> <li>4) Attach the valve cover. (ST1TØ4 x 8l 1 pc.) <ul style="list-style-type: none"> <li>• Insert the upper part into the square hole of the side cabinet, set hook claw of the valve cover to square holes (at three positions) of the main unit, and attach it pushing upward.</li> </ul> </li> </ol>	<div data-bbox="1045 369 1444 817" style="text-align: center;"> <p>Upper cabinet</p> <p>Water proof cover</p> <p>Valve cover</p> </div> <div data-bbox="1045 1030 1444 1366" style="text-align: center;"> <p>Insert the bent part into the rear panel of the inverter</p> <p>Bring into contact against these parts</p> <p>Align the stitch line with the top edge of the front cabinet</p> <p>Bend downward, and align with the inside surface of the front cabinet</p> </div> <div data-bbox="1045 1377 1404 1411" style="border: 1px solid black; padding: 2px; text-align: center;"> <p><b>How to mount the water-proof cover</b></p> </div>

No.	Part name	Procedures	Remarks
②	Front cabinet	<p><b>1. Detachment</b></p> <ol style="list-style-type: none"> <li>1) Perform step 1 in ①.</li> <li>2) Remove the fixing screws (ST1TØ4 x 8l 2 pcs.) used to secure the front cabinet and inverter cover, the screws (ST1TØ4 x 8l 3 pcs.) used to secure the front cabinet at the bottom plate, and the fixing screws (ST1TØ4 x 8l 2 pcs.) used to secure the motor base.</li> </ol> <ul style="list-style-type: none"> <li>• The front cabinet is fitted into the side cabinet (left) at the front left side so pull up the top of the front cabinet to remove it.</li> </ul> <p><b>2. Attachment</b></p> <ol style="list-style-type: none"> <li>1) Insert the claw on the front left side into the side cabinet (left).</li> <li>2) Hook the bottom part of the front right side onto the concave section of the bottom plate. Insert the claw of the side cabinet (right) into the square hole in the front cabinet.</li> <li>3) Return the screws that were removed above to their original positions, and attach them.</li> </ol>	 <p>Front cabinet</p>  <p>Claw</p> <p>Square hole</p> <p>Concave section</p>

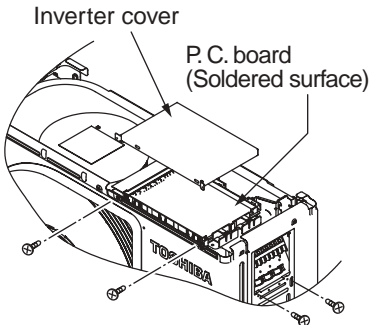
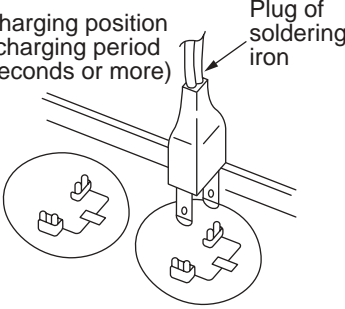
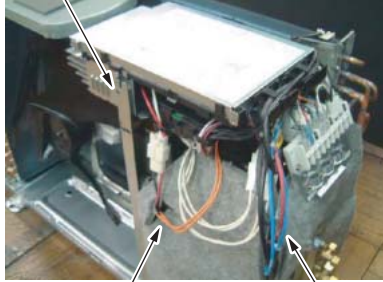
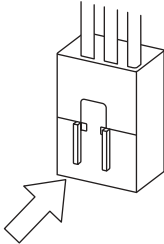
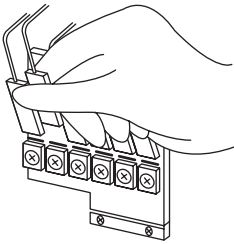

No.	Part name	Procedure	Remarks
③	Inverter assembly	<p>1) Perform work of item 1 in ①.</p> <p>2) Remove screw (ST1TØ4 x 8l 2 pcs.) of the upper part of the front cabinet.</p> <ul style="list-style-type: none"> <li>• If removing the inverter cover in this condition, P.C. board can be checked.</li> <li>• If there is no space above the unit, perform work of 1 in ②.</li> </ul> <div data-bbox="413 504 1003 584" style="border: 1px solid black; padding: 5px; margin: 10px 0;"> <p><b>Be careful to check the inverter because high-voltage circuit is incorporated in it.</b></p> </div> <p>3) Perform discharging by connecting <math>\oplus</math>, <math>\ominus</math> polarity by discharging resistance (approx. 100Ω40W) or plug of soldering iron to <math>\oplus</math>, <math>\ominus</math> terminals a of the C14 (printed "CAUTION HIGH VOLTAGE" is attached.) electrolytic capacitor (760μF) on P.C. board.</p> <div data-bbox="413 840 1003 987" style="border: 1px solid black; padding: 5px; margin: 10px 0;"> <p><b>Be careful to discharge the capacitor because the electrolytic capacitor cannot naturally discharge and voltage remains according to trouble type in some cases.</b></p> </div> <div data-bbox="413 1028 1003 1216" style="border: 1px solid black; padding: 5px; margin: 10px 0;"> <p><b>NOTE :</b>  <b>This capacitor is one with mass capacity. Therefore, it is dangerous that a large spark generates if short-circuiting between <math>\oplus</math>, <math>\ominus</math> polarity with screwdriver, etc. for discharging.</b></p> </div> <p>4) Remove screw (ST1TØ4 x 8l 2 pcs.) fixing the main body and the inverter box.</p> <p>5) Remove the front cabinet by performing step 1 in ②, and remove the fixing screws (ST1TØ4 x 8l) for securing the main body and inverter box.</p> <p>6) Remove various lead wires from the holder at upper part of the inverter box.</p> <p>7) Pull the inverter box upward.</p> <p>8) Disconnect connectors of various lead wires.</p> <div data-bbox="413 1581 1003 1729" style="border: 1px solid black; padding: 5px; margin: 10px 0;"> <p><b>Requirement :</b>  <b>As each connector has a lock mechanism, avoid to remove the connector by holding the lead wire, but by holding the connector.</b></p> </div>	<p>Inverter cover</p> <p>P.C. board (Soldered surface)</p>  <p>Discharging position (Discharging period 10 seconds or more)</p> <p>Plug of soldering iron</p>  <p>A screw (STIT-4X8MSZN)</p>  <p>Put the compressor thermo leads and the comp. through the hole.</p> <p>Put each leads through the slit.</p> <p>The connector is one with lock, so remove it while pushing the part indicated by an arrow.</p>   <p>Be sure to remove the connector by holding the connector, not by pulling the lead wire.</p>

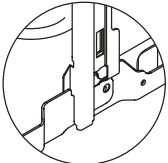
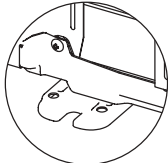
No.	Part name	Procedures	Remarks
④	Control board assembly	<p>1) Disconnect the leads and connectors connected to the other parts from the control board assembly.</p> <p>1) Leads</p> <ul style="list-style-type: none"> <li>• 3 leads (black, white, orange) connected to terminal block.</li> <li>• Lead connected to compressor : Disconnect the connector (3P).</li> <li>• Lead connected to reactor : Disconnect the two connectors (2P).</li> </ul> <p>2) Connectors (x8)</p> <p>Main P.C. board</p> <p>CN300 : Outdoor fan motor (3P: white)* (See <b>Note</b>)</p> <p>CN701 : 4-way valve (2P: yellow)*</p> <p>Sub P.C. board</p> <p>CN01 : TE sensor (2P: white)*</p> <p>CN11 : PMW (6P: white)</p> <p>CN12 : PMV (6P: red)</p> <p>CN04 : TS sensor (3P: white)*</p> <p>CN02 : TD sensor (3P: white)*</p> <p>CN03 : TO sensor (2P: white)</p> <p>CN05 : TGa sensor (3P: yellow)</p> <p>CN14 : TGb sensor (3P: red)</p> <p>CN10 : Case thermo (2P: blue)*</p> <p>CN07 : Lead for communication</p> <p>CN13 : Lead for AC power supply</p> <div data-bbox="456 1099 1027 1279" style="border: 1px solid black; padding: 5px; margin-top: 10px;"> <p><b>Note :</b></p> <p>These connectors have a disconnect prevention mechanism: as such, the lock on their housing must be released before they are disconnected.</p> </div> <p>2) Remove the control board assembly from the P.C. board base. (Remove the heat sink and control board assembly while keeping them screwed together.)</p> <div data-bbox="456 1420 1027 1543" style="border: 1px solid black; padding: 5px; margin-top: 10px;"> <p><b>Note :</b></p> <p>Disengage the four claws of the P.C. board base, hold the heat sink, and lift to remove it.</p> </div> <p>3) Remove the two fixing screws used to secure the heat sink and control board assembly.</p> <p>4) Mount the new control board assembly.</p> <div data-bbox="456 1671 1027 1823" style="border: 1px solid black; padding: 5px; margin-top: 10px;"> <p><b>Note :</b></p> <p>When mounting the new control board assembly, ensure that the P.C. board is inserted properly into the P.C. board support groove.</p> </div> <p>5) Disconnect the connectors.</p> <p>6) Remove the two screws (PT2F-4X10MS-ZN), then remove the Sub P.C. board base while disengaging the claws from the square holes.</p> <p>7) Disengage the two claws of the Sub P.C. board base and remove the Sub P.C. board.</p>	<div data-bbox="1082 248 1410 465" style="border: 1px solid black; padding: 5px; margin-bottom: 10px;"> <p style="text-align: center;"><b>Main P.C. board</b></p> </div> <div data-bbox="1082 517 1410 958" style="border: 1px solid black; padding: 5px; margin-bottom: 10px;"> </div> <div data-bbox="1134 981 1347 1308" style="border: 1px solid black; padding: 5px; margin-bottom: 10px;"> <p style="text-align: center;"><b>Sub P.C. board</b></p> </div> <p>CN300, CN701, CN600 and CN603 are connectors with locking mechanisms: as such, to disconnect them, they must be pressed in the direction of the arrow while pulling them out.</p> <div data-bbox="1091 1585 1410 1995" style="border: 1px solid black; padding: 5px; margin-top: 10px;"> <p style="text-align: center;"><b>P.C. board base</b></p> </div>

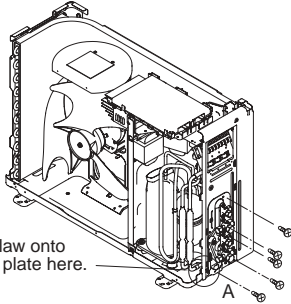
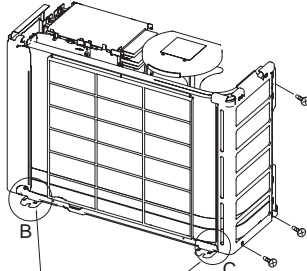
No.	Part name	Procedures	Remarks
⑤	Side cabinet	<p><b>1. Side cabinet (right)</b></p> <ol style="list-style-type: none"> <li>1) Perform step 1 in ② and all the steps in ③.</li> <li>2) Remove the fixing screw (ST1TØ4 x 8l 5 pcs.) used for securing the side cabinet to the bottom plate and valve fixing plate.</li> </ol> <p><b>2. Side cabinet (left)</b></p> <ol style="list-style-type: none"> <li>1) Perform step 1 in ②.</li> <li>2) Remove the fixing screw (ST1TØ4 x 8l 1 pcs.) used to secure the side cabinet (left) onto the heat exchanger.</li> <li>3) Remove the fixing screw (ST1TØ4 x 8l 2 pc.) used for securing the side cabinet to the bottom plate and heat exchanger.</li> </ol> <div style="display: flex; justify-content: space-around; align-items: center; margin-top: 20px;">    </div> <p style="text-align: center; margin-top: 5px;"> <span style="margin-right: 40px;">Detail A</span> <span style="margin-right: 40px;">Detail B</span> <span>Detail C</span> </p>	 <p style="margin-left: 20px;">Hook the claw onto the bottom plate here.</p>  <p style="margin-left: 20px;">The back body section is hooked onto the bottom plate here.</p>

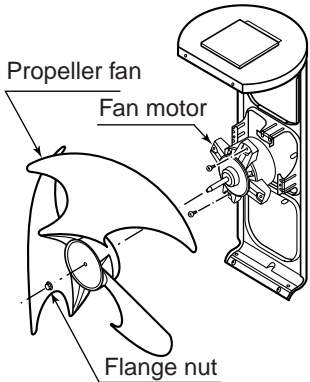
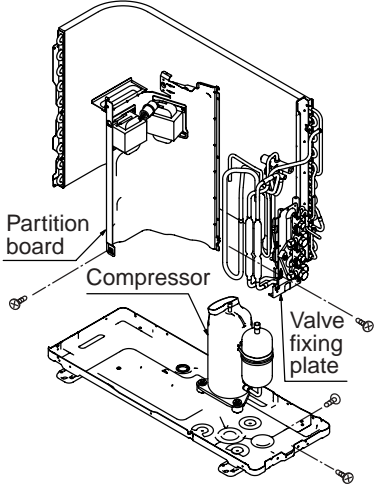
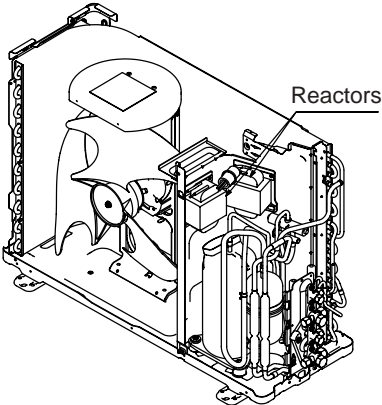
No.	Part name	Procedures	Remarks
⑥	Fan motor	<ol style="list-style-type: none"> <li>1) Perform work of item 1 of ① and ②.</li> <li>2) Remove the flange nut fixing the fan motor and the propeller. <ul style="list-style-type: none"> <li>• Flange nut is loosened by turning clockwise. (To tighten the flange nut, turn counterclockwise.)</li> </ul> </li> <li>3) Remove the propeller fan.</li> <li>4) Disconnect the connector for fan motor from the inverter.</li> <li>5) Remove the fixing screws (2 pc.) holding by hands so that the fan motor does not fall.</li> </ol> <p>* <u>Precautions when assembling the fan motor</u> Tighten the flange nut using a tightening torque of 4.9 N•m.</p>	
⑦	Compressor	<ol style="list-style-type: none"> <li>1) Perform work of item 1 of ① and ②, ③, ④, ⑤.</li> <li>2) Extract refrigerant gas.</li> <li>3) Remove the partition board. (ST1TØ4 x 8ℓ 3 pcs.)</li> <li>4) Remove the sound-insulation material.</li> <li>5) Remove terminal cover of the compressor, and disconnect lead wire of the compressor and the comp. thermo assembly from the terminal.</li> <li>6) Remove pipe connected to the compressor with a burner. <ul style="list-style-type: none"> <li>• Take care to keep the 4-way valve away from naked flames. (Otherwise, it may malfunction.)</li> </ul> </li> <li>7) Remove the fixing screw of the bottom plate and heat exchanger. (ST1TØ4 x 8ℓ 1 pc.)</li> <li>8) Remove the fixing screw of the bottom plate and valve fixing plate. (ST1TØ4 x 8ℓ 1 pc.)</li> <li>9) Pull upward the refrigeration cycle.</li> <li>10) Remove BOLT (3 pcs.) fixing the compressor to the bottom plate.</li> </ol> <p>* <u>Precautions when assembling the compressor</u> Tighten the compressor bolts using a tightening torque of 4.9 N•m.</p>	
⑧	Reactor	<ol style="list-style-type: none"> <li>1) Perform work of item 1 of ②, and ③.</li> <li>2) Remove screws fixing the reactor. (ST1TØ4 x 8ℓ 4 pcs.)</li> </ol>	

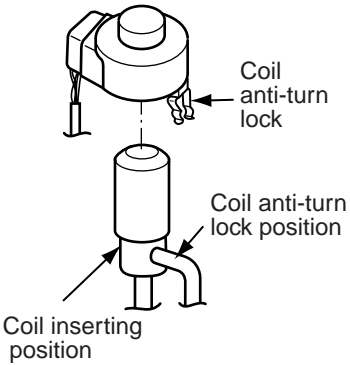
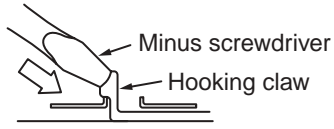
No.	Part name	Procedures	Remarks
⑨	Electronic expansion valve coil	<p><b>1. Detachment</b></p> <p>1) Perform step 1 in ②, all the steps in ③ and 1 in ⑤.</p> <p>2) Remove the coil by pulling it up from the electronic control valve body.</p> <p><b>2. Attachment</b></p> <p>1) When assembling the coil into the valve body, ensure that the coil anti-turn lock is installed properly in the pipe.</p> <p><b>&lt;Handling precaution&gt;</b></p> <p>When handling the parts, do not pull the leads. When removing the coil from the valve body, use your hand to secure the body in order to prevent the pipe from being bent out of shape.</p>	
⑩	Fan guard	<p><b>1. Detachment</b></p> <p>1) Perform work of item 1 of ②.</p> <p>2) Remove the front cabinet, and put it down so that fan guard side directs downward.</p> <div data-bbox="461 1115 1029 1205" style="border: 1px solid black; padding: 5px; margin: 10px 0;"> <p><b>Perform work on a corrugated cardboard, cloth, etc. to prevent flaw to the product.</b></p> </div> <p>3) Remove the hooking claws by pushing minus screwdriver according to the arrow mark in the right figure, and remove the fan guard.</p> <p><b>2. Attachment</b></p> <p>1) Insert claws of the fan guard in the holes of the front cabinet. Push the hooking claws (9 positions) by hands and fix the claws.</p> <div data-bbox="461 1496 1029 1624" style="border: 1px solid black; padding: 5px; margin: 10px 0;"> <p><b>All the attaching works have completed. Check that all the hooking claws are fixed to the specified positions.</b></p> </div>	

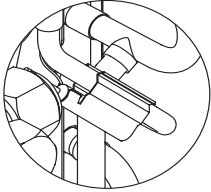
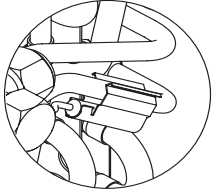
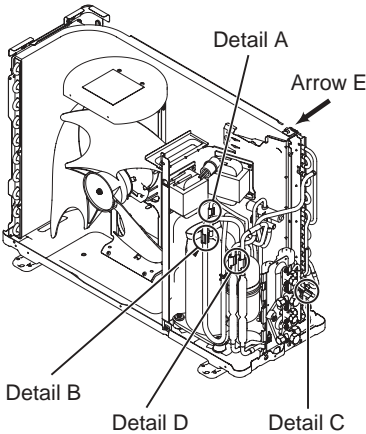
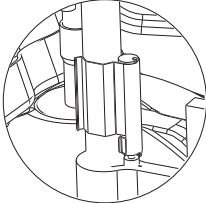
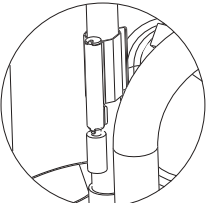
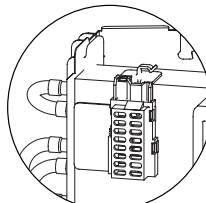
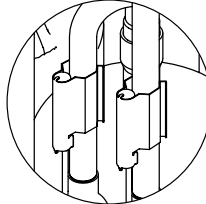
No.	Part name	Procedures	Remarks
⑪	TE sensor (outdoor heat exchanging temperature sensor)	<p>• <b>Attachment</b></p> <p>With the sensor leads pointing in the direction shown in the figure, install the sensor onto the straight pipe part of the condenser output pipe.</p> <div style="display: flex; justify-content: space-around;">   </div> <p style="text-align: center;">Detail C for M14EAV-E, M14EACV-E      Detail C for M18EAV-E, M18EACV-E</p>	
⑫	TS sensor (suction pipe temperature sensor)	<p>• <b>Attachment</b></p> <p>With its leads pointing downward, point the sensor in the direction of the packed valve, and install it onto the straight pipe part of the suction pipe.</p>  <p style="text-align: center;">Detail B</p>	<ul style="list-style-type: none"> <li>• Shown in the above figure is the model M14EAV-E.</li> <li>• The sensor mounting positions in the model M18EAV-E are all the same with the sole exception of the TE sensor. Refer to the figure shown on the left.</li> </ul>
⑬	TD sensor (discharge pipe temperature sensor)	<p>• <b>Attachment</b></p> <p>With its leads pointing downward, install the sensor facing downward onto the vertical straight pipe part of the discharge pipe.</p>  <p style="text-align: center;">Detail A</p>	<p><b>CAUTION</b></p> <p>During the installation work (and on its completion), take care not to damage the coverings of the sensor leads on the edges of the metal plates or other parts. It is dangerous for these coverings to be damaged since damage may cause electric shocks and/or a fire.</p>
⑭	TO sensor (outside air temperature sensor)	<p>• <b>Attachment</b></p> <p>Insert the outdoor air temperature sensor into the holder, and install the holder onto the heat exchanger.</p>  <p style="text-align: center;">Arrow D</p>	<p><b>CAUTION</b></p> <p>After replacing the parts, check whether the positions where the sensors were installed are the proper positions as instructed. The product will not be controlled properly and trouble will result if the sensors have not been installed in their proper positions.</p>
⑮	TGa/TGb sensor (Gas side pipe temperature sensor)	<p>• <b>Attachment</b></p> <p>With its leads pointing downward, point the sensor in the direction of the front cabinet, and install the sensor onto the straight pipe part of gas side pipe. Match the sensor protective tube colors with the pipe marking colors and install the sensors. TGa is yellow, and TGb is red.</p>  <p style="text-align: center;">Detail E</p>	

No.	Part name	Procedure	Remarks																												
⑩	<p>Replacement of temperature sensor for servicing only</p> <p>Common service parts of sensor TO, TS, TE, TD, TGa, TGb</p> <p>These are parts for servicing sensors. Please check that the accessories shown in the right table are packed.</p>	<ol style="list-style-type: none"> <li>1) Cut the sensor 100 mm longer than old one.</li> <li>2) Cut the protective tube after pulling out it (200 mm).</li> <li>3) Move the protective tube toward the thermal sensor side and tear the tip of lead wire in two then strip the covering part.</li> <li>4) Pass the stripped part through the thermal constricting tube.</li> <li>5) Cut the old sensor 100 mm length on the connector side, and recycle that connector.</li> <li>6) Tear the lead wire in two on the connector side and strip the covering part.</li> <li>7) Twist the leads on the connector and sensor sides, and solder them.</li> <li>8) Move the thermal constricting tubes toward the soldered parts and heat them with the dryer and constricting them.</li> <li>9) Wind the attached color tape round the both terminals of the protective tube when colored protective tube is used.</li> <li>10) Fix the sensor again.</li> </ol> <p><b>NOTES :</b></p> <ol style="list-style-type: none"> <li>1) Store the joint part of the sensor and the connector in the electric parts box.</li> <li>2) Never joint them near the thermal sensor part. Otherwise it would cause insulation inferiority because of dew drops.</li> <li>3) When replacing the sensor using the colored protective tube, wind the color tape matching the color of that tube.</li> </ol>	<p>The diagram illustrates the replacement procedure for a temperature sensor. It shows the sensor, connector, thermal sensor part, thermal constricting tube, and the final assembly with color tape and a dryer.</p>																												
		<table border="1"> <thead> <tr> <th></th> <th>Parts name</th> <th>Q'ty</th> <th>Remarks</th> </tr> </thead> <tbody> <tr> <td>1</td> <td>Sensor</td> <td>1</td> <td>Length : 3m</td> </tr> <tr> <td>2</td> <td>Sensor Spring (A)</td> <td>1</td> <td>For spare</td> </tr> <tr> <td>3</td> <td>Sensor Spring (B)</td> <td>1</td> <td>For spare</td> </tr> <tr> <td>4</td> <td>Thermal constricting tube</td> <td>3</td> <td>Including one spare</td> </tr> <tr> <td>5</td> <td>Color tape</td> <td>1</td> <td>9 colors</td> </tr> <tr> <td>6</td> <td>Terminal</td> <td>3</td> <td></td> </tr> </tbody> </table>		Parts name	Q'ty	Remarks	1	Sensor	1	Length : 3m	2	Sensor Spring (A)	1	For spare	3	Sensor Spring (B)	1	For spare	4	Thermal constricting tube	3	Including one spare	5	Color tape	1	9 colors	6	Terminal	3		
	Parts name	Q'ty	Remarks																												
1	Sensor	1	Length : 3m																												
2	Sensor Spring (A)	1	For spare																												
3	Sensor Spring (B)	1	For spare																												
4	Thermal constricting tube	3	Including one spare																												
5	Color tape	1	9 colors																												
6	Terminal	3																													



Outdoor unit  
main PCB (MCC-5009)

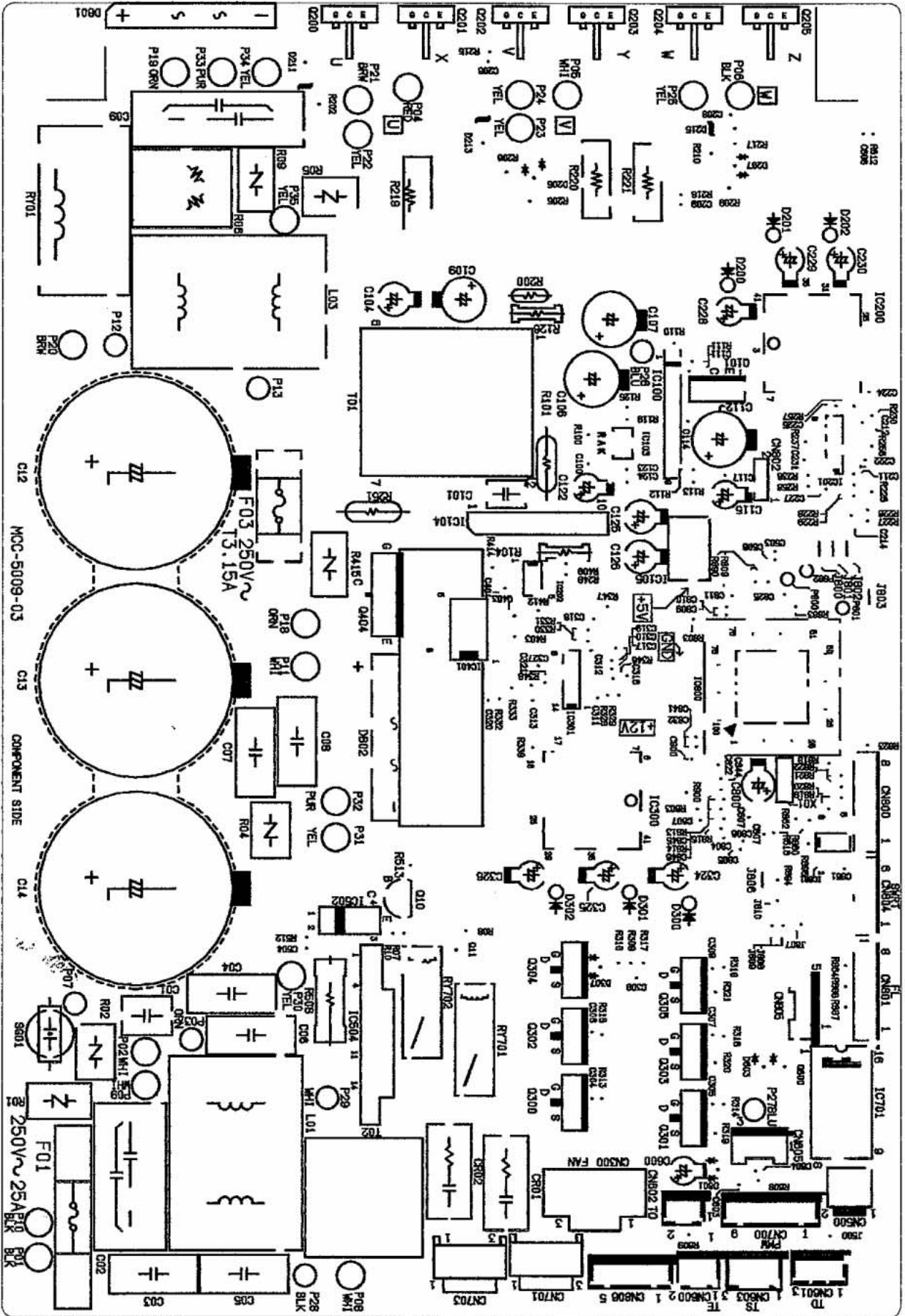



**Outdoor unit  
Sub PCB (MCC-5009)**

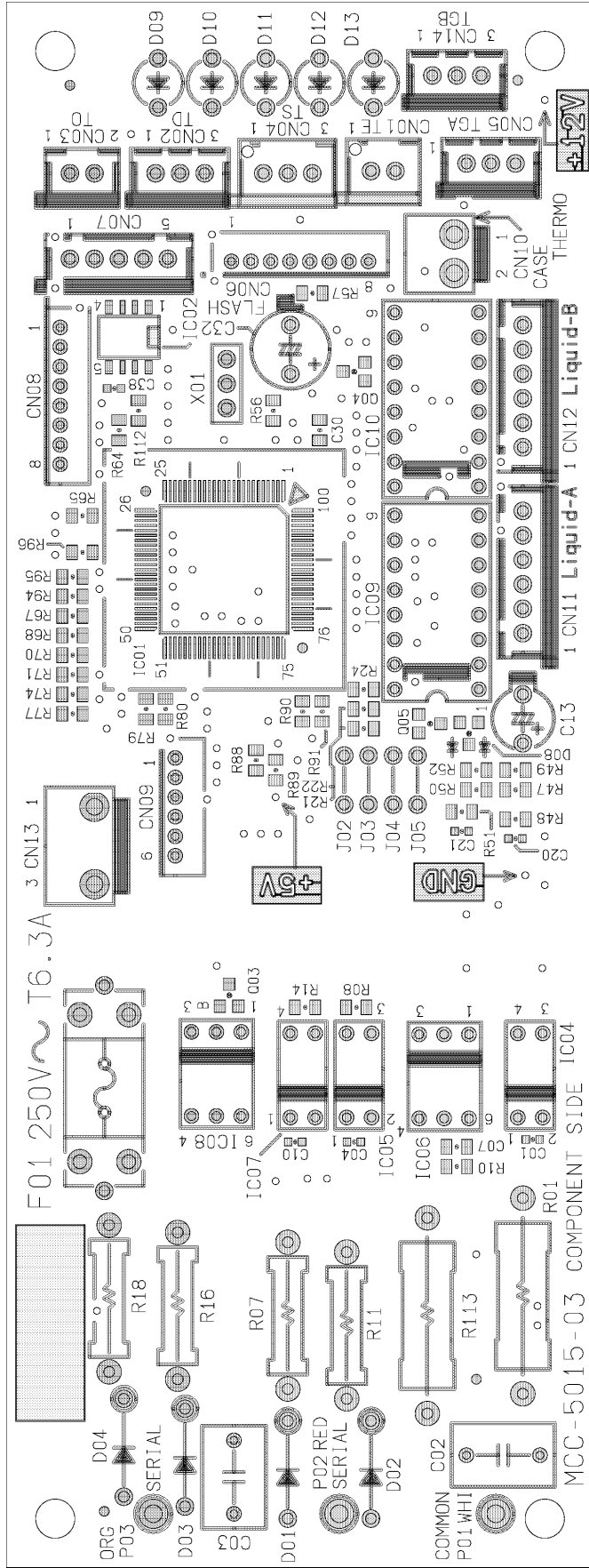

## 13. EXPLODED VIEWS AND PARTS LIST

### 13-1. Indoor Unit (1)

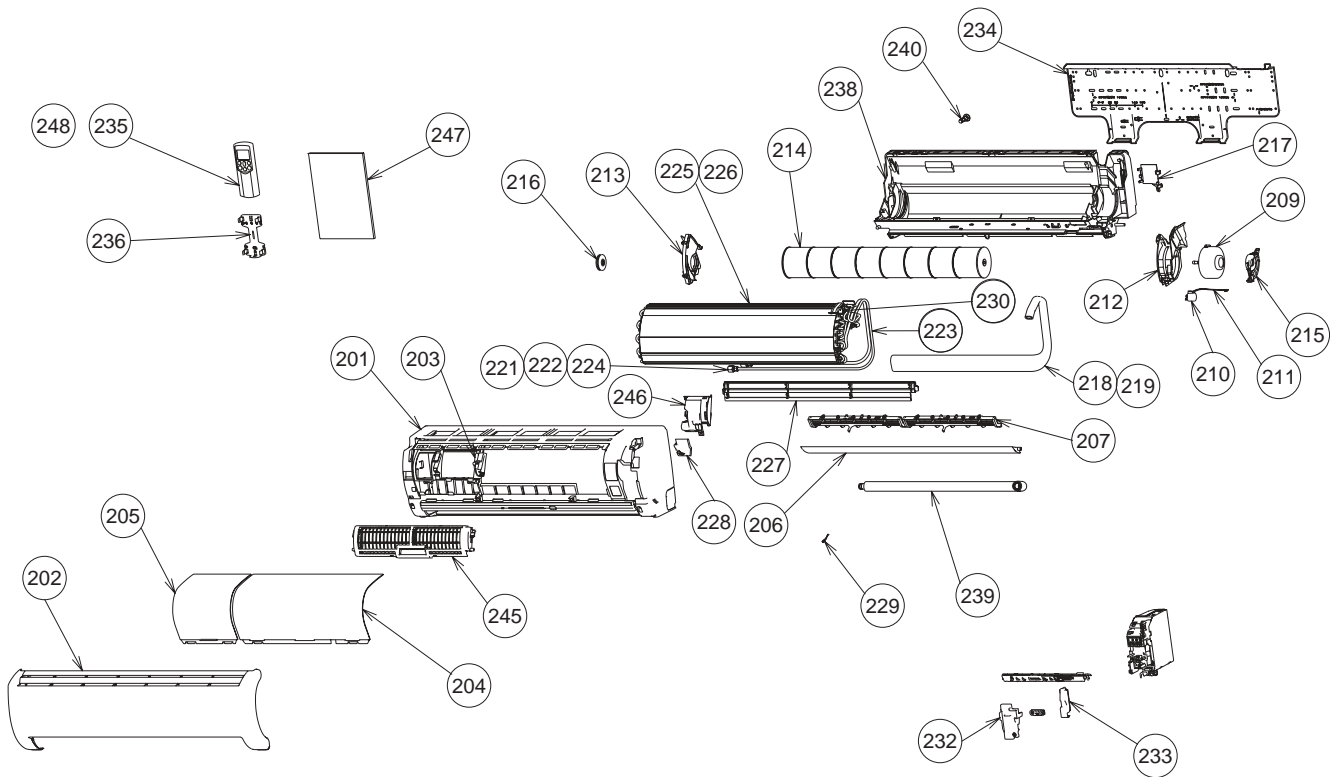

Location No.	Part No.	Description
201	43005611	PANEL ASS'Y, FRONT
202	43005610	GRILLE, AIR INLET
203	4301V052	PLATE, FIX
204	43080512	FILTER, AIR
205	43080521	FILTER, AIR
206	43009675	LOUVER, HORIZONTAL
207	43009649	LOUVER, VERTICAL
209	4302C060	MOTOR, FAN
210	4302C029	MOTOR, LOUVER
211	4306A024	CORD, MOTOR, LOUVER
212	43039363	BAND, MOTOR, LEFT
213	43039321	BASE, BEARING
214	43020315	FAN, CROSS FROW
215	43039314	BAND, MOTOR
216	43020253	BEARING
217	4301V028	HOLDER, PIPE
218	43049701	PIPE, SHIELD (*1)
219	43049698	PIPE, SHIELD (*2)
221	43047332	PIPE, SUCTION (*2)
222	43047334	PIPE, SUCTION (*1)

Location No.	Part No.	Description
223	43049674	SPRING, SUCTION (*1)
224	43047331	PIPE, DELIVERY
225	43044788	EVAPORATOR (*2)
226	43044789	EVAPORATOR (*1)
227	43039324	GUIDE, DRAIN
228	43049728	GUIDE, DRAIN, LEFT
229	43019904	HOLDER, SENSOR
230	43049715	HOLDER, EVAPORATOR, RIGHT
232	43062256	COVER, TERMINAL
233	43062247	COVER, LEAD
234	43082290	PLATE, INSTALLATION
235	4306S577	REMOTE CONTROLLER (Heat pump models)
236	43083071	HOLDER, REMOTE, COMTRROLLER
238	43003301	BODY ASS'Y, BACK
239	43070187	HOSE, DRAIN
240	43079268	CAP, DRAIN
245	43080516	ELECTRICAL AIR PURIFYING FILTER
246	43080518	GENERATOR, ASS'Y HV
247	4308N505	OWNER'S MANUAL
248	4306S578	REMOTE CONTROLLER (Cooling-only models)

(\*1) RAS-B16EKVP-E, RAS-M16EKVP-E

(\*2) RAS-B10EKVP-E, RAS-B13EKVP-E, RAS-M10EKVP-E, RAS-M13EKVP-E

## Indoor Unit (2)

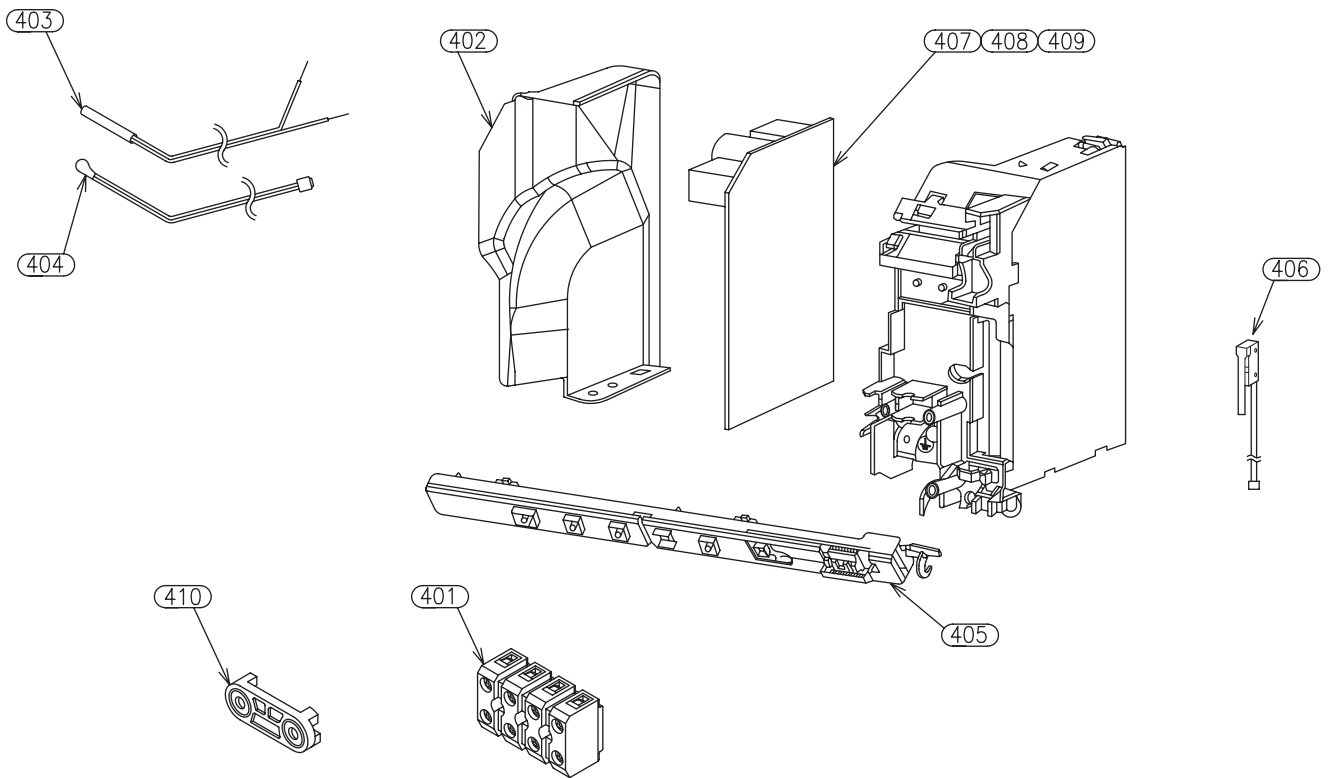

Location No.	Part No.	Description
401	4306A123	TERMINAL BLOCK, 2P
402	43062189	COVER, E-PARTS
403	43050382	SENSOR, TC (F6)
404	43050400	SENSOR, TA
405	4306S484	P.C. BOARD ASS'Y, WRS-LED
406	43051343	SW-MICRO ASS'Y
407	4306S609	PC BOARD ASS'Y (B10EKVP-E, M10EKVP-E)
408	4306S610	PC BOARD ASS'Y (B13EKVP-E, M13EKVP-E)
409	4306S611	PC BOARD ASS'Y (B16EKVP-E, M16EKVP-E)
410	43067113	CLAMP, CORD

## 13-2. Outdoor Unit

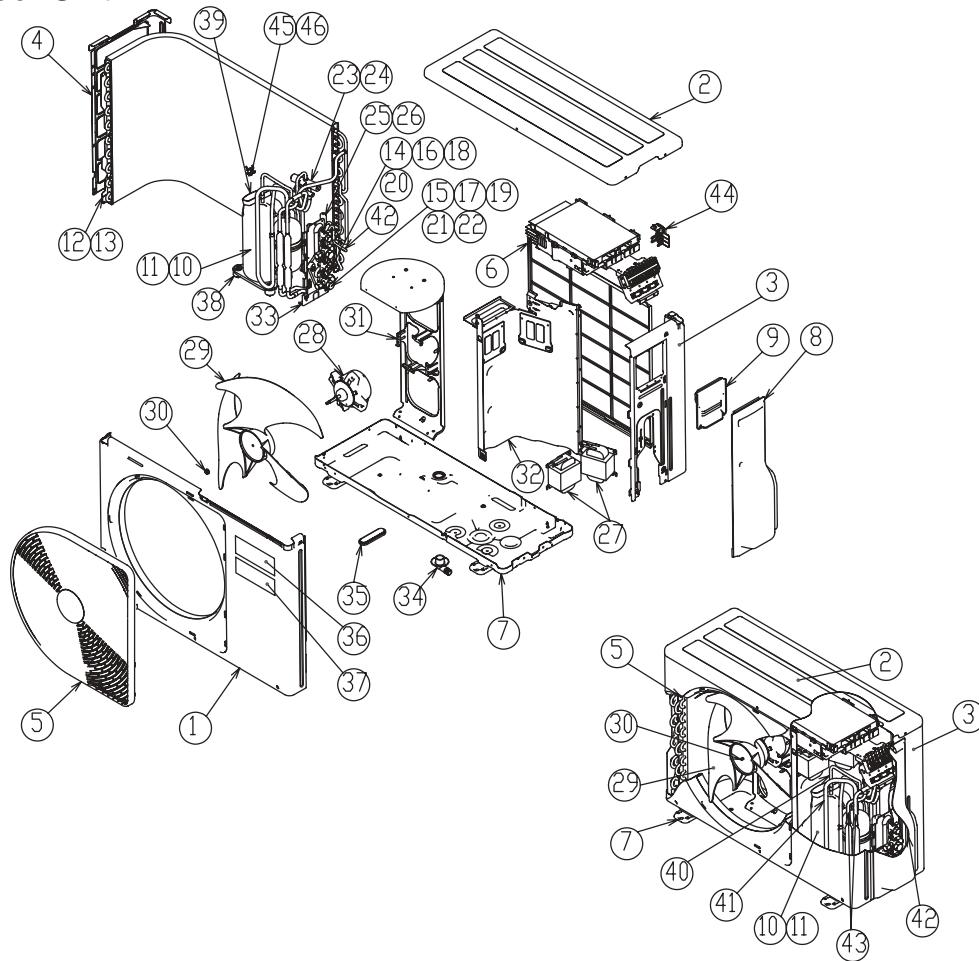

Location No.	Part No.	Description
001	43005619	Cabinet, Front
002	43005616	Cabinet, Upper
003	43005617	Cabinet, Side, Right
004	43005569	Cabinet, Side, Left
005	4301V035	Guard, Fan
006	4301V053	Guard, Fin
007	43042483	Base Assy
008	43119471	Cover, Valve, Packed
009	43062230	Cover, Wiring, Assy
010	43041631	Compressor DA111A1F-20F1 (M14EAV-E , M14EACV-E)
011	43041629	Compressor DA130A1F-25F (M18EAV-E , M18EACV-E)
012	4314G177	Condenser Assy (M14EAV-E , M14EACV-E)
013	43043733	Condenser Assy (M18EAV-E , M18EACV-E)
014	43046392	Valve, Packed, 6.35
015	43046391	Valve, Packed, 9.52
016	43147196	Bonnet, 1/4inch
017	43047401	Bonnet, 3/8inch
018	43047653	Nut, Flare, 6.35
019	43047654	Nut, Flare, 9.52
020	43047657	Cap, Valve, Packed, 6.35
021	43047658	Cap, Valve, Packed, 6.35
022	43047651	Cap, Charge, Port
023	43046439	Valve, 4way, STF-0108Z (M14EAV-E , M18EAV-E)
024	43046348	Coil, Solenoid (M14EAV-E , M18EAV-E)

Location No.	Part No.	Description
025	43046429	Valve, PMV, CAM-B22YGTF-2
026	43046411	Coil, PMV, CAM-MD12TF-1
027	43058270	Reactor
028	4302C048	Motor, Fan, ICF-140-43-4
029	43020329	Fan, Propeller, PJ421
030	43047667	Nut, Flange
031	43039387	Base, Motor
032	43104184	Plate, Partition
033	43004230	Plate, Fix, Valve, Packed
034	43032441	Nipple, Drain (M14EAV-E , M18EAV-E)
035	43089160	Cap, Waterproof (M14EAV-E , M18EAV-E)
036	4301P703	Mark, Toshiba
037	4301P729	Mark, Inverter
038	43049749	Rubber, Cushion
039	43062176	Sleeve, Flag
040	43063321	Holder, Sensor, φ4, 8-9.52 (Heat pump models: TD, TGa, TGb) (Cooling-only models: TD)
041	43063322	Holder, Sensor, φ6, 11.4-12.7 (TS)
042	43063325	Holder, Sensor, φ6, 6.35-8 (Heat pump models: TE)
043	43063320	Holder, Sensor, φ6, 8-9.52 (Cooling-only models: TGa, TGb)
044	43063339	Holder, Sensor, (TO)
045	43050407	Thermostat, Bimetal
046	43063317	Holder, Thermostat

### 13-3. P.C. Board Layout

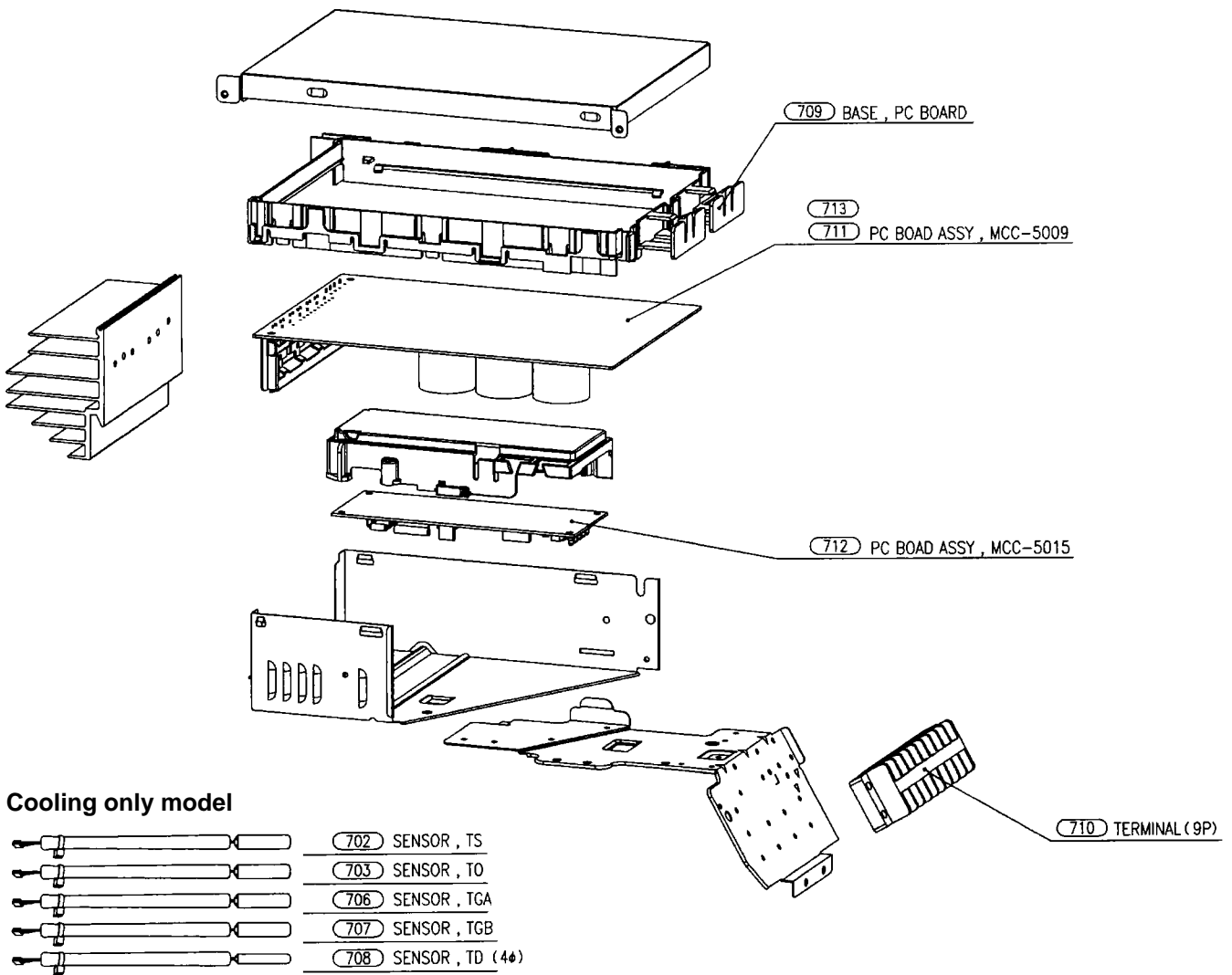

#### Heat pump model

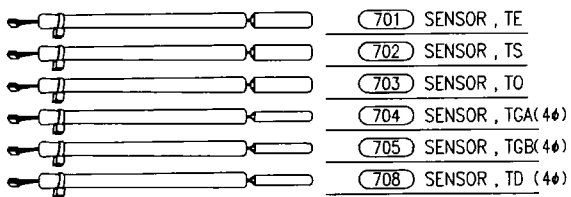

Location No.	Part No.	Description
701	43050412	Sensor , (Heat pump)
702	43050413	Sensor , TS
703	43050415	Sensor , TO
704	43050418	Sensor , TGA(Heat pump)
705	43050419	Sensor , TGB(Heat pump)
706	43050416	Sensor , TGA(Cooling-only)

Location No.	Part No.	Description
707	43050417	Sensor , TGB(Cooling-only)
708	43050354	Sensor , TD
709	43062228	Base , PC Board
710	4306A027	Terminal Block (9P)
711	4306S645	PC Board Assy , MCC-5009 (M14EAV-E, M14EACV-E)
712	4306S646	PC Board Assy , MCC-5015
713	4306S667	PC Board Assy , MCC-5009 (M18EAV-E, M18EACV-E)

# Cord Heater Installation Work

Applicable Models: RAS-10EAVP-E, RAS-13EAVP-E, RAS-16EAVP-E

## 1. Required parts for installation work (Recommendation)

No.	Part name	Q'ty	Specifications/Vendor	Remarks
1	Cord heater	1	Drain line heaters CSC2 (1.5m, 40W/m) by Flexelec com. (Please go to the following URL.) <a href="http://www.flexelec.com">http://www.flexelec.com</a>	Procured locally
2	Thermostat	1	US-622AXRLQE by ASAH KEIKI Operating temperature: on $4 \pm 4^{\circ}\text{C}$ , off $15 \pm 3^{\circ}\text{C}$ A thermostat holder is incorporated with a thermostat in the package. (Please go to the following URL.) <a href="http://www.asahikeiki.co.jp/product/product.html">http://www.asahikeiki.co.jp/product/product.html</a> On self-responsibility, you can use a product manufactured by other company (For example, Texas Instruments) if its characteristics are equivalent to those of ASAH KEIKI. However, when the shape of the thermostat holder is different from that of ASAH KEIKI, apply some treatment to No.14 thermostat fixing plate and then fix the holder.	Procured locally
3	Fuse	1	ES3-5000, 250V / 5A by NAGASAWA Electric Co. (Please go to the following URL.) <a href="http://www.nagasawa-el.co.jp/">http://www.nagasawa-el.co.jp/</a> On self-responsibility, you can use a product manufactured by other company if its characteristics are equivalent to those of NAGASAWA Electric Co.	Procured locally
4	Fuse holder	1	GM1H-02 by NAGASAWA Electric Co. (Please go to the following URL.) <a href="http://www.nagasawa-el.co.jp/">http://www.nagasawa-el.co.jp/</a> On self-responsibility, you can use a product manufactured by other company if its characteristics are equivalent to those of NAGASAWA Electric Co.	Procured locally
5	P-shape clamp	13	Use heat-resistance, weatherproof and non-hydrolytic type. Material: 4-fluorinated ethylene copolymer Harness diameter: $\varnothing 5.9$ Use equivalence with the above specifications. 11 pieces are used to fix the cord heater to the outdoor unit base plate. One piece is used to fix the power cord to the thermostat fixing plate . One piece is used to fix the power cord to the terminal fixing plate.	Procured locally
6	P-shape clamp	1	Use heat-resistance, weatherproof and non-hydrolytic type. Material: 4-fluorinated ethylene copolymer Harness diameter: $\varnothing 9.1$ Use equivalence with the above specifications. One piece is used to fix the cord heater to the outdoor unit base plate.	Procured locally
7	Screw	12	Self-tapping screw type-B $\varnothing 4 \times 6\text{mm}$ , truss head, stainless These screws are used to fix the cord heater to the outdoor unit base plate with P-shape clamp.	Procured locally
8	Screw	4	Self-tapping screw type-B $\varnothing 4 \times 8\text{mm}$ , truss head, stainless Two screws are used to fix the thermostat fixing plate to the side cabinet (R). One screw is used to fix the power cord to the thermostat fixing plate. One screw is used to fix the power cord to the terminal fixing plate.	Procured locally
9	Screw	2	Self-tapping screw type-B $\varnothing 3.5 \times 6\text{mm}$ , pan head These screws are used to fix the thermostat to the thermostat fixing plate with the thermostat holder.	Procured locally
10	Faston	2	#250 They are used for the connecting part to the thermostat.	Procured locally
11	Sleeve for Faston	2	UL sleeve for #250	Procured locally
12	Close-end connector	2	Use the most appropriate connector with the power cord diameter.	Procured locally

No.	Part name	Q'ty	Specifications/Vendor	Remarks
13	Power cord	1	2-cores x 0.75mm <sup>2</sup> or more, H05RN-F	Procured locally
14	Thermostat fixing plate	1	Material: SGCC-Z08, Board thickness: 0.8t	Procured locally (Drawing attached)
15	PVC tube	1	Inside diameter Ø8 x outside diameter Ø11 x 70 mm	Procured locally
16	Shield tube	1	Inside diameter Ø18 x outside diameter Ø26 x 70 mm Material: Polyethylene foam	Procured locally
17	Bundling tie	1	Bundling tie for securing the wires Material: 6/6 nylon	Procured locally

**NOTE:** The parts on the above table are recommended parts.

## 2. Required tools for installation work

No.	Part name	Specifications	Usage
1	Plus screwdriver		It is used for disassembling and assembling of each cabinet.
2	Wrench		It is used for disassembling and assembling of compressor fixing nuts.
3	Motor drill	Drill diameter: Ø3.2 and Ø5.0	It is used to make the additional holes on the base or the side cabinet (R).
4	Faston crimping tool	Fixing jig for #250	
5	Close-end connector crimping tool		
6	Cutting plier		
7	Stripper		
8	Cutter knife		
9	Insulation tape		
10	Metal-cutting shears		It is used to process the side cabinet (L).

### 3. Cord heater installation wiring diagram

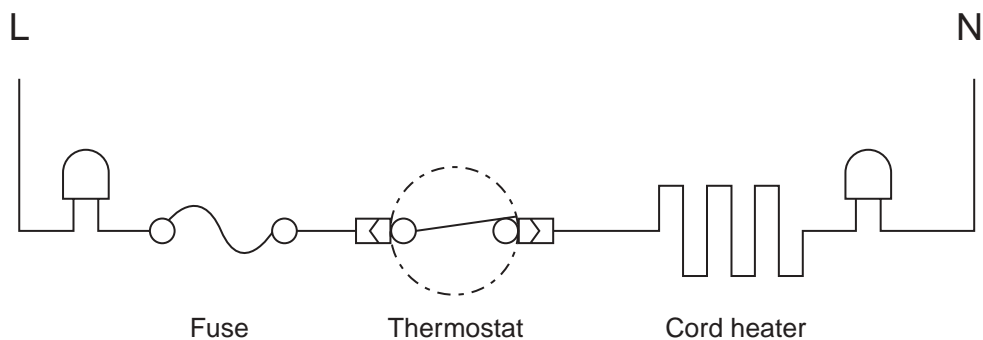

\* Be sure to connect the fuse and the thermostat to LIVE side of the cord heater.

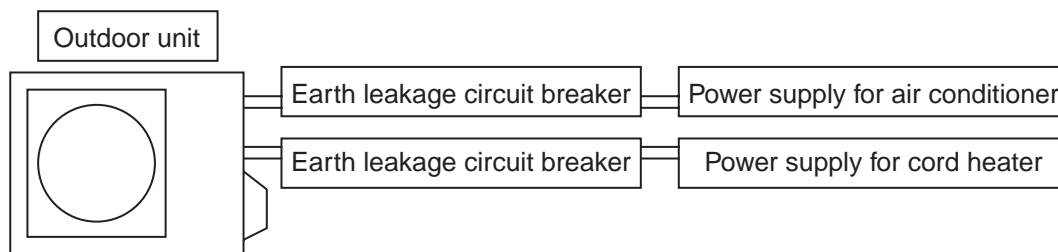

#### NOTE:

Separate the cord heater power from the air conditioner power, and connect it to its exclusive breaker.



By doing so, the power consumption can be decreased because the breaker can be turned off if there is no possibility of freezing of the base plate in cooling operation, etc.



When the cord heater power is connected to the inverter P.C. board assembly or others without connected to the exclusive breaker, the control P.C. board of the inverter assembly may cause a failure.

When the cord heater has been mounted on a base plate, do not mount the water-proof cap and drain nipple which are provided with the outdoor unit on the base plate.

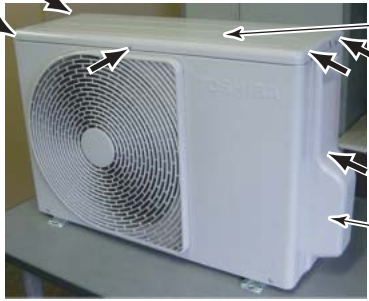
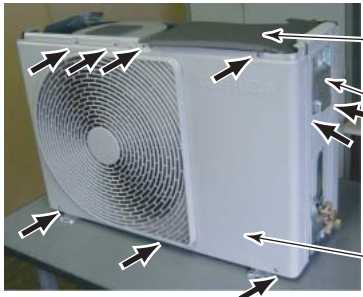
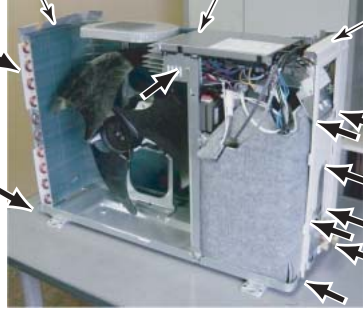

### 4. Cord heater installation work procedure

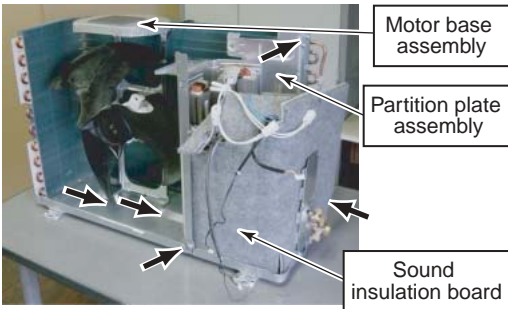
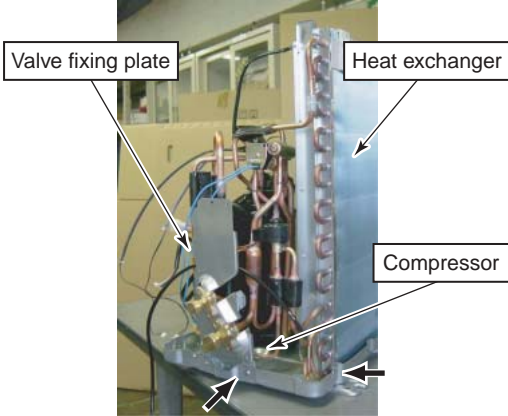
No.	Photo / Explanatory diagram	Procedure																																								
1	<p>Remove each cabinet, inverter assembly, motor base assembly, and partition board assembly.                      * Do not damage the electric parts such as cables, connectors, etc. while this work.</p>																																									
1-1	 <p>Upper cabinet</p> <p>Valve cover</p>	<p>Remove the upper cabinet and the valve cover.</p> <p>Related parts / Screws list</p> <table border="1" data-bbox="839 445 1441 591"> <thead> <tr> <th rowspan="2">Part name</th> <th colspan="2">Used screw</th> </tr> <tr> <th>Screw type</th> <th>Quantity</th> </tr> </thead> <tbody> <tr> <td>Upper cabinet</td> <td>Ø4 × 8</td> <td>5</td> </tr> <tr> <td>Valve cover</td> <td>Ø4 × 1</td> <td>1</td> </tr> </tbody> </table>	Part name	Used screw		Screw type	Quantity	Upper cabinet	Ø4 × 8	5	Valve cover	Ø4 × 1	1																													
Part name	Used screw																																									
	Screw type	Quantity																																								
Upper cabinet	Ø4 × 8	5																																								
Valve cover	Ø4 × 1	1																																								
1-2	 <p>Water-proof cover</p> <p>Wiring cover</p> <p>Front cabinet</p>	<p>Remove the front cabinet, the wiring cover and the water-proof cover.</p> <p>Related parts / Screws list</p> <table border="1" data-bbox="839 851 1441 996"> <thead> <tr> <th rowspan="2">Part name</th> <th colspan="2">Used screw</th> </tr> <tr> <th>Screw type</th> <th>Quantity</th> </tr> </thead> <tbody> <tr> <td>Front cabinet</td> <td>Ø4 × 8</td> <td>7</td> </tr> <tr> <td>Wiring cover</td> <td>Ø4 × 8</td> <td>2</td> </tr> </tbody> </table>	Part name	Used screw		Screw type	Quantity	Front cabinet	Ø4 × 8	7	Wiring cover	Ø4 × 8	2																													
Part name	Used screw																																									
	Screw type	Quantity																																								
Front cabinet	Ø4 × 8	7																																								
Wiring cover	Ø4 × 8	2																																								
1-3	 <p>Side cabinet (L)</p> <p>Inverter assembly</p> <p>Side cabinet (R)</p>	<p>Remove the side cabinet (R/L) and the inverter assembly.</p> <p>Related parts / Screws list</p> <table border="1" data-bbox="839 1202 1441 1384"> <thead> <tr> <th rowspan="2">Part name</th> <th colspan="2">Used screw</th> </tr> <tr> <th>Screw type</th> <th>Quantity</th> </tr> </thead> <tbody> <tr> <td>Side cabinet (R)</td> <td>Ø4 × 8</td> <td>7</td> </tr> <tr> <td>Side cabinet (L)</td> <td>Ø4 × 8</td> <td>3</td> </tr> <tr> <td>Inverter assembly</td> <td>Ø4 × 8</td> <td>1</td> </tr> </tbody> </table>	Part name	Used screw		Screw type	Quantity	Side cabinet (R)	Ø4 × 8	7	Side cabinet (L)	Ø4 × 8	3	Inverter assembly	Ø4 × 8	1																										
Part name	Used screw																																									
	Screw type	Quantity																																								
Side cabinet (R)	Ø4 × 8	7																																								
Side cabinet (L)	Ø4 × 8	3																																								
Inverter assembly	Ø4 × 8	1																																								
1-4		<p>Remove the inverter assembly.</p> <table border="1" data-bbox="839 1554 1441 1951"> <thead> <tr> <th>No.</th> <th>Part name</th> <th>Connector No.</th> <th>Connector color</th> </tr> </thead> <tbody> <tr> <td>1</td> <td>TE sensor</td> <td>CN600</td> <td>White</td> </tr> <tr> <td>2</td> <td>TD sensor</td> <td>CN601</td> <td>White</td> </tr> <tr> <td>3</td> <td>TO sensor</td> <td>CN602</td> <td>White</td> </tr> <tr> <td>4</td> <td>TS sensor</td> <td>CN603</td> <td>White</td> </tr> <tr> <td>5</td> <td>4-way valve coil</td> <td>CN701</td> <td>Yellow</td> </tr> <tr> <td>6</td> <td>PMV coil</td> <td>CN700</td> <td>White</td> </tr> <tr> <td>7</td> <td>Fan motor</td> <td>CN300</td> <td>White</td> </tr> <tr> <td>8</td> <td>Compressor lead</td> <td>(Intermediate connector)</td> <td>White</td> </tr> <tr> <td>9</td> <td>Reactor (2 pieces.)</td> <td>(Intermediate connector)</td> <td>White</td> </tr> </tbody> </table>	No.	Part name	Connector No.	Connector color	1	TE sensor	CN600	White	2	TD sensor	CN601	White	3	TO sensor	CN602	White	4	TS sensor	CN603	White	5	4-way valve coil	CN701	Yellow	6	PMV coil	CN700	White	7	Fan motor	CN300	White	8	Compressor lead	(Intermediate connector)	White	9	Reactor (2 pieces.)	(Intermediate connector)	White
No.	Part name	Connector No.	Connector color																																							
1	TE sensor	CN600	White																																							
2	TD sensor	CN601	White																																							
3	TO sensor	CN602	White																																							
4	TS sensor	CN603	White																																							
5	4-way valve coil	CN701	Yellow																																							
6	PMV coil	CN700	White																																							
7	Fan motor	CN300	White																																							
8	Compressor lead	(Intermediate connector)	White																																							
9	Reactor (2 pieces.)	(Intermediate connector)	White																																							

No.	Photo / Explanatory diagram	Procedure														
1-5		<p>Remove the motor base assembly, partition plate assembly and the sound insulation board.</p> <p>Related parts / Screws list</p> <table border="1" data-bbox="802 331 1441 528"> <thead> <tr> <th rowspan="2">Part name</th> <th colspan="2">Used screw</th> </tr> <tr> <th>Screw type</th> <th>Quantity</th> </tr> </thead> <tbody> <tr> <td>Motor base assembly (Including motor and fan)</td> <td>Ø4 × 8</td> <td>2</td> </tr> <tr> <td>Partition plate assembly (Including reactor)</td> <td>Ø4 × 8</td> <td>3</td> </tr> </tbody> </table>	Part name	Used screw		Screw type	Quantity	Motor base assembly (Including motor and fan)	Ø4 × 8	2	Partition plate assembly (Including reactor)	Ø4 × 8	3			
Part name	Used screw															
	Screw type	Quantity														
Motor base assembly (Including motor and fan)	Ø4 × 8	2														
Partition plate assembly (Including reactor)	Ø4 × 8	3														
1-6		<p>Remove the fixing screws of the heat exchanger and the valve fixing plate. Remove the compressor fixing bolt.</p> <p>Related parts / Screws list</p> <table border="1" data-bbox="802 719 1441 902"> <thead> <tr> <th rowspan="2">Part name</th> <th colspan="2">Used screw</th> </tr> <tr> <th>Screw type</th> <th>Quantity</th> </tr> </thead> <tbody> <tr> <td>Heat exchanger</td> <td>Ø4 × 8</td> <td>1</td> </tr> <tr> <td>Valve fixing plate</td> <td>Ø4 × 8</td> <td>1</td> </tr> <tr> <td>Compressor</td> <td>bolt</td> <td>3</td> </tr> </tbody> </table>	Part name	Used screw		Screw type	Quantity	Heat exchanger	Ø4 × 8	1	Valve fixing plate	Ø4 × 8	1	Compressor	bolt	3
Part name	Used screw															
	Screw type	Quantity														
Heat exchanger	Ø4 × 8	1														
Valve fixing plate	Ø4 × 8	1														
Compressor	bolt	3														
1-7		<p>As shown in the left figure, remove the set of refrigeration cycle assembly from the outdoor unit base plate.</p> <p>* In this time, work attentively so that the cycle pipes are not damaged by dent or deformation. Apply protective measures to pipes if necessary.</p>														

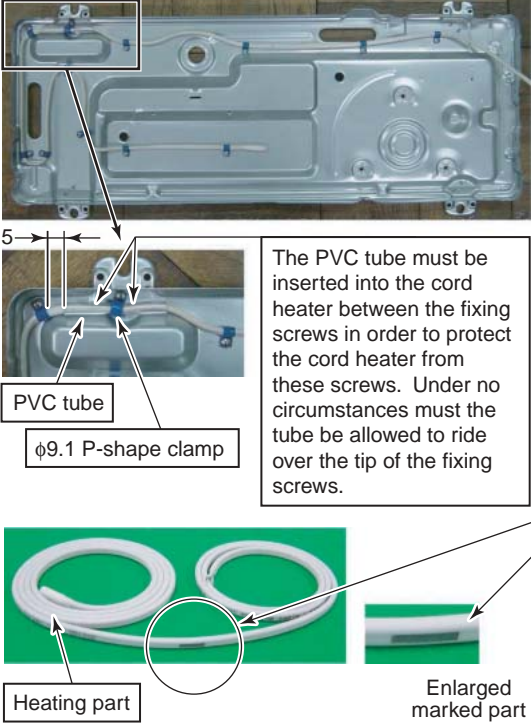
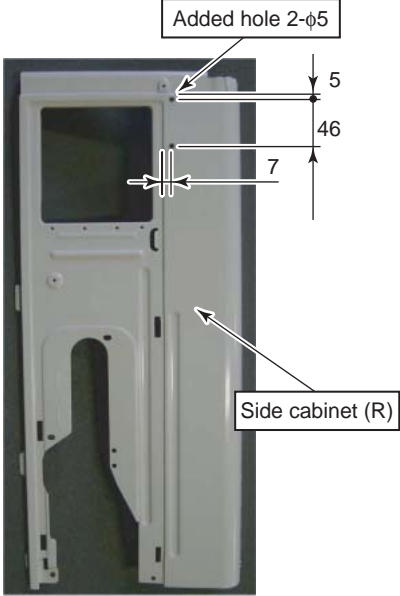
No.	Photo / Explanatory diagram	Procedure
2	<p>Cord heater installation work</p> <p>Drill a hole on the outdoor unit base plate, and fix the cord heater to the outdoor unit base plate using P-shape clamp.</p> <p>Connect the cord heater cables.</p>	
2-1	<p>Using a motor drill, etc., drill Ø3.2 holes on the outdoor unit base plate. (12 positions) See Appendix-10 for the additional hole positions.</p> <p>These holes are used to fix the cord heater to the outdoor unit base plate with P-shape clamp.</p>	
2-2	 <p>The PVC tube must be inserted into the cord heater between the fixing screws in order to protect the cord heater from these screws. Under no circumstances must the tube be allowed to ride over the tip of the fixing screws.</p> <p>Labels: PVC tube, φ9.1 P-shape clamp, Heating part, Enlarged marked part.</p>	<p>Insert the PVC tube into the cord heater.</p> <p>This tube is designed to protect the cord heater from the fixing screws used to secure the anchoring feet.</p> <p>As shown in the left figure, install the cord heater (1.5m) to the outdoor unit base plate by using P-shape clamp and screws (Self-tapping screw type-B Ø4 × 6mm, stainless).</p> <p>Pay attention to the direction of P-shape clamp so that it is set to the same direction in the left figure.</p> <ul style="list-style-type: none"> <li>* If the drain port is frozen due to installation status, etc., draw around the cord heater so that the end part of the heater is inserted into the drain port. In this case, add some fixing positions to fix the cord heater surely.</li> <li>* The end part from the marked part of the cord heater heats up. When there is the heating part near the electric parts box, a fire may generate. Be sure to set the heating part on the outdoor unit base plate at the fan room side or near it. (within 20cm from the outdoor unit base plate)</li> <li>* Be careful that the cord heater does not hit the fan. Fix the cord heater without any loosening or sag.</li> </ul>
2-3	 <p>Labels: Added hole 2-φ5, Side cabinet (R).</p>	<p>Drill a hole on the side cabinet (R) for fixing the thermostat fixing plate.</p> <p>Ø5 hole at two positions</p> <p>When drilling a hole on the side cabinet (R), be sure not to damage the cabinet.</p>

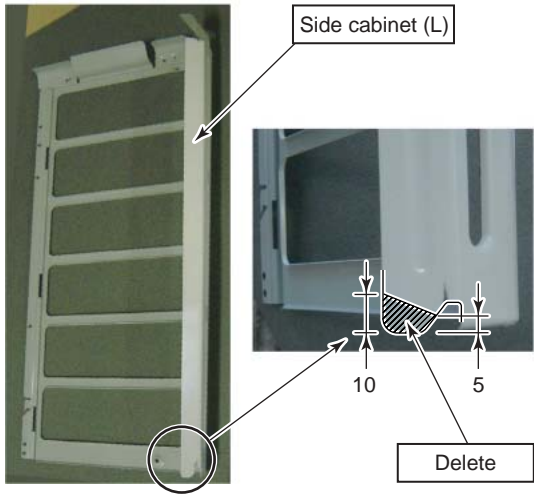
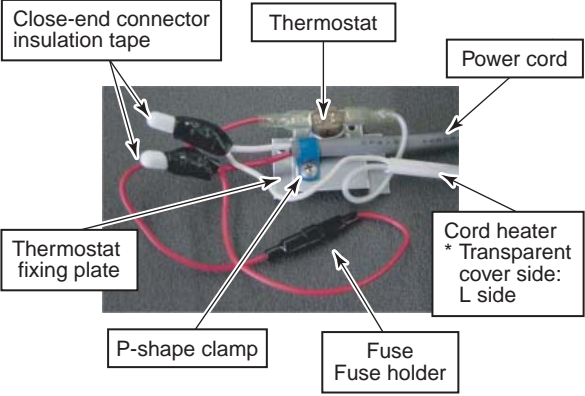
No.	Photo / Explanatory diagram	Procedure
2-4	 <p>Side cabinet (L)</p> <p>Delete</p>	<p>Rework the side cabinet (L) to remove part of it.</p> <p>The area to be removed is indicated by the shaded lines in the left figure.</p> <p>After removing part of the side cabinet (L), deburr the edges of the side cabinet (L).</p>
2-5	 <p>Close-end connector insulation tape</p> <p>Thermostat</p> <p>Power cord</p> <p>Thermostat fixing plate</p> <p>P-shape clamp</p> <p>Fuse Fuse holder</p> <p>Cord heater * Transparent cover side: L side</p>	<p>Perform end process and bundling of each cable.</p> <p>Using fixing screws (Self-tapping screw type-B Ø3.5 × 6mm), fix the thermostat to the thermostat fixing plate.</p> <p>Perform end process for various lead cables and connect them according to the wiring diagram.</p> <p>Attach #250 Faston and UL-approved sleeves each to the end of lead cables which are connected to the thermostat.</p> <p>Using insulation tape, apply protective measures to the connected parts by the close-end connectors.</p> <p>Using P-shape clamp and the screws (Self-tapping screw type-B Ø4 × 8mm), fix the power cord to the thermostat fixing plate.</p> <p>When the power cord size does not match with P-shape clamp, procure the most appropriate one at the local site.</p>

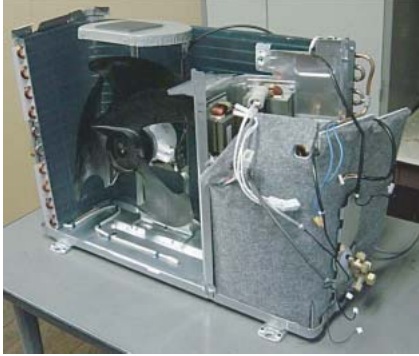
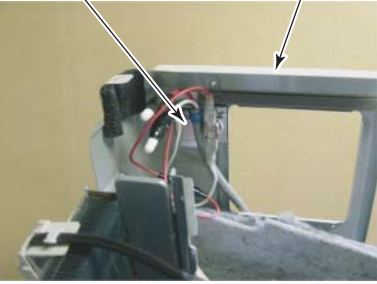
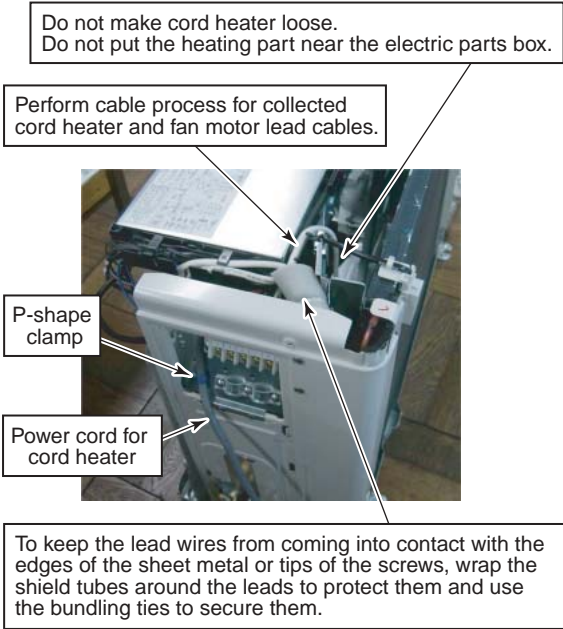
No.	Photo / Explanatory diagram	Procedure
3	<p><b>Assembly</b></p> <p>Return a set of the refrigeration cycle assembly into the outdoor unit base plate and reassemble sound insulation board, partition plate assembly, fan motor assembly, and side cabinet (R/L) as original. Fix the thermostat fixing plate to the side cabinet (R), built in the inverter assembly, and then connect various cables. After then, incorporate front cabinet, upper cabinet, wiring cover, and valve cover as before.</p>	
3-1		<p>Return a set of the refrigeration cycle assembly into the outdoor unit base plate, and assemble sound insulation board, partition plate assembly, fan motor assembly, and side cabinet (R/L) as original.</p>
3-2		<p>Using screws (Self-tapping screw type-B Ø4 × 8mm, stainless), fix the thermostat fixing plate to the side cabinet (R).</p>
3-3		<p>After incorporating the inverter assembly as before, furthermore perform cable process for cord heater and power cord.</p> <p>For the cord heater, perform cable process so that there is no looseness or sag at the fan side.</p> <p>Perform cable process for the cord heater together with the fan motor lead cable, and collect the remained part of cables at cable process part of the inverter.</p> <p>Secure the power cord for the cord heater to the terminal block mounting plate using the P-shape clamp, and pull it out from the wiring area of the side cabinet (R).</p> <p>* Check that there is the marked part of the cord heater on the outdoor unit base plate or near it.</p> <p>When there is the heating part near the electric parts box, a fire may generate.</p> <p>Since the lead wires connected to the cord heater and thermostat may come into contact with the edges of the sheet metal or tips of the screws, wrap the shield tubes around the leads to protect them and use the bundling ties to secure them.</p>
3-4	<p>Incorporate front cabinet, upper cabinet, wiring cover, water-proof cover and valve cover as before.</p>	
4	<p>In installation work, connect power cord for the cord heater to another breaker separated from one for power cord of the air conditioner.</p>	

## 5. Drawing of thermostat fixing plate

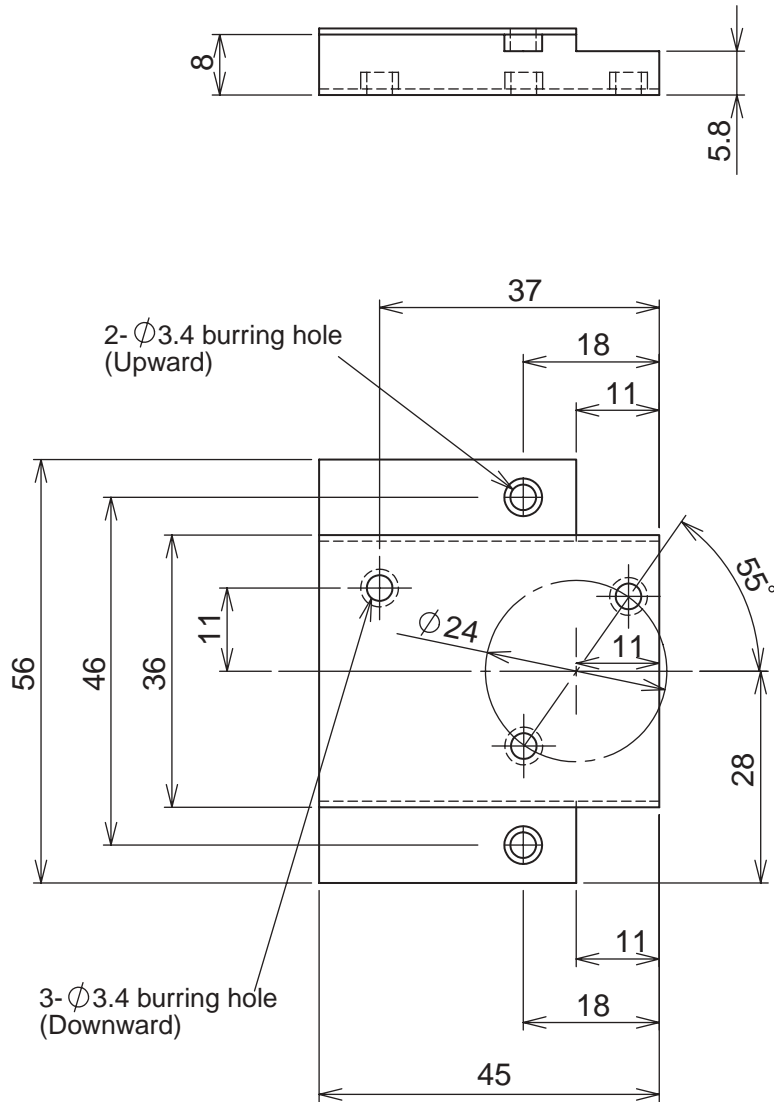

**Material: SGCC-Z08, Thickness: 0.8t**



6. Diagram showing positions  $\phi 3.2$  mm holes to be additionally drilled in base plate

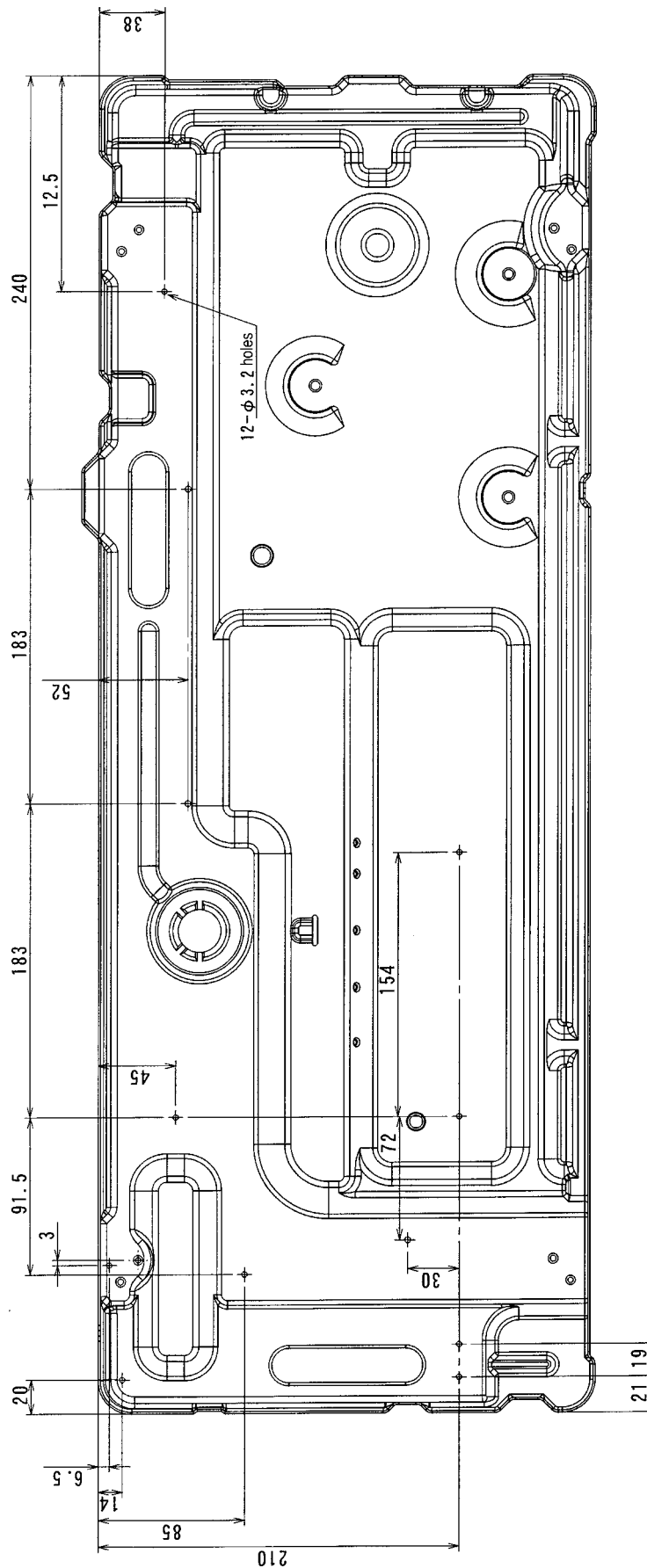

# **TOSHIBA CARRIER CORPORATION**

336 TADEHARA FUJI-SHI, SHIZUOKA-KEN, 416-8521, JAPAN



## Free Manuals Download Website

<http://myh66.com>

<http://usermanuals.us>

<http://www.somanuals.com>

<http://www.4manuals.cc>

<http://www.manual-lib.com>

<http://www.404manual.com>

<http://www.luxmanual.com>

<http://aubethermostatmanual.com>

Golf course search by state

<http://golfingnear.com>

Email search by domain

<http://emailbydomain.com>

Auto manuals search

<http://auto.somanuals.com>

TV manuals search

<http://tv.somanuals.com>