

TOSHIBA

FILE NO. A03-002

SERVICE MANUAL

<OWNER'S MANUAL/INSTALLATION MANUAL>

AIR-CONDITIONER

SPLIT TYPE

RAV-SM1100AT-E/RAV-SM1400AT-E
RAV-SM1100UT-E/RAV-SM1400UT-E

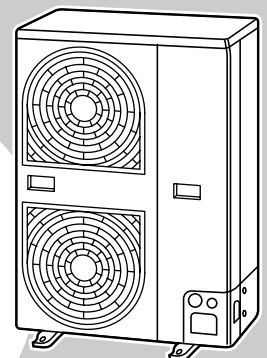
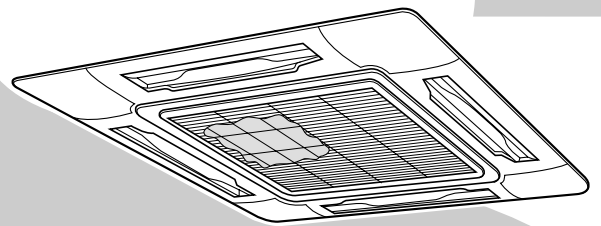

PRINTED IN JAPAN, Aug., 2003 

ADOPTION OF NEW REFRIGERANT

This Air Conditioner is a new type which adopts a new refrigerant HFC (R410A) instead of the conventional refrigerant R22 in order to prevent destruction of the ozone layer.

WARNING

Cleaning of the air filter and other parts of the air filter involves dangerous work in high places, so be sure to have a service person do it. Do not attempt it yourself. The cleaning diagram for the air filter is there for the service person, and not for the customer.

Outdoor Unit --- RAV-SM1100AT-E/RAV-SM1400AT-E

INSTALLATION MANUAL

1 PRECAUTIONS FOR SAFETY	1	5 EVACUATING	9
2 ACCESSORY AND REFRIGERANT	3	6 ELECTRICAL WORK	11
3 SELECTION OF INSTALLATION	3	7 FINAL INSTALLATION CHECKS	12
4 REFRIGERANT PIPING	7		

Indoor Unit --- RAV-SM1100UT-E/RAV-SM1400UT-E

4-Way Air Discharge Cassette Type --- OWNER'S MANUAL

ACCESSORIES (SOLD SEPARATELY)	14	ADJUSTMENT OF WIND DIRECTIONd	21
PRECAUTIONS FOR SAFETY	14	TIMER OPERATION	22
PARTS NAME	16	MAINTENANCE	24
PARTS NAME OF REMOTE CONTROLLER	17	AIR CONDITIONER OPERATIONS AND PERFORMANCE .	25
CORRECT USAGE	19	RE-INSTALLATION	26
AUTOMATIC OPERATION (Auto Changeover)	20	TROUBLES AND CAUSES	26

4-Way Air Discharge Cassette Type --- INSTALLATION MANUAL

Accessory parts and Parts to be procured locally	28	5 EVACUATING	39
1 PRECAUTIONS FOR SAFETY	29	6 ELECTRICAL WORK	41
2 SELECTION OF INSTALLATION PLACE	31	7 TEST RUN	44
3 DRAIN PIPING WORK	36	8 TROUBLESHOOTING	45
4 REFRIGERANT PIPING	38	9 MAINTENANCE	46

Accessories ---

OWNER'S MANUAL

REMOTE CONTROLLER FOR AIR CONDITIONER (SPLIT TYPE) <Wireless Type>	TCB-AX21U (W)-E	48
WEEKLY TIMER FOR AIR CONDITIONER (SPLIT TYPE) <Program Weekly Timer Type>	RBC-EXW21E	56
REMOTE CONTROLLER FOR AIR CONDITIONER <Simple Operation Type>	RBC-AS21E	62

INSTALLATION MANUAL

Ceiling Panel	RBC-U21PG (W)-E	65
Standard Remote Controller	RBC-AMT21E	67
Simple Remote Controller	RBC-AS21E	68
Program Weekly Timer	RBC-EXW21E	69
Remote sensor	TCB-TC21LE	70
Drain-up Kit for Concealed Duct Type Indoor Unit	TCB-DP11BE	71
Remote Controller Wireless Kit	TCB-AX21U (W)-E	72
Network Adapter for Air Conditioner (Use for Indoor Unit Only)	TCB-PCNT20E	73

1 PRECAUTIONS FOR SAFETY

- Ensure that all Local, National and International regulations are satisfied.
- Read this “PRECAUTIONS FOR SAFETY” carefully before Installation.
- The precautions described below include the important items regarding safety. Observe them without fail.
- After the installation work, perform a trial operation to check for any problem.
Follow the Owner’s Manual to explain how to use and maintain the unit to the customer.
- Turn off the main power supply switch (or breaker) before the unit maintenance.
- Ask the customer to keep the Installation Manual together with the Owner’s Manual.

CAUTION

New Refrigerant Air Conditioner Installation

- **THIS AIR CONDITIONER ADOPTS THE NEW HFC REFRIGERANT (R410A) WHICH DOES NOT DESTROY OZONE LAYER.**

The characteristics of R410A refrigerant are ; easy to absorb water, oxidizing membrane or oil, and its pressure is approx. 1.6 times higher than that of refrigerant R22. Accompanied with the new refrigerant, refrigerating oil has also been changed. Therefore, during installation work, be sure that water, dust, former refrigerant, or refrigerating oil does not enter the refrigerating cycle.

To prevent charging an incorrect refrigerant and refrigerating oil, the sizes of connecting sections of charging port of the main unit and installation tools are charged from those for the conventional refrigerant.

Accordingly the exclusive tools are required for the new refrigerant (R410A).

For connecting pipes, use new and clean piping designed for R410A, and please care so that water or dust does not enter. Moreover, do not use the existing piping because there are problems with pressure-resistance force and impurity in it.

CAUTION

To Disconnect the Appliance from Main Power Supply.

This appliance must be connected to the main power supply by means of a switch with a contact separation of at least 3 mm.

The installation fuse (25A D type ) must be used for the power supply line of this conditioner.

⚠ WARNING

- **Ask an authorized dealer or qualified installation professional to install/maintain the air conditioner.**
Inappropriate installation may result in water leakage, electric shock or fire.
- **Turn off the main power supply switch or breaker before attempting any electrical work.**
Make sure all power switches are off. Failure to do so may cause electric shock.
- **Connect the connecting cable correctly.**
If the connecting cable is connected in a wrong way, electric parts may be damaged.
- **When moving the air conditioner for the installation into another place, be very careful not to enter any gaseous matter other than the specified refrigerant into the refrigeration cycle.**
If air or any other gas is mixed in the refrigerant, the gas pressure in the refrigeration cycle becomes abnormally high and it may resultingly causes pipe burst and injuries on persons.
- **Do not modify this unit by removing any of the safety guards or by by-passing any of the safety interlock switches.**
- **Exposure of unit to water or other moisture before installation may cause a short-circuit of electrical parts.**
Do not store it in a wet basement or expose to rain or water.

- **After unpacking the unit, examine it carefully if there are possible damage.**
- **Do not install in a place that might increase the vibration of the unit.**
- **To avoid personal injury (with sharp edges), be careful when handling parts.**
- **Perform installation work properly according to the Installation Manual.**
Inappropriate installation may result in water leakage, electric shock or fire.
- **When the air conditioner is installed in a small room, provide appropriate measures to ensure that the concentration of refrigerant leakage occur in the room does not exceed the critical level.**
- **Install the air conditioner securely in a location where the base can sustain the weight adequately.**
- **Perform the specified installation work to guard against an earthquake.**
If the air conditioner is not installed appropriately, accidents may occur due to the falling unit.
- **If refrigerant gas has leaked during the installation work, ventilate the room immediately.**
If the leaked refrigerant gas comes in contact with fire, noxious gas may generate.
- **After the installation work, confirm that refrigerant gas does not leak.**
If refrigerant gas leaks into the room and flows near a fire source, such as a cooking range, noxious gas might generate.
- **Electrical work must be performed by a qualified electrician in accordance with the Installation Manual. Make sure the air conditioner uses an exclusive power supply.**
An insufficient power supply capacity or inappropriate installation may cause fire.
- **Use the specified cables for wiring connect the terminals securely fix. To prevent external forces applied to the terminals from affecting the terminals.**
- **Be sure to provide grounding.**
Do not connect ground wires to gas pipes, water pipes, lightning rods or ground wires for telephone cables.
- **Conform to the regulations of the local electric company when wiring the power supply.**
Inappropriate grounding may cause electric shock.
- **Do not install the air conditioner in a location subject to a risk of exposure to a combustible gas.**
If a combustible gas leaks, and stays around the unit, a fire may occur.

Required tools for installation work





- | | |
|----------------------------|----------------------------|
| 1) Philips screw driver | 9) Thermometer |
| 2) Hole core drill (65 mm) | 10) Mega-tester |
| 3) Spanner | 11) Electro circuit tester |
| 4) Pipe cutter | 12) Hexagonal wrench |
| 5) Knife | 13) Flare tool |
| 6) Reamer | 14) Pipe bender |
| 7) Gas leak detector | 15) Level vial |
| 8) Tape measure | 16) Metal saw |

R410A (Special requirement)

- 17) Gauge manifold
(Charge hose : R410A special requirement)
- 18) Vacuum pump
(Charge hose : R410A special requirement)
- 19) Torque wrench
1/4 (17 mm) 16 N•m (1.6 kgf•m)
3/8 (22 mm) 42 N•m (4.2 kgf•m)
1/2 (26 mm) 55 N•m (5.5 kgf•m)
5/8 (15.9 mm) 120 N•m (12.0 kgf•m)
- 20) Copper pipe gauge adjusting projection margin
- 21) Vacuum pump adapter

2 ACCESSORY AND REFRIGERANT

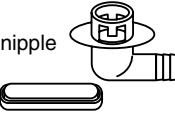
Accessory and Installation Parts

①	 Outdoor unit Installation manual x 1	③	 Protective bush
②	 Drain nipple Waterproof rubber cap	④	 Guard material for passage part

Refrigerant Piping

- Piping kit used for the conventional refrigerant cannot be used.
- Use copper pipe with 0.8 mm or more thickness for Ø9.5 mm.
Use copper pipe with 1.0 mm or more thickness for Ø15.9 mm.
- Flare nut and flare works are also different from those of the conventional refrigerant. Take out the flare nut attached to the main unit of the air conditioner, and use it.

3 SELECTION OF INSTALLATION

Before installation

Be careful to the following items before installation.

Length of refrigerant pipe

Length of refrigerant pipe connected to indoor/outdoor unit	Item
20m or shorter	Addition of refrigerant is unnecessary at the local site.
*21m to 50m	<Addition of refrigerant> Add 40g of refrigerant for every 1m of pipe which exceeds 20m.

* Caution at addition of refrigerant

When the total length of refrigerant pipe exceeds 20m, add 40g/m of refrigerant and the maximum total length of pipe is 50m.

(Max. amount of additional refrigerant is 1200g.)

Charge the refrigerant accurately. Overcharge may cause a serious trouble of compressor.

Air purge

- For air purge, use a vacuum pump.
- Do not use refrigerant charged in the outdoor unit for air purge. (The refrigerant for air purge is not contained in the outdoor unit.)

Electrical cabling

- Be sure to fix the power cables and indoor/outdoor connecting cables with clamps so that they do not contact with the cabinet, etc.

Installation Place

- A place which provides a specified space around the outdoor unit.
- A place where the operation noise and discharged air are not given to your neighbors.
- A place that is not exposed to a strong wind.
- A place that does not block a passage.
- When the outdoor unit is installed in an elevated position, be sure to secure its feet.
- There must be sufficient space for carrying in the unit.
- A place where the drain water does not make any problem.

CAUTION

1. Install the outdoor unit at a place where discharge air is not blocked.
2. When an outdoor unit is installed in a place that is always exposed to a strong wind like a coast or on a high storey of a building, secure a normal fan operation by using a duct or a wind shield.
3. When installing the outdoor unit in a place that is constantly exposed to a strong wind such as the upper stairs or rooftop of a building, apply the windproof measures referring to the following examples.

- 1) Install the unit so that its discharge port faces to the wall of the building. Keep a distance 500 mm or more between the unit and the wall surface.

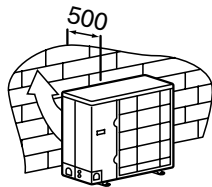

- 2) Supposing the wind direction during the operation season of the air conditioner, install the unit so that the discharge port is set at right angle to the wind direction.

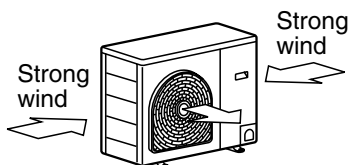

4. Installation in the following places may result in some troubles. Do not install the unit in such places below.
 - A place full of machine oil.
 - A place full of sulphuric gas.
 - A place where high-frequency radio waves are likely to be generated as from audio equipment, welders, and medical equipment.

Necessary Space for Installation

Obstacle at rear side

<Upper side is free>

1. Single unit installation

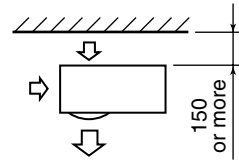

2. Obstacles at both right and left sides.

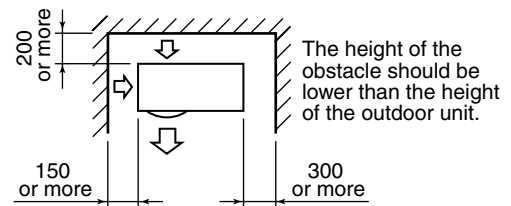

3. Serial installation of two or more units

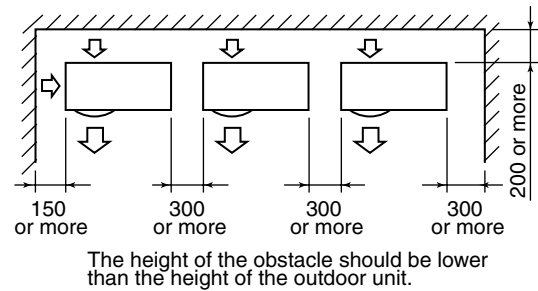

<Obstacle also at the upper side>

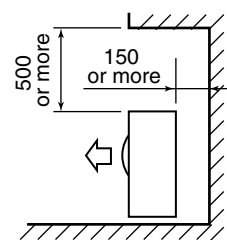

Obstacle at front side

<Upper side is free>

1. Single unit installation

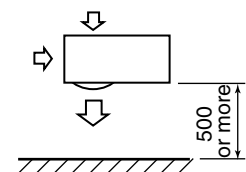

2. Serial installation of two or more units

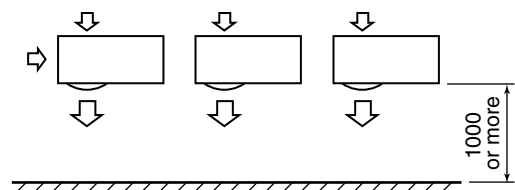

3 SELECTION OF INSTALLATION

<Obstacle also at the upper side>

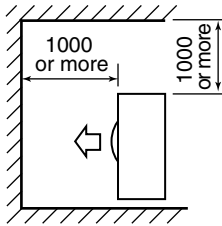

Obstacles at both front and rear sides

Open the upper side and both right and left sides. The height of obstacle at both front and rear side, should be lower than the height of the outdoor unit.

<Standard installation>

1. Single unit installation

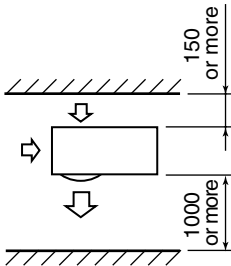

2. Serial installation of two or more units

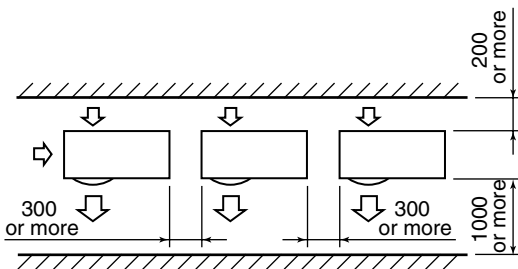

Serial installation at front and rear sides

Open the upper side and both right and left sides. The height of obstacle at both front and rear sides should be lower than the height of the outdoor unit.

<Standard installation>

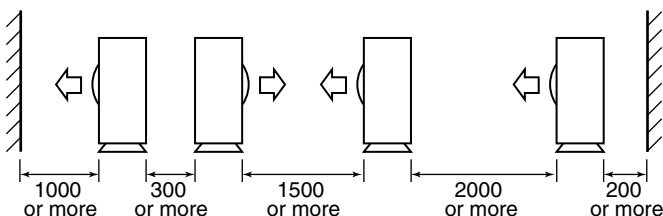

Installation of Outdoor Unit

- Before installation, check strength and horizontality of the base so that abnormal sound does not generate.
- According to the following base diagram, fix the base firmly with the anchor bolts. (Anchor bolt, nut: M10 x 4 pairs)

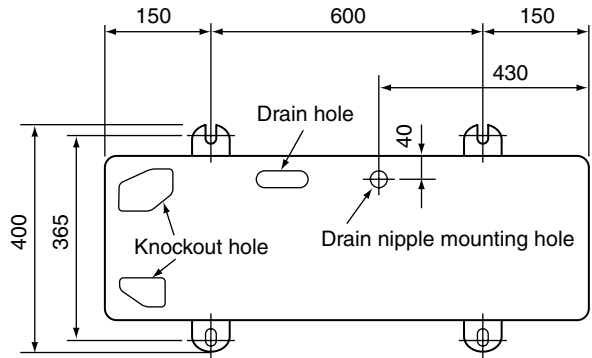

Set the out margin of the anchor bolt to 15mm or less.

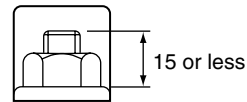

- In case of draining through the drain hose, attach the following drain nipple and the waterproof rubber cap, and use the drain hose (Inner diam.: 16mm) sold on the market. And also seal the screws securely with silicone material, etc. so that water does not drop down. Some conditions may cause dewing or dripping of water.

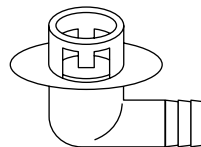

Drain nipple

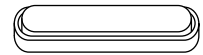

Waterproof rubber cap

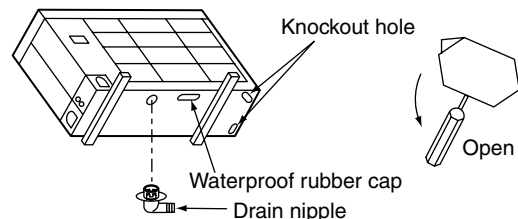

- When there is a possibility of freezing of drain at the cold district or a snowfall area, be careful for drainage ability of drain. The drainage ability increases when a knockout hole on the base plate is opened. (Open the knockout hole to outside using a screwdriver, etc.)

Optional Installation Parts (Local Procure)

	Parts name	Q'ty
A	Refrigerant piping Liquid side : Ø9.5 mm Gas side : Ø15.9 mm	Each one
B	Pipe insulating material (polyethylene foam, 6 mm thick)	1
C	Putty, PVC tapes	Each one

Knockout of Pipe Cover

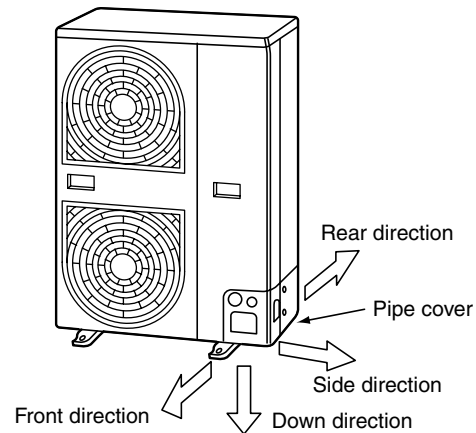

Refrigerant Piping Connection

CAUTION

TAKE NOTICE THESE IMPORTANT 4 POINTS BELOW FOR PIPING WORK

1. Keep dust and moisture away from inside the connecting pipes.
2. Tightly connect the connection between pipes and the unit.
3. Evacuate the air in the connecting pipes using VACUUM PUMP.
4. Check gas leak at connected points.

<Piping connection>

Liquid side		Gas side	
Outer diameter	Thickness	Outer diameter	Thickness
Ø9.5	0.8	Ø15.9	1.0

For Reference

If a heating operation would be continuously performed for a long time under the condition that the outdoor temperature is 0°C or lower, draining of defrosted water may be difficult due to freezing of the bottom plate, resulting in a trouble of the cabinet or fan.

It is recommended to procure an anti-freeze heater locally for a safety installation of the air conditioner.

For details, contact the dealer.

Knockout procedure

- The indoor/outdoor connecting pipes can be connected to 4 directions.
Take off the knockout part of the pipe cover in which pipes or wires pass through the base plate.
- As shown in the figure, do not remove the pipe cover from the cabinet so that the knockout hole can be easily punched. To knock out, it is easily taken off by hands by punching a position at the lower side of 3 connected parts with screwdriver along the guide line.
- After marking the knockout hole, remove the burr and mount the attached protective bush and guard material for pass-through part in order to protect pipes and wires.

After connecting the pipes, be sure to mount the pipe cover. The pipe cover is easily mounted by cutting off the slit at the lower part of the pipe cover.

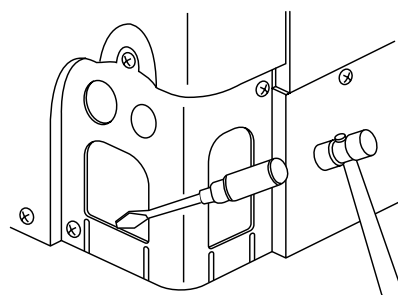

3 SELECTION OF INSTALLATION

How to remove the front panel

1. Remove screws of the front panel.
2. Pull the front panel downward.

Removing the front panel, the electric parts appear at the front side.

- The metal pipes are attachable to the piping holes. If the size of the used power pipe does not match with the hole, adjust the hole size to match with pipe size.
- Be sure to fix the power cable and indoor/outdoor connecting cable with bundling band sold on the market so that they do not make contact with the compressor and discharge pipe. (Temperature of the compressor and discharge pipe becomes high.)

In order to avoid the force applied to on the connecting section, be sure to fix the cables to the cord clamps provided on the pipe valve fixing plate and the electric parts box.

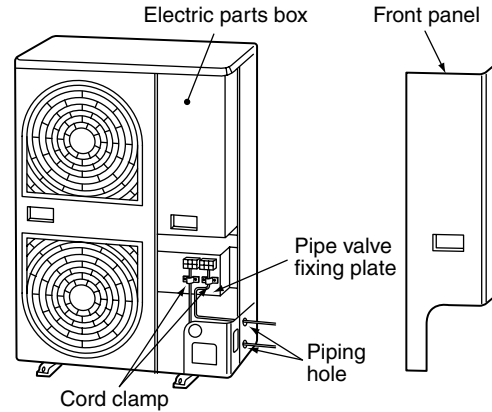

4 REFRIGERANT PIPING

Pipe Forming/End Positioning

Flaring

1. Cut the pipe with a pipe cutter.

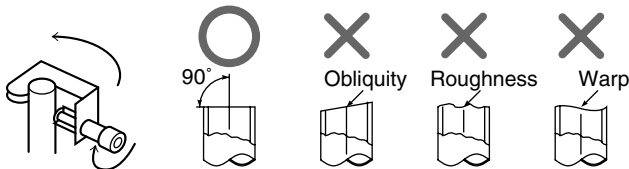

2. Insert a flare nut into the pipe, and flare the pipe.

As the flaring sizes of R410A differ from those of refrigerant R22, the flare tools newly manufactured for R410A are recommended. However, the conventional tools can be used by adjusting projection margin of the copper pipe.

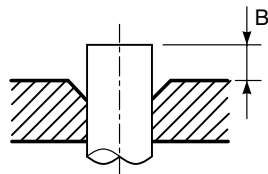

• Flaring size : A (Unit : mm)

Outer dia. of copper pipe	A ⁺⁰ / _{-0.4}	
	R410A	R22
6.4	9.1	9.0
9.5	13.2	13.0
12.7	16.6	16.2
15.9	19.7	19.4

* In case of flaring for R410A with the conventional flare tool, pull it out approx. 0.5 mm more than that of R22 to adjust to the specified flare size. The copper pipe gauge is useful for adjusting projection margin size.

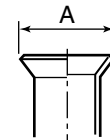

• Projection margin in flaring : B (Unit : mm)

Rigid (Clutch type)

Outer dia. of copper pipe	R410A tool used		Conventional tool used	
	R410A	R22	R410A	R22
6.4	0 to 0.5	(Same as left)	1.0 to 1.5	0.5 to 1.0
9.5	0 to 0.5	(Same as left)	1.0 to 1.5	0.5 to 1.0
12.7	0 to 0.5	(Same as left)	1.0 to 1.5	0.5 to 1.0
15.9	0 to 0.5	(Same as left)	1.0 to 1.5	0.5 to 1.0

Imperial (Wing nut type)

Outer dia. of copper pipe	R410A	R22
6.4	1.5 to 2.0	1.0 to 1.5
9.5	1.5 to 2.0	1.0 to 1.5
12.7	2.0 to 2.5	1.5 to 2.0
15.9	2.0 to 2.5	1.5 to 2.0

Tightening of Connecting Part

(Unit: N•m)

Outer dia. of copper pipe	Tightening torque
6.4 mm (diam.)	14 to 18 (1.4 to 1.8 kgf•m)
9.5 mm (diam.)	33 to 42 (3.3 to 4.2 kgf•m)
12.7 mm (diam.)	50 to 62 (5.0 to 6.2 kgf•m)
15.9 mm (diam.)	63 to 77 (6.3 to 7.7 kgf•m)

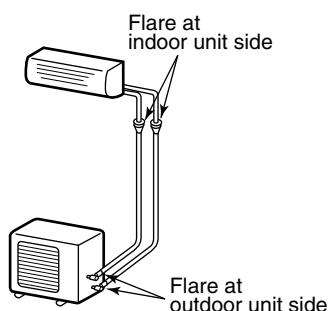

- Align the centers of the connecting pipes and tighten the flare nut strong as far as possible with your fingers.

Then fix the nut with a spanner and tighten it with torque wrench as shown in the figure.

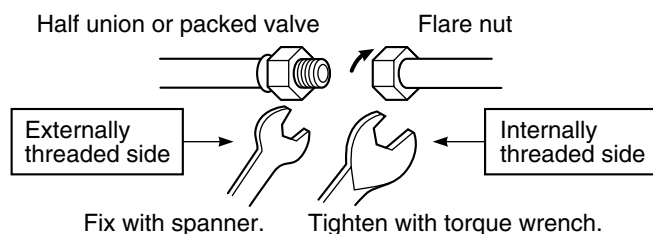

- As shown in the figure, be sure to use a double spanner to loosen or tighten the flare nut of the valve at gas side. If using a single spanner, the nut cannot be tightened with necessary tightening torque.

On the contrary, use a single spanner to loosen or tighten the flare nut of the valve at liquid side.

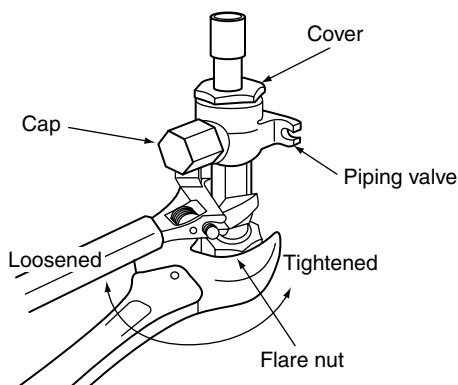

Valve at gas side

REQUIREMENT

- Do not put the spanner on the cap. The valve may be broken.
 - If applying excessive torque, the nut may be broken according to some installation conditions.
- After the installation work, be sure to check gas leak of connecting part of the pipes with nitrogen.

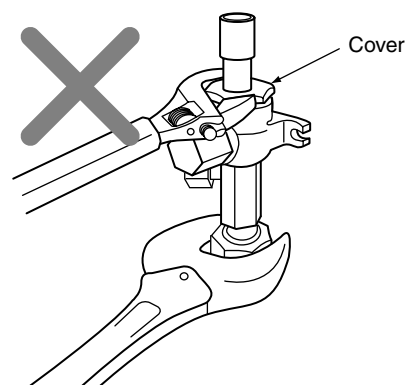

- Pressure of R410A is higher than that of R22 (Approx. 1.6 times). Therefore, using a torque wrench, tighten the flare pipe connecting sections which connect the indoor/outdoor units at the specified tightening torque. Incomplete connections may cause not only a gas leak, but also a trouble of the refrigeration cycle.

Do not apply refrigerating machine oil to the flared surface.

5 EVACUATING

Air Purge

This air conditioner can be installed up to the connecting pipe length and height difference in the following table.

Max. connecting pipe length (m)	Height difference (m)		Hexagonal wrench size
	Outdoor unit at upper side	Outdoor unit at lower side	
50	30	15	4 mm

With respect to the preservation of terrestrial environment, adopt "Vacuum pump" for air purge (Evacuate air in the connecting pipes) when installing the unit.

- Do not discharge the refrigerant gas to the atmosphere to preserve the terrestrial environment.
- Use a vacuum pump to discharge the air (nitrogen, etc.) remained in the set. If the air remains, the capacity may decrease.

For the vacuum pump, be sure to use one with backflow preventer so that the oil in the pump does not backflow into the pipe of the air conditioner when the pump stops. (If oil in the vacuum pump is put in an air conditioner including R410A, it may cause trouble on the refrigeration cycle.)

Vacuum pump

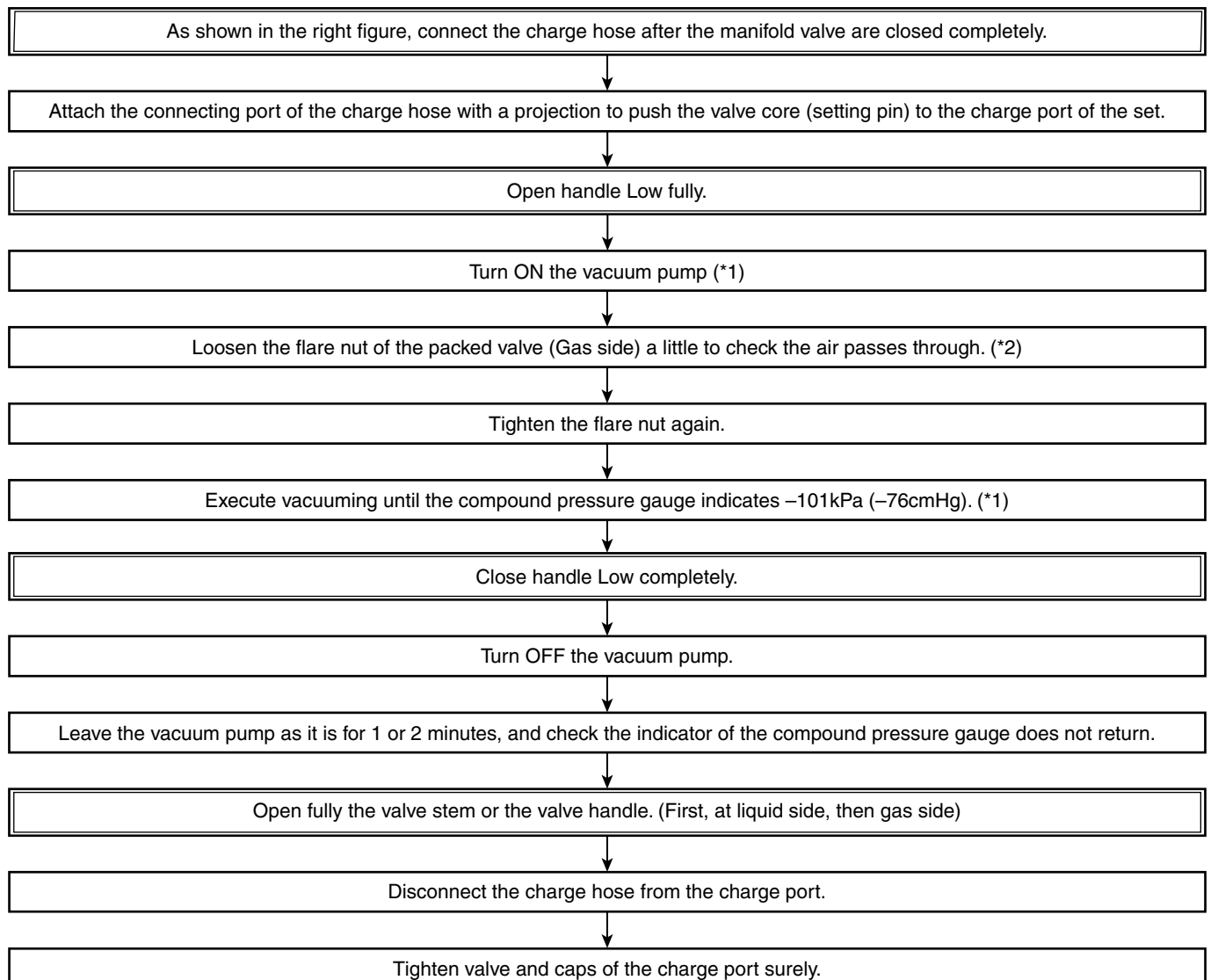

Handle position

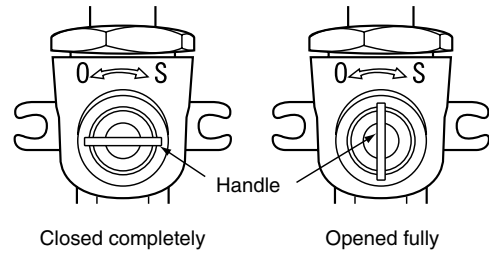
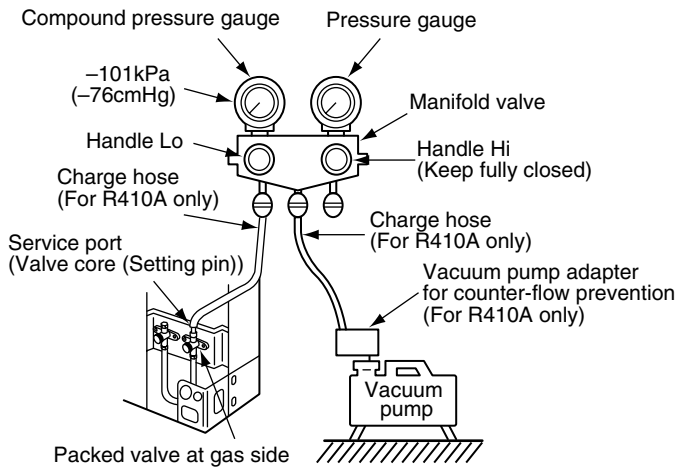

- *1. Use the vacuum pump, vacuum pump adapters, and gauge manifold referring to the manuals attached to each tool before using them. For the vacuum pump, check oil is filled up to the specified line of the oil gauge.
- *2. While the air is purged, check again that the connecting port of charge hose, which has a projection to push the valve core, is firmly connected to the charge port.

How to open the valve

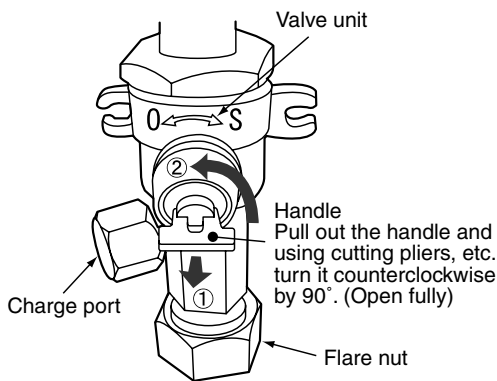

How to close the valve

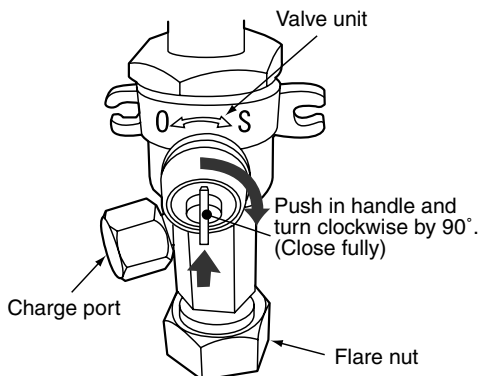

Valve handling precautions

- Open the valve stem or the handle until it strikes the stopper. It is unnecessary to apply further force.
- Securely tighten the cap with a torque wrench.
- Cap tightening torque

Valve size	Ø6.4	14 to 18N•m (1.4 to 1.8kgf•m)
	Ø9.5	33 to 42N•m (3.3 to 4.2kgf•m)
	Ø12.7	33 to 42N•m (3.3 to 4.2kgf•m)
	Ø15.9	20 to 25N•m (2.0 to 2.5kgf•m)
Charge port		14 to 18N•m (1.4 to 1.8kgf•m)

6 ELECTRICAL WORK

For the air conditioner that has no power cable, connect a power cable as mentioned below.

Model	RAV-	SM1100AT-E	SM1400AT-E
Power supply		220 – 240 V Single phase 50 Hz	
Maximum running current		22.0 A	22.8 A
Installation fuse rating		25 A (D type )	
Power cable		H07 RN-F or 245 IEC 66 (2.5 mm ² or more)	

Stripping length power cord and connecting cable

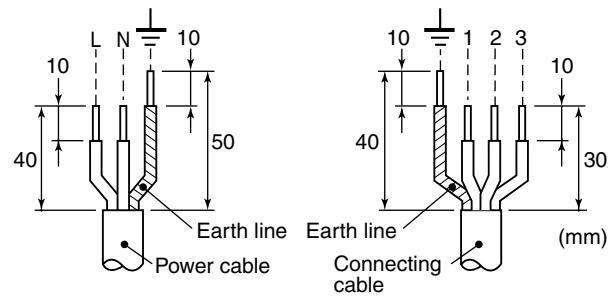

CAUTION

- Wrong wiring may cause a burn-out to some electrical parts.
- Be sure to use the cord clamps attached to the product.
- Do not damage or scratch the conductive core and inner insulator of power and inter-connecting cables when peeling them.
- Be sure to comply with local regulations of the cable from outdoor unit to indoor unit. (wire size and cabling method etc.)
- Use the power and Inter-connecting cables with specified thickness, specified type and protective devices required.

CAUTION

- The installation fuse (25A D type ) must be used for the power supply line of this air conditioner.
- Incorrect/incomplete wiring might cause an electrical fire or smoke.
- Prepare the exclusive power supply for the air conditioner.
- This product can be connected to the mains.
Connection to the fixed wiring :
A switch which disconnects all poles and has a contact separation of at least 3 mm must be incorporated in the fixed wiring.

How to wire

1. Connect the connecting cable to the terminal as identified with their respective numbers on the terminal block of indoor and outdoor unit.
H07 RN-F or 245 IEC 66 (1.0 mm² or more)
2. When connecting the connecting cable to the outdoor unit terminal, prevent water coming in the outdoor unit.
3. Insulate the unsheathed cords (conductors) with electrical insulation tape. Process them so that they do not touch any electrical or metal parts.
4. For inter connecting cable, do not use a wire jointed to another on the way.

Use wires long enough to cover the entire length.

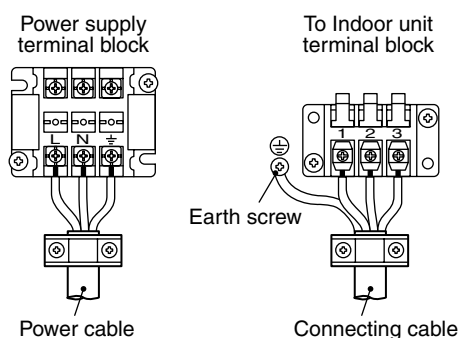

7 FINAL INSTALLATION CHECKS

Check and Test Operation

For R410A, use the leak detector exclusively manufactured for HFC refrigerant (R410A, R134a, etc.).

- * The conventional leak detector for HCFC refrigerant (R22, etc.) cannot be used because its sensitivity for HFC refrigerant lowers to approx. 1/40.
- Pressure of R410A is approx. 1.6 times higher than that of R22.
If installation work is incompletely finished, a gas leakage may occur when pressure rises during operation. Therefore, be sure to test the piping connections for leakage.
- Check gas leakage at the flare nut connections, valve stem cap connections and service port cap fittings with a leak detector or soap water.

CAUTION

When the remote controller is used for the first time, it accepts an operation approx. 5 minutes after the power supply has been turned on.

It is not a trouble, but is because the setup of the remote controller is being checked.

For the second power-ON time and after, approx. 1 minute is required to start the operation by the remote controller.

Useful Functions

Self-Diagnosis by LED Indication

In addition to the code checking by remote controller of the indoor unit, troubles of the outdoor unit can be diagnosed by LED indications on the cycle control P.C. board of the outdoor unit. Utilize them for various checks. For the check by remote controller of the indoor unit, refer to the Installation Manual of the indoor unit. Before a check, confirm each bit of the DIP switch is set to OFF position.

LED indication and code checking

LED indication	Cycle control P.C. board				Cause
	LED indication				
	D800	D801	D802	D803	
D800 ○ : Red D801 ○ : Yellow D802 ○ : Yellow D803 ○ : Yellow ◎ : Rapid flash ● : Go off ○ : Go on	○	●	●	●	Heat exchanger sensor (TE) error
	●	●	○	●	Suction sensor (TS) error
	○	○	●	●	Discharge sensor (TD) error
	●	○	●	○	High-pressure protection error
	●	○	●	●	Outdoor temperature sensor (TO) error
	○	○	○	●	DC outside fan error
	○	●	●	○	Communication error between IPDU (Abnormal stop)
	●	○	●	○	High-pressure release operation
	●	○	○	●	Discharge temp. error
	○	○	●	○	EEPROM error
	●	●	○	○	Communication error between IPDU (No abnormal stop)
	◎	●	●	●	G-Tr short-circuit protection
	●	◎	●	●	Detect circuit error
	◎	◎	●	●	Current sensor error
●	●	◎	●	Comp. lock error	
◎	●	◎	●	Comp. break down	

7 FINAL INSTALLATION CHECKS







Installation/Service Tools

Changes in the product and components

In the case of an air conditioner using R410A, in order to prevent any other refrigerant from being charged accidentally, service port diameter of the outdoor unit control valve (3 way valve) has been changed. (1/2 UNF 20 threads per inch)

- In order to increase the pressure resisting strength of the refrigerant piping flare processing diameter and size of opposite side of flare nuts has been changed. (for copper pipes with nominal dimensions 1/2 and 5/8)

New tools for R410A

New tools for R410A	Applicable to R22 model		Changes
Gauge manifold	×		As pressure is high, it is impossible to measure by means of conventional gauge. In order to prevent any other refrigerant from being charged, each port diameter is changed.
Charge hose	×		In order to increase pressure resisting strength, hose materials and port size are changed (to 1/2 UNF 20 threads per inch). When purchasing a charge hose, be sure to check the port size.
Electronic balance for refrigerant charging	○		As pressure is high and gasification speed is fast, it is difficult to read the indicated value by means of charging cylinder, as air bubbles occur.
Torque wrench (nominal diam. 1/2, 5/8)	×		The size of opposite sides of flare nuts have been increased. Incidentally, a common wrench is used for nominal diameters 1/4 and 3/8.
Flare tool (clutch type)	○		By increasing the clamp bar's receiving hole, strength of spring in the tool has been improved.
Gauge for projection adjustment	—	—	Used when flare is made with using conventional flare tool.
Vacuum pump adapter	○		Connected to the conventional vacuum pump. It is necessary to use an adapter to prevent vacuum pump oil from flowing back to the charge hose. The charge hose connecting part has two ports-one for conventional refrigerant (7/16 UNF 20 threads per inch) and one for R410A. If the vacuum pump oil (mineral) mixes with R410A a sludge may occur and damage the equipment.
Gas leakage detector	×		Exclusive for HFC refrigerant.

- Incidentally, the “refrigerant cylinder” comes with the refrigerant designation (R410A) and protector coating in the U.S.'s ARI specified rose color (ARI color code: PMS 507).
- Also, the “charge port and packing for refrigerant cylinder” require 1/2 UNF 20 threads per inch corresponding to the charge hose's port size.

ACCESSORIES (SOLD SEPARATELY)

Remote controller

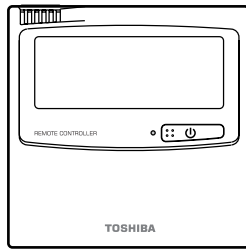

Standard 4-way cassette panel optional parts

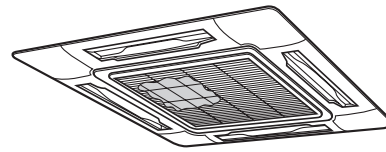

PRECAUTIONS FOR SAFETY

WARNING

WARNINGS ABOUT INSTALLATION

- Make sure to ask the qualified installation professional in electric work to install the air conditioner.
If the air conditioner is inappropriate installed by yourself, it may cause water leak, electric shock, fire, and so on.
- Be sure to provide grounding.
Do not connect ground wires to gas pipes, water pipes, lightning rods or ground wires for telephone cables.

CAUTION

TO DISCONNECT THE APPLIANCE FROM THE MAINS SUPPLY

This appliance must be connected to the mains by means of a switch with a contact separation of at least 3 mm.

The installation fuse (25A D type ) must be used for the power supply line of this conditioner.

WARNINGS ABOUT OPERATION

- Cleaning of the air filter and other parts of the air filter involves dangerous work in high places, so be sure to have a service person do it. Do not attempt it yourself. The cleaning diagram for the air filter is there for the service person, and not for the customer.
- Avoid cooling the room too strong or exposing the human body to cool breeze for a long time as it is bad for the health.
- When you notice something abnormal with the air conditioner (smells like something scorching, poor cooling, etc.), immediately turn off the main switch, the circuit breaker, from the mains to stop the air conditioner, and contact the dealer.
If the air conditioner is continuously operated with something abnormal, it may cause machine failure, electric shock, fire, and so on.

WARNINGS ABOUT MOVEMENT AND REPAIR

- Do not move or repair any unit by yourself.
Since there is high voltage inside the unit, you may get electric shock when removing the cover and main unit.
- Whenever the air conditioner needs repair, make sure to ask the dealer to do it.
If it is repaired imperfectly, it may cause electric shock or fire.
- When moving the air conditioner for re-installing at another place, ask the dealer to do it. If it is imperfectly installed, it may cause electric shock or fire.

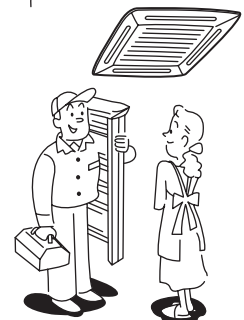
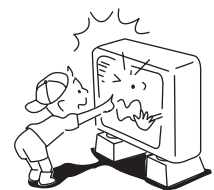
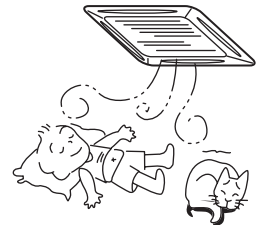

RAV-SM1100AT-E
RAV-SM1400AT-E

CAUTION

CAUTIONS ABOUT INSTALLATION

- Be sure to confirm the following cautions.
- Certainly lay the drain hose for perfect draining. Bad drainage may cause flooding in the house and getting furniture wet.
- Make sure to connect the air conditioner to an exclusive power supply of the rated voltage, otherwise the unit may break down or cause a fire.
- Do not install the unit in a place where inflammable gas may leak. If inflammable gas accumulates around the unit, it may cause a fire.

CAUTIONS ABOUT OPERATION

- Carefully read this manual before starting the air conditioner. There are many important things to keep in mind for daily operation.
- Do not use this air conditioner for special purpose such as preserving food, precision instruments, art objects, breeding animals, growing potted plants, etc.
- Avoid exposing potted plants and animals to the wind of the air conditioner, since it badly affects the health and growth of them.
- When the air conditioner is operated with a combustion appliance in the same place, be careful of ventilation to let fresh air enter the room. Poor ventilation causes oxygen shortage.
- Do not place any combustion appliance in a place where it is directly exposed to the wind of air conditioner, otherwise it may cause imperfect combustion.
- When the air conditioner is used in a closed room, be careful of sufficient ventilation of the room. Poor ventilation causes oxygen shortage.
- Do not touch any switches with wet finger, otherwise you may get an electric shock.
- If the air conditioner won't be used for a considerably long time, turn off the main switch or the circuit breaker, for safety.
- Check the concrete blocks, etc. of the base of the outdoor unit occasionally. If the base is left damaged or deteriorated, the unit may topple over and inflict an injury to a person as the worst case.
- Do not put anything on the outdoor unit nor step onto it. If you do so, it may not only topple over the unit but also injure yourself.
- To make the air conditioner operate in its original performance, operate it within the range of the operating temperature specified in the instructions. Otherwise it may cause a malfunction, or water leak from the unit.
- Prevent any liquid from falling into the remote controller. Do not spill juice, water or any kind of liquid.

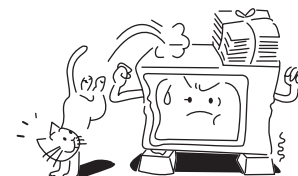
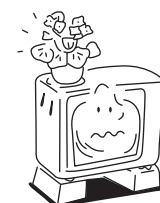
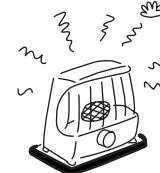
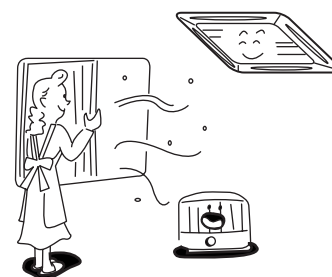
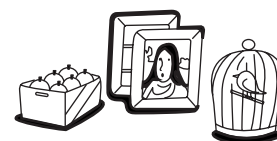
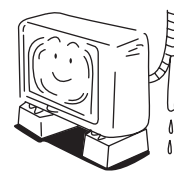

PARTS NAME

Indoor unit

Button

Button to open/close the suction port

Earth screw

Provided in the electric parts box

Discharge flap of discharge port

Change the direction of the air to be discharged according to cool/heat mode.

Air filter

Removes dust or trash. (Provided on the suction port.)

Suction air port

The air in the room is sucked in from this port.

Projection of air filter

Outdoor unit

Air inlet (Side and rear)

Remote controller

Air outlet

Pipes and electric wires

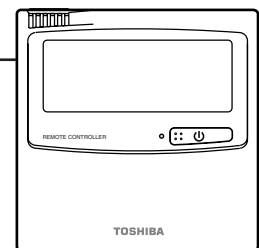

RAV-SM1100AT-E
RAV-SM1400AT-E

PARTS NAME OF REMOTE CONTROLLER

Display section

In the display example, all indicators are displayed for the explanation.

In reality only, the selected contents are indicated.

- When turning on the leak breaker at the first time, [SET DATA] flashes on the display part of the remote controller. While this display is flashing, the model is being automatically confirmed. Accordingly, wait for a while after [SET DATA] display has disappeared, and then use the remote controller.

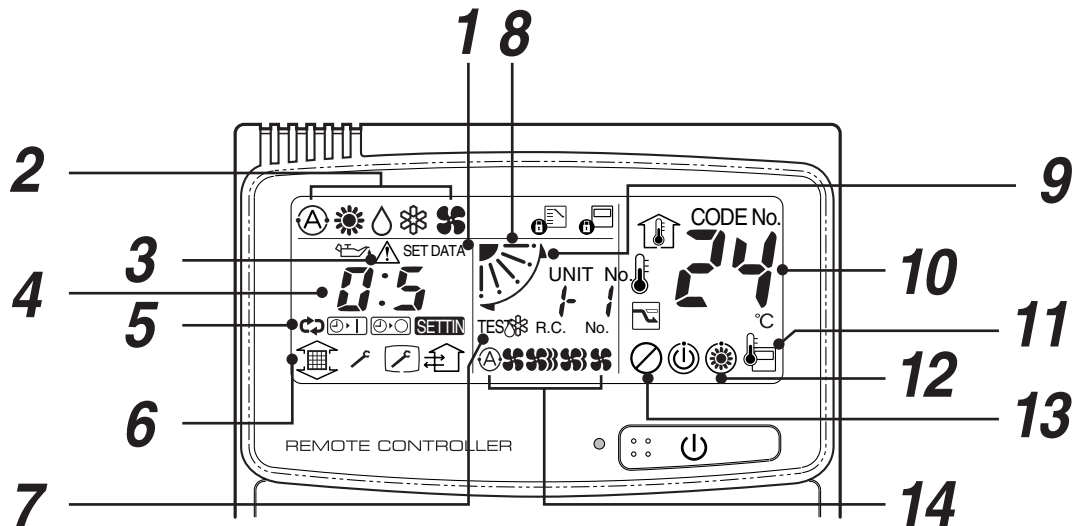
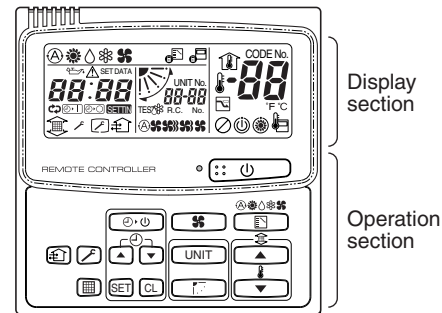

1 SET DATA display

Displayed during setup of the timer.

2 Operation mode select display

The selected operation mode is displayed.

3 CHECK display

Displayed while the protective device works or a trouble occurs.

4 Timer time display

Time of the timer is displayed.
(When a trouble occurs, the check code is displayed.)

5 Timer SETIN setup display

When pushing the Timer SETIN button, the display of the timer is selected in order of [OFF]

☺ → [OFF] repeat OFF timer → [ON]

☺ → No display.

6 Filter display

If "FILTER  is displayed, clean the air filter.

7 TEST run display

Displayed during a test run.

8 Flap position display

Displays flap position.

9 SWING display

Displayed during up/down movement of the flap.

10 Set up temperature display

The selected set up temp. is displayed.

11 Remote controller sensor display

Displayed while the sensor of the remote controller is used.

12 PRE-HEAT display





Displayed when the heating operation starts or defrost operation is carried out. While this indication is displayed, the indoor fan stops or the mode enters in LOW.

13 No function display

Displayed if there is no function even if the button is pushed.

14 Air volume select display

The selected air volume mode is displayed.

- (AUTO) 
- (HIGH) 
- (MED.) 
- (LOW) 

Operation section

Push each button to select a desired operation.

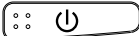
- The details of the operation needs to be set up once, afterward, the air conditioner can be used by pushing  button only.

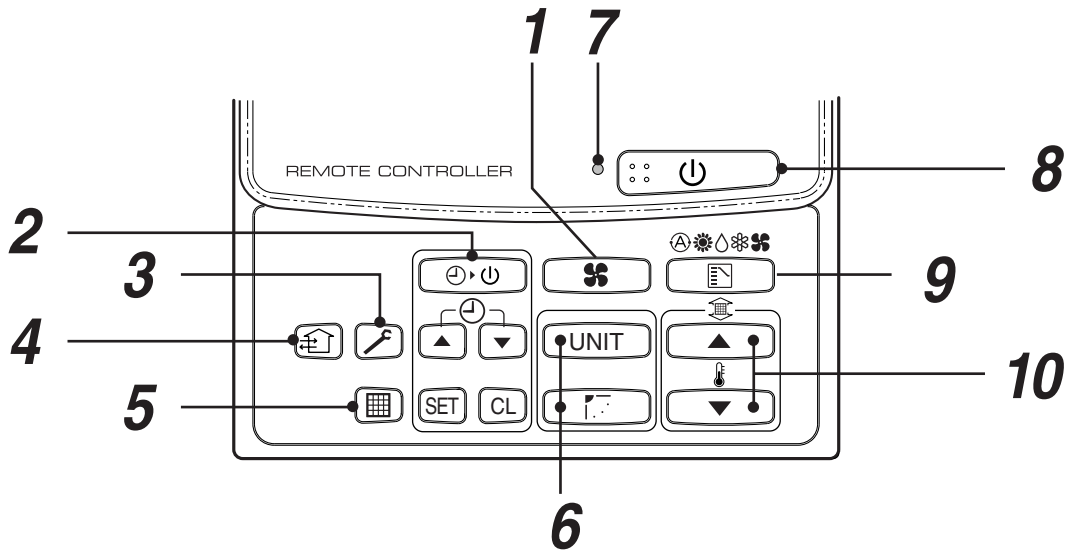

1 Air volume select button

Selects the desired air volume mode.

2 Timer set button

TIMER SET button is used when the timer is set up.

3 Check button

The CHECK button is used for the check operation. During normal operation, do not use this button.

4 Fan button

FAN button is used when a fan which is sold on the market or etc. is connected.

- If “No function” is displayed on the remote controller when pushing the FAN button, a fan is not connected.

5 Filter reset button

Resets (Erases) “FILTER ” display.

6 UNIT and AUTO flap button

 (No function)



7 Operation lamp

Lamp is lit during the operation. Lamp is off when stopped.

Although it flashes when operating the protection device or abnormal time.

8 button

When the button is pushed, the operation starts, and it stops by pushing the button again.

When the operation has stopped, the operation lamp and all the displays disappear.

9 Operation select button

Selects desired operation mode.

10 Set up temperature button

Adjusts the room temperature.

Set the desired set temperature by pushing

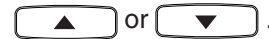

OPTION :

Remote controller sensor

Usually the TEMP. sensor of the indoor unit senses the temperature. The temperature on the surrounding of the remote controller can also be sensed. For details, contact the dealer from which you have purchased the air conditioner.

CORRECT USAGE

When you use the air conditioner for the first time or when you change the SET DATA value, follow the procedure below. From the next time, the operation displayed on the remote controller will start by pushing the  button only.

Preparation

Turn on the main power switch and/or the leakage breaker.

- When the power supply is turned on, a partition line is displayed on the display part of the remote controller.
- * After the power supply is turned on, the remote controller does not accept an operation for approx. 1 minute, but it is not a failure.

REQUIREMENT

- While using the air conditioner, operate it only with  button without turning off the main power switch and the leak breaker.

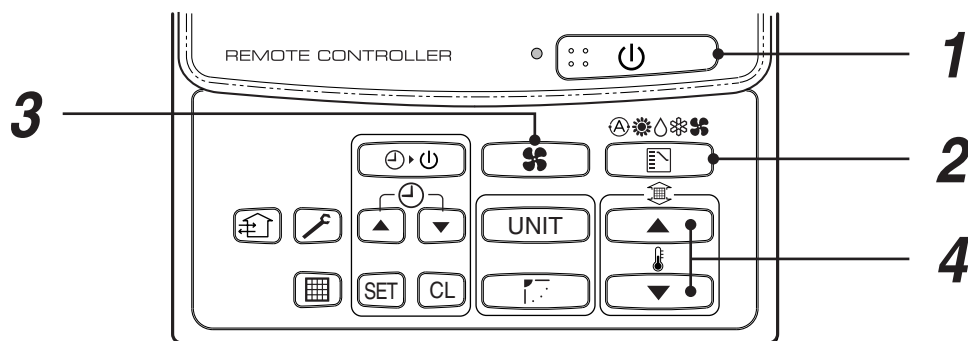



1 Push button.

The operation lamp goes on, and the operation starts.

2 Select an operation mode with the “MODE” button.

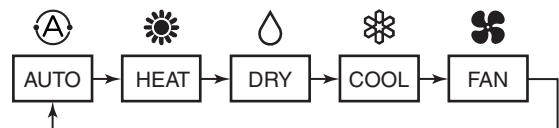
One push of the button, and the display changes in the order shown on the right.









- In HEAT  mode, if the room temperature reaches to the set temperature, the outdoor unit stops and the air flow becomes LOW and the air volume decreases.
- In the defrost mode, the fan stops so that cool air is not discharged and PRE-DEF  is displayed.

3 Select air volume with “FAN ” button.

One push of the button, and the display changes in the order shown on the right.



- When air volume is “AUTO ”, air volume differs according to the room temperature.
- In DRY  mode, “AUTO ” is displayed and the air volume is LOW.
- In heating operation, if the room temperature is not heated sufficiently with VOLUME “LOW ” operation, select “MED. ” or “HIGH ” operation.

4 Determine the set up temperature by pushing the “TEMP. ” or “TEMP. ” button.

Stop

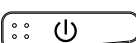
Push  button.

The operation lamp goes off, and the operation stops.

AUTOMATIC OPERATION (Auto Changeover)

When you set the air conditioner in  mode or switch over from AUTO operation because of some settings change, it will automatically select either cooling, heating, or fan only operation depending on the indoor temperature.

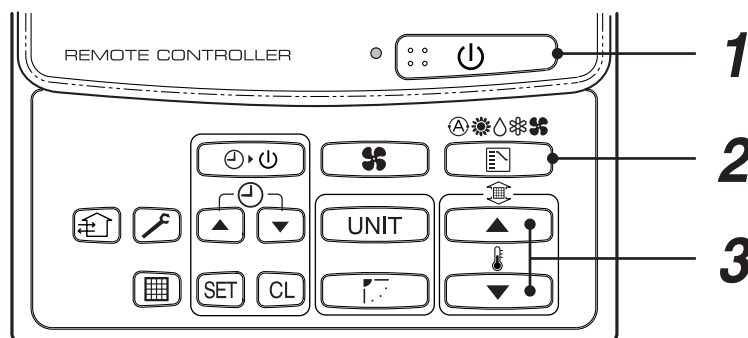

Start

1 button

Push this button to start the air conditioner.

2 Mode select button (MODE)

Select Auto.

3 Temperature button

Set the desired temperature.

- In case of cooling, start the operation after approx. 1 minute.
- In case of heating, the operation mode is selected in accordance with the room temperature and operation starts after approximately 3 to 5 minutes.
- When you select the Auto mode, it is unnecessary to set the fan speed. The FAN speed display will show AUTO and the fan speed will be automatically controlled.
- After the heating operation has stopped, FAN operation may continue for approx. 30 seconds.
- When the room temperature reaches the set temperature and the outdoor unit stops, the super low wind is discharged and the air volume decreases excessively. During defrost operation, the fan stops so that cool air is not discharged and "HEAT READY" is displayed.
- If the Auto mode is uncomfortable, you can select the desired conditions manually.

NOTE

When restarting the operation after stop

- When restarting the operation immediately after stop, the air conditioner does not operate for approx. 3 minutes to protect the machine.

Stop

Push button.

Push this button again to stop the air conditioner.

ADJUSTMENT OF WIND DIRECTION

- When the air conditioner stops, the flap (adjustment plate of up/down wind direction) directs downward automatically.
- When the heating operation is in READY states, the flap (adjustment plate of up/down wind direction) directs upward. The swinging starts after HEAT READY status cleared, SWING  is displayed on the remote controller even if the heating operation is in READY status.

How to set up the wind direction

1 Push  during operation.

The wind direction changes for every push of the button.

In HEAT operation

Direct the flap (adjustment plate of up/down wind direction) downward. If directing at upward, hot air may not come to the foot.

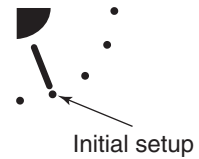

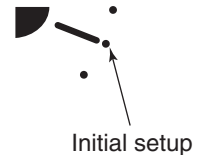

In COOL/DRY operation

Direct the flap (adjustment plate of up/down wind direction) upward. If directing it downward, the dew may form on the surface of the air discharge port and may drop down.



How to start swinging

1 Push , set the flap (adjustment plate of up/down wind direction) direction to the lowest position, and then push  again.

SWING  is displayed and the up/down wind direction is automatically selected.

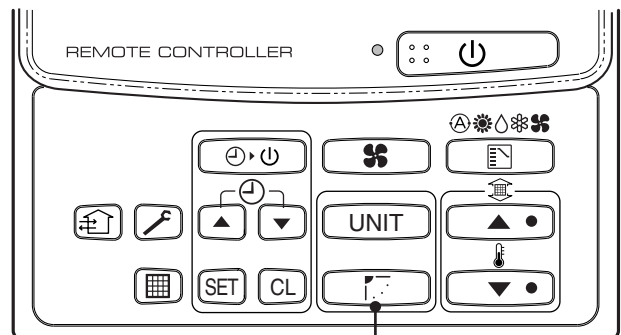

How to stop swinging

1 Push SWING/WIND again while the flap is swinging.

- The flap stops at a position when you push. After then, if pushing , the wind direction descends from the highest position.
- In COOL/DRY operation, the flap does not stop as it directs downward. If stopping the flap as it directs downward during swing operation, it stops after moving to the 3rd position from the highest position.

In FAN operation

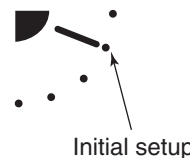

In all modes



Display when stopping the swing



Fan/Heat operation



Cool/Dry operation

TIMER OPERATION

A type of timer operation can be selected from the following three types.

- OFF timer : The operation stops when the time of timer has reached the set time.
- Repeat OFF timer : Every time, the operation stops after the set time has passed.
- ON timer : The operation starts when the time of timer has reached the set time.

Timer operation

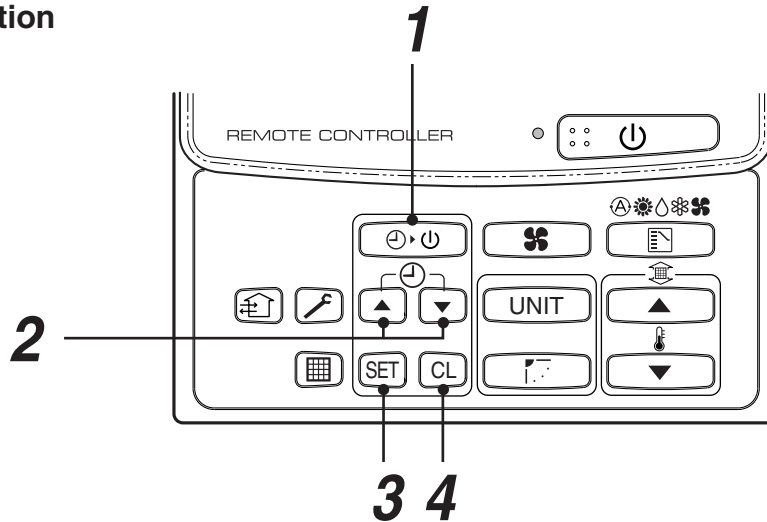

1 Push TIMER SET button.

- The timer display (type) changes for every push of the button.
- SET DATA and  display flashes.

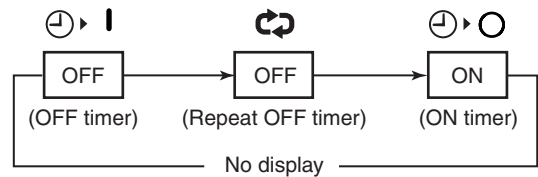

2 Push to select "SET TIME".

For every push of  button, the set time increases in the unit of 0.5 hr (30 minutes).

The maximum set time is 72.0 hr.

For every push of  button, the set time decreases in the unit of 0.5 hr (30 minutes).

The minimum set time is 0.5 hr.

3 Push SET button.

- SET DATA display disappears and  display goes on.

(When ON timer is activated, time is displayed, and after time of the timer has been up, displays other than ON disappear.)

Cancel of timer operation

4 Push CL button.

- TIMER display disappears.

NOTICE

- When the operation stops after the timer reached the preset time, the Repeat OFF timer resumes the operation by pushing  button and stops the operation after the time of the timer has reached the set time.

HINTS FOR ECONOMICAL OPERATION

Maintain room temperature at comfortable level

Clean air filters

The clogged air filter impairs the performance of the air conditioner.

Never open doors and windows more often than necessary

To keep cool or warm air in the room, never open doors and windows more often than necessary.

Window curtains

In cooling, close the curtains to avoid direct sunlight.

In heating, close the curtains to keep the heat in.

Get uniform circulation of room air

Adjust the air flow direction for the even circulation of room air.

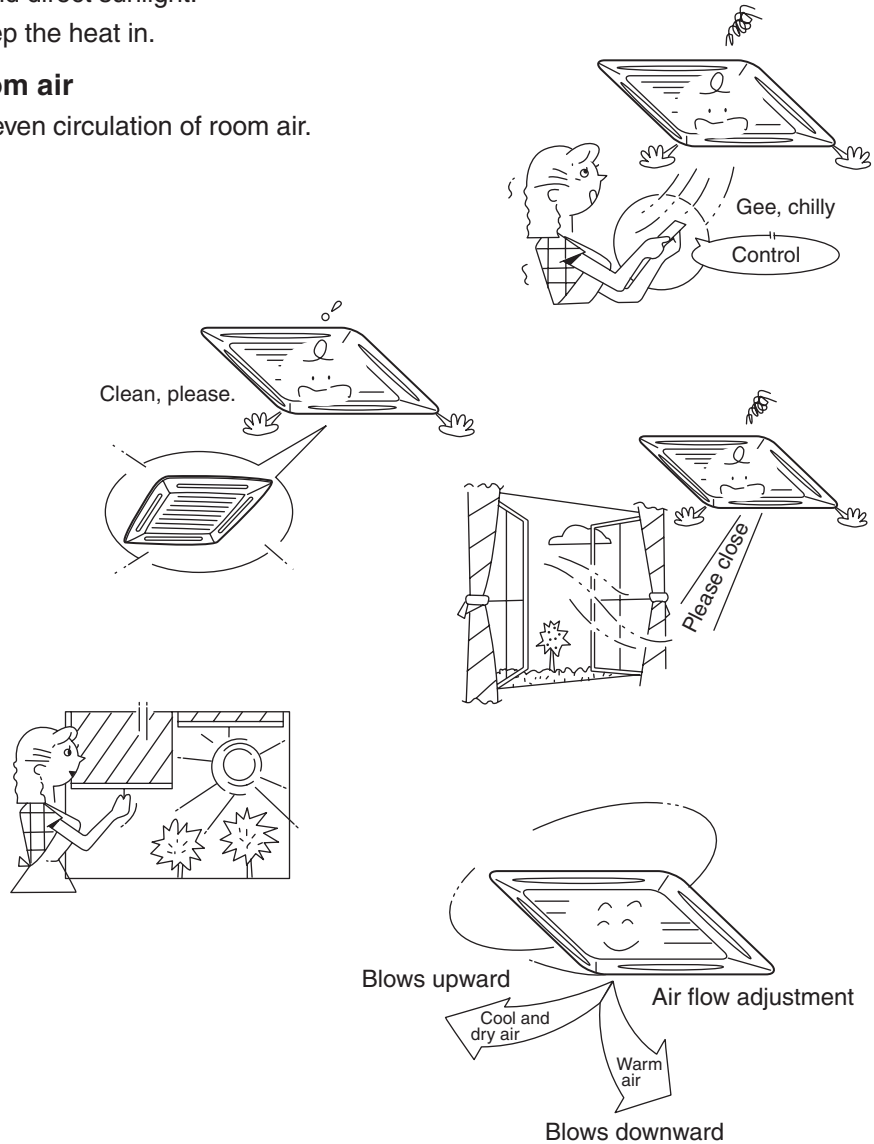

MAINTENANCE

Cleaning of remote controller

CAUTION

- Use a dry cloth to wipe the remote controller.
- A cloth dampened with cold water may be used on the indoor unit if it is very dirty.
- Never use a damp cloth on the remote controller.
- Do not use a chemically-treated duster for wiping or leave such materials on the unit for long. It may damage or fade the surface of the unit.
- Do not use benzine, thinner, polishing powder, or similar solvents for cleaning. These may cause the plastic surface to crack or deform.

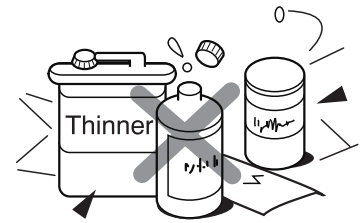

If you do not plan to use the unit for more than 1 month

- (1) Operate the fan for 3 to 4 hours to dry inside the unit
 - Operate "FAN ONLY" mode with set temperature 30°C.
- (2) Stop the air conditioner and turn off the main power switch or the circuit breaker.



FAN ONLY operation or thermo.-off operation

Checks before operation

- (1) Check that the air filters are installed.
- (2) Check that the air outlet or inlet is not blocked.
- (3) Turn on the main power switch or the circuit breaker for the mains AC outlet to turn on the air conditioner.

WARNING

Cleaning of the air filter and other parts of the air filter involves dangerous work in high places, so be sure to have a service person do it.
Do not attempt it yourself.

NOTE

For Air conditioning system which is operated regularly, cleaning and maintenance of the indoor/outdoor units are strongly recommended.
As a general rule, if an indoor unit is operated for about 8 hours daily, the indoor/outdoor units will need to be cleaned at least once every **3-month**. This cleaning and maintenance shall be carried out by a qualified person.
Failure to clean the indoor/outdoor units regularly will result in poor performance, icing, water leaking and even compressor failure.

AIR CONDITIONER OPERATIONS AND PERFORMANCE

3 minutes protection function

3-minutes protection function prevents the air conditioner from starting for initial 3 minutes after the main power switch/circuit breaker is turned on for re-starting the air conditioner.

Power failure

Power failure during operation will stop the unit completely.

- To restart the operation, push the START/STOP button on the remote controller.
- Lightning or a wireless car telephone operating nearby may cause the unit to malfunction. Turn off the main power switch or circuit breaker and then turn them on again. Push the START/STOP button on the remote controller to restart.

Heating characteristics

Preheating operation

The air conditioner will not deliver warm air immediately after it is turned on. Warm air will start to flow out after approximately 5 minutes when the indoor heat exchanger warmed up.

Warm air control (In heating operation)

When the room temperature reaches the set temperature, the fan speed is automatically reduced to prevent to blow cold draft. At this time, the outdoor unit will stop.

Defrosting operation

If the outdoor unit is frosted during the heating operation, defrosting starts automatically (for approximately 2 to 10 minutes) to maintain the heating capacity.

- The fans in both indoor and outdoor units will stop during the defrosting operation.
- During the defrosting operation, the defrosted water will be drained from the bottom plate of the outdoor unit.

Heating capacity

In the heating operation, the heat is absorbed from the outside and brought into the room. This way of heating is called heat pump system. When the outside temperature is too low, it is recommended to use another heating apparatus in combination with the air conditioner.

Attention to snowfall and freeze on the outdoor unit

- In snowy areas, the air inlet and air outlet of the outdoor unit are often covered with snow or frozen up. If snow or freeze on the outdoor unit is left as it is, it may cause machine failure or poor warming.
- In cold areas, pay attention to the drain hose so that it perfectly drains water without water remaining inside for freeze prevention. If water freezes in the drain hose or inside the outdoor unit, it may cause machine failure or poor warming.

Air conditioner operating conditions

For proper performance, operate the air conditioner under the following temperature conditions:

Cooling operation	Outdoor temperature : -5°C to 43°C
	Room temperature : 21°C to 32°C (Dry valve temp.), 15°C to 24°C (Wet valve temp.)
	CAUTION Room relative humidity – less than 80 %. If the air conditioner operates in excess of this figure, the surface of the air conditioner may cause dewing.
Dry operation	Outdoor temperature : 15°C to 43°C (Maximum suction air temp. 46°C)
	Room temperature : 17°C to 32°C
Heating operation	Outdoor temperature : -15°C to 15°C (Wet valve temp.)
	Room temperature : 15°C to 28°C (Dry valve temp.)

If air conditioner is used outside of the above conditions, safety protection may work.

RE-INSTALLATION

DANGER

Ask the dealer or an installation professional to re-install the air conditioner to a new place or move it to another place and to observe the following items.

If the air conditioner is inappropriately installed by yourself, it may cause electric shock or fire.

Do not install the air conditioner in the following places

- Do not install the air conditioner in any place within 1 m from a TV, stereo, or radio set. If the unit is installed in such place, noise transmitted from the air conditioner affects the operation of these appliances.
- Do not install the air conditioner near a high frequency appliance (sewing machine or massager for business use, etc.), otherwise the air conditioner may malfunction.
- Do not install the air conditioner in a humid or oily place, or in a place where steam, soot, or corrosive gas is generated.
- Do not install the air conditioner in a salty place such as seaside area.
- Do not install the air conditioner in a place where a great deal of machine oil is used.
- Do not install the air conditioner in a place where it is usually exposed to strong wind such as in seaside area or on the roof or upper floor of a building.
- Do not install the air conditioner in a place where sulfurous gas generated such as in a spa.
- Do not install the air conditioner in a vessel or mobile crane.

Be careful with noise or vibrations

- Do not install the air conditioner in a place where noise by outdoor unit or hot air from its air outlet annoys your neighbors.
- Install the air conditioner on a solid and stable foundation so that it prevents transmission of resonating, operation noise and vibration.
- If one indoor unit is operating, some sound may be audible from other indoor units that are not operating.



TROUBLES AND CAUSES

CAUTION

If any of the following conditions occur, turn off the main power supply switch and immediately contact the dealer :

- The operation lamps flash at short intervals (5 Hz) even though you have tried turning off the power supply and turning on again after 2 or 3 minutes.
- Switch operation does not work properly.
- The main power fuse often blows out, or the circuit breaker is often activated.
- A foreign matter or water fall inside the air conditioner.
- Any other unusual conditions are observed.

Before you ask for servicing or repairs, check the following points.

Recheck

Inoperative

- The main power switch is turned off.
- The circuit breaker is activated to cut off power supply.
- The main power fuse has blown out.
- Stoppage of electric current.

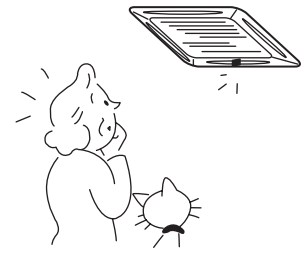

Does not cool well or heat well

- The air inlet and/or outlet of the outdoor unit is blocked.
- Doors or windows are opened.
- The fan speed is set to low.
- The air conditioner is set in the DRY mode.
- The set temperature is too high. (In cooling operation)
- The set temperature is too low. (In heating operation)

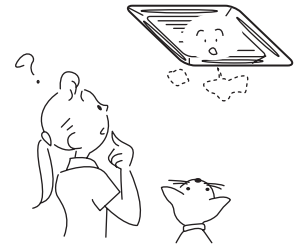

These are not failures.

Indoor unit or outdoor unit makes a strange noise.

- When the temperature suddenly changes, the indoor or outdoor unit occasionally makes a strange noise because of expansion/contraction of parts or change of refrigerant flow.

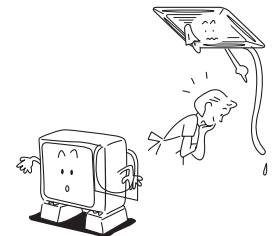

The room air is smelly or a bad odor comes from the air conditioner.

- Smells impregnated in the walls, carpets, furniture, clothing, or furs, come out.



Outdoor unit is frosted in heating operation.

Water drains from outdoor unit.

- The outdoor unit is sometimes frosted in heating operation.
In that case, the unit automatically performs defrosting (for 2 to 10 minutes) for increasing the heating efficiency.
- In defrosting operation, both the indoor and outdoor units stop air flow.
- Hiss sound is heard when flow of the refrigerant is changed for defrosting.
- Resultant water of automatic defrosting in heating operation drains from outdoor unit.



Air flow changes though the FAN button is not set to the AUTO mode.

- When the temperature of blown air drops in heating operation, the air conditioner automatically changes or stops air flow from the indoor unit not to make persons in the room feel chilly.
- Air flow from the indoor unit is occasionally changed in the cooling operation.





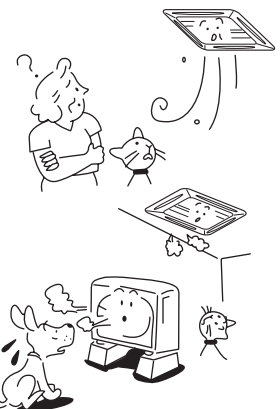

A white mist of chilled air or water is generated from the outdoor unit.





- The indoor unit in cooling operation or the outdoor unit in defrosting operation occasionally steams.



Accessory parts and Parts to be procured locally

□ Accessory parts

Part name	Q'ty	Shape	Usage
Installation Manual	1	This manual	(Be sure to hand over to customers)
Heat insulating pipe	2		For heat insulation of pipe connecting section
Installation pattern	1		For confirmation of ceiling opening and main unit position
Installation gauge	2		For positioning of ceiling position (united with installation pattern)
Pattern fixing screw	4	M5 x 16L	For attach the installation pattern
Heat insulator	1		For heat insulation of drain connecting section

Part name	Q'ty	Shape	Usage
Washer	8		For hanging-down unit
Hose band	1		For connecting drain pipe
Flexible hose	1		For adjusting core-out of drain pipe
Heat insulator	1		For sealing of wire connecting port
Owner's Manual	1		(Be sure to hand over to customers)

<Separate sold parts>

Part name	Q'ty	Shape	Usage
Standard wired remote controller	1		Model RBC-AMT21E

Part name	Q'ty	Shape	Usage
Ceiling panel	1		Model RBC-U21PG (W)-E

□ Parts to be procured locally

<p>Connecting pipe (Liquid side) (6.35mm (diam.), Nominal (diam.) 1/4" thick 0.8mm) RAV-SM560UT-E, RAV-SM560AT-E (9.52mm (diam.), Nominal (diam.) 3/8" thick 0.8mm) RAV-SM800UT-E, RAV-SM800AT-E RAV-SM1100UT-E, RAV-SM1100AT-E RAV-SM1400UT-E, RAV-SM1400AT-E</p>
<p>Connecting pipe (Gas side) (12.7mm (diam.), Nominal (diam.) 1/2" thick 0.8mm) RAV-SM560UT-E, RAV-SM560AT-E (15.9mm (diam.), Nominal (diam.) 5/8" thick 1.0mm) RAV-SM800UT-E, RAV-SM800AT-E RAV-SM1100UT-E, RAV-SM1100AT-E RAV-SM1400UT-E, RAV-SM1400AT-E</p>
<p>Power supply cord 2.5mm² (H07RN-F or 245IEC66) or 3.5mm² (AWG-12)</p>

<p>Connecting cable (indoor and outdoor cable) H07RN-F or 245IEC66 (1.5mm² or more)</p>
<p>Thermal insulation for refrigerant pipe (10mm or more, thermal insulating foam polyethylene)</p>
<p>Thermal insulation for drain pipe (10mm or more, foam polyethylene)</p>
<p>Drain pipe (Outer 26mm (diam.))</p>
<p>Tapes</p>
<p>Grounding cable (2.0mm (diam.) or more)</p>

RAV-SM1100AT-E
RAV-SM1400AT-E

1 PRECAUTIONS FOR SAFETY

- Ensure that all Local, National and International regulations are satisfied.
- Read this "PRECAUTIONS FOR SAFETY" carefully before Installation.
- The precautions described below include the important items regarding safety. Observe them without fail.
- After the installation work, perform a trial operation to check for any problem.
Follow the Owner's Manual to explain how to use and maintain the unit to the customer.
- Turn off the main power supply switch (or breaker) before the unit maintenance.
- Ask the customer to keep the Installation Manual together with the Owner's Manual.

CAUTION

New Refrigerant Air Conditioner Installation

- **THIS AIR CONDITIONER ADOPTS THE NEW HFC REFRIGERANT (R410A) WHICH DOES NOT DESTROY OZONE LAYER.**

The characteristics of R410A refrigerant are ; easy to absorb water, oxidizing membrane or oil, and its pressure is approx. 1.6 times higher than that of refrigerant R22. Accompanied with the new refrigerant, refrigerating oil has also been changed. Therefore, during installation work, be sure that water, dust, former refrigerant, or refrigerating oil does not enter the refrigerating cycle.

To prevent charging an incorrect refrigerant and refrigerating oil, the sizes of connecting sections of charging port of the main unit and installation tools are charged from those for the conventional refrigerant.

Accordingly the exclusive tools are required for the new refrigerant (R410A).

For connecting pipes, use new and clean piping designed for R410A, and please care so that water or dust does not enter. Moreover, do not use the existing piping because there are problems with pressure-resistance force and impurity in it.

CAUTION

To Disconnect the Appliance from Main Power Supply.

This appliance must be connected to the main power supply by means of a switch with a contact separation of at least 3 mm.

The installation fuse (25A D type ) must be used for the power supply line of this conditioner.

⚠ WARNINGS

- **Ask an authorized dealer or qualified installation professional to install/maintain the air conditioner.**
Inappropriate installation may result in water leakage, electric shock or fire.
- **Turn off the main power supply switch or breaker before attempting any electrical work.**
Make sure all power switches are off. Failure to do so may cause electric shock.
- **Connect the connecting cable correctly.**
If the connecting cable is connected in a wrong way, electric parts may be damaged.
- **When moving the air conditioner for the installation into another place, be very careful not to enter any gaseous maller other than the specified refrigerant into the refrigeration cycle.**
If air or any other gas is mixed in the refrigerant, the gas pressure in the refrigeration cycle becomes abnormally high and it resultingly causes pipe burst and injuries on persons.
- **Do not modify this unit by removing any of the safety guards or by by-passing any of the safety interlock switches.**
- **Exposure of unit to water or other moisture before installation may cause a short-circuit of electrical parts.**
Do not store it in a wet basement or expose to rain or water.

- **After unpacking the unit, examine it carefully if there are possible damage.**
- **Do not install in a place that might increase the vibration of the unit.**
- **To avoid personal injury (with sharp edges), be careful when handling parts.**
- **Perform installation work properly according to the Installation Manual.**
Inappropriate installation may result in water leakage, electric shock or fire.
- **When the air conditioner is installed in a small room, provide appropriate measures to ensure that the concentration of refrigerant leakage occur in the room does not exceed the critical level.**
- **Install the air conditioner securely in a location where the base can sustain the weight adequately.**
- **Perform the specified installation work to guard against an earthquake.**
If the air conditioner is not installed appropriately, accidents may occur due to the falling unit.
- **If refrigerant gas has leaked during the installation work, ventilate the room immediately.**
If the leaked refrigerant gas comes in contact with fire, noxious gas may generate.
- **After the installation work, confirm that refrigerant gas does not leak.**
If refrigerant gas leaks into the room and flows near a fire source, such as a cooking range, noxious gas might generate.
- **Electrical work must be performed by a qualified electrician in accordance with the Installation Manual. Make sure the air conditioner uses an exclusive power supply.**
An insufficient power supply capacity or inappropriate installation may cause fire.
- **Use the specified cables for wiring connect the terminals securely fix. To prevent external forces applied to the terminals from affecting the terminals.**
- **Conform to the regulations of the local electric company when wiring the power supply.**
Inappropriate grounding may cause electric shock.
- **Do not install the air conditioner in a location subject to a risk of exposure to a combustible gas.**
If a combustible gas leaks, and stays around the unit, a fire may occur.

2 SELECTION OF INSTALLATION PLACE

⚠ WARNING

- **Install the air conditioner at enough strong place to withstand the weight of the unit.**
If the strength is not enough, the unit may fall down resulting in injury.
- **Install the air conditioner at a height 2.5m or more from the floor.**
If you insert your hands or others directly into the unit while the air conditioner operates, it is dangerous because you may contact with revolving fan or active electricity.

⚠ CAUTION

- **Do not install the air conditioner in a location subject to a risk of exposure to a combustible gas.**
If a combustible gas leaks and stays around the unit, a fire may occur.

Upon approval of the customer, install the air conditioner in a place that satisfies the following conditions.

- Place where the unit can be installed horizontally.
- Place where a sufficient servicing space can be ensured for safety maintenance and check.
- Place where drained water will not cause any problem.

Avoid installing in the following places.

- Place exposed to air with high salt content (seaside area), or place exposed to large quantities of sulfide gas (hot spring). (Should the unit be used in these places, special protective measures are needed.)
- Place exposed to oil, vapor, oil smoke or corrosive gas.
- Place where organic solvent is used nearby.
- Place close to a machine generating high frequency.
- Place where the discharged air blows directly into the window of the neighboring house. (For outdoor unit)
- Place where noise of the outdoor unit is easily transmitted.
(When installing the air conditioner on the boundary with the neighbor, pay due attention to the level of noise.)
- Place with poor ventilation. (Before air ducting work, check whether value of air volume, static pressure and duct resistance are correct.)

Installation space

Secure the specified space in the figure for installation and servicing.

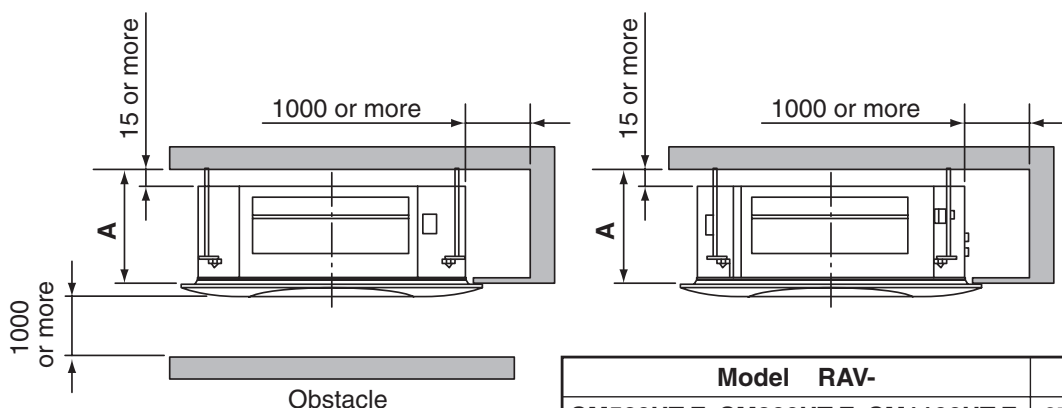

Model	RAV-	A mm
SM560UT-E, SM800UT-E, SM1100UT-E		271 or more
SM1400UT-E		334 or more

Selection of installation place

In case of continued operation of the indoor unit under high-humidity conditions as described below, dew may condense and water may drop.

Especially, high-humidity atmosphere (dew point temperature : 23°C or more) may generate dew inside the ceiling.

1. Unit is installed inside the ceiling with slated roof.
2. Unit is installed at a location using inside of the ceiling as fresh air take-in path.
3. Kitchen

If installing a unit at such place, put insulating material (glass wool, etc.) additionally on all the positions of the indoor unit which come to contact with high-humidity atmosphere.

Advice

Set a check service opening panel at right side of the unit (size: 450 x 450mm or more) for piping, maintenance, and servicing.

Ceiling height

Model RAV-	Possible installed ceiling height
SM560UT-E, SM800UT-E	Up to 3.8 m
SM1100UT-E, SM1400UT-E	Up to 4.3 m

When the height of the ceiling exceeds the distance of the item Standard/4-way in Table below, the hot air is difficult to reach the floor. Therefore, it is necessary to change the setup value of the high ceiling switch or discharge direction.

REQUIREMENT

- When using the air conditioner with 2-way discharge system with the standard setting (at a shipment), it may stop abnormally in heating. Therefore, change the setting switch according to the number of discharge direction and the ceiling height.
- When using the air conditioner with 2-way/3-way discharge system, a strong wind blows directly if the ceiling height is lower than the standard. Therefore, change the setting switch according to height of the ceiling.
- When using the high ceiling (1) or (2) with 4-way discharge system, the draft is apt to be felt due to drop of the discharge temperature.

Discharge direction

As shown in the following figure, No. of discharge directions can be selected according to the shape of rooms and installation position.

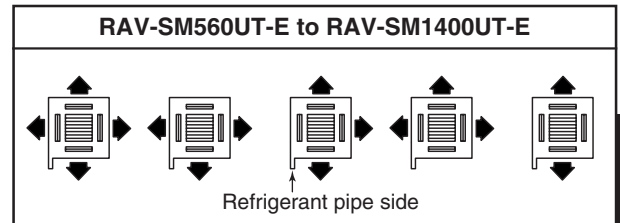

As shown in the following figure direction are not acceptable.

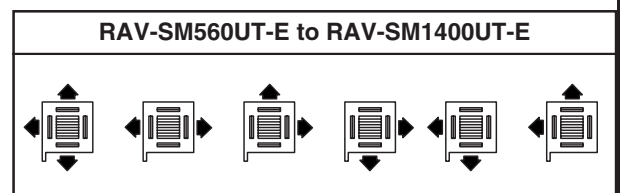

- To change discharge direction, use a shielding plate.
- When attaching a shielding plate, remove the ceiling panel and insert the shielding plate into the discharge port as shown in the figure below.

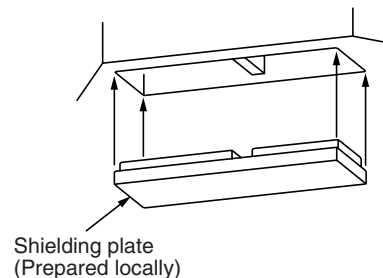

WARNING

Install the air conditioner certainly to sufficiently withstand the weight.

If the strength is insufficient, the unit may fall down resulting in human injury.

Perform a specified installation work to guard against an earthquake.

An incomplete installation can cause accidents by the units falling and dropping.

Height list of ceiling possible to be installed

(Unit : m)

Model RAV-	SM560UT-E			SM800UT-E			SM1100, SM1400UT-E			High ceiling setup
	No. of discharge direction	4-way	3-way	2-way	4-way	3-way	2-way	4-way	3-way	
Standard (at shipment)	2.8	3.2	3.5	3.0	3.3	3.6	3.6	3.9	4.2	Set data
High ceiling (1)	3.2	3.5	3.8	3.3	3.5	3.8	3.9	4.1	4.3	0001
High ceiling (2)	3.5	3.8	—	3.6	3.8	—	4.2	4.3	—	0003

2 SELECTION OF INSTALLATION PLACE

External view

REQUIREMENT

Strictly comply with the following rules to prevent damage of the indoor units and human injury.

- Do not put a heavy article on the indoor unit. (Even units are packaged)
- Carry in the indoor unit as it is packaged if possible. If carrying in the indoor unit unpacked by necessity, be sure to use buffering cloth, etc. to not damage the unit.
- To move the indoor unit, hold the hooking metals (4 positions) only. Do not apply force to the other parts (refrigerant pipe, drain pan, foamed parts, or resin parts, etc.).
- Carry the package by two or more persons, and do not bundle it with PP band at positions other than specified.

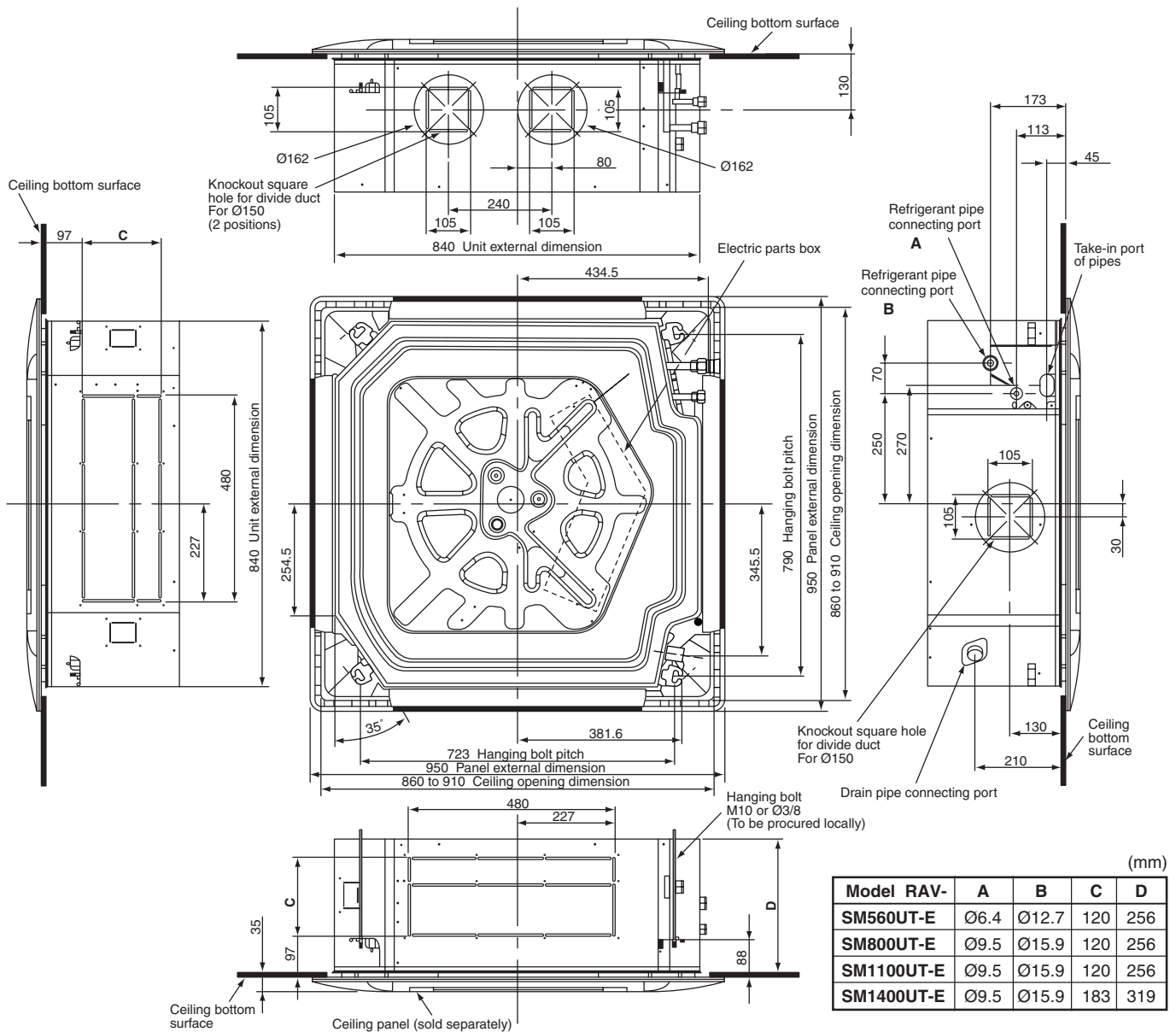

Considering pipe/wire connecting work inside the ceiling after the indoor unit has been hanged, select an installation place and determine piping direction.

- If the ceiling has already been set before hanging the main unit, prepare refrigerant pipe, drain pipe, indoor connecting wire, remote controller cord, etc. up to the place where pipe and wire can be connected.
- Check the size of the indoor unit, and match the indoor unit size, with ceiling opening size and that position using the attached installation pattern.
(Attach the pattern to the lower side of indoor unit with attached four screws M5 x 16L.)

Opening a ceiling and installation of hanging bolts

<Treatment of ceiling>

The ceiling differs according to structure of building. For details, consult your constructor or interior finish contractor. In the process after the ceiling board has been removed, it is important to reinforce ceiling foundation (frame) and to keep horizontal level of installed ceiling correctly in order to prevent vibration of ceiling board.

- (1) Cut and remove the ceiling foundation.
- (2) Reinforce the cut surface of ceiling foundation, and add ceiling foundation for fixing the end of ceiling board.

<Installation of hanging bolt>

Use M10 hanging bolts (4 pcs, to be local procure). Matching to the existing structure, set pitch according to size in the unit external view as shown below.

New concrete slab	Steel frame structure	Existing concrete slab
Install the bolts with insert brackets or anchor bolts.	Use existing angles or install new support angles.	Use a hole-in anchors, hole-in plugs, or a hole-in bolts.
<p>(Blade type bracket) (Slide type bracket) (Pipe hanging anchor bolt)</p>	<p>Hanging bolt Support angle</p>	

Installation of ceiling opening and hanging bolt

Adjust nut position (lower side) so that clearance between the attached washer (lower side) and ceiling board is 88mm.

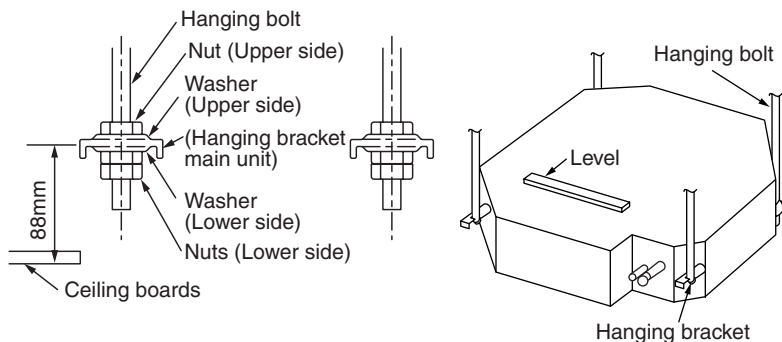

- Hang up the main unit by hanging the nut of hanging bolt to T groove of hanging bracket of the main unit.
- Using the level vial, etc., set the horizontal level of the main unit within 5mm.
- Using the installation gauge, check and adjust the positional relation between the main unit and ceiling opening hole, and hanging-up height of the main unit. (Direction to be used is indicated on the installation gauge.)
 - 1) Check lower side of the indoor unit locates at position (12 to 17) mm higher than the lower surface of the ceiling board. (4 corners)
 - 2) Check clearance between side of the indoor unit and the ceiling board is 20 to 30mm. (Common to 4 corners)

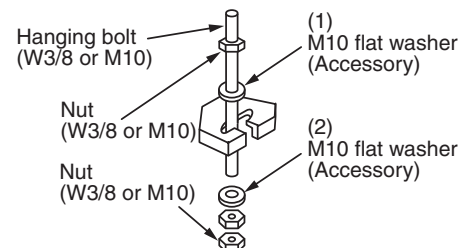

- (1) Required those other than M10 flat washer at site.
- (2) To prevent falling-off of bolt (safety), be sure to set it just under the hanging bracket as shown in the figure.

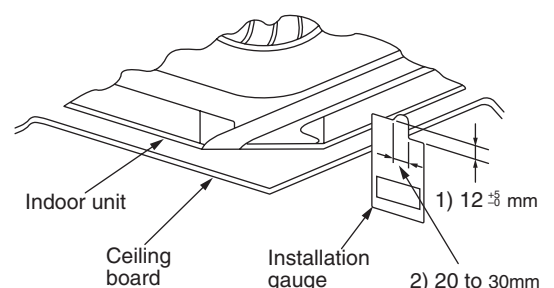
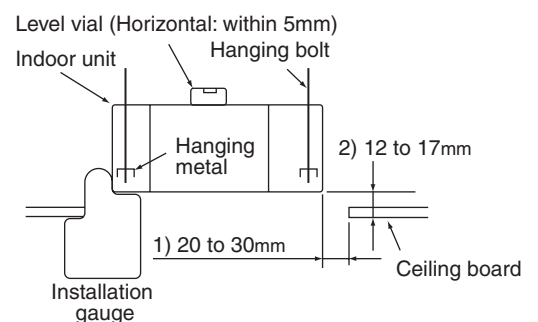

2 SELECTION OF INSTALLATION PLACE

REQUIREMENT

Before installation of the indoor unit, be sure to remove the cushion for transportation between the fan and the bell mouth. Running the unit without removing the cushion may damage the fan motor.

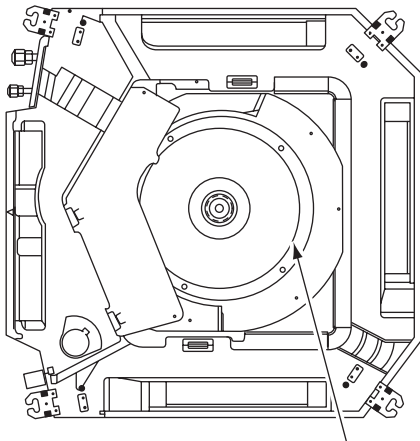

Be sure to remove the cushion for transportation between the fan and the bell mouth.

Installation of ceiling panel (Sold separately)

Install the ceiling panel according to Installation Manual attached with it after piping/wiring work has completed.

Check that installation of indoor unit and ceiling opening part is correct, and then install it.

REQUIREMENT

Joint the connecting sections of ceiling panel, ceiling surface, ceiling panel and indoor unit closely.

Any gap between them will cause air leakage and this generate condensation or water leakage.

Installation of ceiling opening and hanging bolt

For installation of the wired remote controller, follow the Installation Manual attached with the remote controller.

- Pull out the remote controller cord together with the refrigerant pipe or drain pipe.
Be sure to pass the remote controller cord through upper side of the refrigerant pipe and drain pipe.

3 DRAIN PIPING WORK

CAUTION

- Following the Installation Manual, perform the drain piping work so that water is properly drained, and apply a heat insulation so as not to cause a dew. Inappropriate piping work may result in water leakage in the room and wet of furniture.

Piping/Heat insulating material

Require the following materials for piping and heat insulating at site.

Piping	Hard vinyl chloride pipe VP25 (Outer dia. : Ø32mm)
Heat insulator	Foam polyethylene : Thickness 10mm or more

REQUIREMENT

- Be sure to perform heat insulation of the drain pipes of the indoor unit.
- Never forget to perform heat insulation of the connecting part with the indoor unit. An incomplete heat insulation causes dewing.
- Set the drain pipe with downward slope (1/100 or more), and do not make swelling or trap on the piping. It may cause an abnormal sound.
- For length of the traversing drain pipe, restrict to 20m or less. In case of a long pipe, provide support brackets with interval of 1.5 to 2m in order to prevent waving.

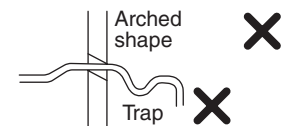
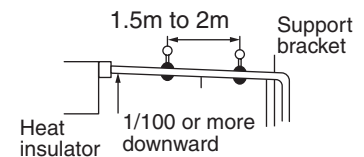

- Set the collective piping as shown in the right figure.
- Be sure not to apply force to the connecting part of the drain pipe.
- The hard vinyl-chloride pipe cannot be directly connected to the drain pipe connecting port of the indoor unit. For connection with the drain pipe connecting port, be sure to use/fix the attached flexible hose with the hose band, otherwise a damage or water leak is caused on the drain pipe connecting port.

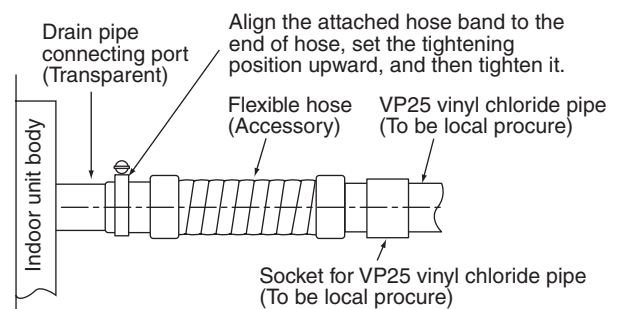
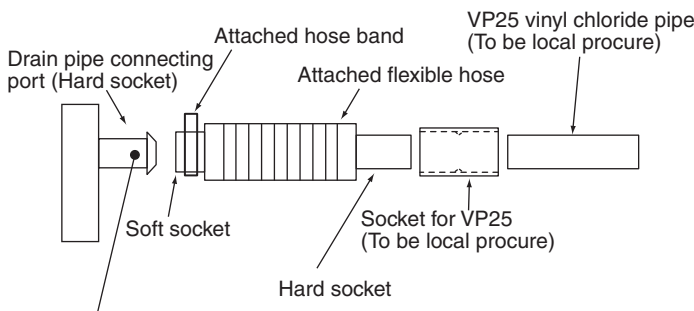
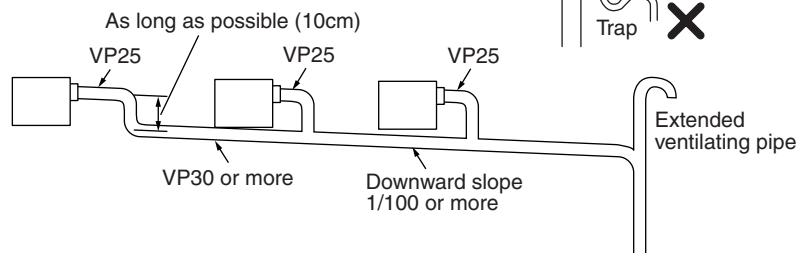

Adhesive inhibited :

Use the attached flexible hose and hose band for connecting the drain hose to the clear drain socket. If applying the adhesive, socket will be damaged and cause water leakage.

Flexible hose

Use the attached flexible hose to adjust core discrepancy of the hard vinyl chloride pipe or to adjust the angle.

- Do not use the flexible hose as stretched, or do not deform it more extent than that in the following figure.
- Be sure to fix the soft end of the flexible hose with the attached hose band.
- Use the flexible hose on a horizontal level.

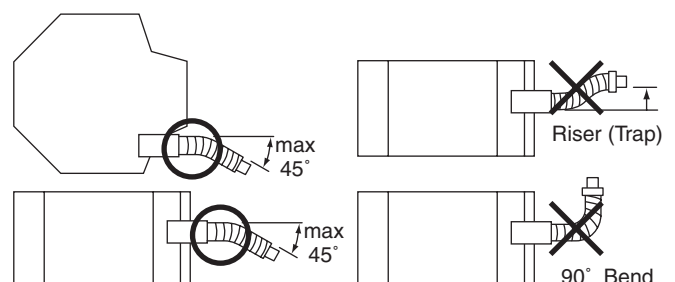

3 DRAIN PIPING WORK

Connection procedure

Connect a socket and a hard vinyl chloride pipe.

- Using adhesive agent for vinyl chloride pipe, connect the drain pipes certainly so that water does not leak.
- It takes approx. 10 hours to dry and harden the adhesive agent. During this period, do not apply force to the connecting part with the drain pipe.

Perform heat insulating.

- As shown in the figure, cover the flexible hose and hose band with the attached heat insulator up to the bottom of the indoor unit without gap.

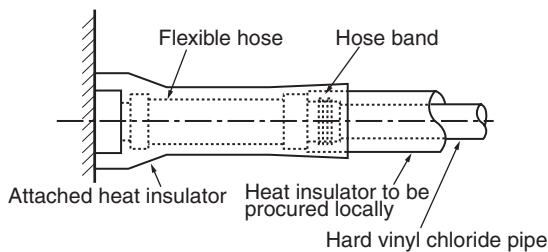

Drain up

When a downward grading cannot be secured on the drain pipe, drain-up up to 640mm is possible.

Set downward grading immediately after raising up vertically.

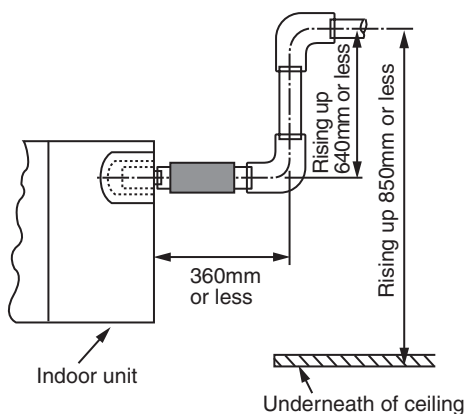

Check the draining

In the test run, check that water drain is properly performed and water does not leak from the connecting part of the pipes.

Be sure to check draining also when installed in heating period.

Using a pitcher or hose, pour water (1500 to 2000cc) into the discharge port before installation of the ceiling panel.

Pour water gradually so that water does not spread on the motor of the drain pump.

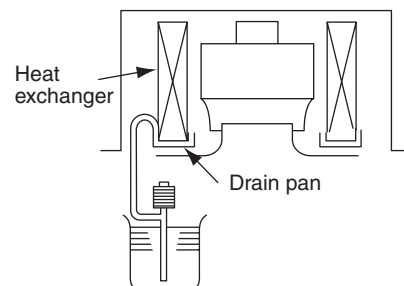

- After the electric work has finished, pour water during COOL mode operation.
- If the electric work has not yet finished, pull out the float switch connector (CN34 : Red) from the electric parts box, and check draining by plugging the single phase 220/230/240V power to the terminal blocks 1 and 2. If doing so, the drain pump motor operates.
- Test water drain while checking the operation sound of the drain pump motor. (If the operation sound changes from continuous sound to intermittent sound, water is normally drained.)

After the check, the drain pump motor runs, connecting the float switch connector.

(In case of check by pulling out the float switch connector, be sure to return the connector to the original position.)

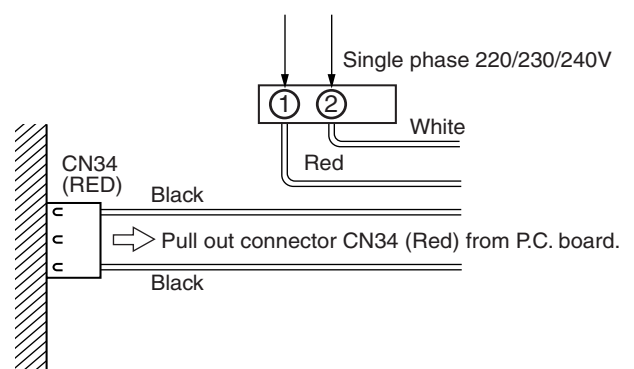

4 REFRIGERANT PIPING

Refrigerant Piping

- If the outdoor units are to be mounted on a wall, make sure that the supporting platform is sufficiently strong. The platform should be designed and manufactured to maintain its strength over a long period of time, and sufficient consideration should be given to ensuring that the outdoor unit will not fall.
- Use copper pipe with 0.8 mm or more thickness.
- Flare nut and flare works are also different from those of the conventional refrigerant. Take out the flare nut attached to the main unit of the air conditioner, and use it.

CAUTION

IMPORTANT 4 POINTS FOR PIPING WORK

- Remove dust and moisture from the inside of the connecting pipes.
- Tight connection (between pipes and unit)
- Evacuate the air in the connecting pipes using VACUUM PUMP.
- Check the gas leakage. (Connected points)

Permissible Piping Length and Heat

The maximum piping length from the outdoor to indoor unit	
30 m (Charge-less 20m) (RAV-SM560AT-E)	50 m (Charge-less 20m) (RAV-SM800 to SM1400AT-E)
The maximum height difference outdoor/indoor unit	
Outdoor unit is above	Outdoor unit is below
30m	15m

Flaring

Insert a flare nut into the pipe, and flare the pipe. As the flaring sizes of R410A differ from those of refrigerant R22, the flare tools newly manufactured for R410A are recommended. However, the conventional tools can be used by adjusting projection margin of the copper pipe.

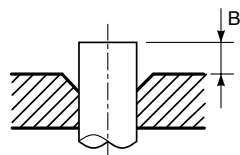

• Projection margin in flaring : B (Unit : mm)

Rigid (Clutch type)

Outer diam. of copper pipe	R410A tool used		Conventional tool used	
	R410A	R22	R410A	R22
6.4 to 15.9	0 to 0.5	(Same as left)	1.0 to 1.5	0.5 to 1.0

Imperial (Wing nut type)

Outer diam. of copper pipe	R410A	R22
6.4 or 9.5	1.5 to 2.0	1.0 to 1.5
12.7 or 15.9	2.0 to 2.5	1.5 to 2.0

• Flaring dia meter size : A (Unit : mm)

Outer diam. of copper pipe	A ⁺⁰ / _{-0.4}	
	R410A	R22
6.4	9.1	9.0
9.5	13.2	13.0
12.7	16.6	16.2
15.9	19.7	19.2

- * In case of flaring for R410A with the conventional flare tool, pull it out approx. 0.5 mm more than that for R22 to adjust to the specified flare size. The copper pipe gauge is useful for adjusting projection margin size.

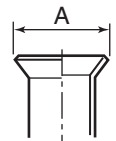

Tightening connection

CAUTION

- Do not apply excessive torque. Otherwise, the nut may crack depending on the conditions.

(Unit : N•m)

Outer diam. of copper pipe	Tightening torque
6.4 mm (diam.)	14 to 18 (1.4 to 1.8 kgf•m)
9.5 mm (diam.)	33 to 42 (3.3 to 4.2 kgf•m)
12.7 mm (diam.)	50 to 62 (5.0 to 6.2 kgf•m)
15.9 mm (diam.)	63 to 77 (6.3 to 7.7 kgf•m)

• Tightening torque of flare pipe connections

Pressure of R410A is higher than that of R22.

(Approx. 1.6 times) Therefore, using a torque wrench, tighten the flare pipe connecting sections which connect the indoor and outdoor units of the specified tightening torque. Incorrect connections may cause not only a gas leak, but also a trouble of the refrigeration cycle.

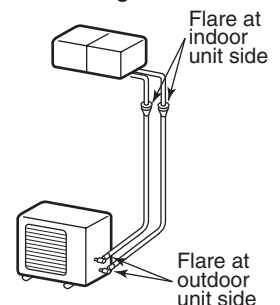

Align the centers of the connecting pipes and tighten the flare nut as far as possible with your fingers. Then tighten the nut with a spanner and torque wrench as shown in the figure.

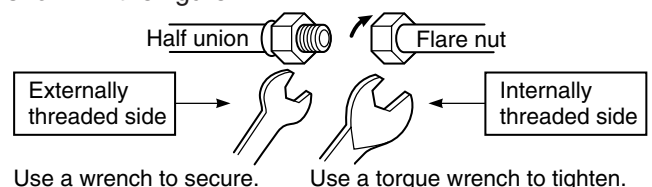

5 EVACUATING

AIR PURGE

Evacuate the air in the connecting pipes and in the indoor unit using vacuum pump.
Do not use the refrigerant in the outdoor unit.
For details, see the manual of vacuum pump.

Use a vacuum pump

Be sure to use a vacuum pump with counter-flow prevention function so that inside oil of the pump does not flow backward into pipes of the air conditioner when the pump stops.

1. Connect the charge hose from the manifold valve to the service port of the gas side packed valve.
2. Connect the charge hose to the port of vacuum pump.
3. Open fully the low pressure side handle of the gauge manifold valve.
4. Operate the vacuum pump to start evacuating.

Perform evacuating for about 35 minutes if the piping length is 30 meters total for model SM560 and 50 meters for model SM800 (assuming a pump capacity of 27 liters per minute.) Then confirm that the compound pressure gauge reading is -101 kPa (-76 cmHg).

5. Close the low pressure side valve handle of gauge manifold.
6. Open fully the valve stem of the packed valves (both sides of Gas and Liquid).
7. Remove the charging hose from the service port.
8. Securely tighten the caps on the packed valves.

REQUIREMENT

For the tools such as charge hose, etc., use those manufactured exclusively for R410A.

Refrigerant amount to be added

For addition of the refrigerant, add refrigerant "R410A" referring to the attached Installation Manual.

Be sure to use a scale to charge the refrigerant of specified amount.

REQUIREMENT

- Charging an excessive or too little amount of refrigerant causes a trouble of the compressor. Be sure to charge the refrigerant of specified amount.
- A personnel who charged the refrigerant should write down the pipe length and the added refrigerant amount in the nameplate attached to the service panel of the outdoor unit. It is necessary to troubleshoot the compressor and refrigeration cycle malfunction.

Open the valve fully

Open the valve of the outdoor unit fully. A 4mm-hexagonal wrench is required for opening the valve.

Gas leak check

Check with a leak detector or soap water whether gas leaks or not, from the pipe connecting section or cap of the valve.

REQUIREMENT

Use a leak detector manufactured exclusively for HFC refrigerant (R410A, R134a, etc.).

Thermal insulation process

Apply thermal insulation for the pipes separately at liquid side and gas side.

For the thermal insulation to the pipes at gas side, be sure to use the material with heat-resisting temperature 120°C or higher.

Using the attached thermal insulation material, apply the thermal insulation to the pipe connecting section of the indoor unit securely without gap.

REQUIREMENT

Apply the thermal insulation to the pipe connecting section of the indoor unit securely up to the root without exposure of the pipe. (The pipe exposed to the outside causes water leak.)

Packed valve handling precautions

- Open the valve stem all the way out ; do not try to open it beyond the stopper.
- Securely tighten the valve stem cap at the torque as follows:

Gas side (15.9 mm (diam.))	20 to 25 N•m (6.3 to 7.7 kgf•m)
Gas side (12.7 mm (diam.))	33 to 42 N•m (5.0 to 6.2 kgf•m)
Gas side (9.5 mm (diam.))	33 to 42 N•m (3.3 to 4.2 kgf•m)
Liquid side (6.4 mm (diam.))	14 to 18 N•m (1.4 to 1.8 kgf•m)
Service port	14 to 18 N•m (1.4 to 1.8 kgf•m)

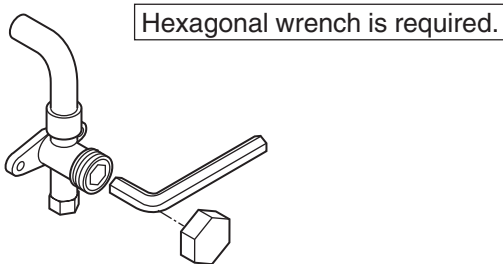

- As shown in the figure, be sure to use a double spanner to loosen or tighten the flare nut of the valve at gas side. If using a single spanner, the nut cannot be tightened with necessary tightening torque. On the contrary, use a single spanner to loosen or tighten the flare nut of the valve at liquid side.

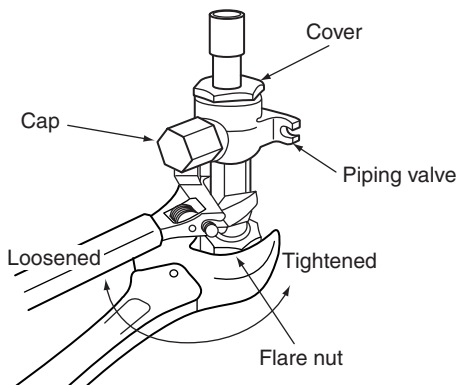

Valve at gas side

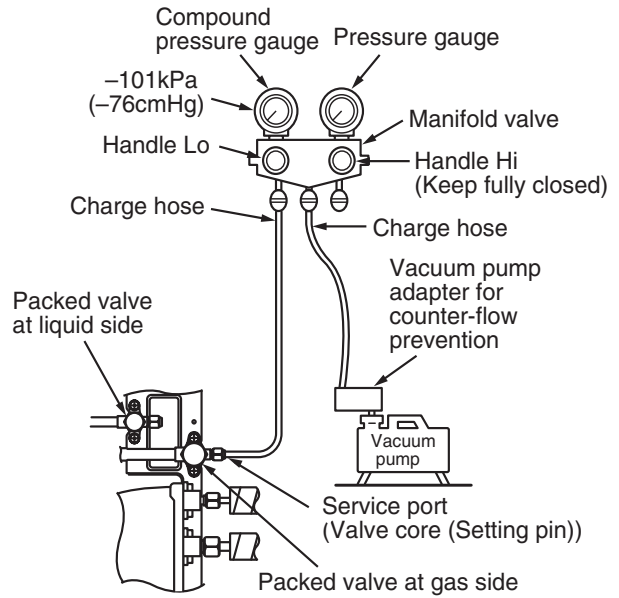
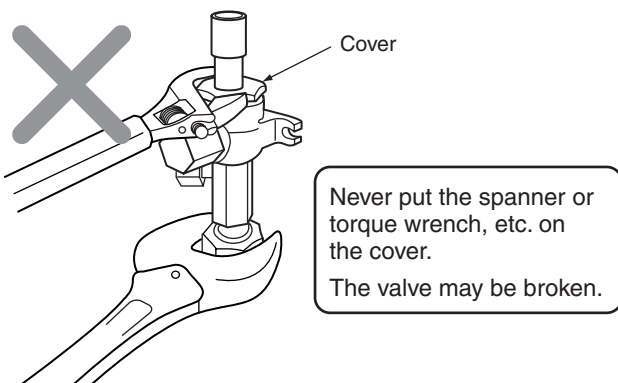

6 ELECTRICAL WORK

WARNING

1. **Using the specified cables, ensure to connect the wires, and fix wires securely so that the external tension to the cables do not affect the connecting part of the terminals.**

Incomplete connection or fixation may cause a fire, etc.

2. **Be sure to connect earth wire. (Grounding work)**

Do not connect the earth wire to gas pipe, city water pipe, lightning rod, or the earth wire of telephone. Incomplete grounding causes an electric shock.

3. **For electric work, strictly follow the Local Regulation in each country and the Installation Manual, and use an exclusive circuit.**

Capacity shortage of power circuit or incomplete installation may cause an electric shock or a fire.

CAUTIONS

- This indoor unit has no power cord.
- If incorrect/incomplete wiring is carried out, it will cause an electrical fire or smoke.
- Be sure to install an earth leakage breaker that is not tripped by shock waves.
If an earth leakage breaker is not installed, an electric shock may be caused.
- Be sure to use the cord clamps attached to the product.
- Do not damage or scratch the conductive core and inner insulator of power and inter-connecting cables when peeling them.
- Be sure to comply with local regulations on running the wire from outdoor unit to indoor unit (size of wire and wiring method etc.)
- Use the power cord and Inter-connecting cable of specified thickness, type, and protective devices required.

REQUIREMENT

- For power supply wiring, strictly conform to the Local Regulation in each country.
- For wiring of power supply of the outdoor units, follow the Installation Manual of each outdoor unit.
- Never connect 220–240V power to the terminal blocks (A, B, etc.) for control wiring.
(Otherwise, the system will fail.)
- Perform the electric wiring so that it does not come to contact with the high-temperature part of the pipe.
The coating may melt resulting in an accident.
- After connecting cables to the terminal blocks, provide a trap and fix cables with the cable clamp.
- Run the refrigerant piping line and control wiring line in the same line.
- Do not turn on the power of the indoor unit until vacuuming of the refrigerant pipes completes.

Remote controller wiring

2-core non polarity cable is used for the remote controller wiring.

How to wire

1. Connect the connecting cable to the terminal as identified with their respective numbers on the terminal block of indoor and outdoor unit. H07 RN-F or 245 IEC 66 (1.5 mm² or more)
2. Insulate the unsheathed redundant cords (conductors) with electrical insulation tape.
Process them so that they do not touch any electrical or metal parts.
3. For inter-unit wiring, do not use a wire jointed to another on the way.

Cable connection

REQUIREMENT

- Be sure to connect the cables matching the terminal numbers. Incorrect connection causes a trouble.
 - Be sure to pass the cables through the bushing of cabling connection port of the indoor unit.
 - Keep a margin (Approx. 100mm) on a cable to hang down the electric parts box at servicing, etc.
 - The low-voltage circuit is provided for the remote controller. (Do not connect the high-voltage circuit)
-
- Remove the cover of the electric parts box by taking off the mounting screws (3 positions) and pushing the hooking section. (The cover of the electric parts box remains hanged to the hinge.)
 - Connect the indoor/outdoor connection cables and REMOCON cable to the terminal block of the electric parts box. (Do not apply tension to the connecting section of the terminal block.)
 - Tighten the screws of the terminal block, and fix the cables with cord clamp attached to the electric parts box. (Do not apply tension to the connecting section of the terminal block.)
 - Using the attached thermal insulation material, seal the pipe connecting port. Otherwise, dewing may be caused.
 - Mount the cover of the electric parts box without pinching cables. (Mount the cover after cabling on the ceiling panel.)

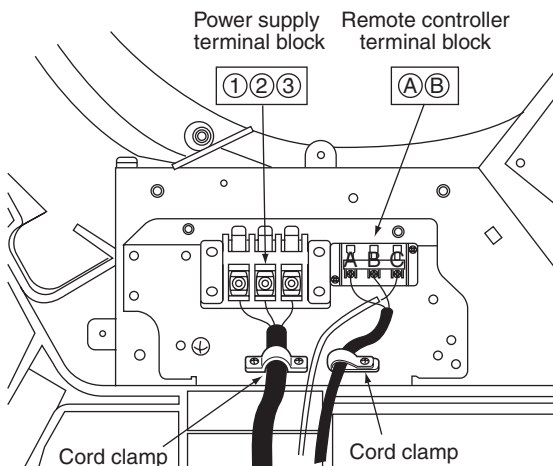
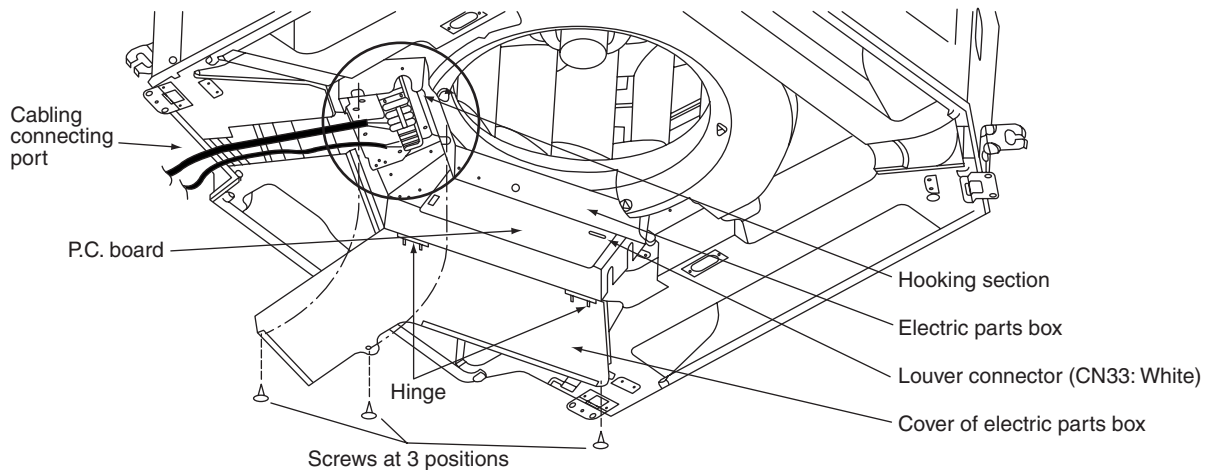

<Thermal insulation to cabling connecting port>

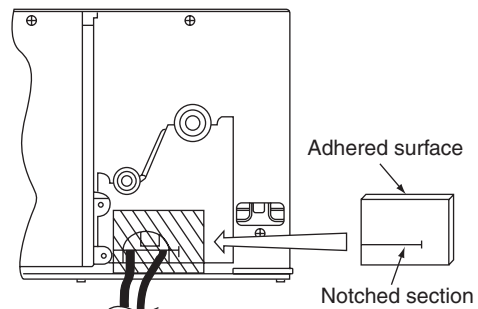

Cabling on the ceiling panel

According to the Installation Manual of the ceiling panel, connect the connector (5P: White) of the ceiling panel to the connector (CN33: White) on P.C. board of the electric parts box.

6 ELECTRICAL WORK

Cabling

1. Remove a screw and then remove cover of the electric parts box.
2. Strip wire ends (10 mm).
3. Match wire colors with terminal numbers on indoor and outdoor units' terminal blocks and firmly screw wires to the corresponding terminals.
4. Connect the ground wires to the corresponding terminals.
5. Fix the cable with cord clamp.
6. Fix cover of the parts box and the terminal block surely with the fixing screws.

Make a loop on the cable for margin of the length so that the electric parts box can be taken out during servicing.

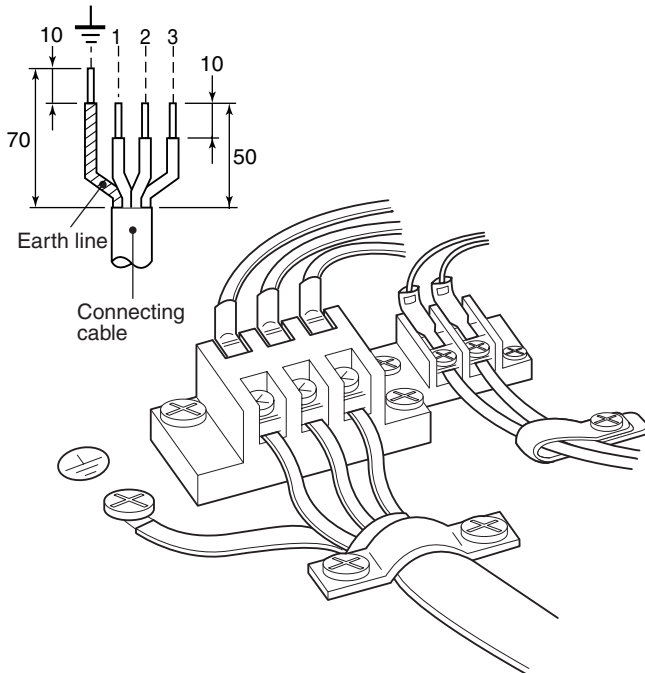

Remote Controller Cabling

- Strip off approx. 14mm the cable to be connected.
- Non polarity, 2 core cable is used for cabling of the remote controller.
- Twist cable of the remote controller to be connected with cable of the remote controller unit (or sensor), and press-fit them with a wire joint.
Wire joints (White: 2 pieces) are included in the attachments to the remote controller (sold separately) or the wireless remote controller kit (sold separately).

Cabling diagram

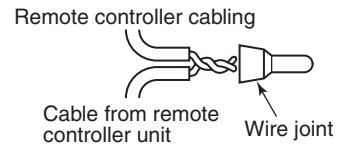
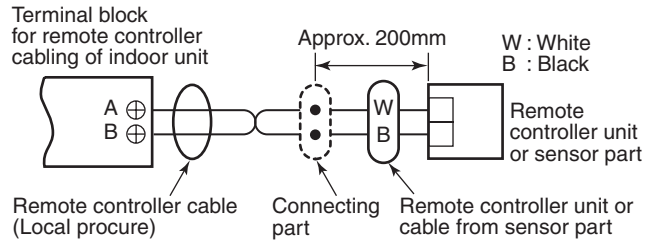

Wiring diagram

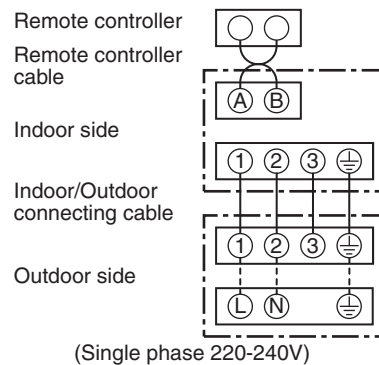

- For details of cabling/installation of the remote controller, refer to the Installation Manual attached to in the remote controller.

7 TEST RUN

Before test run

- Before turning on the power supply, carry out the following procedure.
 - 1) Using 500V-megger, check 1MΩ or more exists between the terminal block 1 to 3 and the earth.
If 1MΩ or less is detected, do not run the unit. Do not apply to the remote controller circuit.
 - 2) Check the valve of the outdoor unit being opened fully.
- To protect the compressor at activation time, leave power-ON for 12 hours or more before operating.

How to execute a test run

Using the remote controller, operate the unit as usual.

For the procedure of the operation, refer to the attached Owner's Manual.

A forced test run can be executed in the following procedure if the operation stops by thermo.-OFF.

In order to prevent a serial operation, the forced test run is released after 60 minutes have passed and returns to the usual operation.

CAUTION

When the remote controller is used for the first time, it accepts an operation approx. 5 minutes after the power supply has been turned on.

It is not a trouble, but is because the setup of the remote controller is being checked.

For the second power-ON time and after, approx. 1 minute is required to start the operation by the remote controller.

NOTE

Do not use the forced test run for cases other than the test run because it applies an excessive load to the devices.

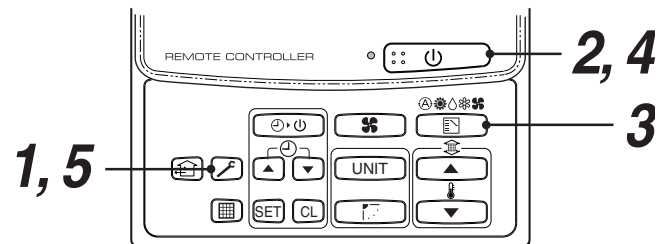

In case of wired remote controller

Procedure	Description	
1	Keep button pushed for 4 seconds or more. [TEST] is displayed on the display part and the selection of mode in the test mode is permitted.	
2	Push button.	
3	Using button, select the operation mode, [COOL] or [HEAT]. <ul style="list-style-type: none"> • Do not run the air conditioner in a mode other than [COOL] or [HEAT]. • The temperature controlling function does not work during test run. • The detection of error is performed as usual. 	
4	After the test run, push button to stop a test run. (Display part is same as procedure 1 .)	
5	Push check button to cancel (release from) the test run mode. ([TEST] disappears on the display and the status returns to a normal.)	

8 TROUBLESHOOTING

Confirmation and check

When a trouble occurred in the air conditioner, the check code and the indoor unit No. appear on the display part of the remote controller.

The check code is only displayed during the operation.
If the display disappears, operate the air conditioner according to the following "Confirmation of error history" for confirmation.

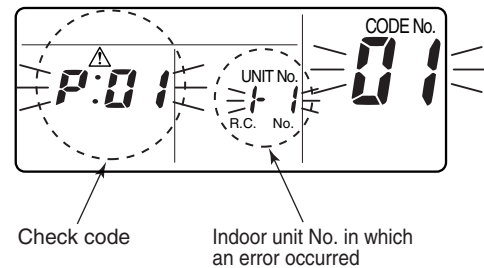

Confirmation of error history

When a trouble occurred on the air conditioner, the trouble history can be confirmed with the following procedure. (The trouble history is stored in memory up to 4 troubles.)

The history can be confirmed from both operating status and stop status.

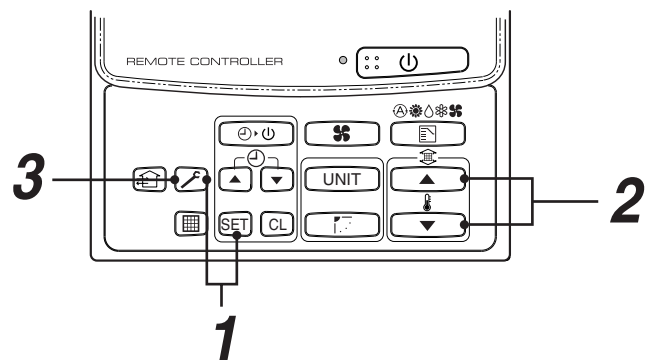

Procedure	Description
1	<p>When pushing [SET] and buttons at the same time for 4 seconds or more, the following display appears.</p> <p>If [Service check] is displayed, the mode enters in the trouble history mode.</p> <ul style="list-style-type: none"> • [01 : Order of trouble history] is displayed in CODE No. window. • [Check code] is displayed in CHECK window. • [Indoor unit address in which an error occurred] is displayed in UNIT No.
2	<p>Every pushing of [,] button used to set temperature, the trouble history stored in memory is displayed in order.</p> <p>The numbers in CODE No. indicate CODE No. [01] (latest) → [04] (oldest).</p> <p>REQUIREMENT</p> <p>Do not push button because all the trouble history of the indoor unit will be deleted.</p>
3	<p>After confirmation, push button to return to the usual display.</p>

1. Check the troubles according to the above procedure.
2. Ask an authorized dealer or qualified service (maintenance) professional to repair or maintain the air conditioner.
3. More details of the service code are explained in Service Manual.

9 MAINTENANCE

Before maintenance, be sure to turn off the leakage breaker.

Cleaning of air filter

- If  is displayed on the remote controller, maintain the air filter.
- Clogging of the air filter reduce cooling/heating performance.

Cleaning of panel and air filter

Preparation :

1. Turn off the air conditioner by the remote controller.
2. Open the suction air port.
 - Slide the button of the suction air port inward, and open the suction port slowly while holding it.

Clean the panel and air filter with water:

- Wipe down the panel and air filter with a sponge or towel moistened with a kitchen detergent. (Do not use any metallic brush for cleaning.)
- **Carefully rinse the panel and air filter to wash out the detergent.**
- **After rinsing the panel and air filter with water, dry it in the shade.**

3. Close the suction air port.
 - Close the suction air port, slide the button outward, and fix the suction port securely.

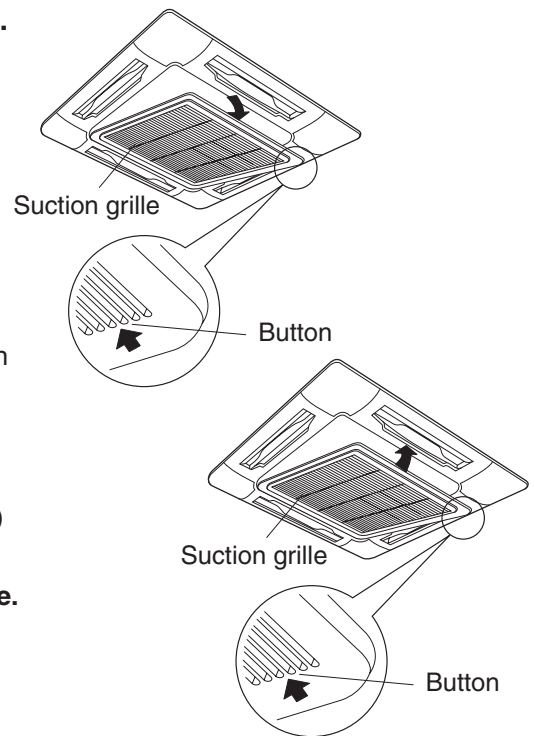

CAUTION

- Do not start the air conditioner while leaving the panel and air filter removed.
- Push the filter reset button.  indication will be turn off.)

Cleaning of Air Filters

- If the air filters are not cleaned, it not only reduce the cooling a performance of air conditioner but causes a failure in the air conditioner such as water falling in drops.

Preparation :

1. Stop the operation by remote controller.
2. Dismount the air filter.

Use a vacuum cleaner to remove dust from the filters or wash them with water.

- After rinsing the air filters with water, dry them in the shade.
- Set the air filter into the air conditioner.

Cleaning of discharge flap

The discharge flap can be removed to clean.

1. Remove the discharge flap.
 - Holding the both ends of the discharge flap, remove the flap sagging the center downward.
2. Cleaning with water
 - If the dirt is terrible, clean the flap by tepid water with neutral detergent or water.
3. Mount the discharge flap.
 - First push in one side of the flap, and then insert the other side sagging the center downward.

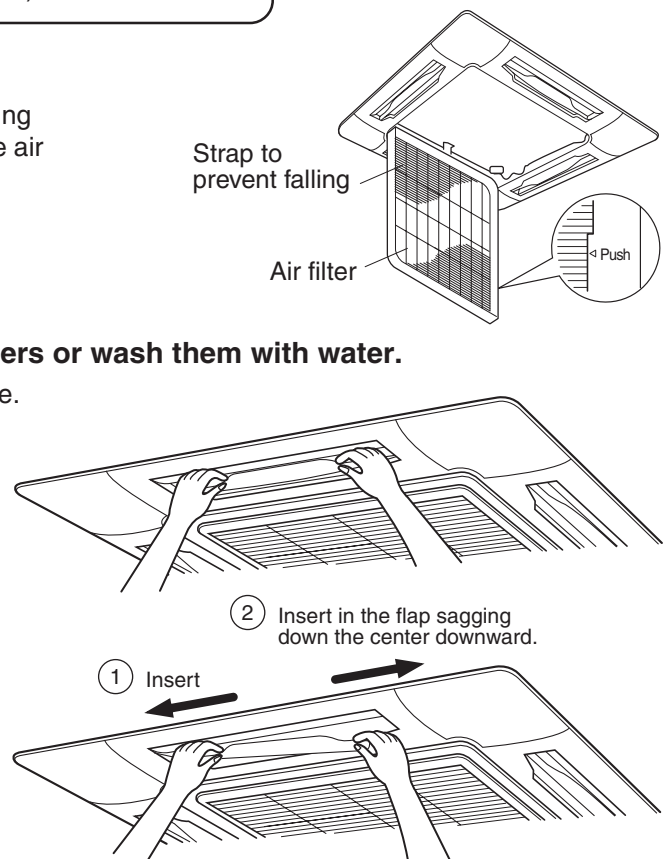

Be careful to the direction of the flap when mounting.

Mount the flap so that the side with the mark faces upward and the arrow direction of the mark directs.

ACCESSORIES

CONTENTS

OWNER'S MANUAL

REMOTE CONTROLLER FOR AIR CONDITIONER (SPLIT TYPE)

<Wireless Type>

TCB-AX21U (W)-E 48

WEEKLY TIMER FOR AIR CONDITIONER (SPLIT TYPE)

<Program Weekly Timer Type>

RBC-EXW21E 56

REMOTE CONTROLLER FOR AIR CONDITIONER

<Simple Operation Type>

RBC-AS21E 62

INSTALLATION MANUAL

Ceiling Panel

RBC-U21PG (W)-E 65

Standard Remote Controller

RBC-AMT21E 67

Simple Remote Controller

RBC-AS21E 68

Program Weekly Timer

RBC-EXW21E 69

Remote sensor

TCB-TC21LE 70

Drain-up Kit for Concealed Duct Type Indoor Unit

TCB-DP11BE 71

Remote Controller Wireless Kit

TCB-AX21U (W)-E 72

Network Adapter for Air Conditioner (Use for Indoor Unit Only)

TCB-PCNT20E 73

OWNER'S MANUAL

REMOTE CONTROLLER FOR AIR CONDITIONER (SPLIT TYPE)

<Wireless Type>

TCB-AX21U (W)-E

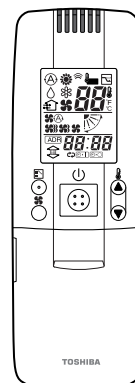

Thank you very much for purchasing TOSHIBA Remote Controller for Air Conditioner.

Please read this owner's manual carefully before using your Remote Controller for Air Conditioner.

- Be sure to obtain the "Owner's manual" and "Installation manual" from constructor (or dealer).

Request to constructor or dealer

Please clearly explain the contents of the Owner's manual and hand over it.

CONTENTS

PRECAUTIONS FOR SAFETY	49
NAME AND OPERATION	49
HOW TO SET THE FAN SPEED	50
HOW TO OPERATE THE UNIT	52
HOW TO OPERATE THE TIMER	52
HOW TO ADJUST AIR DIRECTION	53
SLIDE SWITCH	53
HOW TO INSERT THE BATTERIES	53
HOW TO HANDLE THE REMOTE CONTROLLER	54
HOW TO USE THE REMOTE CONTROLLER CORRECTLY	54
ADDRESS	54
HOW TO PERFORM EMERGENCY OPERATION	54
BEFORE ASKING REPAIR WORK	55

PRECAUTIONS FOR SAFETY

WARNING

WARNINGS ABOUT INSTALLATION

- Make sure to ask the qualified installation professional in electric work to install the remote controller. If the remote controller is inappropriate installed by yourself, it may cause, electric shock, fire, and so on.

WARNINGS ABOUT OPERATION

- When you are aware of something abnormal with the air conditioner (smells like something etc.), immediately turn off the main power supply switch or circuit breaker, from the mains to stop the air conditioner, and make contact with the dealer. If the air conditioner is continuously operated with something abnormal, it may cause machine failure, electric shock, fire, and so on.

WARNINGS ABOUT MOVEMENT AND REPAIR

- Do not repair any unit by yourself.
- Whenever the air conditioner needs repair, make sure to ask the dealer to do it. If it is repaired imperfectly, it may cause electric shock or fire.

CAUTION

CAUTIONS ABOUT OPERATION

- Carefully read this manual before starting the air conditioner. There are many important things for the safety and the correct usage.
- Do not touch any switches with wet finger, otherwise you may get an electric shock.
- When the air conditioner was not be used for a considerably long time, turn off the main switch or the circuit breaker, for safety. Disconnect from the power supply prevents the unit from lightning and power supply surge.
- Prevent any liquid from falling into the remote controller. Do not spill juice, water or any kind of liquid.

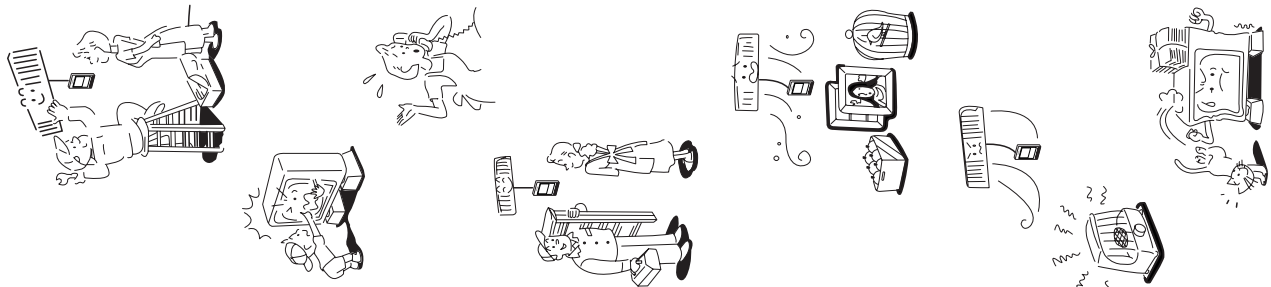

NAME AND OPERATION

Remote Controller

- Max. 8 indoor units can be operated by a remote controller as a group.

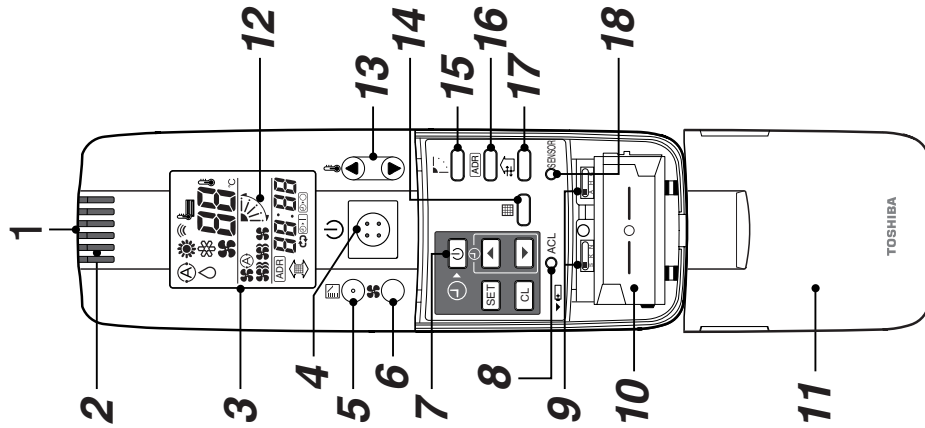

- 1 Transmitting part**
The remote controller sensor is sensed when the sensor button is pushed to remote controller side.
- 2 Remote controller sensor**
The peripheral temperature is sensed when the sensor button is pushed to remote controller side.
- 3 Mode display section**
The operation mode is displayed.
- 4 Start/Stop button**
Pushing this button starts, and pushing again stops the unit.
- 5 Mode Select button**
Pushing this button selects an operation mode.
- 6 Air volume button**
Time Setup button
This button is used when the timer is setup.
- 8 Reset button**
This button is used after replacement of battery or selection of slide switch.
- 9 Slide switch**
- 10 Part storing batteries**
- 11 Cover**
Slide the cover holding its both sides.
- 12 AUTO flap display differs according to the installed unit.**
- 13 Setup Temp. button**
Every pushing this button, temperature rises by 1°C.
Every pushing this button, temperature lowers by 1°C.
- 14 Filter button**
The remote controller is not operated even if this switch is pushed.
- 15 Swing/Air direction button**
- 16 Address button**
- 17 Ventilation button**
The remote controller is not operated even if this switch is pushed.
- 18 Sensor button**
This button is used when selecting the temp. sensor at the remote controller side. At the shipment from the factory, this button is set to the temp. sensor at the indoor unit.

- The signal receiving part is mounted to the ceiling panel.

Signal Receiving Part

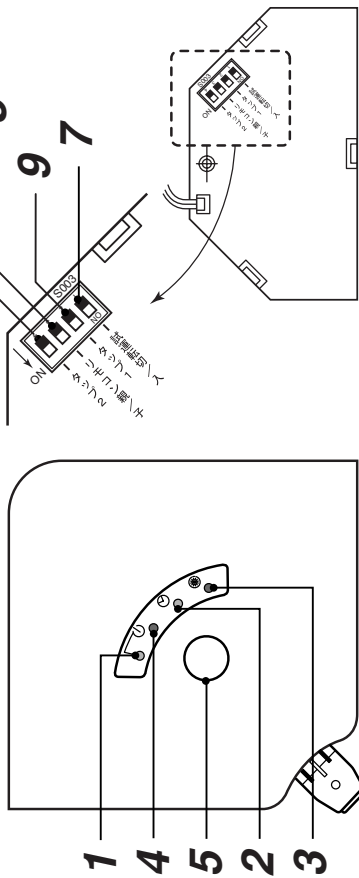

- 1 Emergency operation button**
- 2 Signal receiving part**
The signal sent from the remote controller is received.
- 3 Display lamp**
One of displays flashed while a trouble occurs. When the display lamp flashes, refer to "Before asking of repair".
- 4 lamp**
This lamp goes on during operation.
- 5 lamp**
This lamp goes on while the timer is reserved.
- 6 lamp**
 - In heating operation this lamp in the following cases,
The operation has started.
The temp. controller has worked.
The unit is under defrost operation.
 - This lamp flashes while a trouble occurs.
- 7 試運転転入 (S003-1) Trial ON switch**
This switch is not used in normal time, but used in trial operation time.
- 8 リモコン親 / リモコン子 (S003-3) Priority/Secondary switch**
Use this switch at the position of [リモコン親 (PRIORITY)]. This switch can be used together with the wired remote controller.
- 9 Fan speed change tap 1 (S003-2)**
- 10 Fan speed change tap 2 (S003-4)**
These switches are used to select DC motor speed of a 4-way cassette type indoor unit by the taps.
When installing an indoor unit to a high ceiling surface or when changing the number of discharge ports, perform setting referring to the next page.
- 11 Address switch**
This switch distinguishes the signal, send or receive.

The following switches are provided to the rear side of the receiving part. For setup, contact the shop which you purchased the unit.

- If "pi, pi" sound is heard, the MODE lamp of the display lamp goes on, and the lamp and lamp flash alternately, the operation is not performed with the desired mode.

HOW TO SET THE FAN SPEED

When installing a 4-way cassette type indoor unit to high ceiling of a room, the fan motor speed can be selected in agreement with height of the ceiling and numbers of the discharge port. For details, refer to the Installation Manual for 4-way discharge cassette type unit.

Setup No.	Tap 1	Tap 2	Installable ceiling height (Unit: m)							
			RAV-SM560UTE		RAV-SM800UTE		RAV-SM1120UTE RAV-SM1400UTE			
			4-ways	3-ways	4-ways	3-ways	4-ways	3-ways	4-ways	3-ways
(0)	OFF	OFF	2.8	3.2	3.5	3.0	3.3	3.6	3.9	4.2
Setting at shipment										
(1)	OFF	ON	3.2	3.5	3.8	3.3	3.5	3.8	4.1	4.3
(3)	ON	OFF	3.5	3.8	—	3.6	3.8	—	4.2	4.3

The fan motor speed is selected by Dip switch [S003] on the sensor P.C. board inside or the adjust corner cap (including sensors) of the ceiling panel of 4-way discharge cassette type indoor unit.

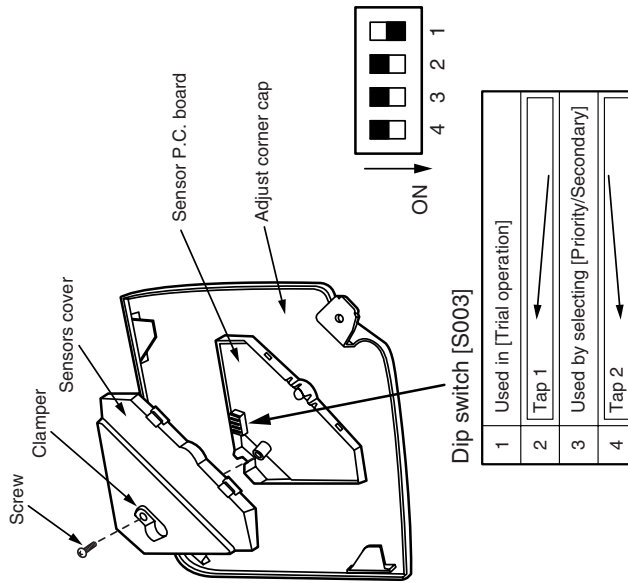

- After selecting a fan motor speed, reassemble the ceiling panel as before. Using a clamper, fix the cable connectors with screws.







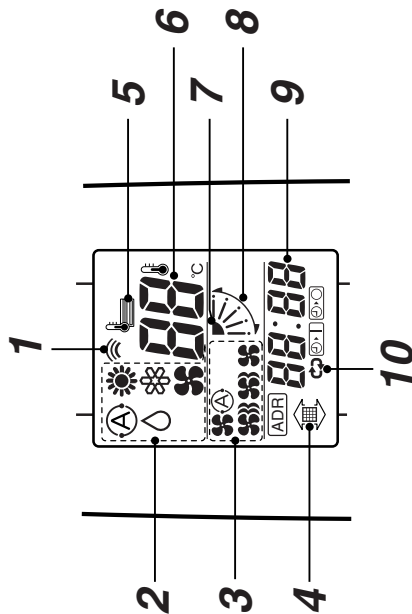

Display Section

All indicators are shown in the right and the lower figures for the explanation.

Only selected contents are display in actual operation.

- When turning on the leakage breaker at the first time 3 minutes later, [SET DATA] flashes about for 1 minute on the display part of the remote controller. While this display is flashing, the model is being automatically confirmed. Accordingly, wait for 1 minute after [SET DATA] display has disappeared, and then use the remote controller.



- 1 Transmitting indication**
Displayed while operating the switches of the remote controller.
- 2 Mode display**
The selected operation mode is displayed.
- 3 Fan mode select display**
The selected fan mode is displayed.
(AUTO) 
(HIGH) 
(MED.) 
(LOW) 
- 4 Filter display**
If "FILTER" is displayed, clean the air filter.
- 5 CHECK display**
Displayed while the protective device works or a trouble occurs.
- 6 Set up temperature display**
The selected set up temp. is displayed.
- 7 Flap position display**
- 8 SWING display**
Displayed during up/down movement of the flap.
- 9 Timer time display**
Time of the timer is displayed.
(When a trouble occurs, the check code is displayed.)
- 10 Timer SETIN setup display**
When pushing the Timer SET button, the display of the timer is selected in order of [OFF]   [ON]
  No display.

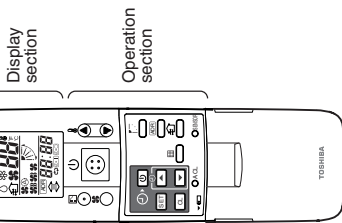



Operation Section

Push each button to select a desired operation.

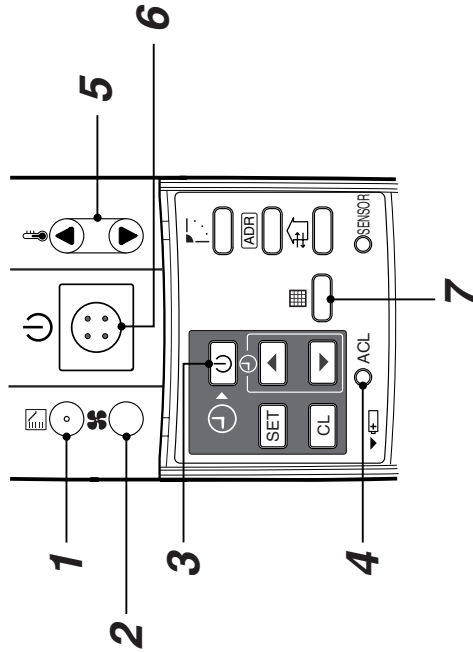
- The details of the operation needs to be set up once, afterward, the air conditioner can be used by pushing  button only.



- 1 Operation select button**
Selects desired operation mode.
 - 2 Fan mode select button**
Selects a fan mode.
 - 3 Timer set button**
TIMER SET button is used when the timer is set up.
 - 4 Check button**
CHECK button is used for check operation. During normal operation, do not use this button.
 - 5 Temperature set button**
Adjusts required room temperature. Set required set temperature by pushing  or .
 - 6 Start/Stop button**
When the button is pushed, operation starts, and it stops by pushing the button again. When the operation stops, the operation lamp and all displays disappear.
 - 7 Filter reset button**
Resets (Erases) "FILTER" display.
- OPTION :**
- Remote controller sensor**
Usually the TEMP. sensor of the indoor unit measured a temperature. A temperature around the remote controller can also be measured. For details, contact the dealer from which you have purchased the air conditioner.

HOW TO OPERATE THE UNIT

Cool/Heat AUTO, Heat, Dry, Cool, Fan

Power supply

Turn on the power of the wireless remote controller 12 hours before starting the operation.

- After the power supply has been turned on, the operation of the remote controller is not accepted for approx. 1 minute. It is not a failure. (The sensor receives the signal once, but the received contents are cleared.)

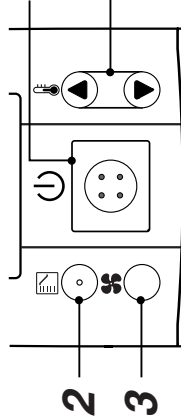

- 1 Push Start/Stop button.
- 2 Push (Operation Select button) operation to select one of (A), (B), and (C).
- 3 Push (Fan Mode Select button) to select one of fan speed modes. When selecting (A), the fan speed is automatically changed. (During FAN mode, the air speed is not automatically changed.)

4 Push either or to select the desired temperature.

- During FAN mode, the temperature cannot be set up.

5 Stop

Push Start/Stop button.

When using the remote controller to stop the unit, the outdoor unit fan may keep operating for a while even if the compressor of the outdoor unit has stopped.

- In heating operation, if the room is not comfortably heated with FAN (A) or (B), select FAN (C) or (D). Although they are displayed, the function may not be provided according to the used indoor unit. (Fan speed is constant.)
- When the unit cannot be stopped by the normal operation Turn off the power switch or leakage breaker, and then contact the shop which you purchased the unit.

Automatic cool/heat

When all indoor units in the identical refrigerant system are controlled as a group, the cooling/heating operation is automatically performed with the difference between the setup temperature and the room temperature.

Dry operation

- There is no dry function according to the used indoor unit even if DRY is displayed on the display section of the remote controller. (Same to Cooling operation)
- When the room temperature approaches the setup temperature, running/stop operations are automatically repeated.
- In order not to return humidity to the room as possible, the mode of indoor fan enters LOW mode when the operation has stopped.
- The fan speed cannot be adjusted according to the used indoor unit or status of the room temperature.
- The DRY mode cannot be used according to the used indoor unit when the outdoor temperature is 15 °C or lower.

HOW TO OPERATE THE TIMER

- After setting of the timer, set the remote controller at a position where the signal can reach the sensors (indoor unit body).
- (The signal of the timer operation is sent from the remote controller.)
- Set up the timer during display of the operation mode.

Use in the following cases	During display
To stop the air conditioner after the previously set time has passed	
To stop the air conditioner every time after the previously set time has passed	
To operate the air conditioner after the previously set time has passed	

<Use example>

How to use OFF timer

(Ex.) To stop the unit 30 minutes after

- 1 When pushing the timer once, and the time flash on the remote controller.
- 2 Push TIME or to set the time to 0.5.
- 3 Push and the go on timer.

How to use the repeat timer

(Ex.) To stop the air conditioner every time after 2.5 hours has passed

- 1 When pushing the timer twice, and the time flash on the remote controller.
- 2 Push TIME or to set the time to 2.5.
- 3 Push and the go on timer.

The works, and the operation stops after 2.5 hours. When pushing (Start/Stop) button again to operate the unit, the operation stops after 2.5 hours.

How to use ON timer

(Ex.) To operate the unit 8 hours after

- 1 When pushing the timer three times, and the timer flash on the remote controller.
- 2 Push TIME or to set the time to 8.0.
- 3 Push The operation mode display disappears, and then time and the go on.

To stop the timer operation

To stop the timer operation Push button. Then the timer display disappears.

Timer time

Every pushing the setup time increases by 0.5 hour (30 minutes). The maximum time to be set is 72.0 hours.

Every pushing the setup time decreases by 0.5 hour (30 minutes). The minimum time to be set is 0.5 hours.

Timer display

Every pushing the display changes as follows;

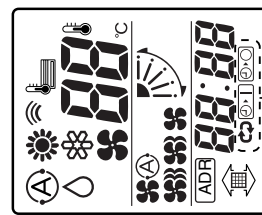

No display



HOW TO ADJUST AIR DIRECTION

- Never move the flap (Air direction up/down adjusting plate) which is operated on the remote controller with hands except a case of cleaning of the flap.
- While the unit stops, the flap (Air direction up/down adjusting plate) directs downward automatically.
- During preparation of heating, the flap (Air direction up/down adjusting plate) directs upward. The swinging operation starts after heating preparation status has been cleared. However, swinging is displayed on the AUTO flap display of the remote controller even if the heating operation is being prepared.

How to set up the air direction

Every pushing  button during operation, the air direction changes.

How to start swinging

When pushing  button, set the direction of the flap (Air direction up/down adjusting plate) to the lowest position, and then push  button again, the swinging is displayed and the air direction automatically changes upward/downward.

How to stop swinging

Pushing  button once again during swinging of the flap stops the flap at the desired position. Then, when pushing  button, the air direction can be set to position from the uppermost position.

- In cooling or dry operation, the flap does not stop when the flap directs downward. If doing so, the flap stops at the 3rd position from the uppermost position.

In heating operation

Direct the flap (Air direction up/down adjusting plate) downward, otherwise the hot air may not reach at the foot.



In cooling/dry operation

Direct the flap (Air direction up/down adjusting plate) upward, otherwise dewdrops may adhere or drip down to near of the discharge grille.



In air blowing operation



In all operation modes



Display when swinging stopped



Fan/Heat operation

Cool/Dry operation

SLIDE SWITCH

- Do not change setting of the slide switch because a malfunction occurs by other settings.
- Before usage, check the slide switch is set to the position as follows;

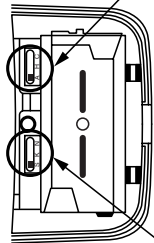

Removal of battery cover

Slide switch position	Corresponding model for change of flap	Operation mode display of remote controller
	Flashing position on remote controller	Slide switch position

HOW TO INSERT THE BATTERIES

1. Holding the both sides of the cover and remove it by sliding downward.
 2. Correctly insert 2 AAAA alkali batteries matching + and - polarities with indications.
 3. Push RESET button with something tipped and attach the cover.
- Replace the batteries when the display section of the remote controller is difficult to be read, or when the signal cannot be sent if you are not close to the sensor. (The standard replacement time of the alkali batteries is approx. one year.)
 - Use the same type of new batteries for replacing two batteries.
 - In case when you do not the remote controller for a long time, remove the batteries.

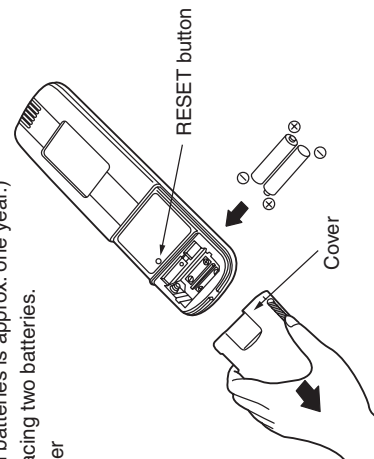

HOW TO HANDLE THE REMOTE CONTROLLER

- Direct the transmitter of the remote controller toward the sensor (indoor unit body). When the signal is normally received, "Pi" sound is heard once. ("Pi, pi" sounds are heard only when the operation has started.)
- The standard distance which the signal can be received is approx. 7m. The distance differs a little according to the capacity of the battery, etc.
- Be careful there is not something to block the signal between the sensor (indoor unit body) and the remote controller.
- Do not put the remote controller on the place exposed to the direct sunlight or air from the air conditioner or near the stove, etc.
- Do not drop, throw, or clean with water the remote controller.
- The signal may be accepted in a room where the electronic instantaneous-ON type or inverter type fluorescent light is set. For details, contact the shop which you purchased the air conditioner.

To Use the Remote Controller Setting to Wall, etc.

- Check a signal is received correctly by pushing  Start/Stop button at the position to be fixed.
- To take off remote controller, pull it toward you.

Fix the remote controller holder with the screws.

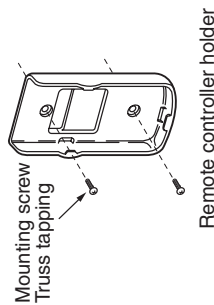

Setting method of remote controller

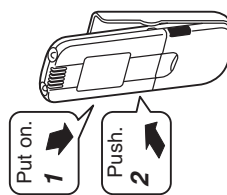

HOW TO USE THE REMOTE CONTROLLER CORRECTLY

- **Set the remote controller so that it is not excessively far from the sensor (indoor unit), otherwise a malfunction is caused.**
Be sure to set the remote controller in the same room where the sensor (indoor unit) is installed.
- **Direct the remote controller toward the sensor (indoor unit) for operation.**
When a signal is correctly received, "Pi" sound can be heard.
- **Avoid to set the remote controller at a place where it is covered with curtain, etc.**

ADDRESS

When the multiple indoor units corresponding to the wireless remote controller are installed in the same room, an address can be set up to prevent an interference.

Matching the address switch of the sensor with number of the remote controller address, Max. 6 indoor units can be controlled by the corresponding remote controller individually.

The address switch for receiving the signal is prepared to the sensor (inside of panel or indoor unit) and the address switch for sending the signal is prepared to the remote controller. For details, contact the shop which you purchased the air conditioner.

How to Check the Address

When pushing **ADR** button on the remote controller, the present address is displayed on the display section of the remote controller. If this address matches with the address of the sensor (inside of panel or indoor unit), a buzzer sounds.

(When ALL is displayed, buzzer sound is necessarily heard.)

When ALL is displayed, the air conditioner can be operated regardless of any address of the sensor (inside of the indoor unit). Send the signal by directing the remote controller toward the sensor (panel or indoor unit body) to be handled.

How to Match the Address

Setup to remote controller address

1. When keeping **ADR** pushed for 4 seconds or more, **ADR** lamp goes on at the display section of the remote controller and the present address is displayed with flashing.
2. Every pushing **ADR**, the address is exchanged as ALL → 1 → 2 → 3 ... → 6 → ALL. Match one of them with the address switch of the indoor unit sensor to be handled.
3. When pushing **CL**, the address display goes on and is displayed for 5 seconds. If the address matches with the address switch of the operation part, the buzzer sounds.

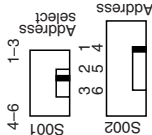
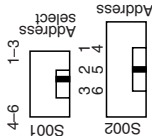
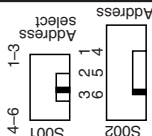
Display of remote controller address	Address	Address	Address	Address
	ALL	1	2	6
Address switch of sensor position of sensor	* Address switch of sensor unit can be set any position.			

Turn the knob to the right side for 1 to 3 while to the left side for 4 to 6 of Address select switch S001.

HOW TO PERFORM EMERGENCY OPERATION

In the following cases, operate the air conditioner in emergency by emergency operation of the operation part (inside of panel or indoor unit).

- The battery in the remote controller expired.
- A trouble occurred on the remote controller.
- The remote controller have disappeared.

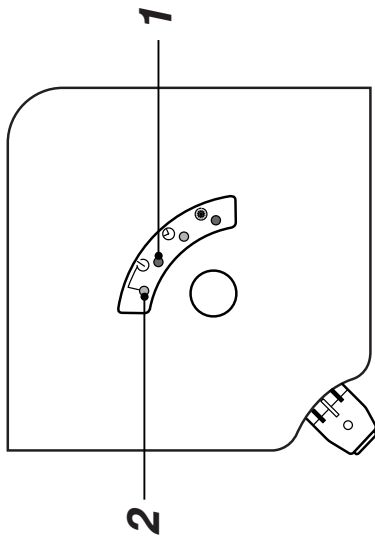

1 Start

Push emergency operation.
(If starting the operation when the room temperature is 24°C or higher, the mode enters COOL mode. If starting the operation when the room temperature is 24°C or lower, the mode enters HEAT mode.)

2 Stop

Push emergency operation once more.

CAUTION

- The ON switch of the test run and the ON switch of the test are used for the test run mode in the installation time. Do not use them in the normal time.
- If the "all stop" is selected in the normal/all stop switches, a signal from the remote controller is not accepted.

BEFORE ASKING REPAIR WORK

Before asking a repair work, check the following items.

Phenomenon	Cause	Measures
Check again Operation does not start even if the switch is turned on.	Stopped? or after power failure?	Push Start/Stop of the remote controller.
	Is the power supply of the power switch?	Turn on the power supply switch if not.
	Fuse?	Contact the shop which you purchased the air conditioner.
	Is not the mode ON timer?	Delete the timer operation.
	Is not [ALL OFF] of [Signal Receiving Part] selected?	Set the switch to [Normal position], and stop the operation.
	Is not the battery of the remote controller expired?	Replace the battery.
	Is not the state of the display lamp "Disagreement of (cool) and (heat)" or "No (A)"?	Change the operation mode.

Phenomenon	Cause	
Contact the shop which you purchased the air conditioner	<Display lamp flashes.> 	<ul style="list-style-type: none"> • It is a communication error between the sensor and the indoor unit, or setup error of the address when the wired remote controller is used.
		<ul style="list-style-type: none"> • A communication error between the indoor unit and the outdoor unit.
		<ul style="list-style-type: none"> • A protective device of the indoor unit works.
		<ul style="list-style-type: none"> • A protective device of the outdoor unit works.
		<ul style="list-style-type: none"> • A trouble occurred on the temperature sensor.
		<ul style="list-style-type: none"> • The compressor of the outdoor unit is protected.
		<ul style="list-style-type: none"> • The test run is performed. Turn off the Trial ON switch.

Please check the above items. If the trouble yet remains, stop the operation, turn off the power switch, and then notify the shop which you purchased the air conditioner of the part No. and phenomenon. Never repair any part by yourself because it is very dangerous. If the display lamp is flashing, also tell of its contents.

OWNER'S MANUAL

WEEKLY TIMER FOR AIR CONDITIONER (SPLIT TYPE)

<Program Weekly Timer Type>

RBC-EXW21E

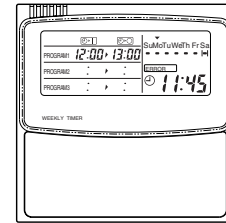

Thank you very much for purchasing TOSHIBA Weekly Timer for Air Conditioner.

Please read this owner's manual carefully before using your Weekly Timer for Air Conditioner.

- Be sure to obtain the "Owner's manual" and "Installation manual" from constructor (or dealer).

Request to constructor or dealer

Please clearly explain the contents of the Owner's manual and hand over it.

FEATURES

1. Using the dialogue system, Start/Stop operations three times per one day can easily set with unit of 1 minute. The program for a week is also set up.
2. To set the holidays (public holidays, consecutive holidays, etc.), the operation reserve can temporarily cancelled.
3. The present time, the day of the week and the operation contents under execution of the program are displayed with 24-hours notation.
4. The output can be forcibly turned on without changing the program.
5. As the backup function is incorporated in this model, the reserve contents of the program are stored in memory during a power failure.

CONTENTS

PRECAUTIONS FOR SAFETY	57
NAME AND OPERATION OF EACH PART	57
HOW TO USE THE TIMER CORRECTLY	58
1. Operation procedure	58
2. Turn on the power supply of the air conditioner	58
3. Setup of the present time	58
4. Setup of the day of the week	58
5. How to set program timer operation	58
6. Set error	59
7. How to copy the program operation time	60
8. How to check the program operation time	60
9. How to change the program operation time	60
10. How to clear the program operation	60
11. How to set up the holiday	60
12. Matters to be memorized	61

85464189558000

PRECAUTIONS FOR SAFETY

WARNING

WARNINGS ABOUT INSTALLATION

- Make sure to ask the qualified installation professional in electric work to install the weekly timer for air conditioner. If the weekly timer for air conditioner is inappropriate installed by yourself, it may cause water leak, electric shock, fire, and so on.

WARNINGS ABOUT OPERATION

- When you notice something abnormal with the air conditioner (smells like something scorching, poor cooling, etc.), immediately turn off the main switch, the circuit breaker, from the mains to stop the air conditioner, and contact the dealer. If the air conditioner is continuously operated with something abnormal, it may cause machine failure, electric shock, fire, and so on.

WARNINGS ABOUT MOVEMENT AND REPAIR

- Do not move or repair any unit by yourself. Since there is high voltage inside the unit, you may get electric shock when removing the cover and main unit.
- Whenever the air conditioner needs repair, make sure to ask the dealer to do it.
- If it is repaired imperfectly, it may cause electric shock or fire. When moving the air conditioner for re-installing at another place, ask the dealer to do it.
- If it is imperfectly installed, it may cause electric shock or fire.

CAUTION

CAUTIONS ABOUT OPERATION

- Carefully read this manual before starting the weekly timer for air conditioner. There are many important things to keep in mind for daily operation.
- Do not use this weekly timer for air conditioner for special purpose such as preserving food, precision instruments, art objects, breeding animals, growing potted plants, etc.
- Do not touch any switches with wet finger, otherwise you may get an electric shock.
- If the air conditioner was not be used for a considerably long time, turn off the main switch or the circuit breaker, for safety. Disconnect from the power supply prevents the unit from lightning and power supply surge.
- Prevent any liquid from falling into the weekly timer. Do not spill juice, water or any kind of liquid.

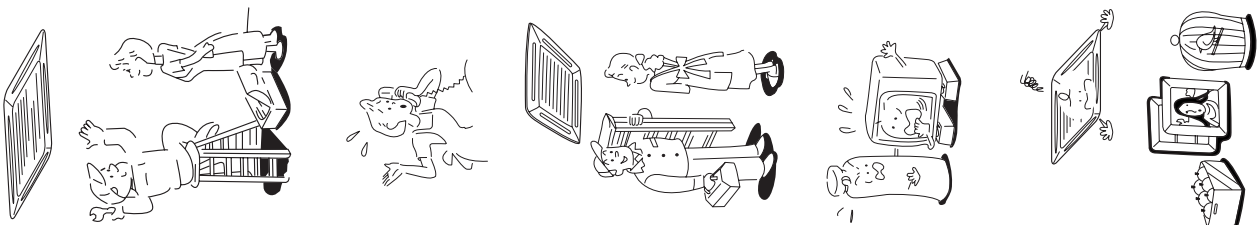

NAME AND OPERATION OF EACH PART

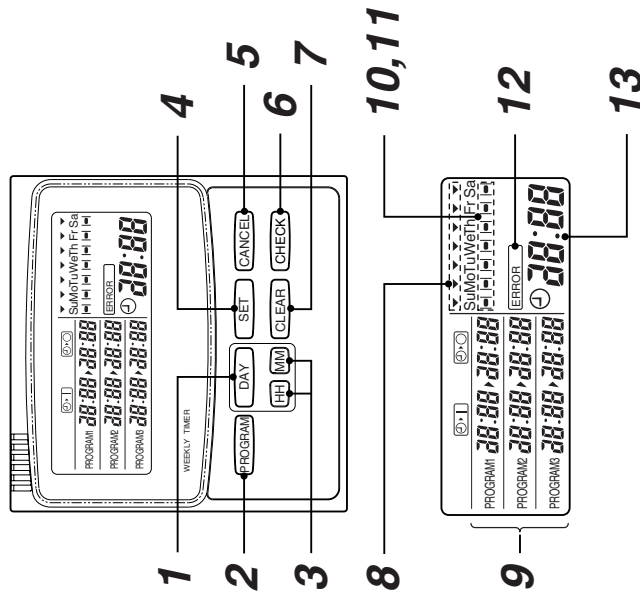

- 1 Day select button**
The day of the week is selected. Each pushing, \blacktriangledown mark moves in order of Sunday \rightarrow Monday \rightarrow Tuesday \rightarrow Wednesday \rightarrow Thursday \rightarrow Friday \rightarrow Saturday.
- 2 Program button**
This button is used to set up the contents of the program operation.
- 3 Hour/Minute button**
This button is used to set the present time and ON/OFF time.
- 4 Timer set button**
This button is used to set the day of the week, hour, minute, holiday, and ON/OFF time.
- 5 Cancel button**
This button is used to cancel as the holiday.
- 6 Check button**
This button is used to confirm the contents of the setting items.
- 7 Cancel button**
This button is used to cancel the setting items.
- 8 Display of the present day of the week (\blacktriangledown mark)**
- 9 ON/OFF time display**
ON/OFF time of the timer operation is displays.
- 10 Operation reserve indication (\blacktriangleleft mark)**
The day of the week when the program operation has been set is displayed.
- 11 Holiday setting indication (\blacktriangleright mark)**
The holiday is displayed (Cancel as holiday)
- 12 Setting error display**
- 13 Present time display**
Displays the present time displayed with 24-hours notation.

HOW TO USE THE TIMER CORRECTLY

1. Operation procedure

Power ON
Turn on the power of the air conditioner.

Program weekly timer set up
Setup of the present time
Setup of the present day of the week
Setup of the program operation for a week

2. Turn on the power supply of the air conditioner

- Turn on the power supply of the air conditioner connected with a program weekly timer. (For cooling and heating, do not turn off the power supply for compressor heating.)

3. Setup of the present time

- Set the present time (Example: Case that the present time is 11:45.)

1 While push **[SET]** button push **[HH]** button to select "hour" of the present time.

- While push **[SET]** button each pushing **[HH]** button, change sequentially.
0 → 1 → ... → 10 → ... → 23 → 0
- While keep **[SET]** button pushed, continuous pushing **[HH]** button makes fast forward. (Example: Leave the finger at display of 11, you can set 11 o'clock.)
- When release **[SET]** button, the hour is set, and **[MM]** mark changes flashing to light.

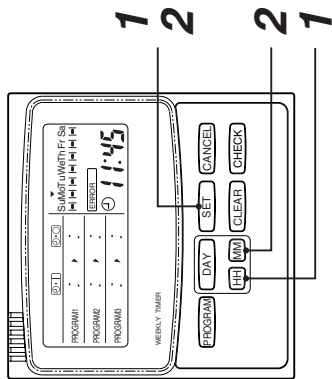

2 While push **[SET]** button push **[MM]** button to select "minutes" of the present time.

- While push **[SET]** button, each pushing **[MM]** button change sequentially.
00 → 01 → ... → 58 → 59 → 60
- While keep **[SET]** button pushed continuous, pushing **[MM]** button makes fast forward. (Example: Leave the finger at display of 45 you can set 45 minutes.)
- When release **[SET]** button, the minutes are set, and **[ON]** mark changes flashing to light.

CAUTION

- The time cannot be changed only when **[HH]** button or **[MM]** button pushed.
- If 30 seconds have passed while the button is flashing without pushing **[DAY]** or **[HH]** / **[MM]** buttons, the display returns automatically to the original display (Normal display). In this case, repeat the procedure from the 1st step.

4. Setup of the day of the week

- Set the today of the week. (Example: Case of Wednesday)

- 1 While push **[SET]** button push **[DAY]** button to select "today" of the week.
 - While pushing **[SET]** button, each push **[DAY]** button, the display of the present day of the week → flashes, and the display moves in order.
▽ ▽ ▽ ▽ ▽ ▽ ▽ ▽
SuMoTu WeTh Fr Sa

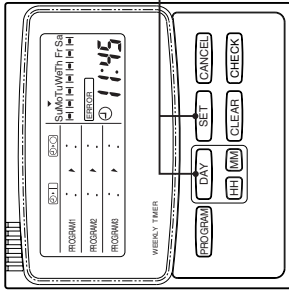

CAUTION

- The day of the week cannot be changed only when **[DAY]** button is pushed.
- If 30 seconds have passed while the button is flashing without pushing **[DAY]** or **[HH]** / **[MM]** buttons, the display returns automatically to the original display (Normal display). In this case, repeat the procedure from the 1st step.

5. How to set program timer operation

Set the present time and the present day of the week surely, otherwise the program operation is not correctly performed.

This timer can control up to 3 cycle program per day. (1 cycle or 2 cycles can be also set up.)

The following items can be set to the program operation.

- Setup of **[ON]** @ **[OFF]** time (**[ON]** or **[OFF]** only cannot be set up singly).

<Name and functions>

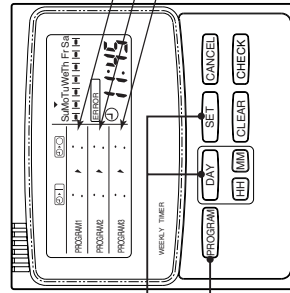

- 1 Operation time of program 1
- 2 Operation time of program 2
- 3 Operation time of program 3

Example:

To set the operation time of Monday as follows:
From 8:00 to 12:00 } Operates
From 12:40 to 16:50 }
From 17:00 to 19:00 }

1 First push **[PROGRAM]** button.

- When pushing **[PROGRAM]** button, the reserve mark ■ flashes.

SuMoTuWeThFrSa

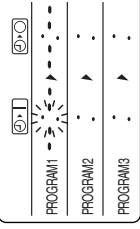

2 Push **[DAY]** button, select the day for operation and then push **[SET]** button.

- When pushing **[SET]** button, the flashed reserve mark ■ changes, and ON time of the program 1 flashes at the same time.

3 Set ON time by [HH] / [MM] buttons, and then push [SET] button.

When push [SET] button, the flashed ON time (8:00 in example) change, and OFF time of the program 1 flashes at the same time.

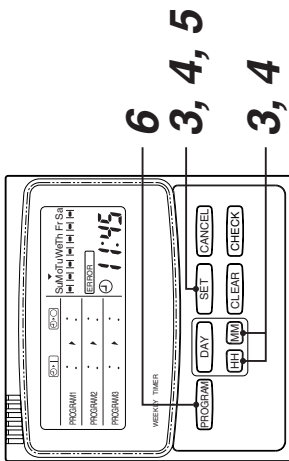
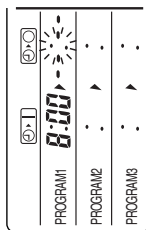

4 Set OFF time by [HH] / [MM] buttons, and then push [SET] button.

When pushing [SET] button, the flashed ON time (12:00 in example) changes, and ON time of the program 2 flashes.

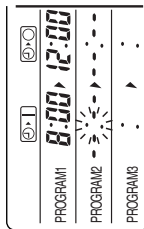

5 Next set up the operation time to the program 2 and 3.

When pushing [SET] button after OFF time of the program 3 has been set, the flashed OFF time (19:00 in example) changes and ON time of the program 1 flashes.

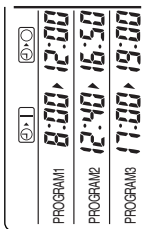

6 Finally, push [PROGRAM] button.

Push [PROGRAM] button within 30 seconds after No. 5 step.

Then, one day timer (Monday in example) is set completely. ON/OFF is displayed when the present time is included in the range of the set time.

(In the above status, the contents of the program 1 are displayed as the present time is included in the range from ON time to OFF time of the program 1.)

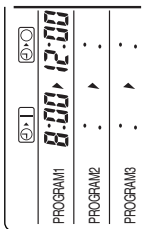

7 Setting to other day, repeat above procedure from 1 to 6.

If you need to set the same time as previous setting. Refer to "7. How to copy the program operation time".

CAUTION

- Setup of the program time : 0:00 is treated as 24:00.
(Example) In the following cases, setup are available.

ON time	0:00	22:00
OFF time	2:00	0:00

- If 30 seconds have passed while the button is flashing without pushing [DAY] or [HH] / [MM] buttons, the display returns automatically to the original display (Normal display). In this case, repeat the procedure from the 1st step.

6. Set error

If flashing [ERROR] is displayed when the program operation has been set up, correct the time following the procedure below.

- When flashing [ERROR] is displayed, ON time of the failed program flashes.

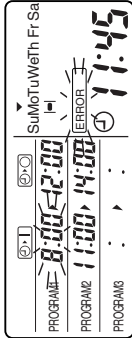

- Push [SET] button to flash the time to be corrected.

- Using [HH] / [MM] buttons, correct ON/OFF time.

- Push [SET] button. When the setup is correctly performed, [ERROR] display disappears.

- The correction has completed by pushing [PROGRAM] button.

CAUTION

- When ON/OFF time is set as follows, [ERROR] is displayed.

- When a part of the operation time makes inroads into a part of another operation time

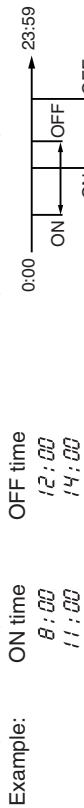

- When OFF time is ahead of ON time



- When ON time is same as OFF time



- ON time or OFF time is singly set up



- The following cases are not set error.

- OFF time of the previous cycle is same as ON time of the next cycle.

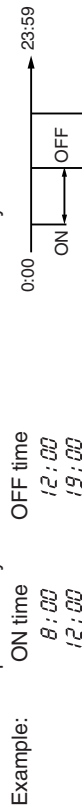

- When the next cycle is set to the time before the set time of the previous cycle

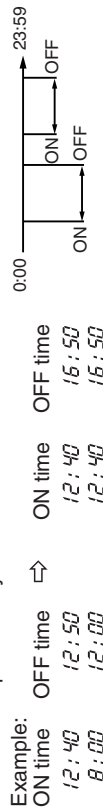

Pushing the [PROGRAM] button changes the order in order of time.

- When both ON and OFF times are same 0:00



Continuous operation for 24 hours

7. How to copy the program operation time

When setting the program operation, already set program can be copied and set to the other day of the week.

<Example: To copy the operation contents of Monday to Tuesday>

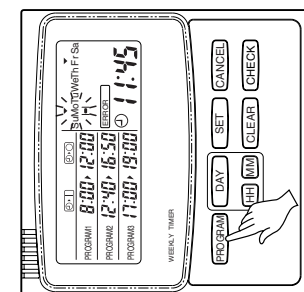

1. Push **CHECK** button in normal display.
2. Push **DAY** button and put the operation reserve indication **■** on the day of the week of which the program operation is already set. (Monday in the example)
3. Push **PROGRAM** button.
Present day of the week indication **▼** and Operation reserve indication **■** flash.
4. Push **DAY** button and put the present day of the week indication **▼** on the day of the week to be copied. (Tuesday in the example) (For continuous copying, push **SET** button, and then push **DAY** button.)
5. Push **PROGRAM** button. The operation reserve indication **■** goes on under the copied day of the week.

8. How to check the program operation time

- 1 Push **CHECK** button.

<Example: Case to check the program operation time of Wednesday in Monday>

- The operation reserve indication **■** flashes in the normal display status.

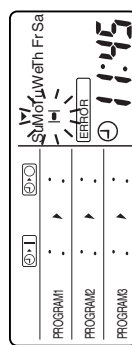

- 2 Push **DAY** button and put the operation reserve indication **■** on the day of the week to be checked.

- Every pushing **DAY** button, the operation reserve indication **■** flashes and the contents of program operation time of the day of the week on which the operation reserve indication **■** has been put on is displayed.

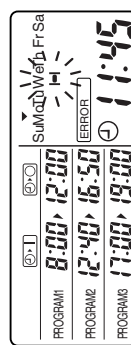

- 3 Push **CHECK** button.

- It turns to be normal indication.

9. How to change the program operation time

1. Push **PROGRAM** button in the normal display status.
2. Select the required day reserve mark **■** by pushing **DAY** button.
3. Push **SET** button.
4. Each push **SET** button, the flashing part changes in the following figure. Put the indication on the time to be changed.
5. Using **HH** / **MM** buttons, change the time.
6. Push **SET** button.
7. Push **PROGRAM** button. Then the change operation has completed.

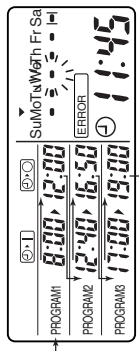
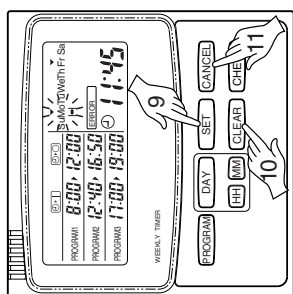

11. How to set up the holiday

- The operation reserve day can be cancelled by setting up the holiday.
 - 1) Push **CANCEL** button. The holiday setup mark **||** flashes.
 - 2) Push **DAY** button and select the holiday setup mark **||** on the day which the holiday is set.
 - 3) Push **SET** button. The flashing holiday setup indication **||** changes on. (**■**)
- Clearance of [HOLIDAY] setup
 - 1) Push **CANCEL** button.
 - 2) Push **DAY** button and select the holiday setup mark **||** on the day to which the holiday is cancelled.
 - 3) Push **SET** button. The holiday setup mark **||** disappears and the operation reserve mark **■** appears.
- Explanation of operation

The cancel setting day is temporarily cancelled, and from the next day, the cancel setup mark **||** disappears and the operation reserve mark **■** appears.

CAUTION

- For the day which does not set timer, the cancellation cannot be set.

12. Matters to be memorized

1. Power failure

When a power failure occurred and the power supply has been reset, the display of the right figure appears. (A colon ":" flashes.)

- Resuming of operation

- 1) Turn on the power (breaker) of the air conditioner.
- 2) Start operation by the remote controller.
- 3) Push **PROGRAM** button of the program weekly timer. The flashing colon ":" changes to the clock display in the normal status. In this case, the program is memorized by the backup function. Therefore, it is unnecessary to set the program again.

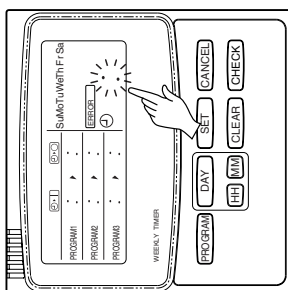

2. Operation of program weekly timer and air conditioner

An air conditioner mounted with a program weekly timer is operated on a remote controller and on the program weekly timer.

(Example)

1) Operation pattern in a day

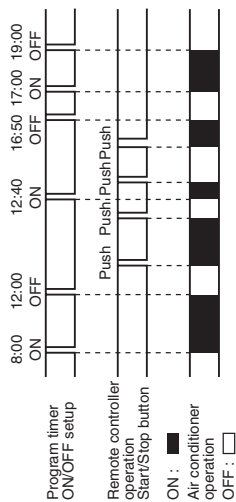

2) Operation pattern in a week

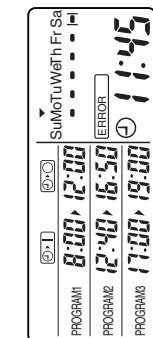
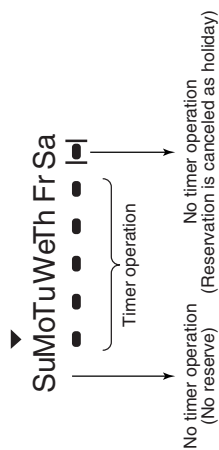

OWNER'S MANUAL

REMOTE CONTROLLER FOR AIR CONDITIONER

<Simple Operation Type>

RBC-AS21E

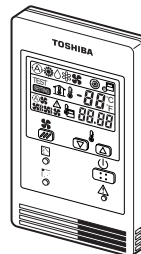

Thank you very much for purchasing TOSHIBA Remote Controller for Air Conditioner.

Please read this owner's manual carefully before using your Remote Controller for Air Conditioner.

- Be sure to obtain the "Owner's manual" and "Installation manual" from constructor (or dealer).

CONTENTS

PRECAUTIONS FOR SAFETY	63
NAME AND OPERATION	63
HOW TO OPERATE AIR CONDITIONER	64

PRECAUTIONS FOR SAFETY

WARNING

WARNINGS ABOUT INSTALLATION

- Make sure to ask the qualified installation professional in electric work to install the remote controller. If the remote controller is inappropriate installed by yourself, it may cause, electric shock, fire, and so on.

WARNINGS ABOUT OPERATION

- When you are aware of something abnormal with the air conditioner (smells like something etc.), immediately turn off the main power supply switch or circuit breaker, from the mains to stop the air conditioner, and make contact with the dealer. If the air conditioner is continuously operated with something abnormal, it may cause machine failure, electric shock, fire, and so on.

WARNINGS ABOUT MOVEMENT AND REPAIR

- Do not repair any unit by yourself.
- Whenever the air conditioner needs repair, make sure to ask the dealer to do it. If it is repaired imperfectly, it may cause electric shock or fire.



CAUTION

CAUTIONS ABOUT OPERATION

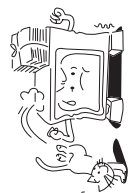
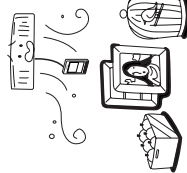
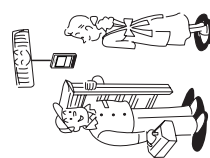
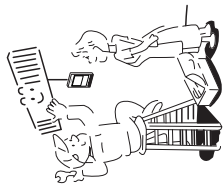
- Carefully read this manual before starting the air conditioner. There are many important things for the safety and the correct usage.
- Do not touch any switches with wet finger, otherwise you may get an electric shock.
- When the air conditioner was not be used for a considerably long time, turn off the main switch or the circuit breaker, for safety. Disconnect from the power supply prevents the unit from lightning and power supply surge.
- Prevent any liquid from falling into the remote controller. Do not spill juice, water or any kind of liquid.





NAME AND OPERATION



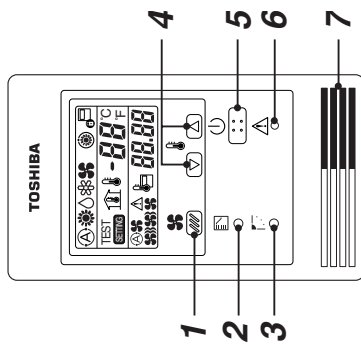





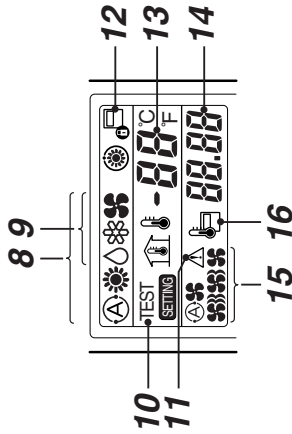







- For Cooling Only type,  and  are not displayed on LCD.
- Max. 8 indoor units can be operated by a remote controller.
- Once setting the operation items, you can operate the previous condition by pushing  button only.



<The following display is for explanation, so it differs from the real display.>



- 1 Fan Speed button**
- 2 Operation mode button**
- 3 Swing/Air direction button**
The flap angle is changed.
- 4 Temperature Setup button**
Every pushing  button, temperature rises by 1°C.
Every pushing  button, temperature decrease by 1°C.
- 5  [Start/Stop] button**
- 6 Check button (Used in servicing)**
 - Do not use this button usually.
- 7 Remote control temperature sensor**
Usually controlled by the indoor unit sensor, it can be changed to the remote controller. For details, contact the shop which you purchased the air conditioner. (When using a group control method, do not use the remote controller sensor.)



- 8 Selected mode displays (Heat pump type)**
Any one of , ,  or  is displayed.
While  is displayed, the indoor fan stops or the mode is Low speed mode.
- 9 Selected mode displays (Cooling only type)**
Any one of ,  or  is displayed.
- 10 TEST is displayed during Test Run.**
- 11  (CHECK) is displayed when the protective device worked or trouble occurred.**
- 12  is displayed during the operation.**
If the remote controller setting is prohibited by the central remote controller,  flashes when [Start/Stop], [Operation Select] or [Temp. Setup] button is pushed and change is not accepted.
- 13 The setup temperature is displayed.**
- 14 Warning code is displayed when a trouble occurred.**
- 15 Selected fan speed, , ,  or  displays.**
- 16  is displayed when the remote controller sensor is used.**

- When turning on the power switch of the simple operation type remote controller at the first time,  flashes. While  is displayed, the automatic model check is operating. Operate the remote controller after  has disappeared.

HOW TO OPERATE AIR CONDITIONER

COOL/HEAT AUTO, HEAT, DRY, COOL, FAN

1 Power supply

Turn on the power supply of the air conditioner 12 hours before starting the operation.

2 Push button.

3 Push button () to select fan speed.

When selecting AUTO, fan speed is automatically changed.
(During FAN mode, the air speed is not.)

4 Push either or set to Auto.

- **<Recommended temperature>**
- During FAN mode, the temperature cannot be set up.

5 Stop

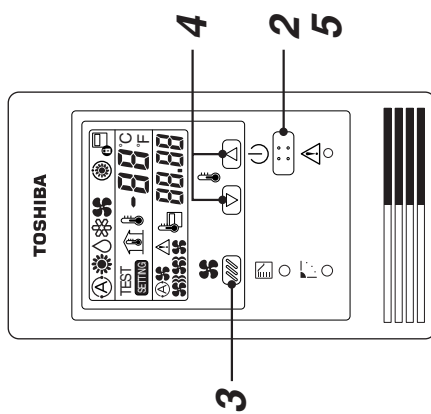

Push  button.

When stopping the unit by the remote controller, the fan of the outdoor unit, the fan or the outdoor unit may keep operating for a while even if the compressor of the outdoor unit has stopped.



- When the unit cannot be stopped by the remote controller.

Turn off the main power switch or the leakage breaker, and then contact the shop which you purchased the unit.

- In heating, if the room is not enough heated with FAN  or .
- As the temperature sensed by the temp. sensor periphery of the suction port of the indoor unit, it differs from in the room according to the installation state. Set the temperature considering the setup value as the standard temperature in the room.

Automatic Cool/Heat

When all indoor units in the identical refrigerant system are controlled as a group and when all indoor units are installed in the same room, the cooling or heating operation is automatically performed with the difference between the setup temperature and the room temperature.

TOSHIBA INSTALLATION MANUAL

Ceiling Panel

MODEL: RBC-U21PG (W)-E





Cautions on Safety

- Before installation work, read this "Cautions on Safety" thoroughly.
- **Strictly keep the following items in mind because they describe the serious contents concerned with safety. The indications and meanings are as follows:**
- After installation work, accompanied with a test run to check if there is no trouble, explain the use method and maintenance of the unit to the customers according to Owner's Manual. And also ask the customers to obtain this Ceiling Panel Installation Manual together with Owner's Manual and Installation Manual of the indoor unit.

WARNING

- **Ask an authorized dealer or qualified installation professional to install the ceiling panel.**
Inappropriate installation may result in water leakage, electric shock or fire if you install it by yourself.
- **Carry out an installation work securely according to this Installation Manual.**
Inappropriate installation may result in water leakage, electric shock or fire.
- **A person qualified in the electric work should execute the electric works according to the Installation Manual and should use the exclusive circuits. The voltage should be matched with the rated voltage of the product.**
The capacity shortage of electric circuit or inappropriate installation may result in electric shock or fire.
- **Never modify or repair the product.**
Incomplete modification or repair may result in electric shock or fire.

Components

Name	Ceiling panel	Screw with washer	Screw	Installation manual
Qty	1	4 ØM5mm x 40mm	4 ØM4mm x 12mm	1
Shape				

- **Never apply an excessive force on the flap. It causes a trouble.**

1. Preparation before installation of ceiling panel

(1) Position check of indoor unit

1. Check the position of the indoor unit according to the installation Manual.
2. Check the size of the ceiling opening hole, applied the following range.
860mm x 860mm to 910mm x 910mm
3. Using the installation gauge attached to the indoor packing, execute positioning of the ceiling surface and the indoor unit. If position of the ceiling surface does not match with position of the indoor unit, air leak, water leak (dewing), or malfunction of the flap is caused.
 - **Never put the ceiling panel downward, lean it, or leave it on a projection to avoid a damage on the surface of the ceiling panel.**
 - **Do not apply an excessive force on the flap when hanging it tentatively to the indoor unit. (It causes a trouble on the flap.)**

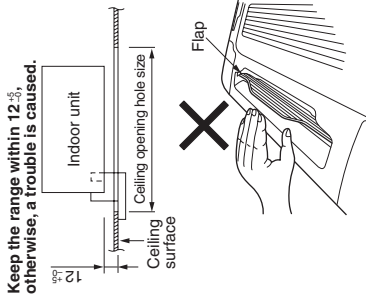

2. Installation to indoor unit

(1) Removal of suction grille

1. Open the suction grille by sliding the hook out of the suction grille along the arrow direction 1.
2. Take off hook of the fall-preventive strap from the ceiling panel.
 - **Do not take off screws of the fall-preventive strap at the suction grille side.**
3. As the suction grille opened, remove the hinge section of the suction grille from the ceiling panel toward the arrow direction (2).

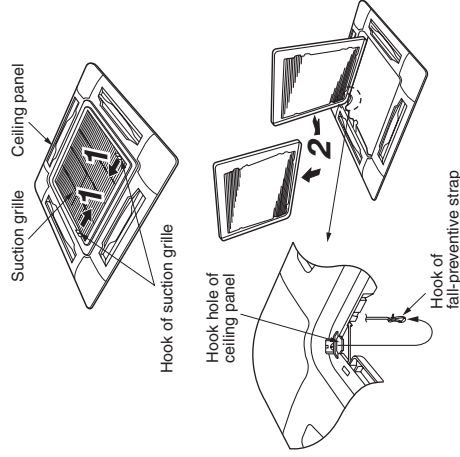

(2) Removal of adjust corner cap

1. Slide the adjust corner cap along the arrow direction 1, and then remove the adjust corner cap. (Fig. 1)

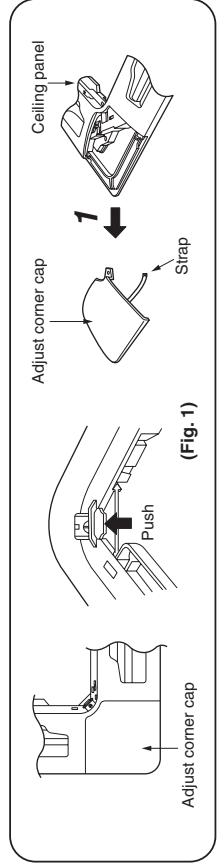

(3) Installation of ceiling panel

The angle change of the flap is possible while the power supply is turned on. (Do not move forcibly the flap with hands. It may break the flap.)

- For tentative hanging, insert the tentative hanging metal (stainless) inside of the ceiling panel into the square hole of the indoor unit. (Fig. 2)
- The ceiling panel has directional ability against the indoor unit. Direct the mark of refrigerant pipe at the ceiling panel corner toward the pipe side.
- Holding the ceiling panel, remove it while pushing the tentative hanging metal toward the outside.
- Match the mounting hole of the panel with the screw hole of the indoor unit.
- Using the attached screws with washer, tighten 4 positions at corners of the suction port until the panel is fitted closely to the main unit. (Fig. 3)
- Check the panel is fitted closely to the ceiling.
 - In this time, check there is no clearance between the indoor unit and the ceiling panel, and between the ceiling panel and the ceiling surface. (Fig. 4)

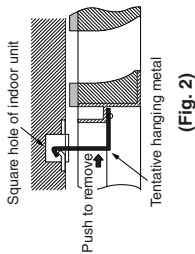

(Fig. 2)

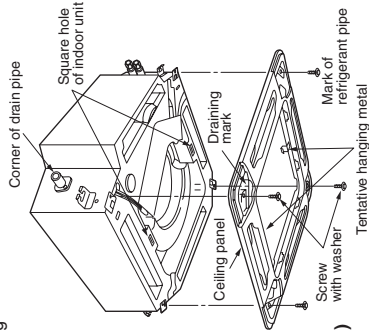

(Fig. 3)

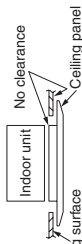

(Fig. 4)

CAUTIONS

- Tighten the screws securely because a trouble is caused as shown in the following figure if the screws are incompletely tightened.

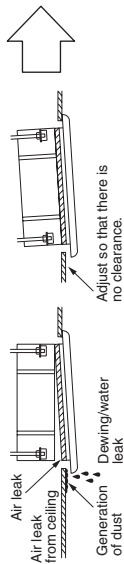

(Fig. 5)

The height of the indoor unit can be adjusted from the height of the ceiling. When the indoor unit is installed, the height of the indoor unit is adjusted so that the levelness of the indoor unit, drain pipe, etc.

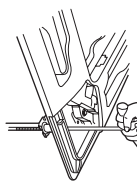

(Fig. 6)

(4) Cabling of ceiling panel

- Open cover of the electric parts box.
- Connect the flap motor wiring connector out of the ceiling panel to the connector 5P (CN33; white) on P.C. board of the indoor unit.
 - Connect the connector surely because the flap does not work if the connector is not connected.
- Mount cover of the electric parts box in the reverse procedure of opening of the cover.
 - Check whether the wiring connector is pinched between the electric parts box and the cover or not.
 - Check whether the wiring connector is pinched between the indoor unit and the ceiling panel or not.

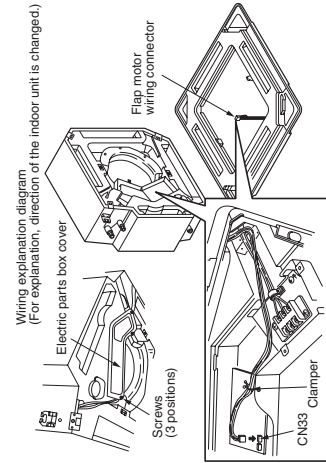

As shown in the figure, pass the clamping material through inside of the slit. After connection, store the connector section in the electric parts box.

(Fig. 7)

(5) Installation of adjust corner cap/suction grille

Install the adjust corner cap/suction grille in the reverse procedure of installation to the indoor unit.

- For this ceiling panel, as shown in the following figure, the direction of the suction grille can be changed on customer's demand when multiple indoor units are installed.

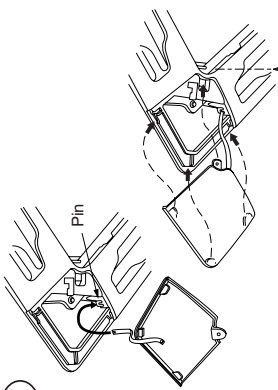

Install the adjust corner cap horizontally to the ceiling surface so that 3 hooks of the adjust corner cap are set in holes of the ceiling panel. And then fix it with the mounting screws (accessory part).

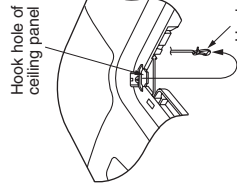

(Fig. 8)

A. Installation of adjust corner cap

- Hook the strap of the adjust corner cap surely to the pin on the ceiling panel.
- Install the adjust corner cap to the ceiling panel, and fix it with the mounting screws. (accessory part)

B. Installation of suction grille

- To install the suction grille, follow to the reverse procedure of the removal. This ceiling panel can be installed from any one of 4 directions by turning the suction grille. Change the direction on the customer's demand or according to the direction matching of the suction grille when multiple units are installed.
- When installing the suction grille, be sure not to pinch the flap motor wiring connector.
- Be sure to attach a strap to prevent falling of the suction grille to the ceiling panel.

3. Others

Positions of suction grille hooks at shipment from the factory

- When height of the ceiling is different from any position of corners, these positions are recommended. (It is unnecessary to remove the suction grille in maintenance for the electric parts box of the indoor unit.)

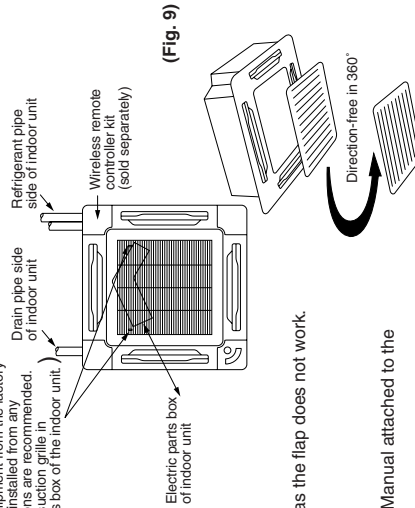

(Fig. 9)

A. Check after installation

- Check again there is no clearance between the indoor unit and the ceiling panel, and between the ceiling panel and the ceiling surface.
 - A clearance causes water leak or dewing.
 - Check the cables are connected surely.
 - Incomplete connection causes a trouble such as the flap does not work.

B. For wireless remote controller

- For details of installation, refer to the Installation Manual attached to the wireless remote controller kit (sold separately).

After confirmation of the above items, hand a set of this manual, manuals for the indoor unit, manual for products sold separately, etc. to the customer. For cleaning of the filter, be sure to ask the maintenance professional.

Accessory parts

Part Name	Q'ty	Part Name	Q'ty
Remote controller (200mm-cable attached)	1	Spacer	2
Screw M4 x 25	2	Wire joint	2
Wood screw	2	Installation Manual	1

Requirement to install the remote controller

Installation place

- Install the remote controller at a position with height 1 to 1.5m from the floor, where the average temperature in the room can be felt.
- Do not install the remote controller at a place exposed to direct sunlight or direct outside air, such as a side of window, etc.
- Do not install the remote controller at a place behind something or rear side of something where air flow is poor in the room.
- Do not install the remote controller in the freezing box or refrigerator because water proof or drop-proof is not applied to this remote controller.
- Be sure to set the remote controller vertically on the wall surface, etc.

How to select the room temperature sensor

The room temperature sensors are equipped in the indoor unit and remote controller.

One of two sensors works. Usually, the room temperature sensor in the indoor unit is set to work. To select the sensor in the remote controller side, refer to the following procedure.

- Keep **[SET]** and **[ON]** buttons pushed for 4 seconds or more.

NOTE The UNIT No. displayed at the first time is the indoor unit address of the master unit in the group control.

NOTE Do not push **[UNIT]** (select) button.

- Using the temperature setup buttons **[▲]**/**[▼]** specify the item code **0032**.
- Using the timer buttons **[▲]**/**[▼]** change the set data from **0000** to **0001**.
- Push **[OK]** button.
- OK if the display changes from flashing to lighting)
- Push **[ON]** button.

The status returns to the normal status. In this time, **[ON]** is displayed in LCD.

NOTE 1 :

When using two remote controllers, the master remote controller is recognized as **[M]** sensor though the temperature can be set from either master or sub remote controller.

NOTE 2 :

In a group control, the **[S]** sensor does not work if the group address is not set to the indoor unit of the master unit.

NOTE 3 :

When using the remote sensor together with the remote controller, do not use the **[S]** sensor of the remote controller.

How to install remote controller

NOTE 1 : Avoid to twist the remote controller cable with power supply cable, etc. or to store them in the same metal pipe, otherwise it causes a malfunction.

NOTE 2 : Install the remote controller apart from the generation source of noise.

NOTE 3 : When noise is contained to the unit power supply, counter measures such as mounting the noise filter is necessary.

- When using the remote controller as exposed, install it at the wall surface where it can be fixed.

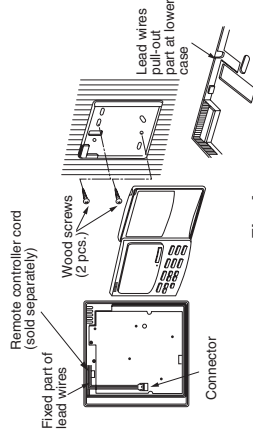

Fig. A

- For removal and mounting of the remote controller body and the rear case, refer to the item, "Using as concealed type".
 - Remove the lead wires wound to the fixing part of lead wires of the remote controller body, remove the connectors, and then connect the remote controller cable (sold separately) to the connector section of the remote controller body. Insert the remote controller cable into the groove and form it, and wind it around the fixing part of lead wires.
- Notching the lower case (thin part of the upper center part) with nipper, etc., pull out the remote controller cables from this part. (Fig. A) (Refer to the item, "How to perform cabling of the remote controller".)

Connect cables of the remote controller after check of terminal No. of the indoor unit so that there is no miswiring. (Do not apply AC 200/230/240V to the remote controller.)

- Fix the remote controller body by two wood screws.
- Using the cable clips (Accessory of remote controller cable sold separately), fix the remote controller cable to the wall surface.

How to perform cabling of the remote controller

Connection diagram

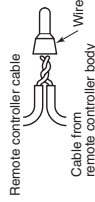
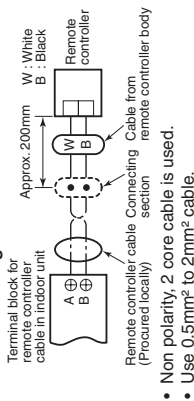

- Peel the sheath of the cable to be connected by approx. 14mm.
- Twist two cables and pressure-connect them using a wire joint.
- When an exclusive pressure-connecting tool is not used or soldering connection is used, apply insulation process with an insulation tape.

For cabling of the remote controller, use the remote controller cable (sold separately).

- Remove the lead wires wound to the fixing part of lead wires of the remote controller body, remove the connectors, and then connect the remote controller cable (sold separately) to the connector section of the remote controller body. Insert the remote controller cable (sold separately) into the groove and form it, and wind it around the fixing part of lead wires.
- When using the remote controller cable (sold separately), refer to the Installation Manual attached to the remote controller cable.

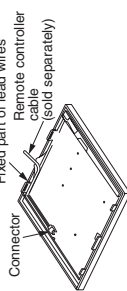

Remote controller test run setup

- When the remote controller is used at the first time, it accepts an operation approx. 5 minutes after the power supply has been turned on. It is not a trouble, but is because the setup of the remote controller is being checked.
- Push **[ON]** key after [TEST] has been displayed on LCD by keeping **[ON]** button on the remote controller for 4 seconds or more.

During the test run, [TEST] is displayed on LCD.

The temperature cannot be controlled if [TEST] is displayed.

Do not use [TEST] in a case other than a test run, otherwise an excessive load is applied on the machine.

Use [TEST] in one of HEAT, COOL, and FAN operation modes.

NOTE : The outdoor unit does not operate for approx. 3 minutes after the power supply has been turned on or the operation has stopped.

- After the test run has finished, push **[ON]** button again to check [TEST] on LCD has gone off. (For this remote controller, a release function of 60 minutes timer is provided to prevent continuous test runs.)

Requirement for installation of multiple remote controllers

"2 remote controllers" means that one or multiple units are operated by the multiple remote controllers. (Max. 2 remote controllers can be set.)

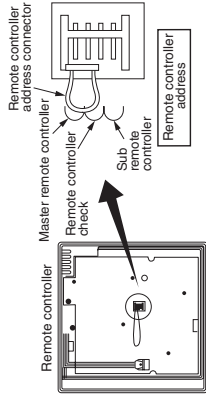

How to install

For 2 remote controllers, install the remote controllers in the following procedure.

- Set one of two remote controllers as the master remote controller. (At shipment from factory)
- For the other remote controller, exchange the remote controller address connector of the master to sub remote controller on the PC board. Under this condition, the other remote controller functions as the sub controller.

Basic wiring diagram

NOTE :

Connect cables without miswiring. (Miswiring breaks the unit.)

- In a case to operate an indoor unit from the remote controllers at two positions

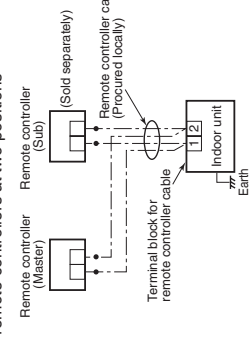

- In a case to operate a group control of multiple indoor units from the remote controllers at two positions

Master and Sub remote controllers are operable even if they are installed to any indoor unit.

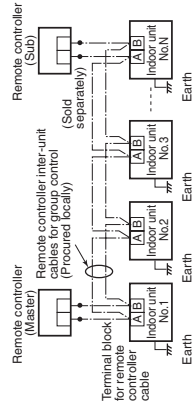

Accessory parts

Part Name	Q'ty	Part Name	Q'ty
Remote controller	1	Spacer	2
(200mm-cable attached)	2	Wire joint	2
Screw M4 x 25	2	Clamper	1
Wood screw	2	Installation Manual	1

Requirement to install the remote controller

Installation place

- Install the remote controller at a position within 1 to 1.5m from the floor, where the average temperature in the room can be felt.
- Do not install the remote controller at a place exposed to direct sunlight or direct outside air, such as a side of window, etc.
- Do not install the remote controller at a place behind something or rear side of something, where air flow is poor in the room.
- Do not install the remote controller in the freezing box or refrigerator because water proof or drop-proof is not applied to this remote controller.
- Be sure to set the remote controller vertically on the wall surface, etc.

How to select the room temp. sensor

The room temperature sensors are equipped in the indoor unit and the remote controller. One of two sensors works. Usually, the room temperature sensor in the indoor unit is set to work. To select the sensor in the remote controller, turn the remote controller sensor from OFF to ON.

NOTE 1 :

Selecting the sensor in the remote controller is impossible on the sub remote controller.

NOTE 2 :

Do not select the sensor in the remote controller when a remote controller sensor is used. (Because it causes a straying.)

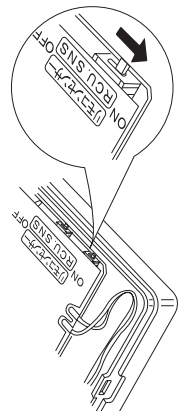

How to install the remote controller switch

NOTE 1 :

Avoid to twist the remote controller cable with the power supply cable, etc. or to store them in the same metal pipe, otherwise it causes a malfunction.

NOTE 2 :

Install the remote controller apart from the generation source of noise.

NOTE 3 :

When noise is contained to the power source of the indoor unit, counter measures such as mounting the noise filter is necessary.

- In case of using the remote controller as a concealed type

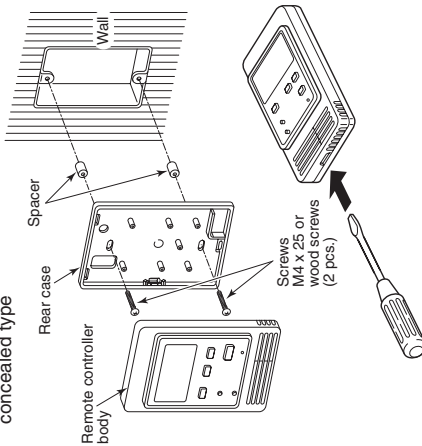

1. Inserting a minus screwdriver, etc. into the groove at the lower side of the remote controller body, force open the rear case to remove it.
2. Using the attached M4 screws (2 pcs.), fix the rear case of the remote controller. Before installation, press to open the screw hole with a screwdriver, etc.
3. Connect the remote controller cable (2 cores) to the cable from the remote controller body. Connect the remote controller cable without miswiring upon confirmation of the terminal numbers of the indoor unit. (If applied AC 220/230/240V, may damage the unit.)
4. Install the remote controller body to hooks on the rear case and putting into the hooks.

How to perform cabling of the remote controller

Connection diagram

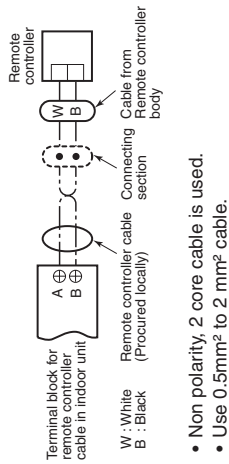

- Non polarity, 2 core cable is used.
- Use 0.5mm² to 2 mm² cable.

Attached wire joint (White, 2 pcs.)

- 1) Peel the sheath of cable to be connected by approx. 14mm.
- 2) Twist two cables and pressure-connect them using a wire joint.
- 3) When an exclusive pressure-connecting tool is not used or soldering connection is used, apply insulation process with an insulation tape.

Requirement for installation of multiple remote controllers

"2 remote controller control" means that one or multiple units are operated by the multiple remote controllers.

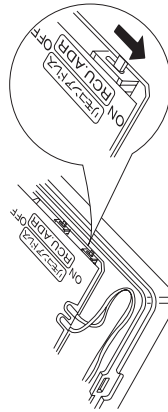

How to install

For 2 remote controller control, install the remote controllers in the following procedure.

1. Set one of the set multiple remote controllers to the master remote controller. (At shipment from factory)
2. For other remote controllers, turn the remote controller address switch on the remote controller P.C. board from OFF to ON. They function as sub remote controllers under the above condition.

Basic cabling diagram

NOTE :

- Connect cables without miswiring. (Miswiring breaks the unit.)
- In a case to operate an indoor unit from the remote controllers at two positions

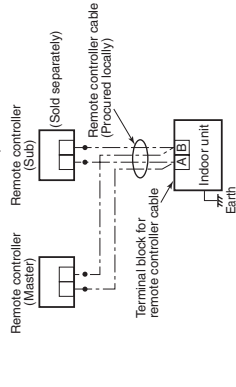

- In a case to operate a group control of multiple indoor units from the remote controllers at two positions

* Master and sub remote controllers are operable even if they are installed to any indoor unit.

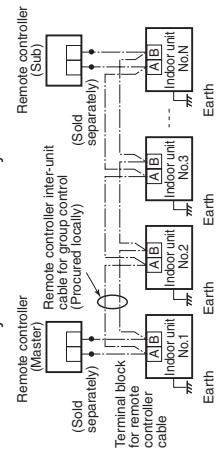

Remote controller test run setup

1. Push **[ON]** key after keeping **[CHECK]** button pushed on the remote controller for 4 seconds or more.
 - During the test run, "TEST" is displayed on LCD.
 - The temperature cannot be controlled if **[TEST]** is displayed. Do not use **[TEST]** in a case other than a test run, otherwise an excessive load is applied on the machine.
2. Use **[TEST]** in one of **HEAT, COOL, and FAN operation modes.**

NOTE :

The outdoor unit does not operate for approx. 3 minutes after the power supply has been turned on or the operation has stopped.

3. After the test run has finished, push **[CHECK]** button again to check "TEST" on LCD has gone off. (For this remote controller, a release function of 60 minutes timer is provided to prevent consecutive test runs.)

Accessory parts

Part Name	Q'ty
Program weekly timer	1
Connecting cable (Length: 1.2m)	1
Screws M4 x 25	2
Wood screws	2
Spacer	2
Owner's Manual	1
Installation Manual	1

Requirement to install the program weekly timer

Installing dimension for serial installation
When installing the program weekly timer (remote controller/system controller, etc.) to the wall surface, follow the installation procedure in (Fig. 1) and (Fig. 2).

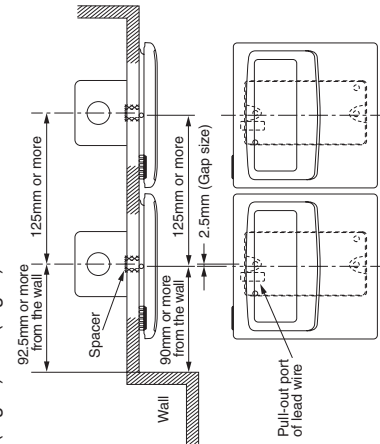

Fig. 1

*When installing the remote controller and the program weekly timer which are set in parallel at upper side and lower side, in consideration of maintenance, keep a clearance with 25mm or more.

How to install the program weekly timer

NOTE 1 :

Avoid to twist the program weekly timer cable with the power supply cable, etc. or to store them in the same metal pipe, otherwise it causes a malfunction.

NOTE 2 :

Install the program weekly timer apart from the generation source of noise.

NOTE 3 :

When noise is induced to the power source of the indoor unit, measures such as mounting the noise filter is necessary.

- Install the program weekly timer to the box (Procured locally) which has previously inserted in the wall.

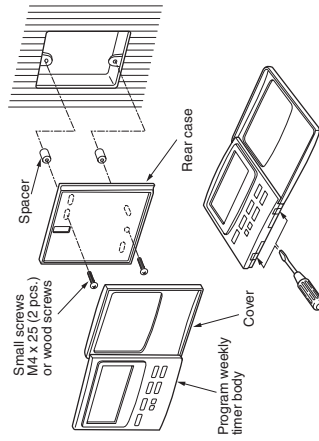
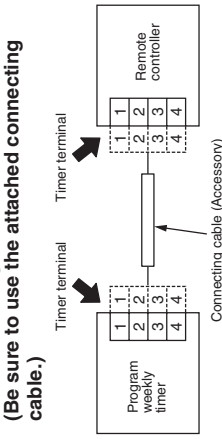

Fig. 2

- Inserting a minus screwdriver, etc. into the groove at the lower side of the program weekly timer, which appears when opening lid of the program weekly timer body, force open the rear case to remove it.
- Using the attached M4 screws or wood screws (2 pcs.), fix the rear case of the program weekly timer. Before installation, press to open the screw hole with a screwdriver, etc.
- Fix it with the spacer, but not so strongly. If the program weekly timer does not fit closely to the wall, adjust it by cutting off the spacer.
- Connect the attached connecting cable (4 cores) to the program weekly timer body.
- Install the program weekly timer body by matching to hooks on the rear case and putting into the hooks.

Cabling

Connection diagram (Be sure to use the attached connecting cable.)



Arrangement

The program weekly timer and the remote controller can be arranged to either right or left side.

Cabling procedure

Perform cabling in the following procedure.

- Connect the attached connecting cable to the timer terminal (4P connector) of the program weekly timer. (Fig. 3)

<Remote controller> <Program weekly timer>

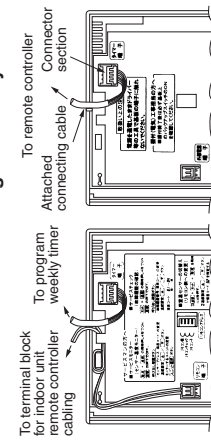

Fig. 3

- Pull the attached cable out of lead wire pull-out port on the rear case of the program weekly timer and connect the cable to the timer terminal (4P connector) of the remote controller via inside of the wall. (Fig. 4)

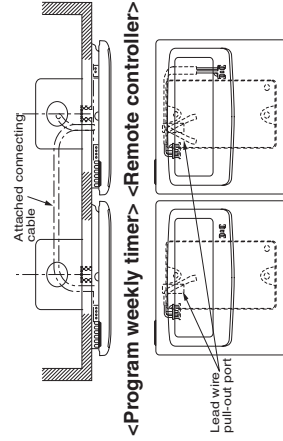
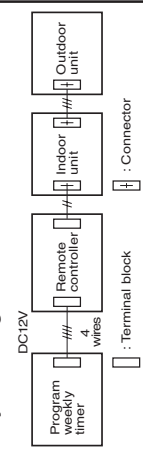

Fig. 4

System diagram



Program weekly timer test run setup

- After installation, check (OFF to ON) output status using the forced ON switch on the rear side of the program weekly timer P.C. board. Then check the normal operation and **certainly turn OFF the forced ON switch.**

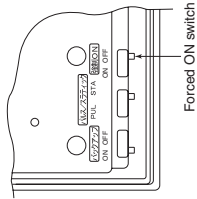

Memory backup function for power failure compensation

- This program weekly timer stores in memory the contents set by the operation button during a power failure. Pushing (PROGRAM) button resumes the operation with the contents before the power failure when the power failure has been reset.

How to use [BACKUP]

- After the installation work, check [BACKUP] switch on the rear side of the program weekly timer P.C. board is turned to ON side.

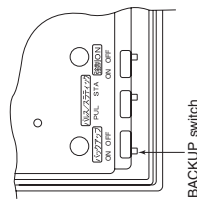

Explanation to customers

- After the installation work, hand "Owner's Manual" and "Installation Manual" to the customers.
- Explain use and maintenance methods to the customers according to "Owner's Manual".

TOSHIBA INSTALLATION MANUAL

To Personnel Charged in Installation (Electric) Work and Service

Remote sensor
MODEL : TCB-TC21LE

Accessory parts

Part Name	Q'ty	Part Name	Q'ty
Remote sensor (200mm-cable attached)	1	Spacer	2
Small screw M4 x 25	2	Wire joint	2
Wood screw	2	Cable clumper	1
		Installation Manual	1

Requirement to install the remote sensor

Installation place

- Install the remote sensor at a position with height 1 to 1.5m from the floor, where the average temperature in the room can be felt.
- Do not install the remote sensor at a place exposed to the direct sunlight or direct outside air, such as a side of window, etc.
- Do not install the remote sensor at a place behind something or rear side of something, where air flow is poor in the room.
- Do not install the remote controller near the freezing box or refrigerator because water proof or drop-proof is not applied to this remote controller.
- Be sure to set the remote sensor vertically on the wall surface, etc.

How to install the remote sensor

- NOTE 1 :** Avoid to twist the remote sensor cable with the power supply cable, etc. or to store them in the same metal pipe, otherwise it causes a malfunction.
- NOTE 2 :** Install the remote sensor apart from the generation source of noise.
- NOTE 3 :** When noise is induced to the power source of the indoor unit, some measures such as mounting the noise filter is necessary.
- In case of using the remote sensor as a concealed type

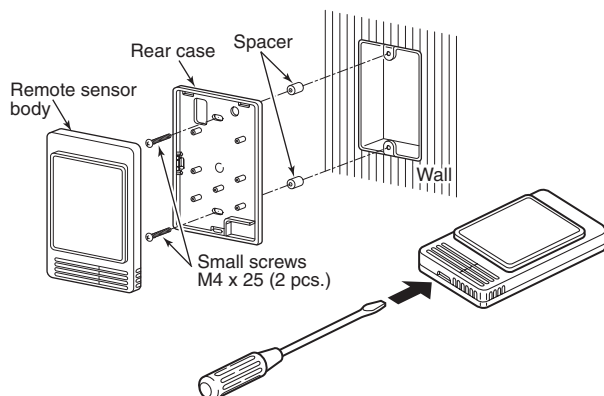

1. Inserting a minus screwdriver, etc. into the groove at the lower side of the remote sensor body, force open the rear case to remove it.
2. Using the attached M4 screws (2 pcs.), fix the rear case of the remote sensor. Before installation, press to open the screw hole with a screwdriver, etc.

Fix it with the spacer, but not so strongly. If the remote sensor does not fit closely to the wall, adjust it by cutting off the spacer.

3. Connect the remote sensor cable (2 cores) to the terminal numbers of the indoor unit.
(Applying AC 220/230/240V breaks the unit.)
4. Install the remote sensor body by matching to hooks on the rear case and putting into the hooks.

How to perform cabling of the remote sensor

In case of using the remote sensor as a concealed type

• Connection diagram

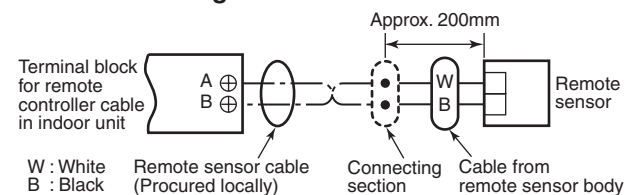

- Non polarity, 2 core cable is used..
- Use 0.5mm² to 2 mm² cable.

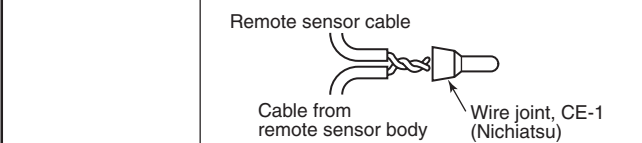

Attached wire joint
(White, 2 pcs.)

- 1) Peel the sheath of the cable to be connected by approx. 14mm.
- 2) Twist two cables and pressure-connect them using a wire joint.
- 3) When an exclusive pressure-connecting tool is not used or soldering connection is used, apply insulation process with an insulation tape.

Requirement for using the remote sensor together with the remote controller

• How to install

For the above control, install the remote sensor in the following procedure.

1. Set the remote controller as the master remote controller.
2. Do not change the remote sensor switch in the master remote controller for correct temperature control by remote sensor.

• Basic cabling diagram

1. Connect cables without miswiring.
(Miswiring breaks the unit.)
2. In a case to operate an indoor unit from the remote sensors and the remote controller.

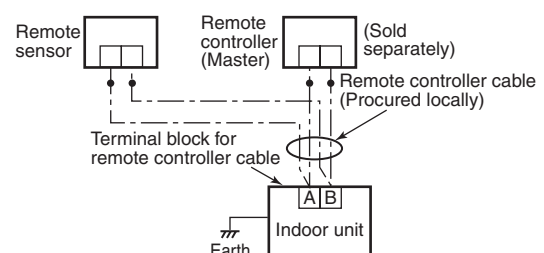

TOSHIBA

INSTALLATION MANUAL

Drain-up Kit for Concealed Duct Type Indoor Unit

MODEL: TCB-DP11BE

WARNING

- Ask the qualified installation professional to install the drain up kit. If drain up kit is inappropriate installed by yourself, it may cause a water leak, an electric shock fire and so on.
- Install the drain up kit surely according to this installation manual.
- When re-install the drain up kit, also ask the qualified installation professional to install it. If drain up kit is installed by yourself, it may cause a water leak, an electric shock fire and so on.

Configuration

Name	Qty	Name	Qty
A	1	E	3
B	1	F	4
C	2	G	2
D	1		

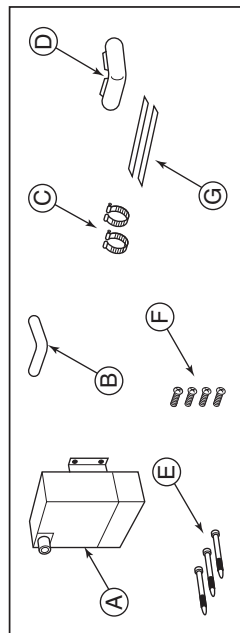

REQUIREMENT

- Be sure to install the drain up kit correctly according to the procedure described in this Installation Manual. Otherwise, the position of the drain pan on the drain up kit does not match with one on the air conditioner body, resulting in a water leak.
- Check the level of the air conditioner. (Check that it is horizontally set or the drain port side of the air conditioner is set with an inclination within 1° downward.)
- Be sure to make a check port to the lower ceiling part of the drain up kit.

How to install drain-up kit

- 1. Installation of drain-up kit body (See Fig. 1.)**
Open the cover of drain-up kit body, align the position and fasten the body using the attached 4 tapping screws.
- 2. Hose connection (See Fig. 1.)**
 - First connect the drain hose to pipe at the drain port of the drain up kit, and then connect it to the drain port of the air conditioner body.
 - Tighten the both ends of the drain hose with hose band. In this time, be sure to set the screw section of the hose band toward upper side.
 - Apply thermal insulation the drain hose with the attached thermal insulation pipe.
- 3. Drain piping**
 - Be sure to set the drain pipe from the drain up kit with falling gradient. Support and fix the drain pipe at an appropriate position so that an excessive load is not applied on the drain port.
 - Be sure to apply thermal insulation (procured locally) to the drain pipe.

<Fig. 1>

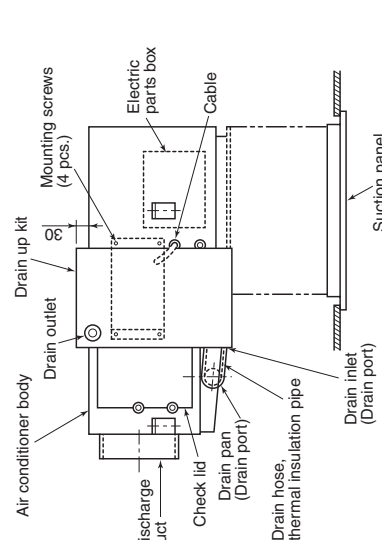

* Using the hose band, tighten the drain port and drain inlet of the drain pan. Also, be sure to set the screw section of the hose band toward upper side.

4. Cabling (See Fig. 2.)

- Remove cover of the electric parts box of the air conditioner body.
- Insert 3P connector (BLUE) of the drain up kit into the terminal No. CN068 (BLUE) in the electric parts box.
- Remove the short circuit connector (No. CN030) on the P.C. board in electric parts box.
- Insert 3P connector (RED) of the drain up kit into the terminal No. CN030 (RED) (Short-circuit connector is not used.)
- Clamp the cable in the electric parts box.

<Fig. 2>

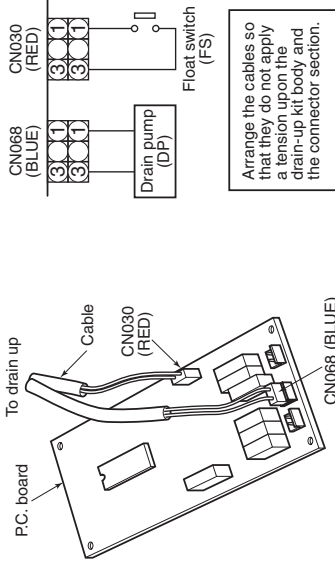

Arrange the cables so that they do not apply a tension upon the drain-up kit body and the connector section.

Test run

Condition check of water drain

After the electric work and cabling work, check the drain is smoothly discharged by running the air conditioner in COOL mode.

- If the cooling operation does not continue for a long time, pour water into the drain pan of the air conditioner body to check whether the drain is smoothly discharged or not.
- Check there is no water leak at each connecting section.

Operation check of float switch

- During cooling operation, operate the float switch.

Check the air conditioner stops the cooling operation under condition that the drain pump keeps operating.

- After operation in COOL mode, operate the float switch. In this time, check that the drain pump works to discharge the drain.

Position of float switch

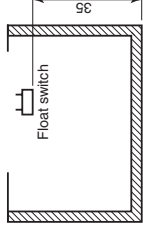

- To handle the float switch, remove the front panel of the kit and push up the floating section of the float switch with a screwdriver, etc.
- Be careful not to operate the float switch consecutively for 2 minutes or more because the air conditioner stops abnormally.

Maintenance/Check

In order to put the function of the air conditioner and the drain-up kit fully to practical use, the regular maintenance and check are necessary, together with correct usage.

For the air conditioner body and the drain-up kit especially, **check dirt of the drain pan once per year before cooling season and clean them if dirt is heavy.**

- It is recommended to make a contract with the customers for maintenance and check.

EH99824201 (EN)

TOSHIBA INSTALLATION MANUAL

To Personnel Charged in Installation Work and Service

Remote Controller Wireless Kit MODEL : TCB-AX21U (W)-E

Accessory parts

Part Name	Qty	Part Name	Qty
Sensor unit	1	Battery	2
Remote controller	1	Owner's Manual	1
Remote controller holder	1	Tapping screw M4 x 10mm	2
		Clamper	1
		Fixing screw M4 x 12mm	1

How to set the fan motor speed refer to the OWNER'S MANUAL

- * The positions where the sensors can be installed are limited to the corners (A) in Fig. 1. Therefore, for installation of the sensor units, consider the direction when a panel is installed to the indoor unit.
- Remove the suction grille.
 - Take off the screw fixing the corner cap and remove the corner cap sliding it side-ward. (Fig. 2)

How to install the sensors

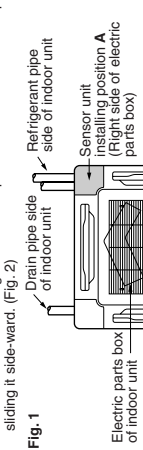
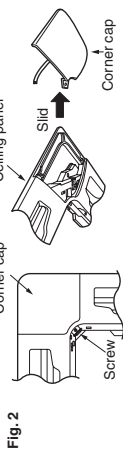
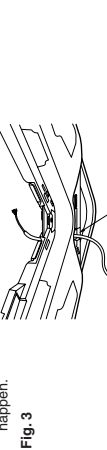

Fig. 2



- The thermal insulation material is stuffed in the square hole provided to pass through cables of the panel, so take off it once and pass the cable out of the sensor of wireless remote controller through the grille. Using a clamp, fix the cable with screws and then be sure to stuff again the removed thermal insulation material as original. (Fig. 3)
- If the thermal insulation material is not stuffed, dewing may happen.

Fig. 3



- After cabling according to "How to perform cabling of sensor units", remain the cable length enough to remove the sensor unit and fix it with screws using a clamp. (Fig. 3)
- Install the sensor units to the panel. In this time, slide the panel so that the hooks are fit in completely at 3 positions. And also be careful not to pinch the cable. (Fig. 4)

Fig. 4



NOTES :

- Avoid to twist the cables of the operation section with cables of the power supply, etc. It causes a malfunction.
- When noise is contained to the power supply of the indoor unit, counter measures such as mounting the noise filter is necessary.

How to perform cabling of sensor units

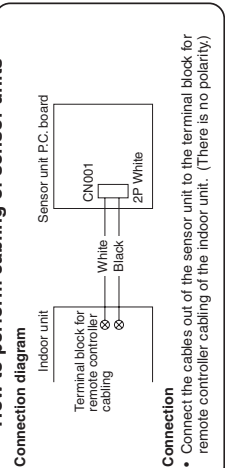

Requirement

- The control by two remote controllers is enabled by installing the wireless remote controller with the wired remote controller for an indoor unit.
- (Max. 2 remote controllers of wireless or wired are installable.)
- * 2-remote controllers' controlling means that one or multiple units are operated by the multiple remote controllers.

NOTES :

- Upon confirmation of the terminal numbers of the indoor unit, connect the remote controller cables without miscabling. (If applied AC 220/230/240 Volt, damage the unit.)
- The multiple wireless remote controller kits cannot concurrently be used for an indoor unit.
- When installing simultaneously the wireless remote controller with the wired remote controller, set one of them as the sub remote controller.
- When setting the wired remote controller as the sub, exchange the address connector at the rear of P.C. board of wired remote controller from master to sub remote controller.
- When setting the wireless remote controller as the sub, turn No.3 of DIP switch [S003] on P.C. board of wireless remote controller sensor unit from OFF to ON.

To operate an indoor unit by 2 remote controllers

- * The indoor unit is operated if either wireless or wired remote controller is set as master or sub remote controller. (Total cable length: Within 400m)

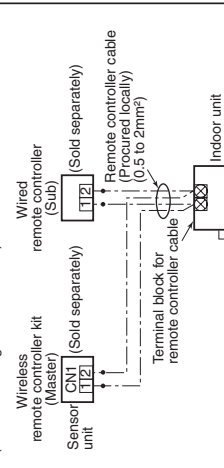

To operate a group control of multiple indoor units by 2 remote controllers

- * Master and Sub remote controllers are operable even if they are installed to any indoor unit. (Total cable length: Within 200m)

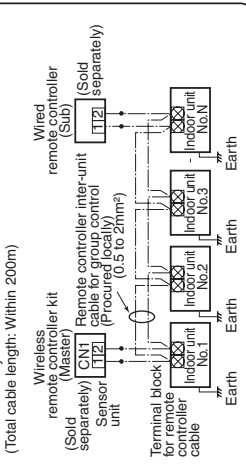

How to set the room temperature sensor

- The room temperature sensors are equipped in the indoor unit and the wireless remote controller. One of two sensors works.
- The room temperature sensor is set to the indoor unit side at the shipment from the factory. To select the sensor in the remote controller, push the SENSOP button (Right figure) inside of the remote controller cover and check "Main sensor" disappears from LCD.

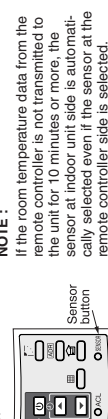

NOTE :

- If the room temperature data from the remote controller is not transmitted to the unit for 10 minutes or more, the sensor at indoor unit side is automatically selected even if the sensor at the remote controller side is selected. Fix the remote controller toward the unit as possible.

How to set the address switch

- When the multiple sensors are installed in the same room, an address can be set to prevent cross communication.
- When replacing the battery and pushing SET button, the address of the remote controller becomes [ALL] and the sensor is enabled to receive signal regardless of setting of address switch of the operation section.
- For selection of the remote controller address, refer to Owner's Manual.
- Change the address of the sensor by removing screws of P.C. board cover of the sensor unit. After then, fix the cover with screws using a clamp.

Address	Address	Address	Address
ALL	1	2	6

Display of remote controller address

Address switch position of sensor

* Address switch of sensor unit can be set any position.

Slide switch

- Check the slide switch in the battery box of the remote controller is set to (S) / (A) at shipment from the factory. Do not change the setting.

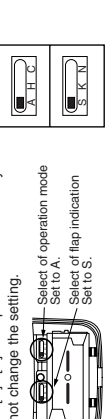

Self-diagnosis table and measures

Lamp indication	Cause	Measures
(No indication)	Power supply is not turned on. Miscabling between sensor unit and indoor remote controller unit is operated.	Check cable connection and correct it.
(Flashes alternately)	Defective connection between sensor unit and indoor unit	Check outdoor unit.
(Flashes)	Miscabling or defective connection between indoor and outdoor units	Check indoor unit.
(Flashes alternately)	Protective device of outdoor unit works.	Check outdoor unit.
(Flashes)	Protective device of indoor unit works.	Check indoor unit.

Test run

- How to use [TEST]**
- Turn No.1 of DIP switch [S003] on sensor P.C. board from OFF to ON.
 - During the test run, all the indication lamps on LCD flash.
 - During the test run, the temperature cannot be controlled.
 - After the test run, be sure to turn DIP switch 1 from ON to OFF and check the indication lamps do not flash.
- Use [TEST] function only for a test run, otherwise the unit is overloaded. Fix the cover as original.

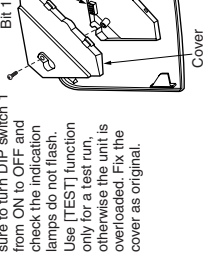

How to handle the remote controller

- In case using remote controller mounting to the wall, etc.**
- Check a signal is received correctly by pushing (ON) button at the position to be fixed.

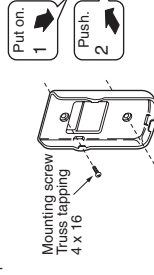

Replacement of battery

- To take off remote controller, pull it toward you.
- Holding the both ends of the cover and remove it by sliding downward.
 - Correctly insert 2 AAA alkali batteries matching + and - polarities with indications.
 - Push SET button with something tipped and attach the cover.

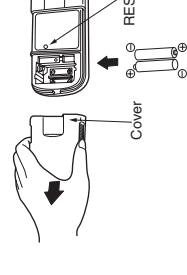

Cautions for installation of the remote controller

- To operate the remote controller by fixing it to the wall, etc. with a remote controller holder, turn on the fluorescent lamp, operate the remote controller at the position to be fixed, check the air conditioner normally operates, and then mount it.
- When the room temperature is sensed by the remote controller, mount the remote controller paying attention to the following items.
 - Place not exposed directly to cold or hot wind.
 - Place not exposed directly to the sunlight.
 - Other places where the remote controller is not influenced.

Explanation to customers

- Hand over the "Owner's Manual" and "Installation Manuals" to the customer after installation works.
- Explain usage and maintenance of the remote controller according to "Owner's Manual".

TOSHIBA INSTALLATION MANUAL

Use for Indoor Unit Only

MODEL : TCB-PCNT20E

Network Adapter for Air Conditioner

[For Installation Professionals]

- Thank you for purchasing the parts sold separately for TOSHIBA package air conditioner.
- Before installation work, please read this manual thoroughly and install the products correctly.
- Ensure that all Local, National and International regulations are satisfied.
- Read this "CAUTION SAFETY" carefully before installation.
- The precautions described below include the important items regarding safety.

CAUTIONS for SAFETY

WARNING

- Ask an authorized dealer or qualified installation professional to install/maintain the air conditioner. Inappropriate installation may result in water leakage, electric shock or fire.
- Turn off the main power supply switch or breaker before attempting any electrical work. Make sure all power switches are off. Failure to do so may cause electric shock.
- Connect the connecting cable correctly. If the connecting cable is connected in a wrong way, electric parts may be damaged.
- When moving the air conditioner for the installation into another place, be very careful not to enter any gaseous matter other than the specified refrigerant into the refrigeration cycle. If air or any other gas is mixed in the refrigerant, the gas pressure in the refrigeration cycle becomes abnormally high and it may resultingly causes pipe burst and injuries on persons.
- Do not modify this unit by removing any of the safety guards or by-passing any of the safety interlock switches.
- Exposure of unit to water or other moisture before installation may cause a short-circuit of electrical parts. Do not store it in a wet basement or expose to rain or water.

CAUTION

- Using the specified cables, surely so that the external force of the cable is not transmitted to the terminal connecting section, otherwise disconnection, heating, or fire may be caused.
- Do not apply an excessive force on the board body, otherwise bending, separation, or disconnection generates resulted in heating or fire.
- After installation work, execute a test run to confirm there is no trouble. And also ask the customers to keep this Manual by themselves.

Components

Part name	Qty	Description
P.C. board	1	P.C. board corresponded to the network
Relay terminal block	1	2P (X, Y) terminal block for relay
Relay cable (A)	1	For connection of adapter board with X, Y relay terminal block (Red connector)
Relay cable (B)	1	For connection of adapter board with remote controller terminal block (Blue connector)
Installation Manual	1	This manual
Spacer (A)	2	For fixing the adapter P.C. board (Used for other types than 4-way cassette type)
Spacer (B)	1	For fixing the adapter P.C. board (Used for other types than 4-way cassette type)
Spacer (C)	3	For fixing the adapter P.C. board (Used for 4-way cassette type)
Screws to fix terminal block	2	For fixing the relay terminal block (M4 x 14 l)
Transformer cover	1	Used to store transformer (For 4-way cassette type)
Transformer base	1	Used to store transformer (For 4-way cassette type)
Transformer	1	For supplying power to adapter
Screws to fix transformer	2	For fixing transformer (M3 x 6 l)
Screws to assemble transformer cover	2	For assembling transformer cover (M4 x 6 l for 4-way)
Screws to fix transformer base	2	For fixing transformer base (M4 x 10 l for 4-way)
Bundling band	3	Used to process cables so that they are not caught in.

Combination List of Adapter Parts

Parts	For 4-way type	For Concealed duct type
1 Adapter P.C. board	3 spacers (C) for installing P.C. board 1 spacer (B) for installing P.C. board	2 spacers (A) for installing P.C. board 1 spacer (B) for installing P.C. board
2 Transformer	M3 x 6 B tight screw (2 pcs.)	M3 x 6 B tight screw (2 pcs.)
3 For assembling transformer cover	M4 x 6 tapping screws (2 pcs.)	_____
4 For fixing transformer base	M4 x 10 plus tight screws (2 pcs.)	_____
5 XY terminal block	M4 x 14 tapping tight screws (2 pcs.)	M4 x 14 tapping tight screws (2 pcs.)
6 Adapter P.C. board to XY terminal block	Connector, red color, lead length : 600L	Connector, red color, lead length : 600L
7 Adapter P.C. board to AB terminal block	Connector, blue color, lead length : 600L	Connector, blue color, lead length : 600L

* Spacer (A) for installing P.C. board : Spacer to be mounted by using the hole on the P.C. board.
(For other types than 4-way cassette type)

Spacer (B) for installing P.C. board : Spacer to be mounted by pinching it in the P.C. board.
(For other types than 4-way cassette type)

Spacer (C) for installing P.C. board : Spacer to be mounted by using the hole on the P.C. board for 4-way cassette type.

Connection of Cables

1. Connection of network cables

- Attach one network adapter to a group of one group controlling (including one unit).
Connect the network adapter to any one of the indoor units in the group control.

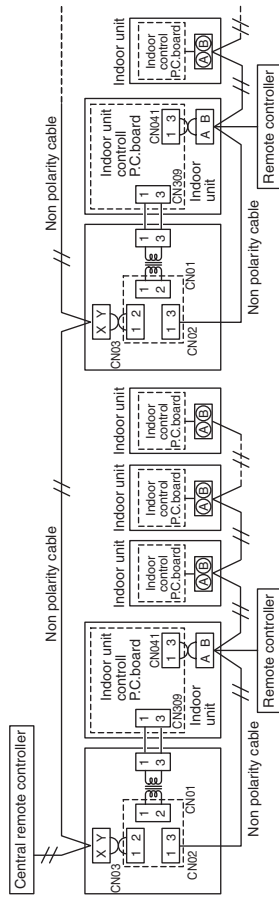

2. Cabling diagram of indoor control P.C. board

- For details, see the installation procedure for individual model.

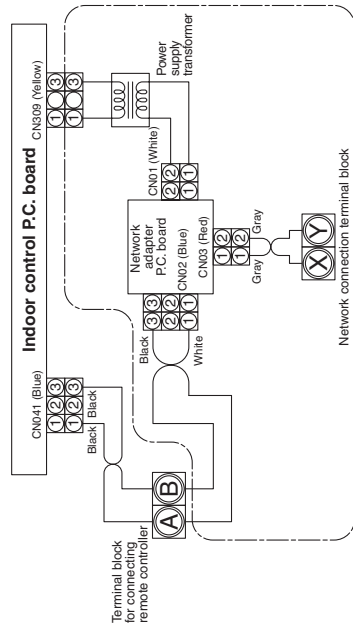

- The enclosed section with the chain line includes the attached parts.
- There is no polarity for cabling to the terminal blocks, A, B and X, Y.
- Arrange the total cable length of the remote controller cable and the inter-unit cable of the remote controller within 400m.

Installation Procedure

- For installation of the adapter P.C. board and removal of the relay cable, be sure to wait for a while (approx. 1 minute) after turning off the power supplies of the air conditioner and the collective control remote controller. If not doing so, the adapter P.C. board may be damaged.

■ In case of 4-way Ceiling Cassette (RAV-SM **0 UT-E)

No.	Procedure
1	Using the spacer (C), install the adapter P.C. board to the position of the electric parts box of the indoor unit.
2	Using the 2 pcs. Ø4 x 14/ tapping tight screws, install X, Y relay terminal block to the position of the electric parts box. <ul style="list-style-type: none"> When tightening the screws, be sure not to damage the cable.
3	Using 2 pcs. Ø4 x 6/ tapping screws, install the transformer box storing the transformer to the position at side of the bell mouth.
4	Using the relay cable (A), connect the X, Y relay terminal block with CN03 (Red) of the adapter P.C. board, and remote controller terminal block (A, B) with CN02 (Blue) of the adapter P.C. board using the relay cable (B), respectively. Perform cabling between the yellow connector of the transformer and CN309 of the adapter P.C. board, and between white connector to CN01 of the adapter P.C. board, respectively.

Details

Adapter TCB-PCNT20E sold separately

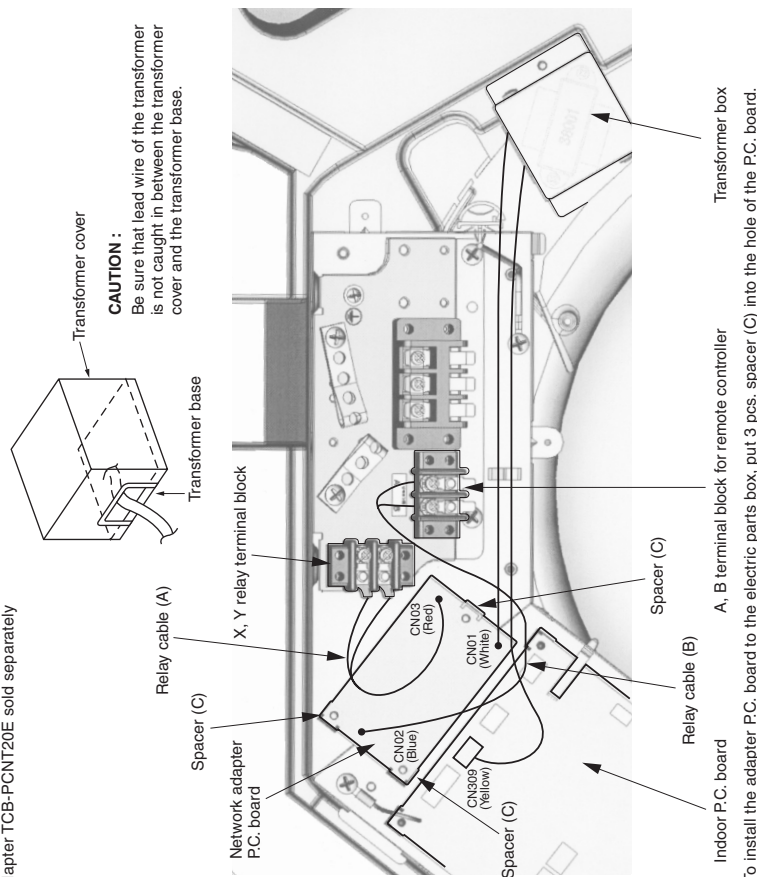

- * To install the adapter P.C. board to the electric parts box, put 3 pcs. spacer (C) into the hole of the P.C. board.
- * After connection of the relay cables (A) and (B), fix them along the neighboring cables with bundling band so that cables are not caught.

■ In case of Concealed Duct (RAV-SM **0 BT-E)

No.	Procedure
1	Using the spacer (A) and (B), install the adapter P.C. board to the position of the electric parts box.
2	Using the 2 pcs. Ø4 x 14/ tapping tight screws, install X, Y relay terminal block to the position of the electric parts box of the indoor unit. <ul style="list-style-type: none"> When tightening the screws, be sure not to damage the cable.
3	Using 2 pcs. Ø3 x 6 / B-tight screws, install the transformer to the position of the electric parts box of the indoor unit.
4	Using the relay cable (A), connect the X, Y relay terminal block with CN03 (Red) on the adapter P.C. board, and remote controller terminal block (A, B) with CN02 (Blue) on the adapter P.C. board using the relay cable (B), respectively. Perform cabling between the yellow connector of the transformer and CN309 on the indoor P.C. board, and between white connector and CN01 on the adapter P.C. board, respectively.

Details

Adapter TCB-PCNT20E sold separately

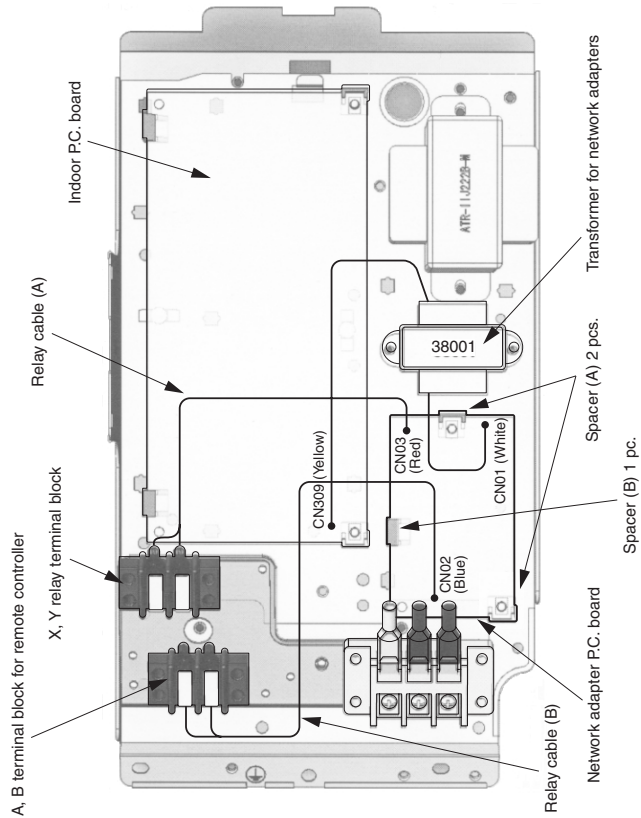

- * Relay cable (A): Connection between X, Y terminal block and CN03 on the adapter P.C. board
- * Relay cable (B): Connection between terminal block of the remote controller and CN02 on the adapter P.C. board
- * To install the adapter P.C. board to the electric parts box, put 2 pcs. spacers (A) into the hole of the P.C. board (At upper side and at lower right side of the P.C. board), and install one of them to the electric parts box (At lower left side of the P.C. board) using the board installing spacer (B) of a type which pinches the P.C. board.
- * After connection of the relay cables (A) and (B), fix them along the neighboring cables with bundling band so that cables are not caught.

Setup of the Address No.

To connect the indoor unit to the central remote controller using the adapter, it is necessary to set up the network address No.

- It is required to agree the network address No. with the central remote controller system No.
- The network address No. is set to 1 at the shipment from the factory. The following two methods are used for setup.
 - Setup from the remote controller at the indoor unit side**
 - This method is available only when [7] of the setup switch SW01 on the adapter P.C. board is OFF.

<Procedure> Set up the address No. while the air conditioner stops.

1 Push and buttons for 4 seconds or more.

In case of the group control, the unit No. **ALL** is displayed, and then all the indoor units in the group control are selected. (Fig. 1)

In this time, the fans of all the selected indoor units start and the swing operation also starts in the models with flaps. (Keep the display status of **ALL** without pushing button.)

In case of individual remote controller with no group control, the system address and the indoor unit address are displayed.

2 Using / buttons, specify the item code .

3 Using / buttons, select the setup data.

The following table shows the setup data. (Table 1)

4 Push button.

(When the display goes on, the setup data is accepted.)

To change the setup item, return to the step 2.

5 Push button. The status returns to the normal stop status.

(Fig. 1)

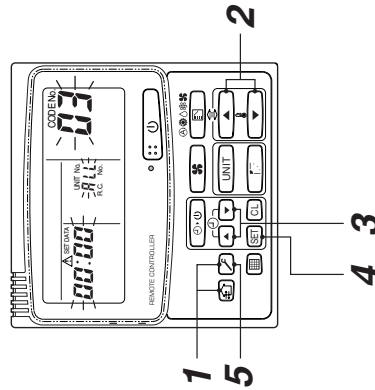

(Table 1)

Setup data	Network address No.
0001	1
0002	2
0003	3
⋮	⋮
⋮	⋮
0064	64
0099	No setting (Shipment from the factory.)

2. Setup by the switch on the adapter P.C. board

When the remote controller is not found, or when you do not want to change the setup of network address No. on the remote controller, set up the address No. by using the setup switch SW01 (Network address No. setup switch) on the adapter P.C. board.

<Procedure>

1 Turn off the power supply.

2 Set [7] of the address No. setup switch SW01 to ON side.

Accordingly, the setup of the address No. from the remote controller is invalidated. (Fig. 2)

3 The network address No. is set up by combining ON/OFF of the address No. setup switch, from SW01 [6] to [1].

For the relation between ON/OFF combination and the address No., see (Table 2). A case when the address No. is set to 16 is shown in (Fig. 3).

Address No. setup on the remote controller is invalid.

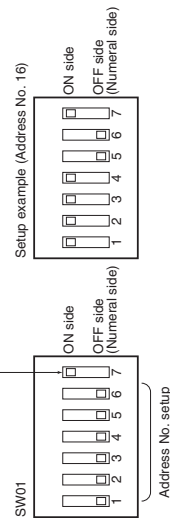

(Fig. 2)

(Fig. 3)

When the network address No. has been changed, turn on the power of the central remote controller again or reset the central remote controller from the reset hole on the control panel of the central remote controller.

■ Address No. setup table (SW01)

(Table 2)

Address No.	①	②	③	④	⑤	⑥
01	x	x	x	x	x	x
02	o	x	x	x	x	x
03	o	o	x	x	x	x
04	o	o	x	x	x	x
05	x	x	o	x	x	x
06	o	x	o	x	x	x
07	o	o	o	x	x	x
08	o	o	o	x	x	x
09	x	x	x	o	x	x
10	o	x	x	o	x	x
11	x	o	x	o	x	x
12	o	o	x	o	x	x
13	x	x	o	o	x	x
14	o	x	o	o	x	x
15	x	o	o	o	x	x
16	o	o	o	o	x	x
17	x	x	x	x	x	x
18	o	x	x	x	o	x
19	x	o	x	x	o	x
20	o	o	x	x	o	x
21	x	x	o	x	o	x
22	o	x	o	x	o	x
23	x	o	o	x	o	x
24	o	o	o	x	o	x
25	x	x	x	x	o	x
26	o	x	x	o	o	x
27	x	o	x	o	o	x
28	o	x	o	o	o	x
29	x	x	o	o	o	x
30	o	x	o	o	o	x
31	x	x	o	o	o	x
32	o	o	o	o	o	x
33	x	x	x	x	x	o
34	o	x	x	x	x	o
35	x	o	x	x	x	o
36	o	o	x	x	x	o
37	x	x	o	x	x	o
38	o	x	o	x	x	o
39	x	o	o	x	x	o
40	o	o	o	x	x	o
41	x	x	x	o	x	o
42	o	x	x	o	x	o
43	x	o	x	o	x	o
44	o	o	x	o	x	o
45	x	x	o	o	x	o
46	o	x	o	o	x	o
47	x	o	o	o	x	o
48	o	o	o	x	x	o
49	x	x	x	x	x	o
50	o	x	x	x	x	o
51	x	o	x	x	x	o
52	o	o	x	x	x	o
53	x	x	o	x	x	o
54	o	x	o	x	x	o
55	x	o	o	x	x	o
56	o	o	o	x	x	o
57	x	x	x	x	x	o
58	o	x	x	o	o	o
59	x	o	x	o	o	o
60	o	x	o	o	o	o
61	x	x	o	o	o	o
62	o	x	o	o	o	o
63	x	x	o	o	o	o
64	o	o	o	o	o	o

o : ON side, x : OFF side



Requirement in Service Time

When using this product as the service part for change of the adapter P.C. board, be sure to set the setup switch SW01 (Network address No. setup switch) on the adapter P.C. board so that it is same as one before change.

To Customers

◆◆ Cautions in using the remote controller ◆◆

- After all the power supplies of the air conditioner have been turned on, turn on the power supply of the central remote controller. (16-systems : RBC-CR1-PE, 64-systems : RBC-CR64-PE)
If the power supplies of the air conditioner and the remote controller are turned on at the same time, or if they are turned on in reverse order, the check code [97] may be temporarily displayed on the central remote controller. When the connection cabling and setup of the central address are correct, the connected air conditioner is displayed on the central remote controller.
- As described below, there are differences of the display on LCD and the individual restrictions for the operation in the handy remote controller (RBC-AMT21E) and the central remote controller.

Item	Contents		Cautions
	Main remote controller	Central remote controller	
1 Fan speed select	④⑤⑥⑦⑧⑨⑩⑪	④⑤⑥⑦⑧⑨⑩⑪	Display of air speed selection differs.
2 Fan speed select in FAN mode	⑫⑬⑭⑮⑯	④⑤⑥⑦⑧⑨⑩⑪	When operating the main remote controller, ④⑤⑥ is not displayed. If selecting ④⑤⑥ at the central side, ④⑤⑥ is displayed on the main remote controller. In this time, the air speed is ⑫.
3 Fan speed select in DRY mode	④⑤⑥⑦⑧⑨⑩⑪	④⑤⑥	④⑤⑥ only is displayed on the central remote controller. ④⑤⑥ is displayed on the main remote controller even by change of the setup temperature/louver, and the air speed changes automatically.
4 Air direction adjustment	 and air direction adjustment (No display)	[LOUVER]	[LOUVER] only is displayed on the central remote controller. [LOUVER] is displayed when the flap is swinging, and ON and OFF of the swing operation set to the louver are exchanged.
5 Check button	(No display)	[LOUVER] Manual	Set the air direction on the main remote controller.
6 Check code	Test run (4 seconds) Display with 3 digits (Alphabet + 2 digits numerals)	Display of check code and Check reset (3 seconds) Display with 2 digits (Alphabet or numerals)	In case of type without function of air direction adjustment The function differs when the  button is pushed for a long time. If the central remote controller-ON is reset during operation of the air conditioner, the operation stops temporarily, and then the operation is resumed. (Trouble of the air conditioner is cleared.) The display of the check code differs. Ex.) Float switch operation Main side : [P10]. Collective side : [0b]

- When using the remote controller with the former remote controller (RBC-AM1E, AT1E), if Last-push priority/Center/Locked is selected on the central remote controller, the display differs on the main remote controller

Item	Contents		Remarks
	New remote controller (RBC-AMT21E)	Former remote controller (RBC-AM1E, AT1E)	
1 Last-push priority	(No display)	(No display)	All the setups and Start/Stop operation are available.
2 Center	CENTER goes on.	CENTER goes on.	The setup contents of the central remote controller are fixed, and the Start/Stop operation and timer operation are available on the main remote controller.
3 Locked	CENTER goes on.	CENTER flashes.	The setup contents of the central remote controller are fixed, and the air conditioner stops. The operation on the main remote controller is unavailable.

* Before using the remote controller, read the Owner's Manual thoroughly to use it correctly.

EH99774901-① (EN)

TOSHIBA CARRIER CORPORATION
336 TADEHARA FUJI-SHI, SHIZUOKA-KEN, 416-8521, JAPAN

Free Manuals Download Website

<http://myh66.com>

<http://usermanuals.us>

<http://www.somanuals.com>

<http://www.4manuals.cc>

<http://www.manual-lib.com>

<http://www.404manual.com>

<http://www.luxmanual.com>

<http://aubethermostatmanual.com>

Golf course search by state

<http://golfingnear.com>

Email search by domain

<http://emailbydomain.com>

Auto manuals search

<http://auto.somanuals.com>

TV manuals search

<http://tv.somanuals.com>