



# TOSHIBA

Leading Innovation >>>

## AIR CONDITIONER (SPLIT TYPE) Installation Manual



### Indoor Unit

Model name:

Concealed Duct High Static Pressure Type

**RAV-SM2242DT-E**

**RAV-SM2802DT-E**

Installation Manual Air conditioner (Split type)	1	English
Manuel d'installation Climatiseur (Type split)	41	Français
Installationsanleitung Klimagerät (Split-typ)	81	Deutsch
Manuale di installazione Condizionatore d'aria (Tipo split)	121	Italiano
Manual de instalación Aire acondicionado (Tipo split)	161	Español

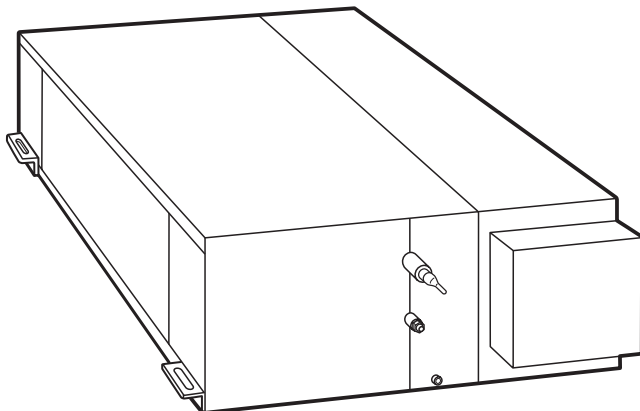

## Original instruction

**ADOPTION OF NEW REFRIGERANT**

This Air Conditioner uses R410A an environmentally friendly refrigerant.

## Contents

<b>1 PRECAUTIONS FOR SAFETY.....</b>	<b>5</b>
<b>2 ACCESSORY PARTS.....</b>	<b>8</b>
<b>3 SELECTION OF INSTALLATION PLACE.....</b>	<b>9</b>
<b>4 INSTALLATION.....</b>	<b>11</b>
<b>5 FAN CHARACTERISTICS.....</b>	<b>15</b>
<b>6 DRAIN PIPING WORK.....</b>	<b>18</b>
<b>7 REFRIGERANT PIPING AND EVACUATING.....</b>	<b>22</b>
<b>8 ELECTRICAL CONNECTION.....</b>	<b>25</b>
<b>9 APPLICABLE CONTROLS.....</b>	<b>28</b>
<b>10 TEST RUN.....</b>	<b>35</b>
<b>11 MAINTENANCE.....</b>	<b>36</b>
<b>12 TROUBLESHOOTING.....</b>	<b>38</b>

Thank you for purchasing this Toshiba air conditioner.

Please read carefully through these instructions that contain important information which complies with the “Machinery” Directive (Directive 2006/42/EC), and ensure that you understand them.

Some of the details provided in these instructions differ from the Installation Manual supplied with your product, and the instructions provided here take precedence.

After reading these instructions, be sure to keep them in a safe place together with the Owner’s Manual and Installation Manual supplied with your product.

**Generic Denomination: Air Conditioner**

**Definition of Qualified Installer or Qualified Service Person**

The air conditioner must be installed, maintained, repaired and removed by a qualified installer or qualified service person. When any of these jobs is to be done, ask a qualified installer or qualified service person to do them for you.

A qualified installer or qualified service person is an agent who has the qualifications and knowledge described in the table below.

Agent	Qualifications and knowledge which the agent must have
Qualified installer	<ul style="list-style-type: none"> <li>• The qualified installer is a person who installs, maintains, relocates and removes the air conditioners made by Toshiba Carrier Corporation. He or she has been trained to install, maintain, relocate and remove the air conditioners made by Toshiba Carrier Corporation or, alternatively, he or she has been instructed in such operations by an individual or individuals who have been trained and is thus thoroughly acquainted with the knowledge related to these operations.</li> <li>• The qualified installer who is allowed to do the electrical work involved in installation, relocation and removal has the qualifications pertaining to this electrical work as stipulated by the local laws and regulations, and he or she is a person who has been trained in matters relating to electrical work on the air conditioners made by Toshiba Carrier Corporation or, alternatively, he or she has been instructed in such matters by an individual or individuals who have been trained and is thus thoroughly acquainted with the knowledge related to this work.</li> <li>• The qualified installer who is allowed to do the refrigerant handling and piping work involved in installation, relocation and removal has the qualifications pertaining to this refrigerant handling and piping work as stipulated by the local laws and regulations, and he or she is a person who has been trained in matters relating to refrigerant handling and piping work on the air conditioners made by Toshiba Carrier Corporation or, alternatively, he or she has been instructed in such matters by an individual or individuals who have been trained and is thus thoroughly acquainted with the knowledge related to this work.</li> <li>• The qualified installer who is allowed to work at heights has been trained in matters relating to working at heights with the air conditioners made by Toshiba Carrier Corporation or, alternatively, he or she has been instructed in such matters by an individual or individuals who have been trained and is thus thoroughly acquainted with the knowledge related to this work.</li> </ul>
Qualified service person	<ul style="list-style-type: none"> <li>• The qualified service person is a person who installs, repairs, maintains, relocates and removes the air conditioners made by Toshiba Carrier Corporation. He or she has been trained to install, repair, maintain, relocate and remove the air conditioners made by Toshiba Carrier Corporation or, alternatively, he or she has been instructed in such operations by an individual or individuals who have been trained and is thus thoroughly acquainted with the knowledge related to these operations.</li> <li>• The qualified service person who is allowed to do the electrical work involved in installation, repair, relocation and removal has the qualifications pertaining to this electrical work as stipulated by the local laws and regulations, and he or she is a person who has been trained in matters relating to electrical work on the air conditioners made by Toshiba Carrier Corporation or, alternatively, he or she has been instructed in such matters by an individual or individuals who have been trained and is thus thoroughly acquainted with the knowledge related to this work.</li> <li>• The qualified service person who is allowed to do the refrigerant handling and piping work involved in installation, repair, relocation and removal has the qualifications pertaining to this refrigerant handling and piping work as stipulated by the local laws and regulations, and he or she is a person who has been trained in matters relating to refrigerant handling and piping work on the air conditioners made by Toshiba Carrier Corporation or, alternatively, he or she has been instructed in such matters by an individual or individuals who have been trained and is thus thoroughly acquainted with the knowledge related to this work.</li> <li>• The qualified service person who is allowed to work at heights has been trained in matters relating to working at heights with the air conditioners made by Toshiba Carrier Corporation or, alternatively, he or she has been instructed in such matters by an individual or individuals who have been trained and is thus thoroughly acquainted with the knowledge related to this work.</li> </ul>



### Definition of Protective Gear





When the air conditioner is to be transported, installed, maintained, repaired or removed, wear protective gloves and 'safety' work clothing.

In addition to such normal protective gear, wear the protective gear described below when undertaking the special work detailed in the table below.

Failure to wear the proper protective gear is dangerous because you will be more susceptible to injury, burns, electric shocks and other injuries.

Work undertaken	Protective gear worn
All types of work	Protective gloves 'Safety' working clothing
Electrical-related work	Gloves to provide protection for electricians and from heat Insulating shoes Clothing to provide protection from electric shock
Work done at heights (50 cm or more)	Helmets for use in industry
Transportation of heavy objects	Shoes with additional protective toe cap
Repair of outdoor unit	Gloves to provide protection for electricians and from heat

## ■ Warning Indications on the Air Conditioner Unit

Warning indication	Description		
 <table border="1" data-bbox="350 363 678 575"> <tr> <td data-bbox="350 363 678 436" style="text-align: center;"><b>WARNING</b></td> </tr> <tr> <td data-bbox="350 436 678 575"> <b>ELECTRICAL SHOCK HAZARD</b>                      Disconnect all remote electric power supplies before servicing.                 </td> </tr> </table>	<b>WARNING</b>	<b>ELECTRICAL SHOCK HAZARD</b> Disconnect all remote electric power supplies before servicing.	<p><b>WARNING</b></p> <p><b>ELECTRICAL SHOCK HAZARD</b>                      Disconnect all remote electric power supplies before servicing.</p>
<b>WARNING</b>			
<b>ELECTRICAL SHOCK HAZARD</b> Disconnect all remote electric power supplies before servicing.			
 <table border="1" data-bbox="350 632 678 844"> <tr> <td data-bbox="350 632 678 705" style="text-align: center;"><b>WARNING</b></td> </tr> <tr> <td data-bbox="350 705 678 844">                     Moving parts.                      Do not operate unit with grille removed.                      Stop the unit before the servicing.                 </td> </tr> </table>	<b>WARNING</b>	Moving parts. Do not operate unit with grille removed. Stop the unit before the servicing.	<p><b>WARNING</b></p> <p>Moving parts.                      Do not operate unit with grille removed.                      Stop the unit before the servicing.</p>
<b>WARNING</b>			
Moving parts. Do not operate unit with grille removed. Stop the unit before the servicing.			
 <table border="1" data-bbox="350 900 678 1113"> <tr> <td data-bbox="350 900 678 974" style="text-align: center;"><b>CAUTION</b></td> </tr> <tr> <td data-bbox="350 974 678 1113">                     High temperature parts.                      You might get burned when removing this panel.                 </td> </tr> </table>	<b>CAUTION</b>	High temperature parts. You might get burned when removing this panel.	<p><b>CAUTION</b></p> <p>High temperature parts.                      You might get burned when removing this panel.</p>
<b>CAUTION</b>			
High temperature parts. You might get burned when removing this panel.			
 <table border="1" data-bbox="350 1169 678 1381"> <tr> <td data-bbox="350 1169 678 1243" style="text-align: center;"><b>CAUTION</b></td> </tr> <tr> <td data-bbox="350 1243 678 1381">                     Do not touch the aluminum fins of the unit.                      Doing so may result in injury.                 </td> </tr> </table>	<b>CAUTION</b>	Do not touch the aluminum fins of the unit. Doing so may result in injury.	<p><b>CAUTION</b></p> <p>Do not touch the aluminium fins of the unit.                      Doing so may result in injury.</p>
<b>CAUTION</b>			
Do not touch the aluminum fins of the unit. Doing so may result in injury.			
 <table border="1" data-bbox="350 1438 678 1650"> <tr> <td data-bbox="350 1438 678 1512" style="text-align: center;"><b>CAUTION</b></td> </tr> <tr> <td data-bbox="350 1512 678 1650"> <b>BURST HAZARD</b>                      Open the service valves before the operation, otherwise there might be the burst.                 </td> </tr> </table>	<b>CAUTION</b>	<b>BURST HAZARD</b> Open the service valves before the operation, otherwise there might be the burst.	<p><b>CAUTION</b></p> <p><b>BURST HAZARD</b>                      Open the service valves before the operation, otherwise there might be the burst.</p>
<b>CAUTION</b>			
<b>BURST HAZARD</b> Open the service valves before the operation, otherwise there might be the burst.			

EN

# 1 PRECAUTIONS FOR SAFETY



## General

- Before starting to install the air conditioner, read carefully through the Installation Manual, and follow its instructions to install the air conditioner.
- Only a qualified installer(\*1) or qualified service person(\*1) is allowed to install the air conditioner. If the air conditioner is installed by an unqualified individual, a fire, electric shocks, injury, water leakage, noise and/or vibration may result.
- Before opening the intake grille of the indoor unit or service panel of the outdoor unit, set the circuit breaker to the OFF position. Failure to set the circuit breaker to the OFF position may result in electric shocks through contact with the interior parts. Only a qualified installer(\*1) or qualified service person(\*1) is allowed to remove the intake grille of the indoor unit or service panel of the outdoor unit and do the work required.
- Before carrying out the installation, maintenance, repair or removal work, be sure to set the circuit breaker to the OFF position. Otherwise, electric shocks may result.
- Place a "Work in progress" sign near the circuit breaker while the installation, maintenance, repair or removal work is being carried out. There is a danger of electric shocks if the circuit breaker is set to ON by mistake.
- Only a qualified installer(\*1) or qualified service person(\*1) is allowed to undertake work at heights using a stand of 50 cm or more or to remove the intake grille of the indoor unit to undertake work.
- Wear protective gloves and safety work clothing during installation, servicing and removal.
- Do not touch the aluminium fin of the outdoor unit. You may injure yourself if you do so. If the fin must be touched for some reason, first put on protective gloves and safety work clothing, and then proceed.
- Do not climb onto or place objects on top of the outdoor unit. You may fall or the objects may fall off of the outdoor unit and result in injury.
- When working at heights, use a ladder which complies with the ISO 14122 standard, and follow the procedure in the ladder's instructions. Also wear a helmet for use in industry as protective gear to undertake the work.
- When cleaning the filter or other parts of the outdoor unit, set the circuit breaker to OFF without fail, and place a "Work in progress" sign near the circuit breaker before proceeding with the work.
- When working at heights, put a sign in place so that no-one will approach the work location, before proceeding with the work. Parts and other objects may fall from above, possibly injuring a person below.
- The refrigerant used by this air conditioner is the R410A.
- You shall ensure that the air conditioner is transported in stable condition.
- Do not move or repair any unit by yourself. There is high voltage inside the unit. You may get electric shock when removing the cover and main unit.

## Selection of installation location

- If you install the unit in a small room, take appropriate measures to prevent the refrigerant from exceeding the limit concentration even if it leaks. Consult the dealer from whom you purchased the air conditioner when you implement the measures. Accumulation of highly concentrated refrigerant may cause an oxygen deficiency accident.
- Do not install the air conditioner in a location that may be subject to a risk of exposure to a combustible gas. If a combustible gas leaks and becomes concentrated around the unit, a fire may occur.
- When transporting the air conditioner, wear shoes with additional protective toe caps.
- When transporting the air conditioner, do not take hold of the bands around the packing carton. You may injure yourself if the bands should break.
- Install the indoor unit at least 2.5 m above the floor level since otherwise the users may injure themselves or receive electric shocks if they poke their fingers or other objects into the indoor unit while the air conditioner is running.
- Do not place any combustion appliance in a place where it is directly exposed to the wind of air conditioner, otherwise it may cause imperfect combustion.

## Installation

- When the indoor unit is to be suspended, the designated hanging bolts (M10 or W3/8) and nuts (M10 or W3/8) must be used.
- Install the air conditioner at enough strong places to withstand the weight of the unit. If the strength is not enough, the unit may fall down resulting in injury.
- Follow the instructions in the Installation Manual to install the air conditioner. Failure to follow these instructions may cause the product to fall down or topple over or give rise to noise, vibration, water leakage, etc.
- The designated bolts (M10, M12) and nuts (M10, M12) for securing the outdoor unit must be used when installing the unit.
- Install the outdoor unit properly in a location that is durable enough to support the weight of the outdoor unit. Insufficient durability may cause the outdoor unit to fall, which may result in injury.

### Refrigerant piping

- Install the refrigerant pipe securely during the installation work before operating the air conditioner. If the compressor is operated with the valve open and without refrigerant pipe, the compressor sucks air and the refrigeration cycle is over pressurized, which may cause an injury.
- Tighten the flare nut with a torque wrench in the specified manner. Excessive tightening of the flare nut may cause a crack in the flare nut after a long period, which may result in refrigerant leakage.
- After the installation work, confirm that refrigerant gas does not leak. If refrigerant gas leaks into the room and flows near a fire source, such as a cooking range, noxious gas may be generated.
- When the air conditioner has been installed or relocated, follow the instructions in the Installation Manual and purge the air completely so that no gases other than the refrigerant will be mixed in the refrigerating cycle. Failure to purge the air completely may cause the air conditioner to malfunction.
- Nitrogen gas must be used for the airtight test.
- The charge hose must be connected in such a way that it is not slack.
- If refrigerant gas has leaked during the installation work, ventilate the room immediately. If the leaked refrigerant gas comes in contact with fire, noxious gas may be generated.

### Electrical wiring

- Only a qualified installer(\*1) or qualified service person(\*1) is allowed to carry out the electrical work of the air conditioner. Under no circumstances must this work be done by an unqualified individual since failure to carry out the work properly may result in electric shocks and/or electrical leaks.
- When connecting the electrical wires, repairing the electrical parts or undertaking other electrical jobs, wear gloves to provide protection for electricians and from heat, insulating shoes and clothing to provide protection from electric shocks. Failure to wear this protective gear may result in electric shocks.
- Use wiring that meets the specifications in the Installation Manual and the stipulations in the local regulations and laws. Use of wiring which does not meet the specifications may give rise to electric shocks, electrical leakage, smoking and/or a fire.
- Be sure to connect earth wire. (Grounding work)  
Incomplete grounding causes an electric shock.
- Do not connect ground wires to gas pipes, water pipes, and lightning rods or ground wires for telephone wires.
- After completing the repair or relocation work, check that the ground wires are connected properly.
- Install a circuit breaker that meets the specifications in the installation manual and the stipulations in the local regulations and laws.
- Install the circuit breaker where it can be easily accessed by the agent.
- When installing the circuit breaker outdoors, install one which is designed to be used outdoors.
- Under no circumstances must the power cable be extended. Connection trouble in the places where the cable is extended may give rise to smoking and/or a fire.
- Electrical wiring work shall be conducted according to law and regulation in the community and installation manual. Failure to do so may result in electrocution or short circuit.

### Test run

- Before operating the air conditioner after having completed the work, check that the electrical parts box cover of the indoor unit and service panel of the outdoor unit are closed, and set the circuit breaker to the ON position. You may receive an electric shock if the power is turned on without first conducting these checks.
- When you have noticed that some kind of trouble (such as when an error display has appeared, there is a smell of burning, abnormal sounds are heard, the air conditioner fails to cool or heat or water is leaking) has occurred in the air conditioner, do not touch the air conditioner yourself but set the circuit breaker to the OFF position, and contact a qualified service person. Take steps to ensure that the power will not be turned on (by marking "out of service" near the circuit breaker, for instance) until qualified service person arrives. Continuing to use the air conditioner in the trouble status may cause mechanical problems to escalate or result in electric shocks, etc.
- After the work has finished, be sure to use an insulation tester set (500V Megger) to check the resistance is 2 MΩ or more between the charge section and the non-charge metal section (Earth section). If the resistance value is low, a disaster such as a leak or electric shock is caused at user's side.
- Upon completion of the installation work, check for refrigerant leaks and check the insulation resistance and water drainage. Then conduct a test run to check that the air conditioner is operating properly.

### Explanations given to user

- Upon completion of the installation work, tell the user where the circuit breaker is located. If the user does not know where the circuit breaker is, he or she will not be able to turn it off in the event that trouble has occurred in the air conditioner.
- If you have discovered that the fan grille is damaged, do not approach the outdoor unit but set the circuit breaker to the OFF position, and contact a qualified service person(\*1) to have the repairs done. Do not set the circuit breaker to the ON position until the repairs are completed.
- After the installation work, follow the Owner's Manual to explain to the customer how to use and maintain the unit.

### Relocation

- Only a qualified installer(\*1) or qualified service person(\*1) is allowed to relocate the air conditioner. It is dangerous for the air conditioner to be relocated by an unqualified individual since a fire, electric shocks, injury, water leakage, noise and/or vibration may result.
- When carrying out the pump-down work shut down the compressor before disconnecting the refrigerant pipe. Disconnecting the refrigerant pipe with the service valve left open and the compressor still operating will cause air, etc. to be sucked in, raising the pressure inside the refrigeration cycle to an abnormally high level, and possibly resulting in rupture, injury or other trouble.

(\*1) Refer to the "Definition of Qualified Installer or Qualified Service Person."

---

 **CAUTION**

---

**New Refrigerant Air Conditioner Installation**

- **THIS AIR CONDITIONER ADOPTS THE NEW HFC REFRIGERANT (R410A) WHICH DOES NOT DESTROY OZONE LAYER.**



- The characteristics of R410A refrigerant are; easy to absorb water, oxidizing membrane or oil, and its pressure is approx. 1.6 times higher than that of refrigerant R22. Accompanied with the new refrigerant, refrigerating oil has also been changed. Therefore, during installation work, be sure that water, dust, former refrigerant, or refrigerating oil does not enter the refrigerating cycle.
- To prevent charging an incorrect refrigerant and refrigerating oil, the sizes of connecting sections of charging port of the main unit and installation tools are changed from those for the conventional refrigerant.
- Accordingly the exclusive tools are required for the new refrigerant (R410A).
- For connecting pipes, use new and clean piping designed for R410A, and please care so that water or dust does not enter.

**To Disconnect the Appliance from Main Power Supply.**

- This appliance must be connected to the main power supply by means of a switch with a contact separation of at least 3 mm.
  - **The installation fuse must be used for the power supply line of this conditioner.**
-



## 2 ACCESSORY PARTS

Part name	Q'ty	Shape	Usage
Installation Manual	2	This manual	(Be sure to hand over to customers) (For other languages that do not appear in this Installation Manual, please refer to the enclosed CD-R.)
Owner's Manual	1		(Be sure to hand over to customers)
Heat insulator	1		For heat insulation of Gas pipe connecting section
	1		For heat insulation of Liquid pipe connecting section
Joint (Ø22.2 – Ø28.6 mm)	1		For connecting the gas side pipe

EN

# 3 SELECTION OF INSTALLATION PLACE

Upon approval of the customer, install the air conditioner in a place that satisfies the following conditions.

- Place where the unit can be installed horizontally.
- Place where a sufficient servicing space can be ensured for safety maintenance and check.
- Place where drained water will not cause any problem.

## Avoid installing in the following places.

- Place exposed to air with high salt content (seaside area), or place exposed to large quantities of sulfide gas (hot spring). (Should the unit be used in these places, special protective measures are needed.)
- A restaurant kitchen where a lot of oil is used or place near machines in a factory (Oil adhering to the heat exchanger and resin part (fan) in the indoor unit may reduce the performance, generate mist or dew drop, or deform or damage resin parts.)
- Place where organic solvent is used nearby.
- Place close to a machine generating high frequency.
- Place where the discharged air blows directly into the window of the neighbour house. (Outdoor unit)
- Place where noise of the outdoor unit is easily transmitted. (When install the outdoor unit on the boundary with the neighbour, pay due attention to the level of noise.)
- Place with poor ventilation. (Before air duct installation, check whether value of air volume, static pressure and duct resistance are correct.)
- Do not use the air conditioner for special purposes such as preserving food, precision instruments, or art objects, or where breeding animals or growing plants are kept. (This may degrade the quality of preserved materials.)
- Place where any of high-frequency appliances (including inverter devices, private power generators, medical equipment, and communication equipment) and inverter-type fluorescent light is installed. (A malfunction of the air conditioner, abnormal control, or problems due to noise to such appliances/equipment may occur.)
- When the wireless remote controller is used in a room equipped with an inverter-type fluorescent light or at a place exposed to direct sunlight, signals from the remote controller may not be received correctly.
- Place where organic solvent is used.
- Place where special spray is used frequently.

## ■ Installation under high-humidity atmosphere

In some cases including the rainy season, especially inside of the ceiling may become high-humidity atmosphere (dew-point temperature: 23°C or higher).

1. Installation to inside of the ceiling with tiles on the roof
  2. Installation to inside of the ceiling with slated roof
  3. Installation to a place where inside of the ceiling is used for pathway to intake the fresh air
- In the above cases, additionally attach the heat insulator to all positions of the air conditioner, which come to contact with the high-humidity atmosphere. In this case, arrange the side plate (Check port) so that it is easily removed.
  - Apply also a sufficient heat insulation to the duct and connecting part of the duct.

<b>[Reference]</b>	Condensation test conditions
Indoor side:	27°C dry bulb temperature 24°C wet bulb temperature
Air volume:	Low air volume, operation time 4 hours

## ■ Installation space

(Unit: mm)

Reserve space required for maintenance the indoor unit and service work.

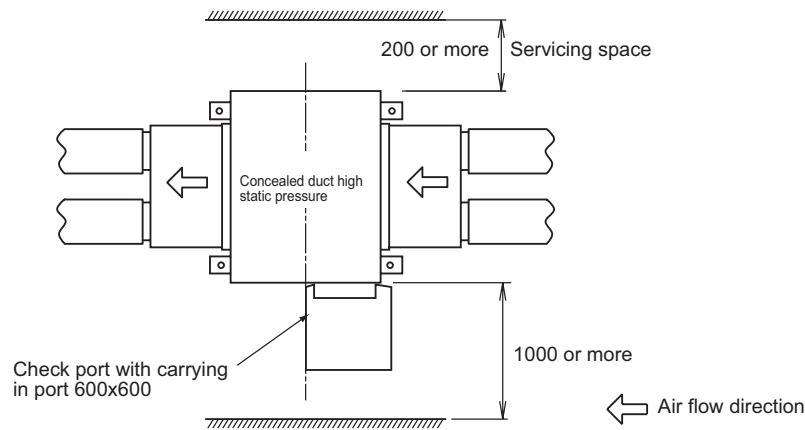

### <Installation example>

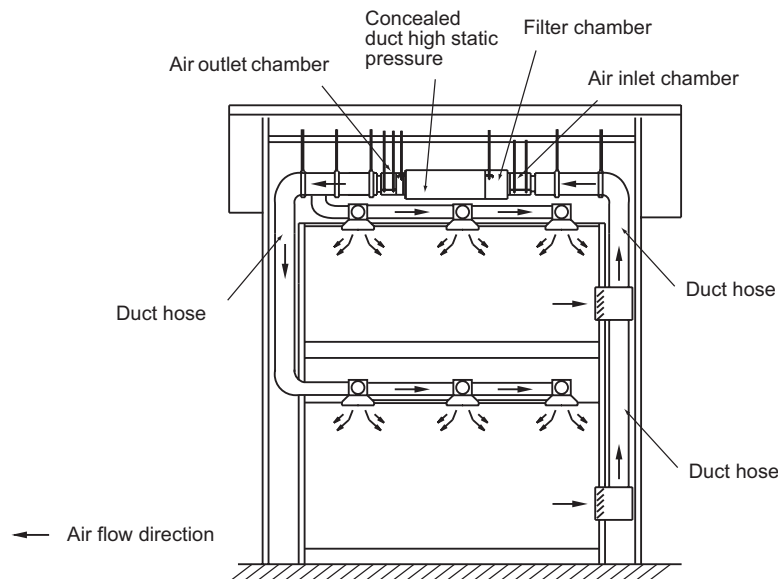

EN

### REQUIREMENT

1. Attach the optional accessories (drain-up kit etc.) on the unit before installing the unit. Also, set the check port with carrying in port to the side surface of the unit except air inlet panel.
2. Prepare the check port with carrying in port hole with the size of 600x600mm.

## ■ Filter cleaning sign term setting

The lighting term setup of the filter sign (Notification of filter cleaning) of the remote controller can be changed according to the condition of installation.

For setup method, refer to "Filter sign setting" and "To secure better effect of heating" in the Applicable controls of this Manual.

# 4 INSTALLATION

## ⚠ WARNING

- Install the air conditioner certainly to sufficiently withstand the weight.
- If the strength is insufficient, the unit may fall down resulting in human injury.
- Perform a specified installation work to guard against strong wind or earthquake.
- An incomplete installation can cause accidents by the units falling and dropping.

## REQUIREMENT

Strictly comply with the following rules to prevent damage of the indoor units and human injury.

- Do not put a heavy article on the indoor unit. (Even units are packaged)
- Carry in the indoor unit as it is packaged if possible. If carrying in the indoor unit unpacked by necessity, be sure to use buffering cloth, etc. to not damage the unit.
- To move the indoor unit, hold the hooking metals (4 positions) only.  
Do not apply force to the other parts (refrigerant pipe, drain pan, foamed parts, or resin parts, etc.).
- Hanging bolt pitch of air inlet chamber side is different (centre position), make sure not to make mistake to install the setting direction.
- Carry the package by two or more persons, and do not bundle it with plastic band at positions other than specified.

## External Dimensions

(Unit: mm)

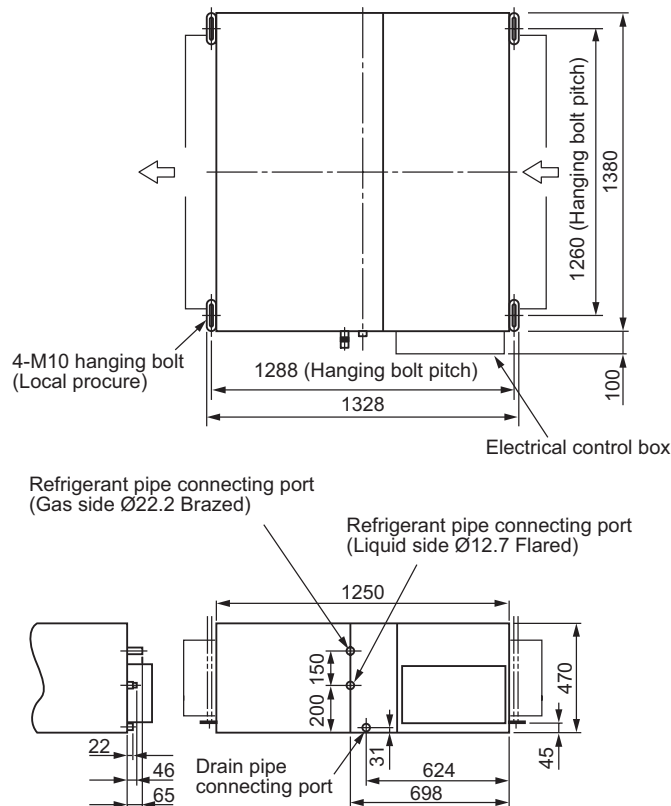

## ■ Installation of hanging bolt

- Consider the piping/wiring after the unit is hung when determining the location of the indoor unit installation and orientation.
- After the location of the indoor unit installation has been determined, install hanging bolts.
- For the dimensions of the hanging bolt pitches, refer to the external view.
- When a ceiling already exists, lay the drain pipe, refrigerant pipe, system interconnection wires, and remote controller wires to their connection locations before hanging the indoor unit.

Procure hanging bolts washer and nuts for installing the indoor unit (these are not supplied).

Hanging bolt	M10 or W3/8	4 pieces
Nut	M10 or W3/8	12 pieces
Washer	M10	8 pieces

### Installation of hanging bolt

Use M10 hanging bolts (4 pcs, to be local procure). Matching to the existing structure, set pitch according to size in the unit external view as shown below.

<b>New concrete slab</b>
Install the bolts with insert brackets or anchor bolts.
<p>(Blade type bracket)    (Slide type bracket)    Rubber Anchor bolt (Pipe hanging anchor bolt)</p>
<b>Steel flame structure</b>
Use existing angles or install new support angles.
<p>Hanging bolt    Hanging bolt    Support angle</p>
<b>Existing concrete slab</b>
Use a hole-in anchors, hole-in plugs, or a hole-in bolts.

## ■ Installation of indoor unit

### Treatment of ceiling

The ceiling differs according to structure of building. For details, consult your constructor or interior finish contractor.

In the process after the ceiling board has been removed, it is important to reinforce ceiling foundation (frame) and to keep horizontal level of installed ceiling correctly in order to prevent vibration of ceiling board.

- Attach the nuts and the M10 flat washers to the hanging bolt.
- Put washers at up and down of the hanging bracket of the indoor unit to hang down the indoor unit.
- Using a level vial, check that four sides are horizontal. (Horizontal degree: Within 5mm)

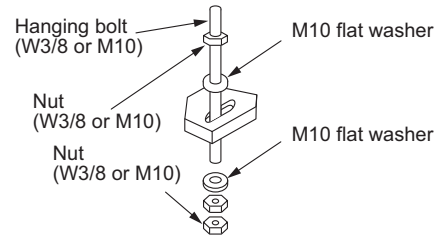

- Check that four sides are horizontal using a level vial. (Horizontal degree: Within 5mm)

### REQUIREMENT

- Hang the unit in a horizontal position. When unit is hanged to slant, it may cause overflow of drainage.
- Install the unit within the dimension according to the figure below.
- Using level vial or vinyl hose to confirm whether the unit is hang horizontally.

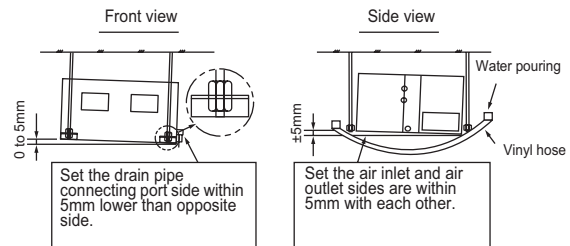

EN

## ■ Diagrams for making connecting flanges

(Unit: mm)

The connecting flange (Incl. the fixing screw) is not supplied to the indoor unit. When the connecting flange is necessary, produce them in locally.

Drawing figure is as follows. (Material: Galvanized steel plate, thickness of 1.6 mm)

### <Air outlet port flange>

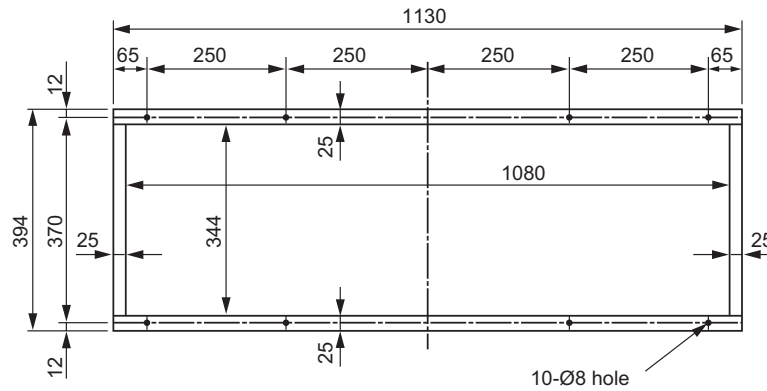

### <Air inlet port connecting flange>

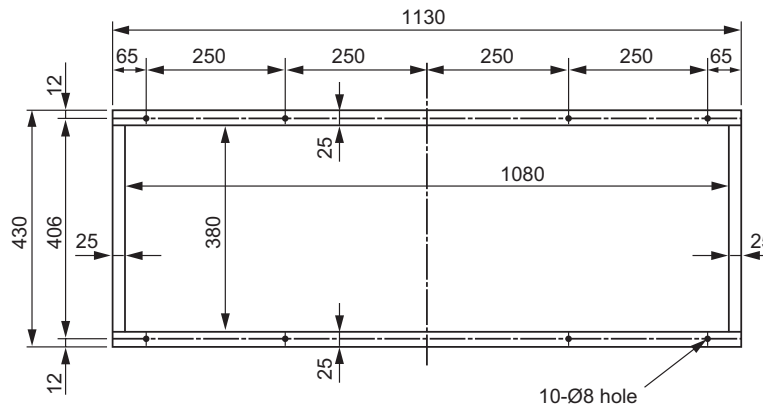

## ■ Duct design

1. In order to prevent short circuits, design the duct installation, so that the intake and discharge openings are not adjacent to each other.
2. The indoor unit does not have a built-in air filter. Make sure to set up the filter chamber etc. and install the air filter (Locally procured). If no air filter is installed, the heat exchanger will be blocked by dust, which may cause the malfunction of air conditioner or the water leakage.

### <Duct installation example (First floor)>

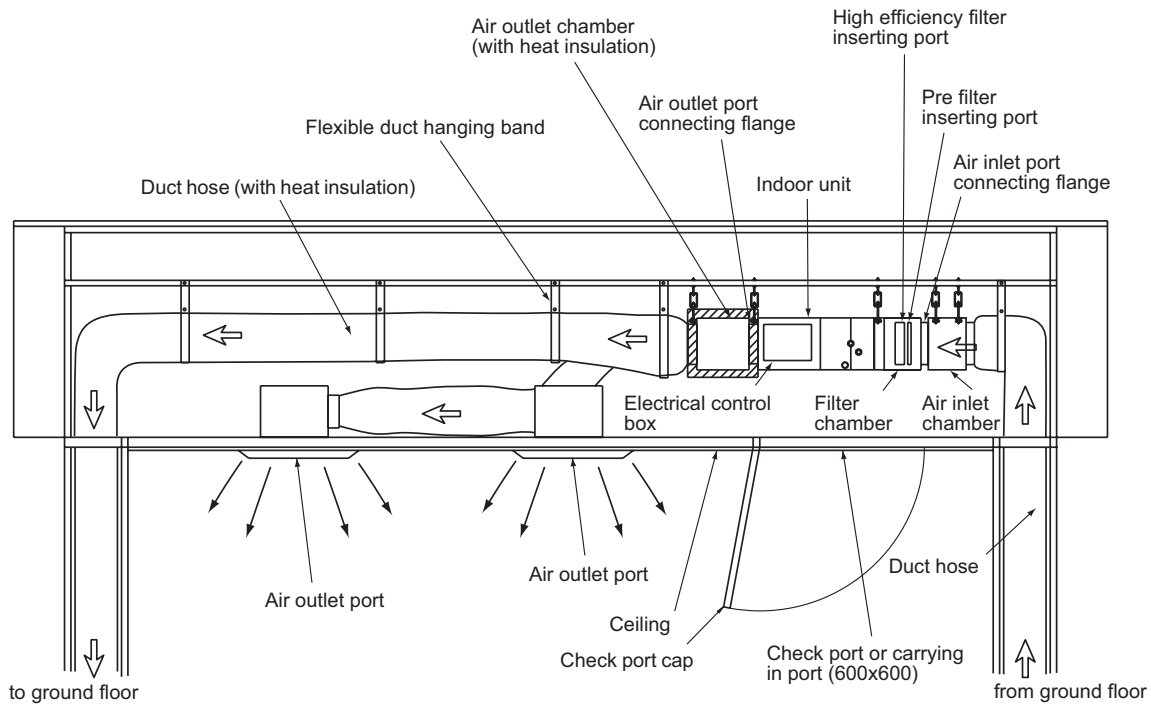

EN

### NOTE

All duct connection between units except outdoor unit must be procured and enforced locally.

# 5 FAN CHARACTERISTICS

Current value as a criterion, adjust the air volume value to become within the range of the chart below.

<RAV-SM2242 Type>

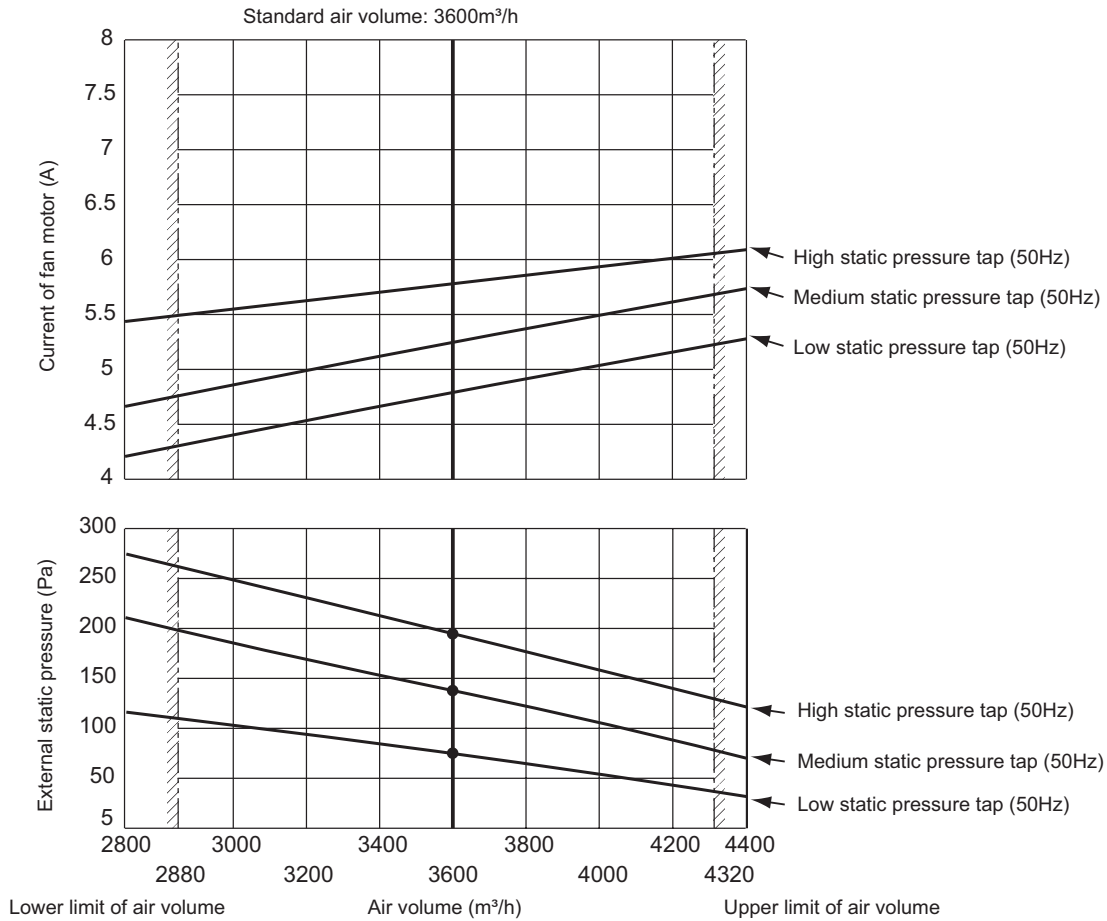



<RAV-SM2802 Type>

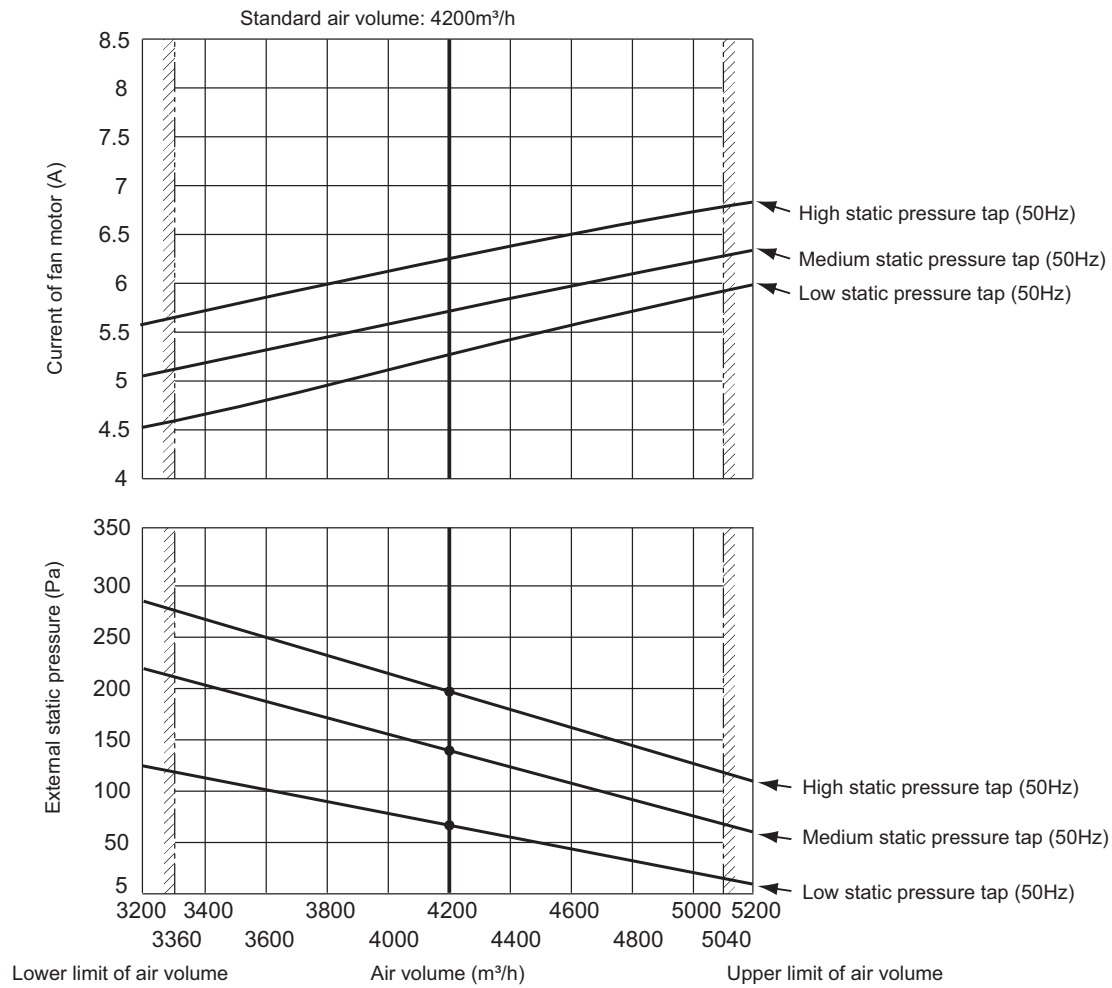

**REQUIREMENT**

Add a air volume damper to the air supply duct, and adjust the air volume in the range from 80% to 120% of the standard air volume.

## ■ Wire connection change of fan motor

This duct is composed of 3 fan motors.

To change external static pressure by duct resistance, connect the 3 connectors of the orange lead wires that are connected to the underside of the fan tap changing terminal block to the same number (F1, F2 or F3) terminal.

The wires of the fan motor has been connected to (F2) [External static pressure 137Pa (14mmAq)] as factory default.

### Low static pressure (F1)

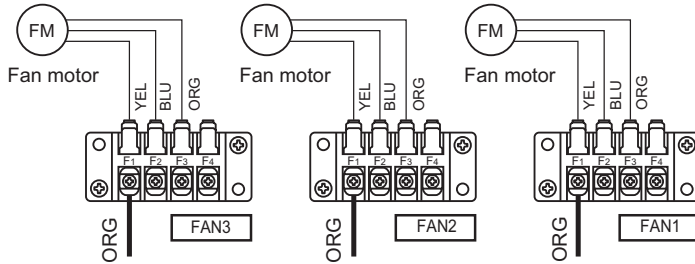

YEL: Yellow  
BLU: Blue  
ORG: Orange

### Standard (Middle) static pressure (F2)

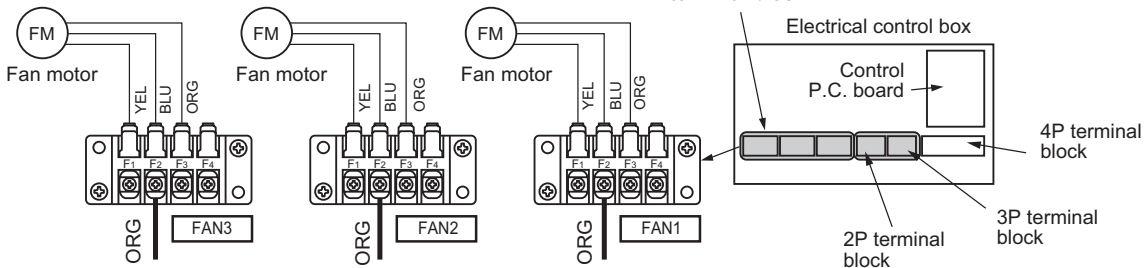

### High static pressure (F3)

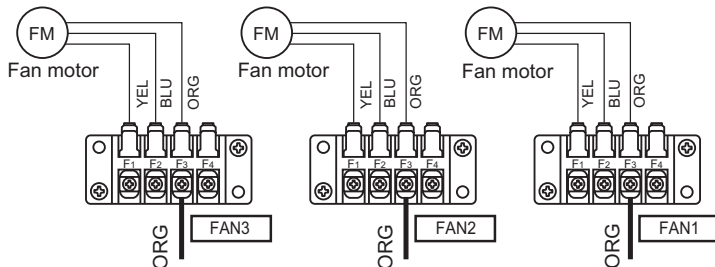

Terminal block No.	Fan motor wiring	External static pressure Pa (mmAq)	Remarks
F1	Yellow Low static pressure	69 (7)	
F2	Blue Middle static pressure	137 (14)	Factory default
F3	Orange High static pressure	196 (20)	

\* Do not use F4.

### NOTE

When the external static pressure is changed, write down the static pressure once change in the wiring diagram of the indoor unit is made.

# 6 DRAIN PIPING WORK

## ⚠ CAUTION

Following the Installation Manual, perform the drain piping work that water is properly drained, and apply a heat insulation not to cause a dew condensation. Inappropriate piping work may cause the water leakage in the room and wet of furniture.

### REQUIREMENT

- The drain piping flows the natural drainage. Make sure to set the drain piping from the unit with descending slope of 1/50 to 1/100 and do not make up-down or trap in the midway.
- Set the horizontal pulling of the drain pipe to 20m or less. When drain piping is too long, attach the support bracket at intervals of 1.5m to 2m to avoid the pipe becomes undulant as shown in figure below.

#### <Example for installation of the main piping (Incl. piping support)>

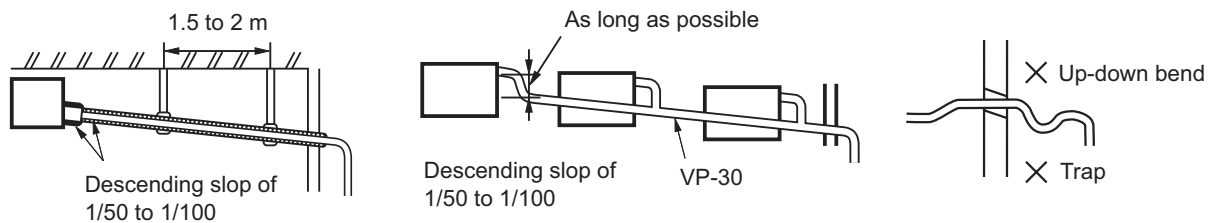

- Be sure to connect the drain pipe to the air conditioner with adhesive to avoid water leakage from the joint portion.
- Condensation may occur on the drain pipes including collective pipes. All drain pipes must be wrapped with heat insulator to prevent dew condensation. Especially a part where drain pipe is connected to the indoor unit must be firmly insulated with the provided heat insulator.

EN

## ■ Pipe material, size and insulator

The following materials for piping work and insulating process are procured locally.

Pipe material	Hard vinyl chloride pipe socket for VP25
	Hard vinyl chloride pipe VP25 (Nominal outer diameter Ø32mm)
Insulator	Foamed polyethylene foam, thickness: 10mm or more

## ■ Connecting drain pipe

### REQUIREMENT

- Using adhesive agent for vinyl chloride, connect the hard vinyl chloride pipes certainly so that water does not leak.
- It takes some time to dry and indurate the adhesive agent. (Refer to the manual of adhesive agent.) Do not apply any extra force on the connecting section until the adhesive agent dried.

## ■ Drain up

- When install the drain up kit of optional accessory, read the Installation Manual supplied to a drain up kit.

## ■ Check the draining

Check if the water can flow out properly during the test run. Also, check if no water leakage from the piping connection port.

### REQUIREMENT

- Do drain test even if installation of heating season.
- Pour water into the drain pan port of the air inlet port gently using the kettle or hose when duct is not connected to the drain pipe. When duct is connected to the drain pipe, remove the Access plate and perform it.

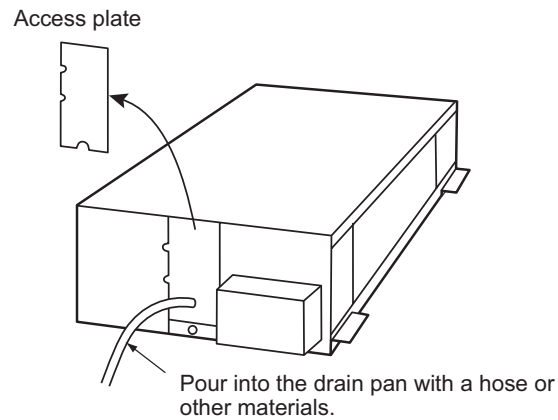
**EN**

## ■ Heat insulating process

- After drain check, covering the heat insulator for drain connecting section, wrap the drain pipe with heat insulator (Locally procured) without clearance from the end of the drain pipe connecting port of the indoor unit.

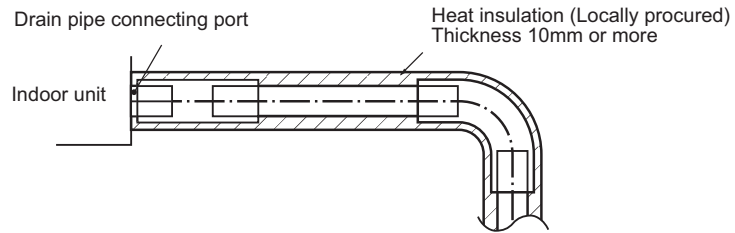

# 7 REFRIGERANT PIPING AND EVACUATING

## ■ Refrigerant Piping

1. If the outdoor units are to be mounted on a wall, make sure that the supporting platform is sufficiently strong. The platform should be designed and manufactured to maintain its strength over a long period of time, and sufficient consideration should be given to ensuring that the outdoor unit will not fall.
2. **Use general copper pipes with a wall thickness of 0.8 mm for Ø12.7 mm, and with a wall thickness of 1.0 mm for Ø28.6 mm (half hard). Do not use any copper pipes with a wall thickness less than these thicknesses.**
3. Flare nut and flare works are also different from those of the conventional refrigerant. Take out the flare nut attached to the main unit of the air conditioner, and use it.

### REQUIREMENT

When the refrigerant pipe is long, provide support brackets at intervals of 2.5 to 3m to clamp the refrigerant pipe. Otherwise, abnormal sound may be generated.

### ⚠ CAUTION

#### IMPORTANT 4 POINTS FOR PIPING WORK

1. Remove dust and moisture from the inside of the connecting pipes.
2. Tight connection (between pipes and unit)
3. Evacuate the air in the connecting pipes using VACUUM PUMP.
4. Check the gas leakage. (Connected points)

## ■ Pipe size

Pipe size	Gas side	28.6 mm
	Liquid side	12.7 mm

## ■ Liquid side refrigerant pipe connection

### Permissible Piping Length and Height Difference

They vary according to the outdoor unit. For details, refer to the Installation Manual attached to the outdoor unit.

## Flaring

- Cut the pipe with a pipe cutter. Remove burrs completely. Remaining burrs may cause gas leakage.
- Insert a flare nut into the pipe, and flare the pipe. As the flaring sizes of R410A differ from those of refrigerant R22, the flare tools newly manufactured for R410A are recommended.

However, the conventional tools can be used by adjusting projection margin of the copper pipe.

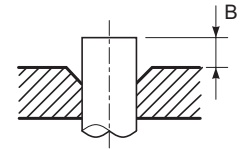

### ▼ Projection margin in flaring: B (Unit: mm)

Rigid (Clutch type)

Outer dia. of copper pipe	R410A tool used	Conventional tool used
	R410A	R410A
12.7	0 to 0.5	1.5 to 2.0

### ▼ Flaring dia. meter size: A (Unit: mm)

Outer dia. of copper pipe	A <sup>+0</sup> / <sub>-0.02"</sub> (-0.4)
	R410A
12.7	16.6

- \* In case of flaring for R410A with the conventional flare tool, pull it out approx. 0.5 mm more than that for R22 to adjust to the specified flare size. The copper pipe gauge is useful for adjusting projection margin size.

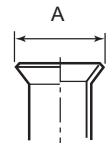

EN

**Tightening connection**



**Do not apply excessive torque. Otherwise, the nut may crack depending on the conditions.**

(Unit: N•m)

Outer dia. of copper pipe	Tightening torque
12.7 mm (dia.)	50 to 62 (5.0 to 6.2 kgf•m)

**▼ Tightening torque of flare pipe connections**

Pressure of R410A is higher than that of R22. (Approx. 1.6 times) Therefore, using a torque wrench, tighten the flare pipe connecting sections which connect the indoor and outdoor units of the specified tightening torque. Incorrect connections may cause not only a gas leak, but also a trouble of the refrigeration cycle. Align the centres of the connecting pipes and tighten the flare nut as far as possible with your fingers. Then tighten the nut with a spanner and torque wrench as shown in the figure.

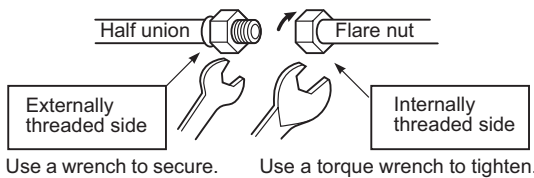

**REQUIREMENT**

Tightening with an excessive torque may crack the nut depending on installation conditions. Tighten the nut within the specified tightening torque.

**■ Gas side refrigerant pipe connection**

- Turn up the pipe heat insulator to the unit side.
- Wrap the pipe with wet cloth.

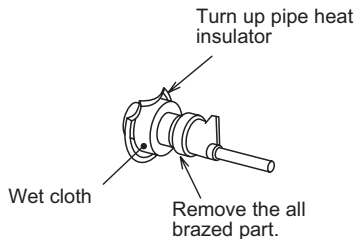

- Remove the cap on the gas side piping by using a brazing machine.



**Do not burn the pipe heat insulator.**

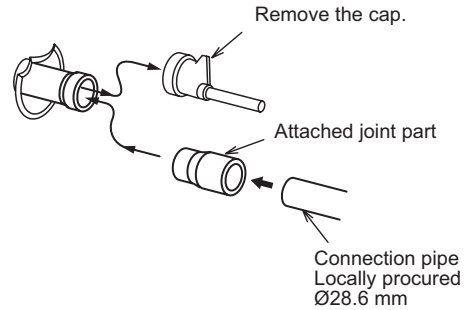

- Braze the attached joint part to the gas side piping and braze the connection piping to the joint part.

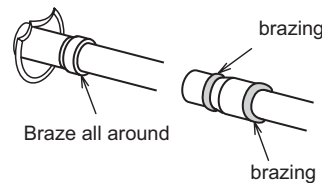

- Turn back the pipe heat insulator and tie up with a banding band.

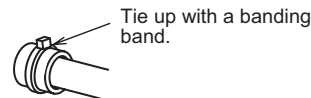

**Piping with outdoor unit**

- For details of installation, refer to the Installation Manual of the outdoor unit.

**■ Evacuation**

Using a vacuum pump, perform vacuuming from the charge port of valve of the outdoor unit. For details, follow to the Installation Manual attached to the outdoor unit.

- Never use the refrigerant sealed in the outdoor unit for evacuation.

**REQUIREMENT**

For the tools such as charge hose, etc., use those manufactured exclusively for R410A.



### **Refrigerant amount to be added**

For addition of the refrigerant, add refrigerant "R410A" referring to the attached Installation Manual of outdoor unit. Be sure to use a scale to charge the refrigerant of specified amount.

#### **REQUIREMENT**

- Charging an excessive or too little amount of refrigerant causes a trouble of the compressor.  
Be sure to charge the refrigerant of specified amount.
- A personnel who charged the refrigerant should write down the pipe length and the added refrigerant amount in the nameplate attached to the service panel of the outdoor unit. It is necessary to fix the compressor and refrigeration cycle malfunction.

### **Open the valve fully**

Open the valve of the outdoor unit fully. A 4mm-hexagonal wrench is required for opening the valve. For details, refer to the Installation Manual attached to the outdoor unit.

### **Gas leak check**

Check with a leak detector or soap water whether gas leaks or not, from the pipe connecting section or cap of the valve.

#### **REQUIREMENT**

Use a leak detector manufactured exclusively for HFC refrigerant (R410A, R134a, etc.).

### **Heat insulation process**

Apply heat insulation for the pipes separately at liquid side and gas side.

For the heat insulation to the pipes at gas side, be sure to use the material with heat-resisting temperature 120°C or higher. Using the attached heat insulation material, apply the heat insulation to the pipe connecting section of the indoor unit securely without gap.

#### **REQUIREMENT**

- Apply the heat insulation to the pipe connecting section of the indoor unit securely up to the root without exposure of the pipe. (The pipe exposed to the outside causes water leak.)
- Wrap heat insulator with its slits facing up (ceiling side).

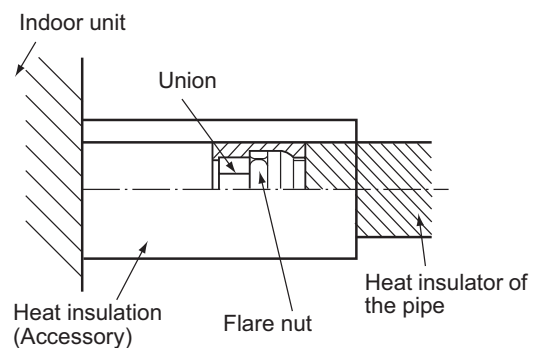

**EN**

# 8 ELECTRICAL CONNECTION

## WARNING

- Using the specified wires, ensure to connect the wires, and fix wires securely so that the external tension to the wires do not affect the connecting part of the terminals.**  
Incomplete connection or fixation may cause a fire, etc.
- Be sure to connect earth wire. (grounding work)**  
Incomplete grounding cause an electric shock. Do not connect ground wires to gas pipes, water pipes, lightning rods or ground wires for telephone wires.
- Appliance shall be installed in accordance with national wiring regulations.**  
Capacity shortage of power circuit or incomplete installation may cause an electric shock or a fire.

## CAUTION

- If incorrect/incomplete wiring is carried out, it will cause an electrical fire or smoke.
- Be sure to install an earth leakage breaker that is not tripped by shock waves.  
If an earth leakage breaker is not installed, an electric shock may be caused.
- Be sure to use the cord clamps attached to the product.
- Do not damage or scratch the conductive core and inner insulator of power and inter-connecting wires when peeling them.
- Use the power cord and Inter-connecting wire of specified thickness, type, and protective devices required.

## REQUIREMENT

- For power supply wiring, strictly conform to the Local Regulation in each country.
- Power supply for indoor unit must be exclusive and separated from the one for outdoor unit.**
- For wiring of power supply of the outdoor units, follow the Installation Manual of each outdoor unit.
- Never connect 220–240V power to the terminal blocks (A, B, etc.) for control wiring. (Otherwise, the system will fail.)
- Perform the electric wiring so that it does not come to contact with the high-temperature part of the pipe. The coating may melt resulting in an accident.
- After connecting wires to the terminal blocks, provide a trap and fix wires with the cord clamp.
- Run the refrigerant piping line and control wiring line in the same line.
- Do not turn on the power of the indoor unit until vacuuming of the refrigerant pipes completes.

## Remote controller wiring

2-core non polarity wire is used for the remote controller wiring.

## Wiring

- Figure below shows the wiring connections indoor power line and between the indoor and outdoor units and between the indoor units and remote controller. The wires indicated by the dash lines are provided at the installation place.
- Insulate the unsheathed redundant cords (conductors) with electrical insulation tape. Process them so that they do not touch any electrical or metal parts.

## Wiring diagram

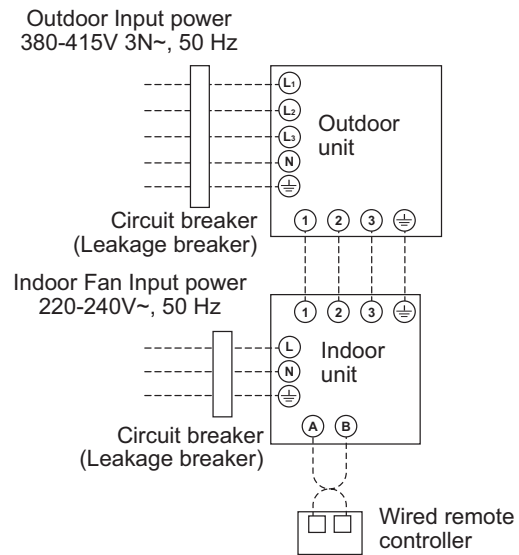

## Power and Wiring Specification

Indoor fan Power supply	220-240V~, 50 Hz
Maximum running current	15A
Fuse rating	25A
Indoor fan power supply wire*	3 x 2.5mm <sup>2</sup> or more (H07 RN-F or 60245 IEC 66)
System interconnecting wires*	4 x 1.5mm <sup>2</sup> or more (H07 RN-F or 60245 IEC 66)

\*Number of wire x wire size

## ■ Wire connection

### REQUIREMENT

- Be sure to connect the wires matching the terminal numbers. Incorrect connection causes a trouble.
- Be sure to pass the wires through the bushing of wire connection holes of the indoor unit.
- Keep a margin (Approx. 100mm) on a wire to hang down the electrical control box at servicing, etc.
- The low-voltage circuit is provided for the remote controller. (Do not connect the high-voltage circuit)

1. Remove the cover of the electrical control box by taking off the mounting screws (2 positions)
2. Tighten the screws of the terminal block, and fix the wires with cord attached to the electrical control box.  
(Do not apply tension to the connecting section of the terminal block.)
3. Mount the cover of the electrical control box without pinching wires.

#### <Terminal block of electrical control box>

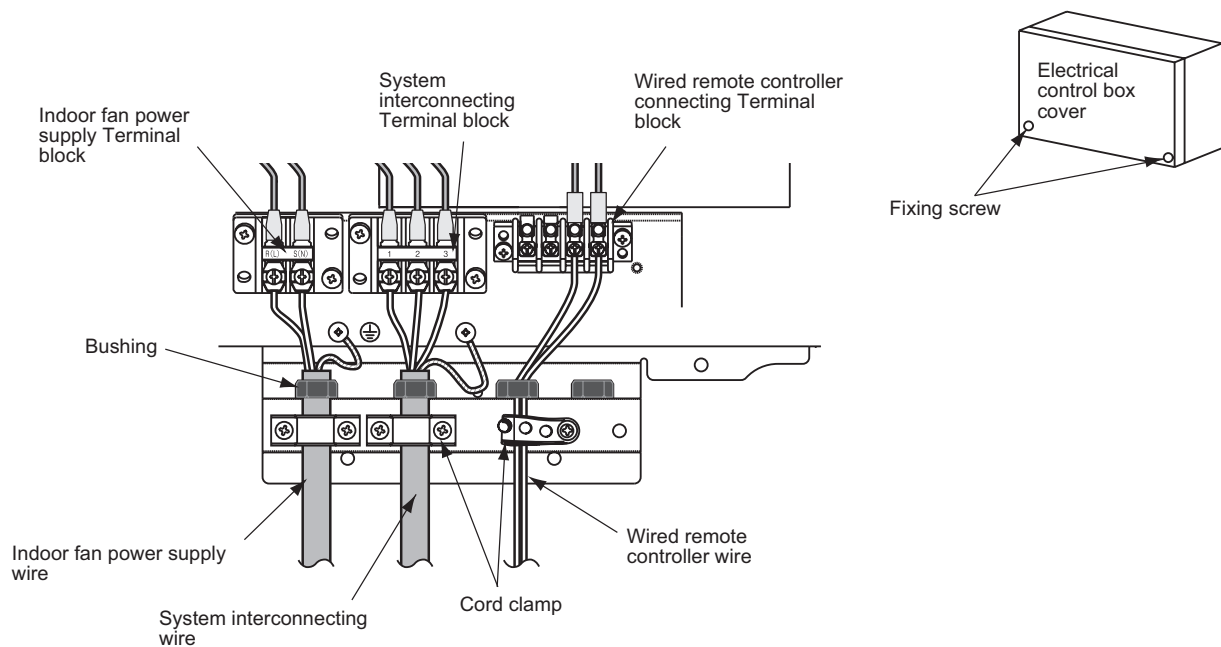

EN

(Unit: mm)

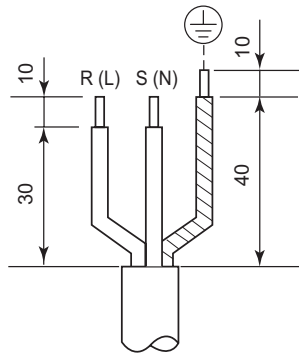

Indoor fan power supply wire

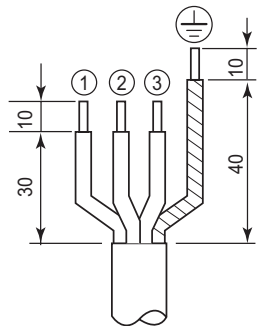

System interconnecting wire

**Group control**

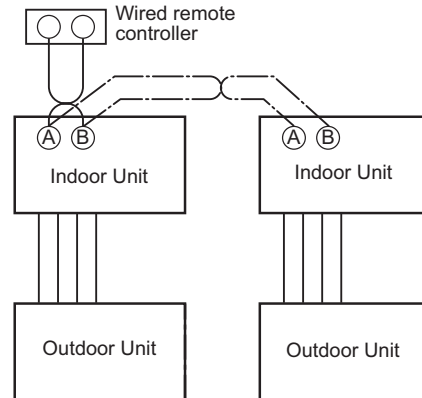

**Remote Controller Wiring**

- Strip off approx. 9mm the wire to be connected.
- Non polarity, 2 core wire is used for wiring of the remote controller. (0.5mm<sup>2</sup> to 2.0mm<sup>2</sup> wires)

**Wiring diagram**

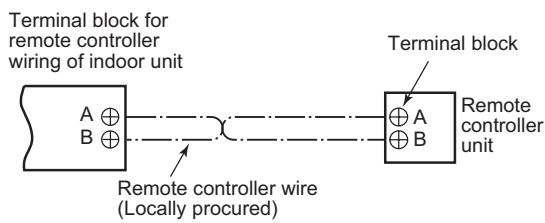

# 9 APPLICABLE CONTROLS

## REQUIREMENT

- When you use this air conditioner for the first time, it takes approx. 5 minutes until the remote controller becomes available after power-on. This is normal.  
**<When power is turned on for the first time after installation>**  
 It takes **approx. 5 minutes** until the remote controller becomes available.

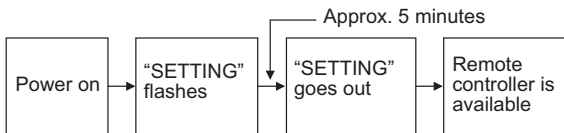

### <When power is turned on for the second (or later) time>

It takes **approx. 1 minute** until the remote controller becomes available.

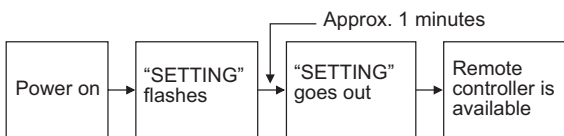

- Normal settings were made when the indoor unit was shipped from factory. Change the indoor unit settings as required.
- Use the wired remote controller to change the settings.
  - \* The settings cannot be changed using the wireless remote controller, sub remote controller, or remote-controller-less system (for central remote controller only). Therefore, install the wired remote controller to change the settings.

## ■ Changing of setting applicable control

### Basic procedure for changing settings

Change the settings while the air conditioner is not working. (Be sure to stop the air conditioner before making settings.)

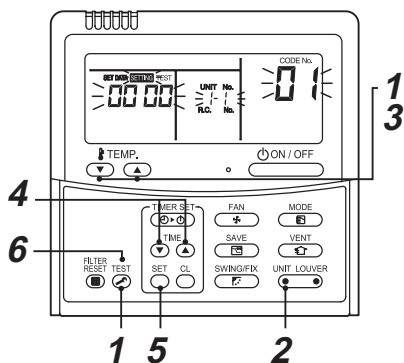

### Procedure 1

Push **TEST** button and **TEMP.** button simultaneously for at least 4 seconds.

After a while, the display flashes as shown in the figure. Confirm that the CODE No. is [01].

- If the CODE No. is not [01], push **TEST** button to erase the display content, and repeat the procedure from the beginning.  
 (No operation of the remote controller is accepted for a while after **TEST** button is pushed.)

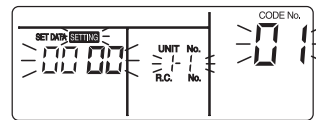

(\* Display content varies with the indoor unit model.)

### Procedure 2

Each time you push **UNIT LOUVER** button, indoor unit numbers in the control group change cyclically. Select the indoor unit you want to change settings for.

The fan of the selected unit runs. You can confirm the indoor unit for which you want to change settings.

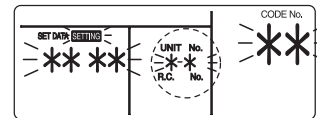

### Procedure 3

Using **TEMP.** / **UNIT LOUVER** buttons, specify CODE No. [\*\*].

### Procedure 4

Using **TIME** / **UNIT LOUVER** buttons, select SET DATA [\*\*\*\*].



### Procedure 5

Push **SET** button. When the display changes from flashing to lit, the setup is completed.

- To change settings of another indoor unit, repeat from Procedure 2.
- To change other settings of the selected indoor unit, repeat from Procedure 3.  
 Use **SET** button to clear the settings.  
 To make settings after **SET** button was pushed, repeat from Procedure 2.

EN

**Procedure 6**

When settings have been completed, push  button to determine the settings.  
 When  button is pushed, "SETTING" flashes and then the display content disappears and the air conditioner enters the normal stop mode.  
 (While "SETTING" is flashing, no operation of the remote controller is accepted.)

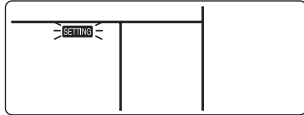

**Filter sign setting**

According to the installation condition, the filter sign term (Notification of filter cleaning) can be changed.  
 Follow to the basic operation procedure (1 → 2 → 3 → 4 → 5 → 6).  
 • For the CODE No. in Procedure 3, specify [01].  
 • For the [SET DATA] in Procedure 4, select the SET DATA of filter sign term from the following table.



SET DATA	Filter sign term
0000	None
0001	150H
0002	2500H (Factory default)
0003	5000H
0004	10000H

**To secure better effect of heating**



When it is difficult to obtain satisfactory heating due to installation place of the indoor unit or structure of the room, the detection temperature of heating can be raised. Also use a circulator, etc. to circulate heat air near the ceiling.  
 Follow to the basic operation procedure (1 → 2 → 3 → 4 → 5 → 6).  
 • For the CODE No. in Procedure 3, specify [06].  
 • For the set data in Procedure 4, select the SET DATA of shift value of detection temperature to be set up from the table below.

SET DATA	Detection temperature shift value
0000	No shift
0001	+1°C
0002	+2°C (Factory default)
0003	+3°C
0004	+4°C
0005	+5°C
0006	+6°C

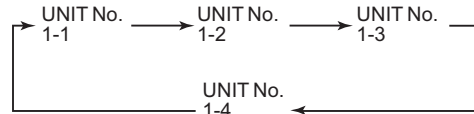

**Power saving mode**

1. Push  button for at least four seconds when the air conditioner is not working.  
 flashes.  
 Indicates CODE No. "C2."
2. Select an indoor unit to be set by pushing  (left side of the button).  
 Each time you push the button, unit numbers change as follows:

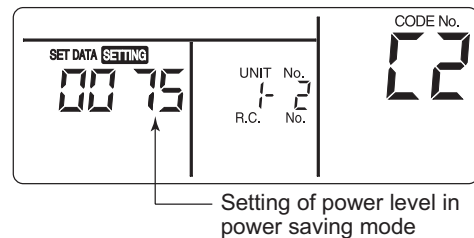

- The fan of the selected unit runs.
3. Adjust the power save setting by pushing TIME   buttons.  
 Each push of the button changes the power level by 1% within the range from 100% to 50%.  
 \* The factory default is 75%.



4. Determine the setting by pushing  button.
5. Push  button to complete the setting.

## Remote controller switch monitoring function

This function is available to call the service monitor mode from the remote controller during a test run to acquire temperatures of sensors of the remote controller, indoor unit, and outdoor unit.

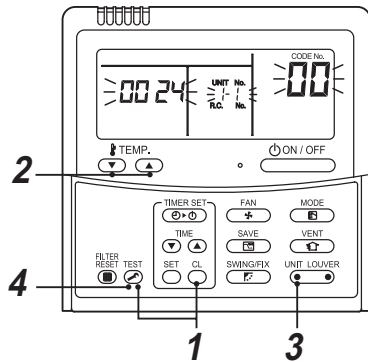

1. Push **CL** and **TEST** buttons simultaneously for at least 4 seconds to call the service monitor mode. The service monitor indicator lights up and the header indoor unit number is displayed first. CODE No. **00** is also displayed.
2. Pushing **TEMP.** buttons, select the number of sensor, etc. (CODE No.) to be monitored. (See the following table.)
3. Pushing **UNIT LOUVER** (left side of the button), select an indoor unit to be monitored. The sensor temperatures of indoor units and their outdoor unit in the control group are displayed.
4. Push **TEST** button to return to the normal display.

Outdoor unit data	
CODE No.	Data name
60	Outdoor unit heat exchanger (coil) temperature (TE)
61	Outside air temperature (TO)
62	Compressor discharge temperature (TD)
63	Compressor suction temperature (TS)
64	—
65	Heatsink temperature (THS)
6A	Operating current (x1/10)
F1	Compressor cumulative operating hours (x100h)

Indoor unit data	
CODE No.	Data name
01	Room temperature (remote controller)
02	Indoor unit intake air temperature (TA)
03	Indoor unit heat exchanger (coil) temperature (TCJ)
04	Indoor unit heat exchanger (coil) temperature (TC)
F3	Indoor unit fan cumulative operating hours (x1 h)



## ■ Group control

### Group control for system of multiple units

One remote controller can control up to 8 indoor units as a group.

#### ▼ Group control in single system

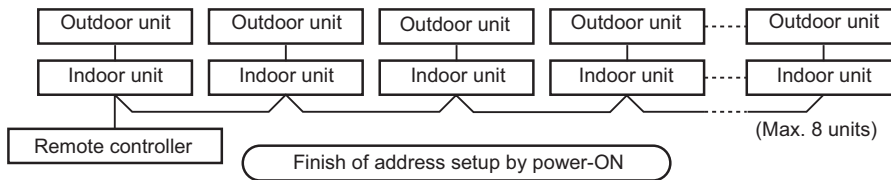

- For wiring procedure and wiring method of the individual line (Identical refrigerant line) system, refer to “ELECTRICAL CONNECTION”.
- Wiring between lines is performed in the following procedure.  
Connect the terminal block (A/B) of the indoor unit connected with a remote controller to the terminal blocks (A/B) of the indoor units of other indoor units by wiring the inter-unit wire of the remote controller.
- When the power supply has been turned on, the automatic address setup starts and which indicates that address is being set up flashes on the display part. During setup of automatic address, the remote controller operation is not accepted.

**Required time up to the finish of automatic addressing is approx. 5 minutes.**

#### NOTE

In some cases, it is necessary to change the address manually after setup of the automatic address according to the system configuration of the group control.



**Procedure example 1**

**Manual address setup procedure**

While the operation stops, change the setup.  
(Be sure to stop the operation of the unit.)

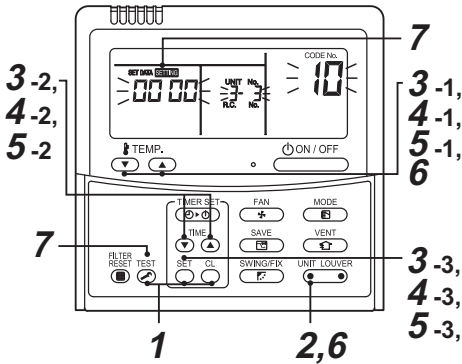

**Procedure 1**

Push simultaneously **SET** + **CL** + **TEST** buttons for 4 seconds or more. After a while, the display part flashes as shown below. Check the displayed CODE No. is [10].

- When the CODE No. is other than [10], push **TEST** button to erase the display and repeat procedure from the first step. (After pushing **TEST** button, operation of the remote controller is not accepted for approx. 1 minute.) (For a group control, No. of the firstly displayed indoor unit becomes the header unit.)

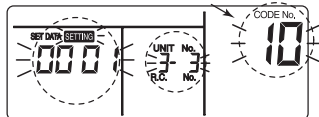

(\* Display changes according to the model No. of indoor unit.)

**Procedure 2**

Every pushing **UNIT LOUVER** button, the indoor UNIT No. in the group control is displayed in order. Select the indoor unit of which setup is changed.

In this time, the position of the indoor unit of which setup is changed can be confirmed because fan of the selected indoor unit operate.

**Procedure 3**

- Using **TEMP.** (▼) / (▲) buttons, specify CODE No. [12]. (CODE No. [12]: Line address)
- Using **TIME** (▼) / (▲) buttons, change the line address from [3] to [2].

- Push **SET** button.

In this time, the setup finishes when the display changes from flashing to lighting.

Indoor unit No. before setup change is displayed.

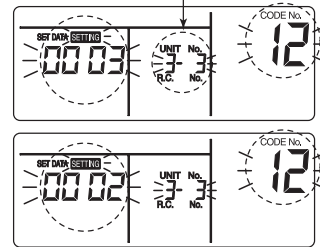

**Procedure 4**

- Using **TEMP.** (▼) / (▲) buttons, specify CODE No. [13]. (CODE No. [13]: Indoor address)
- Using **TIME** (▼) / (▲) buttons, change the indoor address from [3] to [2].
- Push **SET** button.

In this time, the setup finishes when the display changes from flashing to lighting.

Indoor unit No. before setup change is displayed.

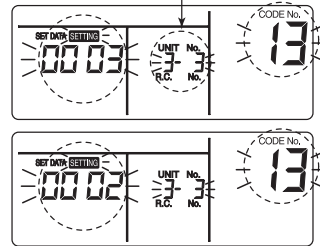

**Procedure 5**

- Using **TEMP.** (▼) / (▲) buttons, specify CODE No. [14]. (CODE No. [14]: Group address)
- Using **TIME** (▼) / (▲) buttons, change the SET DATA from [0001] to [0002]. (SET DATA [Header unit: 0001] [Follower unit: 0002])
- Push **SET** button.

In this time, the setup finishes when the display changes from flashing to lighting.

Indoor UNIT No. before setup change is displayed.

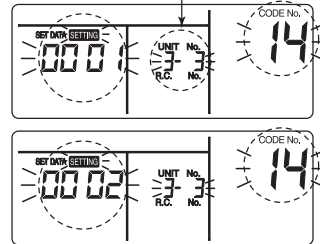

**Procedure 6**

If there is other indoor unit to be changed, repeat procedure **2** to **5** to change the setup.

When the above setup has finished, push **UNIT LOUVER** to select the indoor UNIT No. before change of setup, specify CODE No. [12], [13], [14] in order with TEMP. (▼) / (▲) buttons, and then check the changed contents.

Address change check Before change: [3-3-1] → After change: [2-2-2]

Pushing **CL** button clears the contents of which setup was changed.

(In this case, procedure from **2** is repeated.)

Indoor UNIT No. before setup change is displayed.

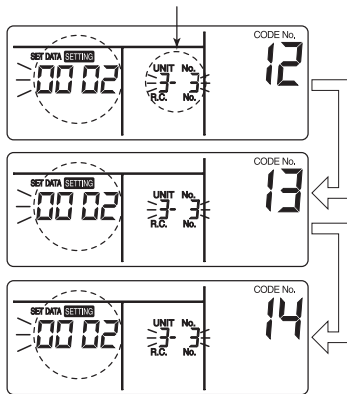

**Procedure 7**

After check of the changed contents, push **TEST** button. (Setup is determined.) When pushing **TEST** button, the display disappears and the status becomes the usual stop status. (When pushing **TEST** button the operation from the remote controller is not accepted for approx. 1 minute.)

\* If the operation from the remote controller is not accepted even 1 minute or more passed after pushing **TEST** button, it is considered that the address setup is incorrect. In this case, the automatic address must be again set up. Therefore repeat procedure of the setup change from the Procedure **1**.

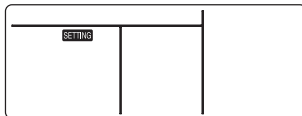

**To recognize the position of the corresponding indoor unit though the indoor UNIT No. is known**

Check the position during operation stop. (Be sure to stop operation of the set.)

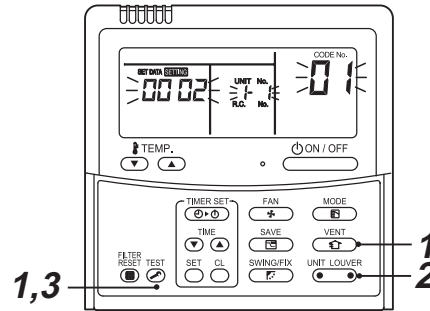

**Procedure 1**

Push simultaneously **TEST** + **UNIT LOUVER** buttons for 4 seconds or more.

After a while, the display part flashes and the display appears as shown below.

In this time, the position can be checked because fan of the indoor unit operate.

- For the group control, the indoor UNIT No. is displayed as [ALL] and fans of all the indoor units in the group control operate. Check the displayed CODE No. is [01].
- When the CODE No. is other than [01], push **TEST** button to erase the display and repeat procedure from the first step. (After pushing **TEST** button, operation of the remote controller is not accepted for approx. 1 minute.)

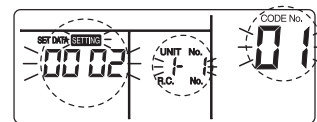

(\* Display changes according to the model No. of indoor unit.)

**Procedure 2**

In the group control, every pushing **UNIT LOUVER** button, the indoor UNIT No. in the group control is displayed in order. In this time, the position of the indoor unit can be confirmed because only fan of the selected indoor unit operate. (For a group control, No. of the firstly displayed indoor unit becomes the header unit.)

**Procedure 3**

After confirmation, push **TEST** button to return the mode to the usual mode.

When pushing **TEST** button, the display disappears and the status becomes the usual stop status.

(When pushing **TEST** button the operation from the remote controller is not accepted for approx. 1 minute.)

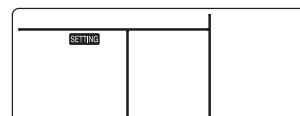

## ■ 8°C Operation

Pre-heating operation can be set for cold regions where room temperature drops to below zero.

### Procedure 1

Push simultaneously **SET** + **CL** + **TEST** buttons for 4 seconds or more when the air conditioner is not working.

After a while, the display part flashes as shown below. Check the Displayed CODE No. is [10].

- When the CODE No. is other than [10], push **TEST** button to erase the display and repeat procedure from the first step. (After pushing **TEST** button, operation of the remote controller is not accepted for approx. 1 minute.)

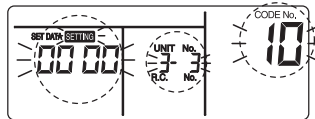

(\* Display changes according to the model No. of indoor unit.)

### Procedure 2

Every pushing **UNIT LOUVER** button, the indoor unit No. in the group control is displayed in order. Select the indoor unit of which setup is changed. In this time, the position of the indoor unit of which setup is changed can be confirmed because fan of the selected indoor unit operate.

### Procedure 3

Using **TEMP.** (down/up) buttons, specify CODE No. [d1].

### Procedure 4

Using **TIME** (down/up) buttons, select SET DATA [0001].

SET DATA	8°C Operation setting
0000	None (Factory default)
0001	8°C Operation setting

### Procedure 5

Push **SET** button.

In this time, the setup finishes when the display changes from flashing to lighting.

### Procedure 6

Push **TEST** button. (Setup is determined.)

When pushing **TEST** button, the display disappears and the status

Becomes the usual stop status. (When pushing **TEST** button the operation from the remote controller is not accepted for approx. 1 minute.)

EN

# 10 TEST RUN

## ■ Before test run

- Before turning on the power supply, carry out the following procedure.
  - 1) Using 500V-megger, check that resistance of 1MΩ or more exists between the terminal block 1 to 3 and the earth (grounding).  
If resistance of less than 1MΩ is detected, do not run the unit.
  - 2) Check the valve of the outdoor unit being opened fully.
- To protect the compressor at activation time, leave power-ON for 12 hours or more before operating.

## ■ Execute a test run

Using the wired remote controller, operate the unit as usual. For the procedure of the operation, refer to the attached Owner's Manual.

A forced test run can be executed in the following procedure even if the operation stops by thermostat-OFF.

In order to prevent a serial operation, the forced test run is released after 60 minutes have passed and returns to the usual operation.

### ⚠ CAUTION

- Do not use the forced test run for cases other than the test run because it applies an excessive load to the devices.

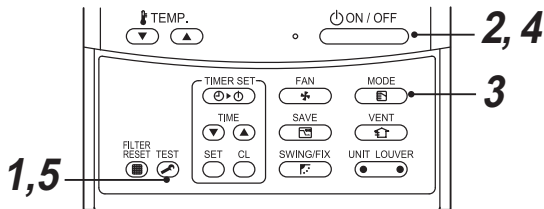

### Procedure 1

Keep **TEST** button pushed for 4 seconds or more. [TEST] is displayed on the display part and the selection of mode in the test mode is permitted.

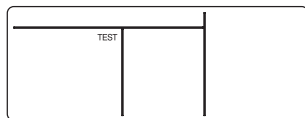

### Procedure 2

Push **ON / OFF** button.

### Procedure 3

Using **MODE** button, select the operation mode, [Cool] or [Heat].

- Do not run the air conditioner in a mode other than [Cool] or [Heat].
- The temperature controlling function does not work during test run.
- The detection of error is performed as usual.

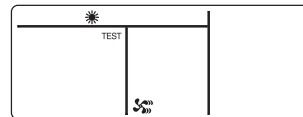

### Procedure 4

After the test run, push **ON / OFF** button to stop a test run. (Display part is same as procedure 1.)

### Procedure 5

Push **TEST** check button to cancel (release from) the test run mode.

([TEST] disappears on the display and the status returns to a normal.)

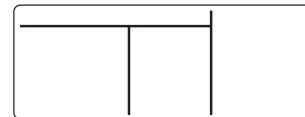



# 11 MAINTENANCE

## ⚠ CAUTION

When connecting a return air duct to the unit, the cleaning method of the air filter differs according to the construction of duct end. Ask a qualified installer or qualified service person.

### <Daily maintenance>

#### Cleaning of air filter

1. If  is displayed on the remote controller, contact to qualified installer or qualified service person.
2. Take out the air filter.
  - Push the extrusion of the air filter to inside and pull out it to take out the air filter.
3. Cleaning with water or vacuum cleaner
  - If dirt is heavy, clean the air filter by tepid water with neutral detergent or water.
  - After cleaning with water, dry the air filter sufficiently in a shade place.
4. Mount the air filter.
5. After cleaning, push  .  
 display disappears.

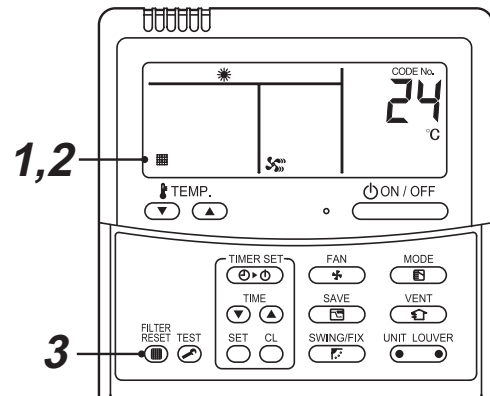

## ⚠ CAUTION

- Do not start the air conditioner while leaving air filter removed.
- Push the filter reset button. ( indication will be turn off.)

### PERIODIC MAINTENANCE

- For environmental conservation, it is strongly recommended that the indoor and outdoor units of the air conditioner in use be cleaned and maintained regularly to ensure efficient operation of the air conditioner. When the air conditioner is operated for a long time, periodic maintenance (once a year) is recommended. Furthermore, regularly check the outdoor unit for rust and scratches, and remove them or apply rustproof treatment, if necessary. As a general rule, when an indoor unit is operated for 8 hours or more daily, clean the indoor unit and outdoor unit at least once every 3 months. Ask a professional for this cleaning/maintenance work. Such maintenance can extend the life of the product though it involves the owner's expense. Failure to clean the indoor and outdoor units regularly will result in poor performance, freezing, water leakage, and even compressor failure.
- When a drain pump kit (sold separately) is installed. If it is used in a place full of dust or oil mist, the pump will be clogged and proper drainage is disabled. Clean the drain pump periodically. For how to clean the drain pump, contact the dealer.

EN

**Maintenance List**

<b>Part</b>	<b>Unit</b>	<b>Check (visual/auditory)</b>	<b>Maintenance</b>
Heat exchanger	Indoor/outdoor	• Dust/dirt clogging, scratches	• Wash the heat exchanger when it is clogged.
Fan motor	Indoor/outdoor	• Sound	• Take appropriate measures when abnormal sound is generated.
Filter	Indoor	• Dust/dirt, breakage	• Wash the filter with water when it is contaminated. • Replace it when it is damaged.
Fan	Indoor	• Vibration, balance • Dust/dirt, appearance	• Replace the fan when vibration or balance is terrible. • Brush or wash the fan when it is contaminated.
Air inlet/outlet grilles	Indoor/outdoor	• Dust/dirt, scratches	• Fix or replace them when they are deformed or damaged.
Drain pan	Indoor	• Dust/dirt clogging, drain contamination	• Clean the drain pan and check the downward slope for smooth drainage.
Ornamental panel, louvres	Indoor	• Dust/dirt, scratches	• Wash them when they are contaminated or apply repair coating.
Exterior	Outdoor	• Rust, peeling of insulator • Peeling/lift of coat	• Apply repair coating.

# 12 TROUBLESHOOTING

## Confirmation and check

When an error occurred in the air conditioner, an error code and indoor UNIT No. appear on the display part of the remote controller.

The error code is only displayed during the operation. If the display disappears, operate the air conditioner according to the following "Confirmation of error log" for confirmation.

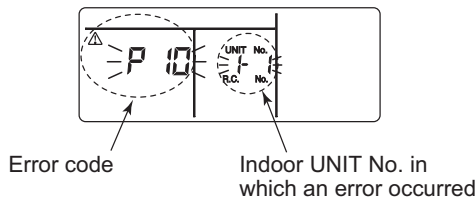

## Procedure 2

Every pushing of button used to set temperature, the error log stored in memory is displayed in order. The numbers in CODE No. indicate CODE No. [01] (latest) → [04] (oldest).

### REQUIREMENT

Do not push button because all the error log of the indoor unit will be deleted.

## Procedure 3

After confirmation, push button to return to the usual display.

## Confirmation of error log

When an error occurred on the air conditioner, the error log can be confirmed with the following procedure. (The error history is stored in memory up to 4 errors.)

The log can be confirmed from both operating status and stop status.

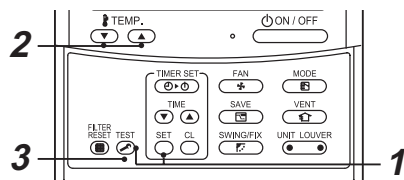

## Procedure 1

When pushing and buttons at the same time for 4 seconds or more, the following display appears.

If is displayed, the mode enters in the error log mode.

- [01: Order of error log] is displayed in CODE No..
- [Error code] is displayed in CHECK.
- [Indoor unit address in which an error occurred] is displayed in Unit No..

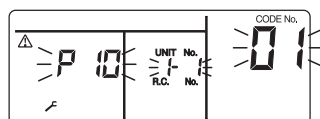

EN

## ■ Error codes and parts to be checked

Wired remote controller display	Main defective parts	Judging device	Parts to be checked / error description	Air conditioner status
Indication				
E01	No header remote controller	Remote controller	Incorrect remote controller setting --- The header remote controller has not been set (including two remote controllers).	*
	Remote controller communication error		No signal can be received from the indoor unit.	
E02	Remote controller transmission error	Remote controller	System interconnecting wires, indoor P.C. board, remote controller --- No signal can be sent to the indoor unit.	*
E03	Indoor unit-remote controller regular communication error	Indoor	Remote controller, network adapter, indoor P.C. board --- No data is received from the remote controller or network adapter.	Auto-reset
E04	Indoor unit-outdoor unit serial communication error	Indoor	System interconnecting wires, indoor P.C. board, outdoor P.C. board -	Auto-reset
	IPDU-CDB communication error		-- Serial communication error between indoor unit and outdoor unit	
E08	Duplicated indoor addresses ★	Indoor	Indoor address setting error --- The same address as the self-address was detected.	Auto-reset
E09	Duplicated header remote controllers	Remote controller	Remote controller address setting error --- Two remote controllers are set as header in the double-remote controller control.	*
			(* The header indoor unit stops raising alarm and follower indoor units continue to operate.)	
E10	CPU-CPU communication error	Indoor	Indoor P.C. board --- Communication error between main MCU and motor microcomputer MCU	Auto-reset
E18	Header indoor unit-indoor follower unit regular communication error	Indoor	Indoor P.C. board --- Regular communication is not possible between header and follower indoor units or between twin header (main) and follower (sub) units.	Auto-reset
E31	IPDU communication error	Outdoor	Communication error between IPDU and CDB	Entire stop
F01	Indoor unit heat exchanger sensor (TCJ) error	Indoor	Heat exchanger sensor (TCJ), indoor P.C. board --- Open-circuit or short-circuit of the heat exchanger sensor (TCJ) was detected.	Auto-reset
F02	Indoor unit heat exchanger sensor (TC) error	Indoor	Heat exchanger sensor (TC), indoor P.C. board --- Open-circuit or short-circuit of the heat exchanger sensor (TC) was detected.	Auto-reset
F04	Outdoor unit discharge temp. sensor (TD) error	Outdoor	Outdoor temp. sensor (TD), outdoor P.C. board --- Open-circuit or short-circuit of the discharge temp. sensor was detected.	Entire stop
F06	Outdoor unit temp. sensor (TE/TS) error	Outdoor	Outdoor temp. sensors (TE/TS), outdoor P.C. board --- Open-circuit or short-circuit of the heat exchanger temp. sensor was detected.	Entire stop
F07	TL sensor error	Outdoor	TL sensor may be displaced, disconnected or short-circuited.	Entire stop
F08	Outdoor unit outside air temp. sensor error	Outdoor	Outdoor temp. sensor (TO), outdoor P.C. board --- Open-circuit or short-circuit of the outdoor air temp. sensor was detected.	Operation continued
F10	Indoor unit room temp. sensor (TA) error	Indoor	Room temp. sensor (TA), indoor P.C. board --- Open-circuit or short-circuit of the room temp. sensor (TA) was detected.	Auto-reset
F12	TS (1) sensor error	Outdoor	TS (1) sensor may be displaced, disconnected or short-circuited.	Entire stop
F13	Heat sink sensor error	Outdoor	Abnormal temperature was detected by the temp. sensor of the IGBT heat sink.	Entire stop
F15	Temp. sensor connection error	Outdoor	Temp. sensor (TE/TS) may be connected incorrectly.	Entire stop
F29	Indoor unit, other P.C. board error	Indoor	Indoor P.C. board --- EEPROM error	Auto-reset
F31	Outdoor unit P.C. board	Outdoor	Outdoor P.C. board ---- In the case of EEPROM error.	Entire stop
H01	Outdoor unit compressor breakdown	Outdoor	Current detect circuit, power voltage --- Minimum frequency was reached in the current releasing control or short-circuit current (Idc) after direct excitation was detected	Entire stop
H02	Outdoor unit compressor lock	Outdoor	Compressor circuit --- Compressor lock was detected.	Entire stop
H03	Outdoor unit current detect circuit error	Outdoor	Current detect circuit, outdoor unit P.C. board --- Abnormal current was detected in AC-CT or a phase loss was detected.	Entire stop
H04	Case thermostat operation (1)	Outdoor	Malfunction of the case thermostat	Entire stop
H06	Outdoor unit low-pressure system error	Outdoor	Current, high-pressure switch circuit, outdoor P.C. board --- Ps pressure sensor error was detected or low-pressure protective operation was activated.	Entire stop
L03	Duplicated header indoor units ★	Indoor	Indoor address setting error --- There are two or more header units in the group.	Entire stop
L07	Group line in individual indoor unit ★	Indoor	Indoor address setting error --- There is at least one group-connected indoor unit among individual indoor units.	Entire stop
L08	Indoor group address not set ★	Indoor	Indoor address setting error --- Indoor address group has not been set.	Entire stop
L09	Indoor power level not set	Indoor	Indoor power level has not been set.	Entire stop
L10	Outdoor unit P.C. board	Outdoor	In the case of outdoor P.C. board jumper wire (for service) setting error	Entire stop



Wired remote controller display	Main defective parts	Judging device	Parts to be checked / error description	Air conditioner status
Indication				
L20	LAN communication error	Network adapter central control	Address setting, central control remote controller, network adapter --- Duplication of address in central control communication	Auto-reset
L29	Other outdoor unit error	Outdoor	Other outdoor unit error	Entire stop
			1) Communication error between IPDU MCU and CDB MCU 2) Abnormal temperature was detected by the heat sink temp. sensor in IGBT.	Entire stop
L30	Abnormal external input into indoor unit (interlock)	Indoor	External devices, outdoor unit P.C. board --- Abnormal stop due to incorrect external input into CN80	Entire stop
L31	Phase sequence error, etc.	Outdoor	Power supply phase sequence, outdoor unit P.C. board --- Abnormal phase sequence of the 3-phase power supply	Operation continued (thermostat OFF)
P01	Indoor unit fan error	Indoor	Indoor fan motor, indoor P.C. board --- Indoor AC fan error (fan motor thermal relay activated) was detected.	Entire stop
P03	Outdoor unit discharge temp. error	Outdoor	An error was detected in the discharge temp. releasing control.	Entire stop
P04	Outdoor unit high-pressure system error	Outdoor	High-pressure switch --- The IOL was activated or an error was detected in the high-pressure releasing control using the TE.	Entire stop
P05	Open phase detected	Outdoor	The power supply wire may be connected incorrectly. Check open phase and voltages of the power supply.	Entire stop
P07	Heat sink overheat	Outdoor	Abnormal temperature was detected by the temp. sensor of the IGBT heat sink.	Entire stop
P10	Indoor unit water overflow detected	Indoor	Drain pipe, clogging of drainage, float switch circuit, indoor P.C. board --- Drainage is out of order or the float switch was activated.	Entire stop
P15	Gas leakage detected	Outdoor	There may be gas leakage from the pipe or connecting part. Check for gas leakage.	Entire stop
P19	4-way valve error	Outdoor (Indoor)	4-way valve, indoor temp. sensors (TC/TCJ) --- An error was detected due to temperature drop of the indoor unit heat exchanger sensor when heating.	Auto-reset (Auto-reset)
P20	High-pressure protective operation	Outdoor	High-pressure protection	Entire stop
P22	Outdoor unit fan error	Outdoor	Outdoor unit fan motor, outdoor unit P.C. board --- An error (overcurrent, locking, etc.) was detected in the outdoor unit fan drive circuit.	Entire stop
P26	Outdoor unit inverter Idc activated	Outdoor	IGBT, outdoor unit P.C. board, inverter wiring, compressor --- Short-circuit protection for compressor drive circuit devices (G-Tr/IGBT) was activated.	Entire stop
P29	Outdoor unit position error	Outdoor	Outdoor unit P.C. board, high-pressure switch --- Compressor motor position error was detected.	Entire stop
P31	Other indoor unit error	Indoor	Another indoor unit in the group is raising an alarm.	Entire stop
			E03/L07/L03/L08 alarm check locations and error description	Auto-reset

★ : The air conditioner automatically enters the auto-address setting mode.



## Free Manuals Download Website

<http://myh66.com>

<http://usermanuals.us>

<http://www.somanuals.com>

<http://www.4manuals.cc>

<http://www.manual-lib.com>

<http://www.404manual.com>

<http://www.luxmanual.com>

<http://aubethermostatmanual.com>

Golf course search by state

<http://golfingnear.com>

Email search by domain

<http://emailbydomain.com>

Auto manuals search

<http://auto.somanuals.com>

TV manuals search

<http://tv.somanuals.com>