



TOSHIBA

Carrier

AIR CONDITIONER (SPLIT TYPE)

Installation Manual



Indoor Unit

Model name:

Under Ceiling Type

RAV-SP180CT-UL

RAV-SP240CT-UL

RAV-SP300CT-UL

RAV-SP360CT-UL

RAV-SP420CT-UL

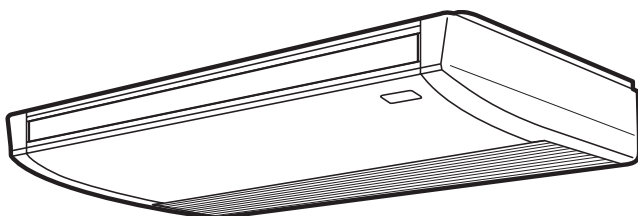

Installation Manual
Air conditioner (Split type)

1 English

Manuel d'installation
Climatiseur (Type split)

33 Français

Please read this Installation manual carefully before installing the Air Conditioner.

- This Manual describes the installation method of the indoor unit.
- For installation of the outdoor unit, follow the Installation Manual attached to the outdoor unit.

ADOPTION OF NEW REFRIGERANT









This Air Conditioner uses R410A an environmentally friendly refrigerant.

Contents

1	ACCESSORY PARTS.....	2
2	PRECAUTIONS FOR SAFETY.....	3
3	SELECTION OF INSTALLATION PLACE.....	5
4	REFRIGERANT PIPING AND EVACUATING.....	11
5	DRAIN PIPING WORK.....	14
6	ELECTRICAL CONNECTION.....	16
7	APPLICABLE CONTROLS.....	21
8	TEST RUN.....	27
9	TROUBLESHOOTING.....	29

1 ACCESSORY PARTS

■ Accessory parts

Part name	Q'ty	Shape	Usage
Owner's Manual	1	–	–
Installation Manual	1	This manual	–
Installation pattern	1	–	Drawing-out port of hanging bolt pipe
Thermal insulation pipe	2		For thermal insulation of pipe connecting section
Washer	4	3/8" (M10) × Ø1.0" (25 mm)	For holding down unit
Hose band	2		For connecting drain pipe
Drain hose	1		For connecting drain pipe
Bushing Ø2.2" (Ø56)	1		For protection of edge at hole for remote control wires
Bushing Ø1.1" (Ø28)	1		For sealing the back side conduit hole
Thermal insulator	1		For thermal insulation of drain hose (0.4" - thickness × 7.9" × 7.9" (10 - thickness × 200 × 200 mm))
Thermal insulator of top plate	1		For upper pipe hole of indoor unit (0.2" - thickness × 5.1" × 6.3" (6 - thickness × 130 × 160 mm))
Banding band	2		For prevention of open of drain hose thermal insulator

2 PRECAUTIONS FOR SAFETY

Installing, starting up, and servicing air-conditioning equipment can be hazardous due to system pressures, electrical components, and equipment location (roofs, elevated structures, etc.).

Only trained, qualified installers and service mechanics should install, start-up, and service this equipment.

Untrained personnel can perform basic maintenance functions such as cleaning heat exchanger. All other operations should be performed by trained service personnel.

When working on the equipment, observe precautions in the literature and on tags, stickers, and labels attached to the equipment.

Follow all safety codes. Wear safety glasses and work gloves. Keep quenching cloth and fire extinguisher nearby when brazing. Use care in handling, rigging, and setting bulky equipment.

Read these instructions thoroughly and follow all warnings or cautions included in literature and attached to the unit. Consult local building codes and National Electrical Code (NEC) for special requirements. Recognize safety information. This is the safety-alert symbol . When you see this symbol on the unit and in instructions or manuals, be alert to the potential for personal injury. Understand these signal words: DANGER, WARNING, and CAUTION. These words are used with the safety-alert symbol.

DANGER identifies the most serious hazards which will result in severe personal injury or death. WARNING signifies hazards which could result in personal injury or death. CAUTION is used to identify unsafe practices which may result in minor personal injury or product and property damage. NOTE is used to highlight suggestions which will result in enhanced installation, reliability, or operation.

WARNING

- **Ask an authorized dealer or qualified installation professional to install (including moving)/maintain the air conditioner.**
Inappropriate installation may result in water leakage, electric shock or fire.
- **Be sure to connect ground wire. (grounding work)**
Incomplete grounding cause an electric shock.
Do not connect ground wires to gas pipes, water pipes, lightning rods or ground wires for telephone wires.
- **Turn off the circuit breaker before attempting any electrical work.**
Make sure all circuit breaker is off. Failure to do so may cause electric shock.
- **Install the refrigerant pipe securely during the installation work before operating the air conditioner.**
If the air conditioner is operated with the valve open and without the refrigerant pipe, the compressor sucks air and the refrigeration cycle is overpressurized, which may cause a burst or injury.
- **When moving the air conditioner for the installation into another place, be very careful not to enter any gaseous matter other than the specified refrigerant into the refrigeration cycle.**
If air or any other gas is mixed in the refrigerant, the gas pressure in the refrigeration cycle becomes abnormally high and it resultingly causes pipe burst and injuries on persons.
- **Perform installation work properly according to the Installation Manual.**
Inappropriate installation may result in water leakage, electric shock or fire.
- **When the air conditioner is installed in a small room, provide appropriate measures to ensure that the concentration of refrigerant leakage occur in the room does not exceed the critical level.**
- **Install the air conditioner securely in a location where the base can sustain the weight adequately.**
- **Perform the specified installation work to guard against an earthquake.**
If the air conditioner is not installed appropriately, accidents may occur due to the falling unit.
- **If refrigerant gas has leaked during the installation work, ventilate the room immediately.**
If the leaked refrigerant gas comes in contact with fire, noxious gas may generate.
- **After the installation work, confirm that refrigerant gas does not leak.**
If refrigerant gas leaks into the room and flows near a fire source, such as a cooking range, noxious gas might generate.
- **Electrical work must be performed by a qualified electrician in accordance with the Installation Manual. Make sure the air conditioner uses an exclusive power supply.**
An insufficient power supply capacity or inappropriate installation may cause fire.
- **Use the specified wires for wiring connect the terminals securely fix.**
To prevent external forces applied to the terminals from affecting the terminals.

- **Conform to the regulations of the local electric company when wiring the power supply.**
Inappropriate grounding may cause electric shock.
- **For the refrigerant recovery work (collection of refrigerant from the pipe to the compressor), stop the compressor before disconnecting the refrigerant pipe.**
If the refrigerant pipe is disconnected while the compressor is working with the valve open, the compressor sucks air and the refrigeration cycle is overpressurized, which may cause a burst or injury.

 **CAUTION**

- **THIS AIR CONDITIONER ADOPTS THE NEW HFC REFRIGERANT (R410A) WHICH DOES NOT DESTROY OZONE LAYER.**
 - The characteristics of R410A refrigerant are ; easy to absorb water, oxidizing membrane or oil, and its pressure is approx. 1.6 times higher than that of refrigerant R22. Accompanied with the new refrigerant, refrigerating oil has also been changed. Therefore, during installation work, be sure that water, dust, former refrigerant, or refrigerating oil does not enter the refrigerating cycle.
 - To prevent charging an incorrect refrigerant and refrigerating oil, the sizes of connecting sections of charging port of the main unit and installation tools are changed from those for the conventional refrigerant.
 - Accordingly the exclusive tools are required for the new refrigerant (R410A).
 - For connecting pipes, use new and clean piping designed for R410A, and please care so that water or dust does not enter.
 - **Tighten the flare nut with a torque wrench in the specified manner.**
Excessive tightening of the flare nut may cause a crack in the flare nut after a long period, which may result in refrigerant leakage.
 - **Wear heavy gloves during the installation work to avoid injury.**
 - **The installation fuse must be used for the power supply line of this conditioner.**
-

3 SELECTION OF INSTALLATION PLACE

⚠ WARNING

- **Install the air conditioner at enough strong place to withstand the weight of the unit.**
If the strength is not enough, the unit may fall down resulting in injury.
- **Install the air conditioner at a height 8' (2.4 m) or more from the floor.**
If you insert your hands or others directly into the unit while the air conditioner operates, it is dangerous because you may contact with revolving fan or active electricity.

⚠ CAUTION

- **Do not install the air conditioner in a location subject to a risk of exposure to a combustible gas.**
If a combustible gas leaks and stays around the unit, a fire may occur.

Upon approval of the customer, install the air conditioner in a place that satisfies the following conditions.

- Place where the unit can be installed horizontally.
- Place where a sufficient servicing space can be ensured for safety maintenance and check.
- Place where drained water will not cause any problem.

Avoid installing in the following places.

- Place exposed to air with high salt content (seaside area), or place exposed to large quantities of sulfide gas (hot spring).
(Should the unit be used in these places, special protective measures are needed.)
- Place exposed to oil, vapor, oil smoke or corrosive gas.
- Place where organic solvent is used nearby.
- Place close to a machine generating high frequency.
- Place where the discharged air blows directly into the window of the neighbor house. (Outdoor unit)
- Place where noise of the outdoor unit is easily transmitted.
(When install the outdoor unit on the boundary with the neighbor, pay due attention to the level of noise.)
- Place with poor ventilation. (Before air ducting work, check whether value of fan speed, static pressure and duct resistance are correct.)

■ Installation space

Secure the specified space in the figure for installation and servicing.

Unit: in (mm)

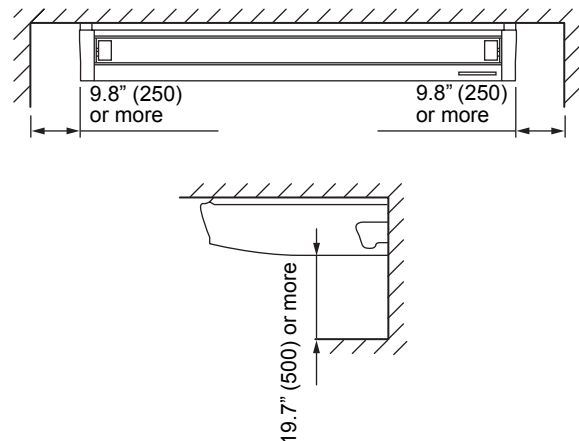

■ Height of ceiling

Set the installable height of the ceiling within 13'1" (4 m), otherwise the air distribution will become poor. If height of ceiling exceeds 11'6" (3.5 m), hot air becomes difficult to reach the floor surface, and then the change of setup of high ceiling is necessary. For the change method of high ceiling, refer to the application control, "In case of installation to high ceiling" and "In case of incorporating filter sold separately" in this Manual.

List of installable ceiling height

Setup data		
0000	Standard (Factory default)	11'6" (3.5 m) or less
0001	High ceiling 1	more than 11'6" (3.5 m) up to 13'1" (4.0 m)

According to the conditions of installation, setup time of turning-on of filter sign (notification of filter cleaning) of the remote control can be changed.

When it is difficult to warm up the room due to installation place or structure of the room, the detection temperature of heating can be raised.

For change the setup time, refer to the application control, "Change of filter sign turning-on time" and "How to increase the heating effect" in this Manual.

■ Wireless remote control

Decide the position which remote control is operated and the installation place.

And then refer to the Installation Manual of the wireless remote controller kit sold separately.

(The signal of the wireless type remote control can be received within approx. 23' (7 m). This distance is a criterion and varies a little according to capacity of the battery, etc.)

- To prevent malfunction, select a place where is not affected by a fluorescent lamp or direct sunlight.
- Two or more (up to 6 units) wireless-type indoor units can be set in a room.

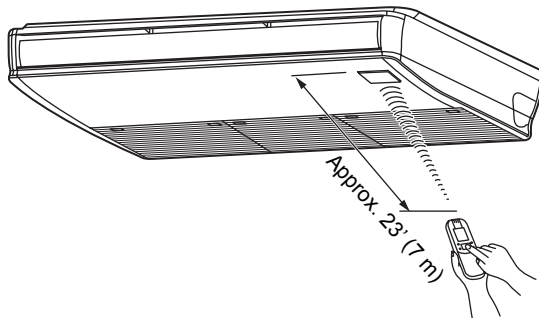

■ Before installation

1 Removal of suction grille

Slide the suction grille fixing knobs (2 positions) toward the arrow direction, and then open the suction grille.

Under the condition of suction grille opened, push the hook section of hinges (2 positions) at the rear side, and then pull out the suction grille.

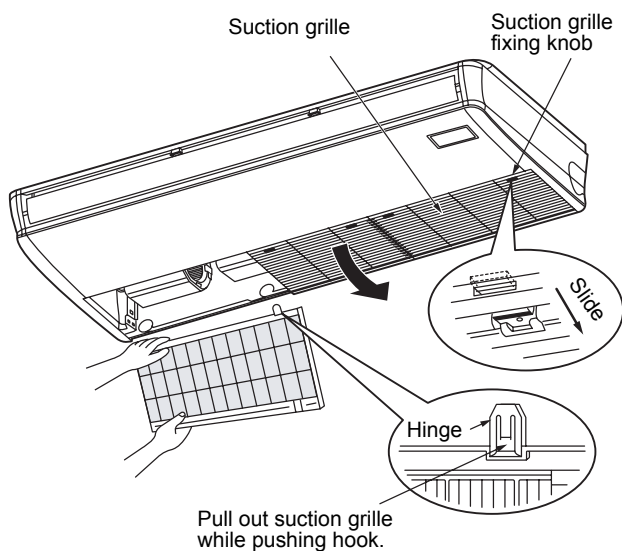

2 Removing wire guard

Remove the screws (2 pcs.) which are fixing the wire guard.

Remove the clamp fixing screws and remove the wire guard.

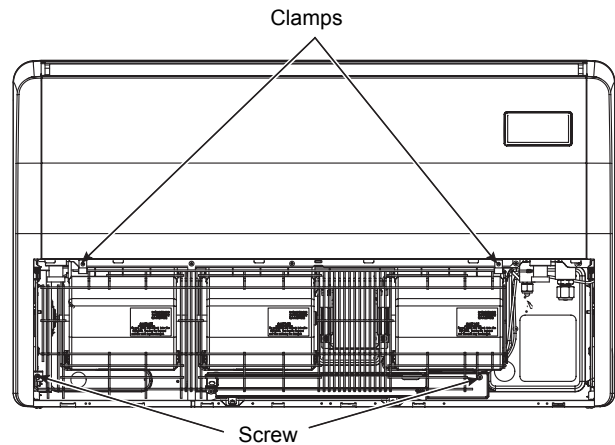

⚠ CAUTION

Attach back the wire guard once indoor unit is installed. Remove the 2 screws fixing the wire guard and hung the wire guard with the clamps during a service.

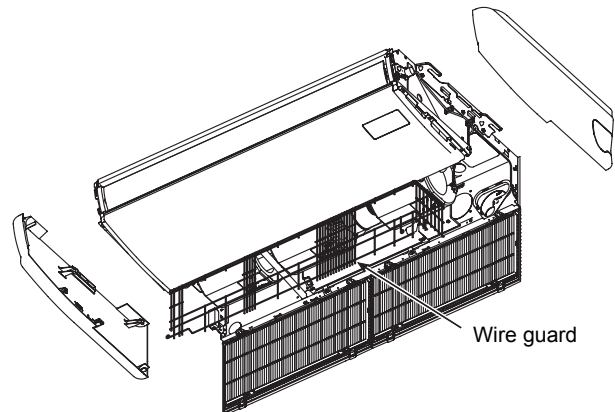

3 Removal of side panel

After removing the side panel fixing screws (1 each at right and left), slide the side panel forward and then remove it.

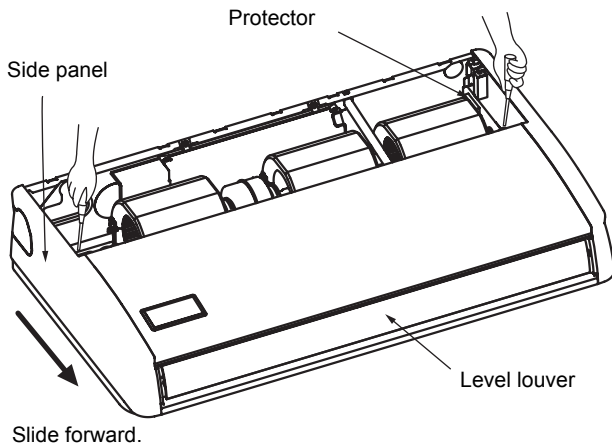

4 Removal of protective vinyl

Peel out the protective vinyl on the level louver.

5 Removal of protector

Remove the protector (1 pcs.) of the fan.
(RAV-SP240CT only)

External view

REQUIREMENT

Strictly comply with the following rules to prevent damage of the indoor units and human injury.

- Do not put a heavy article on the indoor unit. (Even units are packaged)
- Carry in the indoor unit as it is packaged if possible. If carrying in the indoor unit unpacked by necessity, be sure to use buffering cloth, etc. to not damage the unit.
- Do not apply force to the other parts (refrigerant pipe, drain pan, foamed parts, or resin parts, etc.).
- Carry the package by two or more persons, and do not bundle it with plastic band at positions other than specified.

Unit: in (mm)

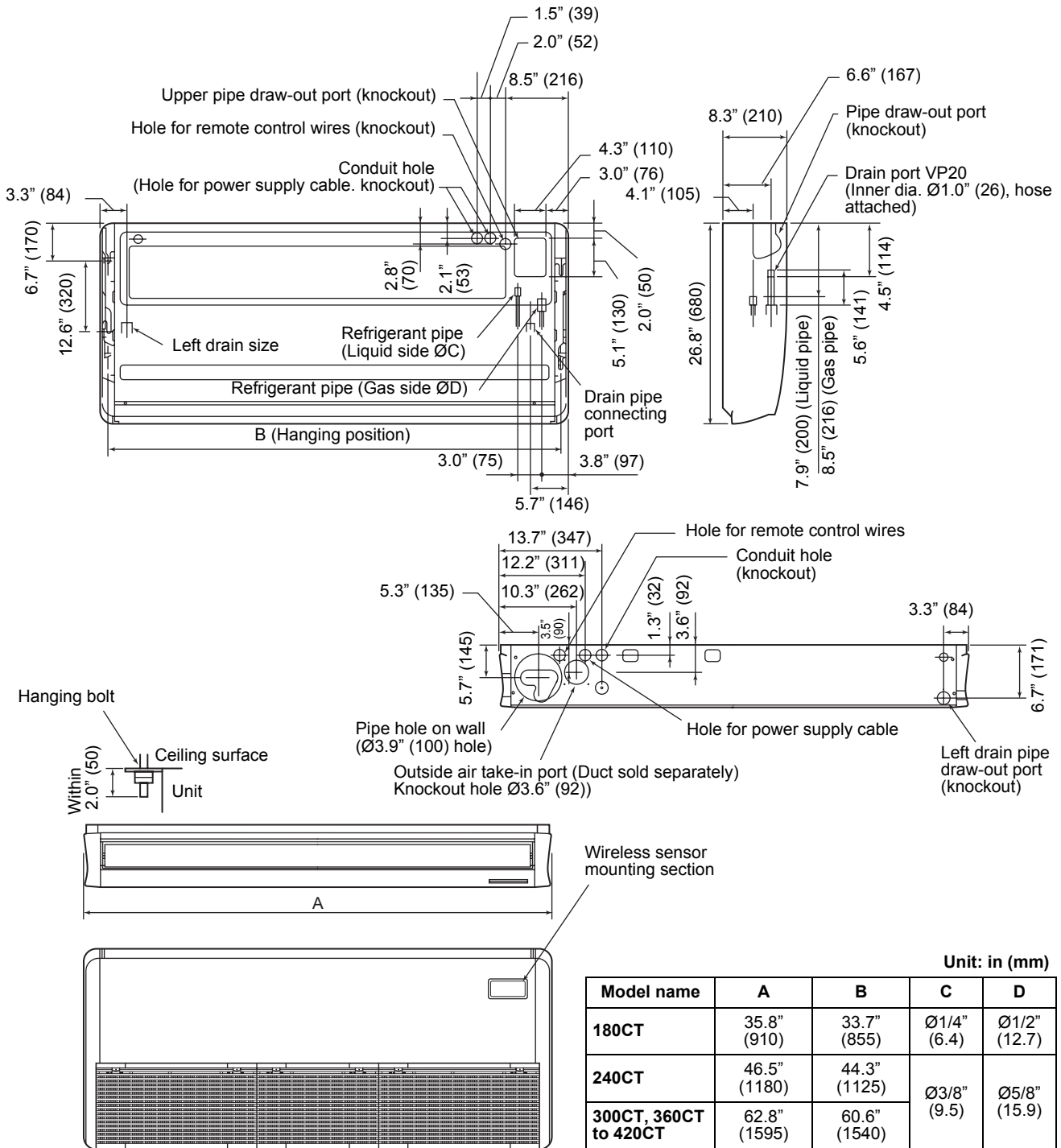

Considering pipe/wire connecting work inside the ceiling after the indoor unit has been hanged, select an installation place and determine piping direction.

- If the ceiling has already been set before hanging the main unit, prepare refrigerant pipe, drain pipe, indoor connecting wire, remote control cord, etc. up to the place where pipe and wire can be connected.
- Check the size of the indoor unit, and match the indoor unit size using the attached installation pattern.



Using attached installation pattern

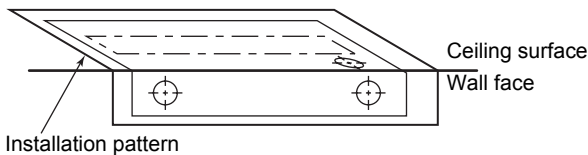

Using the pattern, positioning of the hanging bolt and pipe hole can be performed.

* As an error to some degree may generate on the pattern size due to temperature and humidity, be sure to confirm the size.

Installation of hanging bolts

Use 3/8" (M10) hanging bolts (4 pcs, to be local procure).

Matching to the existing structure, set pitch according to size in the unit external view as shown below.

New concrete slab	
Install the bolts with insert brackets or anchor bolts.	
<p>(Blade type bracket)</p>	<p>(Slide type bracket)</p>
<p>Anchor bolt (Pipe hanging anchor bolt)</p> <p>Rubber</p>	
Steel frame structure	
Use existing angles or install new support angles.	
<p>Hanging bolt</p> <p>Hanging bolt</p> <p>Support angle</p>	
Existing concrete slab	
Use a hole-in anchors, hole-in plugs, or a hole-in bolts.	

Draw-out direction of pipe/wire

• Decide installation place of the unit and draw-out direction of pipe and wire.

Pipe knockout hole

Piping from rear side

* Cut off the groove section with a plastic cutter, etc.

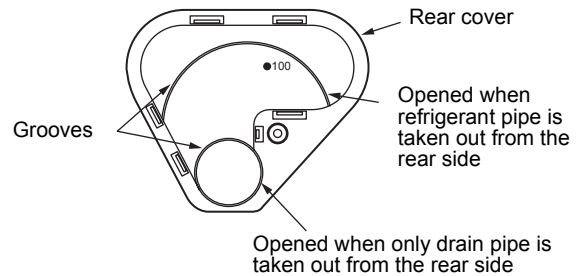

Piping from right side

* Cut off the groove section with a metal saw or plastic cutter, etc.

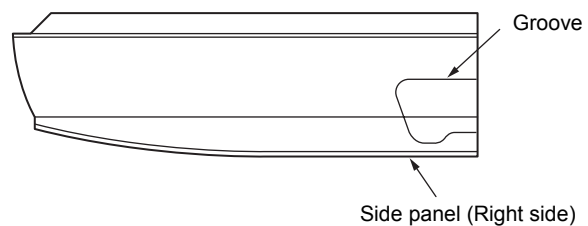

Piping from left side

Taking pipe from left side is applied only to the drain pipe. The refrigerant pipe cannot be taken out from the left side.

* Cut off the groove section with a metal saw or plastic cutter, etc.

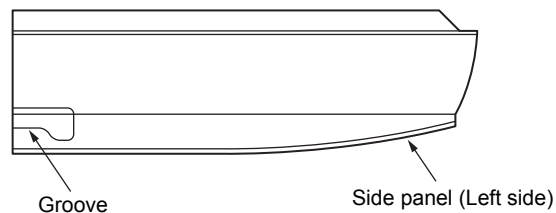

Piping from upper side

Taking pipe from upper side is applied only to the refrigerant pipe.

When taking out the drain pipe from the upper side, use a drain up kit sold separately.

Open the upper pipe draw-out port (Knockout hole) shown in the external view.

(Knockout hole of thin plate)

After piping, cut off the attached thermal insulator of the top plate to pipe shape, and then seal the knockout hole.

■ Installation of indoor unit

• Preparation before holding down main unit

- * Confirm the presence of the ceiling material beforehand because the fixing method of hanging metal when the ceiling material is set differs from that when the ceiling material is not set.

▼ There is ceiling material

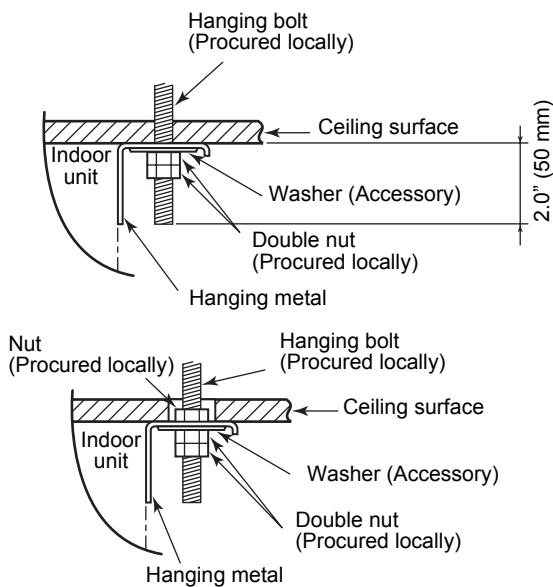

- * Tighten the hanging metal with upper/lower nuts as shown in the figure.

▼ There is no ceiling material

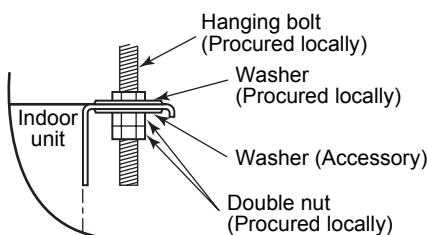

• Holding down of main unit

- (1) Attach washer and nuts to the hanging bolt.

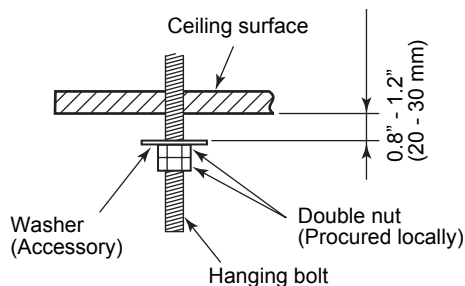

- (2) Hang the unit to the hanging bolt as shown in the figure below.

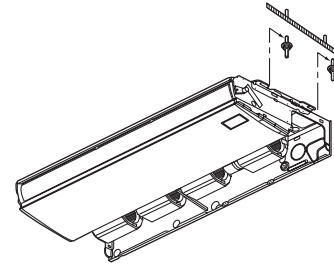

- (3) As shown in the figure below, fix the ceiling material securely with the double nuts.

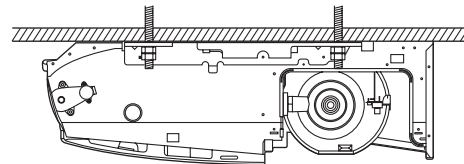

REQUIREMENT

- The ceiling surface may not be horizontal. Be sure to confirm that width and depth directions are level.

■ Installation of remote control (Sold separately)

For installation of the wired remote control, follow the Installation Manual attached with the remote control.

- Pull out the remote control cord together with the refrigerant pipe or drain pipe. Be sure to pass the remote control cord through upper side of the refrigerant pipe and drain pipe.
- Do not leave the remote control at a place exposed to the direct sunlight and near a stove.
- Operate the remote control, confirm that the indoor unit receives a signal surely, and then install it. (Wireless type)
- Keep 3'3" (1 m) or more from the devices such as television, stereo, etc. (Disturbance of image or noise may generate.) (Wireless type)

4 REFRIGERANT PIPING AND EVACUATING

Refrigerant Piping

- The connecting sections of the refrigerant pipes are provided at the positions in the figure below.

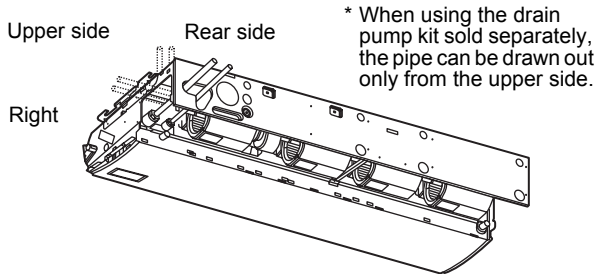

- Use copper pipe with 0.03" (0.8 mm) or more thickness.
(In case pipe size is Ø5/8" (15.9 mm), with 0.04" (1.0 mm) or more.)
- Flare nut and flare works are also different from those of the conventional refrigerant.
Take out the flare nut attached to the main unit of the air conditioner, and use it.

REQUIREMENT

When the refrigerant pipe is long, provide support brackets at intervals of 8'2" - 9'10" (2.5 - 3 m) to clamp the refrigerant pipe. Otherwise, abnormal sound may be generated.

CAUTION

IMPORTANT 4 POINTS FOR PIPING WORK

- Remove dust and moisture from the inside of the connecting pipes.
- Tight connection (between pipes and unit)
- Evacuate the air in the connecting pipes using VACUUM PUMP.
- Check the gas leakage. (Connected points)

Pipe size

Model name	RAV-	SP180 type	SP240, SP300, SP360, SP420 type
Pipe size	Gas side	1/2" (12.7 mm)	5/8" (15.9 mm)
	Liquid side	1/4" (6.4 mm)	3/8" (9.5 mm)

Permissible Piping Length and Height Difference

They vary according to the outdoor unit.
For details, refer to the Installation Manual attached to the outdoor unit.

Flaring

- Cut the pipe with a pipe cutter.
Remove burrs completely.
Remaining burrs may cause gas leakage.
- Insert a flare nut into the pipe, and flare the pipe.
As the flaring sizes of R410A differ from those of refrigerant R22, the flare tools newly manufactured for R410A are recommended.
However, the conventional tools can be used by adjusting projection margin of the copper pipe.

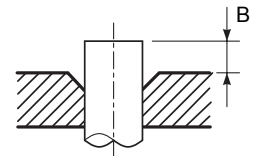

Projection margin in flaring: B (Unit: in (mm))

Rigid (Clutch type)

Outer dia. of copper pipe	R410A tool used	Conventional tool used
1/4" - 5/8" (6.4 - 15.9)	0 - 0.02" (0 - 0.5)	0.04" - 0.06" (1.0 - 1.5)

Outer dia. of copper pipe	Imperial (Wing nut type)
1/4" (6.4) or 3/8" (9.5)	0.06" - 0.08" (1.5 - 2.0)
1/2" (12.7) or 5/8" (15.9)	0.08" - 0.1" (2.0 - 2.5)

Flaring dia. meter size: A (Unit: in (mm))

Outer dia. of copper pipe	A ⁺⁰ _{-0.02" (-0.4)}
1/4" (6.4)	0.36" (9.1)
3/8" (9.5)	0.52" (13.2)
1/2" (12.7)	0.65" (16.6)
5/8" (15.9)	0.78" (19.7)

- * In case of flaring for R410A with the conventional flare tool, pull it out approx. 0.02" (0.5 mm) more than that for R22 to adjust to the specified flare size.
The copper pipe gauge is useful for adjusting projection margin size.

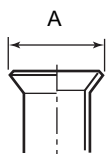

Tightening connection

⚠ CAUTION

- Do not apply excessive torque. Otherwise, the nut may crack depending on the conditions.

(Unit: ft•lbs (N•m))

Outer dia. of copper pipe	Tightening torque
1/4" (6.4 mm)	10 - 13 (14 - 18)
3/8" (9.5 mm)	24 - 31 (33 - 42)
1/2" (12.7 mm)	37 - 46 (50 - 62)
5/8" (15.9 mm)	46 - 57 (63 - 77)

▼ Tightening torque of flare pipe connections

Pressure of R410A is higher than that of R22.

(Approx. 1.6 times)

Therefore, using a torque wrench, tighten the flare pipe connecting sections which connect the indoor and outdoor units of the specified tightening torque.

Incorrect connections may cause not only a gas leak, but also a trouble of the refrigeration cycle.

Align the centres of the connecting pipes and tighten the flare nut as far as possible with your fingers. Then tighten the nut with a spanner and torque wrench as shown in the figure.

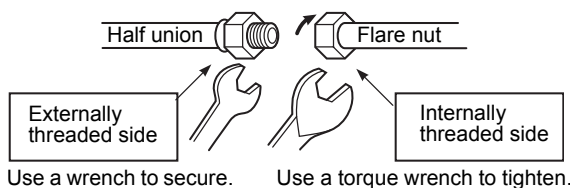
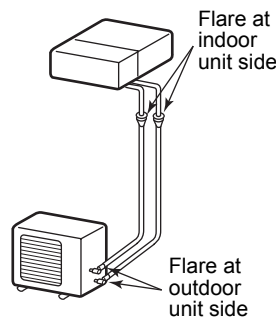

REQUIREMENT

Tightening with an excessive torque may crack the nut depending on installation conditions.

Tighten the nut within the specified tightening torque.

Piping with outdoor unit

- Shape of valve differs according to the outdoor unit. For details of installation, refer to the Installation Manual of the outdoor unit.

■ Evacuation

Using a vacuum pump, perform vacuuming from the charge port of valve of the outdoor unit.

For details, follow to the Installation Manual attached to the outdoor unit.

- Never use the refrigerant sealed in the outdoor unit for air purge.

REQUIREMENT

For the tools such as charge hose, etc., use those manufactured exclusively for R410A.

Refrigerant amount to be added

For addition of the refrigerant, add refrigerant "R410A" referring to the attached Installation Manual of outdoor unit.

Be sure to use a scale to charge the refrigerant of specified amount.

REQUIREMENT

- Charging an excessive or too little amount of refrigerant causes a trouble of the compressor. Be sure to charge the refrigerant of specified amount.
- A personnel who charged the refrigerant should write down the pipe length and the added refrigerant amount in the nameplate attached to the service panel of the outdoor unit. It is necessary to troubleshoot the compressor and refrigeration cycle malfunction.

Open the valve fully

Open the valve of the outdoor unit fully.

For details, refer to the Installation Manual attached to the outdoor unit.

Gas leak check

Check with a leak detector or soap water whether gas leaks or not, from the pipe connecting section or cap of the valve.

REQUIREMENT

Use a leak detector manufactured exclusively for HFC refrigerant (R410A, R134a, etc.).

Thermal insulation process

Apply thermal insulation for the pipes separately at liquid side and gas side.

For the thermal insulation to the pipes at gas side, be sure to use the material with heat-resisting temperature 248 °F (120 °C) or higher.

Using the attached thermal insulation material, apply the thermal insulation to the pipe connecting section of the indoor unit securely without gap.

REQUIREMENT

- Apply the thermal insulation to the pipe connecting section of the indoor unit securely up to the root without exposure of the pipe. (The pipe exposed to the outside causes water leak.)
- Wrap heat insulator with its slits facing up (ceiling side).

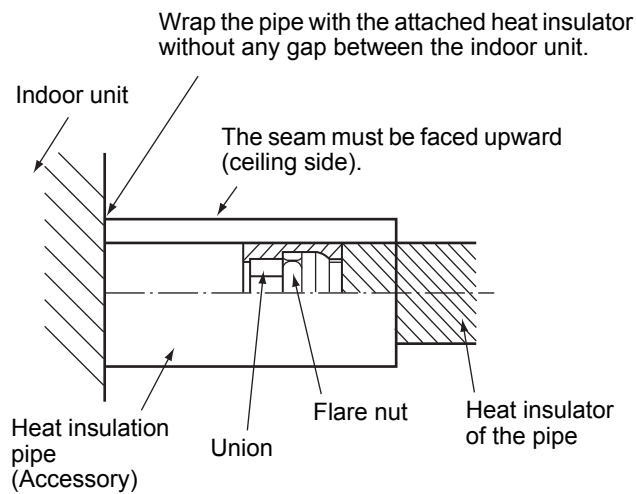

5 DRAIN PIPING WORK

⚠ CAUTION

- Following the Installation Manual, perform the drain piping work so that water is properly drained, and apply a heat insulation so as not to cause a dew dropping. Inappropriate piping work may result in water leakage in the room and wet of furniture.

■ Piping/Heat insulating material

Require the following materials for piping and heat insulating at site.

Piping	Hard vinyl chloride pipe VP20 (Outer dia.: Ø1.0" (26 mm))
Heat insulator	Foam polyethylene: Thickness 0.4" (10 mm) or more

REQUIREMENT

- Be sure to perform heat insulation of the drain pipes of the indoor unit.
- Never forget to perform heat insulation of the connecting part with the indoor unit. An incomplete heat insulation causes dew dropping.
- Set the drain pipe with downward slope (1/100 or more), and do not make swelling or trap on the piping. It may cause an abnormal sound.
- For length of the traversing drain pipe, restrict 65'7" (20 m) or less. In case of a long pipe, provide support brackets with interval of 4'11" - 6'7" (1.5 - 2 m) in order to prevent waving.

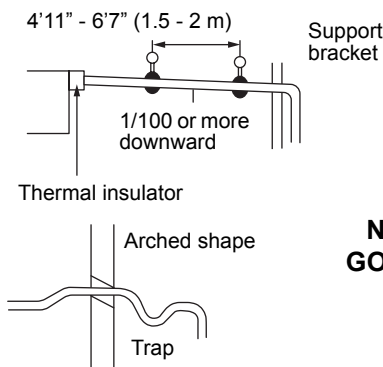

- Set the collective piping as shown in the below figure.

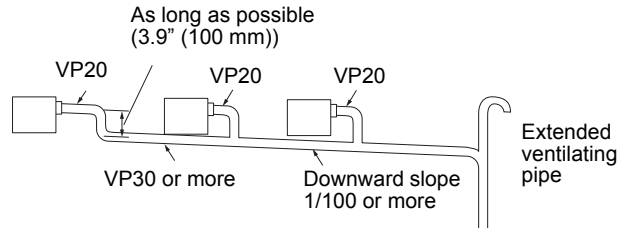

<Collective piping>

- Be sure not to apply force to the connecting part of the drain pipe.
- The hard vinyl-chloride pipe cannot be directly connected to the drain pipe connecting port of the indoor unit.

For connection with the drain pipe connecting port, be sure to use/fix the attached flexible hose with the hose band, otherwise a damage or water leak is caused on the drain pipe connecting port.

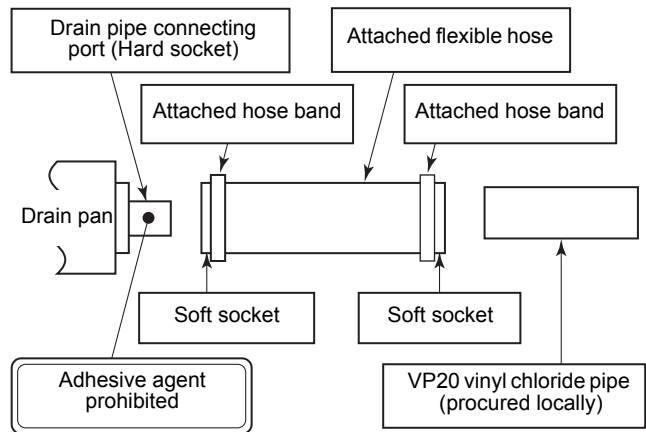

Adhesive inhibited:

Use the attached flexible hose and hose band for connecting the drain hose to the clear drain socket. If applying the adhesive, socket will be damaged and cause water leakage.

■ Drain up

When not securing down slope on the drain pipe, use a Drain pump kit sold separately. Also refer to the "Drain pump kit installation manual". The drain pipe can be raised 23.6" (600 mm) from the top face of the main unit.

- * When using Drain pump kit, both drain pipe and refrigerant pipe can be taken only from upper side.
- * VP25 PVC pipe is needed when a drain pump is used.

EN

■ Connection of drain hose

- Insert the attached drain hose into the drain pipe connecting port on the drain pan up to the end.
- Fit the attached hose band to the end of the pipe connecting port, and then tighten it securely.

REQUIREMENT

- Be sure to fix the drain hose with the attached hose band, and set the tightening position upward.
- As the draining is the natural water draining, arrange the pipe outside of the unit on the down slope.
- If piping is performed as shown in the figure, drain cannot be discharged.

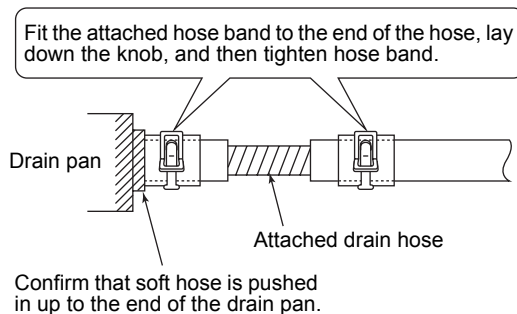
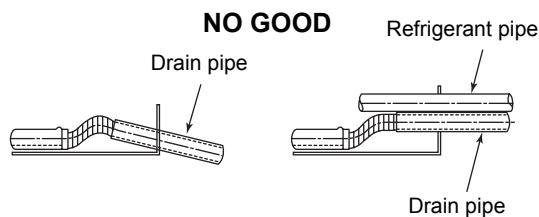

■ Connection of drain pipe

- Connect the hard vinyl chloride pipe (procured locally) to the mounted drain hose which was attached.
- **Piping from left side**
 - In case of taking pipe from the left side, exchange the plug from left to right. Push in the plug of which end is not sharp up to the end.

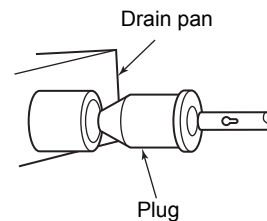

■ Thermal insulating process

- Using the attached drain hose thermal insulator, lap the connecting section and the drain hose without clearance, and then tighten with two handing band so that thermal insulator does not open.
- Covering the attached drain hose thermal insulator, lap the thermal insulator (procured locally) to the drain pipe without clearance.

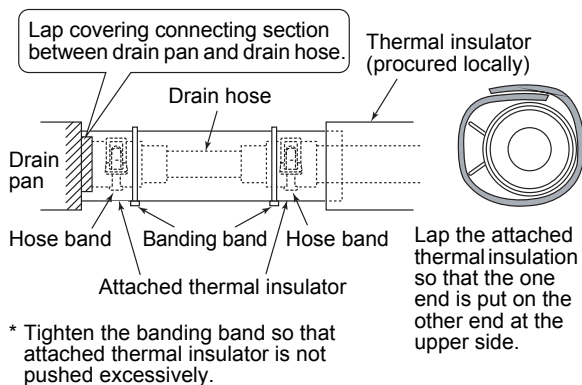

* Tighten the banding band so that attached thermal insulator is not pushed excessively.

6 ELECTRICAL CONNECTION

WARNING

- 1. Using the specified wires, ensure to connect the wires, and fix wires securely so that the external tension to the wires do not affect the connecting part of the terminals.**
Incomplete connection or fixation may cause a fire, etc.
- 2. Be sure to connect ground wire. (grounding work)**
Incomplete grounding cause an electric shock.
Do not connect ground wires to gas pipes, water pipes, lightning rods or ground wires for telephone wires.
- 3. Appliance shall be installed in accordance with national wiring regulations.**
Capacity shortage of circuit breaker or incomplete installation may cause an electric shock or a fire.

CAUTION

- Consult local building codes, NEC (National Electrical Code) or CEC (Canadian Electrical Code) for special requirements.
- This indoor unit has no power cord.
- If incorrect/incomplete wiring is carried out, it will cause an electrical fire or smoke.
- Be sure to install circuit breaker is not tripped by shock waves.
If circuit breaker is not installed, an electric shock may be caused.
- Be sure to use the cord clamps attached to the product.
- Do not damage or scratch the conductive core and inner insulator of power and system interconnection wires when peeling them.
- Use the power cord and system interconnection wire of specified thickness, type, and protective devices required.

REQUIREMENT

- For power supply wiring, strictly conform to the Local Regulation in each country.
- For wiring of power supply of the outdoor units, follow the Installation Manual of each outdoor unit.
- Never connect 208/230 V power to the terminal blocks (A, B etc.) for control wiring.
(Otherwise, the system will fail.)
- Perform the electric wiring so that it does not come to contact with the high-temperature part of the pipe.
The coating may melt resulting in an accident.
- Run the refrigerant piping line and control wiring line in the same line.
- Do not turn on the circuit breaker of the indoor unit until vacuuming of the refrigerant pipes completes.

Remote control wiring

- For single system, use 2 x AWG20 non polarity wire is used for the remote control wiring.

Wiring

1. Connect the connecting wire to the terminal as identified with their respective numbers on the terminal block of indoor and outdoor unit.
(4 x AWG12)
2. Insulate the unsheathed redundant cords (conductors) with electrical insulation tape.
Process them so that they do not touch any electrical or metal parts.
3. For inter-unit wiring, do not use a wire jointed to another on the way.

	Wire Quantity x size
Indoor unit - Outdoor unit *1	3 x AWG12 (polar)
Ground	1 x AWG12 or thicker
Remote control	2 x AWG20 (non-polar)

*1 :Length of the system interconnection wires.

RAV-	SP180AT2	SP240AT2	SP300AT2 - SP420AT2
Wire length	164'1" (50 m) or less	229'8" (70 m) or less	246'1" (75 m) or less

 **CAUTION**

Use the same size wire for the field power supply wire and system interconnection wires when the outdoor unit is RAV-SP180AT2.

NOTE

- Use copper supply wires.
 - Use UL wires rated 600 V for the system interconnection wires.
 - Use UL wires rated 300 V for the remote control wires.
-

■ Wire connection

REQUIREMENT

- Be sure to connect the wires matching the terminal numbers. Incorrect connection causes a trouble.
 - The low-voltage circuit is provided for the remote control. (Do not connect the high-voltage circuit)
-
- Loosen the cover mounting screws (2 positions) of the electric parts box, and then remove the cover.
 - Attach the conduit pipe to the conduit hole with a lock nut.
 - Slit the film of bushing attached to the hole for remote control wire, and then pass through wires.
 - Connect the system interconnection wires and the remote control wire to the terminal block of the electric parts box. Secure the ground wire with the ground screw.
 - Tighten screws of the terminal block securely, and fix the wires with code clamp attached to the electric parts box. (Do not apply tension to the connecting section of the terminal block.)
 - Mount the cover of the electric parts box so that it does not pinch the wires.

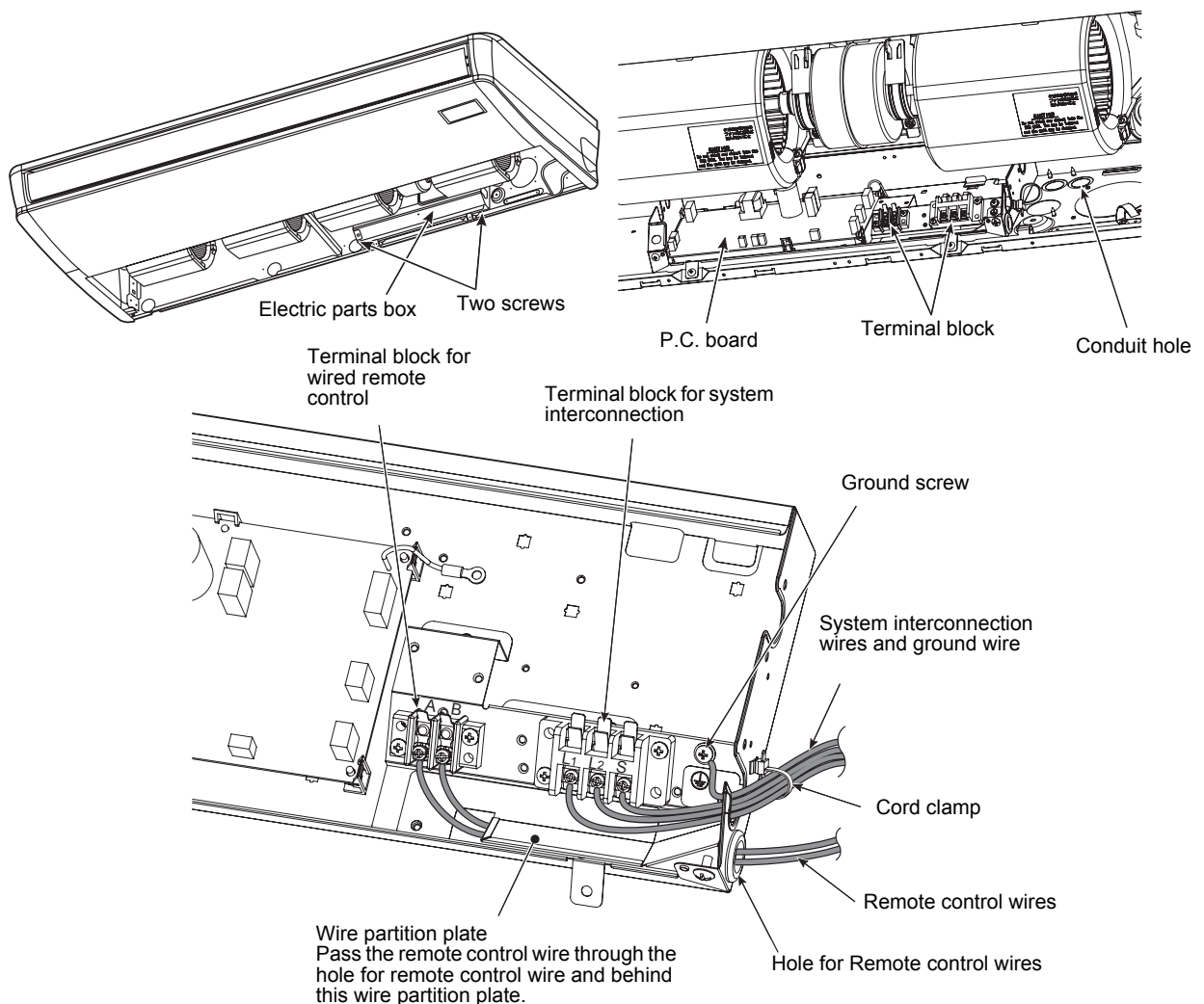

⚠ CAUTION

Fix the system interconnection wires and the remote control wires separately with the cord clamps as shown below.

Connected at backside

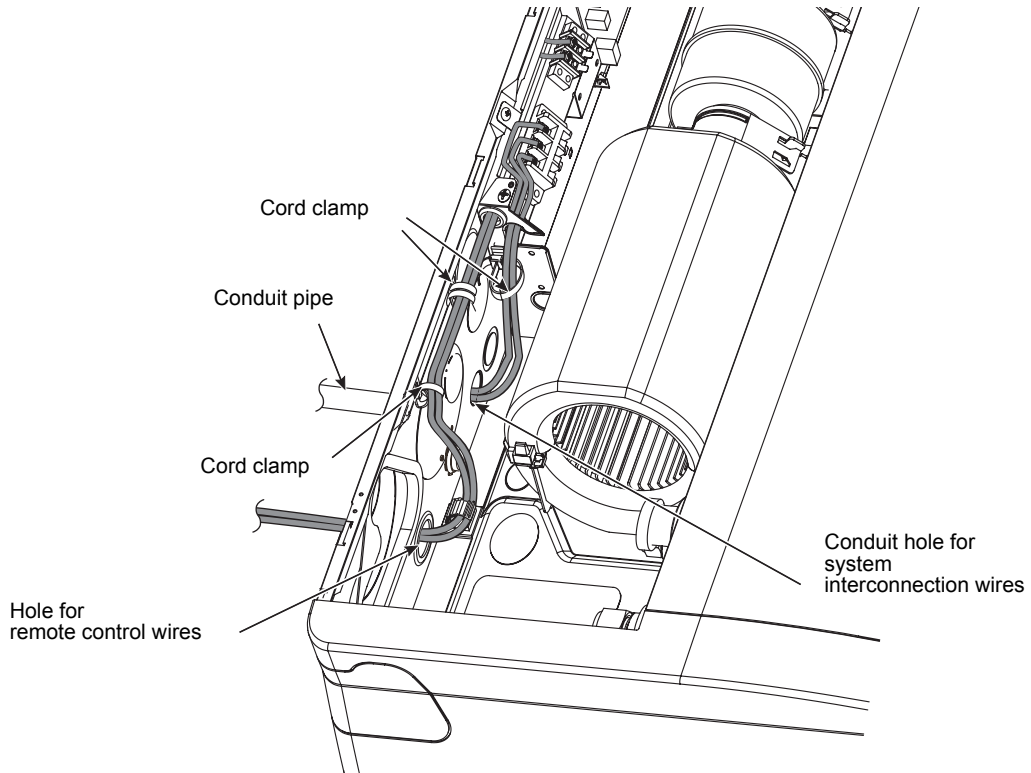

Connected at upside

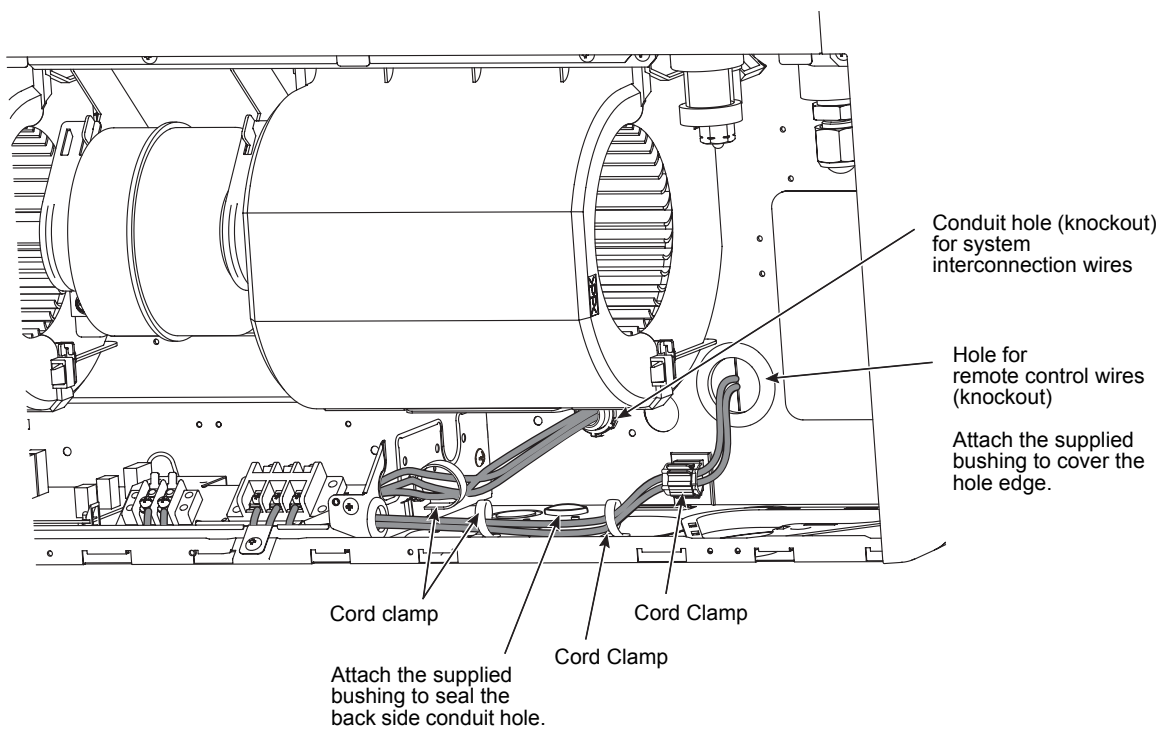

■ System interconnection Wires and Ground Wire

- Strip wire ends.
System interconnection wire : 0.4" (10 mm).
Ground wire : 0.8" (20 mm)
- Match wire colours with terminal numbers on indoor and outdoor units' terminal blocks and firmly screw wires to the corresponding terminals.
- Secure the ground wire with the ground screw.
- Fix the wire with cord clamp.

Unit: in (mm)

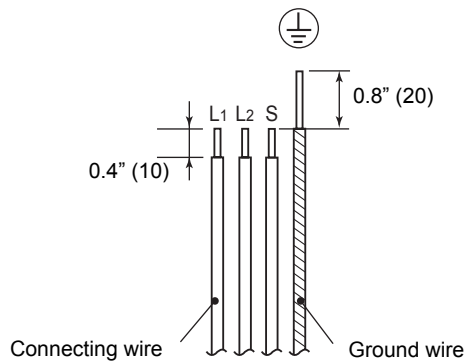

⚠ CAUTION

- Firmly tighten the screws of the terminal block.

Keep the wire length as shown in figure below when it is connected to the terminal block.

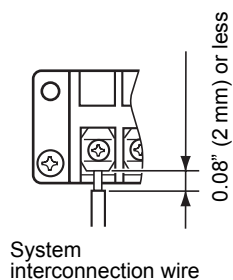

■ Remote Control Wiring

- Strip off approx. 0.4" (9 mm) the wire to be connected.
- Non polarity, 2 x AWG20 wire is used for wiring of the remote control.

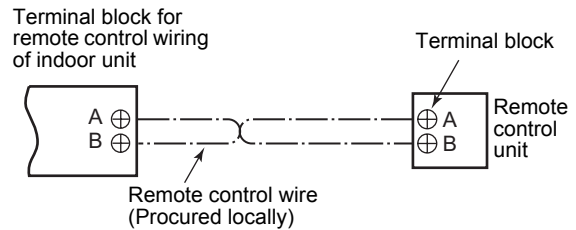

■ Wiring Diagram

▼ Single system

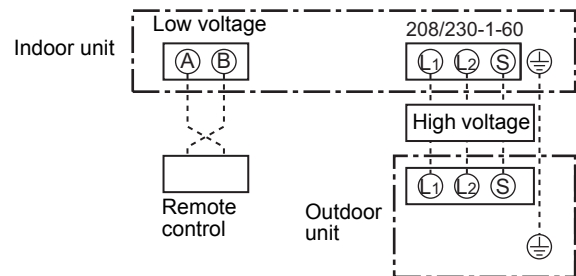

7 APPLICABLE CONTROLS

REQUIREMENT

- When you use this air conditioner for the first time, it takes approx. 5 minutes until the remote control becomes available after power-on. This is normal. **<When power is turned on for the first time after installation>** It takes **approx. 5 minutes** until the remote control becomes available.

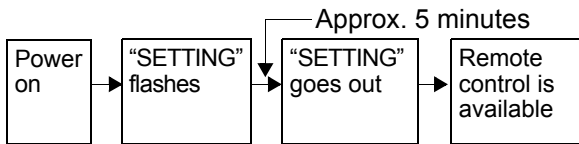

<When power is turned on for the second (or later) time>

It takes **approx. 1 minute** until the remote control becomes available.

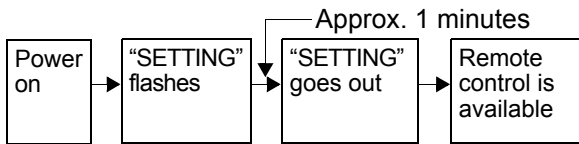

- Normal settings were made as factory default. Change the indoor unit settings as required.
- Use the wired remote control to change the settings.
- * The settings cannot be changed using the wireless remote control, sub remote control, or remote-controlless system (for central remote control only). Therefore, install the wired remote control to change the settings.

Changing applicable control setting

Basic procedure for changing settings

Change the settings while the air conditioner is not working.

(Be sure to stop the air conditioner before making settings.)

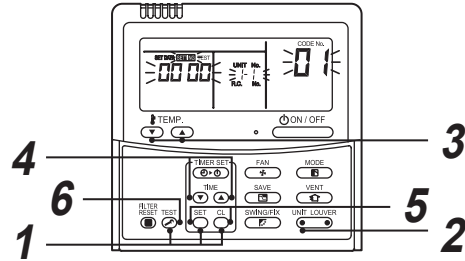

Procedure 1

When pushing **SET**, **CL**, and **TEST** buttons simultaneously for 4 seconds or more, after a while, the display part flashes as shown in the figure.

Check that the displayed CODE No. is [10].

- If the CODE No. indicates other than [10], push **TEST** button to erase the display, and then retry the operation from the first step. (For some time after **TEST** button has been pushed, the operation of the remote control cannot be accepted.)
- (In a group control, the firstly displayed indoor UNIT No. becomes the master unit.)

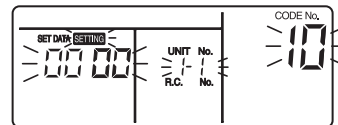

(* Display content varies with the indoor unit model.)

Procedure 2

Every pushing **UNIT LOUVER** button, the indoor UNIT No. in the group control is displayed successively. Select an indoor unit of which setup to be changed. In this time, the position of the indoor unit of which setup to be changed can be confirmed because the fan and the louver of the selected indoor unit work.

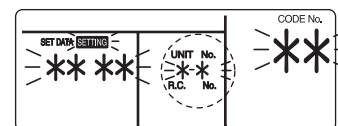

Procedure 3

Using temp. setup **▼** / **▲** buttons, specify CODE No. [**].

Procedure 4

Using timer time **▼** / **▲** buttons, select SET DATA [****].

Procedure 5

Push **SET** button. In this time, if the display changes from flashing to lighting, the setup completes.

- To change the setup of an indoor unit other than the selected one, start operation from Procedure 2.
- To change the setup of another setup in the selected indoor unit, start operation from Procedure 3.

Pushing **CL** button clears the set up contents which have been already set. In this case, retry from Procedure 2.

Procedure 6

When settings have been completed, push **TEST** button to determine the settings.

When **TEST** button is pushed, "SETTING" flashes and then the display content disappears and the air conditioner enters the normal stop mode.

(While "SETTING" is flashing, no operation of the remote control is accepted.)

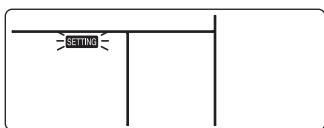

Installation to high ceiling

When the height of the ceiling to be installed exceeds 3.5 m (11'6"), adjustment of fan speed is necessary. Set up the high ceiling.

- Set according to the basic operation procedure (1 → 2 → 3 → 4 → 5 → 6).
- Item code in Procedure specifies [5d].
- Select [SET DATA] in Procedure from "List of installable ceiling height" in this Manual.
- For the item code in Procedure 3, specify [5d].
- For the SET DATA in Procedure 4, select the setup data of static pressure to be set up from the table on the right.

(Exchange by wired remote control)

SET DATA		
0000	Standard (Factory default)	11'6" (3.5 m) or less
0001	High static pressure 1	more than 11'6" (3.5 m) up to 13'1" (4.0 m)

Using wireless remote control

Change the high ceiling setting with the DIP switch on the P.C. board of the signal receiving part. Refer to the installation manual of the wireless remote controller kit for the details.

High ceiling setting can be changed by arranging the jumper block on the indoor unit micro computer P.C. board as shown in the table below as well.

* However, once the setting is changed, it is necessary to reset the setting back to 0000 that placing the jumper block back to the factory default position and rewriting the setting data back to 0000 with wired remote control (sold separately). (The setting can be changed to 0001, 0003 and 0006 without resetting.)

- Select by exchange of jumper block on indoor microcomputer P.C. board.

jumper block position	SET DATA	Note
	0000	Standard filter (Factory default)
	0001	High static pressure 1

- Jumper block position (CN112, CN111, CN110 from the left)

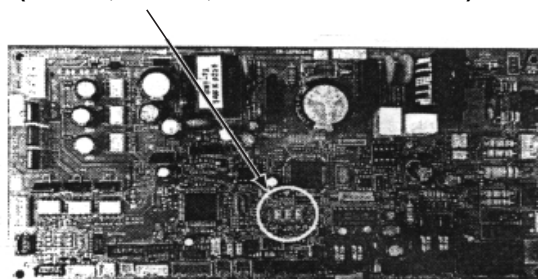

■ Filter sign setting

According to the installation condition, the lighting time of the filter sign (Notification of filter cleaning) can be changed.

Follow to the basic operation procedure (1 → 2 → 3 → 4 → 5 → 6).

- For the CODE No. in Procedure 3, specify [01].
- For the [SET DATA] in Procedure 4, select the setup data of filter sign lighting time from the following table.

Setup data	Filter sign lighting time
0000	None
0001	150H
0002	2500H (Factory default)
0003	5000H
0004	10000H

■ To secure better effect of heating

When it is difficult to obtain satisfactory heating due to installation place of the indoor unit or structure of the room, the detection temperature of heating can be raised. Also use a circulator, etc. to circulate heat air near the ceiling.

Follow to the basic operation procedure (1 → 2 → 3 → 4 → 5 → 6).

- For the CODE No. in Procedure 3, specify [06].
- For the SET DATA in Procedure 4, select the setup data of shift value of detection temperature to be set up from the table below.

Setup data	Detection temp shift value
0000	No shift
0001	+1.8 °F (+1 °C)
0002	+3.6 °F (+2 °C) (Factory default)
0003	+5.4 °F (+3 °C)
0004	+7.2 °F (+4 °C)
0005	+9.0 °F (+5 °C)
0006	+10.8 °F (+6 °C)

■ Group control

Group control for system of multiple units

One remote control can control maximum 8 indoor units as a group.

▼ Group control in single system

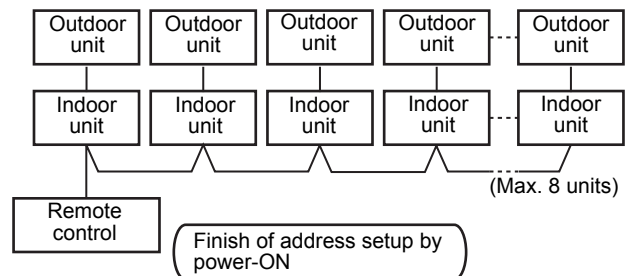

- For wiring procedure and wiring method of the individual line (Identical refrigerant line) system, follow to “Electric work”.
- Wiring between lines is performed in the following procedure.
Connect the terminal block (A/B) of the indoor unit connected with a remote control to the terminal blocks (A/B) of the indoor units of other indoor units by wiring the inter-unit wire of the remote control.
- When the power supply has been turned on, the automatic address setup starts and “” display which indicates that address is being set up flashes on the display part. During setup of automatic address, the remote control operation is not accepted.

Required time up to the finish of automatic addressing is approx. 5 minutes.

NOTE

In some cases, it is necessary to change the address manually after setup of the automatic address according to the system configuration of the group control.

Procedure example 1

Manual address setup procedure

While the operation stops, change the setup.
(Be sure to stop the operation of the unit.)

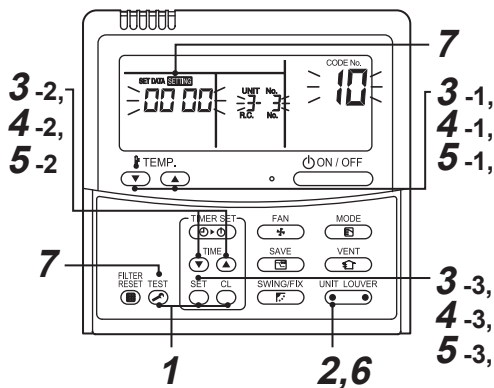

Procedure 1

Push simultaneously **SET** + **CL** + **TEST** buttons for 4 seconds or more. After a while, the display part flashes as shown below. Check the displayed CODE No. is [10].

- When the CODE No. is other than [10], push **TEST** button to erase the display and repeat procedure from the first step.
(After pushing **TEST** button, operation of the remote control is not accepted for approx. 1 minute.)
(For a group control, No. of the firstly displayed indoor unit becomes the header unit.)

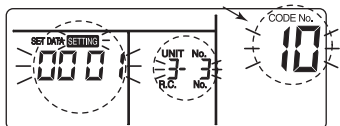

(* Display changes according to the model No. of indoor unit.)

Procedure 2

Every pushing **UNIT LOUVER** button, the indoor UNIT No. in the group control is displayed in order. Select the indoor unit of which setup is changed.

In this time, the position of the indoor unit of which setup is changed can be confirmed because fan and louver of the selected indoor unit operate.

Procedure 3

1. Using temp. setup **▼** / **▲** buttons, specify CODE No. [12].
(CODE No. [12]: Line address)
2. Using timer time **▼** / **▲** buttons, change the line address from [3] to [2].
3. Push **SET** button.
In this time, the setup finishes when the display changes from flashing to lighting.

Indoor UNIT No. before setup change is displayed.

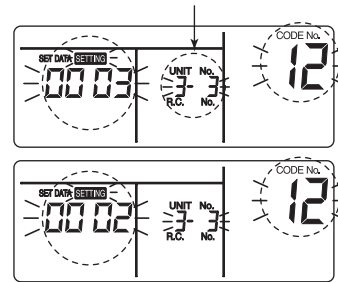

Procedure 4

1. Using temp. setup **▼** / **▲** buttons, specify CODE No. [13].
(CODE No. [13]: Indoor address)
2. Using timer time **▼** / **▲** buttons, change the indoor address from [3] to [2].
3. Push **SET** button.
In this time, the setup finishes when the display changes from flashing to lighting.

Indoor UNIT No. before setup change is displayed.

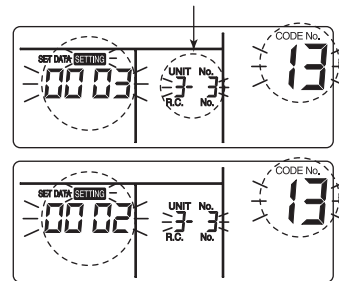

Procedure 5

1. Using temp. setup **▼** / **▲** buttons, specify CODE No. [14].
(CODE No. [14]: Group address)
2. Using timer time **▼** / **▲** buttons, change the setup data from [0001] to [0002].
(Setup data [Header unit: 0001] [Follower unit: 0002])
3. Push **SET** button.
In this time, the setup finishes when the display changes from flashing to lighting.

Indoor UNIT No. before setup change is displayed.

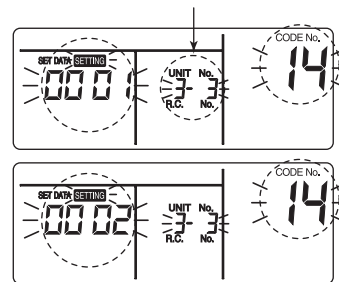

Procedure 6

If there is other indoor unit to be changed, repeat procedure 2 to 5 to change the setup.

When the above setup has finished, push to select the indoor UNIT No. before change of setup, specify CODE No. [12], [13], [14] in order with temp. setup / buttons, and then check the changed contents.

Address change check Before change: [3-3-1] → After change: [2-2-2]

Pushing button clears the contents of which setup was changed. (In this case, procedure from 2 is repeated.)

Indoor UNIT No. before setup change is displayed.

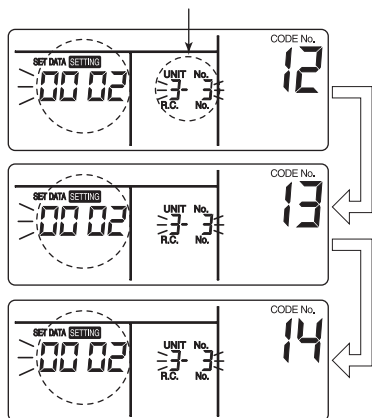

Procedure 7

After check of the changed contents, push button. (Setup is determined.) When pushing button, the display disappears and the status becomes the usual stop status. (When pushing button the operation from the remote control is not accepted for approx. 1 minute.)

* If the operation from the remote control is not accepted even 1 minute or more passed after pushing button, it is considered that the address setup is incorrect. In this case, the automatic address must be again set up. Therefore repeat procedure of the setup change from the Procedure 1.

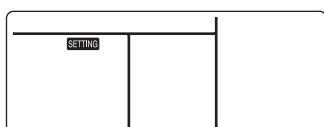

To recognize the position of the corresponding indoor unit though the indoor UNIT No. is known

Check the position during operation stop. (Be sure to stop operation of the set.)

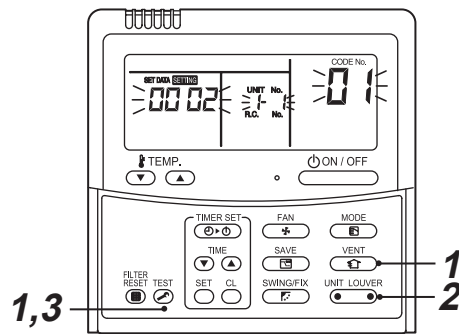

Procedure 1

Push simultaneously + buttons for 4 seconds or more.

After a while, the display part flashes and the display appears as shown below.

In this time, the position can be checked because fan and louver of the indoor unit operate.

- For the group control, the indoor UNIT No. is displayed as [ALL] and fans and louvers of all the indoor units in the group control operate.

Check the displayed CODE No. is [01].

- When the CODE No. is other than [01], push button to erase the display and repeat procedure from the first step. (After pushing button, operation of the remote control is not accepted for approx. 1 minute.)

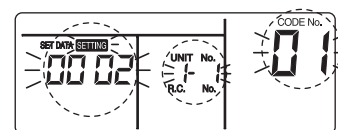

(* Display changes according to the model No. of indoor unit.)

Procedure 2

In the group control, every pushing button, the indoor UNIT No. in the group control is displayed in order.

In this time, the position of the indoor unit can be confirmed because only fan of the selected indoor unit operate.

(For a group control, No. of the firstly displayed indoor unit becomes the header unit.)

Procedure 3

After confirmation, push button to return the mode to the usual mode.

When pushing button, the display disappears and the status becomes the usual stop status.

(When pushing button the operation from the remote control is not accepted for approx. 1 minute.)

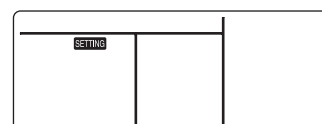

Remote control switch monitoring function

This function is available to call the service monitor mode from the remote control during a test run to acquire temperatures of sensors of the remote control, indoor unit, and outdoor unit.

1. Push **CL** and **TEST** buttons simultaneously for at least 4 seconds to call the service monitor mode. The service monitor indicator lights up and the header indoor unit number is displayed first. CODE No. **00** is also displayed.
2. Pushing **TEMP.** (▼) (▲) buttons, select the number of sensor, etc. (CODE No.) to be monitored. (See the following table.)
3. Pushing **UNIT LOUVER** (left side of the button), select an indoor unit to be monitored. The sensor temperatures of indoor units and their outdoor unit in the control group are displayed.
4. Push **TEST** button to return to the normal display.

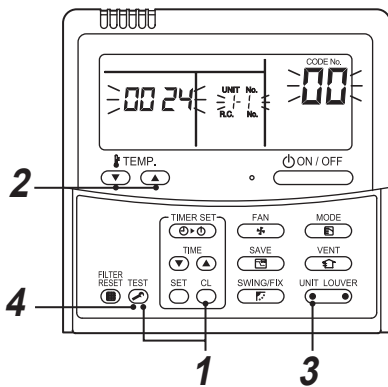

Outdoor unit data	
CODE No.	Data name
60	Outdoor unit heat exchanger temperature (TE)
61	Outside air temperature (TO)
62	Compressor discharge air temperature (TD)
63	Compressor intake air temperature (TS)
64	—
65	Heatsink temperature (THS)
6A	Operating current (x1/10)
F1	Compressor cumulative operating hours (x100h)

Indoor unit data	
CODE No.	Data name
01	Room temperature (remote control)
02	Indoor unit intake air temperature (TA)
03	Indoor unit heat exchanger temperature (TCJ)
04	Indoor unit heat exchanger temperature (TC)
F3	Indoor unit fan cumulative operating hours (x1 h)
F8	Indoor unit discharge air temperature

8 TEST RUN

Before test run

- Before turning on the circuit breaker, carry out the following procedure.
 - 1) Using 500V-megger, check 1MΩ or more exists between the terminal block L1 to L2 and the ground.
If 1MΩ or less is detected, do not run the unit. Do not apply to the remote control circuit.
 - 2) Check the valve of the outdoor unit being opened fully.
- To protect the compressor at activation time, leave power-ON for 12 hours or more before operating.

Execute a test run

Using the remote control, operate the unit as usual. For the procedure of the operation, refer to the attached Owner's Manual.
A forced test run can be executed in the following procedure even if the operation stops by thermo.-OFF. In order to prevent a serial operation, the forced test run is released after 60 minutes have passed and returns to the usual operation.

CAUTION

- Do not use the forced test run for cases other than the test run because it applies an excessive load to the devices.

Wired remote control

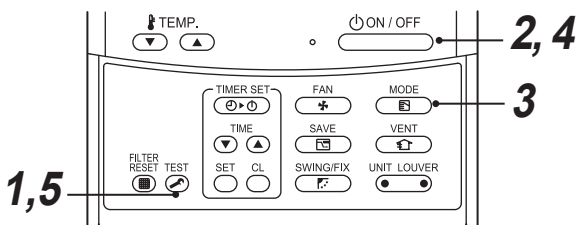

Procedure 1

Keep **TEST** button pushed for 4 seconds or more. [TEST] is displayed on the display part and the selection of mode in the test mode is permitted.

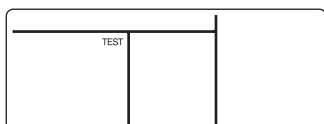

Procedure 2

Push **ON/OFF** button.

Procedure 3

Using **MODE** button, select the operation mode, [COOL] or [HEAT].

- Do not run the air conditioner in a mode other than [COOL] or [HEAT].
- The temperature controlling function does not work during test run.
- The detection of error is performed as usual.

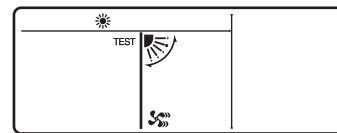

Procedure 4

After the test run, push **ON/OFF** button to stop a test run.

(Display part is same as procedure 1.)

Procedure 5

Push **TEST** check button to cancel (release from) the test run mode.

([TEST] disappears on the display and the status returns to a normal.)

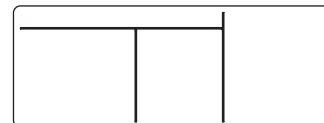

Wireless remote control

Procedure 1

Turn on the circuit breaker of the air conditioner. The operation is not accepted for 5 minutes when circuit breaker is turned on at first time after installation, and 1 minute when circuit breaker is turned on at the next time and after. After the specified time has passed, perform a test operation.

Procedure 2

Push "ON/OFF" button on the remote control, select [COOL] or [HEAT] with "MODE" button, and then select [HIGH] with "FAN" button.

Procedure 3

Cooling test run	Heating test run
Set the temperature to 64°F (18°C) with the temp. setup buttons.	Set the temperature to 86°F (30°C) with the temp. setup buttons.

Procedure 4

Cooling test run	Heating test run
After confirming a signal receiving sound "beep" immediately set the temperature to 66°F (19°C) with the temp. setup buttons.	After confirming a signal receiving sound "beep" immediately set the temperature to 84°F (29°C) with the temp. setup buttons.

Procedure 5

Cooling test run	Heating test run
After confirming a signal receiving sound "beep" immediately set the temperature to 64°F (18°C) with the temp. setup buttons.	After confirming a signal receiving sound "beep" immediately set the temperature to 86°F (30°C) with the temp. setup buttons.

Procedure 6

Repeat procedures **4** → **5** → **4** → **5**. Indicators "Operation" (green), "Timer" (green), and "Ready" (orange) in the wireless receiver section flash in approx. 10 seconds, and the air conditioner starts operation. If any of these indicators does not flash, repeat procedures **2** to **5**.

Procedure 7

Upon completion of the test run, push "ON/OFF" button to stop operation.

<Overview of test run operations using the wireless remote control>

▼ Cooling test run:

ON/OFF → 64 °F (18 °C) → 66 °F (19°C) → 64 °F (18°C) → 66 °F (19°C) → 64 °F (18°C) → 66 °F (19°C) → 64 °F (18°C) → (test run) → ON/OFF

▼ Heating test run:

ON/OFF → 86 °F (30°C) → 84 °F (29°C) → 86 °F (30°C) → 84 °F (29°C) → 86 °F (30°C) → 84 °F (29°C) → 86 °F (30°C) → (test run) → ON/OFF

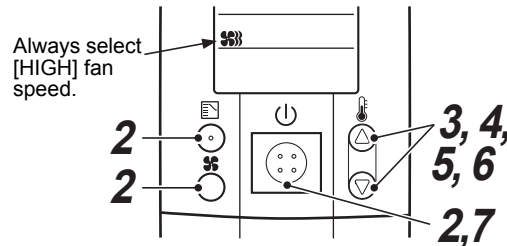

9 TROUBLESHOOTING

Confirmation and check

When a trouble occurred in the air conditioner, the check code and the indoor UNIT No. appear on the display part of the remote control.

The check code is only displayed during the operation. If the display disappears, operate the air conditioner according to the following "Confirmation of error history" for confirmation.

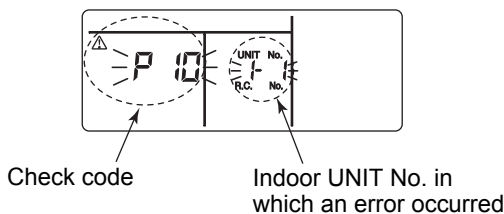

Confirmation of error history

When a trouble occurred on the air conditioner, the trouble history can be confirmed with the following procedure. (The trouble history is stored in memory up to 4 troubles.)

The history can be confirmed from both operating status and stop status.

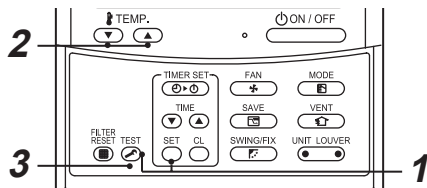

Procedure 1

When pushing **SET** and **TEST** buttons at the same time for 4 seconds or more, the following display appears.

If [Service check]  is displayed, the mode enters in the trouble history mode.

- [01: Order of trouble history] is displayed in CODE No. window.
- [Check code] is displayed in CHECK window.
- [Indoor unit address in which an error occurred] is displayed in Unit No..

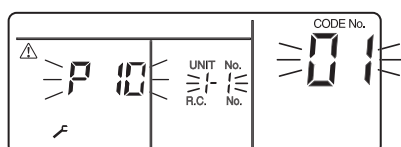

Procedure 2

Every pushing of **TEMP.** button used to set temperature, the trouble history stored in memory is displayed in order.

The numbers in CODE No. indicate CODE No. [01] (latest) → [04] (oldest).

REQUIREMENT

Do not push **CL** button because all the trouble history of the indoor unit will be deleted.

Procedure 3

After confirmation, push **TEST** button to return to the usual display.

1. Check the troubles according to the above procedure.
2. Ask an authorized dealer or qualified service (maintenance) professional to repair or maintain the air conditioner.

■ Check codes and parts to be checked

Wired remote control display	Wireless remote control Sensor block display of receiving unit				Main defective parts	Judging device	Parts to be checked / error description	Air conditioner status
	Indication	Operation GR	Timer GR	Ready OR				
E01	◎ ● ●				No header remote control	Remote control	Incorrect remote control setting --- The header remote control has not been set (including two remote controls).	*
					Remote control communication error		No signal can be received from the indoor unit.	
E02	◎ ● ●				Remote control transmission error	Remote control	System interconnection wires, indoor P.C. board, remote control --- No signal can be sent to the indoor unit.	*
E03	◎ ● ●				Indoor unit-remote control regular communication error	Indoor	Remote control, network adapter, indoor P.C. board --- No data is received from the remote control or network adapter.	Auto-reset
E04	● ● ◎				Indoor unit-outdoor unit serial communication error	Indoor	System interconnection wires, indoor P.C. board, outdoor P.C. board --- Serial communication error between indoor unit and outdoor unit	Auto-reset
					IPDU-CDB communication error			
E08	◎ ● ●				Duplicated indoor addresses ★	Indoor	Indoor address setting error --- The same address as the self-address was detected.	Auto-reset
E09	◎ ● ●				Duplicated header remote controls	Remote control	Remote control address setting error --- Two remote controls are set as header in the double-remote control control.	*
							(* The header indoor unit stops raising alarm and follower indoor units continue to operate.)	
E10	◎ ● ●				CPU-CPU communication error	Indoor	Indoor P.C. board --- Communication error between main MCU and motor microcomputer MCU	Auto-reset
E18	◎ ● ●				Header indoor unit-indoor follower unit regular communication error	Indoor	Indoor P.C. board --- Regular communication is not possible between header and follower indoor units or between twin header (main) and follower (sub) units.	Auto-reset
E31	● ● ◎				IPDU communication error	Outdoor	Communication error between IPDU and CDB	Entire stop
F01	◎ ◎ ●			ALT	Indoor unit heat exchanger sensor (TCJ) error	Indoor	Heat exchanger sensor (TCJ), indoor P.C. board --- Open-circuit or short-circuit of the heat exchanger sensor (TCJ) was detected.	Auto-reset
F02	◎ ◎ ●			ALT	Indoor unit heat exchanger sensor (TC) error	Indoor	Heat exchanger sensor (TC), indoor P.C. board --- Open-circuit or short-circuit of the heat exchanger sensor (TC) was detected.	Auto-reset
F04	◎ ◎ ○			ALT	Outdoor unit discharge temp. sensor (TD) error	Outdoor	Outdoor temp. sensor (TD), outdoor P.C. board --- Open-circuit or short-circuit of the discharge temp. sensor was detected.	Entire stop
F06	◎ ◎ ○			ALT	Outdoor unit temp. sensor (TE/TS) error	Outdoor	Outdoor temp. sensors (TE/TS), outdoor P.C. board --- Open-circuit or short-circuit of the heat exchanger temp. sensor was detected.	Entire stop
F07 (F06)	◎ ◎ ○			ALT	TL sensor error	Outdoor	TL sensor may be displaced, disconnected or short-circuited.	Entire stop
F08	◎ ◎ ○			ALT	Outdoor unit outside air temp. sensor error	Outdoor	Outdoor temp. sensor (TO), outdoor P.C. board --- Open-circuit or short-circuit of the outdoor air temp. sensor was detected.	Operation continued
F10	◎ ◎ ●			ALT	Indoor unit room temp. sensor (TA) error	Indoor	Room temp. sensor (TA), indoor P.C. board --- Open-circuit or short-circuit of the room temp. sensor (TA) was detected.	Auto-reset
F12 (F06)	◎ ◎ ○			ALT	TS sensor error	Outdoor	TS sensor may be displaced, disconnected or short-circuited.	Entire stop
F13 (L29)	◎ ◎ ○			ALT	Heat sink sensor error	Outdoor	Abnormal temperature was detected by the temp. sensor of the IGBT heat sink.	Entire stop
F15 (F06)	◎ ◎ ○			ALT	Temp. sensor connection error	Outdoor	Temp. sensor (TE/TS) may be connected incorrectly.	Entire stop
F29	◎ ◎ ●			SIM	Indoor unit, other P.C. board error	Indoor	Indoor P.C. board --- EEPROM error	Auto-reset

F31 (L29)	⊙ ⊙ ○	SIM	Outdoor unit P.C. board	Outdoor	Outdoor P.C. board ---- In the case of EEPROM error.	Entire stop
H01	● ⊙ ●		Outdoor unit compressor breakdown	Outdoor	Current detect circuit, power voltage --- Minimum frequency was reached in the current releasing control or short-circuit current (I _{dc}) after direct excitation was detected Wiring error of compressor (open phase)	Entire stop
H02	● ⊙ ●		Outdoor unit compressor lock	Outdoor	Compressor circuit --- Compressor lock was detected. Wiring error of compressor (open phase)	Entire stop
H03	● ⊙ ●		Outdoor unit current detect circuit error	Outdoor	Current detect circuit, outdoor unit P.C. board --- Abnormal current was detected in AC-CT or a phase loss was detected.	Entire stop
H04 (P04)	● ⊙ ●		Case thermostat operation	Outdoor	Malfunction of the case thermostat	Entire stop
H06	● ⊙ ●		Outdoor unit low-pressure system error	Outdoor	Current, high-pressure switch circuit, outdoor P.C. board --- P _s pressure sensor error was detected or low-pressure protective operation was activated.	Entire stop
L03	⊙ ● ⊙	SIM	Duplicated header indoor units ★	Indoor	Indoor address setting error --- There are two or more header units in the group.	Entire stop
L07	⊙ ● ⊙	SIM	Group line in individual indoor unit ★	Indoor	Indoor address setting error --- There is at least one group-connected indoor unit among individual indoor units.	Entire stop
L08	⊙ ● ⊙	SIM	Indoor group address not set ★	Indoor	Indoor address setting error --- Indoor address group has not been set.	Entire stop
L09	⊙ ● ⊙	SIM	Indoor power level not set	Indoor	Indoor power level has not been set.	Entire stop
L10 (L29)	⊙ ○ ⊙	SIM	Outdoor unit P.C. board	Outdoor	In the case of outdoor P.C. board jumper wire (for service) setting error	Entire stop
L20	⊙ ○ ⊙	SIM	LAN communication error	Network adapter central control	Address setting, central control remote control, network adapter --- Duplication of address in central control communication	Auto-reset
L29	⊙ ○ ⊙	SIM	Other outdoor unit error	Outdoor	Other outdoor unit error	Entire stop
					1) Communication error between IPDU MCU and CDB MCU	Entire stop
					2) Abnormal temperature was detected by the heat sink temp. sensor in IGBT.	
L30	⊙ ○ ⊙	SIM	Abnormal external input into indoor unit (interlock)	Indoor	External devices, outdoor unit P.C. board --- Abnormal stop due to incorrect external input into CN80	Entire stop
L31	⊙ ○ ⊙	SIM	Phase sequence error, etc.	Outdoor	Power supply phase sequence, outdoor unit P.C. board -- Abnormal phase sequence of the 3-phase power supply	Operation continued (thermostat OFF)
P01	● ⊙ ⊙	ALT	Indoor unit fan error	Indoor	Indoor fan motor, indoor P.C. board --- Indoor AC fan error (fan motor thermal relay activated) was detected.	Entire stop
P03	⊙ ● ⊙	ALT	Outdoor unit discharge temp. error	Outdoor	An error was detected in the discharge temp. releasing control.	Entire stop
P04	⊙ ● ⊙	ALT	Outdoor unit high-pressure system error	Outdoor	High-pressure switch --- The IOL was activated or an error was detected in the high-pressure releasing control using the TE.	Entire stop
P05 (P04)	⊙ ● ⊙	ALT	Open phase detected	Outdoor	The power cable may be connected incorrectly. Check open phase and voltages of the power supply.	Entire stop
P07	⊙ ● ⊙	ALT	Heat sink overheat	Outdoor	Abnormal temperature was detected by the temp. sensor of the IGBT heat sink.	Entire stop
P10	● ⊙ ⊙	ALT	Indoor unit water overflow detected	Indoor	Drain pipe, clogging of drainage, float switch circuit, indoor P.C. board --- Drainage is out of order or the float switch was activated.	Entire stop
P15 (L29)	⊙ ● ⊙	ALT	Gas leakage detected	Outdoor	There may be gas leakage from the pipe or connecting part. Check for gas leakage.	Entire stop
P19 (L29)	⊙ ● ⊙	ALT	4-way valve error	Outdoor (Indoor)	4-way valve, indoor temp. sensors (TC/TCJ) --- An error was detected due to temperature drop of the indoor unit heat exchanger sensor when heating.	Auto-reset (Auto-reset)
P20 (P04)	⊙ ● ⊙	ALT	High-pressure protective operation	Outdoor	High-pressure protection	Entire stop

P22	⊙ ● ⊙	ALT	Outdoor unit fan error	Outdoor	Outdoor unit fan motor, outdoor unit P.C. board --- An error (overcurrent, locking, etc.) was detected in the outdoor unit fan drive circuit.	Entire stop
P26	⊙ ● ⊙	ALT	Outdoor unit inverter Idc activated	Outdoor	IGBT, outdoor unit P.C. board, inverter wiring, compressor --- Short-circuit protection for compressor drive circuit devices (G-Tr/IGBT) was activated.	Entire stop
P29	⊙ ● ⊙	ALT	Outdoor unit position error	Outdoor	Outdoor unit P.C. board, high-pressure switch --- Compressor motor position error was detected.	Entire stop
P31	⊙ ● ⊙	ALT	Other indoor unit error	Indoor	Another indoor unit in the group is raising an alarm.	Entire stop
					E03/L07/L03/L08 alarm check locations and error description	Auto-reset

Check codes in parentheses () are displayed when connected to an outdoor unit other than the new SDI series.

○ : Lighting ⊙ : Flashing ● : OFF ★ : The air conditioner automatically enters the auto-address setting mode.

ALT: When two LEDs are flashing, they flash alternately. SIM: When two LEDs are flashing, they flash in synchronization.

Receiving unit display OR: Orange GR: Green

EH99864801

Free Manuals Download Website

<http://myh66.com>

<http://usermanuals.us>

<http://www.somanuals.com>

<http://www.4manuals.cc>

<http://www.manual-lib.com>

<http://www.404manual.com>

<http://www.luxmanual.com>

<http://aubethermostatmanual.com>

Golf course search by state

<http://golfingnear.com>

Email search by domain

<http://emailbydomain.com>

Auto manuals search

<http://auto.somanuals.com>

TV manuals search

<http://tv.somanuals.com>