

---

# TOSHIBA

TOSHIBA REMOTE RECEIPT PRINTER  
**TRST-A10 SERIES**

**Owner's Manual**



## Safety Summary

Personal safety in handling or maintaining the equipment is extremely important. Warnings and Cautions necessary for safe handling are included in this manual. All warnings and cautions contained in this manual should be read and understood before handling or maintaining the equipment.

Do not attempt to effect repairs or modifications to this equipment. If a fault occurs that cannot be rectified using the procedures described in this manual, turn off the power, unplug the machine, then contact your authorised TOSHIBA TEC representative for assistance.

### Meanings of Each Symbol



This symbol indicates warning items (including cautions). Specific warning contents are drawn inside the  $\Delta$  symbol. (The symbol on the left indicates a general caution.)



This symbol indicates prohibited actions (prohibited items). Specific prohibited contents are drawn inside or near the  $\odot$  symbol. (The symbol on the left indicates "no disassembling".)



This symbol indicates actions which must be performed. Specific instructions are drawn inside or near the  $\bullet$  symbol. (The symbol on the left indicates "disconnect the power cord plug from the outlet".)



### WARNING

This indicates that there is the risk of **death** or **serious injury** if the machines are improperly handled contrary to this indication.



**Any other than the specified AC voltage is prohibited.**

Do not use voltages other than the voltage (AC) specified on the rating plate, as this may cause **fire** or **electric shock**.

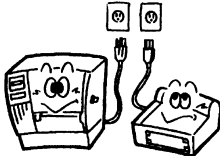

**Prohibited**

Do not plug in or unplug the power cord plug with wet hands as this may cause **electric shock**.

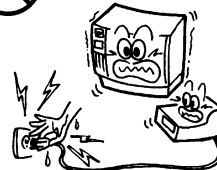

**Prohibited**

If the machines share the same outlet with any other electrical appliances that consume large amounts of power, the voltage will fluctuate widely each time these appliances operate. Be sure to provide an exclusive outlet for the machine as this may cause **fire** or **electric shock**.



**Prohibited**

Do not place metal objects or water-filled containers such as flower vases, flower pots or mugs, etc. on top of the machines. If metal objects or spilled liquid enter the machines, this may cause **fire** or **electric shock**.

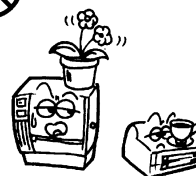

**Prohibited**

Do not insert or drop metal, flammable or other foreign objects into the machines through the ventilation slits, as this may cause **fire** or **electric shock**.

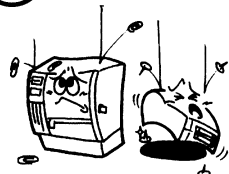

**Prohibited**

Do not scratch, damage or modify the power cords. Also, do not place heavy objects on, pull on, or excessively bend the cords, as this may cause **fire** or **electrical shock**.



**Disconnect the plug.**



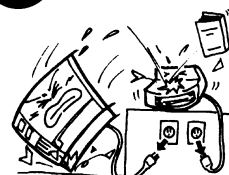



If the machines are dropped or their cabinets damaged, first turn off the power switches and disconnect the power cord plugs from the outlet, and then contact your authorised TOSHIBA TEC representative for assistance. Continued use of the machine in that condition may cause **fire** or **electric shock**.

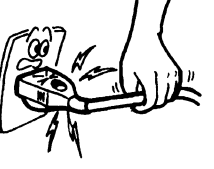

**Disconnect the plug.**

Continued use of the machines in an abnormal condition such as when the machines are producing smoke or strange smells may cause **fire** or **electric shock**. In these cases, immediately turn off the power switches and disconnect the power cord plugs from the outlet. Then, contact your authorised TOSHIBA TEC representative for assistance.

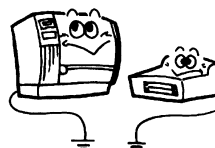

 <p><b>Disconnect the plug.</b></p> 	<p>If foreign objects (metal fragments, water, liquids) enter the machines, first turn off the power switches and disconnect the power cord plugs from the outlet, and then contact your authorised TOSHIBA TEC representative for assistance. Continued use of the machine in that condition may cause <b>fire</b> or <b>electric shock</b>.</p>	 <p><b>Disconnect the plug.</b></p> 	<p>When unplugging the power cords, be sure to hold and pull on the plug portion. Pulling on the cord portion may cut or expose the internal wires and cause <b>fire</b> or <b>electric shock</b>.</p>
 <p><b>Connect a grounding wire.</b></p> 	<p>Ensure that the equipment is properly grounded. Extension cables should also be grounded. <b>Fire</b> or <b>electric shock</b> could occur on improperly grounded equipment.</p>	 <p><b>No disassembling.</b></p> 	<p>Do not remove covers, repair or modify the machine by yourself. You may be <b>injured</b> by high voltage, very hot parts or sharp edges inside the machine.</p>



## CAUTION

This indicates that there is the risk of personal **Injury** or **damage** to objects if the machines are improperly handled contrary to this indication.

### Precautions

The following precautions will help to ensure that this machine will continue to function correctly.

- Try to avoid locations that have the following adverse conditions:
  - \* Temperatures out of the specification
  - \* Direct sunlight
  - \* High humidity
  - \* Shared power source
  - \* Excessive vibration
  - \* Dust/Gas
- The cover should be cleaned by wiping with a dry cloth or a cloth slightly dampened with a mild detergent solution. NEVER USE THINNER OR ANY OTHER VOLATILE SOLVENT on the plastic covers.
- USE ONLY TOSHIBA TEC SPECIFIED paper and ribbons.
- DO NOT STORE the paper or ribbons where they might be exposed to direct sunlight, high temperatures, high humidity, dust, or gas.
- Ensure the printer is operated on a level surface.
- Any data stored in the memory of the printer could be lost during a printer fault.
- Try to avoid using this equipment on the same power supply as high voltage equipment or equipment likely to cause mains interference.
- Unplug the machine whenever you are working inside it or cleaning it.
- Keep your work environment static free.
- Do not place heavy objects on top of the machines, as these items may become unbalanced and fall causing **injury**.
- Do not block the ventilation slits of the machines, as this will cause heat to build up inside the machines and may cause **fire**.
- Do not lean against the machine. It may fall on you and could cause **injury**.
- Care must be taken not to injure yourself with the printer paper cutter.
- Unplug the machine when it is not used for a long period of time.
- Place the machine on a stable and level surface.

### Request Regarding Maintenance

- Utilize our maintenance services.  
After purchasing the machine, contact your authorised TOSHIBA TEC representative for assistance once a year to have the inside of the machine cleaned. Otherwise, dust will build up inside the machines and may cause a **fire** or a **malfunction**. Cleaning is particularly effective before humid rainy seasons.
- Our preventive maintenance service performs the periodic checks and other work required to maintain the quality and performance of the machines, preventing accidents beforehand.  
For details, please consult your authorised TOSHIBA TEC representative for assistance.
- Using insecticides and other chemicals  
Do not expose the machines to insecticides or other volatile solvents. This will cause the cabinet or other parts to deteriorate or cause the paint to peel.

# TABLE OF CONTENTS

	Page
<b>1. PRODUCT OVERVIEW -----</b>	<b>1-1</b>
1.1 Introduction -----	1-1
1.2 Features -----	1-1
1.3 Applicable Model -----	1-2
<b>2. SPECIFICATIONS -----</b>	<b>2-1</b>
2.1 Printer -----	2-1
2.2 Receipt Roll -----	2-1
<b>3. APPEARANCE -----</b>	<b>3-1</b>
3.1 Front/Rear View -----	3-1
3.2 LED and Feed Button -----	3-1
3.3 Connectors -----	3-3
<b>4. SET UP PROCEDURE -----</b>	<b>4-1</b>
4.1 Requirements for Operation -----	4-1
4.2 Setting up the Printer -----	4-4
<b>5. INSTALLATION PROCEDURE -----</b>	<b>5-1</b>
5.1 Connecting the Power Cord and Interface Cable -----	5-1
5.2 Connecting the Drawer -----	5-4
5.3 Loading the Receipt Roll -----	5-4
5.4 Self Test Print -----	5-7
<b>6. GENERAL MAINTENANCE -----</b>	<b>6-1</b>
6.1 Cleaning -----	6-1
6.1.1 Cleaning the Print Head and Platen -----	6-1
6.1.2 Cleaning the Covers -----	6-1
6.2 Removing Jammed Paper -----	6-2
<b>7. TROUBLESHOOTING -----</b>	<b>7-1</b>

## **CAUTION!**

1. This manual may not be copied in whole or in part without prior written permission of TOSHIBA TEC.
2. The contents of this manual may be changed without notification.
3. Please refer to your local Authorized Service representative with regard to any queries you may have in this manual.

# 1. PRODUCT OVERVIEW

## 1.1 Introduction

Thank you for purchasing the TOSHIBA TRST-A10 Series Thermal Printer. This printer is a compact line thermal printer designed to be connected to a TOSHIBA POS terminal or used as a kitchen printer, etc. It prints both 80 mm-wide and 58 mm-wide receipts at the maximum print speed of 225mm/sec. The body colour is selectable from Fair White (SF) and Cool Black (SC) so that it is possible to coordinate the colour with the TOSHIBA POS terminal. The interface type is either RS232C I/F or USB I/F (V2.0 Full Speed). Also Parallel I/F is available as option.

This manual contains general set-up and maintenance information and should be read carefully to help gain the maximum performance and life from your printer. For most queries please refer to this manual and keep it safe for future reference.

## 1.2 Features

- Due to a paper drop-in mechanism, the paper replacement can be done by just dropping a new paper roll and closing the cover. This also makes the print head cleaning easy.
- This printer prints in thermal direct method at high speed (max. 225 mm/sec.) with less noise.
- As the paper outlet is provided in front of the printer, the receipt can be taken out easily, and flexible installation is possible.
- Print layout can be variously arranged.
- The power supply unit (AC adapter) is detachable from the printer.
- A drawer interface (1 ch) is provided.
- An automatic cutter is provided as standard. (Partial cut)
- Two body colors are available for you to color coordinate with the TOSHIBA POS terminal to be connected.
- User-defined characters and logos can be registered in the flash memory.

### 1.3 Applicable Model

**Model name description**

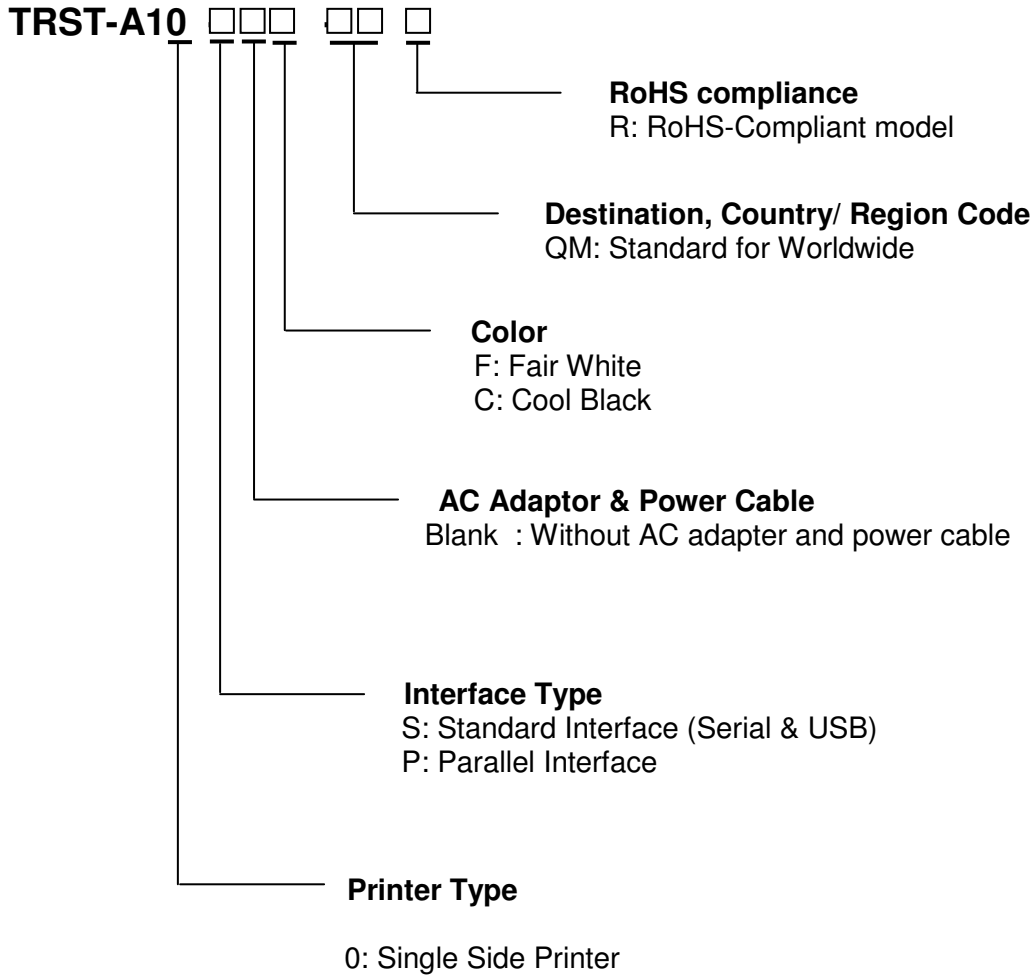

**NOTE:** Some combinations of the above specifications are not developed as products. For details, please refer to your nearest authorized TOSHIBA TEC representative.

## 2. SPECIFICATIONS

### 2.1 Printer

Item	Description
Printing method	Line thermal dot printing method
Printing width	80 mm (576 dots) 58 mm (432 dots)
Resolution	203.2 dpi x 203.2dpi
Printing speed Max.	9 ips max (225 mm/sec) for 75W, 55W mode
2 color printing	Max 50 mm/sec
Printing columns	<b>80 mm Paper</b> 48 Column (at 16.9 cpi Standard Character) 64 Column (at 22.6 cpi Compress Character) <b>58 mm Paper</b> 36 Column (at 16.9 cpi Standard Character) 48 Column (at 22.6 cpi Compress Character)
Character size	Font A: 1.5 x 3.00 mm Font B: 1.125 x 3.00 mm
Character types	Code pages PC437, PC850, PC852, PC857, PC858, PC860, PC863, PC865, PC866 and PC1252
Logo registration and print	User defined characters and logos are downloadable in the flash memory.
Line spacing	7.52 (default) and variable lines per inch.
Printable bar codes	UPC-A, UPC-E, JAN13 (EAN), JAN8 (EAN), Code 39, Code 128, Interleaf 2 of 5, Codabar, PDF417, Code 93
Cut method	Partial Cut
Paper	Thermal paper roll: 80 mm x dia. 83 mm (Max) Thermal paper roll: 58 mm x dia. 83 mm (Max)
Interface	RS232C I/F or USB I/F (V2.0 Full Speed). Parallel as Option.
Input buffer	4K bytes/128 bytes
Printer supply input voltage	DC 24V, 3.15A (75W)/ DC 24V, 2.29A (55W)
Power consumption	3.15A (75W Power Supply), 2.29A (55W Power Supply)
AC adapter specification	Rated input: AC 100 – 240V, 50/60Hz, 2.0A max Rated output: DC 24V, 3.15A (75W)
Body color	Fair White (F) or Cool Black (C)
Operating temperature	5°C to 50°C
Operating humidity	10% to 90% RH (no condensation)
Storage temperature	-20°C to 60°C
Storage humidity	10% to 90% RH (no condensation)
Weight	1.7 Kg
Dimension	145.5 mm (W) x 185.5 mm (D) x 141.0 mm (H)

2.2 Receipt Roll

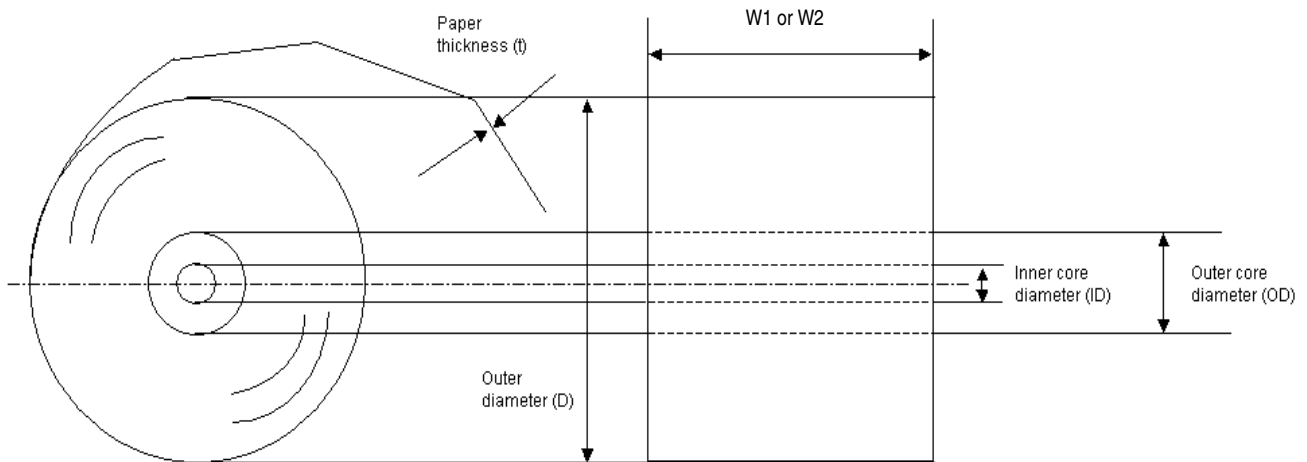

Paper type	Thermal paper rolled with the print side facing outside
Width (W1)	80 +/- 1.0 mm
Width (W2)	58 +0/- 1.0 mm (With optional 58 mm paper guide)
Outer diameter (D)	76 +/- 2.0 mm
Paper thickness (T)	0.065 +/- 0.005 mm
Weight	53 g/m <sup>2</sup>
Outer core diameter	21.5 mm
Inner core diameter	12.5 +/- 0.5 mm
Recommended thermal paper	Only paper rolled onto a core is acceptable, however, the paper end should not be pasted to the core. TOSHIBA TEC recommends using the following thermal paper for this product Manufacturer : NIPPON PAPER Type : TF50KS-E

**CAUTION!**

Use only paper which meets specified requirements. Use of non-specified paper may shorten the head life of the printer, resulting in problems with print quality, cause a paper feed failure or shorten the cutter life. All paper should be handled with care to avoid any damage to the paper. Read the following guideline carefully.

- Do not store the paper for longer than the manufacturer’s recommended shelf life.
- Store the paper in a cool, dry place. Avoid areas where they would be exposed to direct sunlight, high temperature, high humidity, dust or gas.
- A contact of chemical or oil may discolor or erase the printed record.
- Rubbing the paper hard with nail or hard object may discolor the paper.
- The paper end should not be pasted to the core.

For further information please contact your authorized TOSHIBA TEC representative or authorized paper manufacturer.



### 3. APPEARANCE

#### 3.1 Front/Rear View

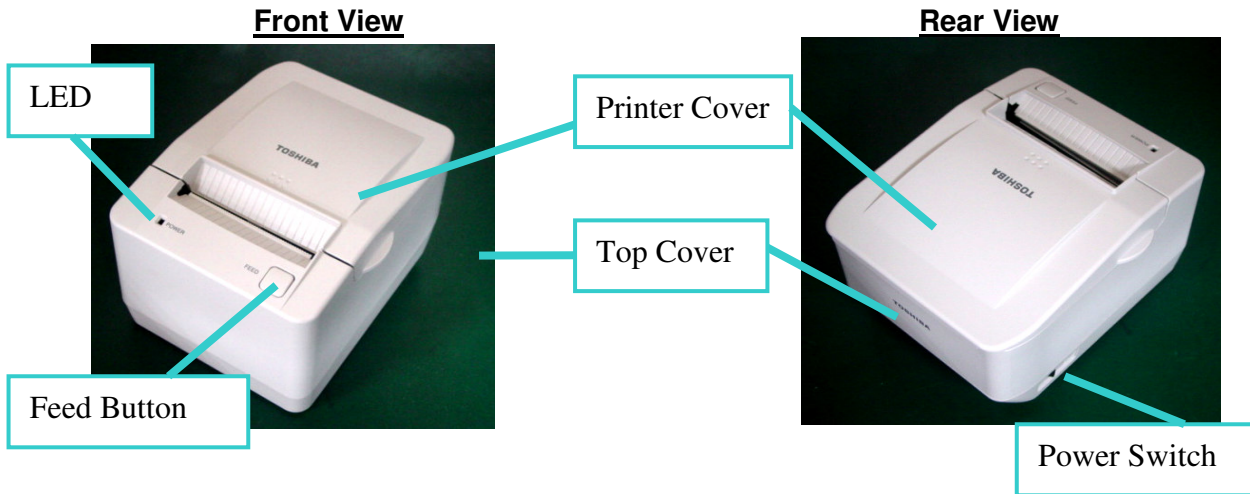

#### 3.2 LED and Feed Button

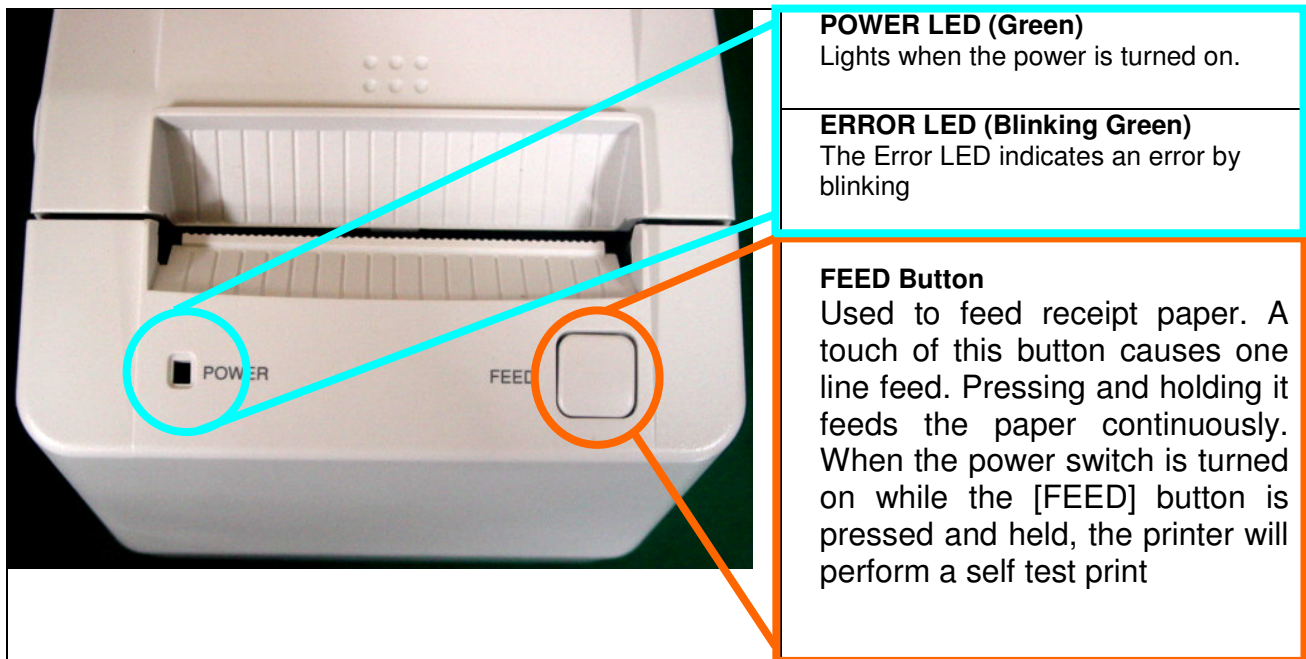

**Error Status Table****Green LED Blinking (Slow)**

<b>Problem</b>	<b>What to Do</b>	<b>Where to Go</b>
Receipt paper is low	There are about 4 ½ meters, ± 3 meters, (15 feet, ± 10 feet) of paper left. Change the paper soon to avoid running out of paper part way through a transaction.	See “Loading the Receipt Roll” in chapter 5.3.

**Green LED Blinking (Fast)**

<b>Problem</b>	<b>What to Do</b>	<b>Where to Go</b>
Receipt paper is out	Change the paper now. Do not run a transaction without paper as the data may be lost.	See “Loading the Receipt Roll” in chapter 5.3.
Receipt cover is open	Close the cover. The printer will not operate with the cover open.	
Knife failure	Open the receipt cover and check the knife. Clear any jammed paper you can see. Tear off any excess paper against the tear-off blade.	

**NOTE:** *If other LED status except for the above occurs, turn the power off, and then on. If this does not restore the LED, contact your nearest TOSHIBA TEC representative for assistance.*

### 3.3 Connectors

**CAUTION!**

1. The drawer interface connector is exclusively for connecting the drawer. Do not connect a phone line or any other cables than the drawer cable to this connector. Doing so may cause a failure of the phone line and this printer.
2. To the DC24V connector (socket connector), do not connect anything other than the built-in AC adapter.
3. The built-in AC adapter is exclusively for this printer. Do not use it for any other machines.

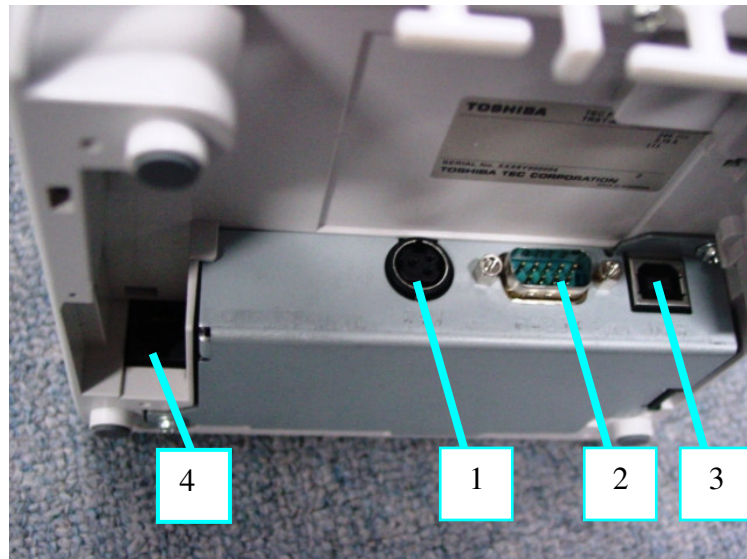
**1 [DC24V] (Socket connector)**

The built-in AC adapter supplies +24V power to the printer through this connector. Do not connect anything other than the TOSHIBA TEC Specified AC adapter.

**2 [Serial interface connector]**

An interface cable which connects the printer to a POS terminal or Personal Computer is connected to this connector. A RS-232C interface cable (Serial I/F model) is needed for this connector.

**3 [USB interface connector]**

An interface cable which connects the printer to a POS terminal or Personal Computer is connected to this connector. A USB I/F (V2.0 Full Speed) is needed for this connector.

**4 [Drawer interface Connector] [CDKO] (6 pin modular connector)**

A drawer cable which connects the printer to a drawer is connected to this connector. To this connector, a TOSHIBA drawer can be connected. Do not connect anything other than the connectable drawer.

**Note:** For connectable drawers, refer to your nearest authorized TOSHIBA TEC representative.

---

## 4. SET UP PROCEDURE

### 4.1 Requirements for Operation

This printer has the following requirements:

#### Serial Interface Type

- The TOSHIBA POS terminal or Personal Computer to be connected must have a serial port.
  - To communicate with the TOSHIBA POS terminal or Personal Computer, an RS-232C interface cable is required.  
RS-232C cable..... 9 pins

#### USB Interface Type

- The TOSHIBA POS terminal or Personal Computer to be connected must have a USB port.
- To communicate with the TOSHIBA POS terminal or Personal Computer, a USB cable is required.

#### Parallel Interface Type (Option)

- The TOSHIBA POS terminal to be connected must have a Centronics parallel port.
- To communicate with the TOSHIBA POS terminal, a Centronics interface cable is required.  
Centronics cable ..... 36 pins.

#### Interface Cables

For the serial interface model, use the RS-232C cable which satisfies the following pin configuration and the specification of the connector. For the USB interface model, use the USB cable which satisfies the following pin configuration and the specification of the connector. For the Parallel interface model (Option), use the Parallel cable which satisfies the following pin configuration and the specification of the connector.

To prevent the emission and receipt of electrical noise, the interface cable must meet the following requirements:

- Fully shielded and fitted with metal or metalized connector housings.
- Kept as short as possible.
- Should not be tightly bundled with the power cord.
- Should not be tied to power line conduits.

RS-232C cable pin configuration

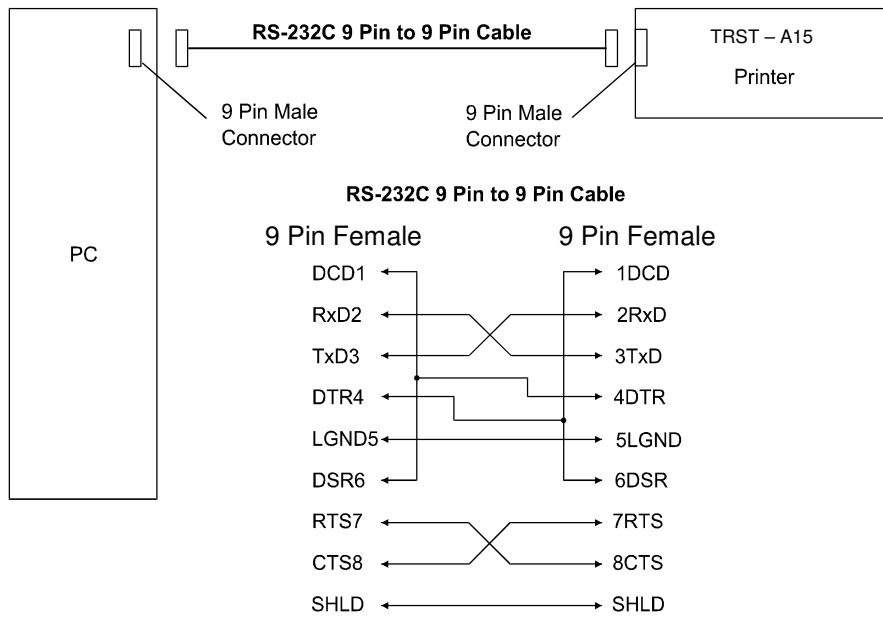

USB cable connector

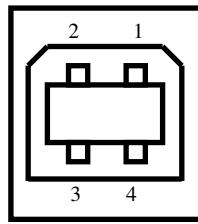

Printer View End

Parallel Interface Type (Option)

IEEE 1284-B receptacle

PIN No.	Signal
1	/STROBE
2-9	PD1-8
10	/ACK
11	BUSY
12	PERROR
13	SELECT
14	/AUTOFD
31	/INIT
32	/FAULT
36	/SELECTIN
19-30	GND
15-18	N.C.
33-35	N.C.

### 4.2 Setting up the Printer

**CAUTION!**

1. Place the printer on a flat, stable surface.
2. Do not place the printer close to a heater or where it may be exposed to direct sunlight.
3. Avoid locations where the printer may be exposed to high temperature, high humidity or dust.
4. Care must be taken that no condensation occurs in the printer. If it should, however, do not turn ON the power until the condensation is dried.
5. Use a grounded electrical outlet. Do not use an adapter plug.
6. Be sure that there is adequate room around the printer for easy operation and maintenance.
7. Keep your work environment static free.

- 1) Make sure that the printer power is turned OFF.
- 2) Connect the interface cable to the printer.
- 3) Insert the power cord into the AC inlet.
- 4) Connect the interface cable to a TOSHIBA POS terminal, and plug in the power cord to the AC outlet.
- 5) If a drawer is desired to be connected, connect the drawer interface cable to the printer.
- 6) Secure the drawer ground wire to the ground terminal on the rear of the printer.
- 7) Turn the printer power ON.
- 8) Open the printer cover.
- 9) Load the receipt roll into the printer.
- 10) Close the printer cover. One receipt will be automatically issued.
- 11) Check the print quality by performing a self test print.

Now the printer is ready for printing.

**NOTES:**

1. For details of the above Steps 1) to 4), refer to Section **5.1 Connecting the Power Cord and Cables**.
2. Steps 5) and 6) are the procedures of the drawer connection. For details of Steps 5) and 6), refer to Section **5.2 Connecting the Drawer**.
3. For details of Steps 8) to 10), refer to Section **5.3 Loading the Receipt Roll**.
4. For details of Step 11), refer to Section **5.4 Self Test**.

---

## 5. INSTALLATION PROCEDURE

**WARNING!**

1. Since the power cord and the interface cable are not provided with this unit, please locally purchase ones which meet the specifications. For detail specifications, please contact your nearest authorized TOSHIBA TEC representative.
2. Before connecting the power cord and cables to the printer, turn the power of the POS terminal and printer OFF.
3. Do not pull the power cord hard. Doing this may damage the power cord, causing fire, electric shock, or broken wire.
4. When it thunders, unplug the power cord. Lightning stroke may cause fire or electric shock.
5. Keep the power cord away from a heater. The cover of the power cord may be melted, causing fire or electric shock.
6. Do not connect the power cord to the AC outlet provided on the POS terminal such as ST-5600, ST-5500, etc.
7. Do not use the AC adaptor other than TOSHIBA TEC specified AC adaptor "KIT-A10-ACA-QM-R"

**CAUTION!**

1. When separating the AC adapter, please contact your authorized TOSHIBA TEC representative.
2. The built-in AC adapter is exclusively for this printer. Do not use it for any other machines.
3. The AC adapter can be used indoors only. Never use it outdoors.
4. Be sure to unplug the printer when it is not used for a long time.
5. Do not share the power source with other electric appliances which generate noise.



## 5.1 Connecting the Power Cord and Interface Cable

**CAUTION!**

1. Be sure to hold the connector when plugging in or unplugging the AC adapter cable.
2. Insert the AC adapter cable and the power cord firmly.
3. Refer to "Important Information to the User"

- 1) Turn the printer power OFF.
- 2) Insert the power cord into the AC inlet.

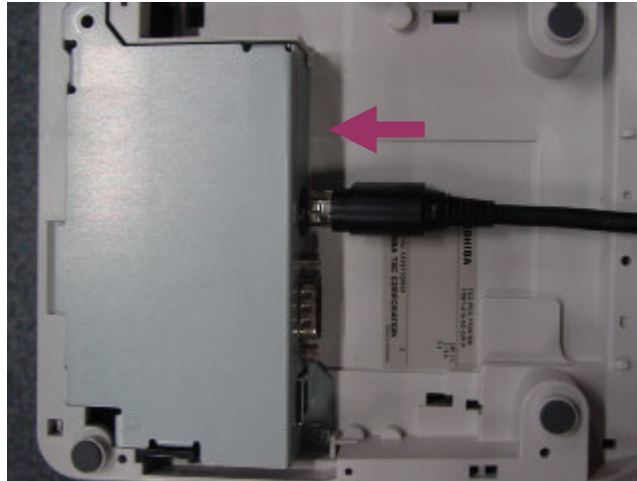

- 3) Connect and secure the interface cable to the interface connector in the correct orientation.  
Serial interface: Secure the connector with the screws.  
USB interface: Securely insert the connector until a positive click is heard.  
Parallel interface: Secure the connector with the locking tabs.

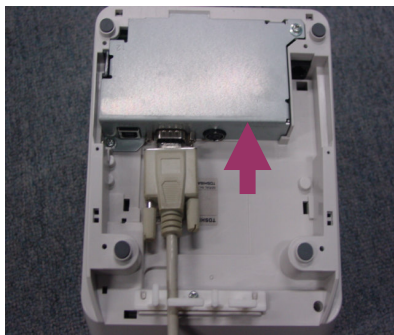

[Serial Interface Connector]

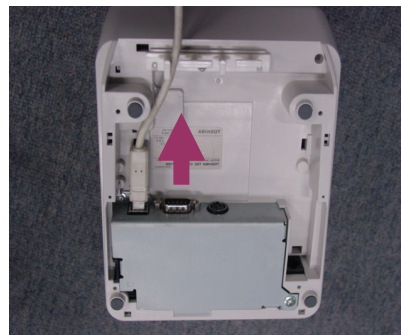

[USB Interface Connector]

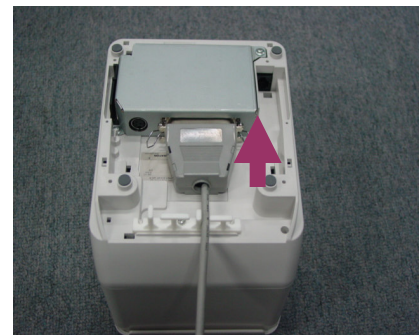

[Parallel Interface Connector]

- 4) Connect the interface cable to the TOSHIBA POS terminal or Personal Computer, and then plug in the power cord to the AC outlet.

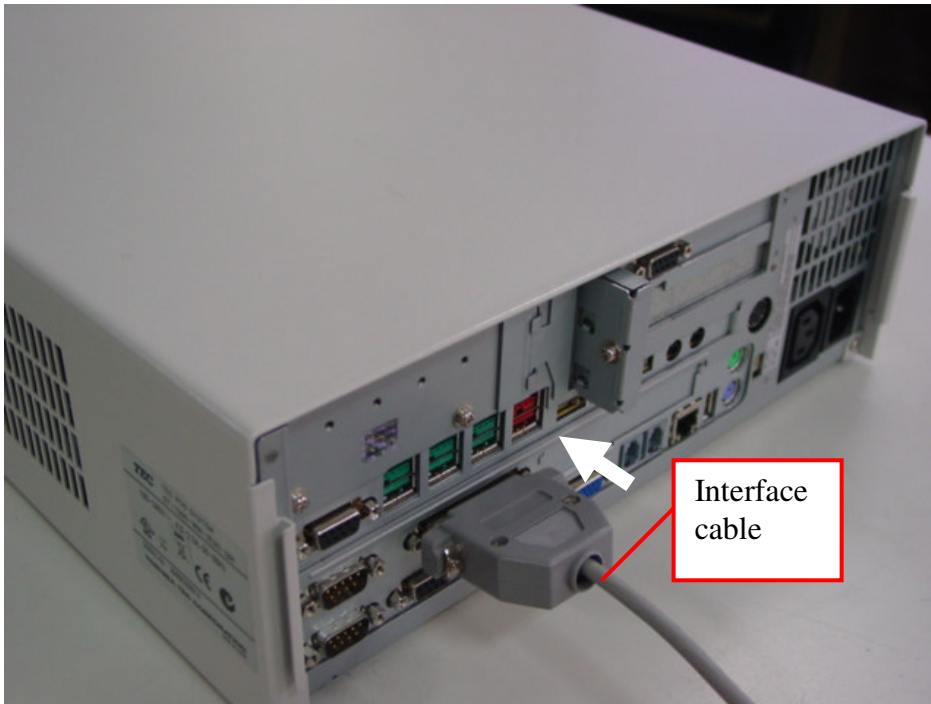

## 5.2 Connecting the Drawer

- 1) Turn the printer power OFF.
- 2) Connect the drawer cable to the drawer interface connector in the correct orientation.

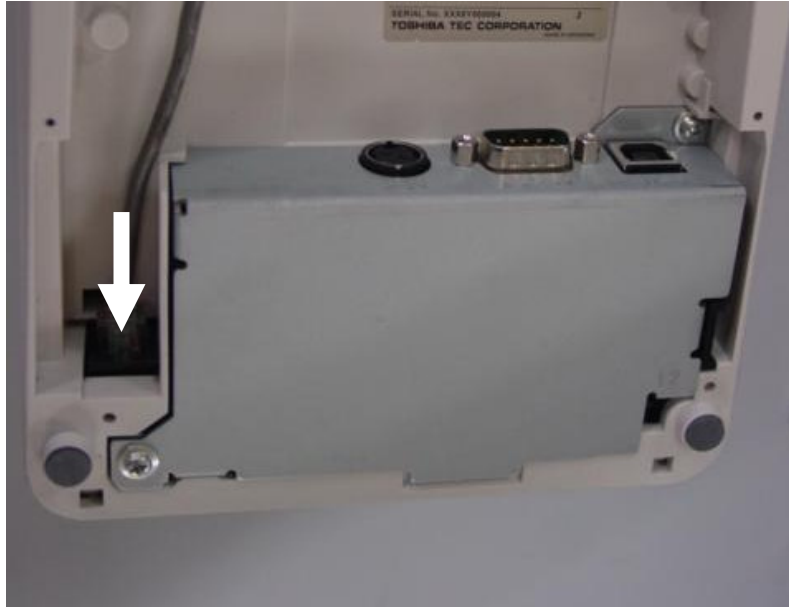

### **[Drawer interface connector] (6-pin modular connector)**

A Drawer cable which connects the printer to a drawer is connected to this connector. To this connector, a TOSHIBA drawer can be connected. Do not connect anything other than the connectable drawer.



NOTE: *For connectable drawers, refer to your nearest authorized TOSHIBA TEC representative.*

### **[Ground terminal] (6-pin modular connector)**

The drawer interface cable's ground wire is secured to this terminal.

### 5.3 Loading the Receipt Roll

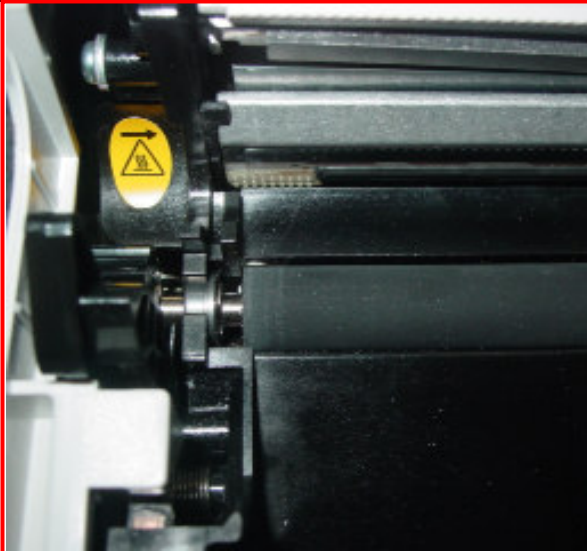
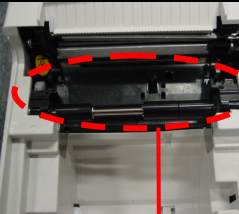
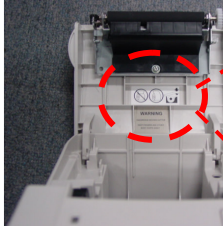
When you use this printer for the first time or when the receipt paper has been used up, load a receipt roll in the following procedures while the printer power is set to ON. A thermal printer prints thermal receipt paper by applying heat to the paper to react with the chemicals on the paper surface. A red line which appears on the reverse side of the receipt paper indicates that the paper is almost used up.

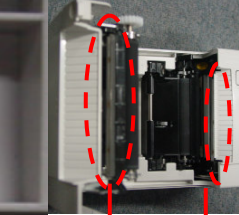
<b>WARNING!</b>			
		 <p style="text-align: center; border: 1px solid red; padding: 2px;">Print Heads</p>	<p>The print head becomes very hot while printing. Never touch the print head to avoid getting burned.</p>
		 <p style="text-align: center; border: 1px solid red; padding: 2px;">Cutter Blades</p>	<p>Hazardous moving cutter. Keep fingers and other body parts away</p>
<p>Standard operating temperature of printer is 5°C to 50°C. Please do not operate out of range for safe operation.</p>			

- 1) Turn the printer power ON.
- 2) Hold the raised sides firmly and lift upwards to unhook the printer cover. (1)
- 3) Hold both sides of the printer cover and open it until it stops. (2)
- 4) Check for the correct orientation of the receipt roll, and put it into the paper holder. Pull the receipt until it extends past the paper outlet for about 5 cm (3), and then close the printer cover by pressing it's front center gently until a positive lock is felt.

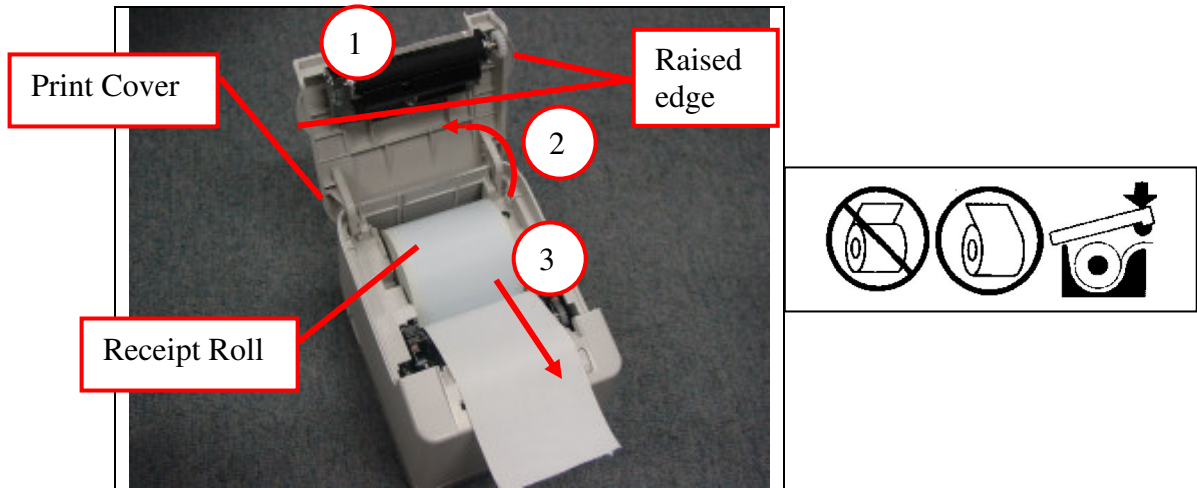
**CAUTION!**

1. Use only TOSHIBA TEC specified paper. Use of non-specified paper may shorten the print head life resulting in problems with print quality, cause a paper feed failure, or shorten the cutter life.
2. Do not subject the thermal receipt roll to water, oil, or heat source as this will darken the paper.
3. Load the receipt roll in the correct orientation. Failure to do this may cause a paper jam error.
4. Care must be taken not to damage the print head and platen when the printer cover is opened as this may cause a poor print or a printer failure.
5. Do not open the printer cover while the printer is printing.
6. Do not hold the receipt while the printer is printing. Doing so may cause a paper jam.
7. When closing the printer cover, do not press it down too hard.
8. Do not put anything on the printer cover or push the cover too strongly. Doing so may cause a print failure.

## 5.4 Self Test Print

To perform the printer self test, use the Mfg Adjustment menu feature. This feature prints instructions on the receipt for selecting any type of print pattern needed.

### CAUTION!

Be extremely careful when changing any of the printer settings to avoid changing other settings that might affect the performance of the printer.

1. Set DIP switch 1 to ON, DIP switch 2 to ON.

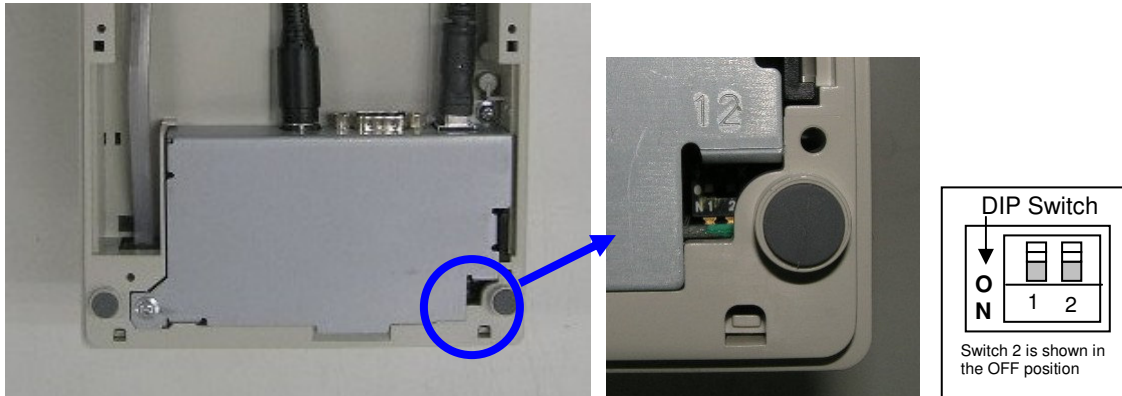

2. Power on the printer while holding the Paper Feed Button. The printer will print the Current Setting Form, then cuts the paper to print the Mfg Adjustment Menu.
3. If you do not hold the Paper Feed Button while power up the printer, it will go to Online Mode.

This menu allows you to print different test patterns  
Selections are made using the Paper Feed Button.

===== Mfg Adjustment Menu =====

Select a sub-menu:

EXIT	> 1 Click
Rolling ASCII Print	> 2 Clicks
H Print Test	> 3 Clicks
Duty Check Print	> 4 Clicks
Print Current Setting	> 5 Clicks
EEPROM to Default Setting	> 6 Clicks

Enter code then hold Button DOWN  
at least 1 second to validate

**Rolling ASCII print test (Receipt)**

This option let you run rolling ASCII printing test. The printer prints the resident character set in standard pitch continuously. When Rolling ASCII Print (Rcpt) is selected, printer prints the following menu. After selection of the printing side, test print will start.

Press the Paper Feed Button to stop the test.

Rolling ASCII  
Stop and exit test > Long Click

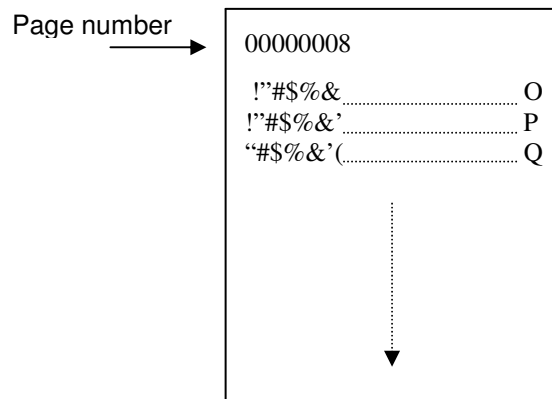

**H print test (Receipt)**

This option let you run H printing test. The printer prints the 'H' character in standard pitch continuously. When H Print Test (Rcpt) is selected, printer prints the following menu. After selection of the printing side, test print will start. Press the Paper Feed Button to start or stop the test.

Press the Paper Feed Button to stop the test.

H Print test  
Stop and exit test                   -> Long Click

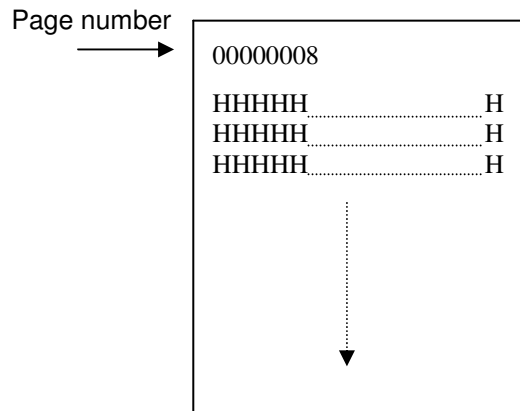



**Duty check print test (Receipt)**

This option let you run duty check printing test. The printer prints the 12.5%, 25%, 50% and 100% duty original pattern. When Duty Check Print (Rcpt) is selected, printer prints the following menu. After selection of the printing side, test print will start.

Press the Paper Feed Button to start or stop the test.

Press the Paper Feed Button to continue or stop the test.

Duty Check Print  
Stop and exit test    Short Click  
Continue test        Long Click

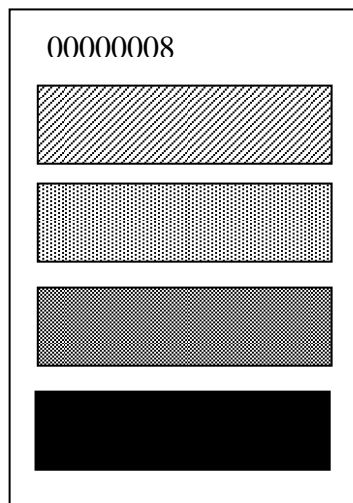

**Print current setting**

This option let you print current setting on receipt.  
Press the Paper Feed Button to start the test.

**\*\* START CURRENT SETTING PRINTING?**

Return Main Menu > Short Click  
Start Printing > Long Click

**Note:** Press the Paper Feed Button for at least one second to validate the selection.

**\*\*\* Current Setting Form \*\*\***

Model number : TRST-A10  
Serial number : 12345678901

**Boot Firmware**

Version : V00.02  
Revision : 00  
CRC : DEEB

**Flash Firmware**

Version : V00.06  
Revision : 00  
CRC : 6696

**SBCS**

Version : V00.01  
Revision : 00

## 6. GENERAL MAINTENANCE

### WARNING!

1. Be sure to disconnect the power cord prior to performing any maintenance.
2. DO NOT POUR WATER directly onto the printer, as this may cause electric shock or fire.
3. The print head becomes very hot while printing. To avoid getting burned, never touch the print head during the maintenance.

### CAUTION!

1. Do not use any sharp object to clean the print head and platen. Doing so may damage them, causing poor print or missing dots.
2. Never use an organic solvent like thinners or benzene for cleaning. Using such solvents may discolor the covers.
3. Do not touch the print head element as static built-up may damage the print head

To help retain the high quality and performance of your printer it should be cleaned regularly. The greater the usage on the printer, the more frequent the cleaning. (i.e. low usage=weekly, high usage=daily)

### 6.1 Cleaning

#### 6.1.1 Cleaning the Print Head and Platen

- 1) Turn the power OFF and open the printer cover.
- 2) Clean the print head element (cross hatched area in the figure on the right) with a cotton swab slightly moistened with alcohol.
- 3) Clean the platen with a soft cloth moistened with alcohol.

**Caution!** Hot surface. (Please refer to the **WARNING!** On the above)

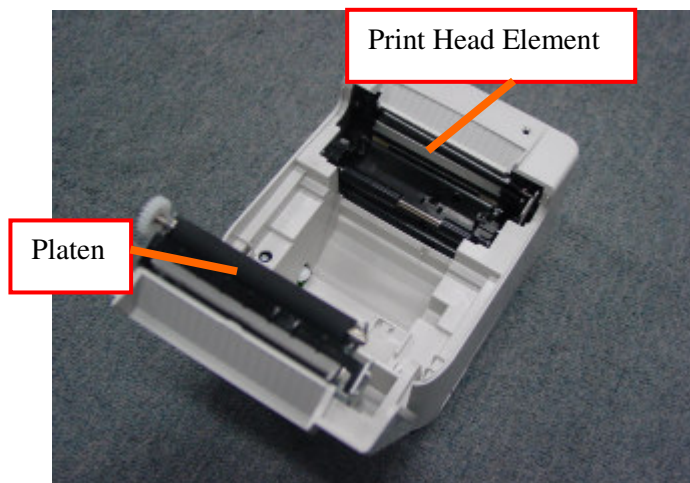

#### 6.1.2 Cleaning the Covers

Wipe the covers with a soft dry cloth or soft cloth slightly moistened with mild detergent. After using detergent for cleaning, be sure to wipe it off with a slightly moistened cloth.

#### 6.2 Removing Jammed Paper

1. Turn the power OFF.
2. Open the printer cover.
3. Remove the jammed paper. **DO NOT USE** any sharp implement or tool as these will damage the printer.
4. Clean the print head and platen, then remove any further dust or foreign objects.
5. Re-load the receipt roll. (Refer to Section **5.3 Loading the Receipt Roll.**)
6. After closing the printer cover, turn the power ON. The printer will initialize the auto cutter to restore the printer stand-by.

## 7. TROUBLESHOOTING

### WARNING!

If you cannot solve a problem with the following solutions, do not attempt to repair it by yourself. Turn the power off, unplug the printer, then contact your authorized TOSHIBA TEC representative for assistance.

Problem	Check Point	Solution
The power is not turned on. (Power LED does not light.)	<ul style="list-style-type: none"> <li>Is the power cord plugged in correctly?</li> <li>Is power supplied to the AC outlet?</li> <li>Has the circuit breaker tripped?</li> </ul>	<ul style="list-style-type: none"> <li>Plug it in correctly.</li> <li>If it is not a power failure, check if the power is supplied to the AC outlet with another electric appliance. If not, contact your nearest power company.</li> <li>Check the circuit breaker.</li> </ul>
Receipt paper is not issued.	<ul style="list-style-type: none"> <li>Is the receipt roll loaded properly?</li> <li>Does a paper jam error occur?</li> </ul>	<ul style="list-style-type: none"> <li>Refer to <b>Section 5.3</b> and load the receipt roll properly.</li> <li>Refer to <b>Section 6.2</b> and remove the jammed paper, and re-load the receipt roll.</li> </ul>
No printing is performed though the POWER LED lights.	<ul style="list-style-type: none"> <li>Is the interface cable connected correctly?</li> <li>Does the specification of the interface cable meet that of the POS terminal or the printer?</li> </ul>	<ul style="list-style-type: none"> <li>Connect the interface cable correctly.</li> <li>Use a TOSHIBA TEC-recommended interface cable or an interface cable which meets the specification of the printer.</li> </ul>
Issued receipt paper is stained.	<ul style="list-style-type: none"> <li>Is the print head dirty?</li> </ul>	<ul style="list-style-type: none"> <li>Refer to <b>Section 6.1</b> and clean the print head.</li> </ul>
Irregular print/blurred print	<ul style="list-style-type: none"> <li>Is the proper paper used?</li> <li>Is the paper dampened?</li> </ul>	<ul style="list-style-type: none"> <li>Refer to <b>Section 2.2</b> and use the TOSHIBA TEC specified paper.</li> <li>Do not use dampened paper</li> </ul>

**NOTE:** If any problem occurs other than the above, please contact your authorized TOSHIBA TEC representative.

English

**Waste Recycling information for users:**

Following information is only for EU-member states:

The crossed out wheeled bin symbol is used to indicate that the product must not be treated as general household waste.

By ensuring that this product is disposed of correctly you will be helping to prevent potentially negative consequences for the environment and human health, which could otherwise be caused by incorrect waste handling of this product.

For more detailed information about the take-back and recycling of this equipment, please contact the supplier that provided you with the product in question.



French

**Information aux utilisateurs concernant le recyclage des déchets:**

Les informations suivantes sont uniquement destinées aux pays membres de l'Union Européenne:

L'utilisation du symbole de "poubelle à roulettes barrée" indique que ce produit ne doit pas être traité comme un déchet ménager classique.

En vous assurant que ce produit est correctement mis au rebut, vous participerez à la prévention de l'environnement et de la santé publique, contre des conséquences négatives potentielles qui pourraient résulter d'un traitement inapproprié des déchets de ce produit. Pour obtenir des informations complémentaires concernant la récupération et le recyclage de ce produit, veuillez contacter le fournisseur auprès duquel vous avez acheté le produit.



German

**Wiederverwertungsinformationen für Verbraucher:**

Die folgenden Informationen gelten nur für EU-Mitgliedsstaaten:

Das durchgestrichene Mülltonnensymbol weist darauf hin, dass dieses Produkt nicht wie allgemeiner Haushaltsmüll behandelt werden darf.

Indem Sie aktiv mitwirken, dieses Produkt ordnungsgemäß zu entsorgen, helfen Sie mit, mögliche negative Auswirkungen auf die Umwelt sowie die menschliche Gesundheit zu vermeiden, die sonst durch die unsachgemäße Entsorgung dieses Produktes beeinträchtigt werden könnten.

Für nähere Informationen zur Rücknahme und Wiederverwertung dieses Produktes wenden sie sich bitte an den Lieferanten, von dem Sie dieses Produkt erworben haben.



Spanish

**Información para usuarios sobre el reciclaje de residuos:**

La siguiente información sólo concierne a los Estados Miembros de la UE:

El uso del símbolo de un contenedor con ruedas tachado indica que este producto no puede ser tratado como si fuera un residuo doméstico.

Asegurando que nos deshacemos de este producto de forma correcta, ayudaremos a evitar potenciales consecuencias negativas tanto para el medio ambiente como para la salud pública, que podrían producirse debido a un tratamiento inapropiado de este producto. Para obtener una información más detallada sobre la recogida y reciclaje de su producto, por favor, póngase en contacto con el proveedor donde lo compró.



Dutch

**Gebruikersinformatie over het recycleren van afval:**

De volgende informatie geldt enkel in EU-lidstaten:

Het symbool met de doorkruiste afvalbak geeft aan dat dit product niet mag worden behandeld als algemeen huishoudelijk afval.

Door dit product op de juiste manier van de hand te doen beschermt u het milieu en de volksgezondheid tegen mogelijke negatieve gevolgen, die anders zouden kunnen voortvloeien uit het onjuist verwerken van de resten van dit product. Voor gedetailleerde informatie over het terugnemen en recycleren van dit product, gelieve contact op te nemen met de leverancier van dit product.



Italian

**Informazioni sul riciclo del prodotto:**

Le seguenti informazioni riguardano gli stati membri EU:

Il simbolo con il bidone sbarrato indica il non poter smaltire questo prodotto come rifiuto domestico.

L'accertamento che questo prodotto sia smaltito correttamente contribuirà ad impedire le potenziali conseguenze negative per l'ambiente e la salute umana che potrebbero essere causati, al contrario, dall'errato smaltimento dello stesso. Per informazioni più dettagliate sulle modalità di resa e riciclaggio di questo prodotto mettetevi in contatto con il fornitore da cui l'avete acquistato.



Portuguese

**Informação sobre reciclagem:**

A informação que se segue é apenas dirigida a países membros da CEE:

A utilização deste símbolo indica que este produto não pode ser tratado como lixo comum.

Ao assegurar-se que este produto é tratado correctamente está a ajudar a prevenir potenciais consequências negativas para o ambiente e para a saúde humana, que poderiam ser causadas pelo inapropriado tratamento deste produto.

Para mais informação sobre a reciclagem e tratamento deste produto, contacte o seu fornecedor.



**TOSHIBA TEC CORPORATION**



PRINTED IN SINGAPORE  
SPAA-207-R1  
TSMB0039901



## Free Manuals Download Website

<http://myh66.com>

<http://usermanuals.us>

<http://www.somanuals.com>

<http://www.4manuals.cc>

<http://www.manual-lib.com>

<http://www.404manual.com>

<http://www.luxmanual.com>

<http://aubethermostatmanual.com>

Golf course search by state

<http://golfingnear.com>

Email search by domain

<http://emailbydomain.com>

Auto manuals search

<http://auto.somanuals.com>

TV manuals search

<http://tv.somanuals.com>