

# Rotary Cutter Module

## B-8204-QM-R Installation Manual

### WARNING!

1. Follow all manual instructions. Failure to do so could create safety hazards such as fire or electrocution.
  - Manual instructions must be followed when installing option kits or adding cables to avoid system failures and to insure proper performance and operation
  - Failure to follow manual instructions or any unauthorized modifications, substitution or change to this product will void the limited product warranty.
2. Turn the power off and disconnect the power cord before installing the rotary cutter module.
3. Be careful not to injure your fingers when installing the swing cutter module.
4. Be careful not to pinch your fingers or hands with the covers.

## 1. APPLICABLE MODEL





This optional kit is the rotary cutter module, which is intended for the following models:

B-SX4T Series, B-SX5T Series

**NOTE:** When using the Rotary Cutter to the B-SX4T Series, be sure to install the Ribbon Saving Module (B-9904-R/R2-QM). Failure to do this may cause a paper jam or ribbon error.

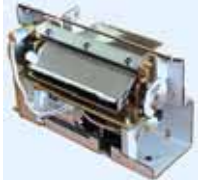
## 2. PACKING LIST

All the following parts are supplied with the kit. Make sure you have all items shown below.

<p>Cutter Unit (1 pc.)</p> 	<p>Cutter Cover (1 pc.)</p> 	<p>Cutter Drive Unit (1 pc.)</p> 	<p>Harness Ass'y (2-pin &amp; 9-pin) (1 pc.)</p> 
<p>Cord Bush (1 pc.) (For B-SX4 only)</p> 	<p>Print Head Cleaner (1 pc.) (P/No.: FMQB0051601)</p> 	<ul style="list-style-type: none"><li>• Installation Manual (1 copy)</li><li>• SM-4x8 Screw (6 pcs.)</li></ul>	

## 3. INSTALLATION PROCEDURE

### 3.1 Installing the Rotary Cutter Unit on the B-SX4T Series

- 1) Turn the power off and disconnect the power cord.
- 2) Remove the two black screws to detach the front plate.

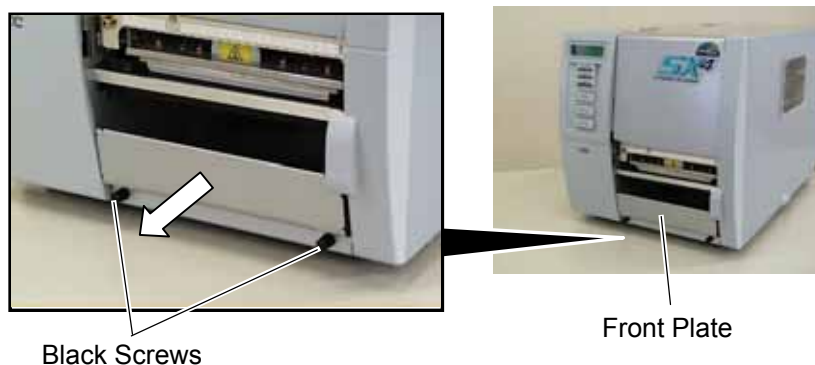

**NOTE:** Retain the two black screws and front plate.

3) Remove the four B-4x5 screws from the side panel (L).

4) Open the top cover and remove the three P-4x8 screws that secure the side panel (L).

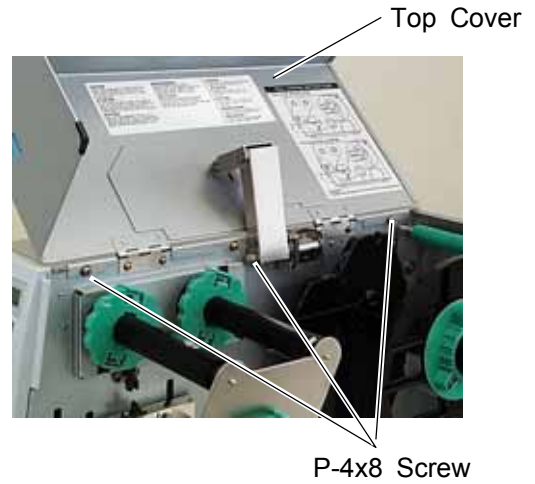
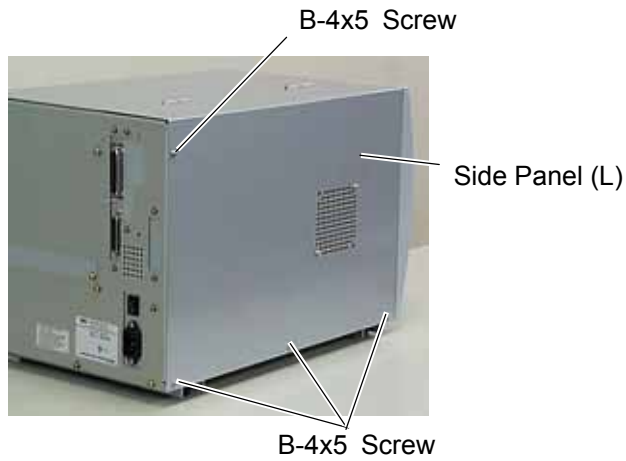

5) Lift the side panel (L) and put it aside.

6) Disconnect the fan motor harness from CN19 on the Main PC board, and then separate the side panel (L).

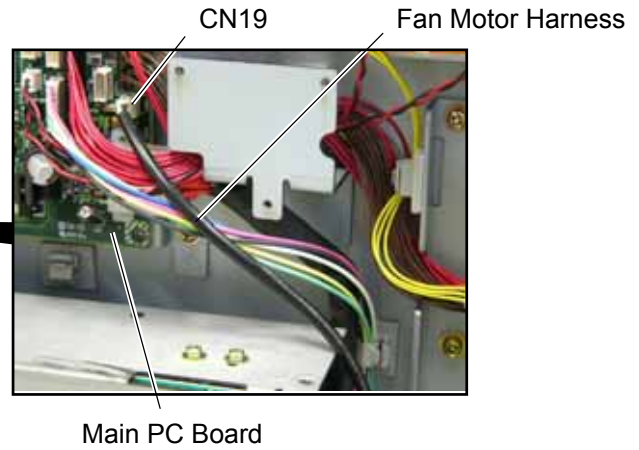
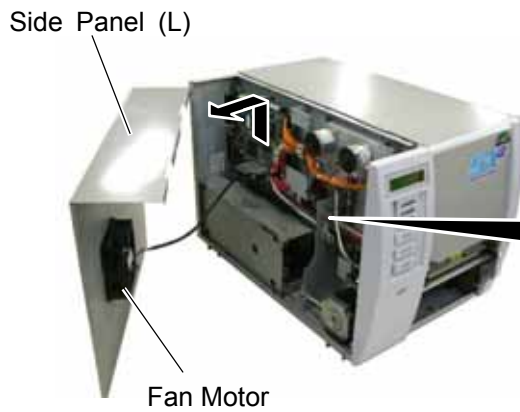

7) Fix the cutter drive unit to the printer with the three SM-4x8 screws.

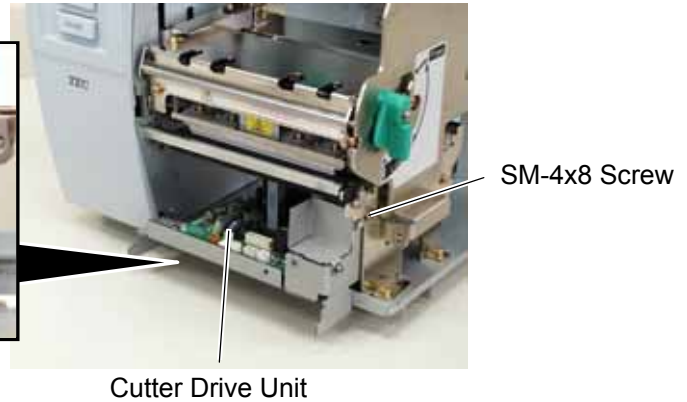
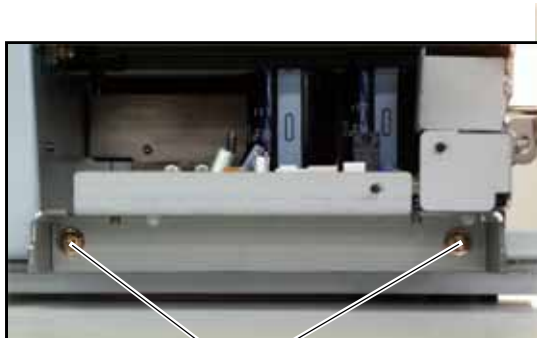

8) Connect the 9-pin connector of the harness ass'y to CN7 and 2-pin connector to CN9 on the cutter driver unit, respectively.



9) Fit the bush to the harness ass'y in the orientation as shown below.

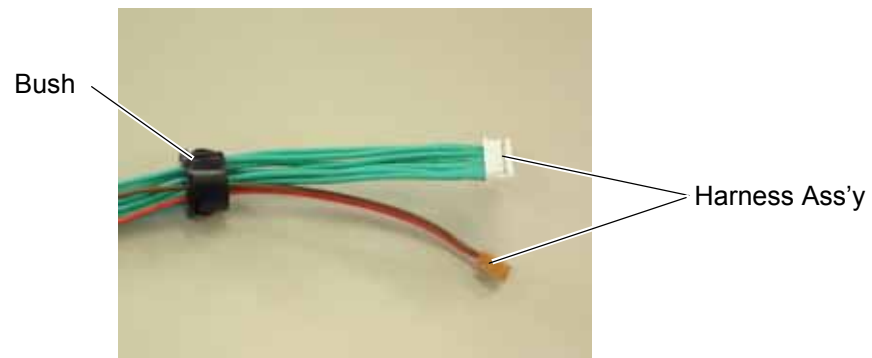

10) Insert the harness ass'y into the hole in the main frame. Fit the bush into the hole.

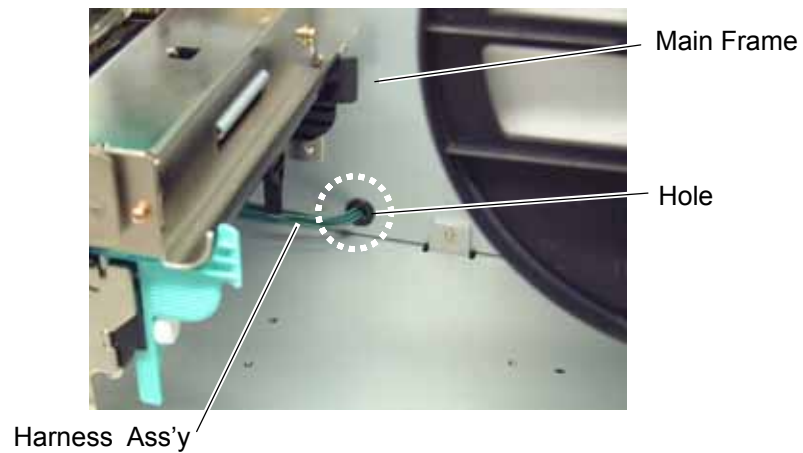

- 11) Fix the harness ass'y with the clamp.
- 12) Connect the 9-pin connector of the harness ass'y to CN15, and 2-pin connector to CN18 on the Main PC board, respectively.

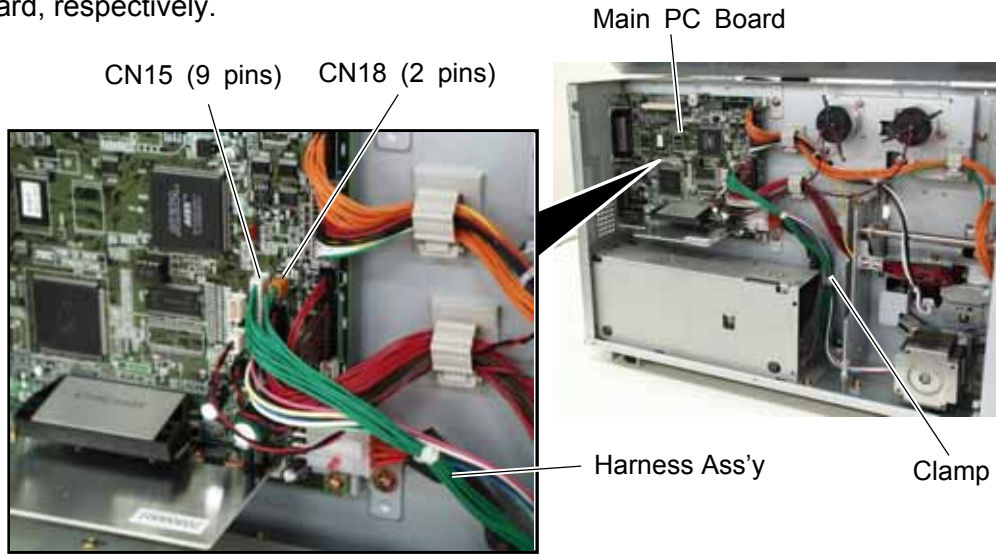

- 13) Turn the head lever counterclockwise to **Free** position.
- 14) Open the ribbon shaft holder plate.

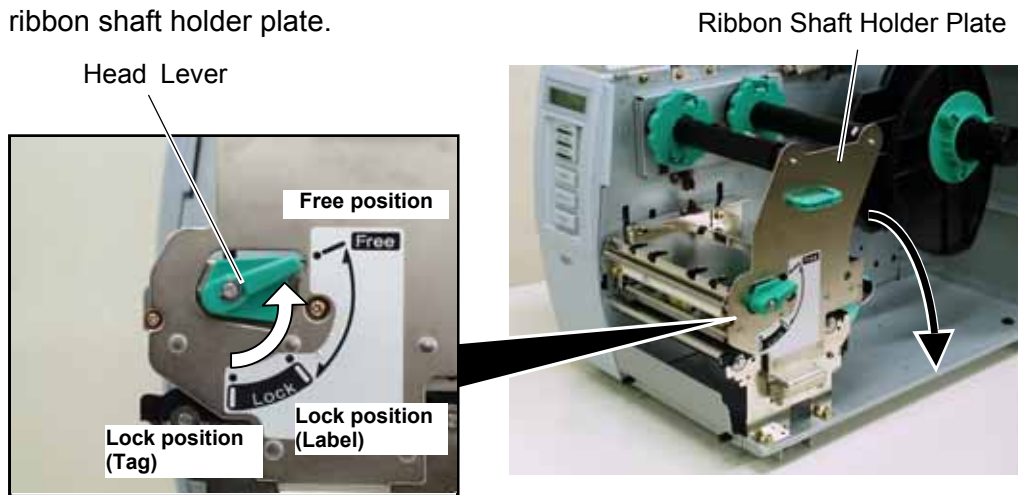

- 15) Raise the print head block until it stops.

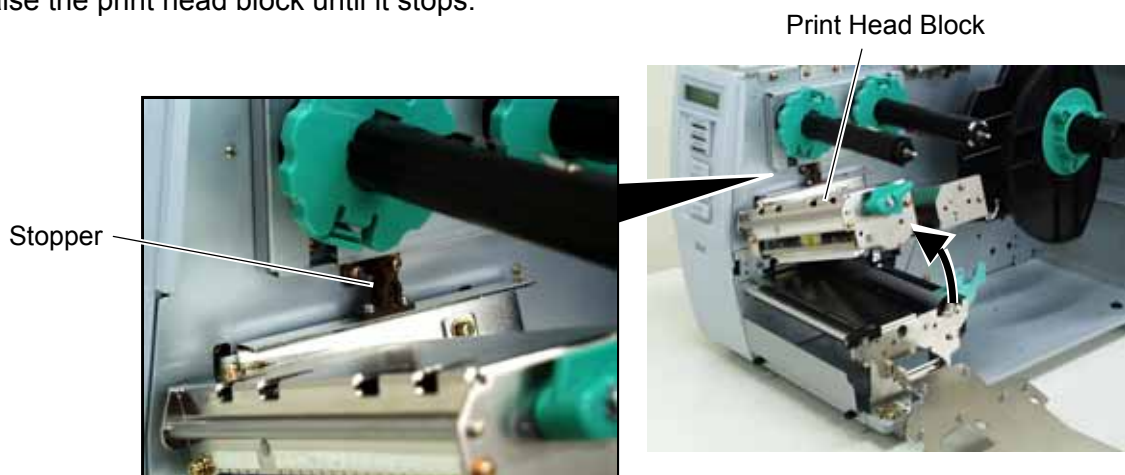



16) Connect the four harnesses of the cutter unit to CN8, CN10, CN11 and CN12 on the cutter drive unit.

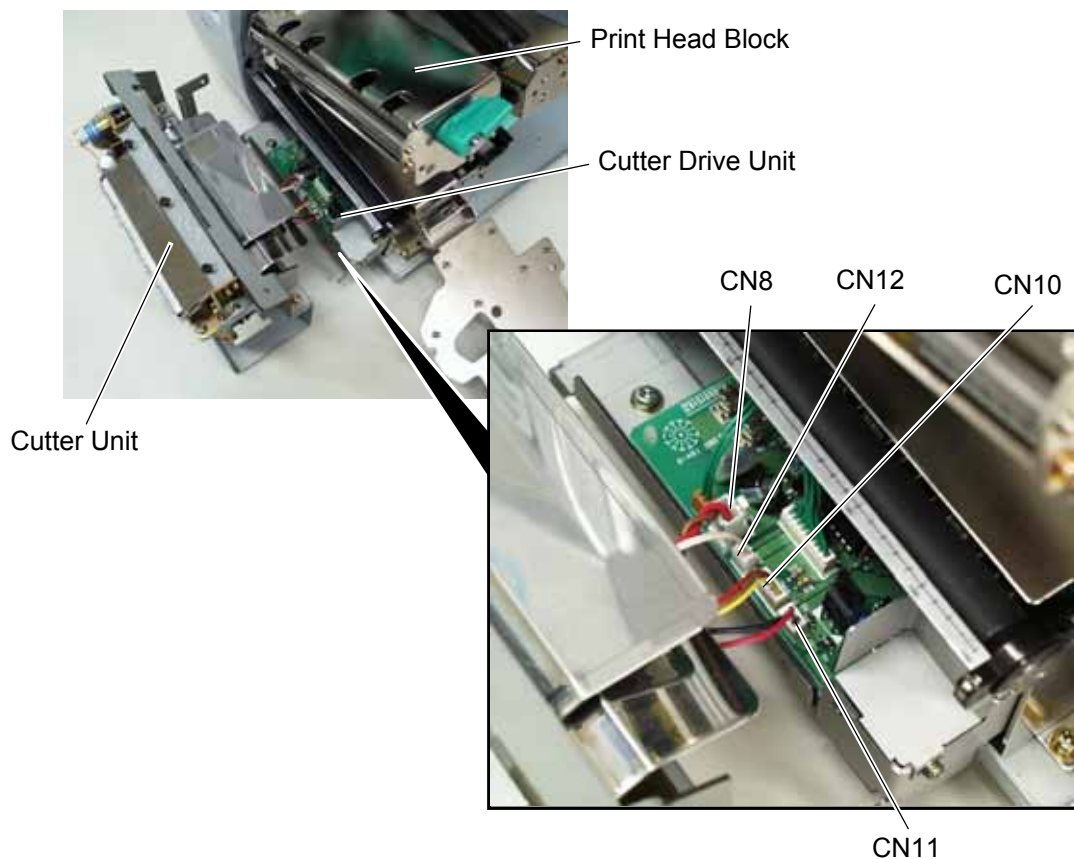

17) Fit the two tabs of the cutter drive unit into the notches, and then fix the cutter unit with the three SM-4x8 screws.

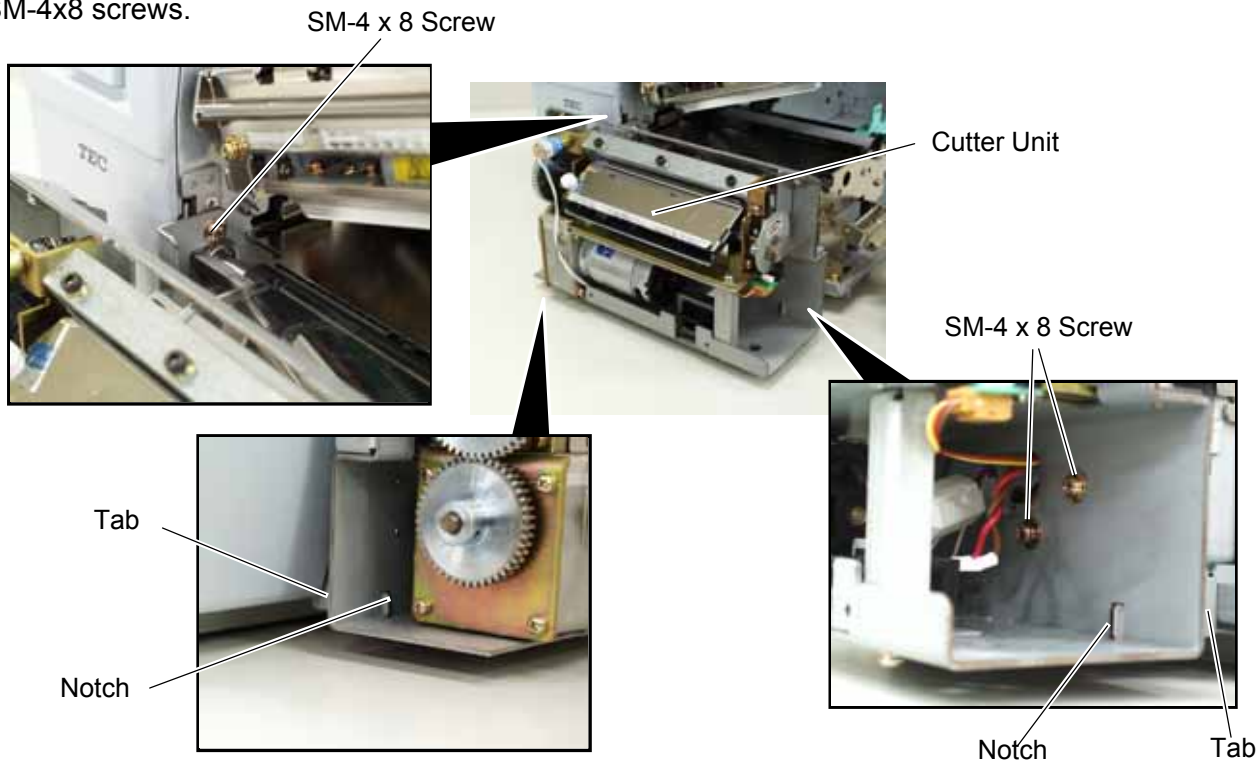

18) Attach the cutter cover to the cutter unit with the two screws so that the tab of the cutter cover turns on the cutter cover open switch.

- NOTES:** 1. Be careful not to pinch the cutter harness by the cutter cover.  
2. Make sure that the anti-static brush is protruding from the media outlet.

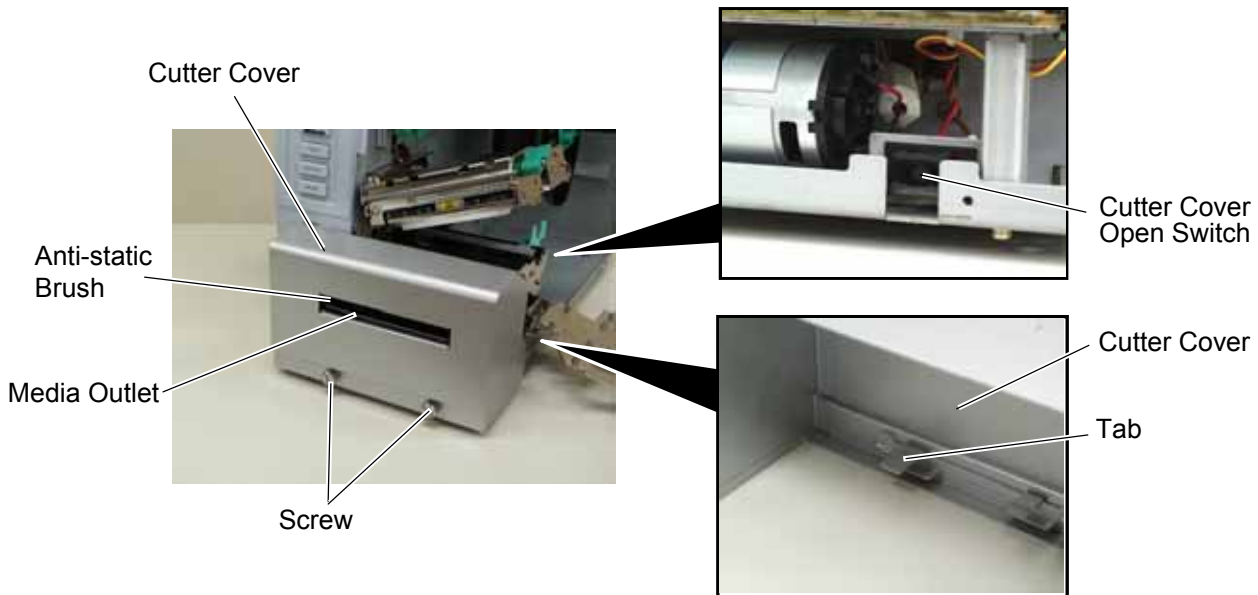

19) Close the print head block and ribbon shaft holder plate.

**NOTE:** DO NOT excessively push down the print head block to close it. Doing so may cause a failure of the print head block or damage to the print head.

20) Reassemble the side panel (L) and close the top cover. Finally check the cutter operation.

### 3.2 Installing the Rotary Cutter Unit on the B-SX5T Series

Since the strip module is standard on the B-SX5T series, it is necessary to remove the rewinder guide plate, strip sensor, etc. before installing the cutter module.

- 1) Turn the power off and disconnect the power cord.
- 2) When the printer is used in the batch or strip mode:  
Remove the two black screws to detach the front plate.

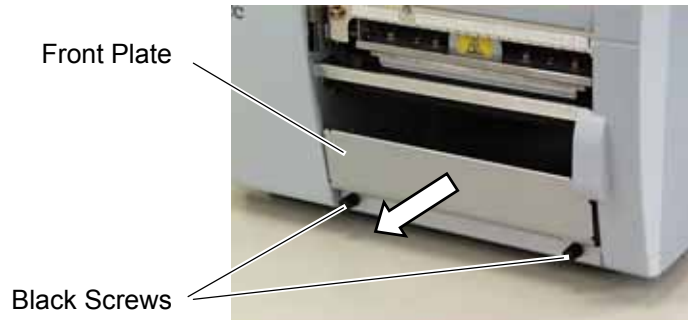

**NOTE:** Retain the two black screws and front plate.

When the printer is used in the built-in rewinder mode:

Open the top cover, remove the two SMW-4x8 screws, and detach the rewinder guide plate from the printer.

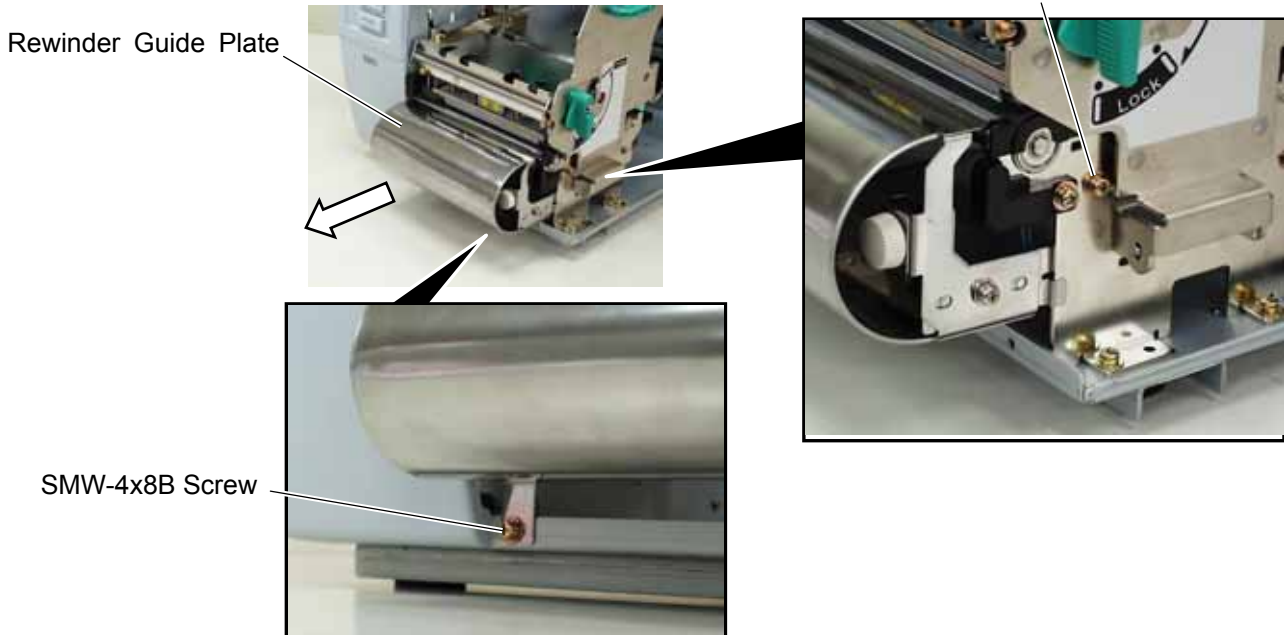

- 3) Remove the four B-4x5 screws from the side panel (L).
- 4) Open the top cover and remove the three P-4x8 screws that secure the side panel (L).

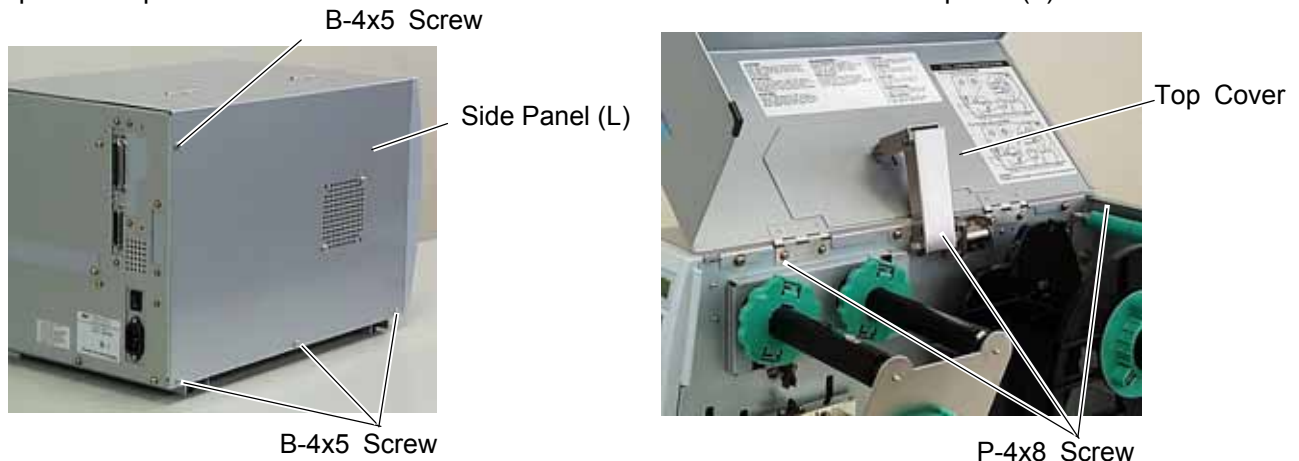

- 5) Lift the side panel (L) and put it aside.
- 6) Disconnect the fan motor harness from CN19 on the Main PC board, and then separate the side panel (L).

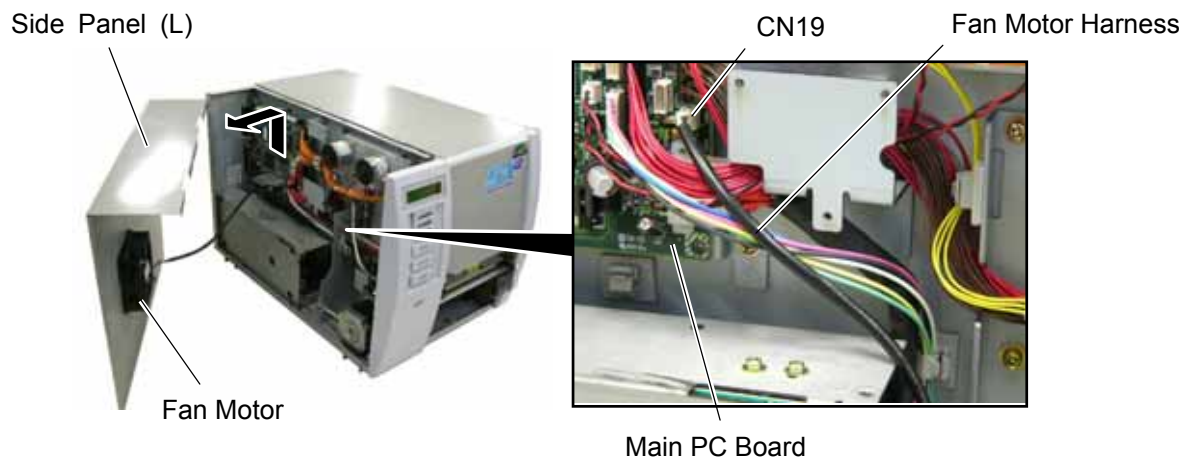

- 7) Remove the SM-4x8 screw that secures the operation panel ass'y.

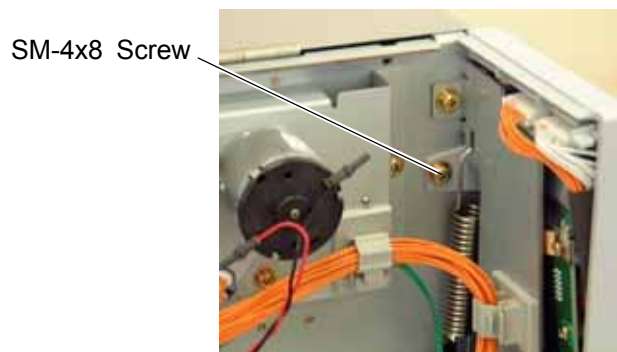

- 8) Half open the top cover, otherwise the operation panel ass'y cannot be removed from the printer.



- 9) Lift the operation panel ass'y to release the hook, and then remove the operation panel ass'y by moving it forward.



10) Disconnect the operation panel harness from the operation panel ass'y.

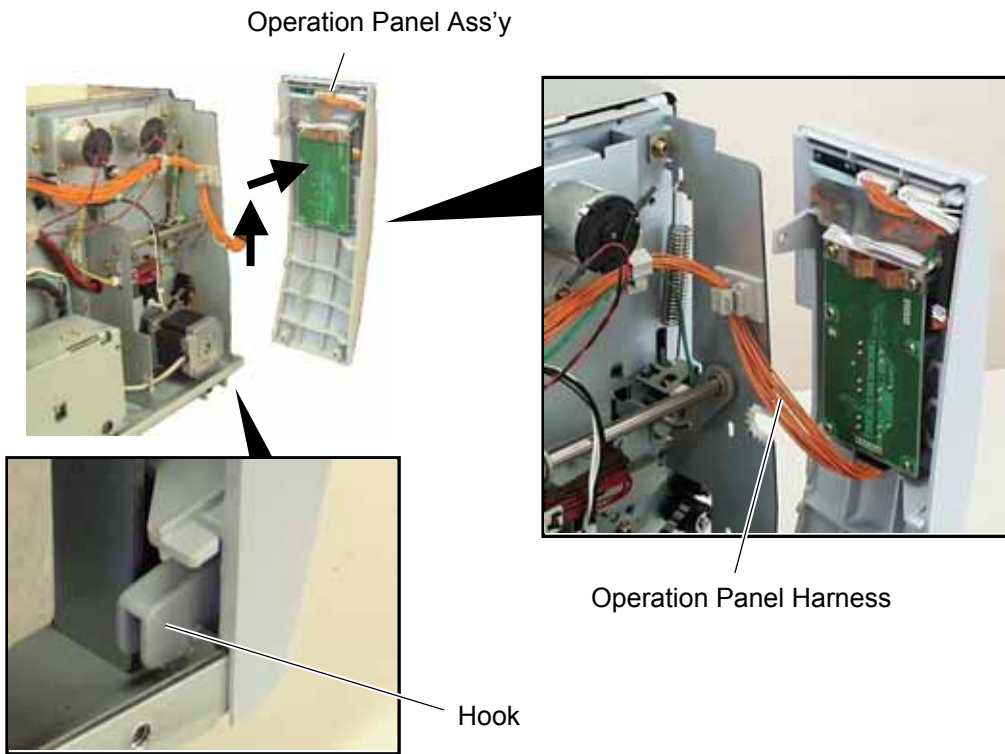

11) Turn the head lever clockwise to **Free** position.

12) Open the ribbon shaft holder plate.

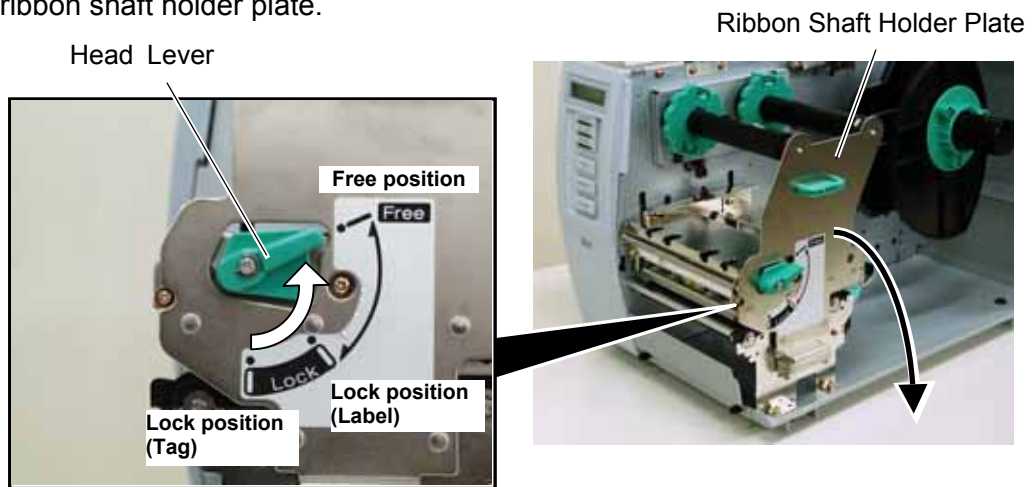

13) Raise the print head block until it stops.

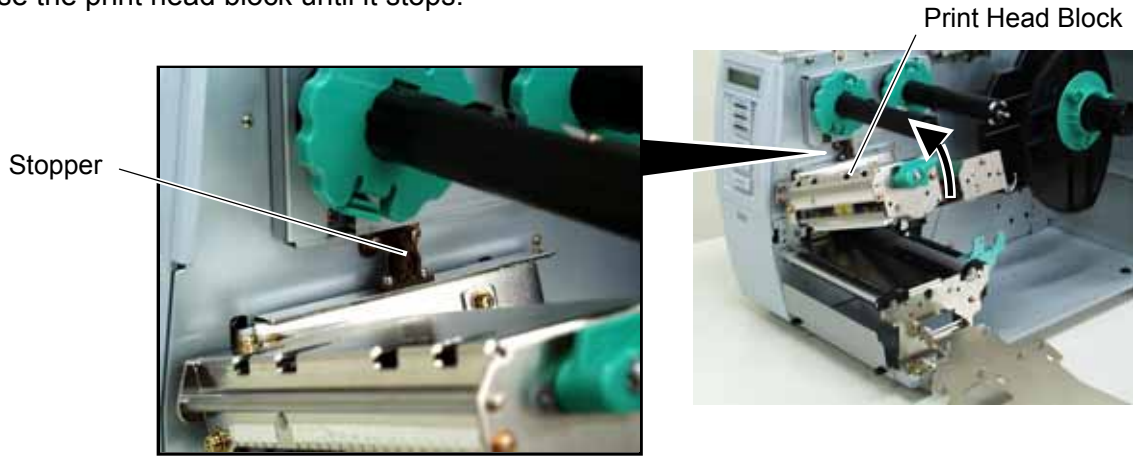

14) Remove the two SMW-4x8 screws that secure the strip sensors (TR) and (LED).

15) Release the strip sensor (LED) harness from the cable clamp, and disconnect it from the shorter harness of the strip sensor harness (TR).

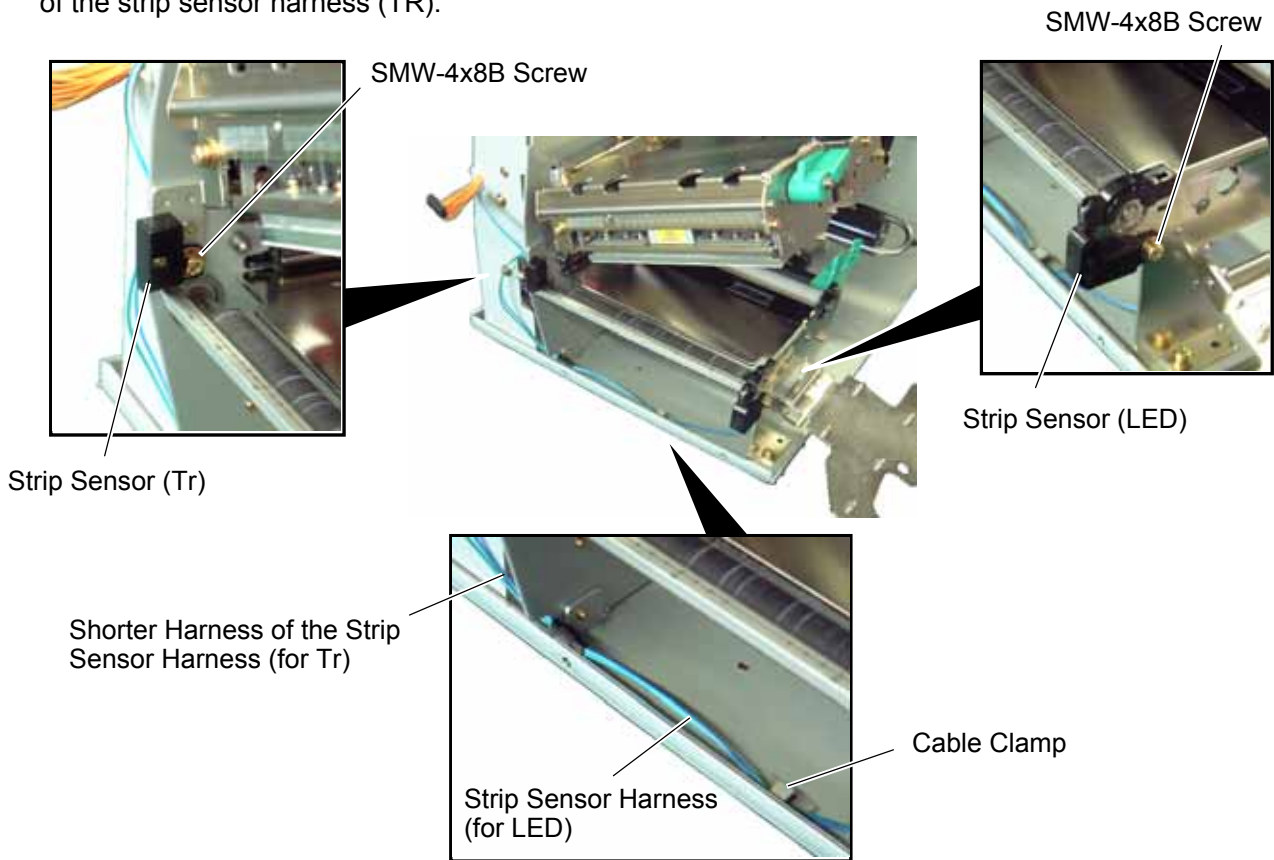

- 16) Remove the Expansion I/O board from the printer temporarily using the following procedure.
- (1) Disconnect the Expansion I/O cable from CN1 on the Expansion I/O board.
  - (2) Remove the two B-3x6 screws to detach the Expansion I/O board from the printer.

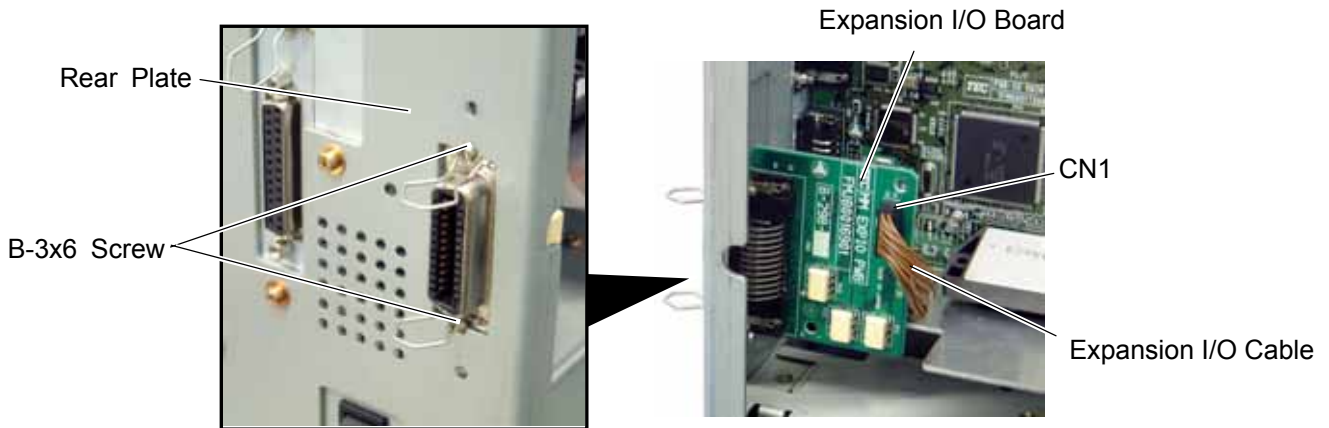

- 17) Disconnect the shorter harness of the strip sensor harness (TR) from CN20 on the Main PC board. Then remove the strip sensor (TR) from the printer.

**NOTE:** Retain the strip sensors (TR) and (LED), and the strip sensor harness.

- 18) Disconnect the longer harness of the rewind full sensor (TR) and rewinder harness from CN4 and CN15 on the Main PC board, respectively.

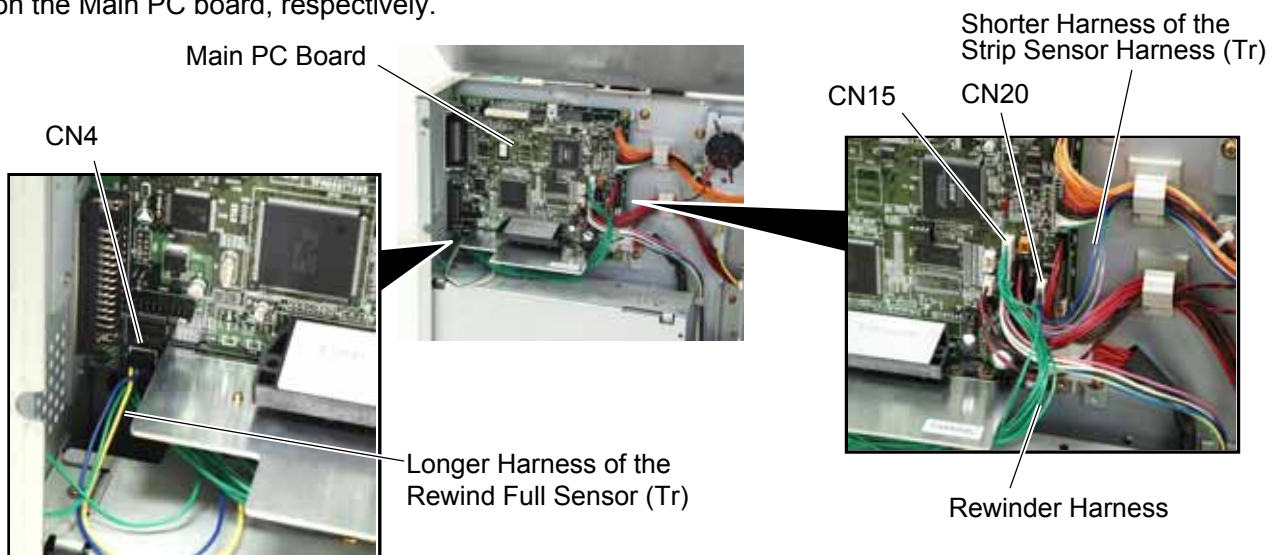

**NOTE:** Secure the rewinder harness and the longer harness of the rewind full sensor (TR) to the space under the Main PC board with the cable clamp so that they are not pinched by the covers or printer's internal components.

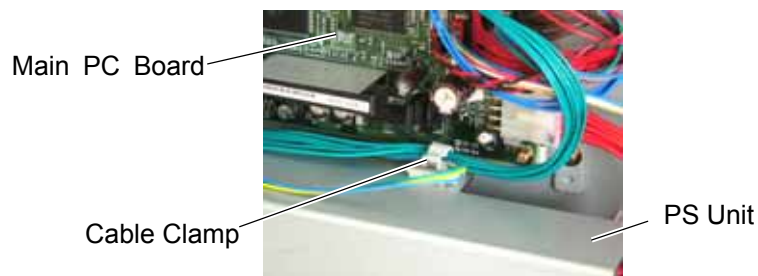

- 19) Reassemble the operation panel ass'y and the expansion I/O board in the reverse order of removal.

20) Fix the cutter drive unit to the printer with the three SM-4x8 screws.

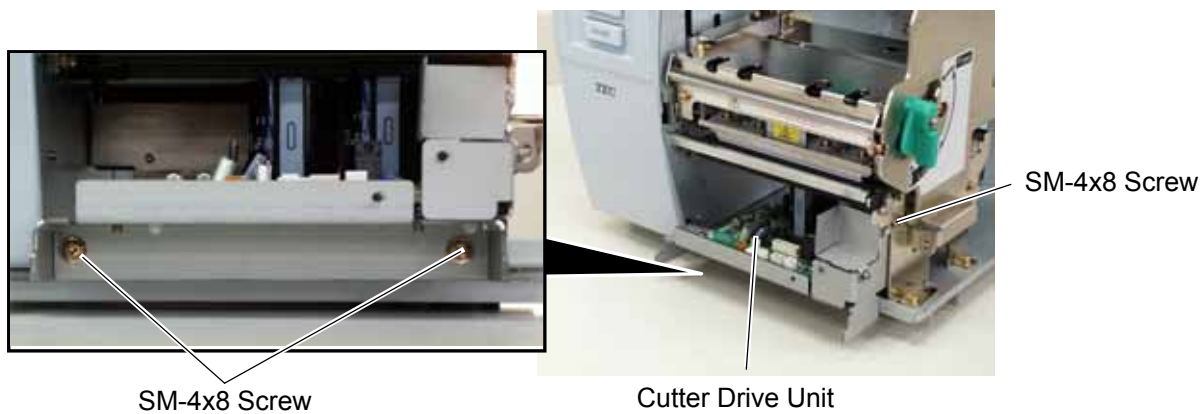

21) Connect the 9-pin connector of the harness ass'y to CN7 and 2-pin connector to CN9 on the cutter driver unit, respectively.



22) Fit the bush to the harness ass'y in the orientation as shown below.

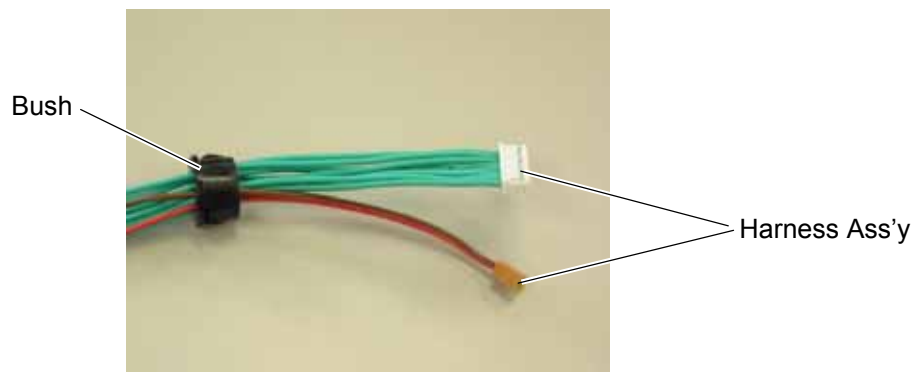

23) Insert the harness ass'y into the hole in the main frame. Fit the bush into the hole.

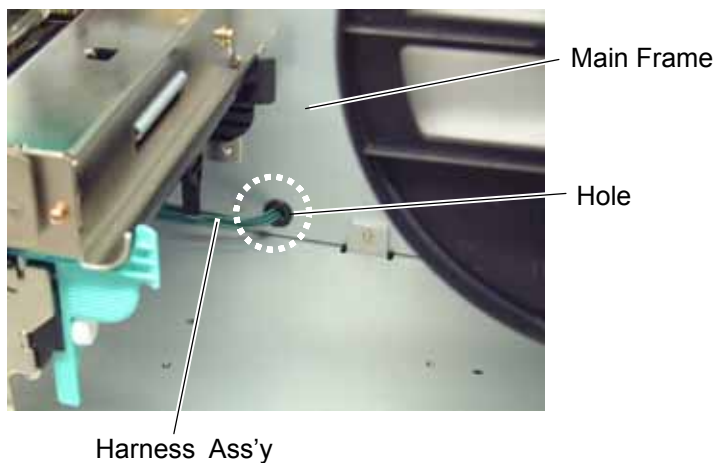



24) Fix the harness ass'y with the clamp.

25) Connect the 9-pin connector of the harness ass'y to CN15, and 2-pin connector to CN18 on the Main PC board, respectively.

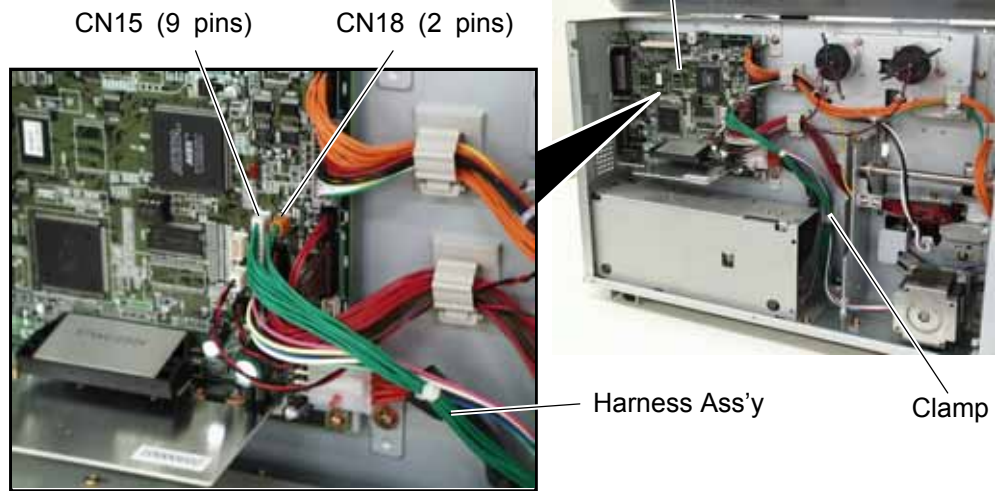

26) Connect the four harnesses of the cutter unit to CN8, CN10, CN11 and CN12 on the cutter drive unit.

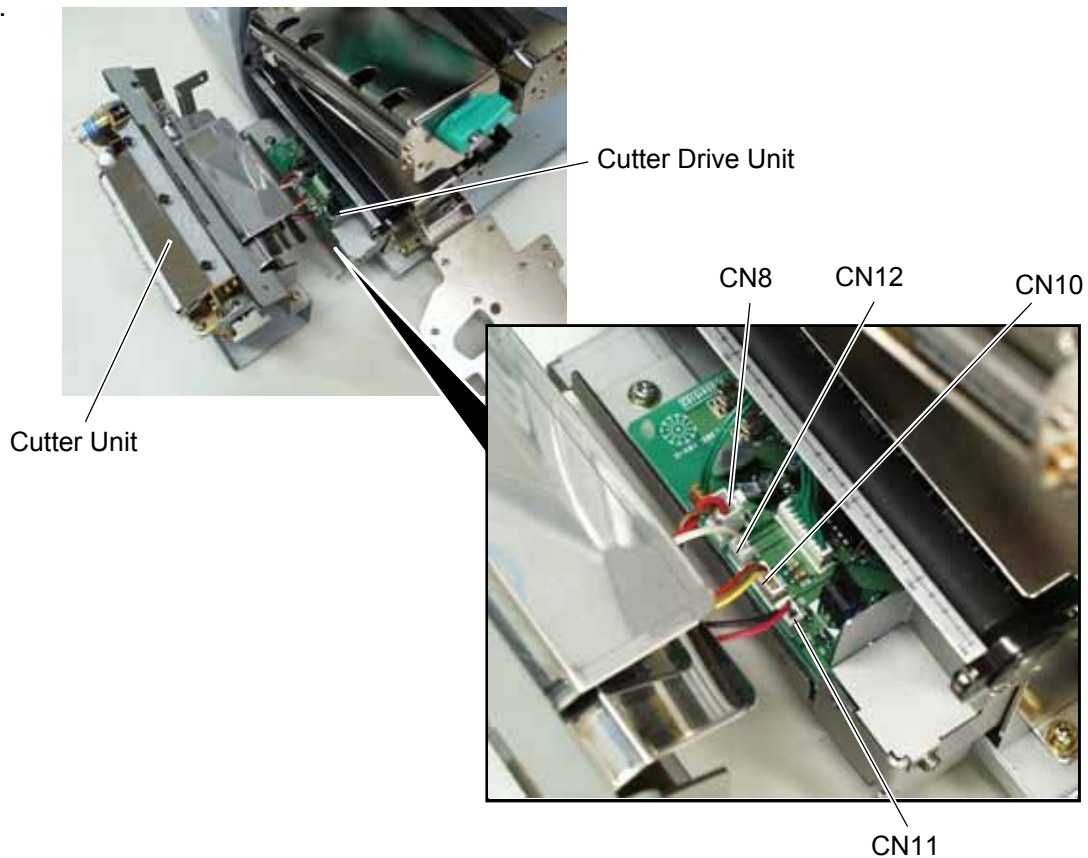

27) Fit the two tabs of the cutter drive unit into the notches, and then fix the cutter unit with the three SM-4x8 screws.

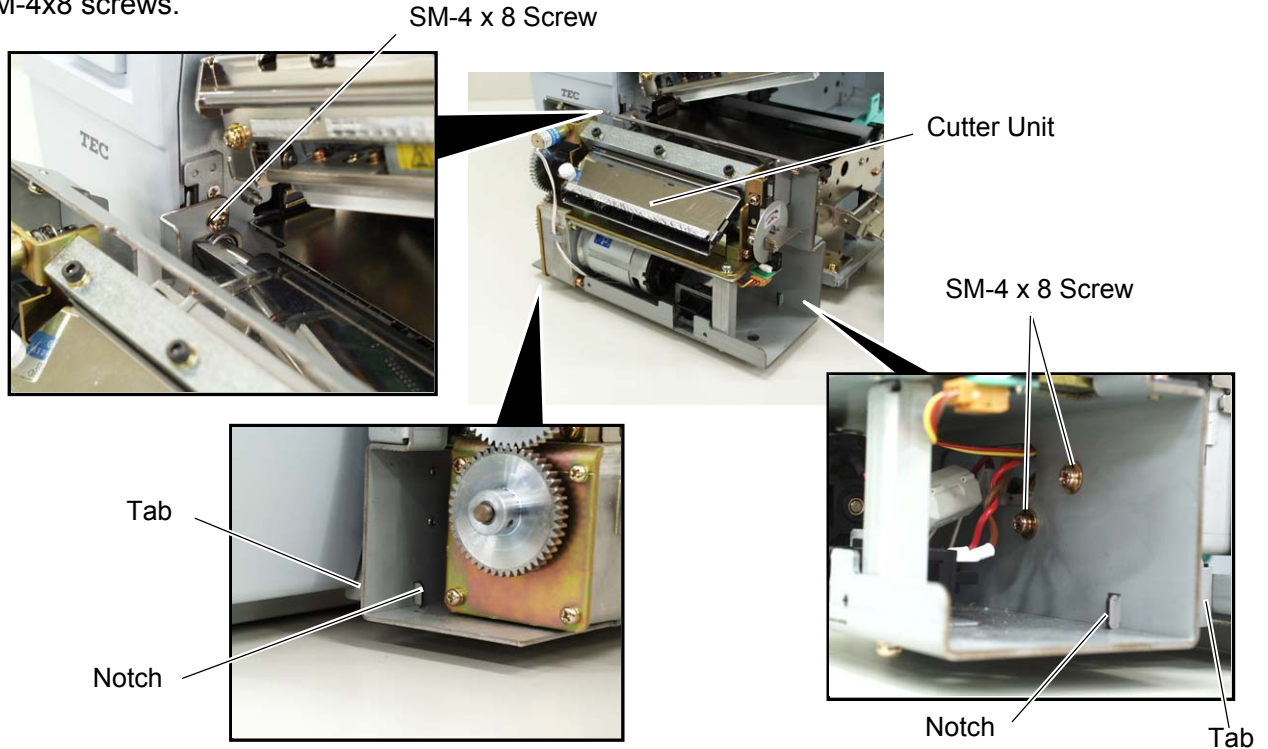

28) Attach the cutter cover to the cutter unit with the two screws so that the tab of the cutter cover turns on the cutter cover open switch.

- NOTES:** 1. Be careful not to pinch the cutter harness by the cutter cover.  
 2. Make sure that the anti-static brush is protruding from the media outlet.

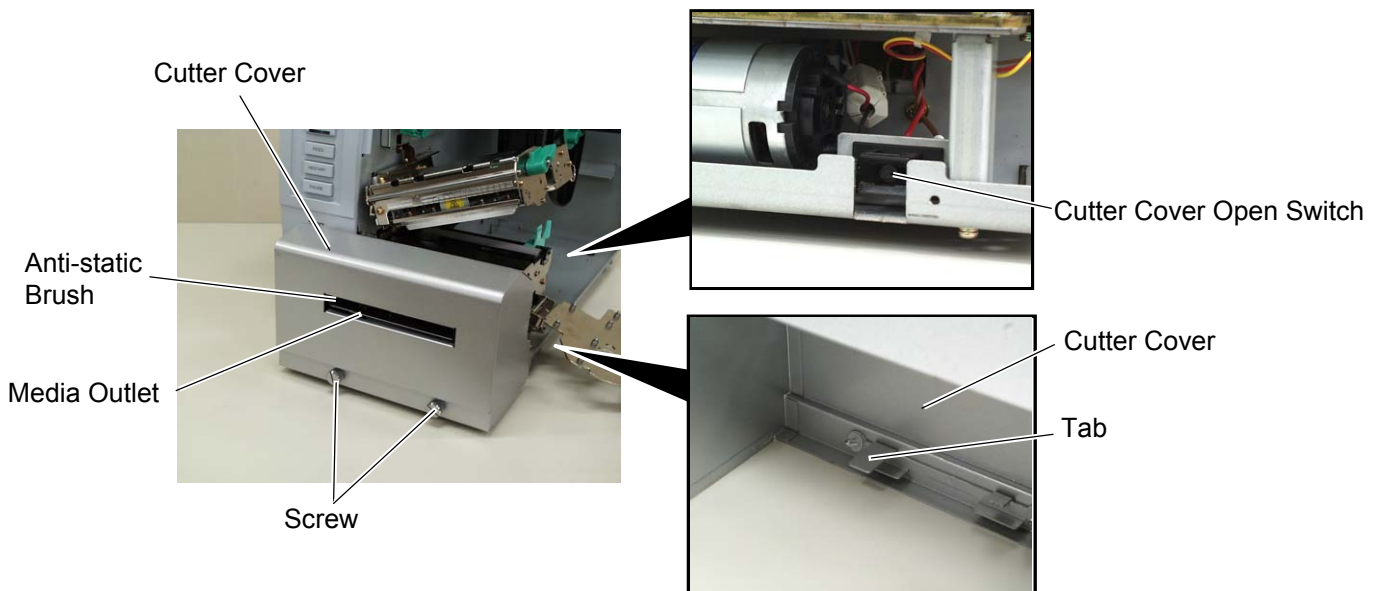





29) Close the print head block and ribbon shaft holder plate.

**NOTE:** DO NOT excessively push down the print head block to close it. Doing so may cause a failure of the print head block or damage to the print head.

30) Reassemble the side panel (L) and close the top cover. Finally check the cutter operation.

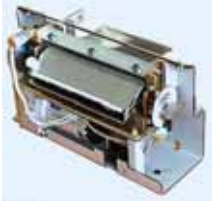
# ロータリーカッターモジュール(B-8204-QM-R) 組込説明書

このたびは「ロータリーカッターモジュール B-8204-QM-R」をお買い上げいただき、誠にありがとうございます。  
B-8204-QM-R は、B-SX5T-R シリーズ用のロータリー式カッターモジュールです。  
B-8204-QM-R を組み込む前に、パッケージに次のものがすべて揃っているか確認してください。  
万一、不足しているものがある場合は、お買い上げの販売店までご連絡ください。

●カッター機構部(1台) 	●カッターカバー(1個) 	●カッター制御部(1個) 	●カッターケーブル (1セット) 
●コードブッシュ(1個) 	●ヘッドクリーナー(1本) 	●セムスネジ SM-4x8 (6個) ●組込説明書(1冊…本書)	



## 注意事項 (組込作業をされる方へ)

- 本書の手順に従って組み込むこと  
手順を無視して組み込むと、火災・感電の恐れがあります。  
本書の手順や指示を無視して組み込んだ場合、その結果に対して当社は一切の責任を負いません。
- 組み込む前にプリンタの電源スイッチをOFFにし、電源プラグをコンセントから抜くこと  
電源が ON 状態で組み込むと、火災・感電・けがの恐れがあります。
- プリンタのトップカバーは、左側に倒すように全開にすること  
中途半端な状態にしておくと勝手に閉まり、けがの原因となることがあります。
- カッターの刃に手や指を触れないこと  
けがの原因となることがあります。
- 印字直後は、印字ヘッドおよびヘッド周辺部に手を触れないこと  
やけどの原因となることがあります。

### 補足

ロータリーカッターモジュール(B-8204-QM-R)とハクリモジュール(B-9904-H-R)を同時に組み込むことはできません。

## ■ 組込手順

- 1) プリンタの電源スイッチを OFF にし、電源プラグをコンセントから抜きます。
- 2) 用紙発行口下側の黒い化粧ネジ2本を外し、目隠し板を取り外します。

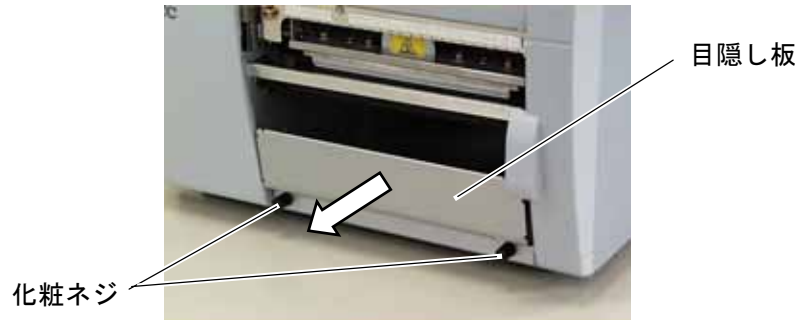

**補足** 目隠し板および化粧ネジは、紛失しないよう大切に保管してください。

- 3) 左サイドカバーからネジ(B-4x5)4本を外します。
- 4) トップカバーを全開にし、左サイドカバーを固定しているネジ(P-4x8)3本を外します。

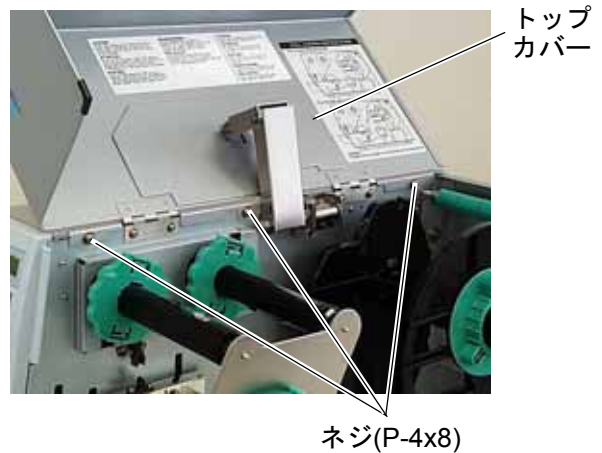
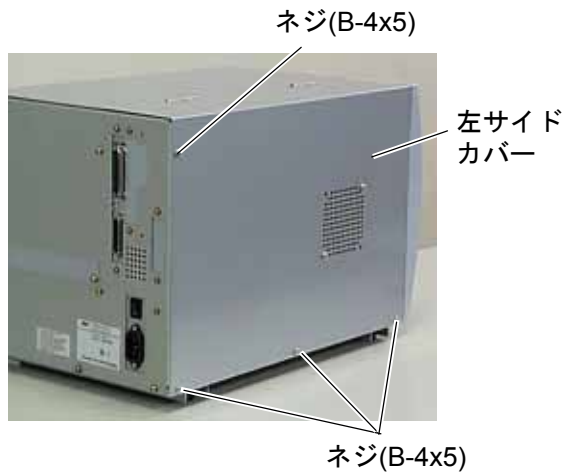

- 5) 左サイドカバーを少し持ち上げながら外してそばに置きます。
- 6) Main PC板のCN19から冷却ファンケーブルを抜き、左サイドカバーをプリンタから取り外します。

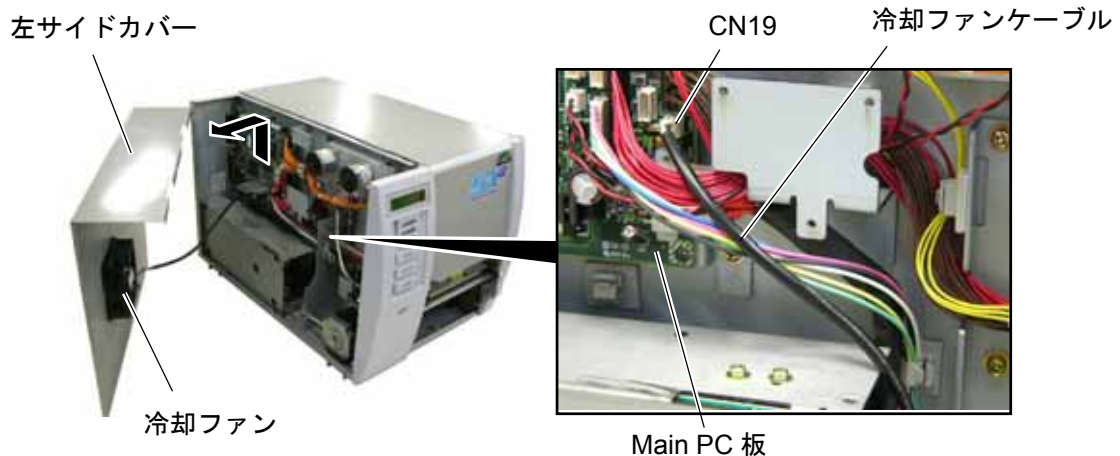



7) ヘッドレバーを **Free** の位置まで回します。

8) リボンシャフト固定板を静かに右側へ倒します。

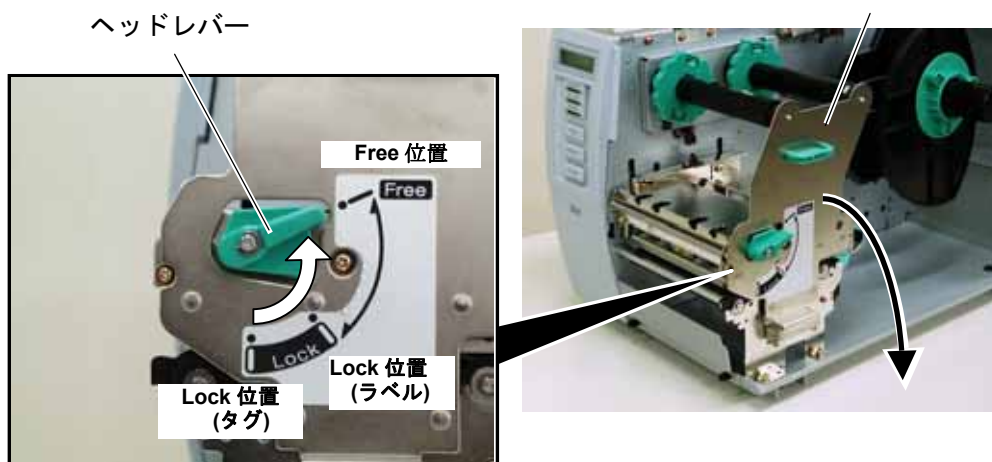

9) 印字ヘッド機構部を持ち上げてロックします。

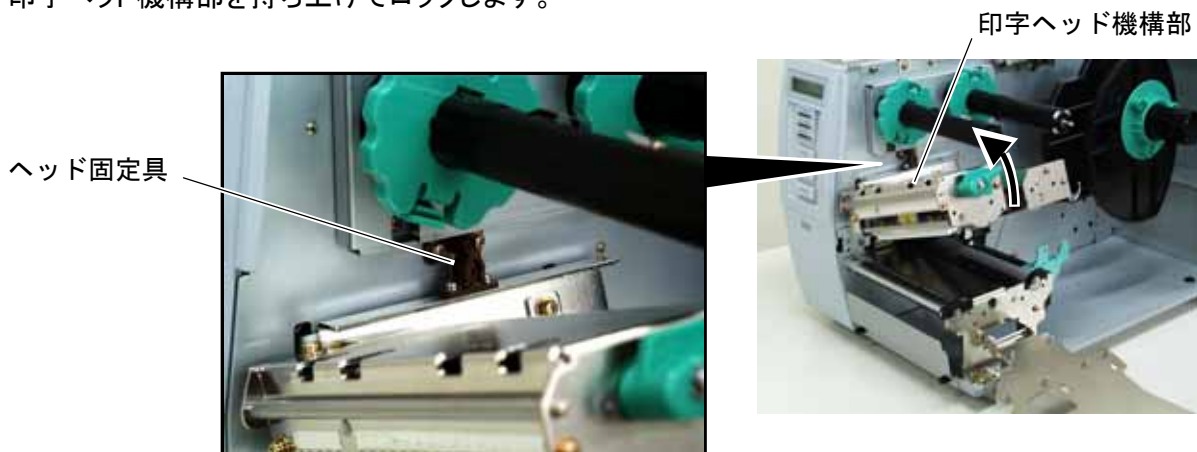

10) セムスネジ(SM-4x8)3本で、カッター制御部を印字ヘッド機構部の下に取り付けます。

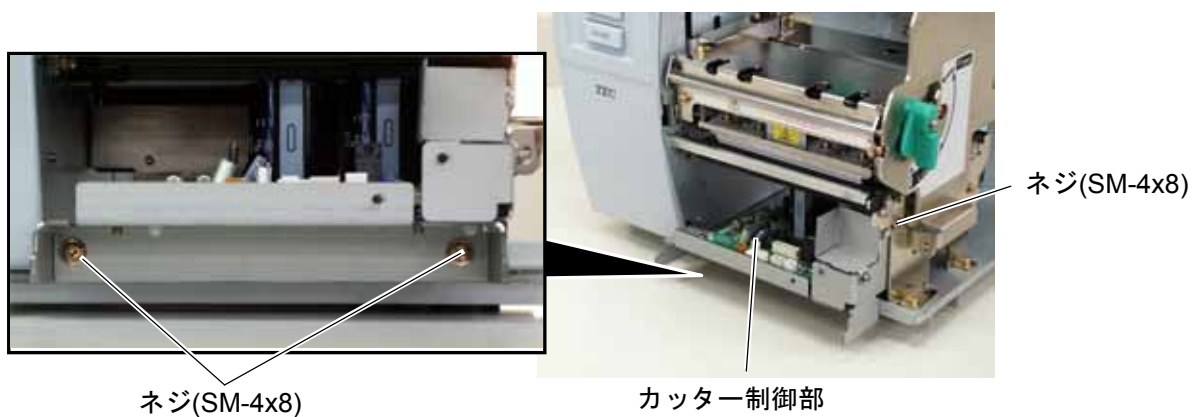

11) カッターケーブルをカッター制御部の CN7 と CN9 へ接続します。

カッターケーブル

CN9 (2ピン)

CN7 (9ピン)



12) カッターケーブルにコードブッシュを取り付けます。

コードブッシュ

カッターケーブル

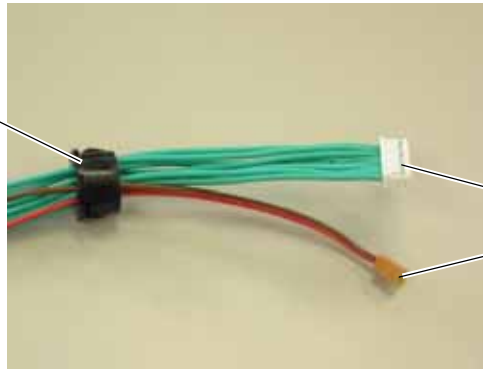

13) カッターケーブルをメインフレーム下側の丸穴に通し、コードブッシュをはめ込みます。

メインフレーム

コードブッシュ

カッターケーブル

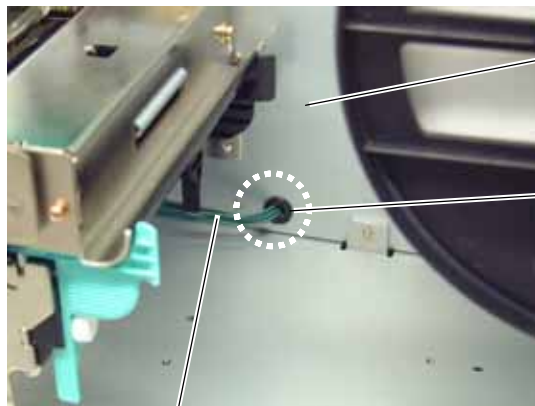

14) コードクランプでカッターケーブルを止め、Main PC 板の CN15 と CN18 へカッターケーブルを接続します。

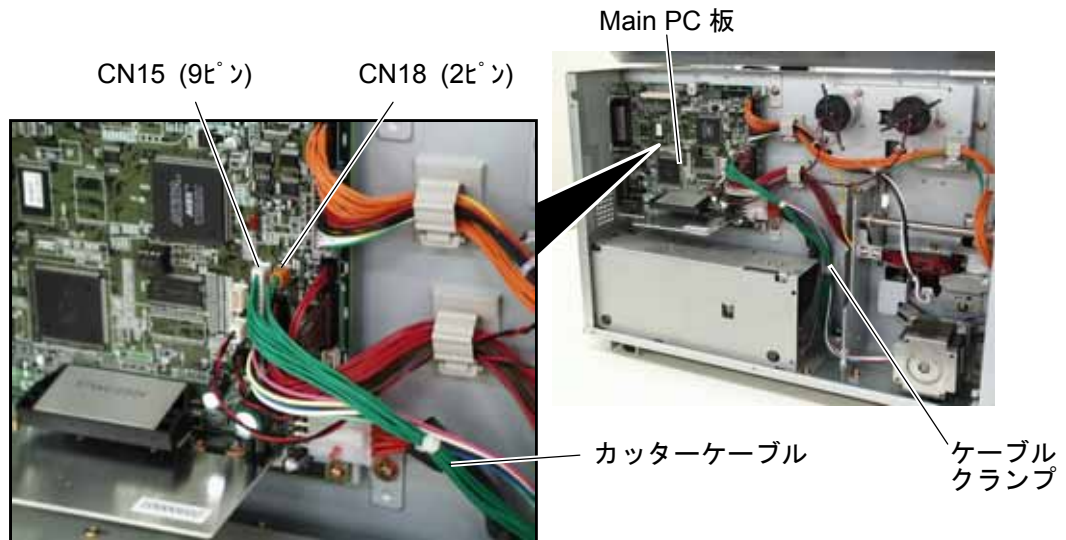

15) カッター機構部の4本のコネクタケーブルを、カッター制御部の CN8, CN10, CN11 および CN12 へ接続します。

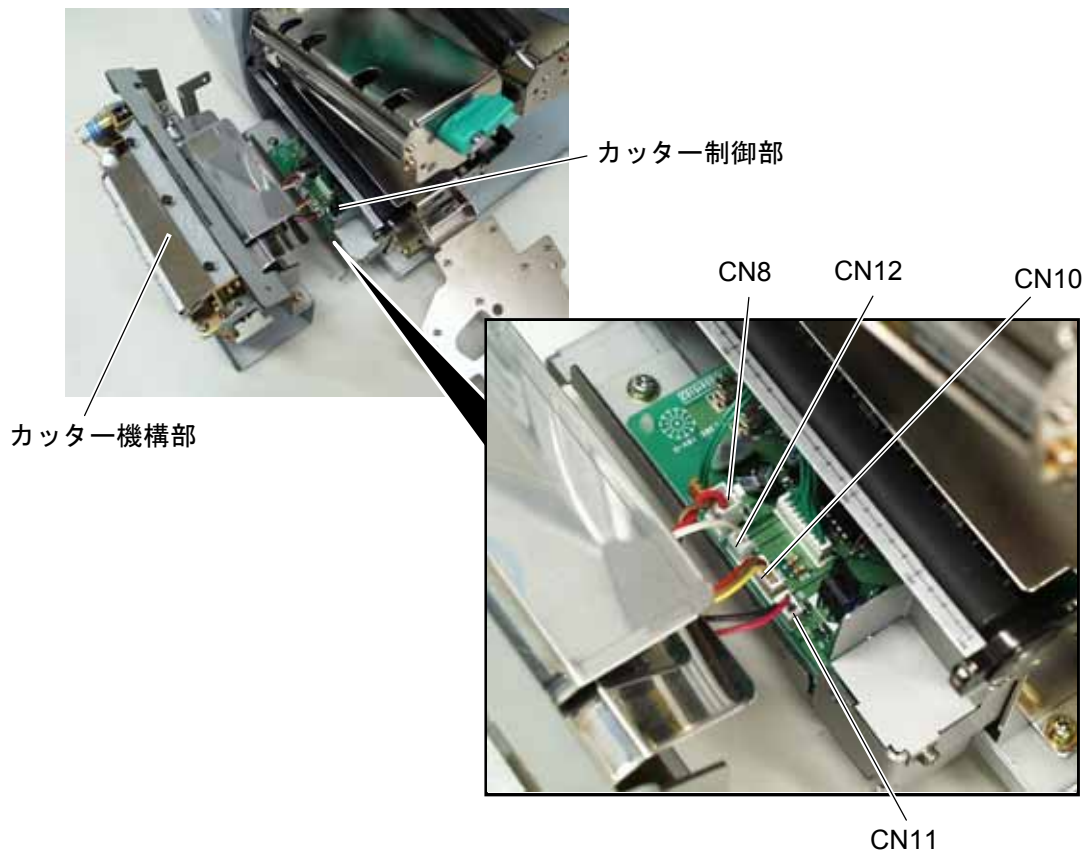

- 16) カッター制御部の2つの突起部とカッター機構部の角穴を合わせ、セムスネジ(SM-4x8)3本でカッター機構部を固定します。

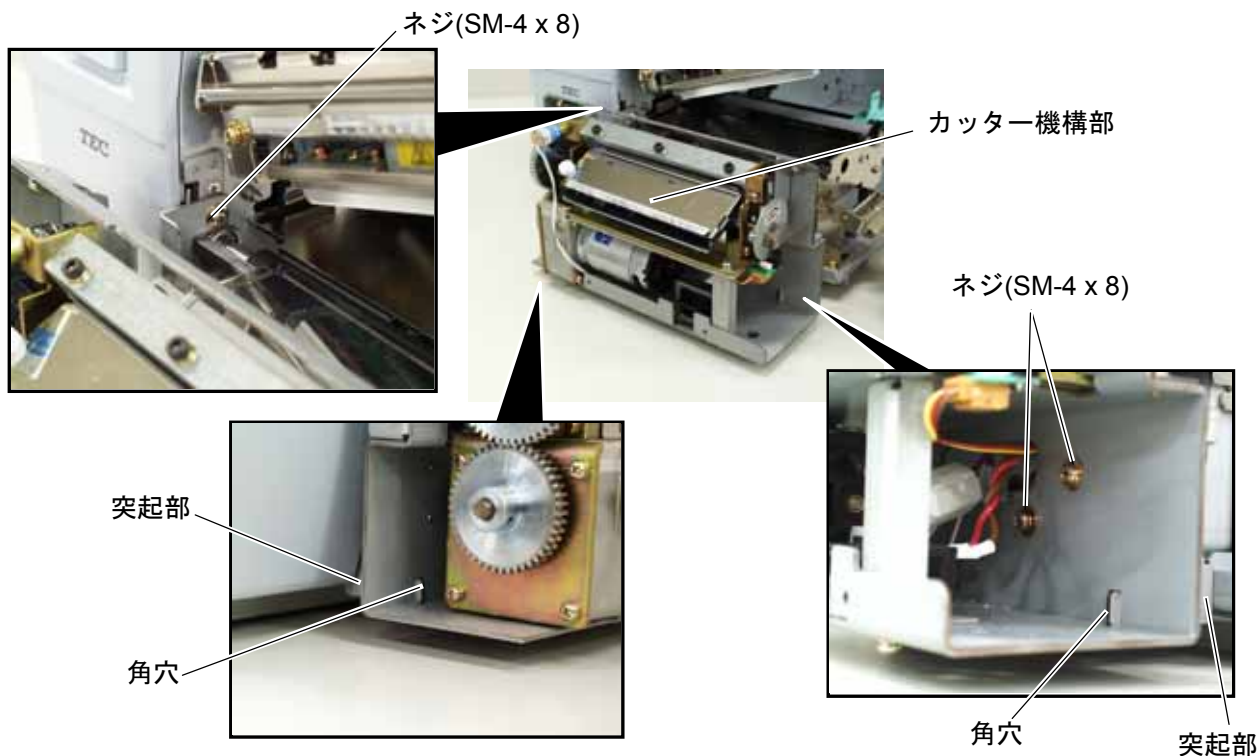

**補足** ケーブル類をかまないように、カッター機構部を固定してください。

- 17) カッターカバーを取り付け、カバーに付いている2本の化粧ネジで固定します。

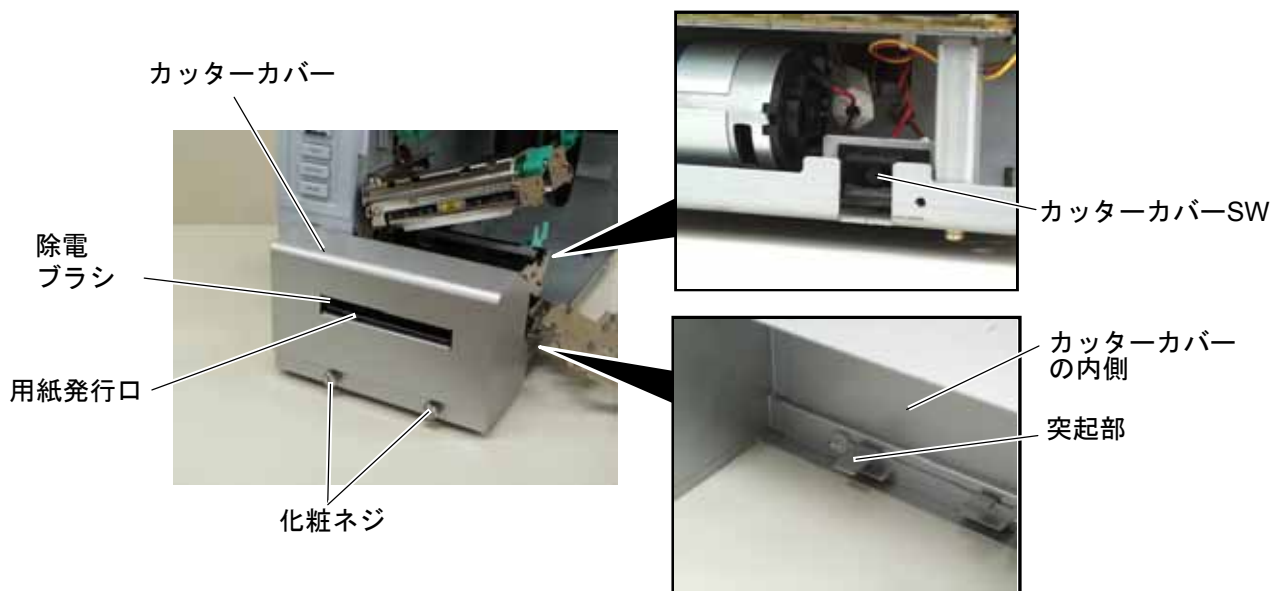

**補足**

- ・カッターカバーを取り付けたとき、カバー内側の突起部がカッターカバースイッチを ON にしていることを確認してください。
- ・ケーブル類をかまないように、カッターカバーを取り付けてください。
- ・用紙発行口から除電ブラシがはみ出していることを確認してください。



- 18) 印字ヘッド機構部のロックを解除して静かに下ろし、リボンシャフト固定板を閉めます。
- 19) 冷却ファンケーブルを接続し、左サイドカバーを取り付けます。  
**補足** ケーブル類をかまないように、左サイドカバーを確実に取り付けてください。
- 20) 用紙(必要ならばリボンも)をセットし、ヘッドレバーを **Lock** 位置まで回します。
- 21) プリンタの電源を ON にし、正しくカットされることを確認してください。

**東芝テック株式会社**

FMMB0067606  
Printed in Japan  
EO2-38009F  
©東芝テック株式会社 2008

## Free Manuals Download Website

<http://myh66.com>

<http://usermanuals.us>

<http://www.somanuals.com>

<http://www.4manuals.cc>

<http://www.manual-lib.com>

<http://www.404manual.com>

<http://www.luxmanual.com>

<http://aubethermostatmanual.com>

Golf course search by state

<http://golfingnear.com>

Email search by domain

<http://emailbydomain.com>

Auto manuals search

<http://auto.somanuals.com>

TV manuals search

<http://tv.somanuals.com>