



TOSHIBA

The power to open people's eyes

17WLT46B

Owners Manual

Contents

Contents

Wiring the plug	2
Remote Control	3
Control Panel	4
Features	5
Panel Features	5
Safety Precautions	6
Before Switching on your TV	7
Power connection	7
Connections to the RF input socket	7
How to connect other devices	7
Inserting batteries in the remote control handset	7
Switching the TV On/Off	8
To switch the TV on	8
To switch the TV off	8
Silence Mode	9
Tuning In	9
Changing Channels	11
Information Banner	12
Channel List	13
Electronic Program Guide	14
Current Programme	15
Next programme	16
Soundtrack Language	17
Digital Teletext	18
Subtitle	19
Configuring Your TV	20
Subtitle	21
Favourite Mode	21
IDTV Upgrade	22
Editing the Channel List	25
Channel and Menu Protection	27
Favourite Channels	29
Programme Reminders and Timers	30
Re-Installation	33
Common Interface Menu	37
Operating the TV	40
Operating with the buttons on the TV set	40
Operating with Remote Control ..	40
Menu System	41
Sound Menu	41
Picture Menu	44
Feature Menu	46
Installation Menu	47
Programme Menu	48
Source Menu	49
PIP Picture Menu	50
Other Features	50
TV Status	50

Programme Swap (P<P)	50
Double-digit (- / - -)	50
Personal Preferences (PP)	51
Sound Indicator	51
Picture Mode	51
Sleep Timer Indicator	51
Mute Indicator	51
No-Signal Detection (TV)	51
No-Signal Detection (PC)	51
Volume Bar	52
AV Modes	52
Signal Out Of Range	52
PC Mode	52
Installation	52
Switching from TV to PC	52
Main Menu in PC mode	52
Sound Menu	52
Picture Menu	53
PIP Picture	53
Feature Menu	53
Geometry Menu	53
Source Menu	54
PIP Source Menu	54
Teletext	55
To operate Teletext	55
To select a page of Teletext	55
To Select Index Page	55
To Select Teletext with a TV Programme	55
To Select Double Height Text	55
To Reveal "concealed" Information	55
To Stop Automatic Page Change	55
To Select a Subcode Page	55
Fastext	56
To exit Teletext	56
To Display the Time	56
Connect Peripheral Equipment	57
PC Sound Connection	57
Via the Euroconnector	57
Via Ant Input	57
Decoder	57
TV and Video Recorder	57
Playback NTSC	57
Search for and store the test signal of the video recorder	58
Camera and Camcorder	58
Connect the decoder to the video recorder	58
Connecting Headphones	58
Connecting the PC	58
Peripheral Equipment Connections	59
PC Input Typical Display Modes	61
Tips/Troubleshooting Guide	62
Specifications	64

Wiring the plug

If your TV is fitted with a non-rewireable plug and you need to change the fuse, you will need to refit the fuse cover. If you lose or damage the fuse cover, do not use the plug until you have replaced the cover with a new one. You can get one from us. Make sure you replace the fuse cover with one which is the same colour as the markings on the fuse.

If you have to change the plug because it is not suitable for your socket or it is damaged, cut off the plug and fit another one following the wiring instructions below. Please throw away the plug you have removed, as insertion into a mains socket could cause injury.

For your own safety, read the following instructions carefully before attempting to connect this unit to the mains.

WIRING INSTRUCTIONS

Your TV is designed to operate on 230 V, 50Hz current only. Connecting it to another power source may damage the TV.

The wires in the mains lead are coloured as follows.

Blue = Neutral Brown = Live

WARNING

To prevent electric shocks, remove the plug from the mains socket before you take off its cover.

IMPORTANT

The colours of the wires in the mains lead from your TV may not be the same as the coloured markings identifying the terminals in your plug. So please follow these instructions.

Connect the blue wire to the terminal marked with the letter N or coloured black.

Connect the brown wire to the terminal marked with the letter L or coloured red.

Do not connect any wire to the other terminal on the plug.

If you use a 13 Amp (BS1363) plug, you will need a 5 Amp fuse.

If you use any other type of plug, you will also need a 5 Amp fuse either in the plug or on the distribution board.

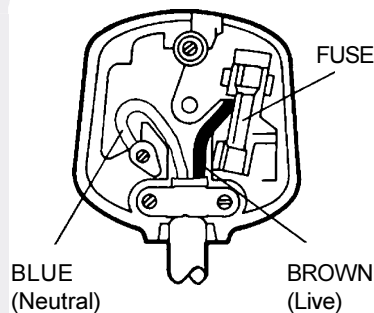

Remote control

Remote Control

- ① = Stand By
- ② = Cursor Up
- ③ = Cursor Right
- ④ **OK / SELECT** = Okay (Store) / Select
- ⑤ **INFO** = Info (Program Menu)
- ⑥ **0 - 9** = Direct Program
- ⑦ **BACK / -/-** = Cancel / Double Digit
- ⑧ **P<P** = Previous Programme
- ⑨ **P/CH +** = Programme Up
- ⑩ **+** = Volume +
- ⑪ **/ DTV** = TV / DTV mode
- ⑫ = External Source (AV-1, AV-2, AV-3, S-VIDEO, PC)
- ⑬ **Yellow (FEATURE)** = Feature Menu
- ⑭ **Blue (INSTALL)** = Installation Menu
- ⑮ = **Hold / Subtitle**
- ⑯ = Update
- ⑰ **/ GUIDE** = Index Page
- ⑱ = Reveal, **PC** = Switch from TV to PC
- ⑲ = Expand, **WIDE** = Aspect ratio
- ⑳ = **Mix**, = **PIP on / PIP off**
- ㉑ = Teletext
- ㉒ = Time
- ㉓ **Red (SOUND) /** = Sound Menu / Page up
- ㉔ **Green (PICTURE) /** = Picture Menu / Page down
- ㉕ = Mute
- ㉖ **I-II** = Mono/Stereo - Dual I-II
- ㉗ = Volume -
- ㉘ **- P/CH** = Programme Down
- ㉙ **PP** = Personal Preference
- ㉚ **M / MENU** = Menu
- ㉛ = Cursor Down
- ㉜ = Cursor Left

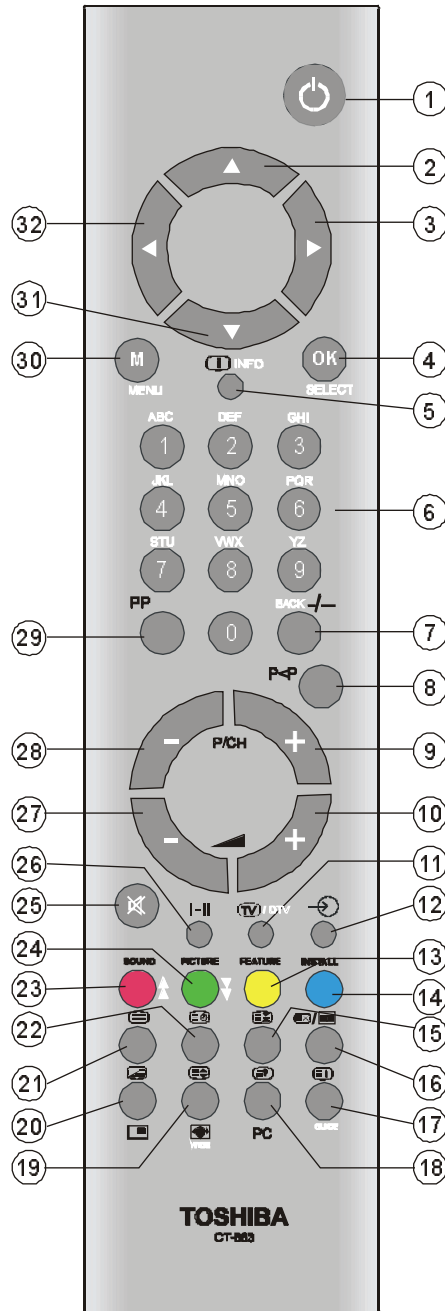

Control Panel

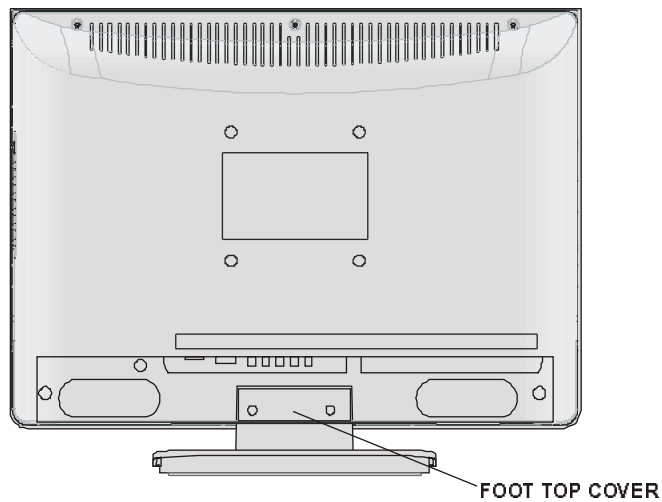
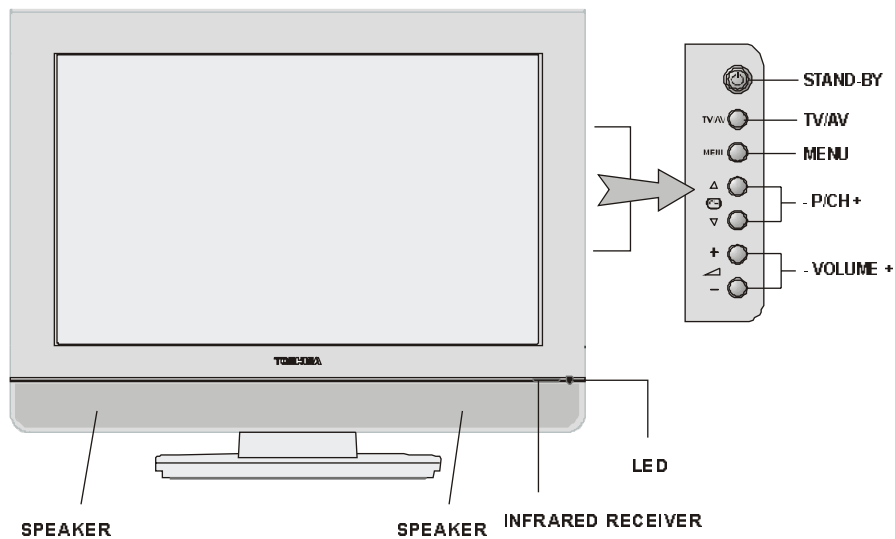

With certain combinations of connectors and leads the back cover may not be easily fitted. If the cover is left off, this in no way infringes safety requirements.

preparation

Install Display on solid horizontal surface such as a table or desk.

For ventilation, leave a space of at least 10 cm free all around the set. To prevent any fault and unsafe situations, please do not place any objects on top of the set.

This apparatus can be used in tropical and/or moderate climates.

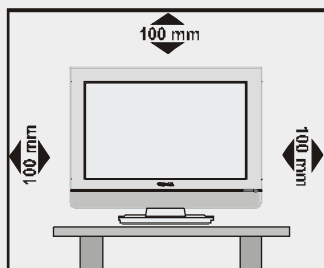

Features

- It is a remote controlled colour television and PC monitor.
 - 100 programmes from VHF, UHF bands or cable channels can be preset.
 - It can tune cable channels.
 - Controlling the TV is very easy by its menu driven system.
 - It has 2 pieces of Euroconnector socket for external devices (such as video, video games, audio set, etc.)
 - To use as a monitor, 15 Pin Mini D-Sub connector for computer.
 - Optional stereo sound systems (German or German+Nicam) are available.
 - Multilanguage OSD.
 - Teletext (Fastext (7 pages), Toptext).
 - It is possible to connect headphone.
 - A.P.S. (Automatic programming system)
 - All programmes can be named.
 - Programme swapping between last watched two programmes.
 - Forward or backward automatic tuning.
 - Sleep timer.
 - Child lock
 - Auto, 4:3, 16:9, Cinema, Subtitle, Zoom and Panorama modes.
- Automatic sound mute when no transmission.
 - When no valid signal is detected, after 5 minutes the TV switches itself automatically to stand-by mode.
 - NTSC Playback
 - Universal power supply range is a standard feature on this model.
 - TV Picture in PC (if PC input available).
 - TV Picture and PC
 - PLL (Channel Search)
 - PC input (Support Up to 1280 x 768)

Panel Features

- High resolution (1280 x 768), 17"-inch TFT LCD display.
- High contrast ratio (400:1 Typical)
- Brightness: 450 cd/m²
- High-speed response time < 25 msec.
- Wide viewing angle (typical) 176° (horizontal) and 176° (vertical).
- 8-bit colour depth, display 16.7 M colours.

Safety Precautions

1. Power Source

The TV set is designed to operate on **15 V DC**. The adaptor should be operated from a **230V AC, 50 Hz.** outlet. Ensure you select the correct voltage setting for your convenience.

2. Power Cord

The power supply cord should be placed so that it is not likely to be walked on or pinched by items placed upon them or against it. Pay particular attention to cord where it enters the plug, power outlet, and the point where it exits from the receiver.

3. Moisture and Water

Do not use this equipment in a humid and damp place (avoid the bathroom, the sink in the kitchen, and near the washing machine). Do not expose this equipment to rain or water, as this may be dangerous and do not place objects filled with liquids on.

4. Cleaning

Before cleaning, unplug the adaptor from the main supply, outlet. Do not use liquid or aerosol cleaners. Use soft and dry cloth.

5. Ventilation

The slots and openings on the receiver are intended for ventilation and to ensure reliable operation. To prevent overheating, these openings must not be blocked or covered in anyway.

6. Lightning

In case of storm and lightning or when going on holiday, disconnect the power cord from the wall outlet.

7. Replacement Part

When replacement parts are required, be sure the service technician has used replacement parts which are specified by the manufacturer or have the same specifications as the original one.

8. Servicing

Please refer all servicing to qualified personnel. Do not remove cover as this may result in electric shock.

9. Naked Flame Sources

Do not place naked flame sources on the apparatus.

WARNING: When the device is not in use for a long time, disconnect from power.

Instructions for waste disposal:

- Packaging and packaging aids are recyclable and should principally be recycled. Packaging materials, such as foil bag, must be kept away from children.
- Battery, including those which is heavy metal-free, should not be disposed of with household waste. Please dispose of used battery in an environmentally sound manner. Find out about the legal regulations which apply in your area.
- Cold cathode fluorescent lamp in LCD PANEL contains a small amount of mercury, please follow local ordinances or regulations for disposal.

"DO NOT LEAVE YOUR TV AT STAND-BY OR OPERATING WHEN YOU LEAVE YOUR HOUSE"

"The LCD panel is very high technology product with about a million thin film transistors, giving you fine picture details. Occasionally, a few non-active pixels may appear on the screen as a fixed point of blue, green or red. Please note that this does not affect the performance of your product."

Before Switching on your TV

Before Switching on your TV

Power connection

Only use the adaptor supplied with this product.

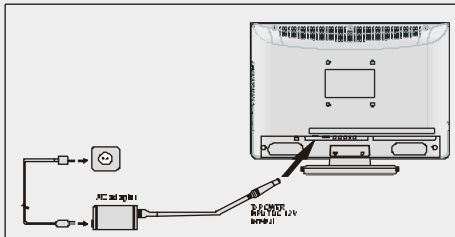

IMPORTANT: The TV set is designed to operate on 12 V DC. For this, an adaptor is used which gives 12V DC voltage. Connect this adaptor to a system that supplies 230V AC, 50 Hz.

- After unpacking, allow the TV set to reach the ambient room temperature before you connect the set to the mains.

Connections to the RF input socket

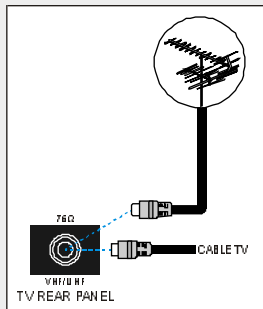

- Connect the aerial or cable TV plug to the RF input socket located at the back of the TV and connect the cable plug coming out from the TV out socket located at the devices (VCR, DVB etc.) to this socket as well.

How to connect other devices

IMPORTANT: Switch off the TV before connecting any external device.

Sockets for external connections are at the back of the TV. For connection of other devices via Euroconnector refer to the manuals of the related devices.

Inserting batteries in the remote control handset

- Remove the battery cover located on the back of the handset by gently pulling upwards from the indicated part.
- Insert two AAA (R03)/UM4 or equivalent type of batteries inside.
- Replace the battery cover.

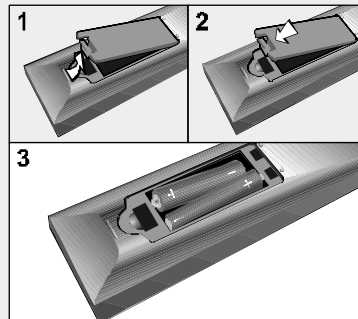

NOTE: Remove battery from remote control handset when it is not to be used for a long period. Otherwise it can be damaged due to any leakage of battery.

Old batteries must be disposed in a designated area. If performance of the remote control reduces, replace the batteries with the correct type. Do not combine a used, old battery or a new one or mixed battery types. Remove dead batteries immediately to prevent acid from leaking into the battery compartment.

Switching the TV On/Off

To switch the TV on

Your TV will switch on in two steps:

1- Connect the power supply cord to the system. Press the "⏻" button on the right side of the TV. Then the TV switches itself to stand-by mode and the led becomes sapphire blue located on the front of the TV.

2- To switch on the TV from stand-by mode either:

Press the "⏻" button on the remote control,

or,

Press a digit button on the remote control so that a programme number is selected,

or,

Press "P/Ch" button on the right side of the TV or press "-P/CH" or "P/CH+" buttons on the remote control, so that last switched off programme is selected.

By either ways the TV will switch on and diminishes the brightness of the led.

To switch the TV off

NOTE: To switch the TV off completely remove the mains plug from the socket.

- Press the "⏻" button on the remote control, so the TV will switch to stand-by mode and the LED will become sapphire blue.

or,

Press the "⏻" button located on the right side of the TV, so the TV will switch off and the BLUE LED will turn off.

preparation

Silence Mode

"When you turn off your IDTV by pressing Stand-by key (on RC) , IDTV switches into SILENCE mode and the led on the front of IDTV starts blinking. Also, IDTV switches into SILENCE mode automatically everyday at 3.00 a.m.

In the silence mode IDTV searches for a new software. If a new software is found, it is loaded onto the old s/w without any warning message. TV exits from stand-by mode after loading process.

You can terminate silence mode any time you want by pressing "P/CH+ / - P/CH" or numeric keys.

Tuning In

Your TV will switch on in the digital mode. Because this is the first time that the TV has been used, there are no channels stored in the memory and the following menu is displayed on the screen.



Press "SELECT" key on the remote control to start the automatic search.

The TV will automatically tune to the UHF transmission channels 21 to 68 looking for digital terrestrial TV broadcasts and displaying the names of channels found. This process will take about three minutes.

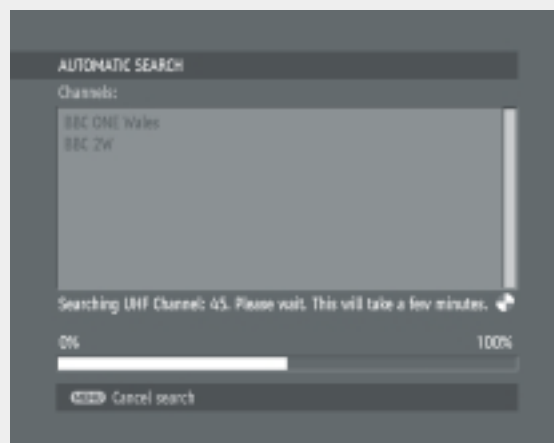

preparation

After Automatic search is finalized the following menu appears.

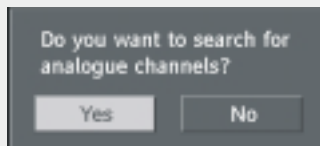

If you select "Yes"

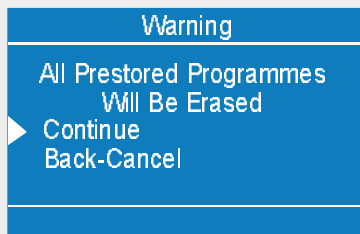

Press "◀" or "▶" key to continue. The following menu appears on the screen.

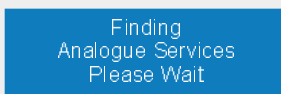

After A.P.S. is completed program table is displayed on the screen. See the "Programming" menu in terrestrial TV section.

If you select "No", the first channel of the channel list and the information banner is displayed you can now watch digital terrestrial television, selecting the channel you require as described in the next section.

HINT

Depending on the reception conditions in your particular area, you may find that the list of channels found includes one or more repeated names. This is because the TV may detect and store some channels, including those it cannot receive clearly, from adjacent areas alongside the strong channels from a transmitter nearby. This is not a problem and the weaker channels can be deleted from the TV later, as described in "ADVANCED OPERATION - Editing the channel list" section.

If no digital terrestrial television broadcasts are found the TV will display a message:



You should then refer to the Tips/Troubleshooting Guide to establish the cause of the problem.

everyday operation

There are a great many keys to use in different situations. Many of the menu screens displayed by the TV have reminders as to which keys do what, at the base of the screen. In addition, many screens have further help available which is displayed when the **INFO** key is pressed, as prompted at the bottom right of the screen.

Pressing the **TV / DTV** key at any time while watching television programmes will switch the TV set between displaying the digital terrestrial television programme and its normal analogue television reception.

Changing Channels

You can select the channel you wish to watch in one of four ways - stepping through the channel list, selection by number, from the on-screen channel list, and using the electronic programme guide (EPG).

To move through the channel list, press the **P/CH+** or **- P/CH** keys on the remote control. Pressing the **P/CH+** key will select the channel next in the channel list. Pressing the **- P/CH** key will select the previous channel in the list.

Pressing the **P/CH+** key when the last channel in the list is being viewed will select the first channel. Similarly, pressing the **- P/CH** key when the first channel is displayed will select the last channel in the channel list.

You can also select the required channel using its channel list number. Channel numbers are entered using the number keys on the remote control handset and can be up to three digits long.

Hint

The channel list numbers are assigned by the broadcasters. Because not all channels are broadcast free-to-air and stored by the TV, the channel list numbers do not run continuously.

The fifteenth channel in the list, for example, may not be channel number 15 but channel number 17.

When you press a number key on the remote control, a small box appears in the top left of the screen to show the entered number. After each digit is entered, the TV will wait up to two seconds for the next digit to be pressed until either three digits have been entered or you do not press a digit in time. The channel corresponding to the entered number in the box will then be selected.

Hint

If you enter a number which does not correspond to a stored channel, the next valid channel number is selected instead. If you enter a number greater than the highest numbered channel in the channel list, the TV will select the last channel in the list.

everyday operation

Information Banner

Whenever you change channel, using the "P/CH+" and "- P/CH" keys or the number keys, the TV displays the channel picture along with an information banner at the bottom of the screen. This will remain on the screen for approximately three seconds. The information banner can also be displayed at any time while watching TV by pressing the "i INFO" key on the remote control. Pressing the "i INFO" key again removes the banner.

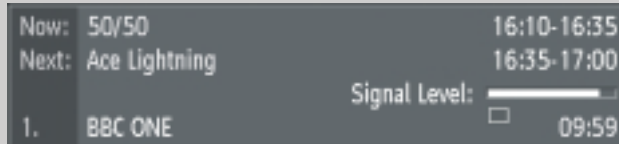

Now:	50/50	16:10-16:35
Next:	Ace Lightning	16:35-17:00
1.	BBC ONE	Signal Level:  09:59

Hint

Not all channels broadcast the programme data. If the name and times of the programme is not available then "No Information Available" is displayed in the information banner.

Icons are also displayed in the information banner and if this channel is a favourite channel (see ADVANCED OPERATION - Favourite Channels section).



favourite channel

The information banner gives a number of facts on the channel selected and the programmes on it. The name of the channel is displayed, along with its channel list number and an indication of the strength of the signal received on this tuning channel.

The name and the start and finish time of the programme currently showing on the selected channel are given, and the current time.

everyday operation

If the selected channel is locked (see Advanced operation- Channel protection), you must enter the correct four digit code to view the channel.

Alternatively, the "P/CH+" or "- P/CH" keys are used to move to another, unlocked channel.

Enter Lock Key

*

Channel List

You can also select the required channel directly from the on-screen channel list. First bring up the menu with the "MENU" key on the remote control handset.

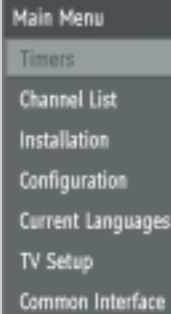

Main Menu
Timers
Channel List
Installation
Configuration
Current Languages
TV Setup
Common Interface

Using the "▲" or "▼" keys on the remote control, make sure that the first item, Channel List, is highlighted in yellow and press the "SELECT" key, to display the channel list.



everyday operation

Here, you can preview any channel stored by the TV before viewing it full screen. The complete list of channels is displayed in pages of 10 channels at a time, with their channel list number and a favourite channel icon if appropriate. (see Advanced operation-Favourite channels). The name and a quarter-screen image of the channel last viewed is displayed on the upper right of the screen.

Using the “▲” or “▼” keys, the highlight is moved through the list to the channel required. The “▲” and “▼” keys can also be used to move forward or back a complete page (ten channels) at a time. Pressing “SELECT” key now changes the quarter-screen display to show the highlighted channel.

Hint

From the Channel List screen, it is possible to edit the channel list, including changing the name of stored channels or deleting them. Editing the list is covered in Advanced operation- Editing The Channel List.

When using the Channel List to select channels, use the “◀” or “▶” keys to ensure that the highlighted button at the bottom of the screen is SELECT, so no editing functions are accidentally begun.

When you leave the Channel List screen, by pressing “MENU” key the channel showing on the quarter screen is selected for normal viewing on the whole screen.

Electronic Program Guide

The fourth way of selecting a channel is with the electronic programme guide, or EPG. The EPG is accessed by pressing the “GUIDE” key. Like the Channel List, the EPG screen displays a list of the stored channels (in pages of five channels) along with information on what programmes are being broadcast.

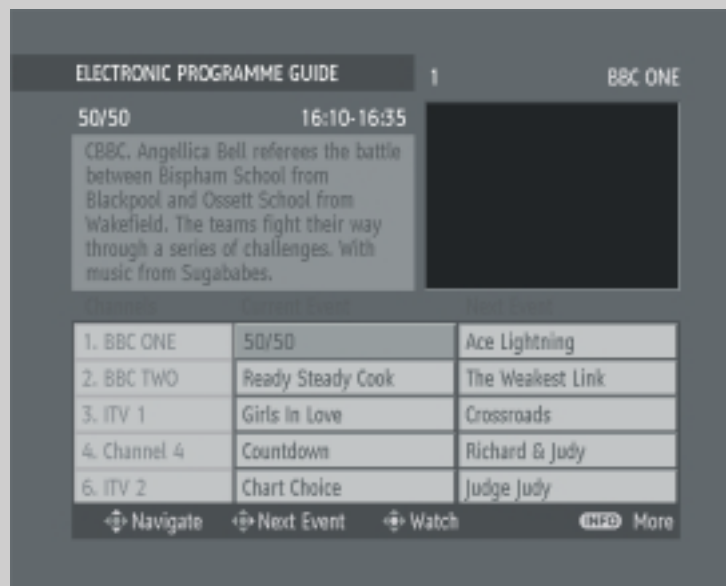

everyday operation

Current Programme

The channels are listed at the bottom of the screen, each with the 'current event' (the name of the programme showing at that time) and the 'next event' (the following programme). When the EPG screen is first displayed, the channel last watched is highlighted in the list of channels. A quarter-screen image of this channel is displayed at the upper right of the screen along with the channel name and channel list number.

Hint

If the channel you have been viewing is a digital teletext channel then no picture will appear in the quarter-screen window.

Details of the current programme on that channel (the name of the programme and, typically, a synopsis with details of the stars involved, the teams playing, or similar information) along with the start and finish times are displayed at the top left inside the dark blue text window.

Hint

Not all channels broadcast all the programme information data. Some channels do not provide the current and next event data and/or the programme details. In this case the programme names and/or the details are not displayed. This is not a fault with your TV.

Moving the highlight through the list of channels using the "▲" and "▼" keys will change the programme details in the text window to reflect the channel highlighted. The quarter-screen window continues to show the channel last watched, so you can stay watching a programme while at the same time browse the details of what's on, on other channels.

You may then select the highlighted channel for viewing on the quarter-screen window by pressing the "SELECT" key.

You can leave the EPG screen, to enjoy normal full-screen viewing of the channel in the quarter-screen

everyday operation

Next programme

While the EPG screen is displayed, pressing the "▶" key highlights, in dark blue, the next event name in the list of channels and displays the highlighted channel's programme details for the next event (the programme following the current programme) in the text window.

As before, you can browse through the list, checking the programmes coming up next on all the channels.

Hint

If the programme details text for the current or next event is too long to fit into the text window on the EPG screen, a scroll bar appears on the right hand side of the window and the text can be scrolled up or down using the "YELLOW" and "BLUE" keys on the remote control. Using "▲" or "▼" keys will display the next/previous 5 channels in the list.



Pressing the "SELECT" key while the next event details are displayed will set a reminder to watch that programme. See Advanced operation- Programme Reminders And Timers.

You can return to the current programme display by pressing the "◀" key or to normal television viewing (to watch the channel last selected in the EPG screen) by pressing the "GUIDE" key again, or the "MENU" key.

everyday operation

Soundtrack Language

Some programmes are broadcast in two or more languages simultaneously.

The language heard can be selected from the Language Menu. Press "MENU" key to display the Main Menu and use the "▲" or "▼" keys to highlight the **Current Languages** line and press "SELECT" key. Use the "▲" or "▼" keys to highlight the soundtrack language required and press "SELECT" key. Normal viewing, with the required language soundtrack, can be resumed by pressing the "MENU" key.

If the programme has no alternative language soundtrack broadcast, the Language Menu will not be available, but a message, 'No Multi Language Available' is displayed briefly.



everyday operation

Digital Teletext

Many digital terrestrial television channels not only broadcast pictures and sound for programmes but also pages of information on the programmes, the weather, news and many other topics.

Some channels are entirely given over to digital teletext and carry no normal TV programme at all. These dedicated digital teletext channels will not give a quarter-screen image in the EPG or the Channel List screen. When such a channel is selected, after a brief pause, they will usually display the opening page of information automatically.

Other channels have digital teletext pages broadcast alongside the television programme and often include a reduced-size broadcast picture within digital teletext pages. These usually require the teletext keys to be pressed to activate the digital teletext pages.

In both cases, moving through the different pages of information is accomplished in a variety of ways, dependent on the individual broadcasters, but including use of the “▲”, “▼”, “◀”, “▶” and “SELECT” keys to select items from on-screen menus, and the coloured keys to jump directly to particular pages.

You can exit any digital teletext channel by changing channel in any of the normal ways. You can leave the digital teletext function of a combined digital teletext/programme channel, to return to normal television viewing of that channel, by pressing the “≡” key.

Hint

Calling for the information banner or any menu on-screen stops the TV from displaying the digital teletext pages and they are temporarily replaced by a blank picture while the banner or menu is displayed. Digital teletext cannot be accessed when the Subtitles are enabled (See Advanced operation - Configuring Your Receiver.



everyday operation

Subtitle

Subtitle key Shows/hides subtitles of channel. When the  subtitle key is pressed, subtitle ON/OFF message is displayed.

Subtitles ON

Subtitles OFF

When the IDTV is in DIGITAL TV mode, this time the TV scart is switched on and the TV is switched to AV/RGB mode. And also, when there is no menu on the screen , pressing  key will manually toggle the IDTV between VCR mode and TV mode. In VCR mode IDTV will display the output of VCR device , In TV mode IDTV displays its own outputs. If IDTV scart mode is not changed by pressing  key , scart mode will be automatically detected . (For example if a dvd player is connected to VCR scart and powered on , then the IDTV will immediately switch to VCR mode. The IDTV will switch to TV mode if dvd player is switched off)

KEY

If there is no connected VCR device, The  key is used to toggle TV and DIGITAL TV modes. When the IDTV is in TV mode, the TV scart is not switched and the TV operates in analog mode.

TIME () KEY

When the TV is in analog mode; if  key is pressed, time information that comes from the analog teletext is displayed on the screen.

If  key is pressed when the TV is in digital mode, digital broadcasting time information is displayed.

advanced operation

Configuring Your TV

The Configuration menu screen is accessed from the Main Menu. Press the “MENU” key to display the Main Menu and the “▼” key **three times** to highlight Configuration, then press “SELECT” key to display the Configuration menu screen.

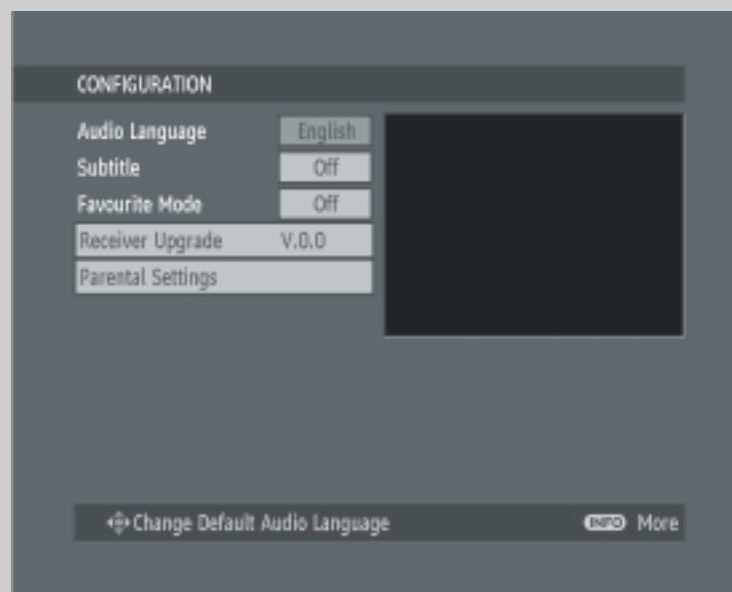

The various configuration functions are displayed in a list, along with a quarter-screen image of the currently selected channel. You can select a function by highlighting the corresponding menu line with the “▲” or “▼” keys. There are five configuration functions.

AUDIO LANGUAGE

Digital terrestrial television channels can broadcast simultaneous soundtracks in more than one language. This function selects which language soundtrack you will hear when switching to a channel broadcasting with multiple soundtracks. See also Everyday operation - Audio Control.

Highlight the Audio Language line in the Configuration menu and use the “◀” or “▶” keys to cycle through the language options.

Return to normal TV viewing by pressing the “MENU” key.

Digital terrestrial television channels can broadcast with subtitles displayed on screen for the hard-of-hearing. This function selects the desired subtitle language and enables the automatic display of subtitles whenever subtitle information is broadcast.

Highlight the subtitle line in the Configuration menu and use the “◀” or “▶” keys to cycle through the disable and language options.

Return no menu to normal TV viewing by pressing the “MENU” key.

advanced operation

Subtitle

Selecting subtitle language other than "Off" will activate the subtitle language. When the subtitle language is activated, subtitle will be displayed on the screen if any matching subtitles are available.

Digital teletext and subtitles can not be activated at the same time. When you set the subtitle language from the configuration menu and try to activate digital teletext by pressing "Ⓜ" or colour buttons the following message appears.

Interactive services cannot be used
while subtitles are on. Would you like
to turn subtitles off now?

Yes

No

Therefore if you want to activate the digital teletext, you should set the subtitles off from the configuration menu.

Favourite Mode

This function enables or disables the favourite channel list mode. See Advanced operation - Favourite Channels.

PARENTAL SETTINGS

This function enables or disables the menu protection system and allows the PIN code to be changed. See Advanced operation - Channel And Menu Protection.

Enter Lock Key

*

If wrong Lock key is entered, the following message is displayed on the screen.

Wrong Lock Key

advanced operation

IDTV Upgrade

The IDTV can be upgraded via the configuration menu, entered from the main menu.

In the configuration menu, there is the "Receiver Upgrade" button. Upgrade process can be started by pressing this button.

There are two possibilities for IDTV software to be upgraded: automatic and manual. Automatic upgrade can be enabled or disabled by pressing "◀"/▶" buttons. If it is enabled, then there are two ways for automatic upgrade. The first one is checking the existence of a new software every time the IDTV goes to standby. The second one is waking up at 03:00 a.m. every night, provided that the IDTV is left in standby mode. Both automatic upgrade methods result in standby mode either upgraded or not. If the automatic upgrade is set to 'Disable' then this function will not work.

Manual upgrade starts if the 'Search for New Version' button is pressed.

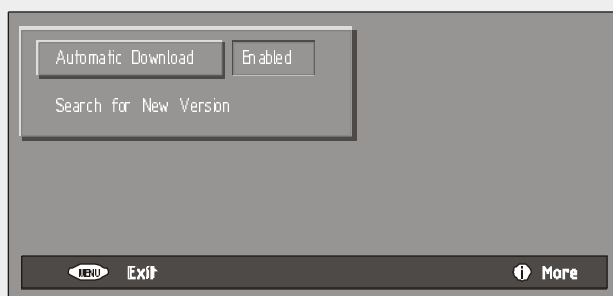

After pressing the 'Search for New Version' button, the IDTV tunes to each frequency that have been stored in its database and looks for the new software. Since this process takes some time, a warning message is displayed.

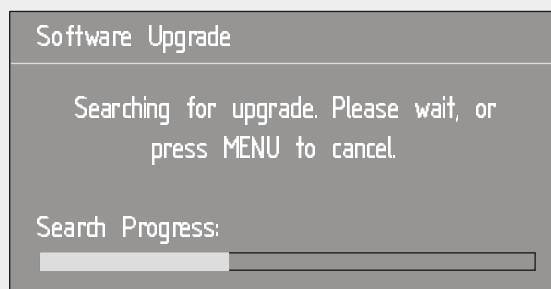

Depending on the existence of a new software, two different messages can appear on the screen: 'No new software was found' or 'New sw loaded. Please wait...'

advanced operation



IDTV returns to the configuration menu if there is no new software.

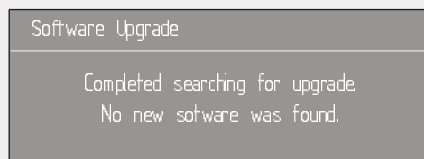

If there is a new software, the following message appears.

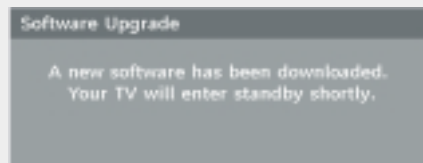

Downloading will be displayed on the screen by a message and a progress bar, together with a percentage button will indicate the status.

User can cancel the upgrade any time by pressing the "MENU" key.

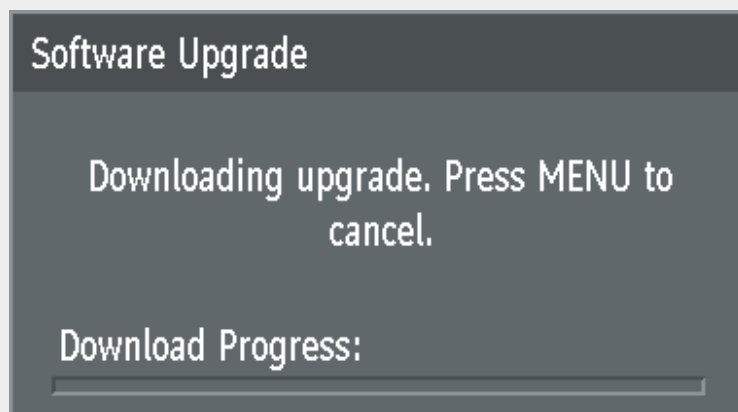

After loading the software into memory, it will be written permanently. This situation will be shown displaying a message.

advanced operation

When the upgrade is finished a message box indicating this will appear and the IDTV will go to standby in order the changes to take place.

Software Upgrade

A new software has been downloaded.
Your TV will enter standby shortly.

advanced operation

Editing the Channel List

The digital terrestrial television channels found by the TV when first installed are stored in its memory as a channel list. This list can be altered and amended to remove unwanted channels and to suit your own preferences.

First bring up the Main Menu with the “MENU” key on the remote control handset. Then, using the “▲” or “▼” keys on the remote control, make sure that the first item, Channel List, is highlighted in yellow and press the “SELECT” key, to display the Channel List.



The Channel List screen displays the list of channels in the TV's memory, with a quarter-screen image window showing the selected channel, and can be used to change channels for viewing, delete channels from the memory, edit the name of the channel as it appears in the list and on-screen, lock a channel against viewing by younger members of the family, and set up favourite channels.

Channel List functions are carried out on one channel at a time. The channel to be affected is first highlighted in the list using the “▲” or “▼” keys. You can move faster through the list using the “▲” or “▼” keys to move up or down a complete page of 10 channels in one jump.

advanced operation

SELECT

This function selects a channel for viewing and is an alternative to using the "P/CH+" and "- P/CH" keys, channel number or EPG. Highlight the channel to be viewed, highlight the "SELECT" button at the base of the screen using the "◀" or "▶" keys and press "SELECT" key. The highlighted channel now appears in the image window and you can leave the Channel List to view the channel by pressing "MENU" key.

DELETE

Duplicate entries can be produced in the channel list from transmitters operating at different frequencies in adjacent areas, and you may wish to delete these duplicate entries from the list. In addition, the channel list may include the channels which you do not want in the list.

Highlight the channel to be deleted, highlight the DELETE button at the base of the screen using the "◀" or "▶" keys, and press "SELECT" key. The warning message "The selected service will be permanently deleted. Are you sure?" is displayed on the screen. Press "SELECT" key. The highlighted channel is deleted from the list.

You can now perform further editing on the channel list, or return to normal broadcast viewing by pressing the "MENU" key.

EDIT NAME

The channel names which appear in the channel list and the information banner are assigned by the broadcasters and some longer names are abbreviated to become unrecognisable. You can edit the names to suit your preferences with the Edit Name function.

Highlight the channel to be renamed, highlight the EDIT NAME button at the base of the screen using the "◀" or "▶" keys, and press "SELECT" key. The highlighted channel name appears on the right of the screen with the first character highlighted by a cursor. Any of the 16 characters that make up a channel name can be highlighted using the "◀" or "▶" keys and the highlighted character changed by pressing the "▲" or "▼" keys to cycle through the alphabet, numbers and other characters available.

Hint

You can also enter a channel name using the number keys on the remote control. Each key represents several letters (as marked on the remote control) and pressing a key several times will enter each letter (in both capitals and lower case), and the number, in turn, in the character position marked by the cursor. The zero key enters all the punctuation marks available and a blank space. With practise, this is a very quick means of entering the required letters into the channel name.

When the required changes have been made, pressing "SELECT" key stores the new name and returns to the Channel List screen. Alternatively, pressing "MENU" key will abandon the name change and return to the previous name.

You can now perform further editing on the channel list, or return to normal broadcast viewing by pressing the "MENU" key.

Using the other two functions of the Channel List menu screen - LOCK and FAVOURITES - is dealt with in the next sections.

advanced operation

Channel and Menu Protection

CHANNEL LOCK

Some channels broadcast material which you do not want younger members of the family to watch. Any channel can be 'locked' so that it cannot be selected for viewing without first a four-digit PIN code being entered. In this way any channel not suitable for younger viewers can be protected.

The channel lock is applied with the Channel List menu. Press the **"MENU"** key on the remote control handset to display the Main Menu and then, using the **"▲"** or **"▼"** keys on the remote control, make sure that the first item, Channel List, is highlighted in yellow and press the **"SELECT"** key.

Highlight the channel to be locked using the **"▲"** or **"▼"** keys. You can move through the list 10 channels in one jump using **"▲▲"** or **"▼▼"** keys. Now select the LOCK button at the base of the screen with the **"◀"** or **"▶"** keys and press **"SELECT"** key.



Locked Channel

A window requesting the PIN code is displayed and the four-digit code should be entered using the number keys on the remote control, followed by the **"SELECT"** key. A lock icon is then displayed alongside the channel name in the channel list.

Hint

The PIN is factory set to 0000.

This code should be reset (as described below) to another sequence of numbers, known only to you, when you have finished setting up the TV.

You can now leave the Channel List screen and return to normal TV viewing by pressing **"MENU"** key. Any attempt to change channel to the locked channel will now display the same window requesting the PIN code and the channel will only be displayed on entry of the correct code. To remove the lock on a channel, repeat the same process as to lock the channel.

Enter Lock Key

*

advanced operation

MENU LOCK

Simply locking a channel will not deflect a determined would-be viewer. Re-installing the complete channel list, for example, will bypass the channel lock. However, the menus can be locked out of use too, to prevent this.

Display the Main Menu by pressing the **"MENU"** key, highlight Configuration, and press **"SELECT"** key to display the Configuration menu screen. Highlight the Parental Settings line of the menu (press **"▼"** key four times) and press **"SELECT"** key to display the Parental Settings menu (after the PIN code has been entered). Here the menu lock-out can be set and the PIN code changed.

With the Menu Lock line highlighted, use the **"◀"** or **"▶"** key to cycle the menu lock setting through Disabled, Main Menu and Installation. The Main Menu setting will lock out the complete menu system; the Installation Menu setting locks only the Installation menu (see Advanced operation - Re-installation); and the Disabled setting allows free access to any of the menus.

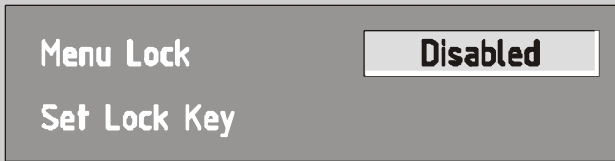

Menu Lock
Set Lock Key

Disabled

Hint

If you want the channel and menu locks to work efficiently and actually protect channels from access, do change the PIN code from the factory default. Make sure that you choose a number that is not obvious to others but one that can be remembered by you.

The same Parental Settings menu is used to change the PIN code. With the Set Lock Key line highlighted, press **"SELECT"** key to display the Set Lock Key window. This requests the new four-digit code to be entered twice (for confirmation) and the new code comes in effect when you return to the Configuration menu by pressing **"MENU"** key.

You must return to normal TV viewing by pressing the **"MENU"** key (three times) to activate the lock. Now any attempt to access the locked menus will display the PIN request window and the menus will only be displayed on entry of the correct PIN code.

Enter Lock Key

*

Lock Key

Confirm

Lock Key Changed

advanced operation

Favourite Channels

There will be some channels that you tend to watch more often and some only occasionally. Although some duplicate or scrambled channels you may want to delete from the channel list, others although not watched frequently, you will not want to do away with altogether. The favourite mode allows the most-watched channels to be accessed more easily, leaving the less-watched channels accessible but out of the way.

When the favourite mode is activated, the "P/CH+" and "- P/CH" keys cycle through the favourite channels only and the EPG will list the favourite channels only (other channels can still be accessed by channel list number or from the Channel List menu screen).

Any channel can be a favourite channel and the Channel List menu is used to label those channels you want as favourites.

Display the Channel List menu screen by highlighting Channel List on the Main Menu and pressing "SELECT" key.



Use the "◀" or "▶" keys to highlight the "Favourites" button at the base of the screen and then, in turn, highlight each channel that is required to be a favourite channel, using the "▲" and "▼" keys (and the "▲" or "▼" keys), and press "SELECT" key. A channel selected as a favourite appears in the main channel list with a favourites icon against the channel name.

advanced operation

A channel can have its favourites status removed by repeating this procedure, to remove the icon. Leave the Channel List menu by pressing **"MENU"** key.

Once the required channels have been marked as favourite channels, the favourite mode can be activated to allow easy access to them. Press the **"MENU"** key to display the Main Menu, the **"▼"** key **three times** to highlight Configuration, and press **"SELECT"** key to display the Configuration screen. Press the **"▼"** key two times to highlight the Favourite Mode line and using the **"◀"** or **"▶"** keys change the setting from Off to On.

When you leave the Configuration menu by pressing **"MENU"** key the favourite mode is activated. Now, changing channel using the **"P/CH+"** or **"- P/CH"** keys will switch to only those channels marked as favourites in the channel list. Similarly, the on-screen list in the electronic programme guide contains only the favourite channels.

You can still access all the channels in the channel list by keying in their channel list number or by selection from the Channel List screen. Alternatively you can switch off the favourite mode from the Favourite Mode line of the Configuration menu.

Hint

The favourite mode can only be activated if one or more channels in the channel list are marked as favourites. Similarly, if the favourite status is removed from all the channels in the Channel List, the favourite mode is turned off automatically.

Programme Reminders and Timers

With the greatly extended channel choice that digital terrestrial television brings, it is all too easy to miss a favourite programme. The TV has two facilities built in to help you make sure you catch all the TV shows you want.

PROGRAMME REMINDERS

Programme reminders can be set to signal that a programme is about to start when you are watching another channel. A reminder is set from the Electronic Programme Guide screen.

Press the **"GUIDE"** key to display the EPG screen and press **"▶"** key to display the next programme details in the text window and highlight the name of the next programme in the list of channels. Press **"SELECT"** key when a programme you want to watch is highlighted and the reminder icon is displayed against that programme's name. You can exit the EPG screen in the normal way - pressing **"GUIDE"** key or **"MENU"** key. Later, shortly before the programme is due to start, the TV will display a reminder on the screen over the picture of the channel being viewed.

Use the **"◀"** or **"▶"** keys to highlight the YES or NO buttons as appropriate and press **"SELECT"** key. If you select the YES button, the TV switches over to the reminder channel.

advanced operation

EVENT TIMER

You can also set a timer to switch the TV to any channel without your intervention. This is intended for making video recordings of programmes when you are out. If a single programme is to be recorded, the TV can be left switched to the required channel and the timer set on the VCR. However, if two or more programmes on different channels are to be recorded then the timer is set as well, to select the required channel when it is needed.

Display the Main Menu by pressing the "MENU" key and highlight and select the Timers line to display the Timer menu screen. Up to **eight** separate timer events can be set and each is displayed in the Timer screen, showing the event number, the channel to be selected, the start time, end time, date and the mode - whether that event is active (and will be acted on) or not.

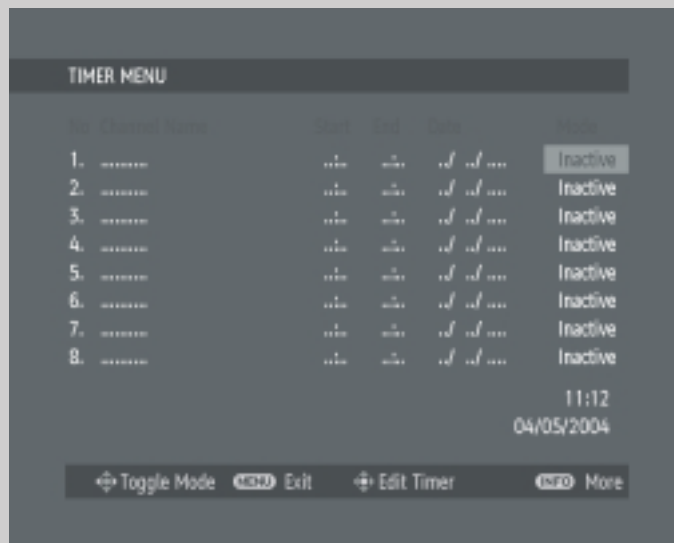

To set an event, highlight its mode button using the "▲" or "▼" keys and press "SELECT" key to display the timer entry window. Here the five settings of channel name, start time, end time, date and frequency mode can be set. You can move freely between each setting using the "▲" and "▼" keys. The channel name is set using the "◀" or "▶" keys to display the channel which broadcasts the programme to be recorded. The start time, end time and date are each set with the number keys on the remote control in 24-hour format. The frequency mode determines how often the TV operates this event and is set with the "◀" or "▶" keys to be either Once, Daily or Weekly.

advanced operation

Name:	3.ITV 1
Start:	20:00
End:	21:00
Data:	12/05/2003
Mode:	Once

Hint

If an invalid number for the start or end times or the date is entered, "Entered time is not valid." message is displayed on the screen.

Pressing "MENU" or "SELECT" key returns to the Timer screen with the settings in place in the timer event list. The event mode is automatically set to Active and you can now return to normal viewing (press the "MENU" key) and at the appointed time the TV will switch over to the required channel and at the end of the event, switch the TV to previous channel.

When the Timer screen is displayed, any event can be set to be Inactive (so it will not occur) or the channel, times and frequency mode altered by highlighting the event's Mode button and pressing "SELECT" key as before.

You can exit the Timer screen and return to normal TV viewing by pressing "MENU" key.

Hint

If you are watching digital terrestrial TV at the time the timer event starts, a message is flashed onto the screen announcing that the TV is 'Switching to timer channel' so you understand what is happening.

Event Timer

If timer action occurs when the TV is in stand-by mode, the TV turns on but no picture is seen and no sound is heard.

Selected digital channel will be at the Scart-2 output. The selected channel can be watched or copied via Scart-2. If timer action occurs while tv is watched, tv switches to the selected channel. When timer expires, the TV switches to the channel which it is switched from.

While watching Analog TV broadcasting, you can get Digital TV broadcasting from EXT-2. For this option you must set **Av-2 Output** in Feature menu to DIGITAL mode. (See Analog TV section - Feature menu) Start and end time of Digital TV programmes can be set in Timers menu.

While watching Digital TV broadcasting, you can get Analog TV broadcasting at that time from EXT-2. For this option you must set **Av-2 Output** in Feature menu to TV. (See Analog TV section - Feature menu)

Re-Installation

Although your TV will not lose its settings or stored channels when switched off, you may wish to re-install the TV because you have moved to a different area with different broadcast frequencies, you wish to reinstate a channel previously deleted from the channel list, or you want to watch new channels which have started broadcasting.

Press the **"MENU"** key to display the Main Menu and using the **"▲"** or **"▼"** keys, highlight the Installation line and press **"SELECT"** key to display the Installation Menu.

You can either perform a First Time Installation, effectively resetting the TV to its ex-factory condition, or just search for channels.



advanced operation

FIRST TIME INSTALLATION

To reset the TV, highlight the First Time Installation line in the menu and press **"SELECT"** key. A warning screen is displayed in case of accidental operation.

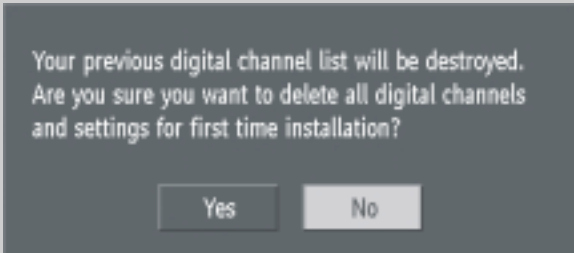

Your previous digital channel list will be destroyed.
Are you sure you want to delete all digital channels
and settings for first time installation?

Yes

No

Highlight the YES button with the "**◀**" or "**▶**" key and press **"SELECT"** key to erase all the channels and settings and switch the TV to standby. You can now start again as detailed in Preparation - Tuning In.

ADD CHANNELS

Your TV can search for channels automatically (searching all the broadcast frequencies for free-to-air channels) or manually (searching one specified broadcast frequency only for any channels to be found there).

Press the **"MENU"** key to display the Main Menu and using the "**▲**" or "**▼**" keys, highlight the Installation line and press **"SELECT"** key to display the Installation Menu. Highlight the Add New Channels line and press "**▶**" key to display the options. Select Automatic Search with the "**▲**" or "**▼**" keys and press **"SELECT"** key. This starts the automatic tuning process as described in "Tuning In", and searches through all the available broadcast frequencies for free-to-air channels.

If, alternatively, from the search options menu the Manual Search line is highlighted and **"SELECT"** key pressed, the manual search screen is displayed.

Installation

Add New Channels ▶

Automatic Search

First Time Installation

Manual Search

advanced operation

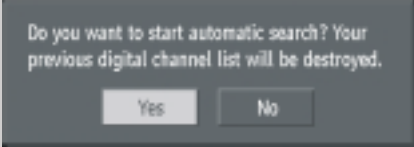

Do you want to start automatic search? Your previous digital channel list will be destroyed.

Yes

No

Highlight the YES button with the “◀” or “▶” key and press “SELECT” key to start the automatic search.

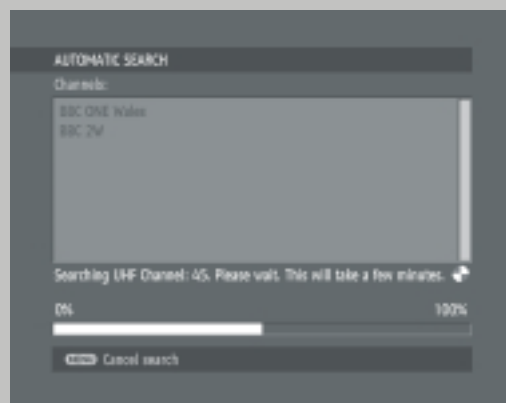

This is for searching for digital channels on a single broadcast frequency. The frequency channel number (21-68) is entered in the box at the top left of the screen and the received signal level and signal quality can be observed on the two bar graphs at the bottom. When “SELECT” key is pressed, the TV searches that frequency and display a list of the channels found. Before returning to the Installation menu.

Hint

The bar graphs of signal quality and signal level give a good indication of whether any channels are likely to be found. If only the signal level graph shows a high value then it is likely that an analogue channel occupies that broadcast frequency. If the signal quality bar is high as well then it is a digital frequency and digital channels will probably be found.

Again, channels which duplicate those already in the channel list are ignored. However, the manual channel search will find all channels on the broadcast frequency.

When either search is finished, press the “MENU” key to return to normal broadcast viewing, to watch the new digital terrestrial television channels found.

HINT

Depending on the reception conditions in your particular area, you may find that the list of channels found includes one or more repeated names. This is because the IDTV may detect and store some channels, including those it cannot receive clearly, from adjacent areas alongside the strong channels from a transmitter nearby. This is not a problem and the weaker channels can be deleted from the IDTV later.

If no digital terrestrial television broadcasts are found the IDTV will display a message:



No channels found, please
check antenna connection

Select

Press "**SELECT**" key to install channels. If no channel is found, you should then refer to the Troubleshooting Guide to establish the cause of the problem.

When you have finished watching digital terrestrial TV, you may wish to switch the IDTV to standby to save power - even when the television is turned off, without harm to the television or itself. The IDTV is returned to standby by pressing the "⏻" key on the remote control handset.

Hint

In standby, the TV still consumes power and thereby contributes to air and water pollution and the exhaustion of the World's natural resources. Overnight, or when your IDTV is not going to be used for long periods of time, you can turn it off at the mains and this will save energy (and save you money). You will not have to re-install the IDTV when it is turned on again.

advanced operation

Common Interface Menu

Common Interface Menu is entered from the Main Menu when the Common Interface button is selected by the user. Just after the selection, a new menu appears on the TV including the names of the common interface modules inserted to the slots. If there is no module inserted into the slots, common interface button on the main menu is disabled by the system. The MediaGuard names are selected for demonstration so you may see different names on this Common Interface menu. Our IDTV has two slots for insertion of modules, however you can see up to two names of modules in this menu option.

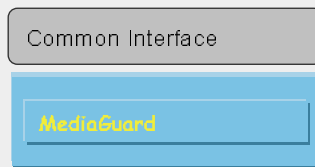

Figure 1. Common Interface Menu with modules inserted into the slots.

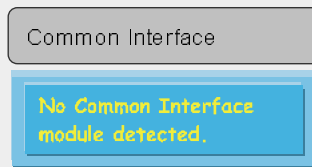

Figure 2. Common Interface without any module inserted.

The user can choose one of the buttons to enter that module's menu. The buttons and the information seen on the screen come from the common interface module and the user can navigate among the buttons by using the “▲”/“▼” keys of the remote control device.

advanced operation

Profile1 Modules display three types of items on the TV monitor.

1) Module Menu (Figure 4)

2) Inquiry Box (Figure 6)

One of them is the Module Menu as you can see an example of this type in Figure 4 Also the common interface module can display a list of items (channel list, subscription information, module information etc.) and an inquiry message for pin control, changing module ratings etc. You can see List box and Inquiry box taken from the Viaccess module. This section can only demonstrate a few of the modules' information and for each of the module you want to use, you will see different names, buttons , lists , menus , etc.

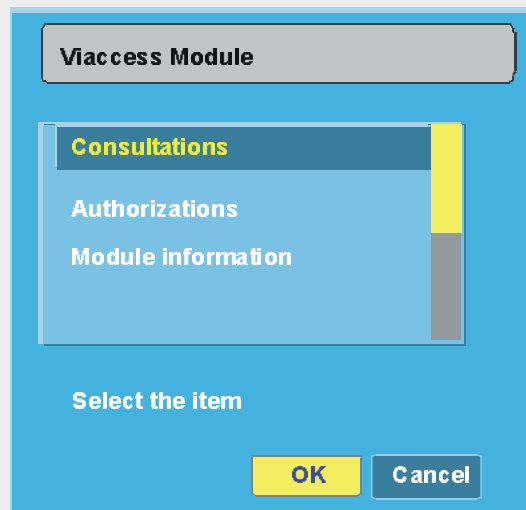

Figure 4. Module Menu (this menu is identical for the Viaccess Common Interface Module)

advanced operation

Common Interface

Please, enter your PIN code

???

Figure 6. Module Inquiry (this list is identical for the Viaccess Common Interface Module)

LANGUAGE

Digital terrestrial television channels can broadcast simultaneous soundtracks in more than one language. This function selects which language soundtrack you will hear when switching to a channel broadcasting with multiple soundtracks.

The Language menu screen is accessed from the Main Menu. Press the **"MENU"** key to display the Main Menu and the **"▼"** key to highlight Language, then press **"SELECT"** key to display the Language menu screen.

Then, using the **"▲"** or **"▼"** keys on the remote control, make sure that the selected language is highlighted in yellow and press the **"SELECT"** key to change the language.

Return to the Main Menu by pressing the **"MENU"** key.

TV SETUP:

To be able to go through TV menu functions, you can use this item.

The digital TV setup menu screen is accessed from the main menu. Press the **"MENU"** key to display the main menu and use the **"▼"** key to highlight TV Set-up, press **"SELECT"** key to display TV Setup menu screen.

Operating the TV

Operating the TV

You can operate your TV both using the remote control handset and onset buttons.

Operating with the buttons on the TV set

Volume setting and programme selection can be made by using the buttons at the control panel on the **right side** of the TV.

Volume Setting

- Press "**-**" button to decrease volume or "**+**" button to increase volume, so a volume level scale (slider) will be displayed at the middle of the bottom on the screen.

Programme Selecting

- Press "**CH**" button to select the next programme or "**CH**" button to select the previous programme.

Entering Main Menu

- Press "**MENU**" button to enter Main menu. In the Main menu select submenu using "**CH**" or "**CH**" button and enter the sub-menu using "**-**" or "**+**" button. To learn the usage of the menus, refer to the Menu System section.

	For Analog TV	For Digital menu	No menu
	Cursor down	Cursor down	Program down
	Cursor up	Cursor up	Program up
	Select	Select	Volume down
	Select	Cursor right	Volume up
MENU	Menu off Previous menu	Menu off Previous menu	Menu open

Operating with Remote Control

The remote control handset of your TV is designed to control all the functions of the model you selected. The functions will be described in accordance with the menu system of your TV.

Functions of the menu system are described in Menu System section.

Volume Setting

Press "**-**" key to increase volume. Press "**+**" key to decrease volume. A volume level scale (slider) will be displayed at the middle of the bottom on the screen.

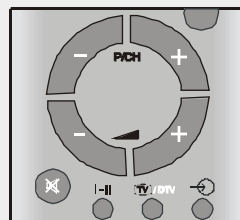

Programme Selecting

(Previous or next programme)

- Press "**-P/CH**" key to select the previous programme.
- Press "**P/CH+**" key to select the next programme.

Programme Selecting (direct access):

Press digit keys on the remote control handset to select programmes between 0 and 9. TV will switch to the selected programme. To select programmes between 10 - 99, you must use the double digit key "- / -".

P - - this OSD is displayed at the left hand upper on the screen.

After then, press the digit keys consecutively which programme you want to select (eg. for programme 27, first press 2 and then 7). When it is late to press any digit key this function will be ignored and the display will be erased. In the same way it must not be late to press any digit key after entering the first digit. The limit of the delay time is 3 seconds.

Press directly the programme number to reselect single digit programmes.

Programme Swapping

- Press "P<P" (programme swap) key to select the last selected programme. This key provides swapping between last two selected programmes.

For example, select programme 8, then select programme 2. Now, if you press "P<P" key, programme 8 will be selected. If you press the same key again, programme 2 will be selected and so on. Press the same key again, programme 2 will be selected and so on.



Menu System

Your TV has been designed with a menu system to provide an easy manipulation of a multi-function system. The TV is controlled by choosing the commands, which are displayed on the screen.

Press the "M" key. The main menu will be displayed at the middle of the screen.

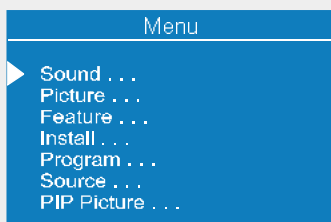

To select a sub-menu use "△" or "▽" key, and press "◀" or "▶" key or directly press "OK" key.

Main menu

The menu system is described below.

The short way in order to enter the menus, press :

"M" Key,	Main Menu.
Red Key,	Sound Menu.
Green Key,	Picture Menu.
Yellow Key,	Feature Menu.
Blue Key,	Install Menu.

"i INFO" Key, Programme Menu in TV mode or, Source Menu in AV mode

"M" key has two functions; first is opening or closing the main menu, and the second is closing the sub-menu and then opening its parent menu.

Sound Menu

To change sound settings

- Enter the Sound Menu directly by pressing the Red key or,
- As you enter the main menu, sound will be the first item. In the main menu, select **Sound** using "△" or "▽" key, then enter the sound menu pressing "◀" , "▶" or "OK" key.

Setting Volume

As you enter the sound menu, Volume will be the first selected option.

- Press "▶" key to increase volume.
- Press "◀" key to decrease volume.

Or you can directly change the volume settings using "▲ +" (to increase) or "- ▼" (to decrease) key.

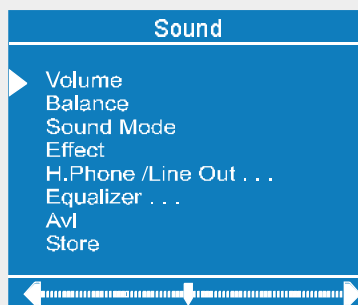

Setting Balance

It allows adjusting the distribution between the left and right speakers.

- Using "△" or "▽" key select Balance.
- Press "▶" key to change balance rightward.

- Press “◀” key to change balance leftward.

When balance control is in mid position, the cursor is displayed with one arrow.

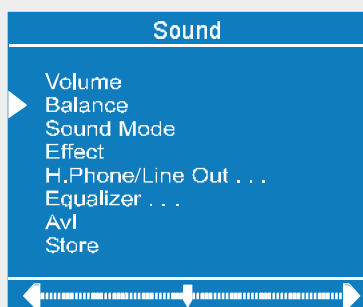

Selecting Mode

- Using “△” or “▽” key select Mode.
- Press “◀” or “▶” key to change Mode.

You can choose **Mono**, **Stereo** or **Dual (I-II)** mode, only if the selected channel supports that mode.

You can also change sound mode directly pressing “I-II” key on your remote control.

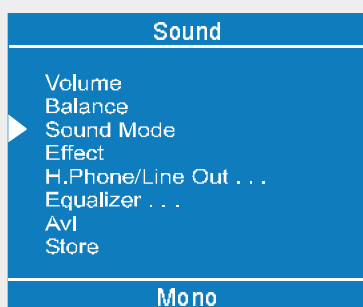

In case of bilingual broadcast (Dual Sound), you can select original or dubbed language using mode option.

Setting Effect

You can use this feature to switch the sound effect on and off. Pressing “◀” or “▶” key will turn on and off this feature. If the current sound system is **Mono** and the sound effect is set **ON**, then the sound will be heard as if it is **Stereo**. If

the current sound system is **Stereo**, switching this effect on will make the sound deeper. Switching it off will make no change in **Mono** and **Stereo**.

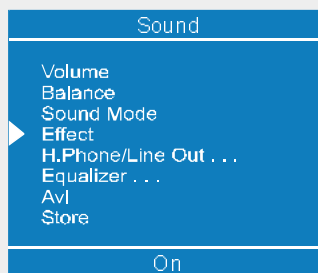

To Change H.Phone/Line Out Settings

- Using “△” or “▽” button select H.Phone/Line Out.
- Press “◀” or “▶” button or directly press “OK” button on H.Phone/Line Out, to enter the H.Phone/Line Out menu. This is a sub-menu of Sound menu, and all options in this menu are working as the same in the Sound menu.

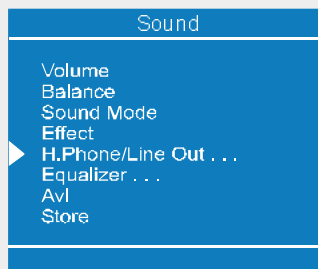

Setting H.Phone/Line Out Volume

- As you enter the H.Phone/Line Out sound menu, Volume will be the first selected option.
- Press “▶” button to increase volume.
- Press “◀” button to decrease volume.

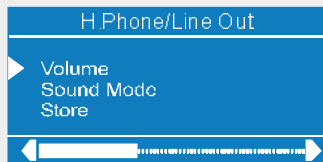

Setting H.Phone/Line Out Sound Mode

- Using "△" or "▽" button select Sound Mode.

Pressing "◀" or "▶" button will change the current sound mode. (e.g.: If the current sound mode is stereo, it will be stereo or visa versa).

In case of bilingual broadcast, you can select original or dubbed language again using mode menu. So when somebody listens to the original language from the loudspeakers, somebody else can listen to the dubbed language from headphones.

To Store the Settings

- Press "OK" button on the remote control to store the settings directly.
- or,
- Using "△" or "▽" button select Store. Press "◀", "▶" or "OK" button to store current H.Phone/Line Out volume and sound mode. The stored values will be valid for all the programmes.

Equalizer

- Using "△" or "▽" key select Equalizer.
- Press "◀" or "▶" key or directly press "OK" key to enter Equalizer sub-menu.

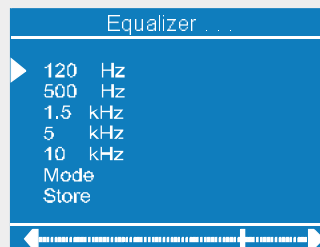
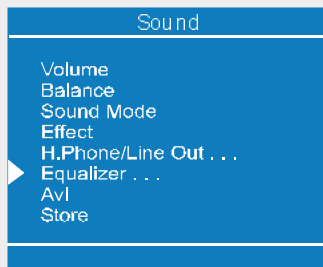

In Mode item there are five predefined and one user defined options. These are User, Classic, Jazz, Rock, Pop and Flat. The predefined options can not be changed by the user. If you want to change one of the frequency values of the predefined options, the Mode must be switched to User option.

The 5 items below the Mode are available to adjust the sound settings in 5 frequency values: 120 Hz, 500 Hz, 1.5 kHz, 5 kHz and 10 kHz. To change the values of 5 frequency options, select one of the options by "△" or "▽" key, and then press "▶" key to increase the value, or "◀" key to decrease the value. In mid position, cursor is displayed with one arrow.

To store the Equalizer settings, press "◀" or "▶" key or directly press "OK" key on "Store" option.

During the store process all the items are stored, moreover, the User mode information would not be lost. In other words, when the user mode is selected again, after storing the Mode with one of the predefined options, the user defined frequency values would be set.

Setting AVL

- Using "△" or "▽" key select AVL.
- Pressing "◀" or "▶" key will turn on and off this feature.

Automatic Volume Limiting (Avl) function normalises sound to obtain fixed output level between programmes, having different sound levels.

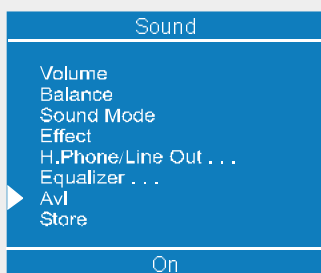

To Store the Settings

- When the cursor is on any item which has no sub-menu press “OK” key on the remote control to store the settings directly.

or,

- Press “◀”, “▶” or “OK” key on “Store” option to store Sound menu settings.

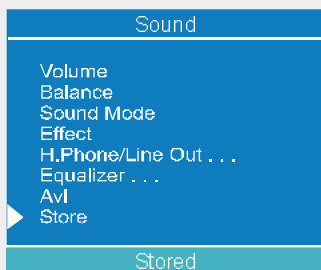

Picture Menu

- To enter the Picture menu directly, press the Green key, or
- Press “M” key, now you are in main menu. In the Main menu, select “Picture” using “△” or “▽” key, then enter the Picture menu pressing “◀” / “▶” or “OK” key.

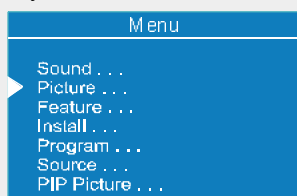

Setting Brightness

- As you enter the picture menu, Brightness will be the first item.
- Press “▶” key to increase brightness.

- Press “◀” key to decrease brightness.

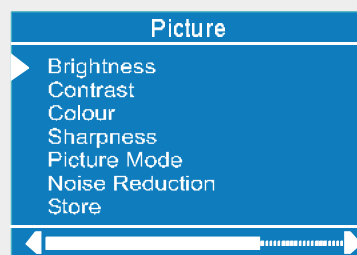

Setting Contrast

- Using “△” or “▽” key select Contrast.
- Press “▶” key to increase contrast level.
- Press “◀” key to decrease contrast level.

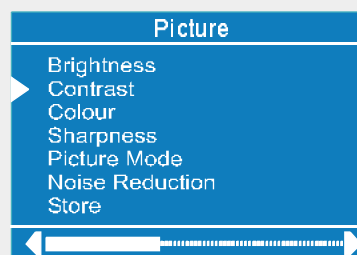

Setting Colour

- Using “△” or “▽” key select Colour.
- Press “▶” key to increase colour level.
- Press “◀” key to decrease colour level.

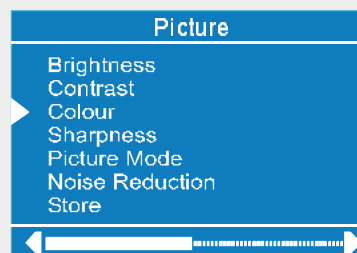

Setting Sharpness

- Using “△” or “▽” key select Sharpness.
- Press “▶” key to increase peaking level.

- Press “◀” key to decrease peaking level.

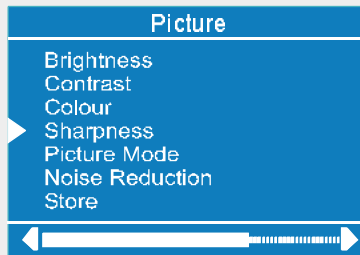

Setting Picture Mode:

- Using “△” or “▽” key select Picture Mode.
- Press “◀” or “▶” key to set Picture Mode. Picture Mode can be set to **Auto**, **4:3**, **16:9**, **Cinema**, **Subtitle**, **Zoom** or **Panorama**.

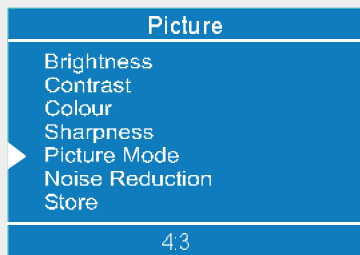

Setting Noise Reduction

- Using “△” or “▽” key select Noise Reduction.
- Press “◀” or “▶” key to select Noise Reduction level **Off** or **Minimum** or **Medium** or **Maximum**.

Note 1:

At low signal level, the changings on the Noise Reduction function are not effective when there is menu on the screen. If the menu is removed, the effect of this function is seen. At normal broadcasting, Noise Reduction changings are effective at once.

Note 2:

At moving pictures, while Noise Reduction is at maximum level, some picture distortions may occur. If Noise Reduction is set to medium or minimum, the picture will improve.

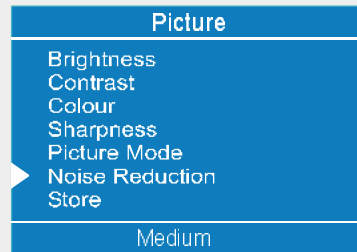

Setting Hue

(During Playback NTSC system, this will appear in AV mode only when NTSC video source is applied. Otherwise, HUE option is invisible in Picture menu.):

- Using “△” or “▽” key select Hue.
- Press “▶” key to increase hue level.
- Press “◀” key to decrease hue level. Center value is indicated with one arrow.

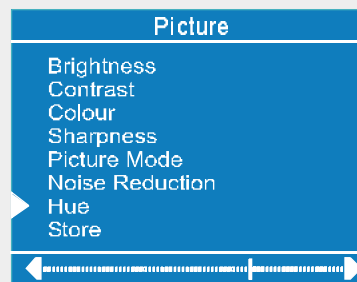

To Store the Settings

- When the cursor is on any item which has no sub-menu press “OK” key on the remote control to store the settings directly.
- or,
- Press “◀”, “▶” or “OK” key on **Store** option to store Picture menu settings.

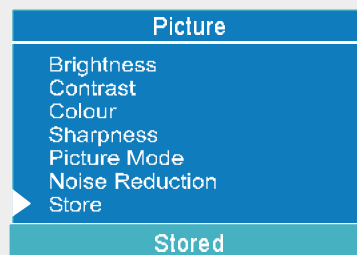

Feature Menu

- To enter the Feature menu directly, press the Yellow key, or
- Press "M" key, now you are in main menu. In the main menu, select **Feature** using "▲" or "▼" key. Then enter the Feature menu pressing "◀" / "▶" or "OK" key.

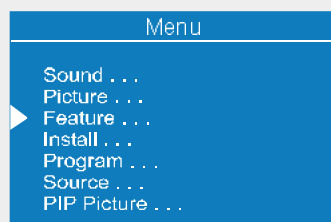

Sleep Timer

As you enter the Feature menu, **Sleep Timer** will be the first selected option. Use "◀" or "▶" key to change the Sleep Timer values between **Off, 0:15, 0:30, 0:45, 1:00, 1:15, 1:30, 1:45** and **2:00**.

If sleep timer is activated it is displayed with the TV status on the upper right of the screen.

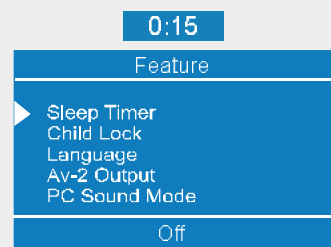

After the setting time of sleep timer ended, TV goes automatically to stand-by.

Child Lock

You can use this feature to prevent children turning on/off TV or changing programmes or adjustments etc. without remote control.

The **Child Lock** feature can be set **On** or **Off** by "◀" or "▶" key. When **Off** is selected, there will be no difference in the oper-

ation of your TV. When **On** is selected, the TV can only be controlled by the remote control handset. In this case the control panel buttons except "⏻" button on the right side of the TV will not work.

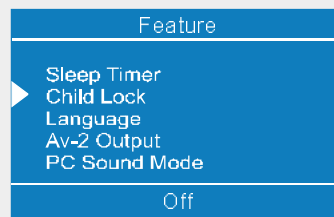

While **Child Lock** is **On**, pressing any of the control panel buttons (except power on/off button) causes the following warning menu to appear on the screen.



Selecting Menu Language

Menu language can be chosen by pressing "◀" or "▶" key on **Language** item.

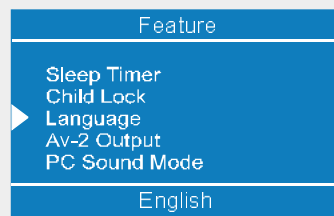

Av-2 Output

From **Av-2 Output**; **DIGITAL, TV, AV-1** or **AV-3** can be given. **DIGITAL, TV, AV-1** or **AV-3** can be chosen by pressing "◀" or "▶" key on "**Av-2 Output**".

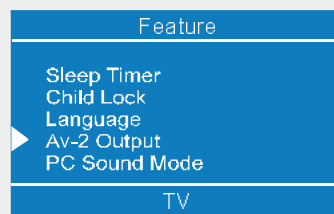

PC Sound Mode

PC sound can be chosen by pressing “◀” or “▶” key on **PC Sound Mode** item.

You can select sound that comes from TV, AV-1, AV-2 or **AV-3** to hear in PC mode.

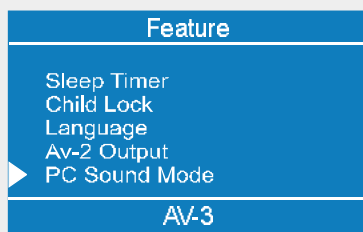

To Store Settings

In Feature menu all settings are stored automatically.

Installation Menu

- To enter the Installation menu directly, press the Blue key, or
- Press "M" key, now you are in main menu. In the main menu, select "Install" using "▲" or "▼" key. Then enter the Install menu pressing "◀" / "▶" or "OK" key.

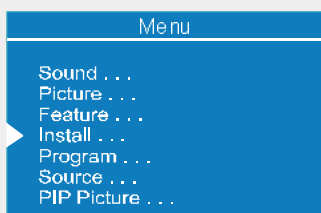

When any item is selected with "▲" or "▼" key in the install menu, the selected item will be highlighted on the bottom bar. Changes by pressing "◀" or "▶" key will be result only at highlighted item on the bottom bar.

Selecting Programme

To select programme number, you can use "◀" or "▶" key, Digit Keys or The Double Digit key with digit keys.

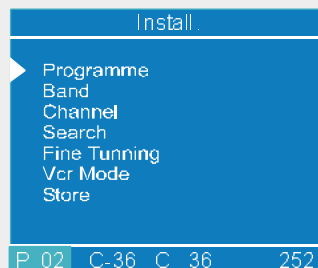

Selecting Band

Band, can be chosen either,

- "C" or "S" by "◀" or "▶" key.

Selecting Channel

Channel can be changed by "◀" or "▶" key, by Digit Keys or by the Double Digit key with digit keys.

For band C,

01 - 17, 21 - 73,

For band S,

01 - 41, for all channel tables.

Selecting Search

To start the search process, press "▶" key for forward search or "◀" key for backward search. If a signal is found or reaches to end of the band after searching, press "◀" or "▶" keys to continue search process. To stop the search process when you want, press "◀" or "▶" keys again.

Selecting Fine Tuning

You can use the Fine Tuning process for fine adjustment (after coarse adjustment), if you are not happy about the image on the screen.

Use "◀" or "▶" key on **Fine Tuning** item, until getting the best image on the screen.

Normally the Fine Tuning cursor is placed next to the left side on the slider and this is indicated with one arrow.

Setting VCR (Video Cassette Recorder) Mode

- This item can be seen in TV, AV-1, AV-2, AV-3, S-VIDEO modes.
- If you want to watch a VCR source from one of these modes, then it will be better to set VCR mode "on". For this, while the cursor is on this item press the "◀" or "▶" keys to set it "On".
- If you want to watch a DVD, then you must set this item "off"; because DVD is not a source like a VCR and to see the picture better, you must set the VCR mode "Off".

To Store Settings

- Press "OK" key on the remote control to store the settings directly.
- or,
- Press "◀", "▶" or "OK" key on Store option to store Install menu settings.

Programme Menu

- To enter Programme menu directly, press the "i INFO" key in TV mode, or
- Press "M" key, now you are in main menu. In the main menu, select "Program" using "△" or "▽" key. Then enter the Programme menu, press "◀" / "▶" or "OK" key.

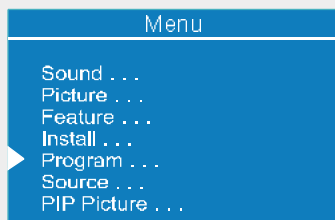

Moving cursor to four direction you can reach 20 programmes in the same page. By scrolling the pages up or down by pressing the navigation keys you can select all the programmes in TV mode (except the AV mode).

By cursor action, programme selection is done automatically. In order to select programme is also possible by using digit or double-digit key. In this way programme selection gets also automatically. The TV Status is changed by the programme selection too. When using double-digit key in order to select a programme, the Programme Number in TV Status OSD is displayed in "P --" form, and by pressing digit keys they are displayed in it.

Programme Number is between 00 and 99. Programme Name has a name string with 4 characters. After autostore process the Programme Names are set to:

- Channel search "C-01" or "S-01" (band and channel number) or name of the tuned channel if defined.

Program.		P 02	
01	C-01	11	----
▶ 02	C-02	12	----
03	C-03	13	----
04	C-04	14	----
05	S-01	15	----
06	S-02	16	----
07	----	17	----
08	----	18	----
09	----	19	----
10	----	20	----
Name		Insert	
Delete		Autostore	

At the bottom of the menu there is a programme sort functions section. Each function is activated by color key (seen above). **Name** allows changing the programme name. By **Delete** you can delete programmes that you decided. **Insert** section is for inserting programmes into another programme spaces. By selecting **Autostore** section, Autostore menu will be available.

Name:

To change the name of a decided programme, that programme is selected and pressed to the Red key (**Name**). The first letter begins to blink on the selected name. To change that letter "△" or "▽"

key can be used, and to select the other letters, “◀” or “▶” key can be used. If the cursor is at the last letter of the Programme Name, pressing “▶” key moves the cursor at the beginning. On the contrary, if the cursor is at the beginning of the Programme Name, pressing “◀” key moves the cursor at the end.

After changing the name by pressing the **Red** key (**Store**) it is stored. After activating the name process the “**Insert**”, “**Delete**” and “**Autostore**” processes will be inactive and “**Cancel**” option will be valid. This option cancels the name process, if the new name do not want to be stored. To cancel option is activated by pressing **Blue** key.



Insert:

When it is pressed to **Green** key (**Insert**), “**Name**”, “**Autostore**” and “**Delete**” functions are erased, the selected programme (A) is displayed with an arrow. From now on, the automatic selection is canceled. With navigation keys, the decided programme space (B) can be selected and by pressing the **Green** key again inserting is occurred to that space (B).

Press **Blue** key to activate “**Cancel**” function of “**Insert**” process.

Delete:

For “**Delete**” process it is pressed to **Yellow** key, (“**Name**”, “**Insert**” and “**Autostore**” functions are inactive). Pressing **Yellow** key again erases the selected programme from the programme list, and the programmes below shift one up. Pressing **Blue** key cancels the activated “**Delete**” process.

Autostore:

To enter Autostore menu, press to the **Blue** key. To learn the features of this function see “**Autostore**” below.

Autostore, searches and stores all channels automatically on your TV, according to the transmission of programme systems in your area.

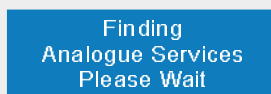
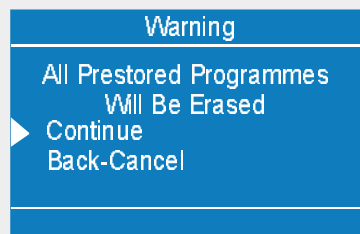

To cancel **Autostore** before starting, press “**BACK**” key. To start **Autostore** press “◀” or “▶” key.

After Autostore is finalized, a programme list will appear on the screen. In the programme list you will see the programme numbers and names assigned to the programmes.

If you do not accept the locations and/or the programme names of programmes, you can change them in Programme menu.

Source Menu

You can switch your TV to AV modes by pressing directly to “◂” key or by selecting in source menu from the main menu.

While in AV mode, you can also switch your TV to TV or other AV modes by selecting in source menu from the main menu.

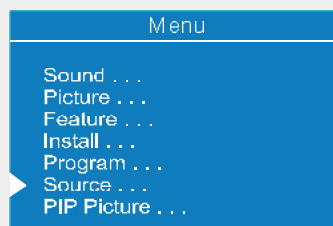

In main menu, firstly use “△” or “▽” key then use “◀” / “▶” or “**OK**” key to enter Source menu. In source menu, move the cursor by “△” or “▽” key and then press “**OK**” key or “◀” or “▶” keys when the cursor is on the required item. The selected mode comes automatically on the screen.

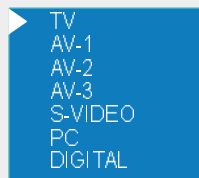

PIP Picture Menu

Setting Brightness

- As you enter the PIP Picture menu, Brightness will be the first item.
- Press “▶” key to increase brightness of PIP Picture.
- Press “◀” key to decrease brightness of PIP Picture.

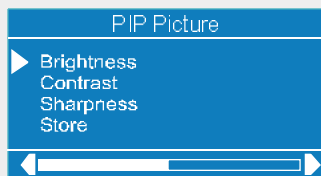

Setting Contrast

- Using “▲” or “▼” key select Contrast.
- Press “▶” key to increase contrast level of PIP Picture.
- Press “◀” key to decrease contrast level of PIP Picture.

Setting Sharpness

- Using “▲” or “▼” key select Sharpness.
- Press “▶” key to increase peaking level of PIP Picture.
- Press “◀” key to decrease peaking level of PIP Picture.

To Store the Settings

- When the cursor is on any item which has no sub-menu press “OK” key on the remote control to store the settings directly.
- or,
- Press “◀”, “▶” or “OK” key on **Store** option to store PIP Picture menu settings.

Other Features

TV Status

Programme Number, Programme Name (or AV), (they are displayed on the upper left of the screen) and **Sleep Timer** (shows the time left on the upper right screen if enabled). The **sound indicator** and **picture mode** are displayed with them too. They are displayed after programme change during 3 seconds.

P 01 Programme Number

PR 01 Programme Name (4 characters)

These OSD's are displayed when a new programme is entered by digit key or by pressing “P<P”, “-P/CH”, “P/CH+”, “TV / DTV”, “←” or “▶” key.

Programme Swap (P<P)

This key is used to reenter to the preceding entered programme again. Pressing “P<P” key consecutively allows to swap into two last entered programmes.



Double-digit (- / - -)

This OSD is displayed when the “Double-Digit” key pressed in place of the programme number indicator.

P - -

After then, in order to enter a programme it must be pressed to two digit consecutively. When it is late to press any digit key this function will be ignored and the display will be erased. In the same way it must not be late to press any digit key after entering the first digit. The limit of the delay time is 3 seconds.

Personal Preferences (PP)

All the preset values will be restored, when pressing "PP" key.

PP

Sound Indicator

The alternatives of the indicator are Mono, Stereo, Dual I and Dual II. This indicator is displayed under the programme number indicator on the screen. "I-II" key is used to select Mono or Stereo, or Dual I or Dual II.

Mono

In Mono broadcast or in forced-mono (for stereo broadcast).

Stereo

In Stereo broadcast.

Dual - I

If dual broadcast detected. Dual I is selected in default and also can be selected after Dual II by Remote Control.

Dual - II

If Dual II selected by Remote Control.

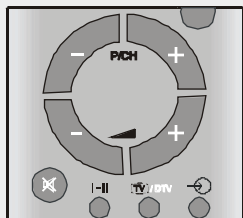

Picture Mode

Picture mode OSD is displayed when "WIDE" key is pressed. Picture mode can be changed to Auto, 4:3, 16:9, Cinema, Subtitle, Zoom or Panorama by pressing "WIDE" key.

Sleep Timer Indicator

It is displayed on the upper right of the screen when a new programme is entered by digit key or by pressing "P<P", "P/CH", "P/CH+", "TV / DTV", "⏻" or "⏻" key. If sleep timer is activated it is displayed with the TV status and erased with it after 3 seconds.

After the setting time of sleep timer has passed then TV goes automatically to stand-by.

0:15

Mute Indicator

It is placed in the upper middle of the screen when enabled, and it stays there until it is disabled.



To cancel mute, there is two alternative; the first one is pressing to "X" key, this volume is set to the preceding value, and the second one is increasing the volume level, thus it starts at the minimum level to increase. By decreasing the volume level in mute state, mute will not be ignored, only the volume level will decrease. If mute canceled after decreasing the volume level, the volume will valid with the decreased level.

No-Signal Detection (TV)

If no valid signal detected, it takes 5 minutes for the switching to the Stand-By mode unless any signal detected or no any Remote

Control command is accessed.

After a Remote Control command (if No-Signal Timer is active) the timer stops and if no signal detected again the timer is initialized to 5 minutes and starts 3 seconds later again to count down.

It is not valid in AV mode.

4:31

No-Signal Detection (PC)

If no valid signal detected for 5 minutes system goes to Stand-By mode. To switch on the system press "⏻" key.

No input signal detected

As the last status feature, system starts from TV or PC, whichever was the status before stand-by or switch-off. Note that SCART inputs have the precedence on both TV and PC.

Volume Bar

It is displayed in the lower middle of the screen. When a volume command is received (pressing “▲ +” or “▲ -” by Remote Control or Control panel at the right side of the TV) and no menu is active, it stays on the screen for 3 seconds, after the last volume command or until another command is received in between.



AV Modes

By pressing the “TV” key you can switch your TV to AV modes (except being in Teletext). Pressing this key will consecutively switch the TV in one of the optional AV modes: AV-1, AV-2, AV-3, S-VIDEO, PC.

In order to quit the AV mode press the “TV / DTV”, digit keys or “-PICH” or “PICH+”.

Signal Out Of Range

When the PC input signal is not supported by LCD-TFT TV, a message is displayed like “Signal out of range” and screen is blanked.

Signal out of range

PC Mode

Installation

- Power off both Computer and Display before making any connections.
- The monitor comes with a 15-pin PC cable. Connect end of the signal cable to the 15-pin connector on the rear of the Computer.

15 Pin Mini D-Sub Connector

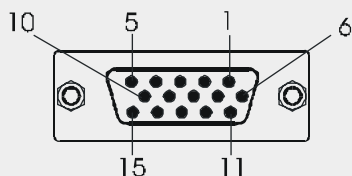

- Tighten the screws of the Display cable until the connectors are fastened securely (finger-tighten only).
- If you are using Windows operating system running on a PC with a Microsoft Plug & Play compatible video card, your system will select the appropriate timing for your monitor.

Switching from TV to PC

Press “PC” key to **switch** directly PC mode.



Main Menu in PC mode

Enter the main menu by pressing the “M” key on the remote control.

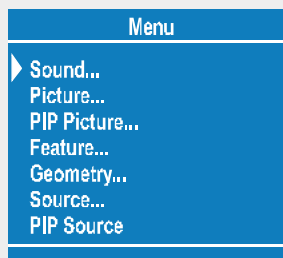

Sound Menu

In the main menu select “Sound” using “△” or “▽” key then enter the Sound menu pressing “◀”, “▶” or “OK” keys.

The items in this menu are described at Sound menu starting page 41.

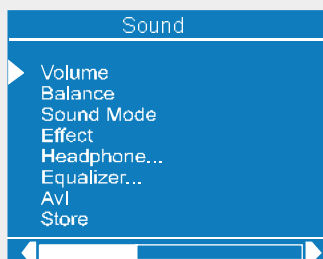

Picture Menu

In the Main menu, select "Picture" using "△" or "▽" key, then enter the Picture menu pressing "◀", "▶" or "OK" keys.

All adjustment in this menu except Picture Mode is identical to adjustment defined TV picture menu (on page 44). Picture Mode can be set to **Auto**, **4:3** and **16:9** in PC mode.

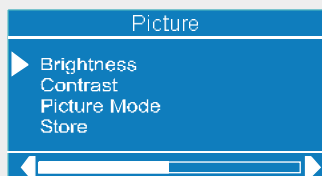

PIP Picture

In the Main menu, select "PIP Picture" using "△" or "▽" key, then enter the PIP Picture

menu pressing "◀", "▶" or "OK" keys.

The items in this menu are described at PIP Picture menu starting page 51 and Colour and Hue adjustments are the same with the picture menu in TV mode (page 46).

This menu is displayed when PIP is displayed on the screen and otherwise "PIP No Signal" message will be displayed at the bottom of menu.

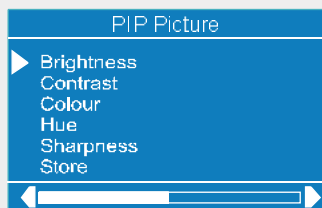

PIP picture is displayed on the screen with "□" key. By pressing "OK" key, PIP window is selected and border of the PIP window becomes green. PIP position is changed by "◀" / "▶" key. There are six different PIP positions. PIP size is decreased by "▽" key and increased by "△" key. Three different PIP size are available.

Programme in the PIP window is increased / decreased by "P/CH+" / "-P/CH" keys. AV mode is also available in PIP window. Digit keys are inactive for PIP window. PIP window is removed from the screen by "□" key.

PIP is available in Digital, terrestrial and PC mode.

Feature Menu

In the main menu select "Feature" using "△" or "▽" key then enter the Feature menu pressing "◀", "▶" or "OK" keys.

The items in this menu are described at Feature menu starting page 46.

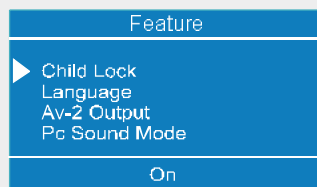

PC Sound Mode

This item selects the sound source for PC mode. But when the PIP is displayed and highlighted in green border, sound switches to whatever is displayed in the PIP. Whenever you close the PIP or make the PIP border blue again by deselecting the PIP, sound switches back to PC Sound Mode.

Geometry Menu

In the Main menu, select "Geometry" using "△" or "▽" key, then enter the Geometry menu pressing "◀", "▶" or "OK" keys.

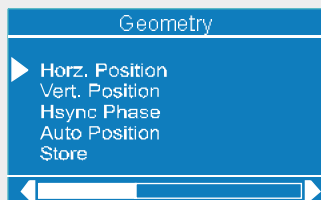

Adjust the required horizontal or vertical position or Hsync Phase by “◀”, “▶” keys.

You can make position adjustment directly by Auto position.

Select Auto position by “△” or “▽” keys and press “◀” or “▶” key.

“Please wait” is displayed at the bottom of the menu. After a few seconds screen geometry is adjusted automatically.

Warning: Auto position adjustment recommended to be done with the full screen image for the proper adjustment.

To store this menu setting select “Store” by “△” or “▽” keys and then press “OK” key, “Stored” will be displayed for few seconds at the bottom of menu.

Source Menu

In the Main menu, select “Source” using “△” or “▽” key, then enter the Source menu pressing “◀”, “▶” or “OK” keys.

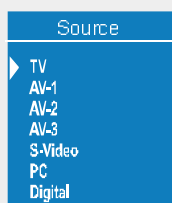

Select the available sources of TV, AV-1, AV-2, AV-3, S-Video, PC or Digital by pressing “◀”, “▶” or “OK” keys.

PIP Source Menu

This menu is available when the PIP displayed.

In the Main menu, select “PIP Source” using “△” or “▽” key, then select the any available source of TV, AV-1, AV-2, AV-3, S-Video or Digital by pressing “◀”, “▶” then “OK” keys.

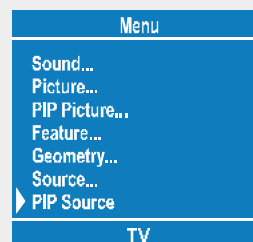

- When the TV is in TV mode, only Digital mode is watched in PIP window.
- When the TV is in Digital mode, TV and AV are watched in PIP window.
- When the TV is in PC mode, Digital, TV or AV can be watched in PIP window.

Teletext

Teletext

Teletext is an information system that displays text on your TV screen. Using the Teletext information system you can view a page of information on a subject that is available in the list of contents (index).

On screen display is not available in text mode.

Contrast, brightness or colour control is not available, but volume control is available in text mode.

To operate Teletext

- Select a TV station on which Teletext is being transmitted.
- Press “” button. Usually the list of contents (index) is displayed on the screen.



To select a page of Teletext

- Press the appropriate digit buttons for the required Teletext page number.

The selected page number is displayed at the top left corner of the screen. The Teletext page counter searches until the selected page number is located, so that the desired page is displayed on the screen.

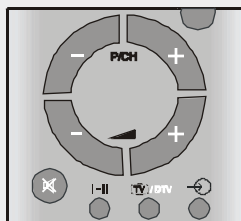



- Press “P/CH +” button to move the Teletext screen forward one page at a time.
- Press “- P/CH” button to move the Teletext screen backward one page at a time.



To Select Index Page

- To select the page number of the index (generally page 100), press “” button.



To Select Teletext with a TV Programme

- Press “” button. The text is now superimposed over the programme on the screen.
- Press “” button again to return to the Teletext page.

To Select Double Height Text



- Press “” button for the top half of the information page to be displayed in double height text.
- Press “” button again for the bottom half of the information page to be displayed in double height text.
- Press “” button once more for the full page of normal height text.

To Reveal “concealed” Information

- Pressing “” button once will reveal answers on a quiz or games page.
- Pressing “” button again will conceal the revealed answers.

To Stop Automatic Page Change



The teletext page you have selected may contain more information than what is on the screen; the rest of the information will be displayed after a period of time.

- Press “” button to stop the automatic page change.
- Press “” button again to allow the next page to be displayed.

To Select a Subcode Page

Subcode pages are subsections of long Teletext pages that can only be displayed on the screen one section at a time.

- Select the required Teletext page.

- Press “” button.
- Select the required subcode page number by pressing four digit buttons (e.g. 0001).
- If the selected subcode page is not displayed in a short time, press “” button. TV programme will be displayed on the screen.
- Teletext page number will be displayed on the upper left corner of the screen when the selected page is found.
- Press “” button to display the selected Teletext page.

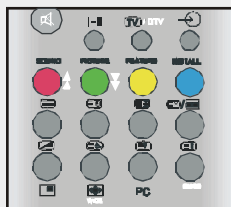

Fastext

(This is applicable if your TV is equipped with FASTEXT feature)

Your TV supports the 7 page Teletext system. When the page number of any of the 7 pages in memory is entered, the system will not search for the requested page; instead it will display the page automatically.

- Press “P/CH +” button to move the Teletext screen forward one page at a time.
- Press “- P/CH” button to move the Teletext screen backward one page at a time.

For Fastext

The subject-heading for the information may have a particular colour.

- Press an appropriate Red, Green, Yellow or Blue button in order to reach the relevant page quickly.

For TOP text

TOP text mode of operation will be activated automatically according to the transmission.

- If TOP text transmission is present, colour coded buttons will appear in status row.
- If TOP text transmission is not present, status row will not appear.



The subject-heading for information may be located in coloured box.

In TOP mode the “P/CH +” or “- P/CH” commands will request the next or previous page respectively. If TOP text transmission is not available, in case of operation of these commands, wraparound occurs. For example page 100 appears to be one greater than page 199.

To exit Teletext

- Press “TV” or “” button. The screen will switch to TV mode.

To Display the Time

- While watching a TV programme with Teletext transmission press “” button. The current time information, captured from Teletext will be displayed at the upper right of the screen until the “”, “” or “M” button pressed.
- If the programme being watched does not have Teletext transmission, no information will be displayed.

Connect Peripheral Equipment

There is a wide range of audio and video equipment that can be connected to your TV.

Connection diagrams at the end of this section show you where the different equipment should be connected at the back side of the TV.

PC Sound Connection

- Connect the PC Audio output to the TFT PC Audio In socket with stereo connection cable.
- In the main menu select "Feature" using "△" or "▽" button then enter the Feature menu pressing "◀", "▶" or "OK" button. Come on "PC Sound Mode" using "△" or "▽" button and select **AV-3** from the TV, AV-1, **AV-2 and AV-3** options using "◀", "▶" or "OK" button.
- **Source** also should be selected as PC in the main menu.

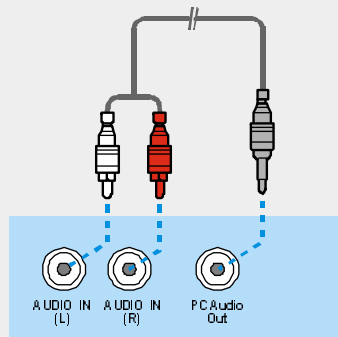

Via the Euroconnector

Your TV set has 2 Euroconnector sockets. If you want to connect peripherals (e.g. video, decoder, etc.) which have Euroconnectors, to your TV, use SCART input.

If an external device is connected via Euroconnector sockets TV is switched to AV mode automatically. In this case if both sockets are connected SCART-1 has the precedence.

In AV mode if you press the "E" button the TV status OSD is displayed on the screen.

Via Ant Input

If you want to connect to your TV, peripherals like video recorders or decoders, but the device you want to connect does not have Euroconnector, you should connect it to the ANT input of your TV set.

If the VCR is connected via antenna input it is suggested to use the Programme 0.

Decoder

Cable TV offers you a wide choice of programmes. Most of them are free, others are to be paid for by the viewer. This means that you will need to subscribe to the broadcasting organisation whose programmes you wish to receive. This organisation will supply you a corresponding decoder unit to allow the programmes to be unscrambled.

For further information ask your dealer. See also the booklet supplied with your decoder.

Connect a decoder with an aerial socket to the TV

- Connect the aerial cable.

Connect a decoder without an aerial socket to the TV

- Connect the decoder to your TV with a eurocable (RCA Jack Cable) to EXTERNAL (RCA Jack) (optional). When your decoder has a Euroconnector / RCA Jack you can obtain better picture quality if you connect a eurocable (RCA Jack Cable) to EXTERNAL (RCA Jack) (optional).

TV and Video Recorder

- Connect the aerial cables.

Better picture quality can be obtained if you also connect a eurocable to EXTERNAL socket (optional).

Playback NTSC

Connect NTSC VCR player to one of two Euroconnectors at the back of the TV.

Then, press "↻" button to select AV-1 or AV-2.

Search for and store the test signal of the video recorder

- Unplug the aerial cable from the aerial socket "ANT" of your video recorder.
 - Switch on your TV and put the video recorder on the test signal. (See the handbook for your video recorder.)
 - Search for the test signal of your video recorder in the same way as you searched for and stored the TV signals. See Install, Search and Store TV channels. Store the test signal under programme number 0.
- Replace the aerial cable in the aerial socket "ANT" of your video recorder once you have stored the test signal.

Camera and Camcorder

To connect to (AV-3) input

Connect your camera or camcorder at the back side of your TV.

- Connect your equipment to the TV via VIDEO (yellow), AUDIO R (red) and AUDIO L (white) inputs. You should connect the jacks to the input in the same colour.

Connect the decoder to the video recorder

Some video recorders have a special euroconnector for decoder.

- Connect a eurocable to the euroconnector of your decoder and to the special euroconnector of your video recorder. See also the handbook of your video recorder.
- To connect your video recorder to the TV, see TV and Video Recorder section.

If you want to connect more equipment to your TV, consult your dealer.

Connecting Headphones

Use the stereo headphone socket on the back side of your TV, to connect headphones.

Connecting the PC

Connect PC monitor with 15-pin PC cable to the 15-pin connector on the rear of the computer. For detail installation procedure see **Installation** in PC mode.

To connect to S-Video input

Connect your camera or camcorder at the back side of your TV.

- Connect your equipment to the TV via S-Video input at the back side by using S-Video cables.

Peripheral Equipment Connections

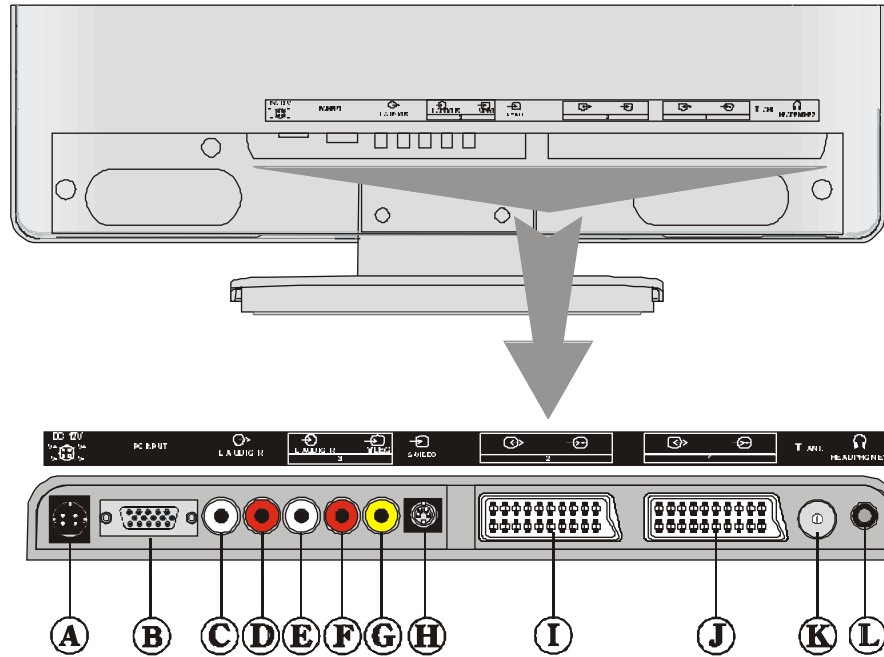

- | | | |
|---------------------|---|---------------------------|
| (A) DC 12 V |  | (H) S-VIDEO INPUT |
| (B) PC INPUT | | (I) SCART SOCKET 1 (AV-1) |
| (C) LINE OUT (L) | | (J) SCART SOCKET 2 (AV-2) |
| (D) LINE OUT (R) | | (K) ANTENNA |
| (E) AUDIO INPUT (L) | } (AV-3) | (L) HEADPHONE |
| (F) AUDIO INPUT (R) | | |
| (G) VIDEO INPUT | | |

Antenna Connections

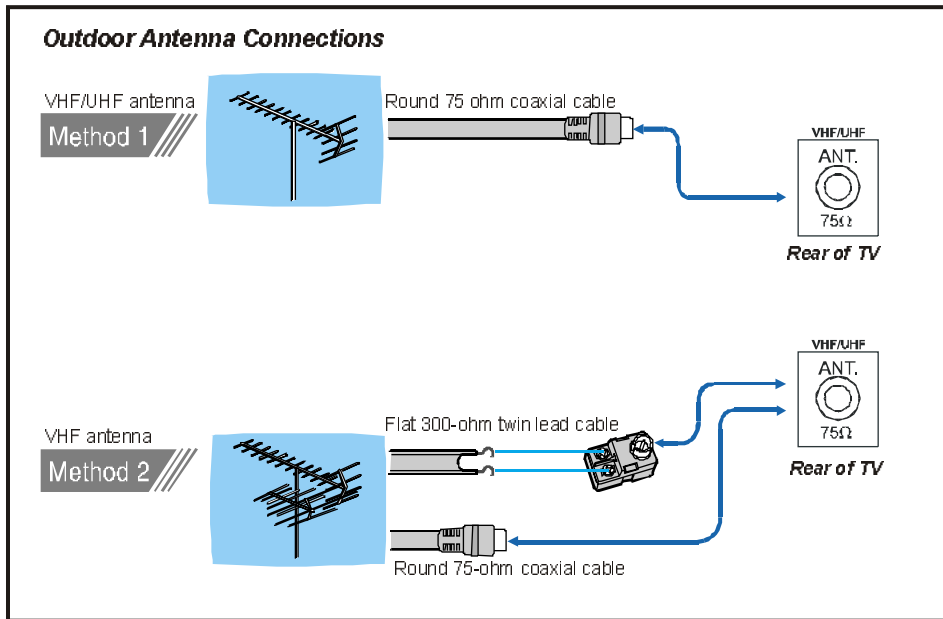

Peripheral Equipment Connections

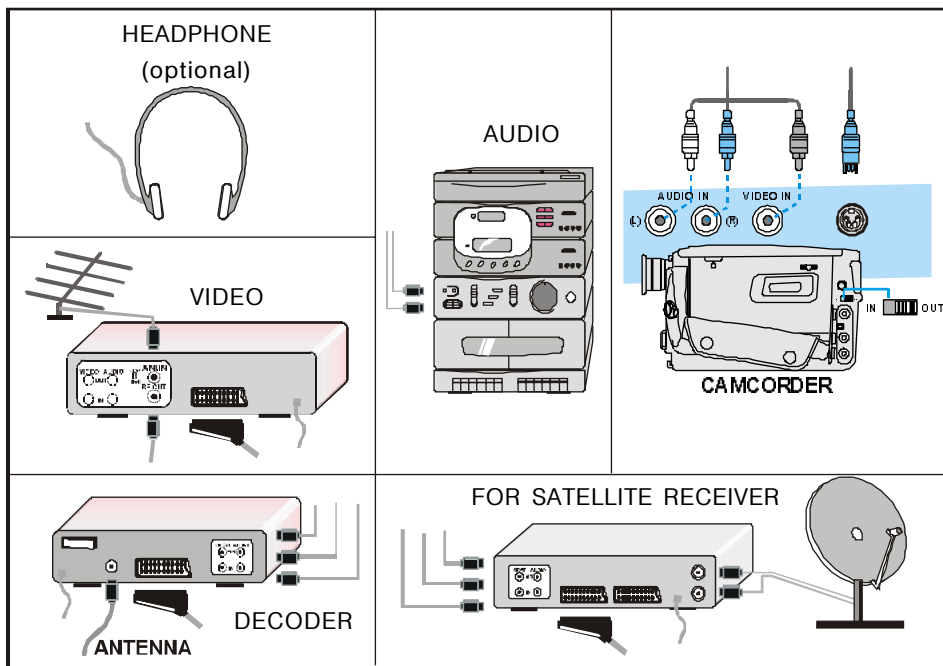

PC Input Typical Display Modes

The display has a maximum resolution of 1280 x 720, vertical sync. frequency range of 50-75 The display has a maximum resolution of 1280 x 768, vertical sync. frequency range of 50-75 Hz and a horizontal sync. frequency range of 30-69 KHz.

The following table is an illustration of some of the typical video display modes.

Mode	Resolution		Frequency		Sync. Polarity	
	Horizontal	Vertical	Hor. (kHz)	Ver. (Hz)	Hor.	Ver.
1	640	400	31.5	70	-	+
2	640	480	31.5	60	-	-
3	640	480	37.9	72	-	-
4	640	480	37.5	75	-	-
5	720	400	31.5	70	-	+
6	800	600	35.2	56	+	+
7	800	600	37.9	60	+	+
8	800	600	48.1	72	+	+
9	800	600	46.9	75	+	+
10	1024	768	48.4	60	-	-
11	1024	768	56.5	70	+	+
12	1024	768	60.0	75	+	+
13	1280	720	44.8	60	-	+
14	1280	768	47.8	60	-	+

The native resolution of the TFT-LCD Panel is 1280 x 768. Therefore using Mode 14 is advised to get the best PC input display quality.

Tips/Troubleshooting Guide

Tips/Troubleshooting Guide

On Digital mode

PROBLEM	POSSIBLE CAUSE	WHAT TO DO
No Signal mode	- Aerial is disconnected	- Check aerial lead
	- Aerial is damaged/misaligned	- Check aerial lead
	- Out of Signal area	- Check with dealer
No Picture or Sound	- Tuned to digital teletext channel	- Retune to another channel
Scrambled channel message	- Channel is scrambled	- Select alternative channel
Forgotten channel lock code		- Re-install channels to cancel channel lock
Forgotten menu lock code		- Contact help line

PROBLEM	POSSIBLE CAUSE	WHAT TO DO
Standby light not lit	- Mains lead unplugged	- Check mains lead
No response to remote control	- Receiver off	- Plug in and turn on receiver
	- Handset not aimed correctly	- Aim handset at front panel
	- Front panel obstructed	- Check that there is nothing in the way of the path between the remote control and the receiver
	- Handset batteries exhausted	- Replace handset batteries

On TV and monitor mode

Care of the Screen

Clean the screen with a slightly damp, soft cloth. Do not use abrasive solvents as they may damage the TV screen coating layer

Colors of image on screen are abnormal

For TV

Have you selected the correct TV system? Is your TV set or house aerial located too close to the loudspeakers, non-earthed audio equipment or neon lights, etc. ?

Mountains or high buildings can cause double pictures or ghost images. Sometimes you can improve the picture quality by changing the direction of the aerial.

Is the picture or Teletext unrecognisable? Check if you have entered the correct frequency.

The picture quality may degrade when two peripherals are connected to the TV at the same time. In such a case, disconnect one of the peripherals.

For Monitor

- Check that Video (Signal) Cable from the Display has been securely and correctly connected to the 15-pin Video Connector on the rear panel of the Computer.
- If you have used an adaptor to convert the 15-pin Video (Signal) Cable Connector from the Display to fit the connector on the rear of the Computer, check the pin assignment of the Display.

No Image on Display Screen

For TV

Is the aerial connected properly? Are the plugs connected tightly to the aerial socket? Is the aerial cable damaged? Are suitable plugs used to connect the aerial? If you are in doubt, consult your dealer.

No Image means that your TV is not receiving any transmission. Have you pressed the correct buttons on the remote control? Try once more.

For Monitor

- Check that power cord of the Display has been connected securely into wall outlet or grounded extension cable or strip.
- Display is equipped with electronic power switch, it will remain power-off in case of any power failure. It is necessary to push power switch again to power-on the display. Check that LED on front of display is green.
- Check that Video (Signal) Cable from the Display has been securely and correctly connected to the 15-pin Video Connector on the rear panel of the Computer.
- Check that Video Card is firmly seated in card slot of Computer motherboard.
- Check that the Brightness and/or the Contrast adjustments of the Display have not been turned down to minimum levels.

Sound

You can not hear any sound. Did you perhaps interrupt the sound, pressing "M" key? Are external speakers connected to the TV?

Sound is coming from only one of the speakers. Is the balance set to one direction extreme? See **Sound** menu.

Remote Control

Your TV no longer responds to the remote control. Press the "TV / DTV" key on the remote control once more. Perhaps the batteries are exhausted. If you can still use the buttons on the control panel at the top of your TV.

Have you selected the wrong menu? Press "TV / DTV" key to return to TV mode or press "M" key to return to the previous menu.

No solution

Switch your TV set off and on. If this does not work, call the service personnel; never attempt to repair it yourself.

Specifications

Specifications

TV BROADCASTING

PAL I/I'

RECEIVING CHANNELS

VHF (BAND I: CH2-4, BAND III: CH5-12)
UHF (CH21-69)
CABLE CHANNEL (S1-S41)

Input Signal

Video: Analog 0.7 Vp-p 75 ohm positive
Sync: TTL Level positive or negative, Separate sync.

Horizontal Timing 30 - 69 KHz
Vertical Timing 50 - 75 Hz

Dot Rate
78.75 MHz max.

Video Cable/Input Connector
15 pin mini D cable

PANEL

Size : 17.1" (43 cm) diagonal

Visible Picture Size

371.5 mm Horizontal x 223.5 mm Vertical

Displayable Resolution
1280 x 768 maximum
Non-interlaced

NUMBER OF PRESET CHANNELS

100

CHANNEL INDICATOR

On Screen Display

RF AERIAL INPUT

75 Ohm (unbalanced)

OPERATING VOLTAGE

For adaptor: 230 V AC, 50 Hz.
For TV : 12 V DC

AUDIO

German + Nicam Stereo

AUDIO OUTPUT POWER

2 x 3 W_{RMS}. (%10 THD)

POWER CONSUMPTION (W) (max.)

43

STAND-BY (⏻) POWER

<3W

DIMENSIONS (WxHxD)

W 445 mm.
H 327 mm.
D 176 mm. with stand
65 mm. without stand
Weight 5.7 Kg.



Free Manuals Download Website

<http://myh66.com>

<http://usermanuals.us>

<http://www.somanuals.com>

<http://www.4manuals.cc>

<http://www.manual-lib.com>

<http://www.404manual.com>

<http://www.luxmanual.com>

<http://aubethermostatmanual.com>

Golf course search by state

<http://golfingnear.com>

Email search by domain

<http://emailbydomain.com>

Auto manuals search

<http://auto.somanuals.com>

TV manuals search

<http://tv.somanuals.com>