

TOSHIBA

OWNER'S MANUAL

LCD Color TV



42WL55A
42WL55E
42WL55T

Owner's Record

You will find the model number and serial number on the back of the TV. Record these numbers in the spaces provided below. Refer to them whenever you call upon your TOSHIBA dealer regarding this product.

Model number:

Serial number:

Introduction

Getting started

Basic operation

Features

Viewing teletext

Equipment connections

Reference section

Welcome to Toshiba

- Thank you for purchasing this Toshiba LCD Color Television. This manual will help you use the exciting features of your new TV.
- Instructions in this manual are based on using the remote control.
- You can also use the controls on the TV if they have the same name as those on the remote control.
- Please read all the safety and operating instructions carefully, and keep the manual for future reference.

Contents

Introduction

Important Safety Instructions	3
Installation	3
Use	5
Service	6
Cleaning	7
Important information	8
Important information	8

Getting started

Installation	9
Connecting an antenna	9
Installing the remote control batteries	9
Exploring your new TV	10
TV top	10
TV front	10
TV back	11
Learning about the remote control	12
Location of controls	12
Turning the TV on	13
Switching on the TV	13
Switching off the TV	13
Learning about the menu system	14
Menu display chart	14
Selecting a language	15
Programming channel memory	16
System selection, Auto tuning	16
Manual tuning	16
Program sorting	18
Watching TV programs	19
Volume, Sound mute, Changing program positions, Program return, On-screen information	19

Basic operation

Viewing the wide-screen picture format	20
Picture size selection	20
Picture position, Reset	21
Picture position adjustment	21
Reset (Picture position adjustment)	21
Picture quality adjustment	22
Picture quality adjustment	22
To activate the black stretch	23
To activate the MPEG NR (Noise Reduction)	23
To activate the DNR (Digital Noise Reduction)	23
To select the color temperature	24
To use the cinema mode	24
Sound adjustment	25
MTS (Multi-channel TV Sound) setting	25
Selecting the Dual 1 or Dual 2 mode	25
Stereo/Bilingual selection	26
Sound quality adjustment	27
Bass boost	27
To use the WOW surround sound	28
To use the stable sound	28

Features

Input selection	29
Input selection	29
Timer, Gray screen	30
Timer	30
To activate Gray screen	30
Side panel adjustment	31
Side panel adjustment	31

Viewing teletext

Teletext - Setting up	32
Teletext mode	32
About Teletext	33
Teletext general information	33
Teletext SW adjustment	33
Teletext - FAST and LIST modes	34
Using FAST mode	34
Using LIST mode	34
Teletext - Control buttons	35
Teletext buttons on the remote control	35

Equipment connections

Side connections	36
Connection example	36
Back connections	37
Connection example	37
Connecting a computer	38
To connect a computer	38
PC setting	39
To adjust a PC setting	39

Reference section

Troubleshooting	41
Symptom and solution	41
Broadcast system, Specifications	42
Broadcast transmission systems of each country or region	42
LCD color television	42

Important Safety Instructions

- Be sure to observe the following instructions and precautions to ensure safe use of this TV.
- The exact power cord will vary according to the country or region.

Installation

Always connect the power plug to an electrical outlet equipped with
A model: 220-240V, AC 50Hz, E model: 220-240V, AC 50/60Hz and T model: 110-240V, AC 50/60Hz.

Do not use the TV outside the specified voltage range. It may cause a fire or an electric shock.

WARNING ABOUT THREE-WIRE GROUNDING-TYPE PLUG:

Do not remove the earthing pin on the power plug. This system is equipped with a three pin earthing-type power plug. This plug will only fit an earthing-type power outlet. This is a safety feature. If you are unable to insert the plug into the outlet, contact an electrician to replace the wall outlet.

Do not defeat the purpose of the earthing plug.

Check!

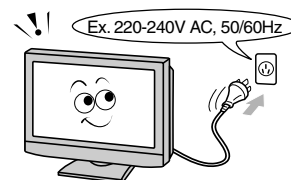

About the fuse

In a three pin earthing-type, the fuse fitted in this plug is approved by ASTA or BSI to BS1362. It should only be replaced by a correctly rated and approved type and the fuse cover must be refitted.

Never insert or remove the power plug with wet hands.
 This may cause electric shock.

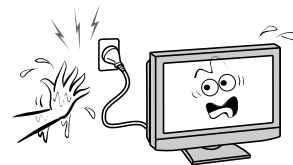

Do not place the TV in an unstabilized location such as on a shaky table, incline or location subject to vibration.
 The TV may drop or fall down which may cause injury or damage.

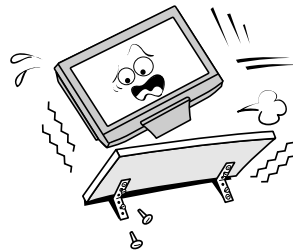

The slots and openings in the cabinet must never be blocked or covered.

- Do not place the TV so that it is facing upwards, or on its side.
- Do not place the TV into a closet or bookshelf where the ventilation is poor.
- Do not spread a newspaper, tablecloth or curtain on the TV.
- When installing the TV against a wall, keep the TV at least 10 cm from the wall.
- Do not place the TV on an unstable object, such as a carpet, or a cushion, etc.

The inside of this TV will overheat if the ventilation holes are sealed, which may result in a fire.

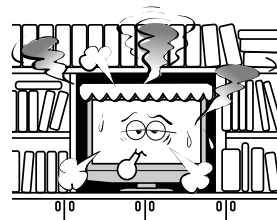

Never place the TV near a heater.

The surface of the cabinet or power cord may melt and result in fire or electric shock.



Important Safety Instructions (continued)

Installation (continued)

Do not place the TV in locations exposed to high humidity levels such as in a bathroom or close to a humidifier. This may cause a fire or an electric shock.

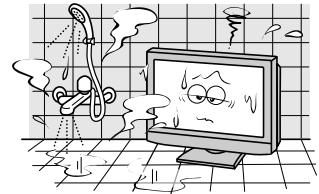

Do not place the TV next to a stove where it will be exposed to oil, smoke, or steam, or in a location where there is a large quantity of dust. This may cause a fire or electric shock.



Install the TV in a horizontal, stable location. Connect between two clips on the back of the TV and a wall, pillar, etc., with a sturdy tie and clip of supplied accessories (see page 43).

If the TV is not installed securely, it may lean or fall over and cause an injury.

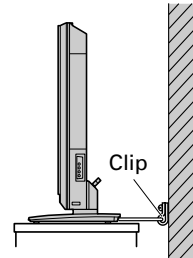

Side view

Sturdy tie
(as short as possible)

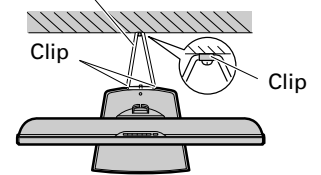

Top view

Precautions for moving the TV

- When moving the TV, be sure to remove the power plug from the wall outlet and disconnect the antenna cable and audio/video cables, any steady ties. Fire or electric shock may result if the power cord is damaged.
- When carrying the TV, at least two people are needed. Be sure to carry it upright.
- Do not carry the TV with the screen facing up or down.



Precautions for installing on outdoor antenna

An outside antenna system should not be located in the vicinity of overhead power lines, or other electric light or power circuits.

If the antenna falls down or drops, it may cause injury or electric shock accidents.



Use

Do not place hot objects or naked flame sources, such as lighted candles or nightlights on, or close to the TV. High temperatures can melt plastic and lead to fires.

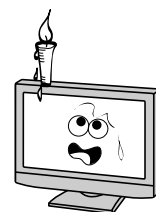

The apparatus shall not be exposed to dripping or splashing and that no objects filled with liquids, such as vases, shall be placed on the apparatus.

When liquids are spilled or small items are dropped inside the TV, this may cause a fire or an electric shock. If small objects drop inside the TV, turn off the TV and remove the power plug from the outlet immediately and contact a service technician.

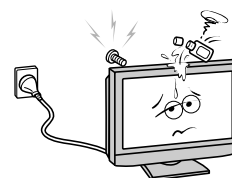

Do not insert objects (metal or paper) or pour water inside the TV from ventilation holes and other places.

These items may cause a fire or an electric shock. If these objects are inserted inside the TV, turn off the TV and remove the power plug from the outlet immediately and contact a service technician. Be especially careful that children do not insert objects in the TV.



Do not stand or climb on the TV.

Be especially careful in households with children to prevent them from climbing on top of the TV. It may move, fall over, break, become damaged or cause an injury.



When the TV will not be used for a long period of time, such as during vacation or travel, remove the power plug from the wall outlet for safety.

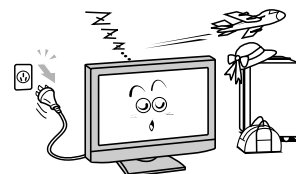

Important Safety Instructions (continued)

Use (continued)

Do not pull on the power cord when removing the plug from the wall outlet.

Always hold the plug firmly when removing it. If the power cord is yanked, the cord may become damaged and fire or electric shock may occur.

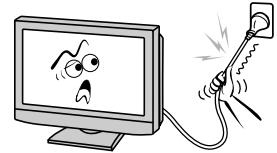

Do not cut, break, modify, twist, bunch up or bent the cord or apply excessive force or tension to it.

Do not place heavy objects on the cord or allow it to overheat as this may cause damage, fire or electric shock. Contact a service technician if the power cord is damaged.

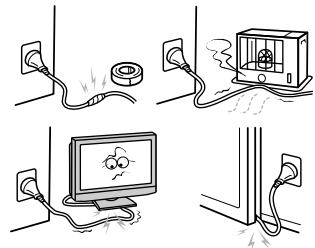

If there is thunder or lightning, do not touch the antenna cable or other connected cables.

You may suffer an electric shock.

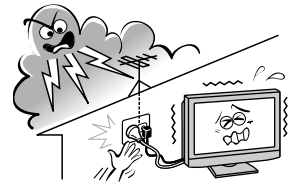

Service

Never repair, modify or disassemble the TV by yourself.

If it may cause a fire or an electric shock. Consult a service technician for inspection and repairs.

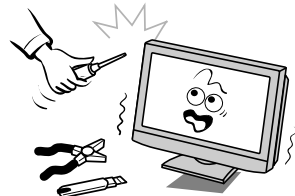

When a malfunction occurs, or if smoke or peculiar smells comes from the TV, turn off the TV and remove the power plug from the outlet immediately.

Make sure that the smoke or smell has stopped, then contact a service technician. If the TV is still used in this condition, it may then cause a fire or an electric shock.

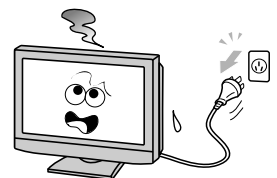

Service (continued)

If the TV is dropped or the cabinet is broken, turn off the TV and remove the power plug from the outlet immediately.

If the TV is still power used in this condition, it may cause a fire or an electric shock or an injury. Contact a service technician for inspection.

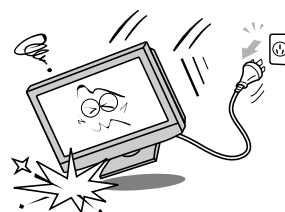

When the TV reaches the end of its useful life, ask a qualified service technician to properly dispose of the TV.

Note:

The lamp unit contains a small amount of mercury. Disposal of mercury may be regulated due to environmental considerations.

Dispose of the used lamp unit by the approved method for your area. For disposal or recycling information, please contact your local authorities.



Exemptions

- Toshiba is not liable for any damage caused by fires, natural disaster (such as thunder, earthquake, etc.), acts by third parties, accidents, owner's misuse, or uses in other improper conditions.
- Toshiba is not liable for incidental damages (such as profit loss or interruption in business, modification or erasure of record data, etc.) caused by use or inability to use of product.
- Toshiba is not liable for any damage caused by neglect of the instructions described in the owner's manual.
- Toshiba is not liable for any damage caused by misuse or malfunction through simultaneous use of this product and the connected equipment.

Cleaning

Remove the power plug before cleaning.

Do not use solvents such as benzine or thinner to clean the TV.

- These solvents may distort the cabinet or damage its finish.
- If rubber or vinyl products remain in contact with the TV for a long time, a stain may result.

If the cabinet becomes dirty, clean it with a soft, dry cloth.

When cleaning the surface of the LCD display:

- Wipe the panel surface gently with a soft, dry cloth.

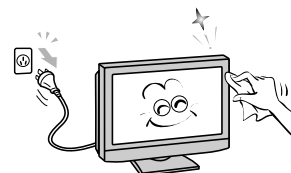

Periodically disconnect the power plug from the outlet and check it. If dust has collected on the power plug connectors, clean off the dust.

This dust may cause a fire due to reduced insulation on the plug.



Important information

Important information

About LCD screen

- If you have the LCD screen facing to the sun, the LCD screen will be damaged. Be aware of locating the TV in the place such as window side or outside of the room.
- Do not press the LCD screen strongly or scratch it, and do not put anything on it. These actions will damage the LCD screen.

About cabinet

- Do not spray volatile compounds such as insecticide on the cabinet.
This may cause a discoloration or damage the cabinet.

Some pixels of the screen do not light up

- The LCD display panel is manufactured using an extremely high level of precision technology, however sometimes some pixels of the screen may be missing picture elements or have luminous spots. This is not a sign of a malfunction.

About Interference

- The LCD display may cause interference in image, sound, etc. of other electronic equipment that receives electromagnetic waves (e.g. AM radios and video equipment).

About using under the low temperature places

- If you use the TV in the room of 0°C or less, the picture brightness may vary until the LCD monitor warms up.
This is not a sign of a malfunction.

About afterimage

- If a still picture is displayed, an afterimage may remain on the screen, however it will disappear.
This is not a sign of malfunction.

Installation

Connecting an antenna

Optimum reception of color requires a good signal and will generally mean that an outdoor antenna must be used. The exact type and positioning of the antenna will depend upon your particular area. Your Toshiba dealer or service personnel can best advise you on which antenna to use in your area. Before connecting the antenna cable, turn off all main POWER switches. Before connecting the antenna cable, remove the back terminal cover (see page 11).

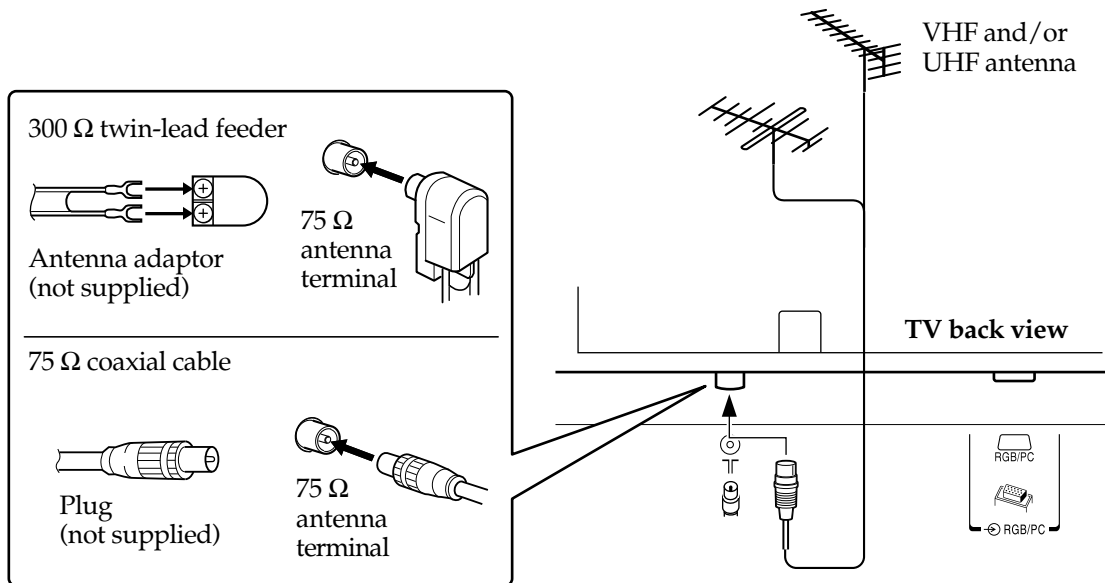

Installing the remote control batteries

Remove the battery cover. Insert two R03 (AAA) batteries matching the -/+ polarities of the battery to the -/+ marks inside the battery compartment.

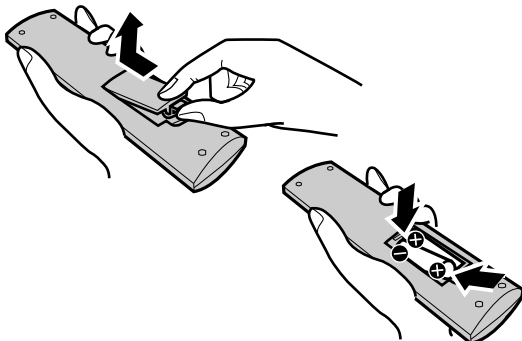

Caution:

- Dispose of batteries in a designated disposal area. Do not throw batteries into a fire.
- Attention should be drawn to the environmental aspects of battery disposal.
- Do not mix battery types or combine used batteries with new ones.

Effective range

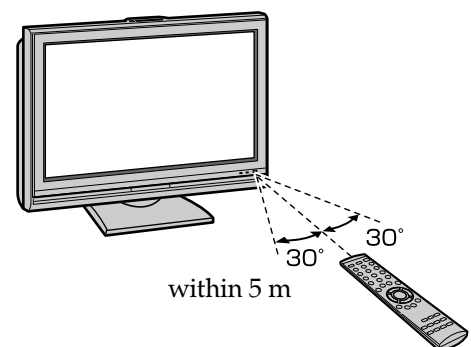

Notes:

- If the remote control does not operate correctly, or if the operating range becomes reduced, replace both batteries with new ones.
- If the batteries are dead or if you will not use the remote control for a long time, remove the batteries to prevent battery acid from leaking into the battery compartment.

Exploring your new TV

- You can operate your TV using the buttons on the top of the panel or the remote control. The back and side of the panel provide the terminal connections to connect other equipment to your TV. See "Equipment connections" on pages 36-38.

TV top

For the use of each control, see the pages in brackets.

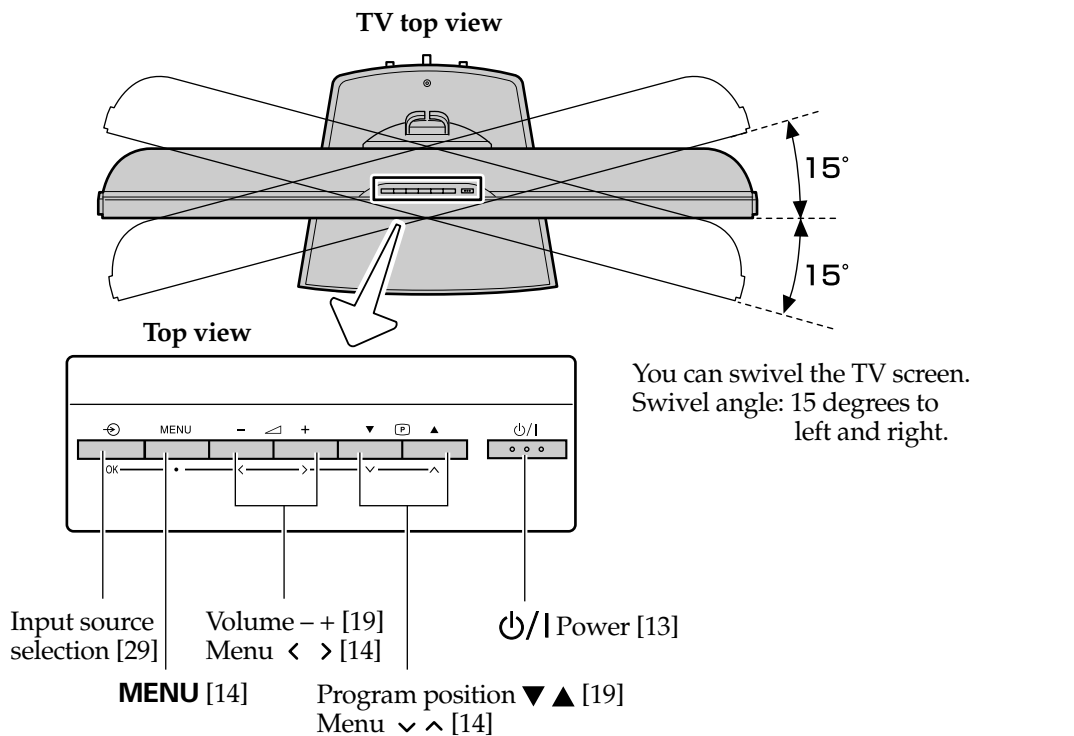

TV front

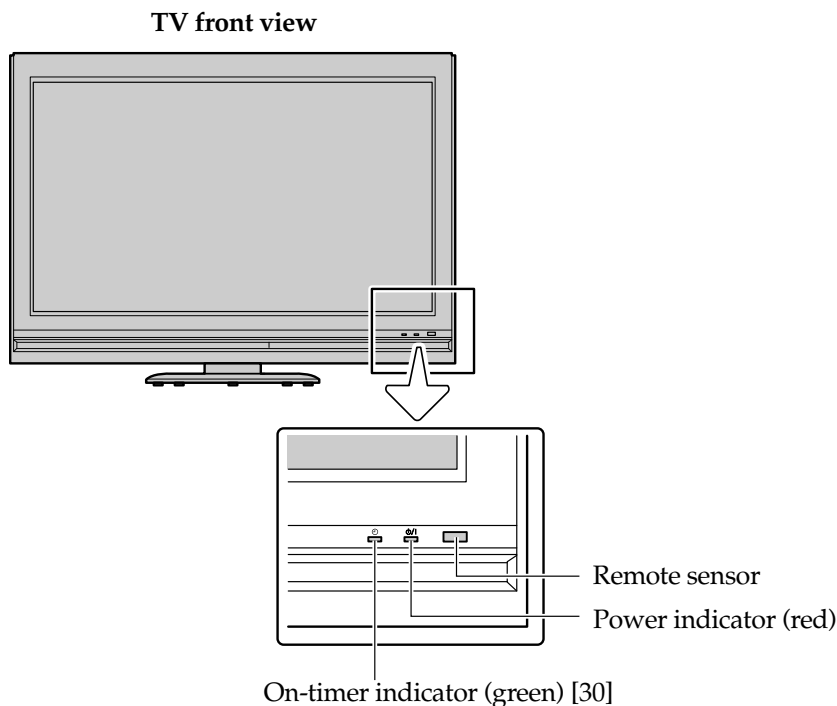

TV back

- Before the connecting external equipment etc., remove the back terminal covers (squeeze tabs (➔ mark in the figure below) and pull covers).

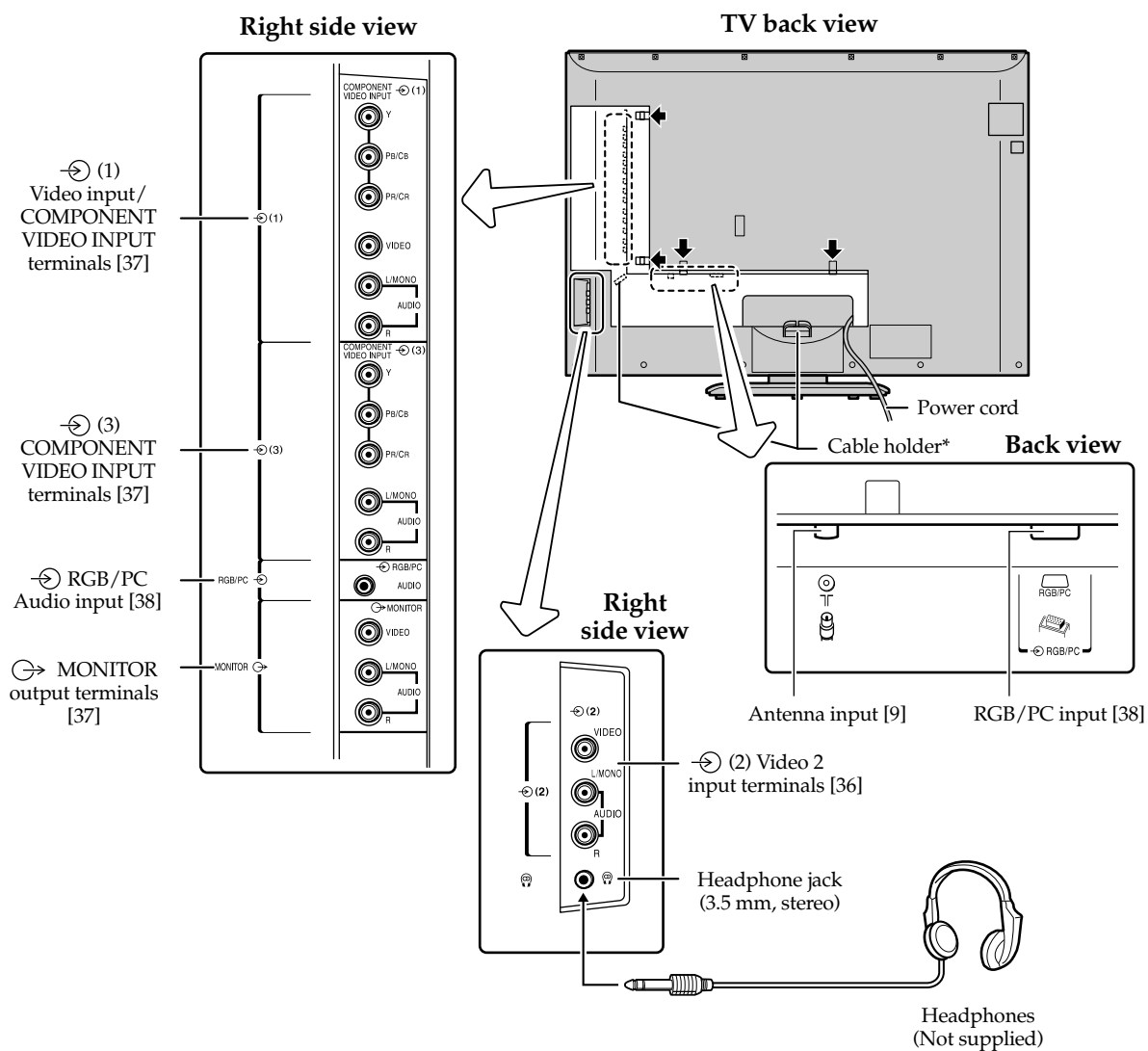

* You can use the cable holder to hold antenna cable, video and audio cables etc.

When moving the TV, do not hold this holder.

Note:

Inserting the Headphone jack will mute the sound from all speakers and deliver normal stereo left and right sounds to the headphones.

Learning about the remote control

Location of controls

For the use of each control, see the pages in brackets.

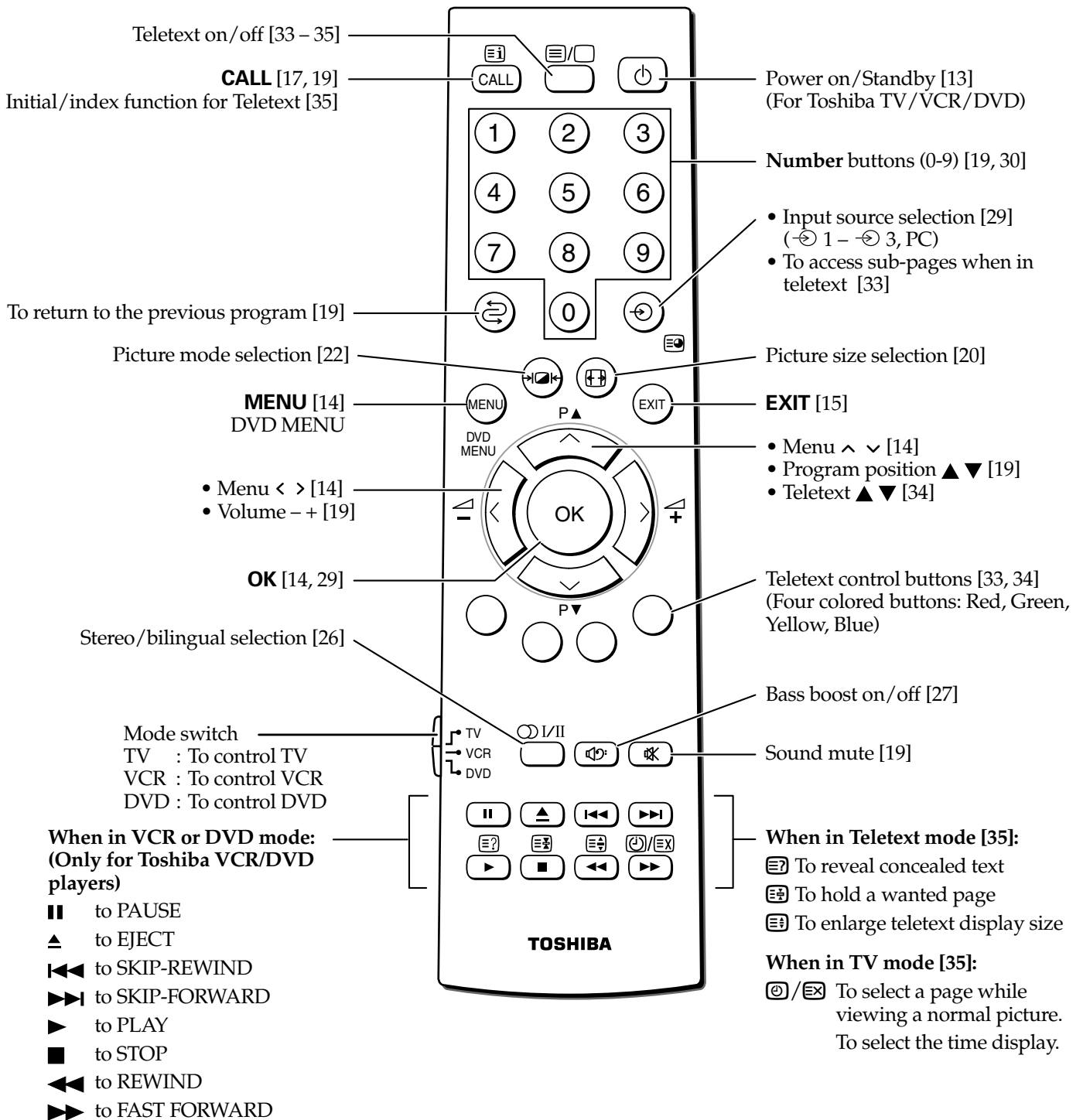

Turning the TV on

- Plug the power cord to a wall outlet.

Switching on the TV

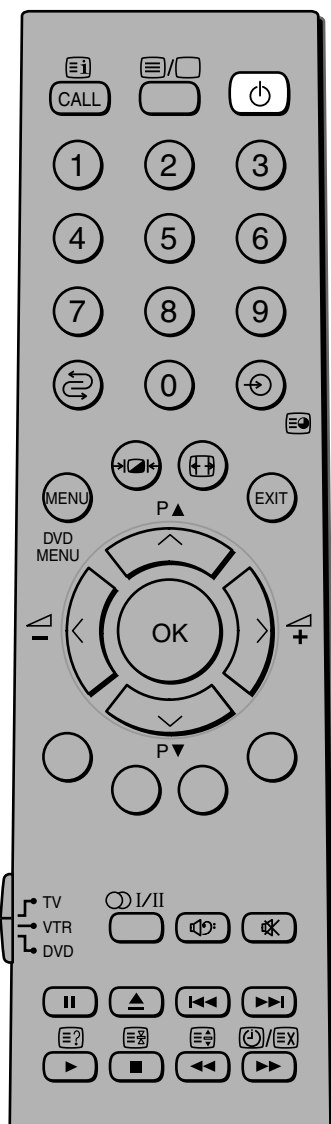
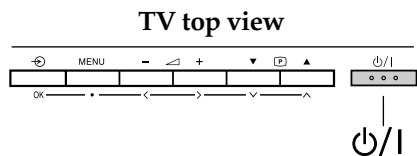

Note:

If you watch black and white programs when the color system mode is set to Auto, color noise may appear on the screen. In this case, select the appropriate Color system (For the system of each country or region, refer to pages 17 and 42).

- 1 Press the Power button on the TV or press the button on the remote control.

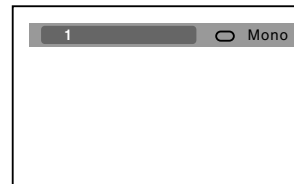

Switching off the TV

- 1 Press the Power button on the TV or press the button on the remote control to switch to the standby mode.

Notes:

- When the TV will not be used for a long period of time, such as during vacation or travel, remove the power plug from the wall outlet.
- The TV will automatically turn off after approximately 15 minutes if it is tuned to a vacant channel or a station that completes its broadcast for the day. This function does not work in external input or PC input mode.
- If power is cut off while you are viewing the TV, the Last Mode Memory function turns on the TV automatically when power is applied again. If power is going to be off for a long time and you are going to be away from your TV, unplug the power cord to prevent the TV from turning on in your absence.

Learning about the menu system

- We suggest you familiarize yourself with the display charts before using the menu system:
 - Press the **MENU** button to display menu, then press the < or > button to select main menu headings.
 - Press the ∨ or ∧ button to select an item.
 - Press the < or > button to select or adjust setting.
 - Press the **OK** button to display the next menu.

Menu display chart

PICTURE menu

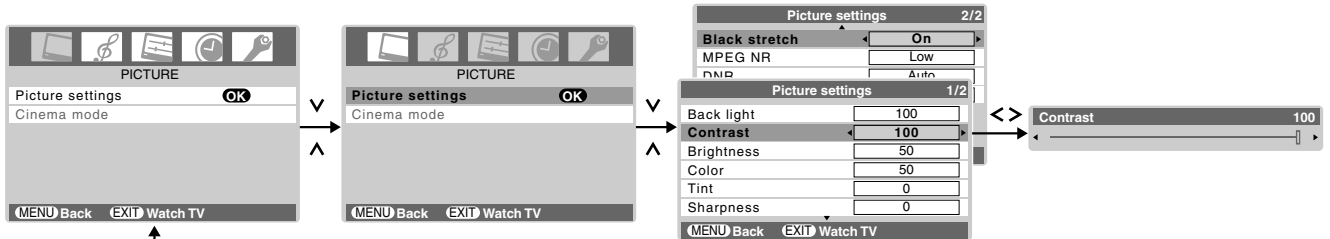

SOUND menu

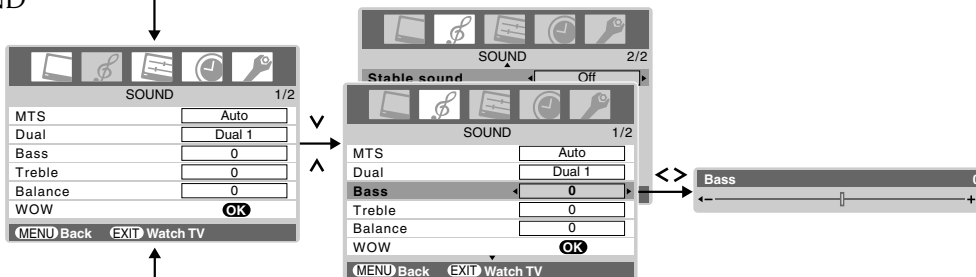

SET UP menu

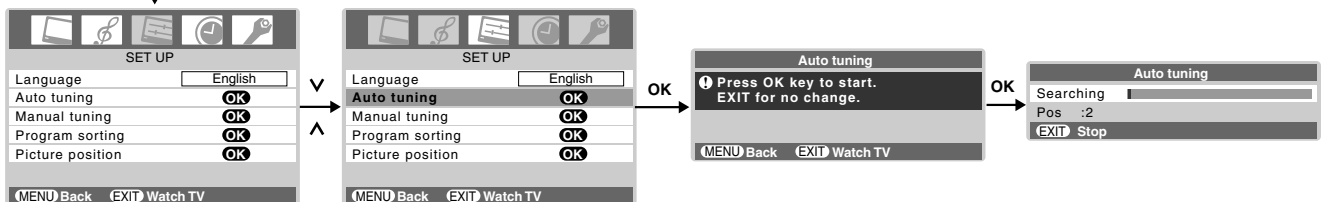

TIMER menu

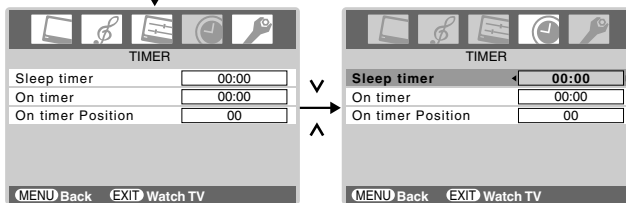

FUNCTION menu

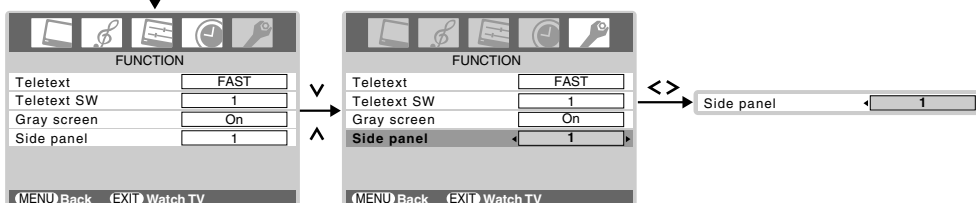

Selecting a language

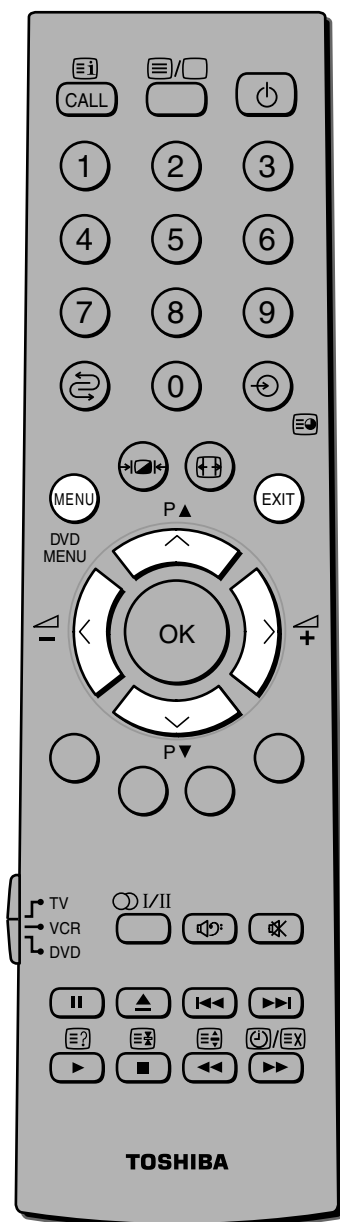

Choose from seven different languages (English, Chinese (CS), Malay, Thai, Vietnamese, Russian and Arabic) for the on-screen display.

- 1 Press the **MENU** button, then press the < or > button to display the SET UP menu.

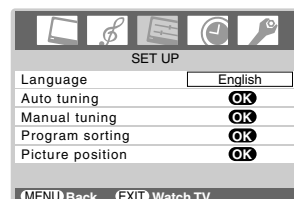

- 2 Press the ∇ or \blacktriangle button to select Language.

- 3 Press the < or > button to select the desired language.

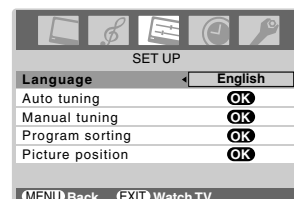

Notes:

- In the video input mode (1 - 3), Auto tuning, Manual tuning and Program sorting are not available. Instead, Manual setting appears in the SET UP menu (see page 29).
- If you connect external equipment via component video source to external input, Color system selection in the Manual setting menu is not available.
- If you do not make a selection for a while, the menu display disappears automatically.
- If you want to close the menu display instantly, press the **EXIT** button.
- To return to the previous menu, press the **MENU** button.
- The \wedge / ∇ buttons function as the Program position **P** \blacktriangle / **P** \blacktriangledown buttons when there is no menu display on the screen.
- The < / > buttons function as the Volume \blacktriangle / \blacktriangledown buttons when there is no menu display on the screen.
- In the PC input mode, PC Setting appears in the SET UP menu (see page 39).
- In the 480i or 576i input signals mode, you can select the Cinema mode in the PICTURE menu (see page 24).

Programming channel memory

- First, use the Auto tuning function to preset all the active channels in your area automatically. Then, arrange the preset channels with the Manual tuning function so that you can tune into only desired channels.
- Use the Channel search operation if desired channels cannot be preset with the Auto tuning or if you would like to preset channels to specific position numbers one by one.

System selection, Auto tuning

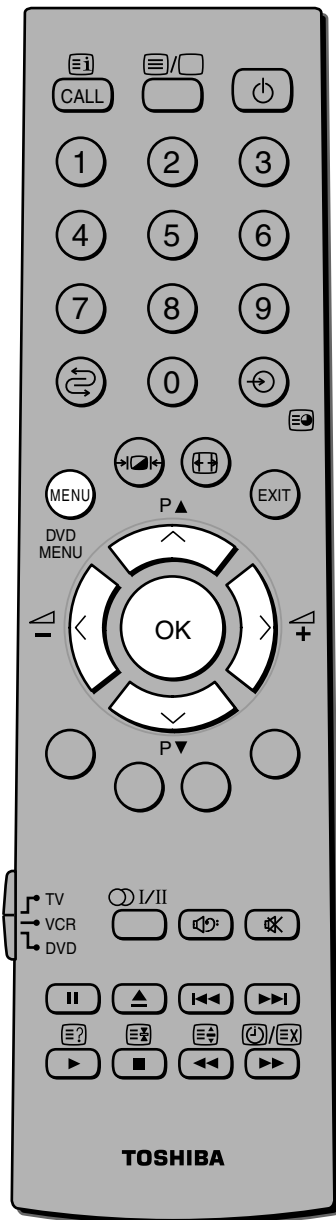

1 Press the **MENU** button, then press the < or > button to display the SET UP menu.

2 Press the ∨ or ∧ button to select Auto tuning.

3 Press the **OK** button to display the Auto tuning menu.

4 Press the **OK** button to start the automatic search. The search will begin for all available stations. The slide bar will move along the line as the search progresses.

If you make a mistake, simply repeat steps 1-4 to start again from the beginning.

5 When the automatic search is complete, the TV will automatically return to the first program position.

6 Press the P▲ or P▼ button to view the programmed position.

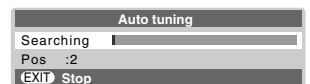
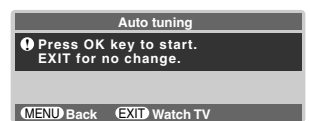
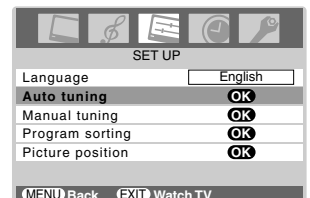

Manual tuning

1 Press the **MENU** button, then press the < or > button to display the SET UP menu. Press the ∨ or ∧ button to select Manual tuning.

2 Press the **OK** button to display the Manual tuning menu. Press the ∨ or ∧ button to select the program position you want to arrange.

3 Press the **OK** button to display the breakdown menu. Press the < or > button to select an item, then press the ∨ or ∧ button to select the item as shown below.

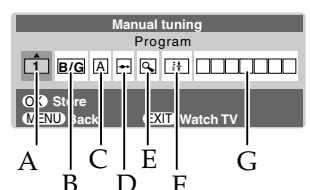
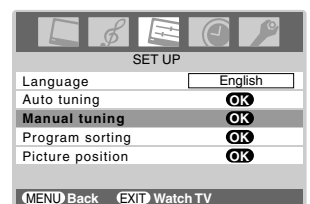

Manual tuning (continued)

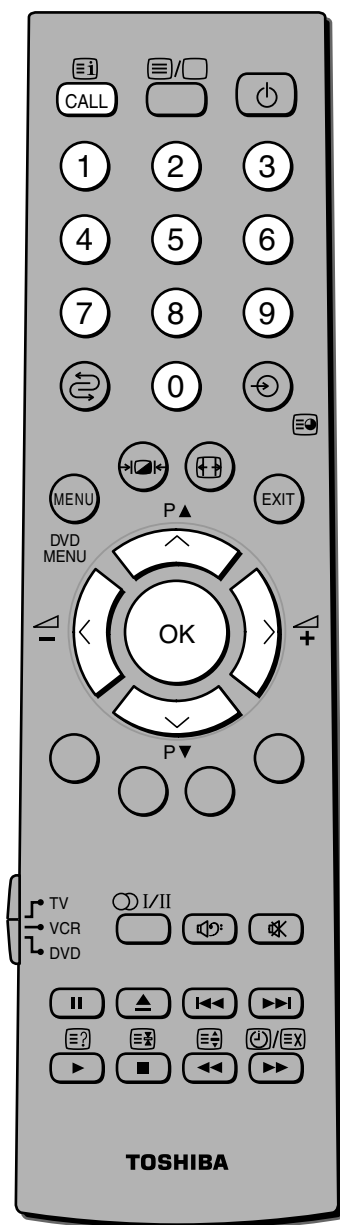

- A. Program position selection
 B. Sound system (see page 42)
 C. Color system (see page 42)
 A : Automatic (factory set), P : PAL, S : SECAM
 N4 : NTSC 4.43 (MHz), N3 : NTSC 3.58 (MHz)
 If the color of a certain channel is abnormal, the automatic color system selection (A) may have malfunctioned, or sound system selection is wrong. In such a case, select another color and/or sound system (see page 42).
- D. Program position skip selection
 Press the \wedge or \vee button to turn the program position skip option on “ \curvearrowright ” or off “ \curvearrowleft ”.
 The program position will then be skipped when you select channels with the **P \blacktriangle** or **P \blacktriangledown** button.
 The “ \curvearrowright ” mark will appear beside a program position number when you use the **Number** button on the remote control.
- E. Channel search operation
 Press the \wedge button to search up the band or the \vee button to search down the band.
 Press the \vee or \wedge button repeatedly until your desired channel is displayed.
 When a station/satellite is found, it will be displayed.
DO NOT PRESS ANY OTHER BUTTONS WHILE THE SET IS TUNING.
- F. Auto Fine Tuning
 Press the \vee or \wedge button to turn the Auto Fine Tuning option on “ ≡ ” or off “0”.
 The Auto Fine Tuning function automatically corrects slight fluctuations when receiving signals.
Manual Fine Tuning
 While the Auto Fine Tuning turn off “0”, press the \vee or \wedge button so that the better picture and sound are obtained.
- G. Label
 Station labels appear under the program position display each time you turn on the TV, select a channel, or press the **CALL** button.

To change or create station labels:

- 1) Press the \vee or \wedge button repeatedly to select a character for the first space, then press the \blacktriangleright button.

\rightarrow A \leftrightarrow Z \leftrightarrow (\leftrightarrow) \leftrightarrow * \leftrightarrow + \leftrightarrow , \leftrightarrow - \leftrightarrow . \leftrightarrow / \leftrightarrow 0 \leftrightarrow 9 \leftrightarrow □ \leftrightarrow

*(blank space)

- 2) Repeat step 1) to enter the rest of the characters. If you would like a blank space in the label name, you must choose a blank space from the list of characters.

Press the **OK** button to store your settings.

Programming channel memory (continued)

- This TV is capable of receiving a number of different channels depending upon where you live.
- Program sorting is an easy way of storing each channel on the program position of your choice.

Program sorting

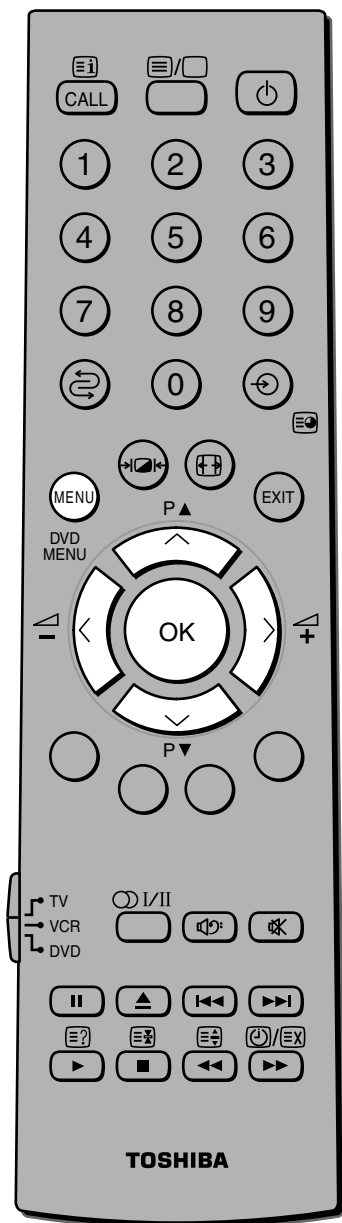

Ex.: To swap channel ABCD (Prog.1) for channel MNOP (Prog.4):

- 1 Press the **MENU** button, then press the < or > button to display the SET UP menu. Press the ^ or v button to select Program sorting.
- 2 Press the **OK** button to display the Program sorting menu.
- 3 Press the ^ or v button to select the channel ABCD, then press the > button.
- 4 Press the v button to select the new position "4", then press the < button.
- 5 Press the ^ button to select the channel MNOP, then press the > button.
- 6 Press the ^ button to select the new position "1", then press the < button.
- 7 Confirm new sorting list.

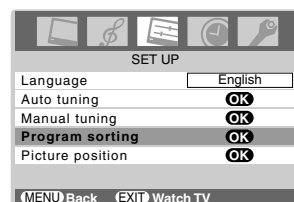

Watching TV programs

Volume, Sound mute, Changing program positions, Program return, On-screen information

TV top view

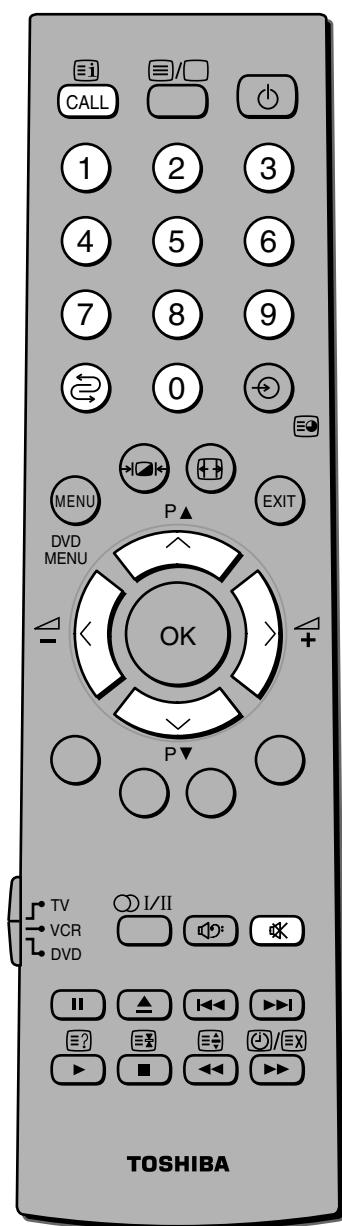
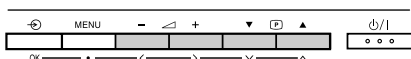
**Note:**

The program position selection change between different format channels takes several seconds.

To alter the volume:

- 1 Press the \triangle + or \triangle - button to raise or lower the volume.

**To mute the sound:**

- 1 Press the \times button. The word Sound mute appears on the screen.
- 2 Press the \times button again to restore the sound.

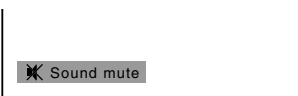
**To change program position:**

- 1 Enter the desired program position number using the **Number** buttons on the remote control.

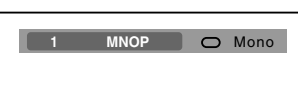

For program positions below 10, use 0 and the required number e.g., for program position 1.

- 2 You can also change the program position by using the **P▲** or **P▼** button.

The program position will be displayed on the screen with the Mono/Stereo/Dual audio status.

To switch between two program positions:

You can switch two program positions without entering actual position number each time.

- 1 Select the first program position you want to view.
- 2 Select the second program position with the **Number** buttons (0-9).
- 3 Press the \rightleftarrows button. The previous channel will be displayed.

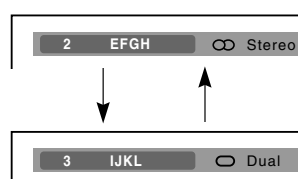

Each time you press the \rightleftarrows button, the TV will switch back and forth between the two program positions.

To display the on-screen information:

- 1 Press the **CALL** button to display the following on-screen information. The information will disappear in 6 seconds.
 - Program position or external input mode selected
 - Program skip on/off information
 - Label (if set)
 - Mono/Stereo/Dual audio status

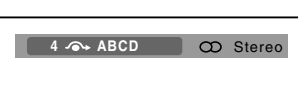

- 2 To erase the display instantly, press the **CALL** button again.

Viewing the wide-screen picture format

- This TV is capable of showing broadcasts in a number of formats. Depending on the type of broadcast being transmitted, you may select between Super live, Cinema, Subtitle, 14:9, Wide and 4:3.

Picture size selection



Notes:

- Using the special functions to change the size of the displayed image (e.g. changing the height/width ratio) for the purpose of public display or commercial gain may infringe on copyright laws.
- In the 720p/1081i input signals mode, the picture size selection is wide only.
- If the aspect ratio of the selected format is different from the one of the TV transmission or video program, it can cause a difference in vision. Change to the correct aspect ratio picture size.
- When the PC input mode (see page 29) is selected, the picture size selection is wide or 4:3 only.

Press the  button repeatedly to view the options available.

Super live

This setting will enlarge the 4:3 image to fit the screen by stretching the image vertically and horizontally, holding the correct proportions at the center of the image.

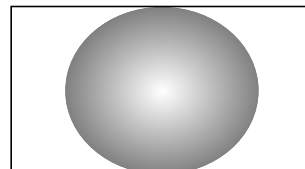

Cinema

When watching "letterbox format" films/video tapes, this setting will eliminate or reduce the black bars at the top and bottom of the screen by zooming in and selecting the image without distortion.

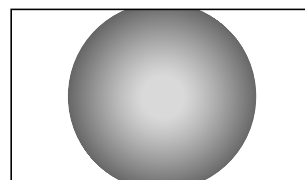

Subtitle

When subtitles are included on a letterbox format broadcast, this setting will raise the picture so that the most of text is displayed.

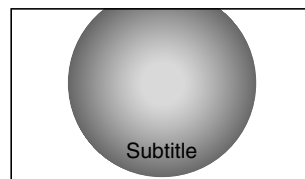

14:9

Use this setting when watching a 14:9 broadcast.

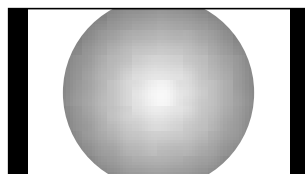

Wide

Use this setting when watching a wide-screen DVD, wide-screen video tape or a 16:9 broadcast (when available). Due to the range of wide-screen formats (16:9, 14:9, 20:9 etc.), you may see bars on the top and bottom of the screen.

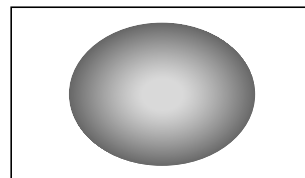

4:3

Use this setting to view a true 4:3 broadcast.

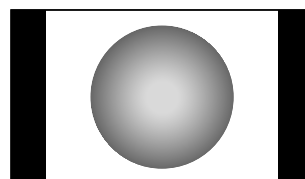

Picture position, Reset

Picture position adjustment

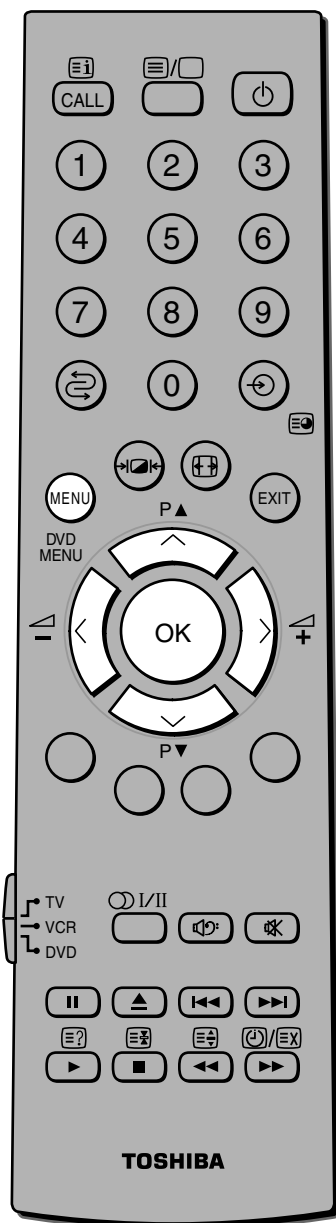

Notes:

- When the picture format is in Wide or 4:3 mode, only the Horizontal position can be adjusted.
- The picture position adjustment is not available for 720p/1080i input signals.

Adjustment to the position of the picture may be made to suit your viewing preferences.

To adjust the picture position:

- 1 Press the **MENU** button, then press the < or > button to display the SET UP menu.
- 2 Press the ∨ or ∧ button to select Picture position.
- 3 Press the **OK** button to display the Picture position menu.
The menu will vary depending upon the widescreen format you have previously chosen.
- 4 Press the ∨ or ∧ button to select an item you want to adjust.
- 5 Press the < or > button to adjust the settings as required.

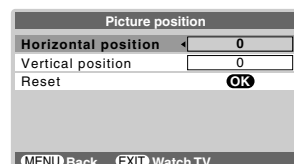
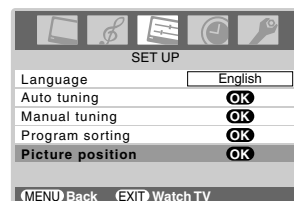

Reset (Picture position adjustment)

This function resets your picture position settings to the factory settings.

To reset the picture position:

- 1 Press the **MENU** button, then press the < or > button to display the SET UP menu.
- 2 Press the ∨ or ∧ button to select Picture position, then press the **OK** button.
- 3 Press the ∨ or ∧ button to select Reset, then press the **OK** button.

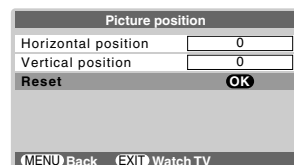
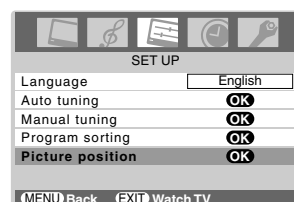

Picture quality adjustment

Picture quality adjustment

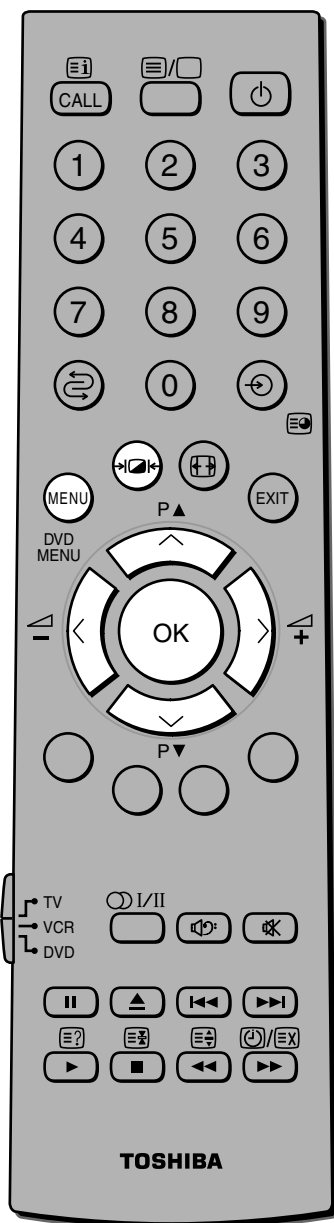
Note:

The Tint may only be adjusted on a tape which has been recorded and played back on an NTSC VCR.





To select the picture mode:

You can select the picture quality instantly among three preset modes and one user-set mode.

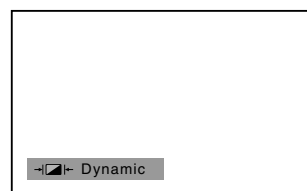
- Press the  button to select the desired picture quality.

Dynamic, Standard, Mild and Memory (user-set) can be selected cyclically.



Mode	Picture quality
 Dynamic	bright and dynamic picture
 Standard	standard picture
 Mild	soft picture
 Memory	the picture quality you set

Note:

In the PC input mode (see page 29), this mode is not available.

To adjust the basic picture quality:

- Press the **MENU** button, then press the **<** or **>** button to display the PICTURE menu.
- Press the **∨** or **∧** button to select the Picture settings menu, then press the **OK** button.
- Press the **∨** or **∧** button to select Back light, Contrast, Brightness, Color, Tint or Sharpness, then press the **<** or **>** button to adjust the level.

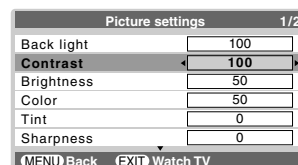

Selection	< Pressing >	
Back light	darker	lighter
Contrast	lower	higher
Brightness	darker	lighter
Color	paler	deeper
Tint	reddish	greenish
Sharpness	softer	sharper

To activate the black stretch

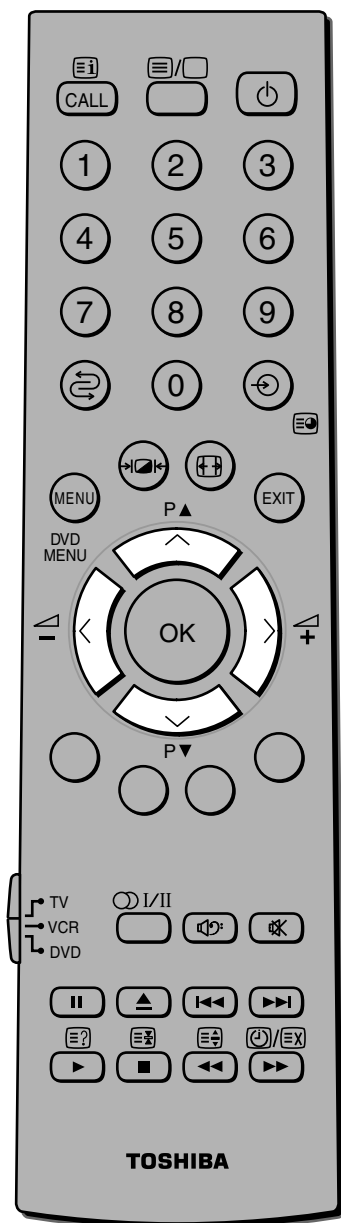

This function increases the strength of dark areas of the picture which improves definition.

- 1 From the Picture settings menu, press the \downarrow or \uparrow button to select Black stretch on the 2nd page.

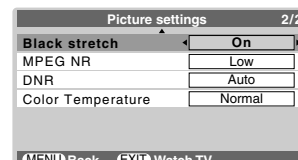

- 2 Press the \leftarrow or \rightarrow button to select On or Off.



To activate the MPEG NR (Noise Reduction)

If MPEG pictures include mosquito noise (grainy outlines around images within the picture which may result depending on compression and conversion rates), it may be reduced by using this function.

- 1 From the Picture settings menu, press the \downarrow or \uparrow button to select MPEG NR on the 2nd page.

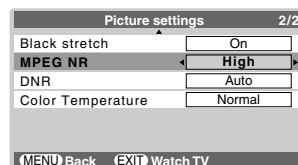

- 2 Press the \leftarrow or \rightarrow button to select Off, Low, Middle or High.



Note:

In the PC input mode (see page 29), this function is not available.

To activate the DNR (Digital Noise Reduction)

If the received signal is weak and the picture is blurry, the picture may be improved by using this function.

- 1 From the Picture settings menu, press the \downarrow or \uparrow button to select DNR on the 2nd page.

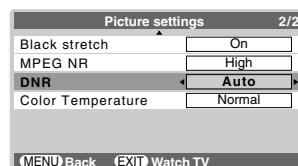

- 2 Press the \leftarrow or \rightarrow button to select Auto, Low, Middle, High or Off.



Note:

This function is available for 480i and 576i signals.

Picture quality adjustment (continued)

To select the color temperature

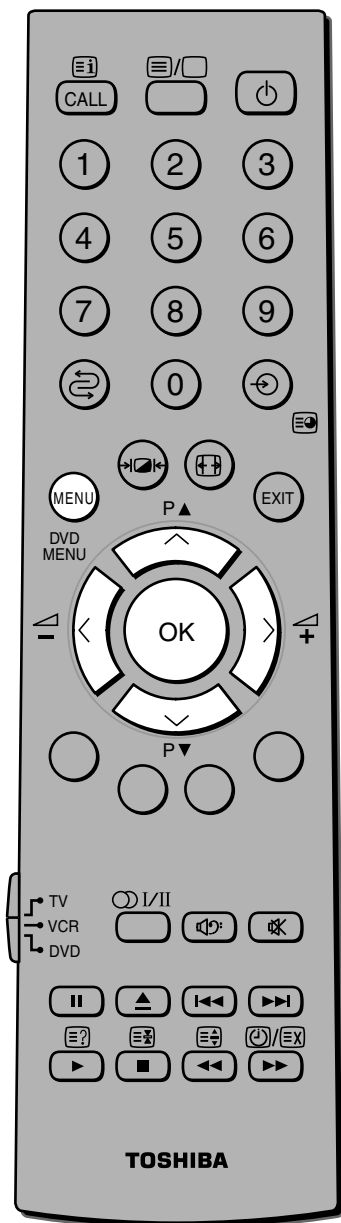

You can change the tone of the picture by selecting from three preset color temperatures: Cool, Normal or Warm.

- 1 Press the **MENU** button, then press the < or > button to display the PICTURE menu.
- 2 Press the ∨ or ∧ button to select the Picture settings menu, then press the **OK** button.
- 3 Press the ∨ or ∧ button to select Color Temperature on the 2nd page, then press the < or > button to select mode you prefer.

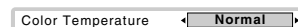
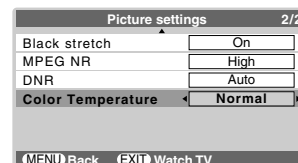

Cool : Lends a blue hue to the picture.
 Normal : Neutral
 Warm : Lends a red hue to the picture.

To use the cinema mode

A movie film's picture runs at 24 frames a second, whereas movie software such as DVD, etc., that you enjoy watching on television at home runs at 30 (NTSC) or 25 (PAL) frames a second. To convert this signal to reproduce a smooth motion and picture quality, select the On mode.

Effective signal and setup conditions

- When the Video input mode is selected.
- When the input signal format is 480i and 576i signals.

- 1 Press the **MENU** button, then press the < or > button to display the PICTURE menu.
- 2 Press the ∨ or ∧ button to select Cinema mode, then press the < or > button to select On or Off.

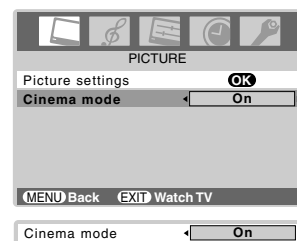

Note:

A DVD movie with a subtitle is input from a DVD player, the Cinema mode may not work correctly.

Sound adjustment

MTS (Multi-channel TV Sound) setting

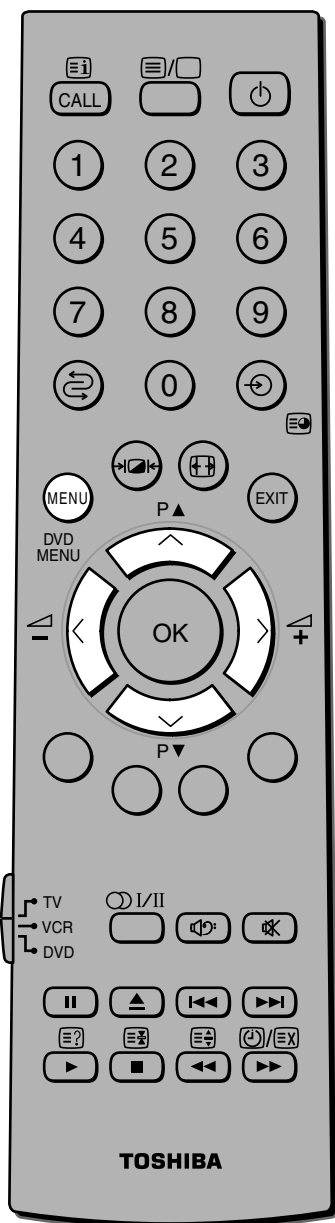

Setting the MTS mode:

Auto mode

The MTS Auto mode automatically recognize stereo/bilingual programs depending on the broadcast signal.

- 1 Press the **MENU** button, then press the < or > button to display the SOUND menu.
- 2 Press the ∨ or ∧ button to select MTS, then press the < or > button to select Auto or Mono.

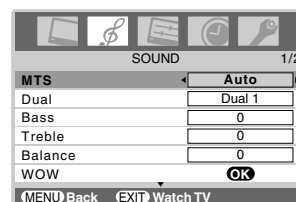

Mono mode

If you experience noise or poor reception of any stereo/bilingual program, set the MTS mode to Mono. Noise will be reduced and reception may improve.

Note:

If you experience noise with a particular program on whose channel reception is usually good, try setting MTS mode to Auto, then switch the /II button to Mono (monaural) (see page 26).

Selecting the Dual 1 or Dual 2 mode

You can hear only Dual 1 or Dual 2 sound selected, whenever bilingual programs are received.

- 1 Press the **MENU** button, then press the < or > button to display the SOUND menu.
- 2 Press the ∨ or ∧ button to select Dual, then press the < or > to select Dual 1 or Dual 2.

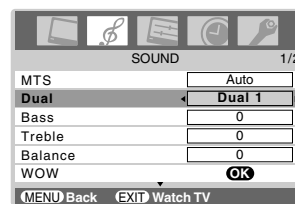

Notes:

- When the MTS setting is in Mono mode, the Dual menu is not selectable.
- The Dual menu setting status remains even if the TV is turned off.

Sound adjustment (continued)

Stereo/Bilingual selection

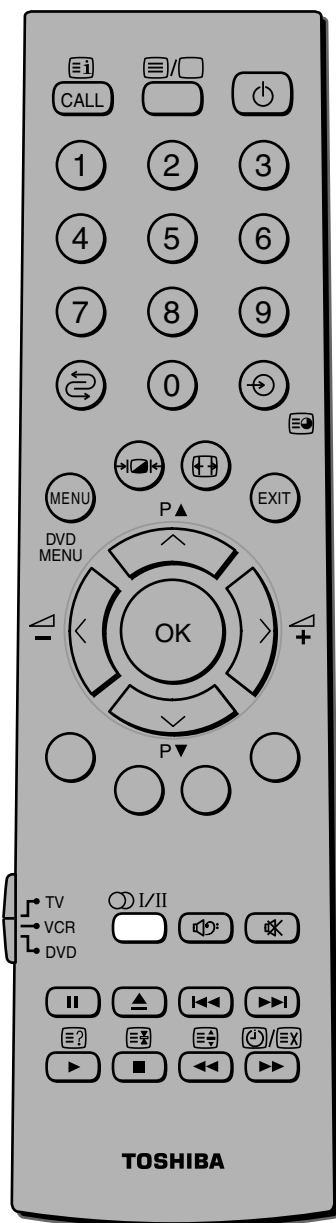

To select the stereo programs:

- 1 When a stereo program is received, Stereo appears.
- 2 Press the button to select the stereo/monaural mode. Stereo and Mono appear cyclically on the screen.

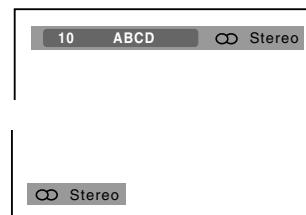

Display	Reception mode
Stereo	Stereo
Mono	Monaural

To select the bilingual programs:

- 1 When a bilingual program is received, Dual appears.
- 2 Press the button to select the sound to be heard. The sound differs according to the transmission system: NICAM or German stereo/bilingual broadcast. Dual 1, Dual 2 and Mono appear cyclically on the screen.

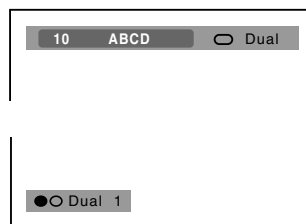

Display	Sound to be heard	
	NICAM	German stereo/bilingual broadcast
Dual 1	Sub I sound	Main sound
Dual 2	Sub II sound	Sub sound
Mono	Main sound	—

Note:

These settings are not stored in the TV memory.

Sound quality adjustment

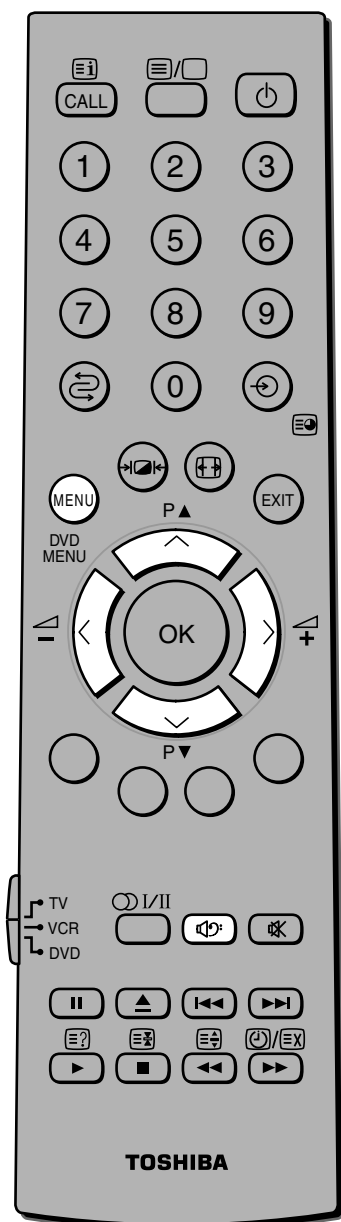

Note:

The Bass boost effect is active only when the sound outputs from the speaker.

To adjust the sound quality:

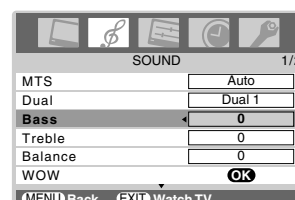

- 1 Press the **MENU** button, then press the < or > button to display the SOUND menu.
- 2 Press the ∨ or ∧ button to select Bass, Treble or Balance.
- 3 Press the < or > button to adjust the level.



Selection	< Pressing	>
Bass	weaker	stronger
Treble	weaker	stronger
Balance	decreases the right channel	decreases the left channel

Bass boost

To use the Bass boost:

- 1 Press the  button to display Bass boost level.
- 2 While the Bass boost display is on the screen, press the ∆ + or ∇ - button to adjust the Bass boost level.
- 3 To turn off the Bass boost, press the  button to display Bass boost Off.



Sound adjustment (continued)

To use the WOW surround sound

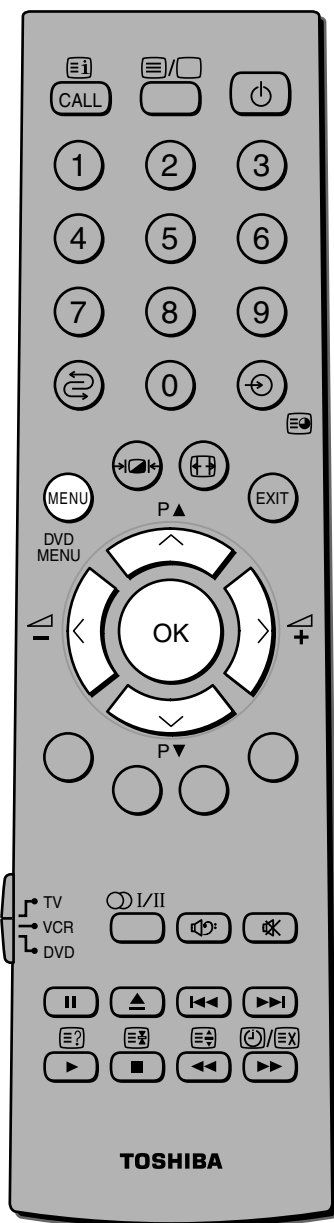

WOW is a special combination of SRS Labs audio technologies that creates a thrilling surround experience with deep, rich bass from stereo sound sources. Your TV's audio will sound fuller, richer and wider.

- 1 Press the **MENU** button, then press the < or > button to display the SOUND menu.
- 2 Press the ∨ or ∧ button to select WOW, then press the **OK** button.
- 3 Press the ∨ or ∧ button to select an item you want to adjust, then press the < or > button to adjust the settings as required.

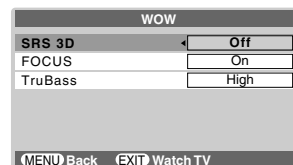
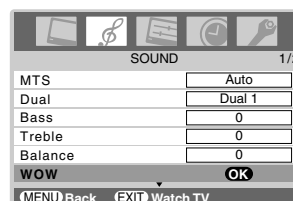

- SRS 3D: To turn On or Off the surround effect.
- FOCUS: To turn On or Off the surround effect.
- TruBass: To select your desired bass expansion level (Off, Low or High).

To use the Stable sound

When the signal source is changed, the Stable sound function limits the high volume level to prevent extreme changes in volume. For example, this will prevent the sudden increase in volume that often happens when a TV program switches to a commercial.

- 1 From the SOUND menu, press the ∨ or ∧ button to select Stable sound on the 2nd page.
- 2 Press the < or > button to select On or Off.



Notes:

- If the broadcast is monaural, the SRS 3D effect does not work.
- WOW, SRS and (●)® symbol are trademarks of SRS Labs, Inc.
- WOW technology is incorporated under license from SRS Labs, Inc.

Input selection

Input selection

TV top view

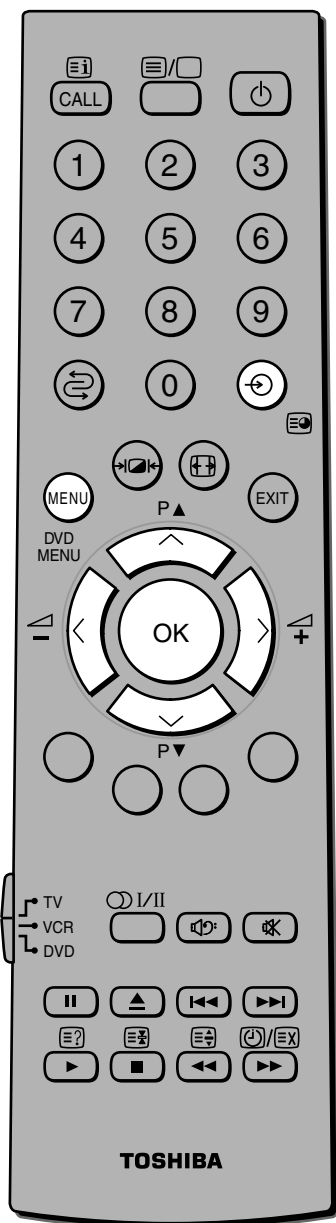

Notes:

- To return to the TV mode from the PC input mode, press the **↻** button.
- When the component video input or PC input mode is selected, the **↻** MONITOR output terminals (see page 37) output audio signal only.

To select input source:

- 1 Press and hold the **↻** button or press the **OK** button on the remote control until the video input mode list appears on the screen, then press the **∨** or **∧** button to select appropriate input source (or press the **↻** button on the top of the panel or **↻** button on the remote control repeatedly to select required input source directly).
- 2 Press the **OK** button.
 - ↻ 1 (↻ (1), video 1 input),
 - ↻ 2 (↻ (2), video 2 input),
 - ↻ 3 (↻ (3), video 3 input), PC (↻ RGB/PC, PC input)

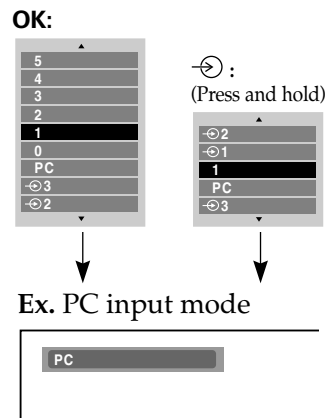

Manual setting:

- 1 Press the **MENU** button, then press the **<** or **>** button to display the SET UP menu.
- 2 Press the **∧** or **∨** button to select Manual setting, then press the **OK** button.
- 3 Press the **<** or **>** button to select an item, then press the **∧** or **∨** button to select the item as shown below.

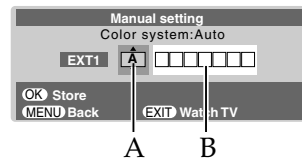
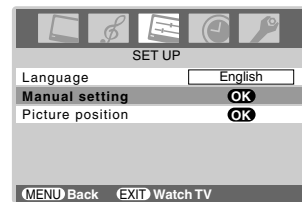

A. Color System
Confirm that color system is set to "A" (Auto). If not, select "A" with the **∧** or **∨** button.

B. Video label
The video label allows you to label each input source for your TV.

To change or create video labels:

- 1) Press the **∧** or **∨** button repeatedly to select a character for the first space, then press the **>** button.

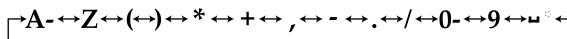

* (blank space)

- 2) Repeat step 1) to enter the rest of the characters. If you would like a blank space in the label name, you must choose a blank space from the list of characters. Press the **OK** button to store your settings.

Timer, Gray screen

Timer

The Timer is especially useful if you want the TV to turn itself on or off after a selected period of time. Activation of the Timer is indicated by the green "On-timer indicator", on the front of the TV (see page 10).

TV top view

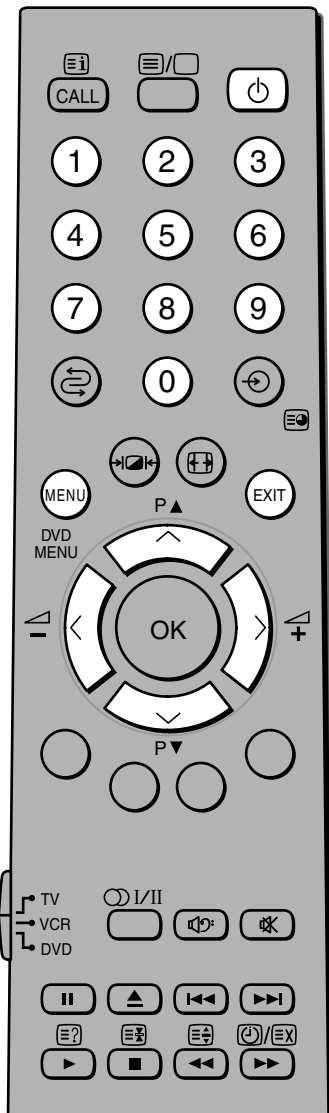
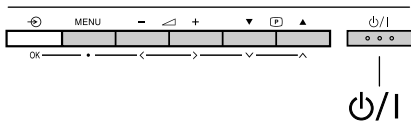

To select the timer menu:

- 1 Press the **MENU** button, then press the < or > button to display the **TIMER** menu.
- 2 Press the ∨ or ∧ button to select the required timer mode (On timer or Sleep timer (Turn off the TV)).
- 3 Press the **Number** buttons (0-9), < or > button to set the On or Off delay time, e.g. on in 30 minutes and program 3 selected.
- 4 Press the **EXIT** button to exit the menu. When setting the On timer, press the ∨ or ∧ button to select the On timer Position and enter the program position number you want to watch. Set the Standby mode by pressing the ⏻ button on the remote control or ⏻/| Power button on the TV.

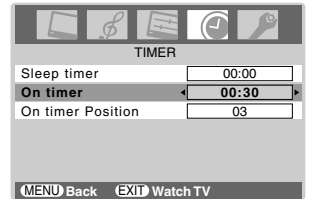

Note:

The time display will set by 10 minutes, up to 12 hours 50 minutes.

To activate Gray screen

With the Gray screen function On, the screen will automatically turn gray and the sound will be muted when no signal is being received.

- 1 Press the **MENU** button, then press the < or > button to display the **FUNCTION** menu.
- 2 Press the ∨ or ∧ button to select Gray screen.
- 3 Press the < or > button to select On or Off.

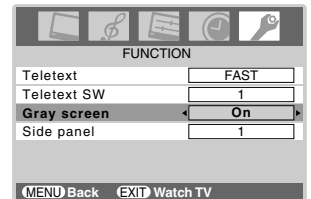

Note:

In the PC input mode (see page 29), the Gray screen is not available.

Side panel adjustment

Side panel adjustment

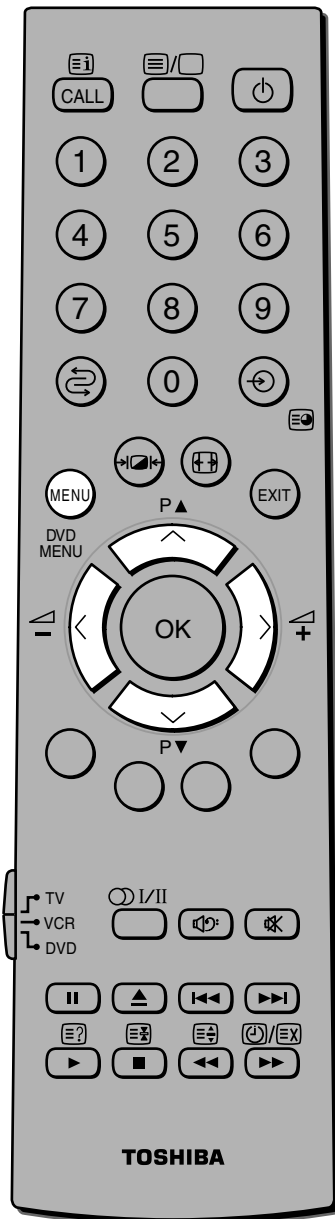

You can adjust the brightness of side panel in 14:9 or 4:3 mode.

To adjust the Side panel setting:

- 1 Press the **MENU** button, then press the < or > button to display the FUNCTION menu.
- 2 Press the ∨ or ∧ button to select Side panel.
- 3 Press the < or > button to adjust the settings as required.

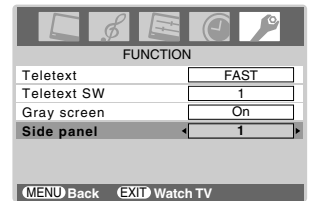

Teletext - Setting up

- This TV has a multi-page teletext memory, which takes a few moments to load and it offers two ways of viewing Teletext FAST and LIST which are explained on page 34.

Teletext mode

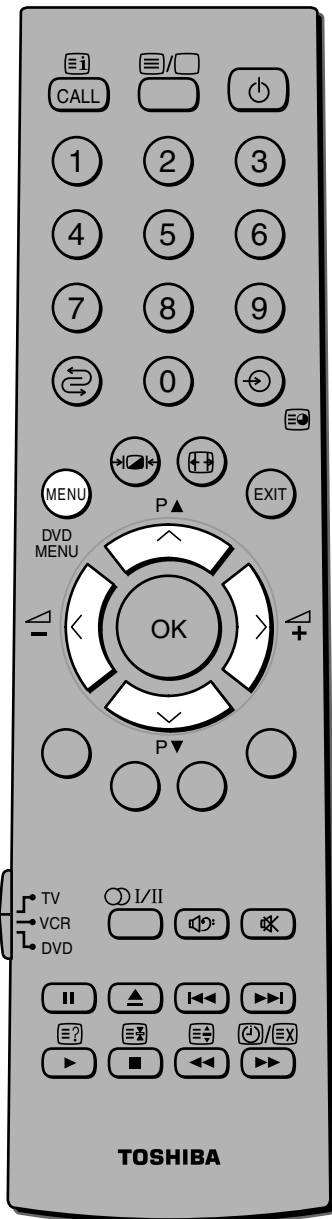

To select Teletext mode:

Select a channel position with the desired teletext service.

- 1 Press the **MENU** button, then press the < or > button to display the FUNCTION menu.
- 2 Press the ∨ or ∧ button to select Teletext.
- 3 Press the < or > button to select FAST or LIST mode.

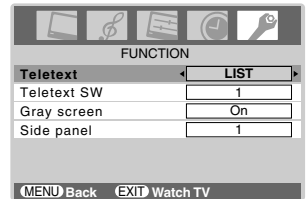

Note:

When you are watching the teletext program, SET UP menu and FUNCTION menu are not selectable.

About Teletext

Teletext general information

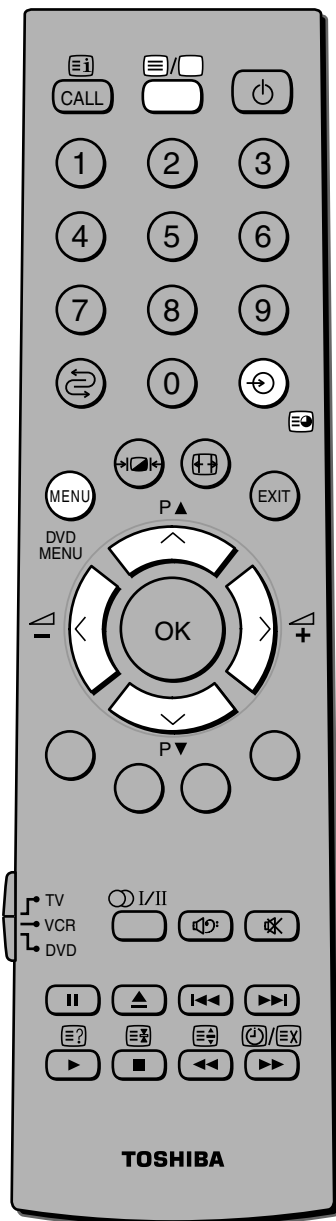

☐/☐ button:

Pressing the ☐/☐ button once will bring up the teletext screen. Press again to superimpose the teletext over a normal broadcast picture. Press again to return to normal TV mode. You need to return to normal viewing if you wish to change channels.

When you first press the ☐/☐ button to access the text service, the first page you see will be the initial page.

In **FAST** mode, this displays the main subjects available and their relevant page numbers.

In **LIST** mode, you will see the page numbers currently stored on the **each color** button.

Sub-pages:

Once in this chosen page, if there are sub-pages they will automatically load into memory without changing the one you are reading. Arrows will appear alongside the page number, indicating sub-pages which have loaded to the left or right of the one on the screen. If there are many sub-pages, it will take a long time for them all to load and this will depend on the speed with which the broadcaster transmits them.

To access the sub-pages in memory, press the ☐ (↻) button, then use the ^ and v buttons to view them.

Teletext SW adjustment

If reception is weak, the picture may appear blurred, and text may not appear clearly on the screen. In this case, use this function to make text appear clearer.

- 1 Press the **MENU** button, then press the < or > button to display the **FUNCTION** menu.

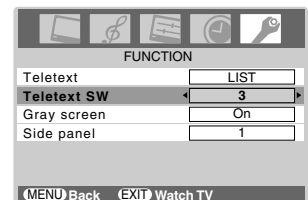

- 2 Press the v or ^ button to select Teletext SW, then press the < or > button to adjust 1, 2 or 3 modes.

Notes:

- This function may not be available in some cases.
- Only in the antenna input signal mode, this function is available.

Teletext - FAST and LIST modes

Using FAST mode

There are two Modes: FAST will display FASTEXT, if available. LIST will display your four favorite pages. In either mode, as an alternative to the colored buttons, you can access a page by entering a 3-digit number, using the **Number** buttons on the remote control, or to advance to the next page, press the **P▲** (^) button, to go back to the previous page press the **P▼** (v) button.

To change between FAST and LIST, see page 32.

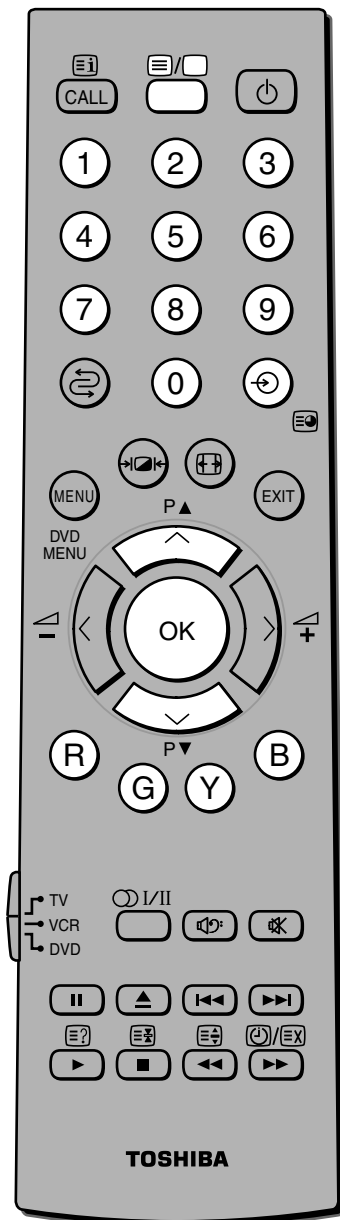

Press the button to access teletext.

If FASTEXT is available, you will see 4 colored titles at the base of the TV screen. To access any given subject, simply press the relevant colored button on the remote control.

If FASTEXT is not available, you can access any page simply by entering a 3-digit page number or pressing the corresponding colored button.

For further information on your particular text system(s), see the broadcast teletext index page or consult your local Toshiba dealer.

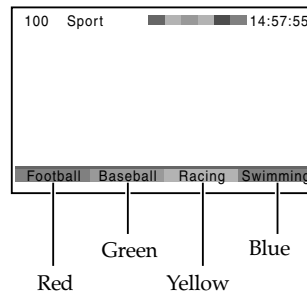

Using LIST mode

1 Press the button to access teletext.

The four choices at the bottom of the screen are now number – 100, 200, 300 and 400, which have been programmed into the TV's memory.

2 To view these pages, use the colored prompt buttons. e.g. press the Green button to view page 200.

3 If you want to change these stored pages, press the colored button for the color you want to change. e.g. Press the Green button and enter the 3-digit number.

This number will change in the top left of the screen and in the colored highlight.

4 Press the **OK** button to store your choice. The bars at the bottom of the screen will flash white.

5 You may view other pages by simply entering the 3-digit page number – but **DO NOT** press the **OK** button or you will lose the favorite already stored.

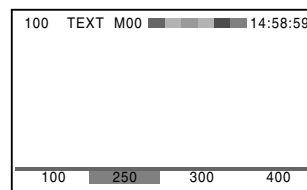
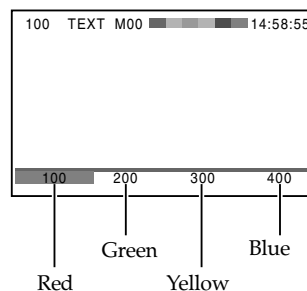

Teletext - Control buttons

- Below is an introduction to the teletext buttons on your remote control and their functions.

Teletext buttons on the remote control

Note:

It will not be possible to change program position while in Teletext mode, you will have to cancel the teletext first by pressing the  button to return to a normal TV picture.

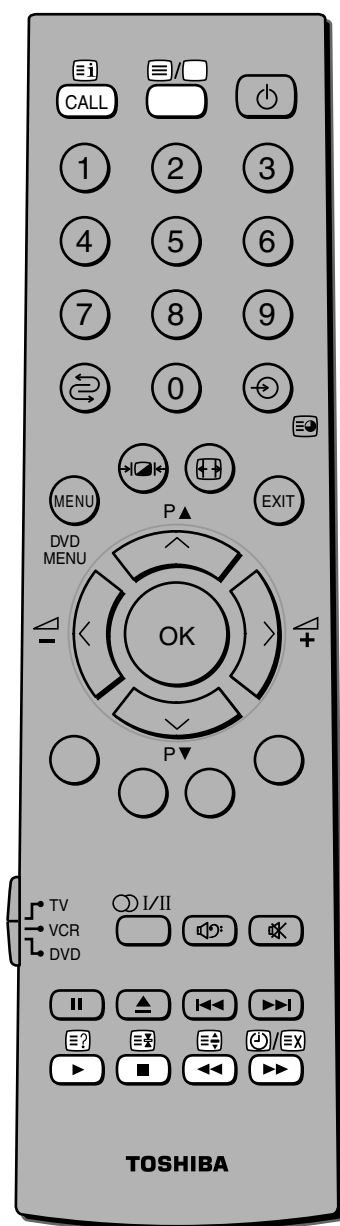

To display a page of teletext:

Press the  button to display teletext. Press again to superimpose the teletext over a normal broadcast picture. Press again to return to normal TV mode.

To display an index/initial page:

In FAST-mode

Press the  button to access the index page. The one displayed is dependant on the broadcaster.

In LIST-mode

Press the  button to return to the 100 page or initial page.

To reveal concealed text:

Some pages cover topics such as quizzes and jokes. To discover the solutions, press the  button.



To hold a wanted page:

This function is included as it is part of the broadcast teletext system but you will not need it as this TV allows you to control the display of sub-pages.

To enlarge the teletext display size:

Press the  button once to enlarge the top half of the page, press again to enlarge the bottom half of the page. Press again to revert to the normal size.

To select a page while viewing a normal picture:

When in teletext mode, if a page selection is made and then the  button is pressed, a normal picture will be displayed. The TV will indicate when the page is present by displaying the title bar of the text page at the top of the screen. Press the  button to view the page.

To select the time display:

If you press the  button while watching a normal TV broadcast, you will see a time display from the broadcaster. It will remain on the screen for about 5 seconds.

9:56 and 25 seconds p.m.

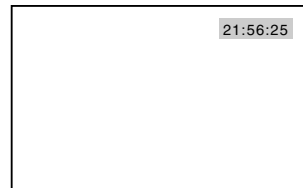

Side connections

- You can connect a wide variety of auxiliary equipment via the terminals located on the right side of the TV → (2).

Connection example

Please always refer to the owner's manual of the equipment to be connected for full details.

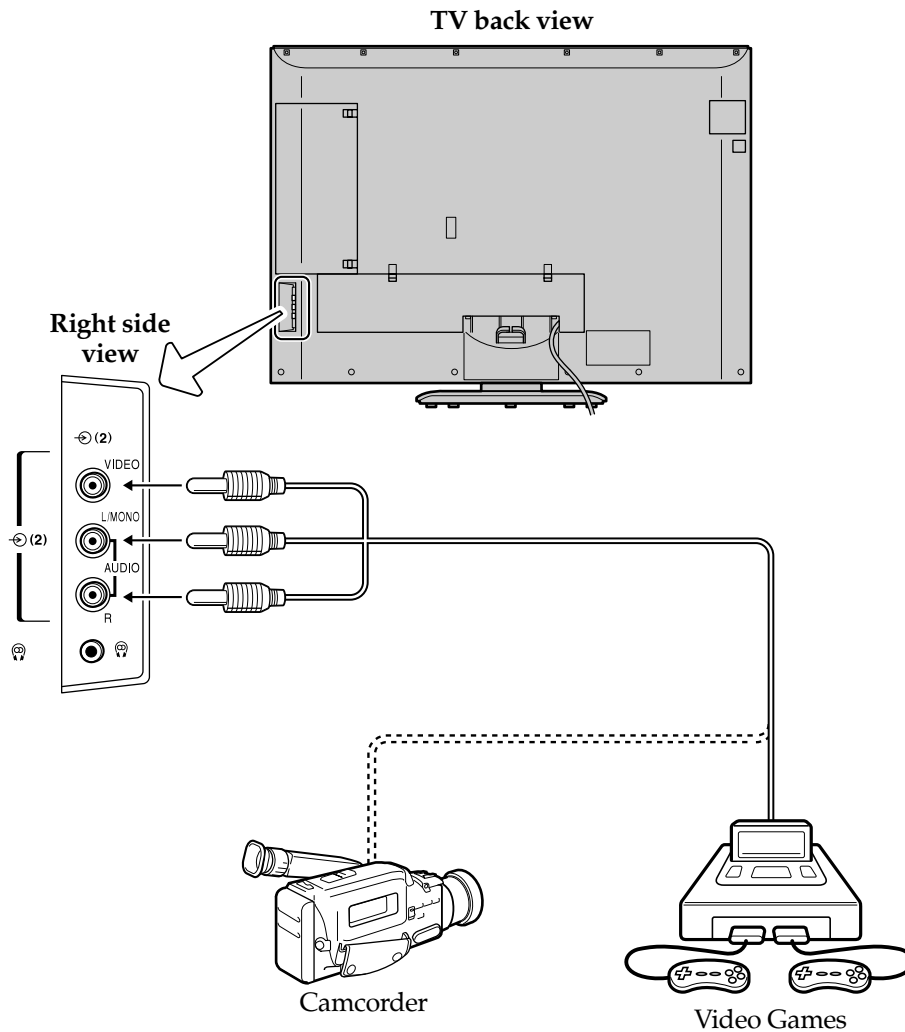

- To select the side inputs, press and hold the → button until the video input mode list appears on the screen, then press the ^ or v button to select → 2 (see page 29), then press **OK**.
- Before connecting any external equipment, turn off all main power switches.
- If you connect mono sound equipment to → (2), connect the audio output of the equipment to the L/MONO jack on the TV.
- You can enjoy Video Games with this TV. However shooting games, which shoots at a target on the TV screen with a light gun, may not work because of the LCD Color TV properties.

Back connections

Connection example

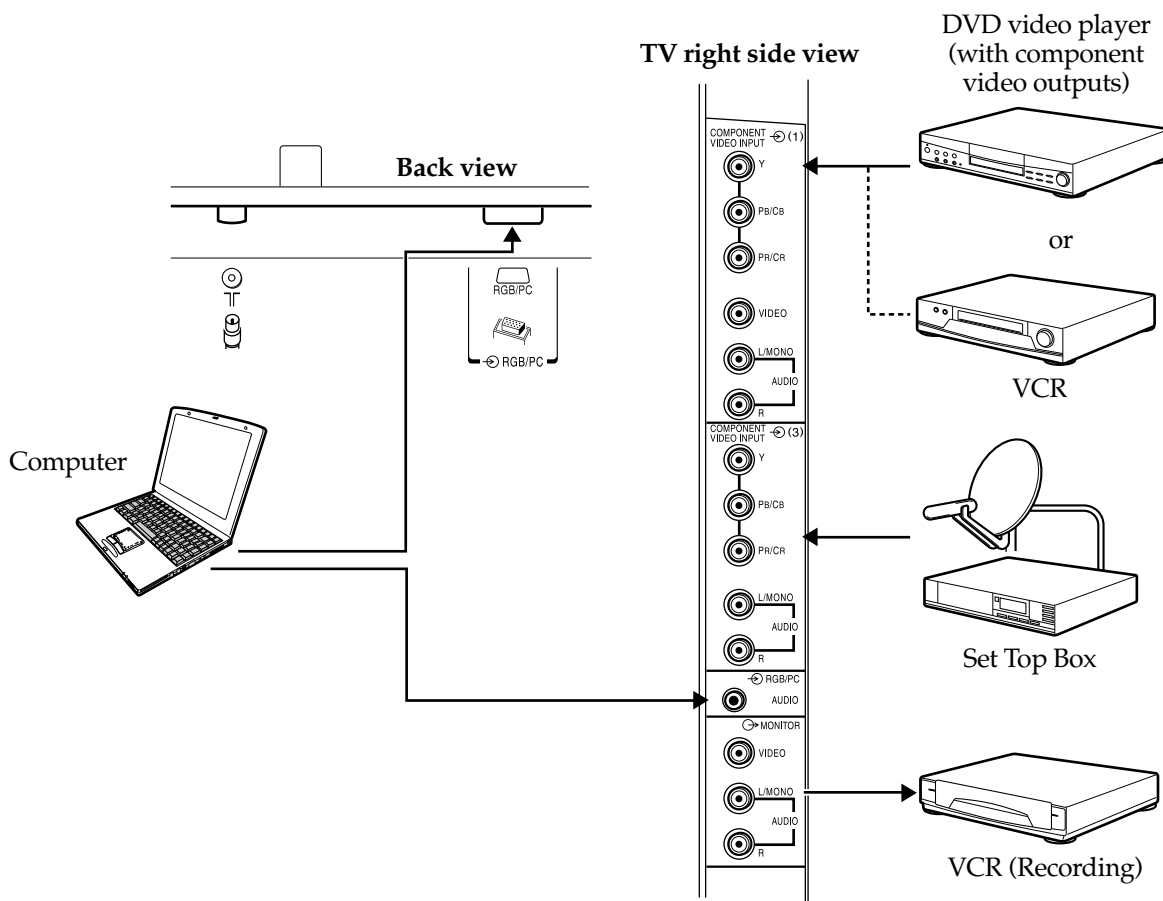

- Before connecting any external equipment, turn off all main power switches.
- Before connecting any external equipment, remove the back terminal covers (see page 11).
- The unauthorized recording of television programs, video tapes and other materials may infringe upon the provisions of copyright laws.
- The COMPONENT VIDEO INPUT consists of three component video jacks (Y, P_B/C_B, P_R/C_R) and provides the best picture performance. These jacks can only be used with the component video compatible equipment e.g. DVD video player etc.
- Connect either the COMPONENT VIDEO INPUT terminals or VIDEO input terminal (↻(1)), whichever terminal is used. Do not connect both of these terminals.
- Additional equipment and cables shown are not supplied with this TV.

Connecting a computer

- Before connecting PC and audio cables, remove the back terminal covers (see page 11).
- An analog RGB (15 pin) computer cable can be connected.

To connect a computer

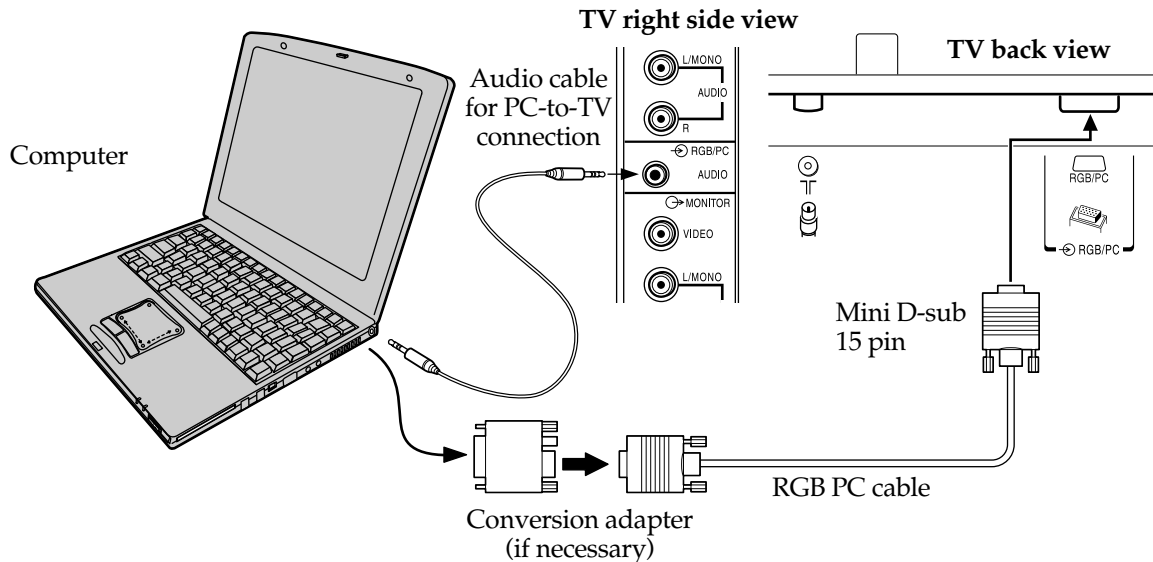

Connect a PC cable from the computer to the RGB/PC terminal on the back of the TV.

The following signals can be displayed:

- VGA: VESA 640 x 480 @ 60 Hz
- SVGA: VESA 800 x 600 @ 60 Hz
- XGA: VESA 1024 x 768 @ 60 Hz

However, these signal formats are converted to match the number of pixels of the LCD panel.

Therefore, the TV may not display small text properly.

Notes:

- Some PC models cannot be connected to this TV.
- There is no need to use an adapter for computers with DOS/V compatible mini D-sub 15 pin terminal.
- A bar may appear in the upper, lower, right or left side of the screen, or parts of the picture may be obscured depending on some signals. This is not the malfunction.
- If the edges of the picture are stretched, readjust the picture position adjustment in the PC Setting menu.
- Depending on the specification of the PC you are playing the DVD-Video on, and the DVD's title, some scenes may be skipped, or you may not be able to pause during multi-angle scenes.

Signal names for mini D-sub 15 pin connector



Pin assignment for RGB/PC terminal 	Pin No.	Signal name	Pin No.	Signal name
	1	R	9	NC
	2	G	10	Ground
	3	B	11	NC
	4	NC (not connected)	12	NC
	5	NC	13	H-sync
	6	Ground	14	V-sync
	7	Ground	15	NC
	8	Ground		

PC setting



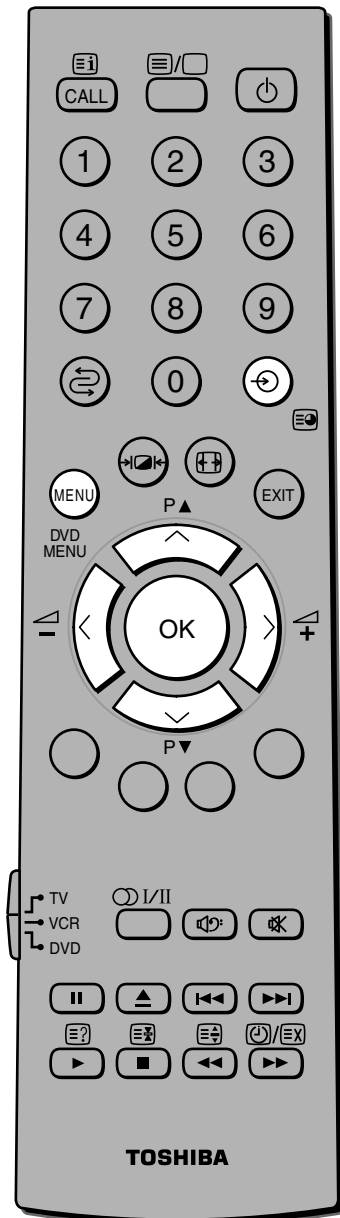





- In the PC input mode, you cannot select the Color, Tint, Black stretch, MPEG NR and DNR in the Picture setting menu and Cinema mode (see page 14).
- In the PC input mode, the Manual setting (see page 29) is not displayed.

To adjust a PC setting



First press and hold the  button until the video input mode list appears on the screen, then press the  or  and **OK** buttons in order to select the PC input mode (see page 29).

To adjust the Picture size/position:

- 1 Press the **MENU** button, then press the  or  button to display the SET UP menu.
- 2 Press the  or  button to select PC Setting.
- 3 Press the **OK** button to display the PC Setting menu.
- 4 Press the  or  button to select an option you want to adjust. (Picture size/position menu: Horizontal position, Horizontal width, Vertical position and Vertical height)
- 5 Press the  or  button to adjust the settings as required.

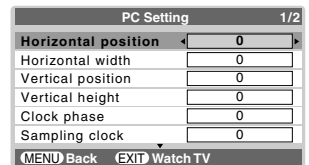

PC setting (continued)

- If the clock phase, which synchronize the PC signal and LCD display, is not optimized, the picture will blur. This function enables you to adjust clock phase and display a clear picture.
- If the sampling clock does not synchronize with the dot clock frequency of the PC, blurred picture detail will occur, or screen width will change, or drift patterns in vertical lines may be apparent. This function enables you to adjust it and optimize the picture.
- The Reset function adjusts the PC Setting (for all VGA, SVGA and XGA) to the factory settings.

To adjust a PC setting (continued)

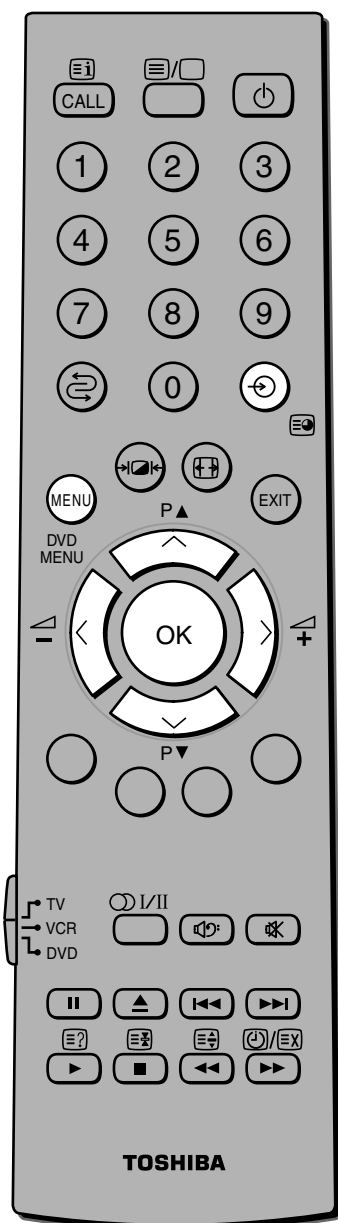

Note:

The optimum points of the clock phase and sampling clock adjustments may be incomprehensible according to the input signals.

First press and hold the button until the video input mode list appears on the screen, then press the \downarrow or \uparrow and **OK** buttons in order to select the PC input mode (see page 29).

To adjust the Clock phase of the picture:

- 1 Press the **MENU** button, then press the \leftarrow or \rightarrow button to display the SET UP menu. Press the \downarrow or \uparrow button to select PC Setting.



- 2 Press the **OK** button, then press the \downarrow or \uparrow button to select Clock phase.

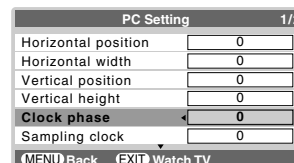

- 3 Press the \leftarrow or \rightarrow button to obtain a clear picture.



To adjust the Sampling clock:

- 1 From the PC Setting menu, press the \downarrow or \uparrow button to select Sampling clock.
- 2 Press the \leftarrow or \rightarrow button to optimize the picture.

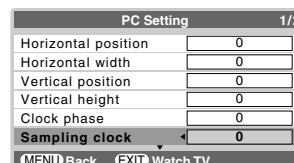

To reset the PC Setting:

- 1 From the PC Setting menu, press the \downarrow or \uparrow button to select Reset on the 2nd page.
- 2 Press the **OK** button.



Troubleshooting

- Before calling a service technician, please check the following table for a possible cause of the symptom and some solutions.

Symptom and solution

Symptom	Solution
TV will not turn on	<ul style="list-style-type: none"> • Make sure the power cord is plugged in, then press ⏻/I. • The remote control batteries may be dead. Replace the batteries.
No picture, no sound	<ul style="list-style-type: none"> • Check the antenna connections.
No sound, picture OK	<ul style="list-style-type: none"> • The sound may be muted. Press ⏮ +, ⏭ - or 🔊. • The station may have broadcast difficulties. Try another channel.
Poor sound, picture OK	<ul style="list-style-type: none"> • The station may have broadcast difficulties. Try another channel.
Poor picture, sound OK	<ul style="list-style-type: none"> • Check the antenna connections. • The station may have broadcast difficulties. Try another channel. • Adjust the PICTURE menu.
Poor reception of broadcast channels	<ul style="list-style-type: none"> • Check the antenna connections. • The station may have broadcast difficulties. Try another channel. • Make sure the Color system is properly set.
Teletext problems	<ul style="list-style-type: none"> • Check the antenna connections. <p>Good performance of text depends on a good strong broadcast signal.</p>
Multiple images	<ul style="list-style-type: none"> • The station may have broadcast difficulties. Try another channel. • Antenna reception may be poor. Use a high directional outdoor antenna. • Check if the direction of the antenna has changed.
Poor color or no color	<ul style="list-style-type: none"> • The station may have broadcast difficulties. Try another channel. • Adjust the Tint and/or Color in the PICTURE menu.
The remote control does not operate	<ul style="list-style-type: none"> • Remove all obstructions between the remote control and the remote control sensor in the TV. • The remote control batteries may be dead. Replace them with new ones. • Check that the TV/VCR/DVD switch on the remote control is properly set.
Some pixels of the screen do not light up	<ul style="list-style-type: none"> • The LCD display panel is manufactured using an extremely high level of precision technology, however, sometimes some pixels of the screen may be missing picture elements or have luminous spots. This is not a sign of a malfunction.
The brightness of the screen comes down, or flickers of the screen are caused, or some parts of the screen do not light up.	<ul style="list-style-type: none"> • When you just buy and start to use this TV, a flickering may be caused in the screen. In this case, switch off the TV, then switch on it again to cure the condition. • The cold cathode fluorescent lamp used for the back light on this TV has longevity. When the brightness of the screen comes down, or the flickers of the screen are caused, or some parts of the screen do not light up, it may reach the end of its life. Contact a service technician.
The picture brightness varies when you switch the TV on.	<ul style="list-style-type: none"> • If you switch the TV on at 0°C and under, wait until the display warms up.

Broadcast system, Specifications

Broadcast transmission systems of each country or region

Area	Country or Region	System	
		Color	Sound
Asia M. E.	Bahrain, Kuwait, Israel, Oman, Qatar, United Arab Emirates, Yemen, etc. Indonesia, Malaysia, Singapore, Thailand, etc.	PAL	B/G
	China	PAL	D/K
	China Hong Kong	PAL	I
	Iraq, Islamic Republic of Iran, Lebanon, Saudi Arabia, etc.	SECAM	B/G
	Russian Federation, etc.	SECAM	D/K
	Myanmar, etc.	NTSC	M
Oceania	Australia, New Zealand, etc.	PAL	B/G
Africa	Republic of South Africa, etc.	PAL	I
South America	Argentina, Paraguay, Uruguay, etc.	PAL	N
	Brazil	PAL	M
	Chile, Colombia, etc.	NTSC	M

Note:

PAL, SECAM and NTSC 3.58 (MHz) are different color signal broadcast transmission systems applicable to different countries or region. NTSC 4.43 (MHz) is used in special VCRs to playback NTSC recorded video tapes through PAL television equipment.

LCD color television

Model	42WL55A, 42WL55E, 42WL55T		
Power source	42WL55A	220V - 240V AC, 50 Hz	
	42WL55E	220V - 240V AC, 50/60 Hz	
	42WL55T	110V - 240V AC, 50/60 Hz	
Power consumption	240 W, 0.5 W (standby)		
Dimensions	1,044 mm (W)	757 mm (H)	352 mm (D)
Mass (Weight)	34.7 kg		
Television system (Antenna input)	Channel coverage:		
	PAL	B/G (CCIR)	VHF 2 - 12 UHF 21 - 69 CATV X - Z+2, S1 - S41
	PAL	I (UK)	VHF - UHF 21 - 69 CATV -
	PAL	D/K (CHINA)	VHF 1 - 12 UHF 13 - 57 CATV Z1 - Z38
	SECAM	B/G (CCIR)	VHF 2 - 12 UHF 21 - 69 CATV X - Z+2, S1 - S41
	SECAM	D/K (OIRT)	VHF 1 - 12 UHF 21 - 69 CATV X1 - X19
	NTSC	M (US)	VHF 2 - 13 UHF 14 - 69 CATV A6 - A1, A - W, AA - ZZ, AAA, BBB
	NTSC	M (JAPAN)	VHF 1 - 12 UHF 13 - 62 CATV M1 - M10, S1 - S41
	Special RF signal:		
	NTSC 4.43 color system	5.5/6.0/6.5 MHz sound system	
	PAL 60 Hz color system	5.5/6.0/6.5 MHz sound system	

LCD color television (continued)

COMPONENT VIDEO INPUT terminals (the signal format)	480i, 480p, 576i, 576p, 720p (50/60 Hz), 1080i (50/60 Hz) (These signal formats are converted to match the number of pixels of the LCD panel.)	
Color system	PAL, SECAM, NTSC 3.58/4.43	
Aspect ratio	16 : 9	
Visible size (diagonal)	106.7 cm	
Number of pixels	1366 (H) dots × 768 (V) dots	
Audio power	10 W + 10 W (10% THD)	
Speakers	Main: 60 × 120 mm 4pcs. Tweeter: 33 mm (round) 2pcs.	
Input/Output terminals	⊖ (1) Input ⊖ (2) Input ⊖ (3) Input ↪ MONITOR Output ⊖ RGB/PC Input ⊖ Audio Input Headphone jack	Component video Y, P _B /C _B , P _R /C _R or Phono jacks A/V Phono jacks A/V Component video Y, P _B /C _B , P _R /C _R Phono jacks Audio L/Mono +R Phono jacks A/V Mini D-sub 15 pin Analog RGB 3.5 mm stereo mini jack 3.5 mm (Diameter) stereo
Operating condition	Temperature Humidity	0°C - 35°C 20% - 80% (No moisture condensation)
Supplied accessories	Owner's manual (1), Remote control (1), Batteries (2), Clip (1)	



This is used to fix the TV to a wall, pillar, etc. (see page 4).

- Design and specifications are subject to change without notice.
- Never service or remodel the TV by yourself. It may expose you to a fire hazard or dangerous voltages.

TOSHIBA CORPORATION

Free Manuals Download Website

<http://myh66.com>

<http://usermanuals.us>

<http://www.somanuals.com>

<http://www.4manuals.cc>

<http://www.manual-lib.com>

<http://www.404manual.com>

<http://www.luxmanual.com>

<http://aubethermostatmanual.com>

Golf course search by state

<http://golfingnear.com>

Email search by domain

<http://emailbydomain.com>

Auto manuals search

<http://auto.somanuals.com>

TV manuals search

<http://tv.somanuals.com>