

TOSHIBA

OWNER'S MANUAL

Video Monitor

CM1310A
CM1910A

Owner's Record

The model number and serial number are on the back of your monitor. Record these numbers in the spaces below. Refer to these numbers whenever you communicate with your Toshiba dealer about this monitor.

Model number:

Serial number:

Important Information

WARNING:

TO REDUCE THE RISK OF FIRE OR ELECTRIC SHOCK, DO NOT EXPOSE THIS APPLIANCE TO RAIN OR MOISTURE.

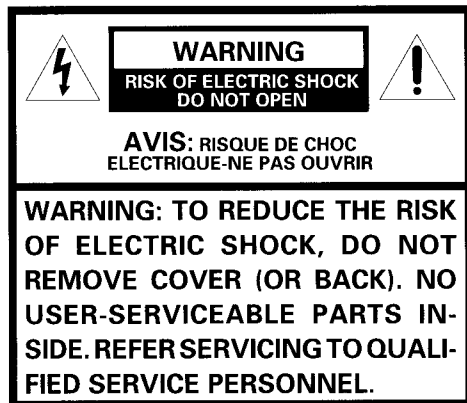

The lightning symbol in the triangle tells you that the voltage inside this product may be strong enough to cause an electric shock. **DO NOT TRY TO SERVICE THIS PRODUCT YOURSELF.**



The exclamation point in the triangle tells you that important operating and maintenance instructions follow this symbol.

CAUTION:

TO PREVENT ELECTRIC SHOCK, DO NOT USE THIS POLARIZED PLUG WITH AN EXTENSION CORD RECEPTACLE OR OTHER OUTLET UNLESS THE PRONGS CAN BE FULLY INSERTED INTO THE OUTLET TO PREVENT ANY EXPOSURE OF THE PRONGS ON THE POLARIZED PLUG.

FCC NOTICE

This equipment has been tested and found to comply with the limits for a Class A digital device, pursuant to Part 15 of the FCC Rules.

These limits are designed to provide reasonable protection against harmful interference when the equipment is operated in a commercial environment. This equipment generates, uses, and can radiate radio frequency energy and, if not installed and used in accordance with the instruction manual, may cause harmful interference to radio communications. Operation of this equipment in a residential area is likely to cause harmful interference in which case the user will be required to correct the interference at his own expense.

NOTE TO CATV SYSTEM INSTALLERS IN THE USA:

This reminder is provided to call the CATV system installer's attention to Article 820-22 of the N.E.C., that provides guidelines for proper grounding and, in particular, specifies that the cable ground shall be connected to the grounding system of the building, as close to the point of cable entry as practical.

Table of Contents

Installing Your Video Monitor	3
Location of Controls	4
Basic Operation	5
Adjusting the Picture	6
Changing the On-Screen Display Language	7
Maintenance and Care	8
Specifications	8
Limited Warranty	9
Troubleshooting	Back cover

Installing Your Video Monitor

Where to install

Place the monitor on the floor or on a sturdy platform. The mounting surface should be flat and steady.

Lighting

Do not place the monitor in a room where direct lighting strikes the screen. Use soft and indirect lighting.

Air circulation

Place the monitor far enough from the walls to allow proper ventilation. This will prevent the monitor from overheating and avoid possible damage to the monitor. Avoid dusty places too.

Power supply

Plug into an electrical outlet with standard household power (120 volt AC, 60Hz). As a safety feature, the plug has one prong wider than the other. It will fit only one way into a standard electrical outlet. If the plug will not fit into the outlet, try turning it around. If the plug will not fit either way, the outlet is probably old and non-standard. You will need to have a new outlet installed by an electrician.

DO NOT CHANGE THE SAFETY FEATURE OF THE PLUG.

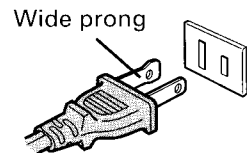

Location of Controls

For the use of each control, see the pages in brackets.

Front view

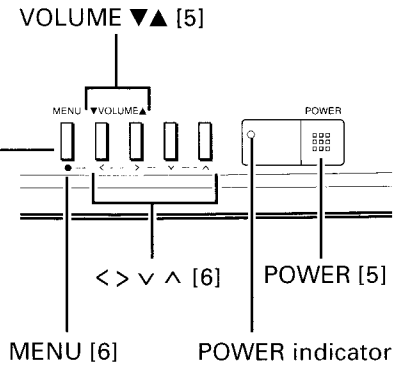
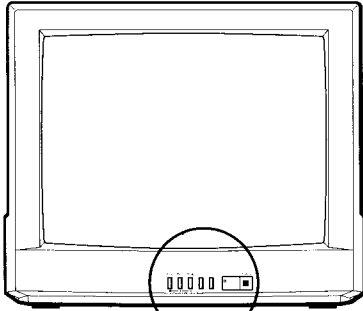

Rear view

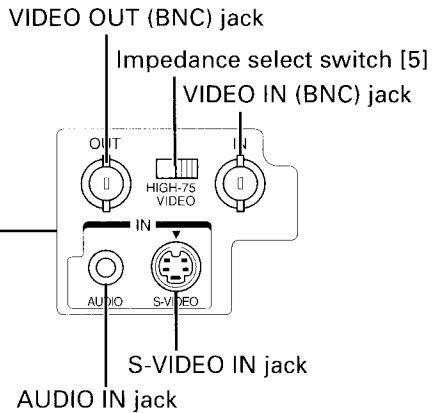
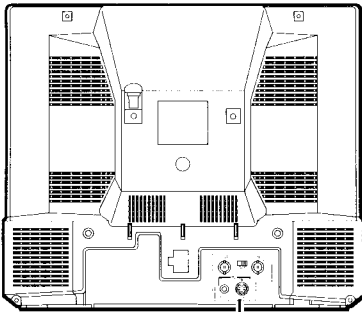

Basic Operation

Setting the impedance select switch

When the VIDEO OUT jack is used to connect another video monitor, set the impedance select switch to HIGH (left) position.

When the VIDEO OUT jack is not used, set the switch to 75Ω (right) position.



HIGH-75
VIDEO

Turning the video monitor on

Press the POWER button to turn the video monitor on.

To turn the video monitor off, press the button again.

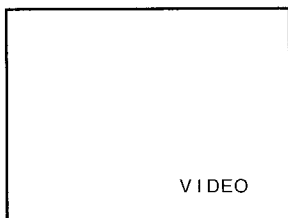
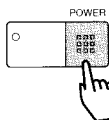

Adjusting the volume

To increase the volume, press the VOLUME ▲ button. To decrease the volume, press the VOLUME ▼ button. Press and hold either button until your desired volume level is obtained.

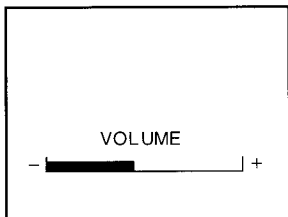
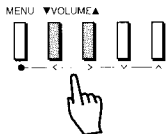

Note: The VOLUME ▼▲ buttons will operate as the menu <> buttons while the menu display is on the screen.

Adjusting the Picture

You can adjust the picture quality to your personal preference, including the contrast, brightness, sharpness, color and tint.

To adjust the picture quality

1. Press **MENU** until the Picture menu appears.

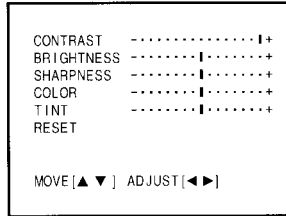
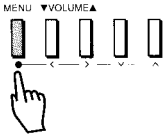

2. Press ∇ or \blacktriangle until the item you want to adjust is displayed in purple.
3. Press \blacktriangleleft or \blacktriangleright to adjust the level.

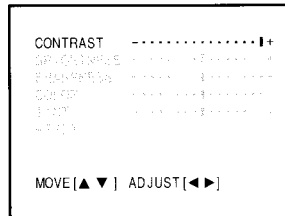
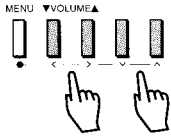

Selection	< Pressing >	
contrast	lower	higher
brightness	darker	lighter
sharpness	softer	sharper
color	paler	deeper
tint	reddish	greenish

To reset your adjustments to the factory settings.

1. Press **MENU** until the Picture menu appears.
2. Press ∇ or \blacktriangle until **RESET** is displayed in purple.
3. Press \blacktriangleleft or \blacktriangleright .

Changing the On-Screen Display Language

You can choose from three different languages (English, French and Spanish) for the on-screen displays.

To select a language:

1. Press MENU until the Language menu appears.

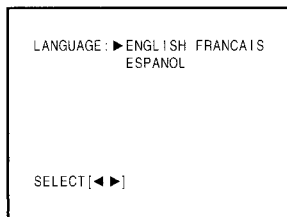
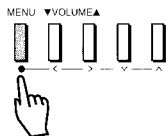

2. Press < or > until your desired language is displayed in purple. If you select FRANCAIS, the display language change to French.

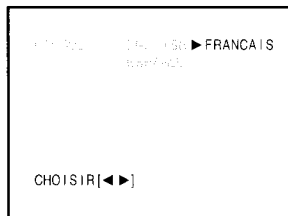
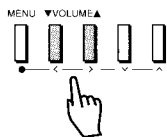

Maintenance and Care

WARNING: Video Monitor use High Voltages. Do not try to remove the cabinet back. Refer servicing to qualified service personnel.

- To clean the monitor screen:
 1. First remove the plug from the power outlet.
 2. Use a clean cellulose sponge or chamois cloth dampened with a solution of mild detergent and warm water to clean monitor screen and trim. Do not use too much water on the monitor screen.
 3. Remove any extra moisture with the same cloth or a dry one.
- To maintain the finish and appearance of the cabinet, polish it from time to time with a quality furniture polish.

Specifications

Power Source	120 V AC, 60Hz
Power Consumption	CM1310A: 40 W (average) CM1910A: 52 W (average)
Audio Power	1 W
Video/Audio Terminals	S-VIDEO INPUT Y-INPUT: 1Vp-p, 75 ohm, negative sync. C-INPUT: 0.286Vp-p (burst signal), 75 ohm AUDIO INPUT (phono jack) 150mVrms, 47k ohm or more VIDEO INPUT/OUTPUT (BNC jack) 1Vp-p, 75 ohm/HIGH, negative sync.
Horizontal Resolution	450
Dimensions	CM1310A Width 15-1/8 inches (384 mm) Height 13-21/32 inches (347 mm) Depth 14-29/64 inches (367 mm) CM1910A Width 20-15/32 inches (520mm) Height 17-13/32 inches (441 mm) Depth 18-25/64 inches (467 mm)
Mass	CM1310A: 20.9 lbs (9.5 kg) CM1910A: 36.4 lbs (16.5 kg)

Design and specifications are subject to change without notice.

Limited Warranty

The Imaging Systems Division of Toshiba America Information Systems, Inc. ("ISD") makes the following limited warranties with regard to this Color Monitor ("Product"). These limited warranties extend to the Original End-User ("You[r]").

One (1) Year Limited Warranty of Labor and Parts ISD warrants that this Product will perform in accordance with specifications for a period of one (1) year from the date of purchase by the Original End-User. During this one (1) year period, ISD will repair or replace the Product, if it does not perform as warranted. In order to take advantage of this Limited Warranty, You must: (a) deliver the Product to an ISD Authorized Service Provider ("ASP"); and (b) pay all transportation and insurance charges for shipment of the Product to the ASP. ISD reserves the right to substitute factory refurbished parts in place of those in need of repair.

Instruction Manual (Owner's Manual): You should read the Instruction Manual (Owner's Manual) thoroughly before operating this Product. Before seeking warranty service, you should check the troubleshooting guide in the Instruction Manual (Owner's Manual) and follow the instructions to correct the problem.

Your Responsibilities: This Limited Warranty is subject to the following conditions:

1. You must provide the bill of sale or proof of purchase at the time that warranty service is required.
2. You must notify an ASP within thirty (30) days after You discover that the Product does not perform in accordance with specifications during the Limited Warranty period.
3. All warranty servicing of this product must be made by an ISD Authorized Service Provider.
4. You must pack the Product in its original carton using the original packing material, then insert the original carton containing the Product into another carton with additional packing material before shipping the Product to an ASP.

DISCLAIMERS:

ALL OTHER EXPRESS OR IMPLIED WARRANTIES ON THIS PRODUCT, INCLUDING THE IMPLIED WARRANTIES OF MERCHANTABILITY AND FITNESS FOR A PARTICULAR PURPOSE, ARE HEREBY DISCLAIMED. SOME STATES DO NOT ALLOW THE EXCLUSION OF IMPLIED WARRANTIES OR LIMITATIONS ON HOW LONG AN IMPLIED WARRANTY LASTS, SO THE ABOVE LIMITATIONS MAY NOT APPLY TO YOU.

IF THIS PRODUCT IS NOT IN GOOD WORKING ORDER AS WARRANTED ABOVE, YOUR SOLE AND EXCLUSIVE REMEDY SHALL BE THE REPAIR OR REPLACEMENT OF THE PRODUCT. IN NO EVENT WILL ISD OR ITS PARENT COMPANY OR ANY ASP BE LIABLE TO YOU OR ANY THIRD PARTY FOR ANY DAMAGES IN EXCESS OF THE PURCHASE PRICE OF THE PRODUCT. THIS LIMITATION APPLIES TO DAMAGES OF ANY KIND, INCLUDING ANY DIRECT OR INDIRECT DAMAGES, LOST PROFITS, LOST SAVINGS OR OTHER SPECIAL, INCIDENTAL, EXEMPLARY OR CONSEQUENTIAL DAMAGES, WHETHER FOR BREACH OF CONTRACT, TORT OR OTHERWISE, OR WHETHER ARISING OUT OF THE USE OF OR INABILITY TO USE SUCH PRODUCT, EVEN IF TAIS, ITS PARENT COMPANY, OR AN ASP HAS BEEN ADVISED OF THE POSSIBILITY OF SUCH DAMAGES OR OF ANY CLAIM BY ANY OTHER PARTY. SOME STATES DO NOT ALLOW THE EXCLUSION OR LIMITATION OF INCIDENTAL OR CONSEQUENTIAL DAMAGES FOR SOME PRODUCTS, SO THE ABOVE LIMITATIONS OR EXCLUSIONS MAY NOT APPLY TO YOU.

THIS WARRANTY GIVES YOU SPECIFIC LEGAL RIGHTS, AND YOU MAY ALSO HAVE OTHER RIGHTS WHICH MAY VARY FROM STATE TO STATE.

THIS LIMITED WARRANTY SHALL BE VOID IF THE PRODUCT OR PARTS HAVE BEEN SUBJECTED TO MISUSE, ABUSE, ACCIDENT, IMPROPER INSTALLATION, IMPROPER MAINTENANCE, OR USE IN VIOLATION OF ISD'S WRITTEN INSTRUCTIONS, OR WHERE THE PRODUCT HAS BEEN ALTERED OR MODIFIED WITHOUT ISD'S PRIOR AUTHORIZATION, OR UPON THE REMOVAL OR ALTERATION OF ISD'S FACTORY SERIAL NUMBER. LABOR SERVICE CHARGES FOR PRODUCT INSTALLATION, SET UP AND ADJUSTMENT OF CONTROLS ARE NOT COVERED BY THIS LIMITED WARRANTY.

How to Obtain Warranty Service – Step-By-Step Procedures: To obtain warranty service, You should:

1. Contact an ASP for warranty service within thirty (30) days after the Product fails to comply with specifications.
2. Arrange for shipment of the Product to an ASP.
3. Securely pack the Product as described above, insure the carton, and include a letter explaining the problem and a copy of the bill of sale or proof of purchase.
4. Prepay all transportation and insurance costs.

Questions? If you have any questions, please check ISD's website or send an e-mail as follows:

Website: <http://www.toshiba.com/taisid/security/>

E-mail: CCTVtech.support@tais.toshiba.com

No person, agent, distributor, dealer, authorized service provider, or company is authorized to change, modify, or extend the terms of this Limited Warranty in any manner whatsoever. The time within which an action must be commenced to enforce any obligation of ISD arising under this Limited Warranty or under any statute, or law of the United States or any state thereof, is hereby limited to one (1) year from the date You discover or should have discovered the problem. This limitation does not apply to implied warranties arising under state law. Some states do not permit limitation of the time within which You may bring an action beyond the limits provided by state law, so the above provision may not apply to You. This Limited Warranty gives You specific legal rights and You may also have other rights which vary from state to state.

Troubleshooting

Before calling a service technician, please check the following table for a possible cause of the problem and some solution.

Problem	Solution
Monitor will not turn on	<ul style="list-style-type: none">● Make sure the power cord is plugged in, then press POWER button.
No picture, no sound	<ul style="list-style-type: none">● Check cable connections.
No sound, picture OK	<ul style="list-style-type: none">● Try pressing VOLUME ▲ button.
Poor picture, sound OK	<ul style="list-style-type: none">● Check cable connections.● Check if the impedance select switch is properly set.● Adjust Picture menu.
Poor color or no color	<ul style="list-style-type: none">● Adjust TINT and /or COLOR in the Picture menu.● If you change the direction of the monitor while the monitor is activated, the picture may suffer from color shading. If so, turn off the monitor and allow for about 30 minutes to cool, then turn on the monitor again. The picture should improve.

TOSHIBA AMERICA INFORMATION SYSTEMS, INC.
9740 IRVINE BLVD., IRVINE, CA 92618-1697
TEL: (949) 583-3000

MANUFACTURED BY
P.T. TOSHIBA CONSUMER PRODUCTS INDONESIA.

Printed in Indonesia
(99-07)

TOSHIBA

Free Manuals Download Website

<http://myh66.com>

<http://usermanuals.us>

<http://www.somanuals.com>

<http://www.4manuals.cc>

<http://www.manual-lib.com>

<http://www.404manual.com>

<http://www.luxmanual.com>

<http://aubethermostatmanual.com>

Golf course search by state

<http://golfingnear.com>

Email search by domain

<http://emailbydomain.com>

Auto manuals search

<http://auto.somanuals.com>

TV manuals search

<http://tv.somanuals.com>