

# TOSHIBA

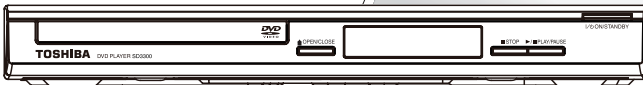

# DVD PLAYER SD3300KU

## OWNER'S MANUAL



### Owner's Record



The model number and serial number are on the back of your DVD Player. Record these numbers in the spaces below. Refer to these numbers whenever you communicate with your Toshiba dealer about this DVD Player.

Model number:

Serial number:

# Introduction

## SAFETY PRECAUTIONS

	<b>CAUTION</b> RISK OF ELECTRIC SHOCK DO NOT OPEN	
<b>CAUTION: VISIBLE LASER RADIATION WHEN OPEN. DO NOT STARE INTO BEAM.</b>		
<b>AVIS</b>	RISQUE DE CHOC ELECTRIQUE NE PAS OUVRIR	
<b>WARNING: TO REDUCE THE RISK OF ELECTRIC SHOCK, DO NOT REMOVE COVER (OR BACK). NO USER-SERVICEABLE PARTS INSIDE. REFER SERVICING TO QUALIFIED SERVICE PERSONNEL.</b>		



The lightning flash with arrowhead symbol, within an equilateral triangle, is intended to alert the user to the presence of uninsulated 'dangerous voltage' within the product's enclosure that may be of sufficient magnitude to constitute a risk of electric shock to persons.



The exclamation point within an equilateral triangle is intended to alert the user to the presence of important operating and maintenance (servicing) instructions in the literature accompanying the appliance.



The symbol for CLASS II (Double Insulation)



ENERGY STAR® qualified DVD. Products that earn the ENERGY STAR prevent green house gas emissions by meeting strict energy efficiency guidelines set by the U.S. Environmental Protection Agency and the U.S. Department of Energy. ENERGY STAR and the ENERGY STAR mark are registered U.S. marks.

### WARNING:

TO REDUCE THE RISK OF FIRE OR ELECTRIC SHOCK, DO NOT EXPOSE THIS APPLIANCE TO RAIN OR MOISTURE. DANGEROUS HIGH VOLTAGES ARE PRESENT INSIDE THE ENCLOSURE. DO NOT OPEN THE CABINET. REFER SERVICING TO QUALIFIED PERSONNEL ONLY.

### CAUTION:

TO PREVENT ELECTRIC SHOCK, MATCH WIDE BLADE OF PLUG TO WIDE SLOT, FULLY INSERT.

### ATTENTION:

POUR EVITER LES CHOCES ELECTRIQUES, INTRODUIRE LA LAME LA PLUS LARGE DE LA FICHE DANS LA BORNE CORRESPONDANTE DE LA PRISE ET POUSSER JUSQU' AU FOND.

### CAUTION:

PLEASE READ AND OBSERVE ALL WARNINGS AND INSTRUCTIONS GIVEN IN THIS OWNER'S MANUAL AND THOSE MARKED ON THE UNIT. RETAIN THIS BOOKLET FOR FUTURE REFERENCE.

### CAUTION:

USE OF ANY CONTROLS, ADJUSTMENTS, OR PROCEDURES OTHER THAN THOSE SPECIFIED HEREIN MAY RESULT IN HAZARDOUS RADIATION EXPOSURE.

### FCC NOTICE:

**This equipment has been tested and found to comply with the limits for a Class B digital device, pursuant to part 15 of the FCC Rule.**

These limits are designed to provide reasonable protection against harmful interference in a residential installation. This equipment generates, uses, and can radiate radio frequency energy and, if not installed and used in accordance with the instructions, may cause harmful interference to radio communications.

However, there is no guarantee that interference will not occur in a particular installation.

If this equipment does cause harmful interference to radio or television reception, which can be determined by turning the equipment off and on, the user is encouraged to try to correct the interference by one or more of the following measures:

- Reorient or relocate the receiving antenna.
- Increase the separation between the equipment and receiver.
- Connect the equipment into an outlet on a circuit different from that to which the receiver is connected.
- Consult the dealer or an experienced radio/TV technician for help.

**Changes or modifications made to this equipment, not expressly approved by Toshiba, or parties authorized by Toshiba, could void the user's authority to operate the equipment.**

## IMPORTANT SAFETY INSTRUCTIONS

1. Read these instructions.
2. Keep these instructions.
3. Heed all warnings.
4. Follow all instructions.
5. Do not use this apparatus near water.
6. Clean only with dry cloth.
7. Do not block any ventilation openings. Install in accordance with the manufacturer's instructions.
8. Do not install near any heat sources such as radiators, heat registers, stoves, or other apparatus (including amplifiers) that produce heat.

9. Do not defeat the safety purpose of the polarized or grounding-type plug. A polarized plug has two blades with one wider than the other. A grounding type plug has two blades and a third grounding prong. The wide blade or the third prong are provided for your safety. If the provided plug does not fit into your outlet, consult an electrician for replacement of the obsolete outlet.
10. Protect the power cord from being walked on or pinched particularly at plugs, convenience receptacles, and the point where they exit from the apparatus.
11. Only use attachments/accessories specified by the manufacturer.
12. Use only with the cart, stand, tripod, bracket, or table specified by the manufacturer, or sold with the apparatus. When a cart is used, use caution when moving the cart/apparatus combination to avoid injury from tip-over.
13. Unplug this apparatus during lightning storms or when unused for long periods of time.
14. Refer all servicing to qualified service personnel. Servicing is required when the apparatus has been damaged in any way, such as power-supply cord or plug is damaged, liquid has been spilled or objects have fallen into the apparatus, the apparatus has been exposed to rain or moisture, does not operate normally, or has been dropped.



#### Additional Safety Instructions

15. Do not overload wall outlets; extension cords, or integral convenience receptacles as this can result in a risk of fire or electric shock.
16. Apparatus shall not be exposed to dripping or splashing and no objects filled with liquids, such as vases, shall be placed on the apparatus.
17. Keep your fingers well clear of the disc tray as it is closing. Neglecting to do so may cause serious personal injury.
18. Do not place a heavy object on or step on the apparatus. The object may fall, causing serious personal injury and serious damage to the apparatus.
19. Do not use a cracked, deformed, or repaired disc. These discs are easily broken and may cause serious personal injury and apparatus malfunction.
20. If the apparatus should smoke or smell, immediately disconnect the power cord from the wall outlet. Wait until the smoke or smell stops, then ask your dealer for a check and repair. Neglecting to do so may cause fire.
21. While it is thundering, do not touch the connecting cables or the apparatus.
22. Warning: To prevent the spread of fire, keep candles or other open flames away from this product at all times.

#### CAUTION:

This Digital Video Disc Player employs a Laser System.

To ensure proper use of this product, please read this owner's manual carefully and retain for future reference. Should the unit require maintenance, contact an authorized service location.

Use of controls or adjustments or performance of procedures other than those specified herein may result in hazardous radiation exposure.

To prevent direct exposure to laser beam, do not try to open the enclosure.

Visible and invisible laser radiation when open and interlocks defeated.

#### DO NOT STARE INTO BEAM.

Location of the required label:

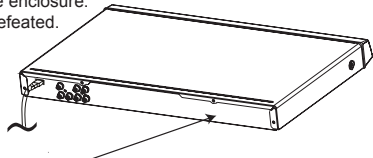

**CERTIFICATION:** This product complies with FDA Rule 21 CFR Subchapter J in effect at date of manufacture.

**CAUTION:** These servicing instructions are for use by qualified service personnel only. To reduce the risk of electric shock do not perform any servicing other than that contained in the operating instructions unless you are qualified to do so.

Be aware that this equipment is still powered when in standby mode. To disconnect this equipment completely from the mains power, pull out the power plug from the wall outlet.

The mains plug is used as the disconnect device, the disconnect device shall remain readily operable.

#### Environmental Information

All unnecessary packaging has been omitted. The packaging has been made easy to separate into three materials; cardboard (box), polystyrene foam (buffer) and polyethylene (bags, protective foam sheet).

Your DVD player consists of materials which can be recycled and reused if disassembled by a specialised company. Please observe the local regulations regarding the disposal of packaging materials, exhausted batteries and old equipment.

<b>LASER</b>	
Type	Semiconductor laser
	InGaAlP(DVD)
	AlGaAs(CD)
Wave length	657 nm(DVD)
	790 nm(CD)
Output Power	5.5 mW(DVD)
	7.0 mW(VCD/CD)
Beam divergence	60 degrees

# Introduction



**WARNING:**  
**RISK OF ELECTRIC SHOCK!**



Never attempt to service this product yourself. Opening and removing the covers may expose you to dangerous voltage or other hazards. Failure to follow this WARNING may result in death or serious injury. Refer all servicing not specified in this manual to a Toshiba Authorized Service Center.

## Setup

### Finding a suitable location

- Place the set on a flat, hard and stable surface.
- Do not place the set on a carpet.
- Do not position the set on top of other equipment that might heat it up (e.g., receiver or amplifier).
- Do not put anything under the set (e.g.CDs, magazines).
- Install this unit near the AC outlet and where the AC power plug can be reached easily.

### Space for ventilation

-Place the apparatus in a location with adequate ventilation to prevent internal heat build up. Allow at least 10 cm (4.0") clearance from the rear and the top of the set and 5 cm (2.0") from the left and right to prevent overheating.

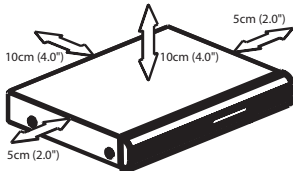

### Avoid high temperatures, moisture, water and dust

- Apparatus shall not be exposed to dripping or splashing.
- Do not place any sources of danger on the apparatus (e.g., liquid filled objects, lighted candles).

## Cleaning discs

Some problems occur because the disc inside the system is dirty (frozen picture, sound disruptions, picture distortions). To avoid these problems, discs should be cleaned on a regular basis.

To clean a disc, use a micro fibre cleaning cloth and wipe the disc from the center to the edge in a straight line. Do not touch the playback side of the disc.

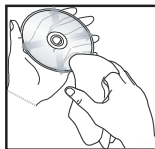
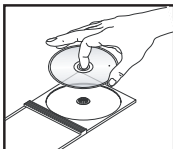

### CAUTION!

Do not use solvents such as benzene, thinner, commercially available cleaners, or anti-static sprays intended for analog discs. Since the optical unit (laser) of the DVD system operates at a higher power than regular DVD or CD players, cleaning CDs intended for DVD or CD players may damage the optical unit (laser). Therefore, refrain from using a cleaning CD.

## Moisture Condensation

Moisture condensation damages the DVD player. Please read the following carefully. Moisture condensation occurs, for example, when you pour a cold drink into a glass on a warm day. Drops of water form on the outside of the glass. In the same way, moisture may condense on the optical pick-up lens inside this unit, one of the most crucial internal parts of the DVD player.

If you use the DVD player in such a situation, it may damage discs and internal parts. Remove the disc, connect the power cord of the DVD player to the wall outlet, turn on the DVD player, and leave it for two or three hours. After two or three hours, the DVD player will have warmed up and evaporated any moisture. Keep the DVD player connected to the wall outlet and moisture condensation will seldom occur.













## Region Codes

This DVD player is designed to support the Region Management System. Check the regional code number on the disc package. If the number does not match the player's region number (see table on page 4), the player may be unable to playback the disc.

### Tips:

-It may not be possible to play CD-R/RW, DVD±R/RW, or DVD±R DL in all cases due to the type of disc or condition of the recording.

-If you are having trouble playing a certain disc, remove the disc and try a different one. Improperly formatted disc will not play on this DVD Player.

Region	Discs that can be played	
U.S.A. and Canada regions		
U.K., Europe regions and Japan		
Asia Pacific, Taiwan, Korea		
Australia, New Zealand, Latin America		
Russia and India regions		
China, Calcos Islands, Walls and Futuna Islands		

Manufactured under license from Dolby Laboratories. Dolby and the double-D symbol are trademarks of Dolby Laboratories.

Manufactured under license under U.S. Patent #: 5,451,942 & other U.S. and worldwide patents issued & pending. DTS and the Symbol are registered trademarks and DTS Digital Out and the DTS logos are trademarks of DTS, Inc. Product includes software. © DTS, Inc. All Rights Reserved.

This product incorporates copyright protection technology that is protected by method claims of certain U.S. patents and other intellectual property rights owned by Macrovision Corporation and other rights owners. Use of this copyright protection technology must be authorized by Macrovision Corporation, and is intended for home and other limited viewing uses only unless otherwise authorized by Macrovision Corporation. Reverse engineering or disassembly is prohibited.

**Notes on copyright**

The unauthorized recording, use, distribution, or revision of television programs, videotapes, DVDs and other materials, is prohibited under the Copyright Laws of the United States and other countries, and may subject you to civil and/or criminal liability.

# Introduction

## Table of Contents

<b>Introduction</b>	
SAFETY PRECAUTIONS	1
IMPORTANT SAFETY INSTRUCTIONS	1-2
Setup	3
Cleaning discs	3
Moisture Condensation	3
Region Codes	3-4
Table of Contents	5
<b>Connections</b>	
Connecting to television	6
Connecting to a Stereo System	7
Connecting to a Digital AV Receiver	7
Connecting the power cord	8
<b>Product Overview</b>	
Front and Rear panels	9
Remote Control	10
<b>Getting Started</b>	
Inserting Batteries	11
Finding your viewing channel	11
Setting up Progressive Scan feature	11-12
Setting the language	12
<b>Playback from Disc</b>	
Playable discs	12-13
<b>Playback Feature</b>	
Starting disc playback	13
Basic playback control	13-14
Operations for video playback (DVD/VCD/SVCD)	14
Selecting various repeat functions	14-15
Viewing the disc playback Information	15
Special DVD Features	15
Special VCD and SVCD Features	15
Playing JPEG/Kodak picture CD	16-17
<b>DVD Menu Options</b>	
Using the Language setup menu	17
Using the Video setup menu	17-18
Using the Audio setup menu	18-19
Using the Rating setup menu	19-20
Using the Misc (Miscellaneous) setup menu	20
Tray Lock	20
<b>Others</b>	
Specifications	21
Troubleshooting	22-23
Glossary	24
Limited United States Warranty	25
Canadian Warranty Information	26-27

## Connecting to television

### IMPORTANT!

– You only need to make one video connection from the following options, depending on the capabilities of your television.

– Connect the DVD player directly to the television.

### Using Composite Video Jack(CVBS)

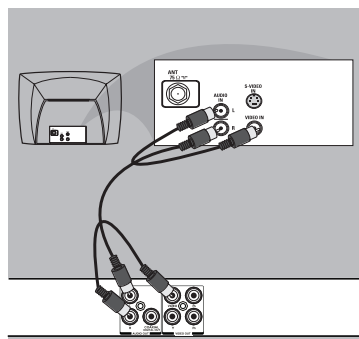

- 1 Use the composite video cable (yellow) to connect the DVD player's VIDEO (CVBS) jack to the video input jack (or labeled as A/V in, Video In or Composite) on the TV (cable supplied).  
To hear the sound of this DVD player through your TV, use the audio cables (white/red) to connect AUDIO OUT (L/R) jacks of the DVD player to corresponding AUDIO IN jacks on the TV (cable supplied).

### Using Component Video Jacks(Y, P<sub>B</sub>, P<sub>R</sub>)

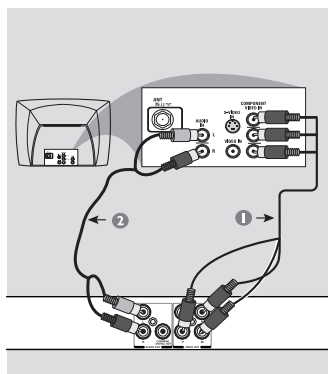

### IMPORTANT!

–The progressive scan video quality is only possible when using Y, P<sub>B</sub>, P<sub>R</sub> and a progressive scan TV is required.

- 1 Use the component video cables (red/blue/green) to

**Helpful hint:** Before making or changing any connections, make sure that all the devices are disconnected from the power outlet.

connect the DVD player's Y, P<sub>B</sub>, P<sub>R</sub> jacks to the corresponding Component video input jacks (or labeled as Y, P<sub>B</sub>, P<sub>R</sub>) on the TV (cable not supplied).

- 2 Use the audio cables (white/red) to connect AUDIO OUT (L/R) jacks of the DVD player to the corresponding AUDIO IN jacks on the TV (cable not supplied).
- 3 Proceed to page 11 for detailed Progressive Scan set up.

### Using a RF modulator

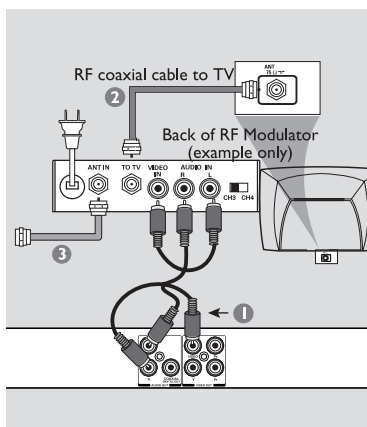

### IMPORTANT!

–If your TV only has a single Antenna In jack (or labeled as 75 ohm or RF In), you will need an RF modulator in order to view the DVD playback on the TV.

- 1 Use the composite video cable (yellow) to connect the DVD player's VIDEO (CVBS) jack to the video input jack on the RF modulator (cable supplied).  
To hear the sound of this DVD player through your TV, use the audio cables (white/red) to connect AUDIO OUT (L/R) jacks of the DVD player to the corresponding AUDIO IN jacks on the RF modulator (cable supplied).
- 2 Use the RF coaxial cable (not supplied) to connect ANTENNA OUT or TO TV jack on the RF modulator to the ANTENNA IN jack on the television.
- 3 Connect the Antenna or Cable TV service signal to the ANTENNA IN or RF IN jack on the RF modulator. (It may have been connected to your TV previously. Disconnect it from the TV.)

# Connections

## Connecting to a Stereo System

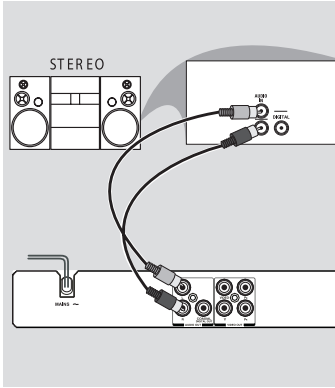

### Stereo System with Left/Right Audio In Jacks

- 1 Select one of the video connections (CVBS VIDEO IN or COMPONENT VIDEO IN) depending on the options available on your TV.
- 2 Use the audio cables (white/red) to connect AUDIO OUT (L/R) jacks of the DVD Player to the corresponding AUDIO IN jacks on the stereo system.

## Connecting to a Digital AV Receiver

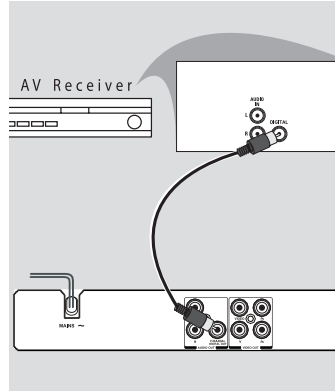

### Receiver has a PCM, Dolby Digital or MPEG decoder

- 1 Select one of the video connections (CVBS VIDEO IN or COMPONENT VIDEO IN) depending on the options available on your TV.
- 2 Connect the COAXIAL jack of the DVD player to the corresponding Digital Audio In jack on your Receiver (cable not supplied).
- 3 Set the DVD Player's Digital Output to PCM or All depending on the capabilities of your Receiver (see page 19 {Digital Output}).

#### Tip:

-If the audio format of the Digital Output does not match the capabilities of your receiver, the receiver will produce a strong, distorted sound or no sound at all.

**Helpful hint:** Before making or changing any connections, make sure that all the devices are disconnected from the power outlet.



---

---

## Connecting the power cord

---

---

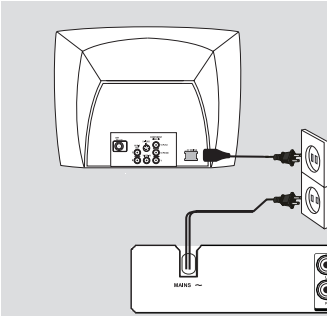

After everything is connected properly, plug in the AC power cord to the power outlet.  
Never make or change any connections with the power switched on.

**Helpful hint:** Before making or changing any connections, make sure that all the devices are disconnected from the power outlet.

# Product Overview

## Front and Rear panels

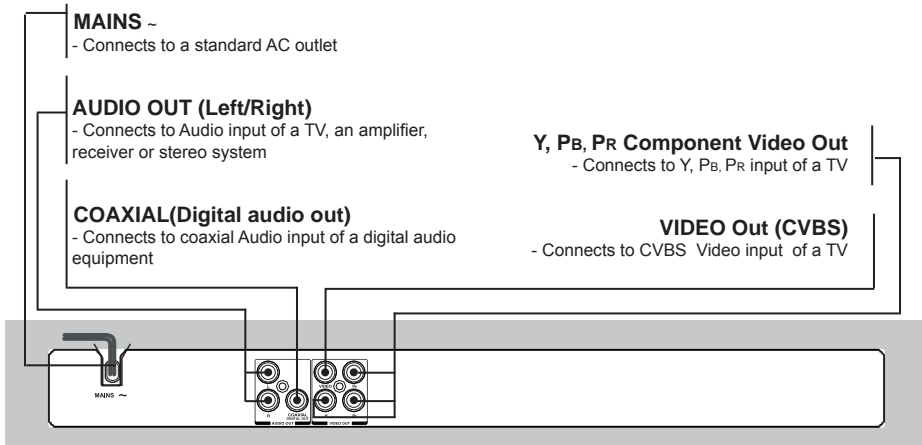
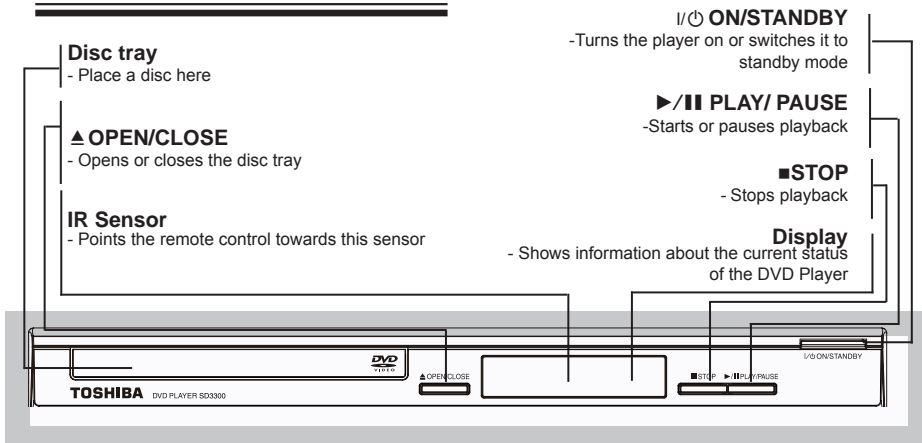

## DVD display

The indicators vary depending on the kinds of disc you play.

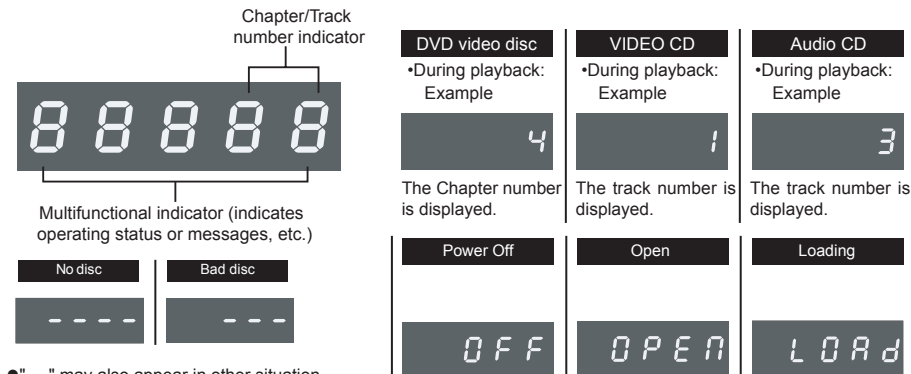

● "----" may also appear in other situation.

## Remote Control

See the page in [ ] for details.

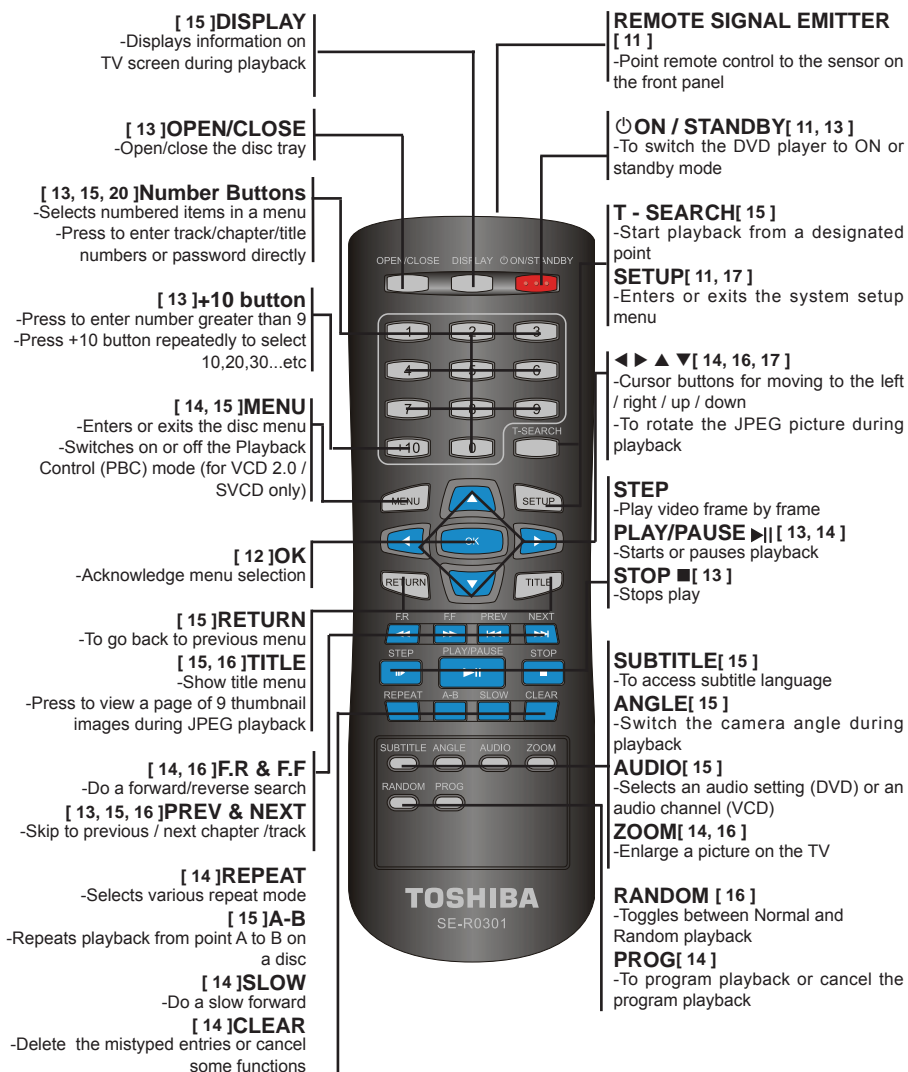

# Getting Started

## Inserting Batteries

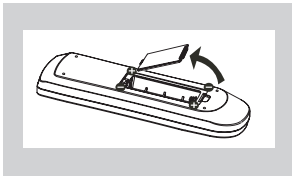

- 1 Open the battery compartment.
- 2 Insert two batteries type R03 or AAA, following the indications (+ / - ) inside the compartment.
- 3 Close the cover.

### CAUTION:

Never throw batteries into a fire.

### Note:

- Be sure to use AAA size batteries.
- Dispose of batteries in a designated disposal area.
- Batteries should always be disposed of with the environment in mind. Always dispose of batteries in accordance with applicable laws and regulations.
- If the remote control does not operate correctly, or if the operating range becomes reduced, replace batteries with new ones.
- When necessary to replace batteries in the remote control, always replace both batteries with new ones. Never mix battery types or use new and used batteries in combination.
- Always remove batteries from remote control if they are dead or if the remote control is not to be used for an extended period of time. This will prevent battery acid from leaking into the battery compartment.

## Using the Remote Control to Operate the System

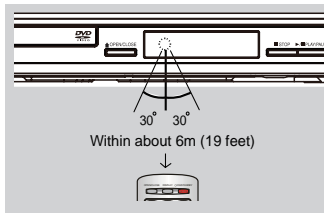

- 1 Aim the Remote Control directly at the remote sensor (IR) on the front panel.
- 2 Do not put any objects between the Remote Control and DVD Player while operating the DVD Player.

## Finding your viewing channel

- 1 Press I/ON/STANDBY on the DVD player to turn it on.
- 2 Turn on the TV and set it to the correct video-in channel. You should see the blue DVD background screen.  
→ Usually these channels are between the lowest

and highest channels and may be called FRONT, AV IN or VIDEO. See your TV's manual for more details.

→ Or, you may go to channel 1 on your TV, then press the Channel down button repeatedly until you see the Video In channel.

→ Or, the TV remote control may have a button that chooses different video modes.

→ Or, set the TV to channel 3 or 4 if you are using an RF modulator.

- 3 If you are using external equipment, (such as audio system or receiver), turn it on and select the appropriate input source for the DVD player output. Refer to the equipment user's manual for detail.

## Setting up Progressive Scan feature

### (For Progressive Scan TV only)

The progressive scan display twice the number of frames per seconds than interlaced scanning (ordinary normal TV system). With nearly double the number of lines, progressive scan offers higher picture resolution and quality.

Before you start...

- Ensure that you have connected this DVD player to a progressive scan TV using the Y, Pb, PR connection (see page 6).

- Ensure that you have completed the basic installation and set up.

- 1 Turn on your TV and select the video input connected to the DVD player (refer to your TV user manual).
- 2 Press ON/STANDBY on the remote control to turn on the DVD player.  
→ The blue DVD background screen will appear on the TV.
- 3 Press SETUP.
- 4 Press ▲/▼ to select { Video }, then press ►.

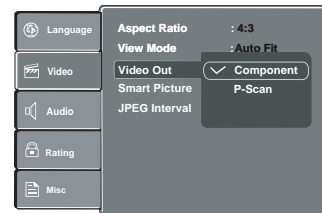

- 5 Press ▲/▼ to select { Video Out }, then press ►.
- 6 Select { P-Scan }, then press OK to confirm.  
→ The menu will appear on the TV.

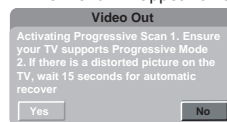

**Helpful hint** Press ◀ to go back to previous menu item.  
Press SETUP to exit the menu item.

# Getting Started/Playback from disc

- 7 Press ◀ to highlight { **Yes** } and press OK to confirm.  
→ The reconfirmation menu will appear on the TV.

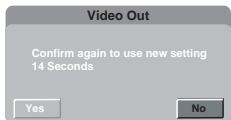

- 8 Press ◀ to highlight { **Yes** } and press OK to confirm.  
→ The setup is now completed and you can start enjoying the high quality picture.

## To deactivate Progressive Scan manually:

- 1 Wait for 15 seconds for the auto recovery.

### OR

- 1 Press OPEN/CLOSE ▲ on the DVD player to open the disc tray.  
2 Press number button '1' on the remote control for a few seconds.

→ The DVD background screen appears.

Tip:

*-There are some progressive scan TVs and High-Definition TVs that are not fully compatible with this unit, resulting in the unnatural picture when playing back a DVD VIDEO disc in the progressive scan mode. In such a case, turn off the progressive scan feature on both the DVD player and your TV.*

## Setting the language

Choose your desired On-Screen Display(OSD)language including English, French and Spanish.

### On-Screen Display (OSD) Language

The On-screen language for the system setup menu will remain as you set it, regardless of various disc languages.



- 1 Press SETUP.  
2 Press ▲/▼ to select { **Language** }.  
3 Press ► to highlight { **OSD language** }, then press ►.  
4 Press ▲/▼ to select a language and press OK to confirm.

### Subtitle, Audio and DVD Menu language

You can choose your own preferred language or soundtrack from Subtitle, Audio and DVD Menu languages. If the language selected is not available

on the disc, the disc's default language will be used instead.



- 1 Press SETUP.  
2 Press ▲/▼ to select { **Language** }, then press ►.  
3 Press ▲/▼ to highlight one of the options below, then press ►.  
{ **Subtitle** }  
Select this to change the subtitle language.  
{ **Audio** }  
Select this to change the disc soundtrack language.  
{ **DVD Menu** }  
Select this to change the language of the disc menu.  
4 Use ▲/▼ to select a language and press OK to confirm.  
5 Repeat steps 3 - 4 for other language settings.

### IMPORTANT!

- DVD discs and players are designed with regional restrictions. Before playing a disc, make sure the disc is for the same zone as your player.

- If 'Ⓢ' appears on the TV screen when a button is pressed, it means the function is not available on the current disc or at the current time.

## Playable discs

Using this DVD player, you can playback on the following discs. Some of these discs may be incompatible.

DVD Video disc(Digital Versatile Disc)



DVD±R/RW (DVD Recordable / Rewritable), DVD±R DL (Dual layer) of DVD Video format or Audio/Video formats (e.g., JPEG files).



CD-R (CD-Recordable)

Audio/Video formats (e.g., JPEG files).



CD-RW (CD-Rewritable)

Audio/Video formats (e.g., JPEG files).



Audio CD (Compact Disc Digital Audio)



**Helpful hint:** Press ◀ to go back to previous menu item.  
Press SETUP to exit the menu item.

# Playback from disc/Playback Feature

**Video CD**  
(Formats 1.0, 1.1, 2.0)



**Super Video CD**

**DVD** is a trademark of DVD Format/Logo Licensing Corporation.

Because of problems and errors that can occur during the creation of DVD and CD software and/or the manufacture of DVD and CD discs, Toshiba cannot assure that this DVD player will successfully play every disc bearing the DVD and CD logos. If you happen to experience any difficulty playing a DVD and/or CD disc on this DVD player, please contact Toshiba Customer Service.

This DVD player requires discs/recordings to meet certain technical standards in order to achieve optimal playback quality. There are many different types of recordable disc formats. Not all recordable discs will operate or produce optimal playback quality. The technical criteria set forth in this owner's manual are meant only as a guide. You must obtain any required permission from copyright owners to download or use copyrighted content. Toshiba cannot and does not grant such permission.

## Supported Formats

### JPEG/Pictures

-The file extensions have to be '.JPG' and not '.JPEG'.

-ISO format.

-Maximum of 5760×3840 resolution can be supported.

-Maximum file size: 5 Mbytes.

-Maximum of 500 files and 200 folders are supported.

-When the number of files(or folders) reaches the maximum limit, the rest of the files(or folders) cannot be displayed.

-It can only display DCF-standard still pictures or JPEG pictures such as TIFF.

*Tips:*

- Maximum 100 sessions for CD and 10 multi border for DVD are supported.

- For DVD-R and DVD-RW multi border, only finalized disc can be supported.

- For DVD+R and DVD+RW multi border, both finalized and unfinalized disc cannot be supported.

## Starting disc playback

- 1 Turn on the TV and select the video input connected to the DVD player.
- 2 Press **ON/STANDBY** to turn on the DVD player.
- 3 Press **OPEN/CLOSE** to open the disc tray.
- 4 Place a disc onto the disc tray with the label facing up, then press **OPEN/CLOSE**.

**Helpful hint** Some discs cannot be played on this DVD player due to the configuration and characteristics of the disc, or due to the condition of recording and authorizing software.

→For double-sided discs, load the side which you want to play facing up.

- 5 Playback may start automatically. If not, press **PLAY/PAUSE** **▶||**.

→If a disc menu appears on the TV, see page 14 'Using the disc menu'.

→If the parental control was activated for the inserted disc, you have to enter your four-digit password, see page 20.

→For more playback features, see pages 13 - 17.

*Tips:*

-Do not overturn the DVD player while disc loading, playing or ejecting.

-Do not close the disc tray manually if the power is switched off.

## Basic playback control

Unless otherwise stated, all operations described are based on Remote Control use.

### Pausing playback

- 1 During playback, press **PLAY/PAUSE** **▶||** to pause playback and display a still picture.  
→Sound will be muted.
- 2 To resume normal playback, press **PLAY/PAUSE** **▶||** again.

### Skipping chapter/track

● Press **PREV** **◀◀** / **NEXT** **▶▶** to go to the previous or next chapter/track during playback.

→When **PREV** **◀◀** is pressed after the 5 seconds of playback, playback will start from the beginning of the current chapter/track. If you press the button within the 5 seconds, playback will start from the beginning of the preceding chapter/track.

● Press **DISPLAY** to display the disc information for title/chapter/track.

● Use Number buttons to enter valid chapter / track number directly. For the track/chapter numbers which are greater than "9", use "+10" button. Each press increases the number by 10. Then press the second digit of track/Chapter number.

→The playback skips to the selected chapter / track.

*Tip:*

- For VCD 2.0 / SVCD discs, accessing tracks using number buttons is not possible if the PBC mode is turned on.

### Stopping playback

- 1 During playback, press **STOP** **■**.  
●The DVD player memorises the stopped point.  
Press **PLAY/ PAUSE** **▶||** to resume playback from the location where you stopped playback.  
●If you press **STOP** **■** again, the DVD player will cancel the resume function.

*Tips:*

-Screen saver will start automatically if the disc playback is stopped for about 2 minutes.

-The player will automatically switch to Power Standby mode if you do not press any buttons for about 22 minutes after the disc has stopped playing.

## Program playback

During playback, press PROG, then the OSD will appear as below:

**For VCD:**



**For DVD:**

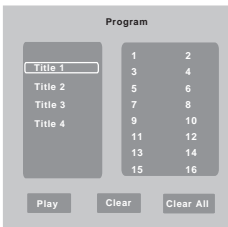

- 1 Use the ▲/▼ and OK button to select your desired title/chapter/track in the list.
- 2 When you have finished programming, press ► to move the cursor to the 'Play', then press the OK button or directly press PLAY/PAUSE ►|| button to start the program playback.
- 3 Press CLEAR or select 'Clear' to delete one by one from last chosen track / title /chapter or select 'Clear All' to clear all the programmed tracks/titles/chapters.
- 4 Press STOP twice to cancel program playback.

## Operations for video playback (DVD/VCD/SVCD)

### Using the disc menu

Depending on the disc, a menu may appear on the TV screen once you load in the disc.

**To select a playback feature or item**

●Use ▲/▼ or number buttons on the remote control, then press OK to start playback.

**To access or remove the menu.**

●Press MENU on the remote control.

### Zooming In

This function allows you to enlarge the picture on the TV screen and to pan through the enlarged picture.

- 1 During playback, press ZOOM repeatedly to display the picture with different scales.
  - Use ◀/▶/▲/▼ to pan through the enlarged picture.
  - Playback will continue.
- 2 Press ZOOM repeatedly to return to the original size.

### Slow Motion

- 1 Press SLOW during playback to select the required speed: 1/2, 1/4, 1/8( forward only ).
  - ➔Sound will be muted.
- 2 To return to normal speed, press PLAY/ PAUSE ►||.

### Forward/ Reverse Searching

You can fast forward or fast reverse a disc during playback and select a desired search speed.

**For DVD, VCD, SVCD, CD,**

- 1 During playback, press F.R/ F.F to select the required speed: X2, X8, X30, X100(backward or forward).
  - ➔Sound will be muted (DVD/VCD/SVCD) or intermittent (CD).
- 2 To return to normal speed, press PLAY / PAUSE ►||.

## Selecting various repeat functions

### Repeat play mode

The repeat play options vary depending on the disc type.

- 1 While playing a disc, press REPEAT repeatedly to choose a repeat option.

**For DVD**

- Repeat Chapter (currently playing chapter)
- Repeat Title (currently playing title)
- Off (cancel)

**For Video CD, Audio CD**

- Repeat Single (currently playing track)
- Repeat All (entire disc)
- Off (cancel)

**Helpful hint:** The operating features described here might not be possible for certain discs. Always refer to the instructions supplied with the discs.

# Playback Feature

## For JPEG

- Repeat Single (currently playing file)
- Repeat All (current folder)
- Off (cancel)

Tip:

-For VCD2.0/SVCD discs, repeat playback is not possible if the PBC mode is turned on.

### Repeating a section within a title/track

You can repeat the playback of a specific segment within a title or track. To do this, you must mark the start and end of the segment you want.

- 1 While playing a disc, press A - B at your chosen starting point.
- 2 Press A - B again at your chosen end point.  
→ The section will now repeat continuously.
- 3 To exit the sequence, press A - B.

## Viewing the disc playback Information

You can view the disc information (such as current title/chapter/track number, total playing time or remaining time on the disc) without interrupting the disc playback.

- 1 During playback, press DISPLAY repeatedly on the remote control.  
→ The available disc information appears on the TV screen with the following sequence.

DVD Video	(DVD)
Time	
Time	00 : 03 : 33/01 : 24 : 46 (DVD)
Title	
Title	1/1 (DVD)
Chapter	
Chapter	2/8 (DVD)
Audio	
Audio 1/1	D 5.1Ch Eng (DVD)
Subtitle	
Subtitle	1/8 Eng (DVD)
Angle	
Angle 1/4	(DVD)
VCD2.0	(VCD)
Time	
Time	00 : 03 : 33/00 : 05 : 00 (VCD)
Track	
Track	3/24 (VCD PBC OFF)
OR	
Time	
Time	00 : 03 : 33/00 : 05 : 00 (VCD PBC ON)
PBC On	(VCD PBC ON)

### Title/Chapter/Track/Time selection

- 1 Press T-SEARCH, then press ▲/▼ to select { Time }, { Title }, { Chapter } or { Track }.

For VCD :

PBC OFF

Track	---	
Time	--:--	(desired time of the current track)
Disc Time	--:--	(desired time of the disc)

For DVD:

Title	---	
Chapter	---	
Time	--:--	(desired time of the disc)

**Helpful hint:** The operating features described here might not be possible for certain discs. Always refer to the instructions supplied with the discs.

- 2 Use the number buttons ( 0-9 ) to input a valid number or time ("0" cannot be input as the first number). (This function only apply to DVD/VCD/CD/ SVCD.)
- 3 Press OK to confirm.  
→ The playback skips to the selected title/chapter/ track/time.

### Angle

- When {Angle} information appears on the screen, press ANGLE button on the remote control repeatedly to switch between different angles.  
→ Playback will go to the selected angle.

## Special DVD Features

### Playing a Title

- 1 Press TITLE.  
→ The disc title menu appears on the TV screen.
- 2 Use ▲/▼/◀/▶ or number buttons (0-9) to select a play option.
- 3 Press OK to confirm.

### Changing the Audio Language

For DVD :

Press AUDIO repeatedly to select different audio languages.

Changing the Audio Channel

For VCD :

● Press AUDIO to select the available audio channels provided by the disc (Left, Right, Mix, Stereo).

### Subtitles

● Press SUBTITLE repeatedly to select different subtitle languages.

## Special VCD and SVCD Features

For VCD with Playback Control ( PBC ) feature (version 2.0 only)

● Press MENU to toggle between ' PBC On ' and ' PBC Off '.

→ If you select ' PBC On ', the disc menu ( if available ) will appear on the TV.

→ Use the number buttons ( 0-9 ) to select a play option.

● Press PREV ◀◀ / NEXT ▶▶ to go to the previous or next track.

→ When PREV ◀◀ is pressed after the 5 seconds of playback, playback will start from the beginning of the current track. If you press the button within the 5 seconds, playback will start from the beginning of the preceding track.

● During playback, pressing RETURN will return to the menu screen (if PBC is on).

**If you want to skip the index menu and playback directly from the beginning.**

● Press MENU on the remote control to turn the PBC off.



## Playing JPEG/ Kodak picture CD

### IMPORTANT!

You have to turn on your TV and set to the correct Video In channel. (See page 11, ' Finding your viewing channel ' ).

### General Operation

- Load a disc.
  - The disc reading time may exceed 30 seconds due to the complexity of the directory/file configuration.
  - The data disc menu appears on the TV screen.

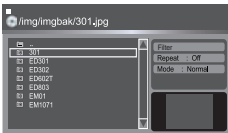

- Press ▲ / ▼ to select the folder and press OK to open the folder.
  - Press ▲ / ▼ to select a track/file.
  - Press OK to confirm.
- Tips:**  
 - If you highlight on a jpeg file, a preview will appear.  
 - During JPEG playback, the LED will display the file number.

### Playback Selection

During playback, you can;

- Press PREV |◀◀ / NEXT ▶▶| to select the previous/next track/file in the current folder.
- Press PLAY/PAUSE ▶|| repeatedly to pause/ resume playback.

### Play modes for Audio CD/JPEG

You are able to modify the play modes through the toolkit which appears on the right of below picture on the screen. Press ◀ / ▶ to navigate between the windows and ▲ / ▼ buttons to select files/ tracks or play mode items. Then press OK . Please refer to below steps to playback files /tracks in the **Program View** list:

- Select **Edit Mode** in the toolkit then press OK to start edit mode.
- Select a file/track or more files/tracks you want in the original view list.
- Select **Add To Program** in the toolkit then press OK. '√' will disappear from screen. It means that the files/tracks you have selected already added into the **Program View** list.
- Select **Program View** in the toolkit then press OK to open the file/track in the Program View list that you already selected in step ②.
- Press PLAY / PAUSE ▶|| to playback all files/tracks in the Program View list.

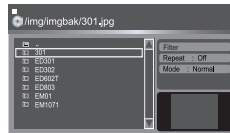

The Toolkit has the following play mode items:

- **Filter ( Audio/Photo/Video )**: Sets file filters (Filter is not applicable to Audio CD.)
- **Repeat (Off/Single/ All)**:
  - Off**: Resumes normal playback
  - Single**: Repeats the current track/file.
  - All**: Repeats all files on the current folder or all tracks on the disc.
- **Mode(Normal/Random)**
  - This mode can also be toggled by using RANDOM button.
  - Normal**: Resumes normal playback
  - Random**: Playbacks track/file in random order.
    - During CD-DA/JPEG files playback;
      - If Repeat All(or Repeat Off) and Random are selected, all the tracks will be played randomly and endlessly.
      - If Repeat Single is selected, Random cannot be selected and vice versa.
- **Edit Mode**: Program operation works only when Edit Mode is selected. After finished storing the files/ tracks you want into the Program View list, select "Edit Mode" again and press OK to release edit mode.
- **Program View**: To view tracks/files in the Program View list. It is disabled if the Program View list is empty.
- **Add To Program**: Add files/tracks to the Program View list. It is disabled if Edit Mode is not selected. (The maximum number of files/tracks can be added is 30.)
- **Browser View**: To view files/tracks in the Original View list.
- **Clear Program**: Delete the files/tracks in the Program View list.
  - Select a file/track or more you want to delete in stop mode. '√' will appear besides the deleted file/ track. Select **Clear Program** and then press OK . It is disabled if Edit mode is not selected.

### Preview ( JPEG)

During playback, press TITLE to view a page of 9 thumbnail images.

- Use ▲ / ▼ / ◀ / ▶ to select an image. Press OK to view the selected image in full-screen and subsequent images will be displayed one after another automatically. See page 18 for JPEG Interval setting.
- Press PREV |◀◀ / NEXT ▶▶| to view the previous or next thumbnail screen.

### Zoom picture ( JPEG)

- During playback, press ZOOM repeatedly to display the picture with different scales.
- Use ▲ / ▼ / ◀ / ▶ to view the zoomed picture.

**Helpful hint:** The operating features described here might not be possible for certain discs. Always refer to the instructions supplied with the discs.

# Playback Feature/DVD Menu Options

## Rotate picture (JPEG)

• During playback, press ▲ / ▼ / ◀ / ▶ to rotate the picture on the TV screen.

▲ / ▼ : flip the picture vertically by 180°

◀ : rotate the picture anti-clockwise by 90°

▶ : rotate the picture clockwise by 90°

Tip:

-It may not be possible to play certain JPEG disc due to the configuration and characteristics of the disc or condition of the recording.

This DVD Player setup is carried out via the TV, enabling you to customise the DVD player to suit your particular requirement.

## Using the Language setup menu

- 1 Press SETUP on the remote control.

→ The system setup menu appears.



- 2 Press ▲ / ▼ to select {Language}, then press ▶.

- 3 Press ▲ / ▼ to select an item, then press ▶ to access.

Example: { OSD language }

→ The options for the selected item appears.

→ If the selection in the menu is greyed out, that means the feature is not available or not possible to change at the current state.

- 4 Use ▲/▼ to select a setting and press OK to confirm.

Example: { English }

→ The setting is selected and setup is completed.

- 5 To exit, press SETUP.

## OSD Language

This menu contains various language options for the language displayed on the screen.

## Subtitle/Audio/DVD Menu

These menus contain various language options for subtitle, audio and DVD menu which may be recorded on the DVD.

Tips:

-Some DVD video discs may be set to display subtitles in a different language other than you selected. A prior subtitle language may be programmed on the disc.

-Some DVD video discs allow you to change subtitle selections only via the disc menu. If this is the case, press the MENU button and choose the appropriate subtitle language from the selection on the disc menu.

-Some DVD video discs may not be played in a different audio language that you selected. A prior language may be programmed on the disc.

**Helpful hint:** Press ◀ to go back to previous menu item.  
Press SETUP to exit the menu item.

-Some DVD discs may not include your pre-selected language. In this case, the DVD player automatically displays discs menus consistent with the disc's initial language setting.

## Using the Video setup menu

- 1 Press SETUP on the remote control.

→ The system setup menu appears.

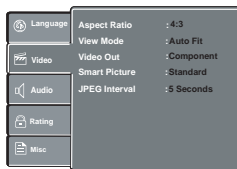

- 2 Press ▲ / ▼ to select { Video }, then press ▶

- 3 Press ▲ / ▼ to select an item, then press ▶ to access.

Example: { Video Out }

→ The options for the selected item appears.

→ If the selection in the menu is greyed out, that means the feature is not available or not possible to change at the current state.

- 4 Use ▲ / ▼ to select a setting and press OK to confirm.

Example: { P-Scan }

→ The setting is selected and setup is completed.

- 5 To exit, press SETUP.

## Aspect Ratio

The picture shape can be adjusted to fit your TV and the format must be available on the playback disc. Otherwise, the TV display will not affect the picture during playback.

- 1 In 'Video', press ▲ / ▼ to select {Aspect Ratio}, then press ▶.

{ 4:3 }

Select this if you have a normal TV. A 'wide-screen' source display with black bars on the top and bottom will be displayed on the TV screen.

{ 16:9 }

Select this for wide-screen TV (frame ratio 16:9).

- 2 Use ▲ / ▼ to select a setting and press OK to confirm.

## View Mode

Use view mode to scale an image that fits to the TV screen's width and height.

- 1 In 'Video', press ▲ / ▼ to select { View Mode }, then press ▶.

{ Fill }

Fill the screen with decoded image.

{ Original }

Display image as its original size.

{ Height Fit }

Fit the screen height with image height.

{ Width Fit }

Fit the screen width with image width.

## { Auto Fit }

Automatically display the decoded image on screen at a suitable size.

## { Pan Scan }

Automatically display decoded image on full screen without distortion.

- Use ▲ / ▼ to select a setting and press OK to confirm.

*Tip:*

-Depending on the type of disc, you may not be able to view the mode as selected.

## Video Out

The video output of the DVD player can be selected as "Component" or "P-Scan".

- In "Video", press ▲ / ▼ to select { Video Out }, then press ►.

### { Component }

Select this for Video(CVBS) or component video connection.

### { P-Scan }

Select this when you connect your DVD player to your TV, which has component video inputs that supports progressive scan.

- Use ▲ / ▼ to select a setting and press OK to confirm.
  - If the progressive scan feature is activated but the connected TV does not support progressive scan, press number button "1" with the disc tray opened to set the video output of the DVD player to "Component".

## Smart Picture

This DVD player provides four predefined sets of picture color settings.

- In "Video", press ▲ / ▼ to select { Smart Picture }, then press ►.

### { Standard }

Select this for a preset standard picture setting.

### { Vivid }

Select this to make the picture brighter.

### { Cool }

Select this to make the picture softer.

### { Personal }

Select this to personalize your picture color by adjusting the brightness, contrast, tint and color (saturation).

- Use ▲ / ▼ to select a setting and press OK to confirm.
- If you select { Personal }, then proceed to steps 4-7.

→The setup menu appears.

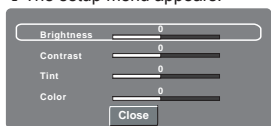

- Press ▲ / ▼ to highlight one of the following options.

### Brightness

Increase the value to brighten the picture or vice versa. Choose zero (0) for average setting.

### Contrast

Increase the value to sharpen the picture or vice versa. Choose zero (0) to balance the contrast.

### Tint

Increase the value to darken the picture or vice versa. Choose zero (0) for average setting.

### Color

Increase the value to enhance the color in your picture or vice versa. Choose zero (0) to balance the color.

- Press ◀ / ▶ to adjust the setting that best suits your personal preference.

- Repeat steps 4~5 to adjust your picture preference.

- Press ▲ / ▼ to select 'Close' and press OK to confirm.

## JPEG Interval

You can continuously playback all JPEG files automatically. Set "JPEG Interval" to "5 Seconds", "10 Seconds" or "15 Seconds".

- In "Video", press ▲ / ▼ to select { JPEG Interval }, then press ►.

### { Off }

Plays back one file at a time.

### { 5 Seconds }

Plays back images in the form of a slide show at 5 seconds intervals.

### { 10 Seconds }

Plays back images in the form of a slide show at 10 seconds intervals

### { 15 Seconds }

Plays back images in the form of a slide show at 15 seconds intervals

- Use ▲ / ▼ to select a setting and press OK to confirm.

## Using the Audio setup menu

- Press SETUP on the remote control.

→The system setup menu appears.

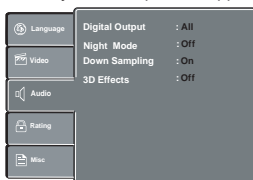

- Press ▲ / ▼ to select { Audio }, then press ►.

- Press ▲ / ▼ to select an item, then press ► to access.

Example: { Night Mode }

→The options for the selected item appears.

→If the selection in the menu is greyed out, that means the feature is not available or not possible to change at the current state.

- Use ▲ / ▼ to select a setting and press OK to confirm.

Example: { On }

→The setting is selected and setup is completed.

- To exit, press SETUP.

**Helpful hint:** Press ◀ to go back to previous menu item.  
Press SETUP to exit the menu item.

# DVD Menu Options

## Digital Output

Select this if you connect to a multichannel decoder/receiver.

- 1 In 'Audio', press ▲ / ▼ to select { **Digital Output** }, then press ►.

To deactivate the digital audio output. For example, if you use the AUDIO OUT jacks to connect to a TV or stereo system.

{ **PCM** }

Select this if the connected device is not capable of decoding multichannel audio. The DVD player will convert the Dolby Digital signal to PCM (Pulse Code Modulation).

{ **All** }

Select this if the connected device has a built-in multichannel decoder that supports one of the multichannel audio format (Dolby Digital, DTS).

- 2 Use ▲ / ▼ to select a setting and press OK to confirm.

Tip:

-When playing MPEG and set Digital Output to {All}, the player will output PCM signals.

## Night Mode

This mode optimizes playback of sound at low volume. High volume outputs will be softened and low volume outputs are brought upward to an audible level.

- 1 In 'Audio', press ▲ / ▼ to select { **Night Mode** }, then press ►.

{ **Off** }

Turns off night mode feature. Select this to enjoy the surround sound with its full dynamic range.

{ **On** }

Select this to set low volume output. This feature is only available for movie discs with Dolby Digital mode.

- 2 Use ▲ / ▼ to select a setting and press OK to confirm.

## Down Sampling

You can enable and disable the digital signal for better sound output quality.

- 1 In 'Audio', press ▲ / ▼ to select { **Down Sampling** }, then press ►.

{ **Off** }

If your amplifier / decoder is compatible with 96 KHz PCM, select " Off ". Sound is sampled at 96 KHz.

{ **On** }

If your amplifier / decoder is not compatible with 96 KHz PCM, select " On ". Sound recorded at 96 KHz is down sampled to 48 KHz.

- 2 Use ▲ / ▼ to select a setting and press OK to confirm.

Tip:

- When playing back disc with copyright protection, the sound will be down sampled to 48 KHz even when you select Down Sampling off.

## 3D Effects

To obtain expansive virtual surround sound effects from two speakers, set 3D Effects to on. This

**Helpful hint:** Press ◀ to go back to previous menu item. Press SETUP to exit the menu item.

enhancement sounds only output from the Analog AUDIO OUT (L / R) jacks of the DVD player.

- 1 In 'Audio', press ▲ / ▼ to select { 3D Effects }, then press ►. You can set to { Off } or { On }.
- 2 Use ▲ / ▼ to select a setting and press OK to confirm.

Tip:

- Only effective in playback of a DVD Video disc with Dolby Digital 5.1 bitstream.

## Using the Rating setup menu

- 1 Press SETUP on the remote control.  
→ The system setup menu appears.

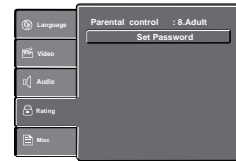

- 2 Press ▲ / ▼ to select { **Rating** }, then press ►.
- 3 Press ▲ / ▼ to select an item, then press ► to access.

**Example: { Parental control }**

→ The options for the selected item appears.

→ If the selection in the menu is greyed out, that means the feature is not available or not possible to change at the current state.

- 4 Use ▲ / ▼ to select a setting and press OK to confirm.

Example: { **8 Adult** }

→ The setting is selected and setup is completed.

- 5 To exit, press SETUP.

## Rating Level settings

Depending on the DVD, you may be asked to change the parental level while playing the disc. The rating levels are from 1 to 8 and are country dependent. You can prohibit the playing of certain discs that are not suitable for your children, or have certain discs played with alternative scenes.

- 1 In 'Rating', press ▲ / ▼ to select { **Parental control** }, then press ►.
- 2 Use the number buttons to enter the four-digit password, then press OK. (See 'Changing the Password' on page 20.)
- 3 Press OK again to list the parental level.

{ **1.Kid Safe** }

Suitable for children.

{ **2.G** }

General Audience; recommended as acceptable for viewers of all ages.

{ **3.PG** }

Parental Guidance suggested.

{ **4.PG-13** }

Unsuitable for children under 13.

{ **5.PG-R** }

Parental Guidance Recommended.

## { 6. R }

Restricted; under 17 requires accompanying parent or adult guardian.

## { 7. NC-17 }

No one under 17 admitted.

## { 8. Adult }

DVD softwares of any grades (adult/general/children) can be played back. Should be viewed only by adults due to graphic sexual material, violence or language.

- Use ▲ / ▼ to select a rating level and press OK to confirm.

→ Select { 8. Adult } to disable parental level and allow all discs to play.

● DVDs that are rated higher than the level you selected will not play unless you enter your four-digit password.

Tips:

-This feature will not limit viewing if the disc manufacturer did not code the disc.

-VCD, SVCD, CD have no level indication, so

parental control has no effect on these type of discs.

This also applies to most illegal DVDs.

-Some DVDs are not coded with a rating though the

movie rating may be printed on the disc cover. The

rating level feature does not prohibit play of such discs.

## Changing the Password

You need to enter your four-digit password to play a prohibited disc or if prompted for a password.

- In 'Rating', press ▲ / ▼ to select {Set Password}, then press OK.

→ You will be prompted to enter your four-digit password.



- Use the number buttons ( 0-9 ) to enter the four-digit password, then press OK.

→ When doing this for the first time, enter the default password ' 0000 ' .

● If you forget your old four-digit password, enter the default password ' 0000 ' .

- Press OK again to enter the new four-digit password.

→ The new four-digit password will now take effect.



- Press OK to confirm.

## Using the Misc (Miscellaneous) setup menu

### Restoring to original settings

Setting the { Use Default Settings } function will reset all options and your personal settings to the factory defaults, except your password and rating level.

- Press SETUP on the remote control.

→ The system setup menu appears.

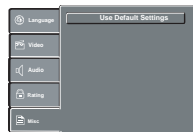

- Press ▲ / ▼ to select { Misc }, then press ►.

- { Use Default Settings } will be highlighted, then press OK.

→ The menu will appear.

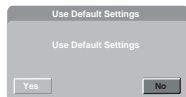

{ Yes }

Select this to reset to factory default settings.

{ No }

Select this to close the menu.

- Use ◀ / ▶ to select a setting and press OK to confirm.

- To exit, press SETUP.

## Tray Lock

Press SETUP button, then press the number button "2006" in sequence to lock the tray.

● All functionality of the player and playback remain the same except for the OPEN/CLOSE button.

● After the tray is locked, "Tray Lock Is On" will appear on the screen when OPEN/CLOSE is pressed.

● To unlock the tray, just follow the same procedure as above.

**Helpful hint:** Press ◀ to go back to previous menu item.  
Press SETUP to exit the menu item.

# Specifications

## DVD Player/Outputs/Supplied Accessories



### DVD Player

Power supply	120 V AC, 60 Hz
Power Consumption	6W ( standby :<1W )
Net weight	1.23 kg
External dismensions	330 X 43 X 209 mm (W/H/D)
Signal System	Standard NTSC
Laser	Semiconductor laser, wavelength 657/790 nm
Frequency range	DVD linear sound : 48 kHz sampling 4 Hz to 22 kHz 96 kHz sampling 4 Hz to 44 kHz
Signal-to-noise ratio	More than 90 dB
Audio dynamic range	More than 80 dB
Harmonic distortion	Less than -65 dB
Wow and flutter	Below measurable level [less than $\pm 0.001$ % ( W.PEAK )]
Operating conditions	Temperature : 5°C to 35°C Operation status :Horizontal

### Outputs

Video output	1.0 V ( p-p ) , 75 $\Omega$ , pin jack x 1
Component video output	(Y) 1.0 V (p-p), 75 $\Omega$ , pin jack x 1 (P B)/(P R) 700 mV (p-p), 75 $\Omega$ , pin jack x 2
Audio output (COAXIAL DIGITAL)	0.5 V (p-p) 75 $\Omega$ pin jack x 1
Audio output (ANALOG)	2.0 V (rms), 10K $\Omega$ , pin jacks (L/R) x 1

### Supplied Accessories

Audio/Video cable	
Remote control(SE-R0301)	
Batteries(AAA)	

- The model complies with the above specifications.
- Designs and specifications are subject to change without notice.
- This model may not be compatible with features and /or specifications that may be added in the future.

## WARNING

Under no circumstances should you try to repair the DVD player yourself, as this will invalidate the warranty. Do not open the DVD player as there is a risk of electric shock.

If a fault occurs, first check the points listed below before taking the DVD player for repair. If you are unable to remedy a problem by following these guides, consult your dealer or TOSHIBA for help.

Problem	Solution
<b>No power</b>	<ul style="list-style-type: none"> <li>-Check if the AC power cord is properly connected.</li> <li>-Press the I/O ON/STANDBY on the front of the DVD player to turn on the power.</li> </ul>
<b>No picture</b>	<ul style="list-style-type: none"> <li>-Refer to your TV's manual for correct Video In channel selection. Change the TV channel until you see the DVD screen.</li> <li>-Check if the TV is switched on.</li> <li>-If the progressive scan feature is activated but the connected TV does not support progressive signals or the cables are not connected accordingly. See pages 11-12 for proper progressive scan set up or deactivate the progressive scan feature as follow:               <ol style="list-style-type: none"> <li>1) Press OPEN/CLOSE on the DVD Player.</li> <li>2) When the disc tray is opened, press number button '1' on the remote control for a few seconds.</li> </ol> </li> </ul>
<b>Distorted picture</b>	<ul style="list-style-type: none"> <li>-Sometimes a small amount of picture distortion may appear depending on the disc being played back. This is not malfunction.</li> </ul>
<b>Picture clipped</b>	<ul style="list-style-type: none"> <li>-May be caused by View Mode Setting (see page 17). Set to Original for normal viewing.</li> </ul>
<b>Completely distorted picture or black /white picture with DVD.</b>	<ul style="list-style-type: none"> <li>-Connect DVD Player directly to the TV.</li> <li>-Make sure the disc is compatible with the DVD player.</li> <li>-Ensure that the DVD Player's setting is set to match that of the disc and your TV.</li> </ul>
<b>No sound / distorted sound</b>	<ul style="list-style-type: none"> <li>-Adjust the volume.</li> <li>-Check that the speakers are connected correctly.</li> </ul>
<b>No audio at digital output</b>	<ul style="list-style-type: none"> <li>-Check the digital connections.</li> <li>-Check if your receiver can decode MPEG-2 or DTS and if not, please make sure the digital output is set to PCM.</li> <li>-Check if the audio format of the selected audio language matches your receiver capabilities.</li> </ul>
<b>No sound and picture</b>	<ul style="list-style-type: none"> <li>-Check that the cable is connected to the correct device (See Connecting to television).</li> </ul>
<b>Disc cannot be played</b>	<ul style="list-style-type: none"> <li>-The DVD±R/RW must be finalized and in video mode format.</li> <li>-Ensure the disc label is facing up.</li> <li>-Check if the disc is defective by trying another disc.</li> <li>-Wrong region code.</li> </ul>
<b>Picture freezes momentarily during playback</b>	<ul style="list-style-type: none"> <li>-Check the disc for fingerprint/scratches and clean with a soft cloth wiping from centre to edge.</li> </ul>
<b>No return to start-up screen when disc is removed</b>	<ul style="list-style-type: none"> <li>-Reset the unit by switching the player off, then on again.</li> </ul>
<b>The player does not respond to the Remote Control</b>	<ul style="list-style-type: none"> <li>-Aim the Remote Control directly at the sensor on the front of the player.</li> <li>-Reduce the distance to the player.</li> <li>-Replace the batteries in Remote Control.</li> <li>-Re-insert the batteries with their polarities(+/- signs)as indicated.</li> </ul>
<b>Buttons do not work</b>	<ul style="list-style-type: none"> <li>-To completely reset the player, unplug the AC cord from AC outlet for 5-10 seconds.</li> </ul>

# Troubleshooting

Problem	Solution
<b>Player does not respond to some operating commands during playback.</b>	-Operations may not be permitted by the disc. Refer to the instructions of the disc jacket.
<b>DVD Player cannot read CDs /DVDs</b>	-Use a commonly available cleaning CD/DVD to clean the lens before sending the DVD Player for repair.
<b>Menu items cannot be selected</b>	-Press STOP twice before selecting system setup menu. -Depending on the disc availability, some menu items cannot be selected.
<b>Unable to select Progressive Scan on/off</b>	-Ensure that the output of the Video Out signal is switch to P-Scan/Component.



**Analog audio:**

An electrical signal that directly represents sound. In contrast, digital audio can also be an electrical signal, but is an indirect representation of sound. See also Digital audio.

**Aspect ratio:**

The width of a TV screen relative to its height. Conventional TVs are 4:3 (i.e., the screen is almost square). Widescreen models are 16:9 (the screen is almost twice as wide as its height)

**AUDIO OUT jacks:**

Jacks on the back of the DVD System that send audio to another system (TV, Stereo, etc.)

**Bit rate:**

The amount of data used to hold a given length of music; measured in kilobits per seconds, or kbps. Or, the speed at which you record. Generally, the higher the bit rate, or the higher the recording speed, the better the sound quality. However, higher bit rates use more space on a disc.

**Chapter:**

Just as a book is split up into several chapters, a title on a DVD disc is usually divided into chapters. See also Title.

**Digital audio:**

An indirect representation of sound using numbers. During recording, the sound is measured at discrete intervals (44, 100 times a second for CD audio) by an analog-to-digital converter, generating a stream of numbers. On playback, a digital-to-analog converter generates an analog signal based on these numbers. See also Sampling frequency and Analog audio.

**Disc menu:**

A screen display prepared for allowing of selection of images, sound, subtitle, multi-angles etc. recorded on the DVD.

**Dolby® Digital:**

A system developed by Dolby Laboratories that compresses digital sound. It works with stereo (2ch) or multi-channel audio.

**DTS®:  
(Digital Theater System)**

DTS is a Multi-channel surround sound system, but it is different from Dolby Digital. DTS format was developed by Digital Theater Systems, Inc.

**JPEG:  
(Joint Photographic Experts Group)**

JPEG is a method of compressing still image files. You can copy JPEG files on CD-RW / R or DVD±R / R discs from a computer and play back the files on this unit.

**Multichannel:**

DVD is specified to have each sound track constitute one sound field. Multichannel refers to a structure of sound tracks having three or more channels.

**Parental control:**

A function of the DVD to limit playback of the disc by the age of the users according to the limitation level in each country. The limitation varies from disc to disc; when it is activated, playback will be prohibited if the software's level is higher than the user-set level.

**PBC (Video CD only):  
(Playback Control)**

This function enables you to play back interactive software using a menu screen. See also Title.

**PCM:  
(Pulse Code Modulation)**

PCM is a format that converts audio into digital data. It is mainly used for Audio CDs and DAT. This unit can play back sounds as realistic as possible by converting even compressed Dolby Digital and MPEG audio to PCM.

**Progressive scan:**

It displays all the horizontal lines of a picture at one time, as a signal frame. This system can convert the interlaced video from DVD into progressive format for connection to a progressive display. It dramatically increases the vertical resolution.

**Region code:**

Regions associate discs and players with particular areas of the world. This unit will only play back discs that have compatible region codes. You can find the region code of your unit by looking on the rear panel. Some discs are compatible with more than one region (or all regions).

**Sampling frequency:**

The rate at which sound is measured by a specified interval to turn it into digital audio data. The number of samples in one second is defined as the sampling frequency. The higher the rate is, the better the possible sound quality.

**Title:****(DVD)**

A collection of chapters on a DVD. See also chapter.

**(Video CD)**

The contents of a Video CD. When playing back a Video CD with the PBC function, the title menu will appear automatically.

**Track:**

Audio CDs and Video CDs use tracks to divide the contents of a disc. The DVD equivalent is called a chapter. See also Chapter.

# Limited United States Warranty

## Limited United States Warranty Digital Audio Video ("DAV") Product - Exchange Warranty

Toshiba America Consumer Products, L.L.C. ("TACP") makes the following limited warranties to original consumers in the United States. THESE LIMITED WARRANTIES EXTEND TO THE ORIGINAL CONSUMER PURCHASER OR ANY PERSON RECEIVING THIS DAV PRODUCT AS A GIFT FROM THE ORIGINAL CONSUMER PURCHASER AND TO NO OTHER PURCHASER OR TRANSFEREE.

DAV PRODUCTS PURCHASED IN THE U.S.A. AND USED ANYWHERE OUTSIDE OF THE U.S.A., INCLUDING, WITHOUT LIMITATION, CANADA AND MEXICO, ARE NOT COVERED BY THESE WARRANTIES.

DAV PRODUCTS PURCHASED ANYWHERE OUTSIDE OF THE U.S.A., INCLUDING, WITHOUT LIMITATION, CANADA AND MEXICO, AND USED IN THE U.S.A., ARE NOT COVERED BY THESE WARRANTIES.

### Limited Warranty

TACP warrants this DAV Product and its parts against defects in materials or workmanship for a period of ninety (90) days after the date of original retail purchase.

**DURING THIS PERIOD, TACP WILL EXCHANGE A DEFECTIVE DAV PRODUCT WITH A NEW OR REFURBISHED DAV PRODUCT WITHOUT CHARGE TO YOU. DURING THE PERIOD THAT COMMENCES ON THE DATE THAT IS NINETY ONE (91) DAYS AFTER THE DATE OF ORIGINAL RETAIL PURCHASE AND ENDS ON THE DATE THAT IS THREE HUNDRED SIXTY FIVE (365) DAYS AFTER THE DATE OF ORIGINAL RETAIL PURCHASE, TACP WILL EXCHANGE A DEFECTIVE DAV PRODUCT WITH A NEW OR REFURBISHED DAV PRODUCT FOR A FEE.**

### Rental Units

The warranty for DAV Product rental units begins on the date of the first rental or thirty (30) days after the date of shipment to the rental firm, whichever comes first.

### Commercial Units

DAV Products sold and used for commercial purposes have a limited warranty for all parts and labor, which warranty begins on the date of original retail purchase and ends on the date that is ninety (90) days thereafter.

### Owner's Manual and Product Registration Card

Read this owner's manual thoroughly before operating this DAV Product. Complete and mail the enclosed product registration card or register your DAV Product on-line at [www.tacp.toshiba.com/service](http://www.tacp.toshiba.com/service) as soon as possible. By registering your DAV Product you will enable TACP to bring you new products specifically designed to meet your needs and help us to contact you in the unlikely event a safety notification is required under the U.S. Consumer Product Safety Act. Failure to complete and return the product registration card does not diminish your warranty rights.

### Your Responsibility

THE ABOVE WARRANTIES ARE SUBJECT TO THE FOLLOWING CONDITIONS:

- (1) You must retain your bill of sale or provide other proof of purchase.
- (2) All warranty servicing of this DAV Product must be made pursuant to the TACP DAV Product Warranty Exchange Program.
- (3) The warranties from TACP are effective only if the DAV Product is purchased and operated in the Continental U.S.A. or Puerto Rico.
- (4) Labor service charges for set installation, setup, adjustment of customer controls, and installation or repair of antenna systems are not covered by this warranty. Reception problems caused by inadequate antenna systems are your responsibility.
- (5) Warranties extend only to defects in materials or workmanship as limited above, and do not extend to any DAV Product or parts that have been lost or discarded by you or to damage to the DAV Product or parts caused by fires, misuse, accident, Acts of God (such as lightning or fluctuations in electric power), improper installation, improper maintenance, or use in violation of instructions furnished by TACP; use or malfunction through simultaneous use of this DAV Product and connected equipment; or to units that have been modified or had the serial number removed, altered, defaced, or rendered illegible.
- (6) This warranty does not cover product sold AS IS or WITH ALL FAULTS.

### How to Obtain Warranty Services

If, after following all of the operating instructions in this manual and checking the section "Troubleshooting," you find that service is needed:

- (1) For instructions on how to obtain warranty service for your DAV Product under the TACP DAV Product Warranty Exchange Program, contact TACP's Consumer Solutions Center toll free at 1-800-631-3811.
- (2) You must include the original bill of sale (or a copy of the original bill of sale) or other proof of purchase along with the entire DAV Product when sending the DAV Product to the TACP Warranty Exchange Center specified by TACP's Consumer Solutions Center. You are responsible for all inbound transportation and insurance charges for the DAV Product to the TACP Warranty Exchange Center.

For additional information, visit TACP's website:  
[www.tacp.toshiba.com](http://www.tacp.toshiba.com)

**ALL WARRANTIES IMPLIED BY THE LAW OF ANY STATE OF THE U.S.A., INCLUDING THE IMPLIED WARRANTIES OF MERCHANTABILITY AND FITNESS FOR A PARTICULAR PURPOSE, ARE EXPRESSLY LIMITED TO THE DURATION OF THE LIMITED WARRANTIES SET FORTH ABOVE. WITH THE EXCEPTION OF ANY WARRANTIES IMPLIED BY THE LAW OF ANY STATE OF THE U.S.A. AS HEREBY LIMITED, THE FOREGOING WARRANTY IS EXCLUSIVE AND IN LIEU OF ALL OTHER WARRANTIES, GUARANTEES, AGREEMENTS, AND SIMILAR OBLIGATIONS OF TACP WITH RESPECT TO THE REPAIR OR REPLACEMENT OF ANY PARTS. IN NO EVENT SHALL TACP BE LIABLE FOR CONSEQUENTIAL OR INCIDENTAL DAMAGES (INCLUDING, BUT NOT LIMITED TO, LOST PROFITS, BUSINESS INTERRUPTION, OR MODIFICATION OR ERASURE OF RECORDED DATA CAUSED BY USE, MISUSE OR INABILITY TO USE THIS DAV PRODUCT).**

No person, agent, distributor, dealer, or company is authorized to change, modify, or extend the terms of these warranties in any manner whatsoever. The time within which an action must be commenced to enforce any obligation of TACP arising under the warranty or under any statute or law of the United States or any state thereof is hereby limited to ninety (90) days from the date you discover, or should have discovered, the defect. This limitation does not apply to implied warranties arising under state law.

**THIS WARRANTY GIVES YOU SPECIFIC LEGAL RIGHTS AND YOU MAY ALSO HAVE OTHER RIGHTS WHICH MAY VARY FROM STATE TO STATE IN THE U.S.A. SOME STATES OF THE U.S.A. DO NOT ALLOW LIMITATIONS ON HOW LONG AN IMPLIED WARRANTY LASTS, WHEN AN ACTION MAY BE BROUGHT, OR THE EXCLUSION OR LIMITATION OF INCIDENTAL OR CONSEQUENTIAL DAMAGES, SO THE ABOVE PROVISIONS MAY NOT APPLY TO YOU UNDER SUCH CIRCUMSTANCES.**

## Limited Canadian Warranty

### For Toshiba Brand Digital Audio/Video Products

Toshiba of Canada Limited ("TCL") makes the following limited warranties to original consumers in Canada. **THESE LIMITED WARRANTIES EXTEND TO THE ORIGINAL CONSUMER PURCHASER OR ANY PERSON RECEIVING THIS TOSHIBA BRAND DIGITAL AUDIO/VIDEO PRODUCT (the "DAV PRODUCT(S)" or "DAV Product(s)") AS A GIFT FROM THE ORIGINAL CONSUMER PURCHASER AND TO NO OTHER PURCHASER OR TRANSFEREE.**

**DAV PRODUCTS PURCHASED IN CANADA, AND USED ANYWHERE OUTSIDE OF CANADA INCLUDING, WITHOUT LIMITATION, THE UNITED STATES AND MEXICO, ARE NOT COVERED BY THESE WARRANTIES.**

**DAV PRODUCTS PURCHASED ANYWHERE OUTSIDE OF CANADA, INCLUDING, WITHOUT LIMITATION, THE UNITED STATES AND MEXICO, AND USED IN CANADA, ARE NOT COVERED BY THESE WARRANTIES.**

#### Limited One (1) Year Warranty on Parts and Labour

Subject to the more limited warranty if the DAV Product is used for any commercial or business purposes as set out below, TCL warrants the DAV Product and its parts against material defects in materials or workmanship that result in the DAV Product failing for a period of one (1) year after the date of original retail purchase. **DURING THIS PERIOD, TCL WILL, AT TCL'S OPTION, REPAIR OR REPLACE A DEFECTIVE PART WITH A NEW OR REFURBISHED PART, WITHOUT CHARGE TO YOU FOR PARTS OR LABOUR. YOU MUST DELIVER THE ENTIRE DAV PRODUCT TO A TCL DAV PRODUCT AUTHORIZED SERVICE PROVIDER ("ASP"). YOU MUST PAY FOR ALL TRANSPORTATION AND INSURANCE CHARGES FOR THE DAV PRODUCT TO AND FROM THE ASP.**

#### Rental Units

The warranty for DAV Product rental units begins with the date of first rental or thirty (30) days from the date of shipment to the rental firm, whichever comes first.

#### Limited Warranty for Commercial Units

TCL warrants DAV Products that are used for any commercial or business purposes as follows: all parts are warranted against material defects in materials or workmanship that result in the DAV Product failing for a period of ninety (90) days after the date of original retail purchase. **DURING THIS PERIOD, TCL WILL, AT TCL'S OPTION, REPAIR OR REPLACE A DEFECTIVE PART WITH A NEW OR REFURBISHED PART, WITHOUT CHARGE TO YOU FOR PARTS OR LABOUR. YOU MUST DELIVER THE ENTIRE DAV PRODUCT TO AN ASP. YOU MUST PAY FOR ALL TRANSPORTATION AND INSURANCE CHARGES FOR THE DAV PRODUCT TO AND FROM THE ASP.**

#### Your Responsibility

**THE ABOVE WARRANTIES ARE SUBJECT TO THE FOLLOWING CONDITIONS:**

- (1) You must provide your bill of sale or other proof of purchase.
- (2) All warranty servicing of this DAV Product must be performed by an ASP.
- (3) The warranties from TCL are effective only if the DAV Product is (i) purchased as new and unopened from TCL or from TCL's authorized distributors, dealers or resellers ("ADR's") and (ii) located/operated in Canada.
- (4) Warranties extend only to material defects in materials or workmanship as defined above, and do not extend to:
  - a. Service, repairs or replacement made necessary by accident, misuse, abuse, moisture, liquids, dust, dirt, neglect, accident, damage, 24/7 applications, improper installation, improper operation, improper cleaning, improper maintenance, normal wear and tear, or any other external cause or event, act or omission outside the control of TCL, including fire, theft, acts of God, alteration, power failures, power surges or power shortages, lightning, other electrical faults, or repairs, modifications or replacements by persons other than those authorized by TCL to service the DAV Product;
  - b. Replacement of missing, discarded or lost parts, the provision of retrofits, or preventive maintenance;

- c. Repair of damage that is cosmetic only or does not affect the DAV Product functionality, such as wear and tear, scratches and dents;
- d. Service on Toshiba-branded accessory items (such accessory items may be covered by their own warranty);
- e. Service on third party products or service made necessary by use of incompatible third party products;
- f. Service made necessary by the simultaneous use of this DAV Product and connected equipment;
- g. Modifications to the DAV Product not approved in writing by TCL, and service made necessary by the use or installation of non-Toshiba modifications to the DAV Product;
- h. Service of a DAV Product on which the TOSHIBA label or logo, rating label or serial number have been defaced or removed;
- i. On-site service and repair of the DAV Product;
- j. Damage to the DAV Product caused by failure to follow the specifications, User manuals or guides as to usage and/or storage.

#### Disclaimer and Limitation of Remedy

**TO THE EXTENT NOT PRECLUDED BY LAW, ALL OTHER EXPRESS AND IMPLIED WARRANTIES, CONDITIONS AND REPRESENTATIONS FOR THIS DAV PRODUCT, INCLUDING THE IMPLIED WARRANTIES AND CONDITIONS OF MERCHANTABILITY AND FITNESS FOR A PARTICULAR PURPOSE, ARE HEREBY DISCLAIMED AND EXCLUDED. IF THE APPLICABLE LAW, STATUTORY OR OTHERWISE, PRECLUDES THE EXCLUSION OF ANY IMPLIED WARRANTIES, CONDITIONS AND REPRESENTATIONS THEN SUCH IMPLIED WARRANTIES, CONDITIONS AND REPRESENTATIONS ARE OTHERWISE LIMITED IN DURATION TO THE TERM OF THIS EXPRESS WRITTEN LIMITED WARRANTY. TO THE EXTENT NOT PRECLUDED BY LAW, STATUTORY OR OTHERWISE, THIS WRITTEN WARRANTY SUPERCEDES AND SPECIFICALLY DISCLAIMS ANY OTHER WARRANTY, CONDITION OR REPRESENTATION NOT STATED IN THIS WARRANTY, WHETHER MADE BY TCL, TOSHIBA CORPORATION, THEIR AFFILIATES, ADRs AND ASPs AND WHETHER MADE ORALLY OR IN WRITING (INCLUDING ANY STATEMENT IN ANY BROCHURE, PRESS RELEASE, ANNOUNCEMENT, ADVERTISEMENT, POINT OF SALE DISPLAY, ETC.).**

YOU MUST READ AND FOLLOW ALL SET-UP AND USAGE INSTRUCTIONS IN THE APPLICABLE USER GUIDES AND/OR MANUALS. IF YOU FAIL TO DO SO, THIS DAV PRODUCT MAY NOT FUNCTION PROPERLY AND YOU MAY SUFFER DAMAGE. THIS WARRANTY WILL NOT COVER ANY SERVICE THAT IS REQUIRED, IN PART OR IN WHOLE, AS A RESULT OF ANY FAILURE TO FOLLOW THE SET-UP AND USAGE INSTRUCTIONS. THIS WARRANTY DOES NOT APPLY AND SHALL BE VOID AND UNENFORCEABLE IF THE DAV PRODUCT IS OPENED, SERVICED, OR REPAIRED BY PERSONS OTHER THAN THOSE AUTHORIZED BY TCL TO SERVICE OR REPAIR THE DAV PRODUCT.

# Canadian Warranty Information

IF THE DAV PRODUCT FAILS TO WORK AS WARRANTED ABOVE, YOUR SOLE AND EXCLUSIVE REMEDY SHALL BE REPAIR OR REPLACEMENT OF THE DEFECTIVE PART. IN NO EVENT WILL TCL, TOSHIBA CORPORATION, THEIR AFFILIATES, ADRs OR ASPs (THE "RELATED PARTIES") BE LIABLE TO YOU OR ANY THIRD PARTY FOR ANY DAMAGES, MONEY, REIMBURSEMENT, COSTS OR EXPENSES. THIS LIMITATION APPLIES TO DAMAGES, MONEY, REIMBURSEMENT, COSTS OR EXPENSES OF ANY KIND WHATSOEVER INCLUDING ANY DIRECT OR INDIRECT DAMAGES, DAMAGE TO PROPERTY OR PERSON, LOST PROFITS, LOST SAVINGS, INCONVENIENCE OR OTHER SPECIAL, INCIDENTAL, EXEMPLARY OR CONSEQUENTIAL DAMAGES, WHETHER FOR BREACH OF WARRANTY, BREACH OF CONTRACT, TORT (INCLUDING NEGLIGENCE), UNDER A STATUTE OR UNDER ANY OTHER LAW OR FORM OR ACTION, OR WHETHER ARISING OUT OF THE USE OF OR INABILITY TO USE THE DAV PRODUCT, EVEN IF ANY OF THE RELATED PARTIES HAS BEEN ADVISED OF THE POSSIBILITY OF SUCH DAMAGES OR OF ANY CLAIM BY ANY OTHER PARTY.

No person, agent, distributor, dealer or company is authorized to change, modify or extend the terms of these warranties in any manner whatsoever.

## Arbitration and Dispute Resolution

To the extent not precluded by law, any claim, dispute, controversy or disagreement (whether for breach of warranty, breach of contract, tort (including negligence), under a statute or under any other law or form of action) against any of the Related Parties arising out of, or otherwise relating to: (i) this warranty; (ii) the DAV Product; (iii) any oral or written representations, statements, brochures, press releases, advertising, announcement, point of sale display, or promotional material relating to the DAV Product; (iv) the relationships that result from this warranty, (the foregoing claims, disputes controversies and disagreements are collectively referred to as the "Dispute"), shall be referred to and resolved by final and binding arbitration (to the exclusion of the courts). To the extent not precluded by law, you agree to waive any right that you may have to commence or participate in any representative or class proceeding against the Related Parties relating to any Dispute. If and where applicable and to the extent not precluded by law, you further agree to opt out of any such representative or class proceedings. Arbitration of any Dispute will be conducted in the forum and in the manner as agreed to between you and TCL. Failing such agreement, the arbitration will be conducted by one arbitrator pursuant to the laws and rules relating to arbitration generally in force in the jurisdiction in which you reside at the time that the Dispute arises. To the extent not precluded by law, no claim, dispute, controversy or disagreement of any other person may be joined or combined with any Dispute by you, without the prior written consent of TCL.

## Critical Applications

The DAV Product you have purchased is not designed for any "critical applications." "Critical applications" means life support systems, medical applications, connections to implanted medical devices, commercial transportation, nuclear facilities or systems or any other applications where DAV Product failure could lead to injury to persons or loss of life or catastrophic property damage.

IF THE CUSTOMER USES THE DAV PRODUCT IN ANY CRITICAL APPLICATION, THE CUSTOMER – AND NOT TCL, ITS AFFILIATES, ADRs OR ASPs – ASSUME SOLE AND FULL RESPONSIBILITY FOR SUCH USE. TCL RESERVES THE RIGHT TO REFUSE TO SERVICE ANY DAV PRODUCT USED IN A CRITICAL APPLICATION. TCL, ITS AFFILIATES, ADRs AND ASPs HEREBY DISCLAIM ANY AND ALL LIABILITY, DAMAGES AND CONSEQUENCES ARISING OUT OF THE SERVICE OR REFUSAL TO SERVICE SUCH DAV PRODUCT AND FURTHER DISCLAIM ANY AND ALL LIABILITY, CONSEQUENCES AND DAMAGES THAT MAY ARISE OR RESULT FROM THE USE OF THE DAV PRODUCT IN ANY CRITICAL APPLICATIONS.

## General Provisions

If and to the extent that any provision of this limited warranty should generally be found to be unenforceable, the unenforceable provision shall be severed from the warranty and deemed not to form part of the warranty. The remaining provisions of this warranty shall be and remain valid and enforceable. If and to the extent that any provision of this limited warranty as it relates to any of the Related Parties is found to be invalid or unenforceable in respect of that party (the "Excluded Party"), the Excluded Party shall be deemed to be severed or excluded from the provision, and the provision shall remain valid, enforceable and applicable in respect of the other or remaining Related Parties.

To the extent permitted by law, this limited warranty shall be governed and construed in accordance with the laws of Ontario.

If there is any inconsistency between this limited warranty, on the one hand, and any statement in the packaging of the DAV Product or in any other document enclosed with, or used in the context of the promotion or sale of, the DAV Product, on the other hand, the provisions of this limited warranty shall prevail.

## How to Obtain Warranty Services

If, after following all of the operating instructions in this manual and checking the "Troubleshooting" section, you find that service is needed:

- (1) To find the nearest ASP, visit TCL's web site at [www.toshiba.ca](http://www.toshiba.ca), or call toll free 1-800-268-3404.
- (2) Present your bill of sale or other proof of purchase to the ASP

For additional information, visit TCL's website at [www.toshiba.ca](http://www.toshiba.ca)

## Free Manuals Download Website

<http://myh66.com>

<http://usermanuals.us>

<http://www.somanuals.com>

<http://www.4manuals.cc>

<http://www.manual-lib.com>

<http://www.404manual.com>

<http://www.luxmanual.com>

<http://aubethermostatmanual.com>

Golf course search by state

<http://golfingnear.com>

Email search by domain

<http://emailbydomain.com>

Auto manuals search

<http://auto.somanuals.com>

TV manuals search

<http://tv.somanuals.com>