

TEC

TEC Electronic Cash Register

FDS-50

Owner's Manual

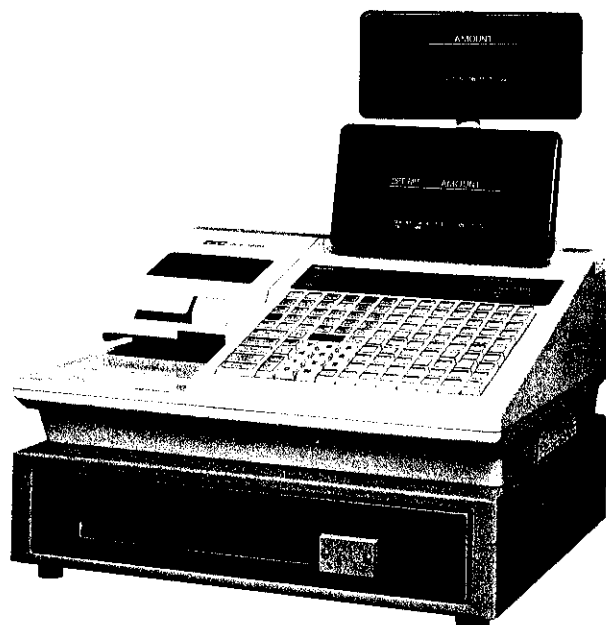

TOKYO ELECTRIC CO., LTD.

OPERATOR'S GUIDE

TABLE OF CONTENTS

<i>Chapter No.</i>	<i>page</i>
1. TO OUR CUSTOMERS	1
2. PRECAUTIONS	1
3. APPEARANCE AND NOMENCLATURE	2
4. CONTROL LOCKS AND MODE SELECTOR KEYS	3
5. DISPLAY	6
6. KEYBOARD LAYOUT	10
7. FUNCTIONS OF EACH KEY	12
8. SYSTEM TYPE VARIATIONS AND OPERATION FLOWS	15
9. REGISTERING PROCEDURES	18
10. POWER FAILURE PROCESS	70
11. JOURNAL AND RECEIPT PAPER-END DETECTOR	70
12. PRINTER MOTOR LOCK DETECTOR	70
13. PAPER ROLL REPLACEMENT AND OTHER MAINTENANCE OPERATIONS	71
14. SPECIFICATIONS	75
15. -- INDEX --	76

1. TO OUR CUSTOMERS

Thank you for choosing the TEC electronic cash register FDS-50 series. This instruction manual provides a description of the functions and handling of this register and should be read carefully to ensure optimum performance. Since every consideration has been given to safety and reliability, there is no danger of damaging the machine by incorrect operation.

Please refer to this manual whenever you have any questions concerning the machine. This machine has been manufactured under strict quality control and should give you full satisfaction. However, if the machine is damaged during transit, or there are any unclear points in this manual, please contact your local TEC representative.

- The specifications described in this manual may be modified by TEC, if necessary.
- Be sure to keep this manual available for future reference.

2. PRECAUTIONS

The ECR is a precision machine. Please handle it carefully considering the following guidelines.

REMARKS ON THE LOCATION

- Place it where no unusual temperature changes are expected.
- Place it on a flat and level surface with little dust, humidity, vibration, etc.
- Keep it away from water sources.
- Do not use it in direct sunlight for a long time.
- Ensure proper ventilation so that the machine is not exposed to excessive heat.
- Be certain to connect a grounding wire to prevent the generation of static electricity and noise troubles. Never share the same power outlet with many other electric appliances.

REMARKS ON OPERATING THE ECR

- The keys on the keyboard function with a light touch. Avoid pressing the keys too hard.
- Do not handle the machine with wet hands, since this may cause electrical malfunctions and corrosion of parts.
- Do not apply thinner, benzine, or other volatile materials to the cabinet or other plastic parts. Such liquids will cause discoloration or deterioration of the cover. If dirty, wipe off with a piece of cloth soaked in a neutral detergent and wrung out thoroughly.
- Turn off the power switch when the operations are over for the day.
- Ask your TEC representative to provide periodical maintenance to ensure the optimum performance of the machine.
- As for other operations, follow the instructions in this manual.

3. APPEARANCE AND NOMENCLATURE

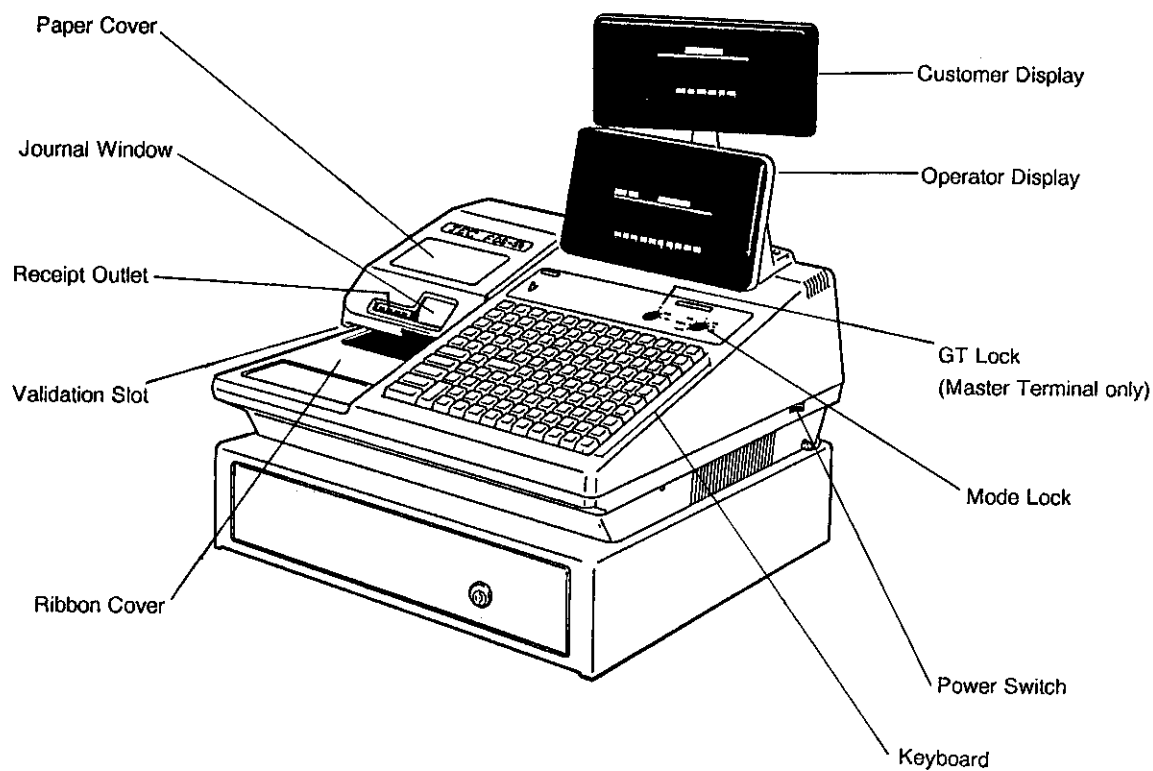

- Power Switch:** The power switch is located on the righthand side of the cabinet. The AC Power is turned on when the switch is pushed to ON, and turned off when the switch is pushed to OFF.

4. CONTROL LOCKS AND MODE SELECTOR KEYS

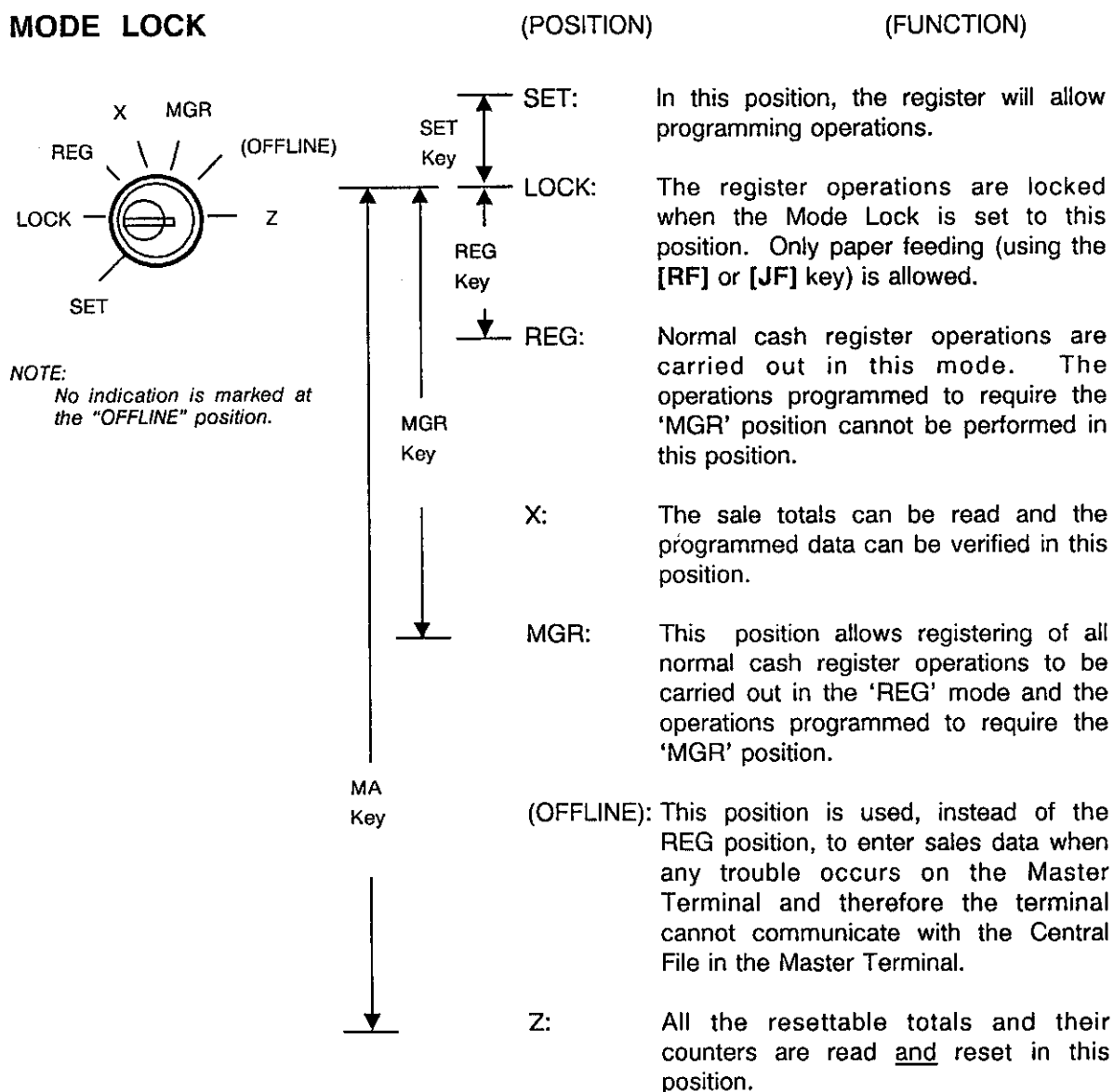

NOTE:
No indication is marked at the "OFFLINE" position.

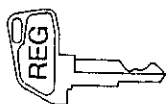

REG Key: The REG Key is used by the cashier who operates the register. This key can access the positions of **LOCK** and **REG**.



MGR Key: The MGR Key is used by the manager or a person authorized by the manager. This key can access the positions of **LOCK**, **REG**, **X**, and **MGR**.

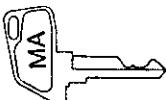

MA Key: The MA Key is used by the manager who will daily supervise the collection of money and the printout of transactions recorded by the register. This key can access the positions of **LOCK**, **REG**, **X**, **MGR**, **OFFLINE**, and **Z**.

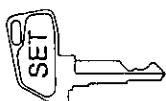

SET Key: The SET Key is used by the programmer. This key can access the positions of **LOCK** and **SET**.

All the keys can be removed from the **OFF** or **REG** position.

GT LOCK (on Master Terminal only)

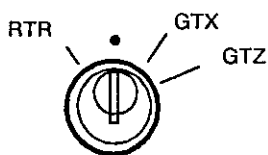

This lock is provided to read or reset the accumulated sales not on a daily basis but on a weekly or monthly basis.

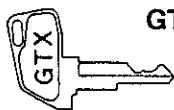

GTX Position: This position can be accessed by the **GTX Key** or **GTZ Key**, and allows to issue GTX reports of consolidated data of the terminals connected to the in-line loop.

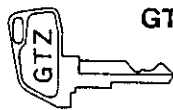

GTZ Position: This position can be accessed by the **GTZ Key**, and allows to issue GTZ reports of consolidated data of the terminals connected to the in-line loop.

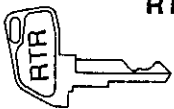

RTR Position: This position can be accessed by the **RTR Key**, and allows to operate in-line service jobs such as reports, Down Line Loadings, etc.

The keys can be removed and inserted in the neutral position which is marked with a dot.

CASHIER LOCKS (option)

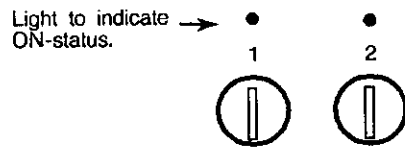

These locks are provided as option, to identify the operating cashier. Each of the keys can be inserted and pulled out in the neutral position marked with a No., and two ways are provided to set the Cashier Lock ON status:

1. PUSH-ON

When simply pushed on and immediately released, the Cashier Lock is set to ON status. However, this ON condition will be cleared automatically cleared when the following transaction is finalized.

2. PUSH-AND-LOCK

When pushed and turned to the right, the ON status is locked until it is turned back, released, and the other Cashier Lock is set to ON.

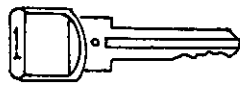

As for cashier/server Sign-ON/OFF operations, see Chapter 9.

RECEIPT ON/OFF SWITCH

RECEIPT



This key has two positions, OFF and ON. When in the OFF position, receipts are not issued from the register and sales are printed on the journal roll only. When the switch is set to the ON position, sales are printed on both the receipt roll and journal roll. (Applicable when the entered data is to be printed on the receipt roll.)

This switch position selection does not affect any printing on Remote Kitchen Printers or Guest Check Printer.

If the **[POST RECEIPT]** key is installed on the keyboard, a receipt can be issued even when the RECEIPT ON/OFF SWITCH is in the OFF position. (See the **Post Receipt** description in Chapter 9.)

5. DISPLAY

A tilt type is adopted for the operator display, which is adjustable in the up and down direction. The entered amounts and the obtained total are easy to see.

OPERATOR DISPLAY (Front Display)

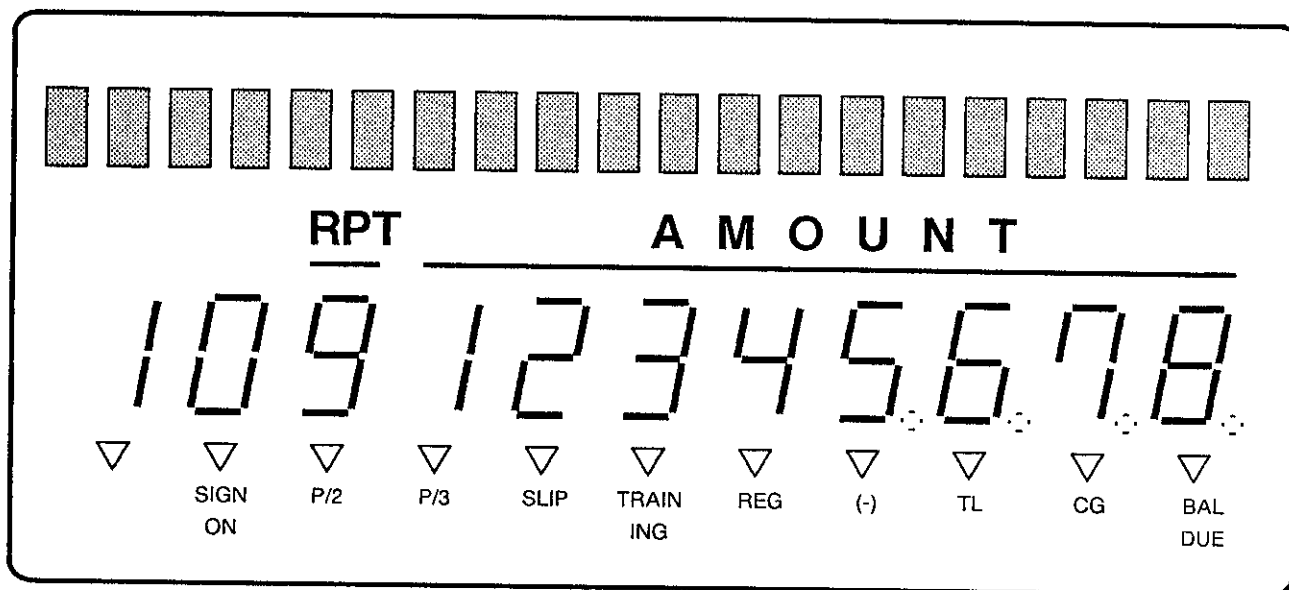

The customer display can be fixed as a rear display or moved to form a remote display. It can be moved up, down, to the right, and to the left, and thus is fully adjustable according to the position of the customer.

CUSTOMER DISPLAY (Rear or Remote Display)

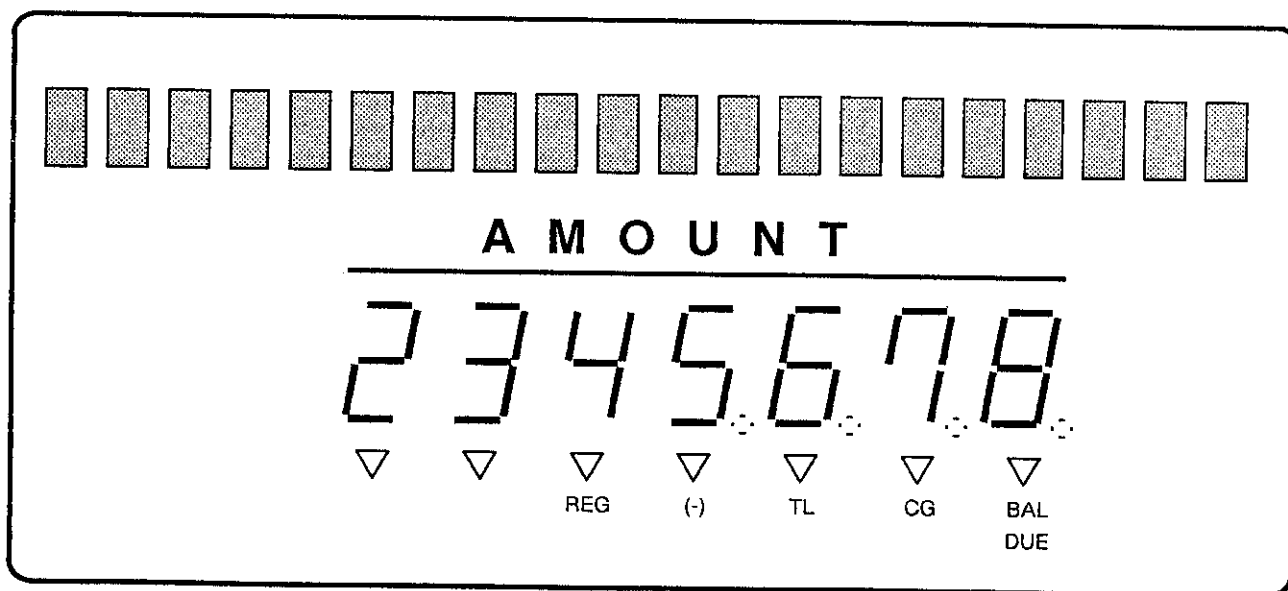

NOTE: The upper row (20-digit dot windows) is a hardware option.

5-1 UPPER ROW (20-digit dot windows)

Alphanumeric characters are displayed here as messages, order item descriptors, prompts for the operator, etc. depending on the Mode Lock position and the operation sequence.

(1) Mode Indications

"LOCK" Mode

If the display message is programmed, the message is displayed, scrolling from the right to the left. A maximum of 60 characters can be programmed as the display message for the purposes of commercial information, welcoming greetings, etc. At the same time the current time is displayed in the lowest 5 digits of the Lower Row (example: 14:52 for the time 14:52).

"REG", "MGR", or "OFFLINE" Mode Initial Display

Nothing is displayed as initial display.

Other Mode Initial Display

The mode symbol of 1 to 3 characters are displayed in the lowest 3 digits:

	4	3	2	1	← Digit No.
"SET" Mode:		<input type="checkbox"/>	<input type="checkbox"/>	<input type="checkbox"/>	P	
"X" Mode:		<input type="checkbox"/>	<input type="checkbox"/>	<input type="checkbox"/>	X	
"Z" Mode:		<input type="checkbox"/>	<input type="checkbox"/>	<input type="checkbox"/>	Z	
"GTX" Mode:		<input type="checkbox"/>	G	T	X	
"GTZ" Mode:		<input type="checkbox"/>	G	T	Z	

(2) Descriptors of Various Sales Items ("REG", "MGR", "OFFLINE")

The descriptor (name) programmed for each menu item, transaction item, etc. is displayed as the item is entered on the keyboard.

(3) Error Messages (in any mode except "LOCK")

When an error occurs, a 2-digit error code and its message (programmable) are displayed, with an error buzzer (a long tone).

Read the Error Code or the Error Message, depress the [C] key to cancel the error status and tone, operate the sequence again after removing the cause of the error.

The following table shows the cause of the error corresponding to each Error Code. Fill in the actual content for the Error Message programmed for your terminal. (The manager should have the information.)

ERROR CODE AND MESSAGE TABLE

Error Code	Error Message	Content or Cause of Error
01		Operation error
02		Operation locked
03		Illegal programming
04		Incorrect code entry
06		Numeric entry overflow
07		Numeric entry inhibit error
08		Numeric entry compulsory error
09		Manager intervention required
10		Validation required
11		Validation operation error
12		Drawer -close compulsory
14		Code entry compulsory error
16		Scale entry compulsory error
17		Scale operation error
18		Scale time-out error
20		Guest Check insertion required
21		Guest Check removal required
22		Remote Kitchen Printer busy
23		Remote Kitchen Printer off-line
24		Remote Kitchen Printer hardware error
25		Server # required
26		Check # required
27		Guest # required
28		Table # required
29		Operator busy
30		Sign ON required
31		Incorrect operator code
32		Previous Balance file busy
33		Previous Balance file full
34		Incorrect Check #
35		Check Transfer operation
36		Communication error
37		Time-Out Error (on Satellite Terminals)
38		Transmission Error (on Satellite Terminals)
39		The server still has outstanding checks.
40		Power Failure occurred (See Chapter 10.)

It is recommended to prepare a copy of the above table after filling in the messages, and place it near the register.

5-2 LOWER ROW (11-digit 7-segment Numeric Display and 11 Triangular Lamps)

Numeric Display

- AMOUNT** (8 digits) Displays the numeric data, such as amount, quantity, etc.
- RPT** (1 digit) Displays the repeat count. It indicates nothing on the first item entry, showing 2, 3, 4, etc., from the second item entry on. Since it has only one digit, 0 will be displayed for count 10, 1 for 11, etc.

Triangular Lamps

- SIGN ON** This lamp lights when a Cashier or Server has signed on (and a cashier or server has entered his/her code if so required), indicating that a sale entries are now allowed.
- P/2** This lamp lights when the prices of Menu Items has been shifted to Price 2 by operating the **[PRICE SHIFT]** key.
- P/3** This lamp lights when the prices of Menu Items has been shifted to Price 3 by operating the **[PRICE SHIFT]** key.
- SLIP** Flickers when a validation slip is required to be inserted to the Validation Slot. It is steadily lit when a validation slip is properly set.
- TRAINING** Lights up in the Training Mode.
- REG** Lights up in the REG or MGR mode when a sale item has been entered and goes out when the sale has been finalized.
- (-)** Lights up when an item of negative amount has been entered. It flickers when the Mode Lock is turned to the OFFLINE position, indicating that the operations are performed in the OFF-LINE condition.
- TL** Lights up when any operation to obtain the total of the entered items has been performed, indicating that the displayed amount is the total. It goes out when another motorized key is depressed.
- CG** When an amount tendering operation is performed, it lights up with the change due displayed (including cases when the change due is zero). It goes out when another motorized key is depressed.
- BAL DUE** Lights up when an amount tendered is short, indicating that the amount displayed is the balance due.

6. KEYBOARD LAYOUT

The following are typical keyboard layouts for the FDS-50 series. Since this series is designed to be capable of programming most of the keys in the most desired location on the keyboard, these are merely examples. The keyboard of your register should have its own layout according to the store's requirements.

-- Flat Keyboard Type -- (standard feature)

RECEIPT



										SIGN ON/OFF	RF	JF
										PRICE SHIFT	PO	R/A
										#	VALID DATE	NS
										CHECK COMB.	CHECK TRANS	TIPS PAID
										VOID CHECK	SERVICE ADJUST	CHARGE TIP
										DISC ITEM	DISC	COUPON
							ITEM #	VOID	ITEM CORR	SERVICE CHARGE	GIFT CERT	TX EX
							AMOUNT	TX1/M	TX2/M	PR OPEN	HOUSE CHARGE	TAB CASH
							NEW CHECK	C		@/FOR	PB	
							GUEST #	7	8	9	CHECK PAID	
							TABLE #	4	5	6	CASH	
							SERVER #	1	2	3	CREDIT CARD	
								0	00	ST	TOTAL	

Other keys that can be installed in addition to the keys in the above figure:
 See the description below the "Ordinary Keyboard Type" on the next page.

RECEIPT

-- Ordinary Keyboard Type -- (alternative option)

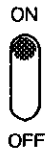

RF	JF	SIGN ON/OFF	PRICE SHIFT	PO	R/A							
CHECK COMB.	CHECK TRANS	TIPS PAID	#	VALID DATE	NS							
VOID CHECK	SERVICE ADJUST	CHARGE TIP	DISC ITEM	DISC	COUPON							
GIFT CERT	TX EX	ITEM #	VOID	ITEM CORR	SERVICE CHARGE							
HOUSE CHARGE	TAB CASH	AMOUNT	TX1/M	TX2/M	PR OPEN							
PB	NEW CHECK	C		@/FOR								
CHECK PAID	GUEST #	7	8	9								
CASH	TABLE #	4	5	6								
CREDIT CARD	SERVER #	1	2	3								
TOTAL		0	00	ST								

Other keys that can be installed in addition to the keys in the above figure:

- [POST RECEIPT]
- [TX3/M]
- [TXBL TL]
- [TAX]
- [PRESET OPEN]
- [SCALE]
- [TARE]
- [LINE #]
- [CLEAR TRAN]
- [TRAY TOTAL]
- [FUNCTION]

Additional Non-cash Media Keys

(besides [CREDIT CARD], [GIFT CERT], & [HOUSE CHARGE])

Additional %-/COUPON Keys

(besides [COUPON], [DISC], & [DISC ITEM])

Additional Received-on-Account Keys (besides [R/A])

The keys other than these function keys are usually used as Code-preset Menu Item Keys.

7. FUNCTIONS OF EACH KEY

This section briefly describes functions of each key for your quick reference purposes. See the reference pages in Section 9: REGISTERING PROCEDURE for detail operation sequences.

TABLE OF KEY FUNCTIONS

KEY	FUNCTIONS	REFERENCE PAGE
Numeric Keys [0] to [9], [00]	Used to enter numeric values. Depressing the [00] key once is the same as depressing the [0] key twice consecutively.	
[RF]	Receipt Feed Key. Used to advance the receipt roll and operated by holding it down until the paper has advanced to the required position.	
[JF]	Journal Feed Key. Used to advance the journal roll in the same fashion as the [RF] key is used to receipt roll.	
Menu Item Keys	These keys are often referred to [Code-preset Menu] keys in the following chapters. Each of them has its own Item Code preset and allows the item entry by one-touch depression of the key.	33
[ITEM #]	Used to enter menu items by Item Code entries.	33
[RETURN]	Used to enter returned items in Non-tab Mode.	41
[ITEM CORR]	Item Correct Key. Used to delete the last line item entered within the current transaction.	39
[VOID]	Used to delete a menu item entered previously in the current transaction or guest check.	40
[SERVICE ADJUST]	Used to enter a refund amount to adjust a guest check total before finalizing the check.	48
[CASH]	This is the cash media key to finalize a transaction or guest check for payment.	31
Non-cash Media Keys	A maximum of 9 non-cash media keys can be installed and used to finalize a transaction or guest check for non-cash payment. The [CREDIT CARD], [HOUSE CHARGE], and [GIFT CERT] keys on the sample keyboards in the preceding sections are examples of such keys.	31
[ST]	Subtotal Key. Used to obtain subtotal of the current transaction. It can be programmed to display taxable total amount.	51
[TXBL TL]	Taxable Total Key. Used to obtain taxable total (subtotal + taxes) of the current transaction. When the [ST] key is programmed to display taxable total, this key is not necessary.	51
[VALIDATE]	Validation Key. Used to print a required item entry on a validation slip.	56

TABLE OF KEY FUNCTIONS (continued)

KEY	FUNCTIONS	REFERENCE PAGE
[#]	Non-add Number Print Key. Used to print a non-add numbers for future references.	55
[PR OPEN]	Preset Open Key. Used to release a preset-price menu items for a manual price entry.	34
[AMOUNT]	Amount Key. Used to enter a manual amount of a menu item.	33
[@/FOR]	At/For Key. Used to multiply a menu item entry by a quantity. It is also used to enter a Purchased Quantity and a Whole Package Quantity in a Split Package Pricing sequence.	34
[POST RECEIPT]	Used to issue a post receipt of the last transaction finalized.	57
[C]	Clear Key. Used to clear numeric entries, to cancel an error status, etc.	
[TX1/M], [TX2/M], [TX3/M]	Tax Modifier Keys. Used to reverse the taxable/non-taxable status of menu items or function keys. The keys correspond to Tax 1, Tax 2, Tax 3 tables respectively. They are also used to exempt a transaction from a specific tax, along with a use of the [TX EX] key.	52, 53
[TAX]	Manual Tax Key. Used to enter a tax amount not charged by automatic tax calculation.	52
[TX EX]	Tax Exempt Key. Used to exempt a transaction from taxes.	53
[PB]	Previous Balance Key. Used to pick up the previous balance of the guest check in an additional order entry sequence.	28
[SCALE]	Scale Key. Used to enter the weight of a menu item from the sale automatically or to enter a pre-weighed menu item manually.	35
[TARE]	Tare Key. Used to enter a Tare Table Code to specify the tare subtraction amount from an auto-scale item entry.	35
%-/COUPON Keys	A maximum of 5 keys can be installed. Each key can be programmed as %- key or Coupon (or Dollar Discount) key. On the typical keyboards in the preceding chapter, [DISC], [COUPON], and [DISC ITEM] are examples of these keys.	44
[SIGN ON/OFF]	Used for each operator's sign ON and sign OFF entries.	20, 21
[TIP PAID]	Used to enter a cash tip amount in transactions in Tab Mode.	46
[CHARGE TIP]	Used to enter a tip amount paid in a non-cash media in Tab Mode.	47
[SERVER #]	Used to enter the code of the server or cashier who is responsible of the transaction.	22, 23

TABLE OF KEY FUNCTIONS (continued)

KEY	FUNCTIONS	REFERENCE PAGE
[TABLE #]	Used to enter the Table No. of a guest party.	27
[GUEST #]	Used to enter the number of guests in a party.	27
[TRAY TOTAL]	Used to obtain the total of an individual guest tray in a guest party. Used in Non-tab Mode only.	54
[TAB CASH]	Tab/Cash Mode Change Key. Used to change the original mode of the terminal for one transaction only.	55
[CLEAR TRAN]	Clear Transaction Key. Used to clear the entire data already entered in the current transaction.	42
[VOID CHECK]	Used to clear the entire guest check data in Tab Mode.	43
[FUNCTION]	Used to designate Function Tables 1 to 10, each of which is programmed with a maximum of 10 key entry sequences often used as daily business routines.	62
[PRICE SHIFT]	Used to shift prices of menu items. (A maximum of three prices can be preset for each menu items.)	37
[SERVICE CHARGE]	Used to add a service or table charge rate to a guest check in Tab Mode.	45
[TOTAL]	Used to finalize menu items for order and obtain the total, and at the same time, transfer the balance.	29
[NEW CHECK]	Used to open a check for a new guest party in Tab Mode.	27
[CHECK TRANSFER]	Used to change the Server, Table, and/or Number of Guests of a check already opened.	49
[CHECK COMBINE]	Used to merge two different checks into one.	50
[CHECK PAID]	Used to declare closing of a guest check and go on to media entries for payment.	30
[LINE No.]	Used, in the OFF-LINE mode, to enter the number of printed lines for accessing the appropriate position to print additional data on a guest check.	OFF-LINE Mode, Manger's Guide
[NS]	No-sale Key. Used to open the cash drawer without relating to a sale.	59
[R/A] 1 to 4	Received-on-Account Keys. A maximum of 4 keys can be installed. Used to enter payments received on account, i.e. not relating to business.	60
[PO]	Paid-Out Key. Used to record amounts paid out of the cash drawer not relating to a sale.	61

8. SYSTEM TYPE VARIATIONS AND OPERATION FLOWS

The FDS-50 terminal can be programmed to one of the following three types in the aspect of the store environments. Combining these different types in one in-line system is also possible.

TYPE 1: NON-TAB MODE (Cash Mode)

This type is used for cafeterias, concession stands, etc. where cashiers are responsible of sales entry operations and the entries are immediately finalized for payment.

– OPERATION FLOW –

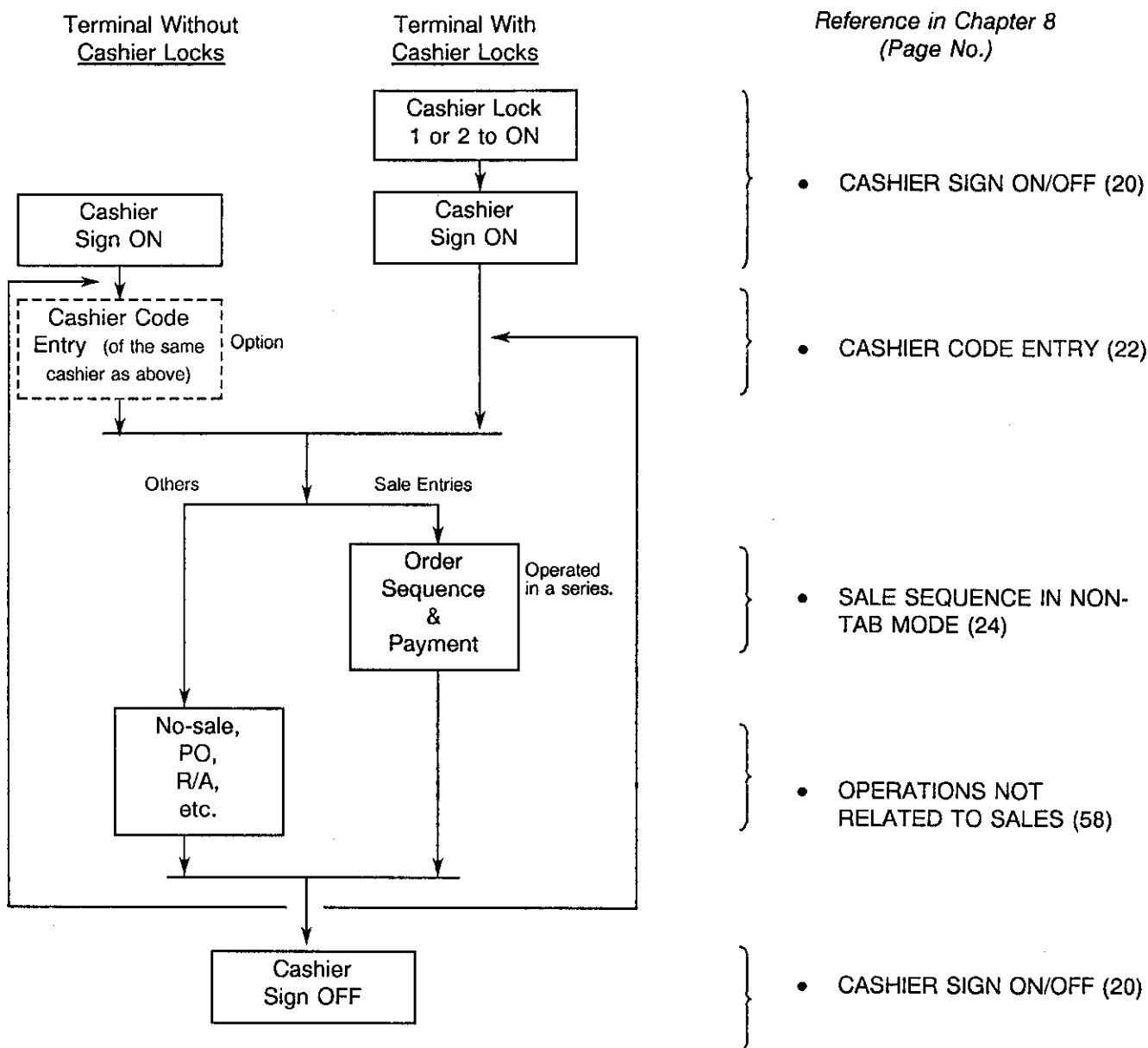

TYPE 2: TAB MODE 1 (Server-Cashier System)

This type is used for full-service restaurants where servers are responsible of order entry operations and cashiers are responsible of check payment operations.

-- OPERATION FLOW --

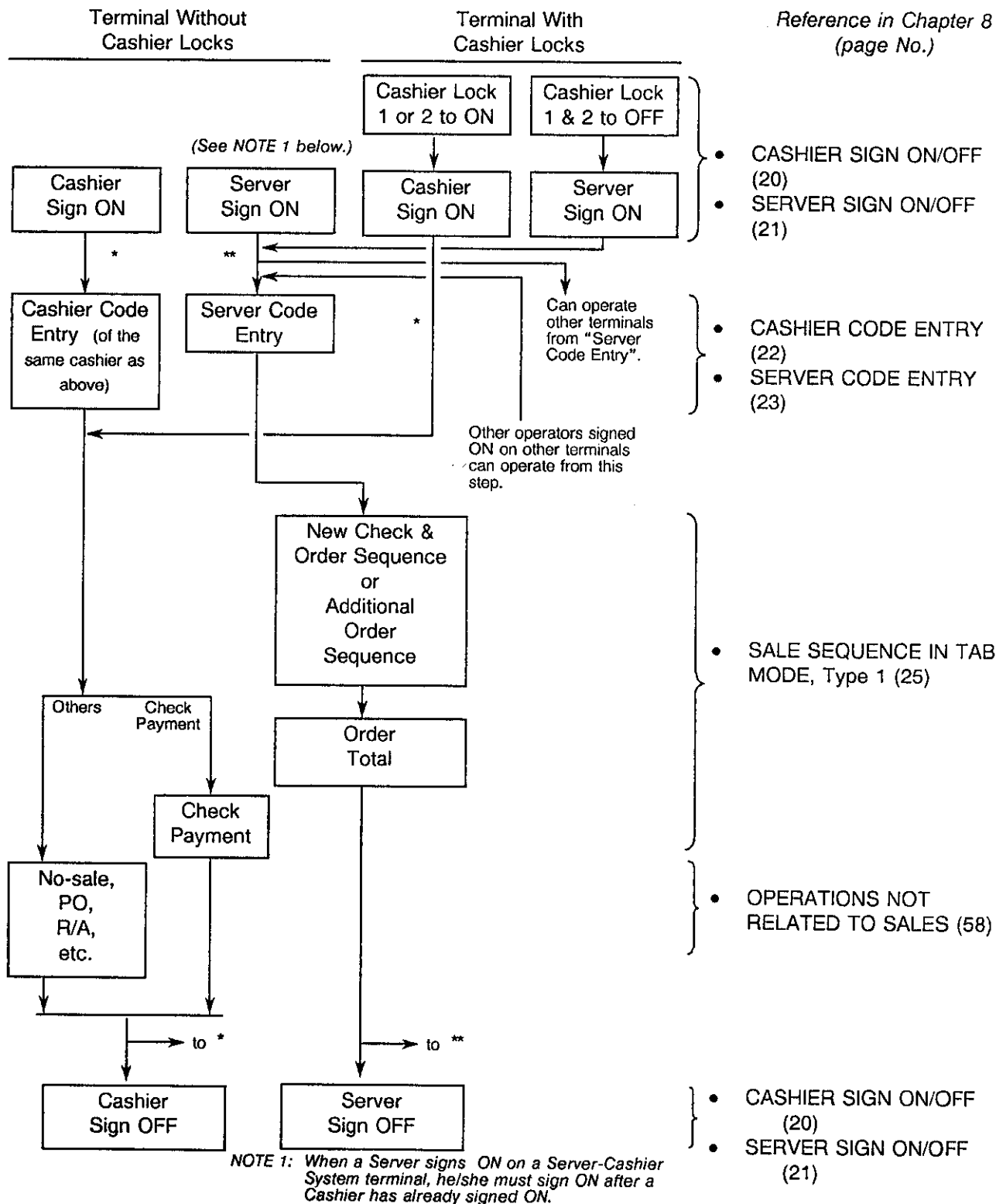

TYPE 3: TAB MODE 2 (Server/Banking System)

This type is used for full-service restaurants where each server is responsible of both order entry and check payment operations.

-- OPERATION FLOW --

Reference in Chapter 8
(page No.)

For this type, Cashier Locks
are not necessary.

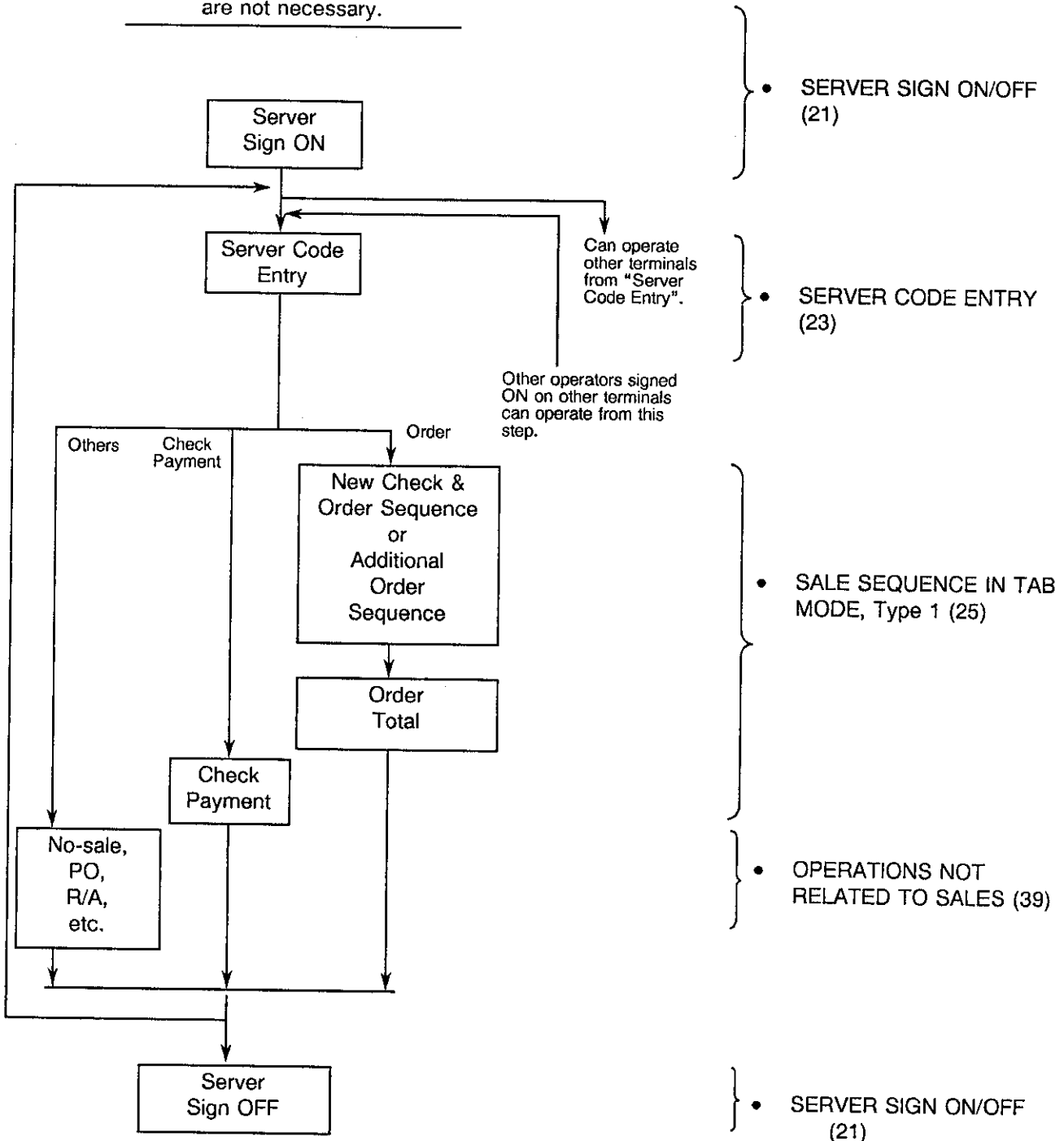

9. REGISTERING PROCEDURES

9-1 PREPARATION FOR REGISTERING OPERATIONS

The following are registering operation patterns and actual operation samples. In the patterns, "[]" indicates an input through the numeric keys, "[]" indicates a depression of the transaction key, and "---" indicates other registering and/or finalizing operations. In referring to the sample operations, please note that the programmed data on some keys or items (such as individual menu items) may be different from those programmed for your store.

For the following operations, set the keylocks to the appropriate positions:

GT LOCK (on Master Terminal only): Neutral Position marked with a dot.

MODE LOCK: REG

Most of the operations can be entered in this position. However, when "E09" errors occur without your key-in mistakes after any of the following operations, it means that the operation is programmed to require Manager Intervention. In this case, depress the [C] key to cancel the error status and call for the store manager. Then the manager turns the Mode Lock to the MGR position with an appropriate key to allow the operation.

%-/COUPON Keys (such as [DISC], [COUPON])
 [RETURN]
 [VOID]
 [PO] (Paid-Out)
 [R/A] (Received-on-Account)
 [CHARGE TIP]
 [TIP PAID]
 [SERVICE ADJUST]
 [SERVICE CHARGE]
 [CLEAR TRAN] (Clear Transaction)
 [CHECK TRANS] (Check Transfer)
 [VOID CHECK]
 [TX EX] (Tax Exempt)
 [TAX] (Manual Tax)
 [PRICE SHIFT]
 [SIGN ON/OFF]
 [NS] (No-sale)
Over-subtraction of the sale total using:
 [RETURN] or [VOID], or
 Other negative amount keys
Negative Balance Sale Payment

When an "E06" error occurs, you may have entered an amount through a key exceeding the programmed limit. Manager Intervention may be required.

A TRAINING MODE IS AVAILABLE ON THIS REGISTER

If you are a beginner in operating this register, ask your manager to allot some time to train you in the Training Mode.

9-2 REGISTERING OPERATIONS

TABLE OF CONTENTS

<u>OPERATION</u>	<u>PAGE</u>
CASHIER SIGN ON/OFF	20
SERVER SIGN ON/OFF	21
CASHIER CODE ENTRY	22
SERVER CODE ENTRY	23
SALE SEQUENCE IN NON-TAB MODE	24
SALE SEQUENCE IN TAB MODE (Server-Cashier System or Server/Banking System)	25
New Check	27
Additional Order	28
Order Total (Balance Transfer)	29
Check Finalization (Check Paid)	30
Media Entries (Payment)	31
MENU ITEM ENTRIES	33
Individual Menu Item	33
Repeat Entry	34
Quantity Extension	34
Split Package Pricing	34
Scale Item Entry	35
Modifier Entry	36
Set Menu Entry	37
Price Shift	37
Preset Price Open Entry	38
OPERATIONS RELATED TO ORDER OR PAYMENT	39
Item Correct	39
Void	40
Return	41
Clear Transaction	42
Void Check	43
%-, Dollar Discount, Coupon	44
Service Charge (% +)	45
Tip Paid	46
Charge Tip	47
Service Adjust	48
Check Transfer	49
Check Combine	50
Subtotal, Taxable Total	51
Tax Status Modification	52
Manual Tax Entry	52
Tax Exempt	53
Tray Total	54
Non-add Number Print	55
TAB/CASH Mode Change	55
Validation Print	56
Post Receipt	57
OPERATIONS NOT RELATED TO SALES	58
No-sale	59
Received-on-Account	60
Paid-Out	61
KEY STRINGS USING THE [FUNCTION] KEY	62
GUEST CHECK PRINTER (GCP)	63
REMOTE KITCHEN PRINTER (RKP)	66

CASHIER SIGN ON/OFF

In the Non-tab Mode (Type 1) or the Server-Cashier System (Type 2), a sign-ON of the cashier is required for operations in the REG or MGR position of the Mode Lock. By signing ON, the cashier is responsible of the terminal until he/she signs OFF on the same terminal. Unlike a sign-ON of a server (to be described on the next page), a cashier once signed ON on a terminal cannot operate another terminal until he/she signs OFF on the first terminal and signs ON again on the second terminal. Signing ON or OFF of a cashier is not possible on a terminal in the Server/Banking System (Type 3) because the terminal can only be used by servers (i.e. operators programmed as servers).

OPERATION (must be operated outside a sale)

SIGN ON

SIGN OFF

On Non-tab Mode Terminal

Without Cashier Locks: Cashier Code [SIGN ON/OFF]
 (see the details below)

0 [SIGN ON/OFF]
 0 (zero) is fixed for Sign OFF.

With Cashier Locks: Cashier Lock 1 or 2 to ON.
 (See NOTE 1 below.)
 ↓
Cashier Code [SIGN ON/OFF]

0 [SIGN ON/OFF]

On Server-Cashier System Terminal

Without Cashier Locks: Cashier Code [SIGN ON/OFF]

Same as Sign ON

With Cashier Locks: Cashier Lock 1 or 2 to ON.
 (See NOTE 1 below.)
 ↓
Cashier Code [SIGN ON/OFF]

0 [SIGN ON/OFF]

Composition of a "Cashier Code":

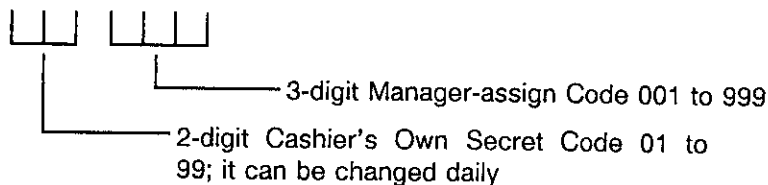

This 5-digit code will also be used for "CASHIER CODE" entry. The code being entered on the terminal will not be displayed.

- NOTES** 1. When Cashier Locks are installed, a maximum of two cashiers can sign ON on a terminal at a time. To sign OFF, the Cashier Lock of the Cashier must be in the ON condition for operating 0 [SIGN ON/OFF]. A cashier once signed ON can turn OFF the Cashier Lock to allow the other cashier's sign ON or operations. Either of the cashiers already signed ON simply turns ON his/her own Cashier Lock ON for operating his/her jobs. Two drawers can be installed with the Cashier Locks; in this case, Cashier Lock 1 is assigned to Drawer 1 and Cashier Lock 2 to Drawer 2.

SERVER SIGN ON/OFF

In the Server-Cashier System (Type 2) and the Server/Banking System (Type 3), a sign-ON of the server is required for operations in the REG or MGR position of the Mode Lock. By signing ON, the server can operate any terminal in either of the two systems above until he/she signs OFF. Signing ON or OFF of a server is not possible on a terminal in the Non-tab Mode System (Type 1) because the terminal only allows operations by cashiers (i.e. operators programmed as cashiers). A server with outstanding checks remaining cannot sign OFF (an "E39" error results).

OPERATION (must be operated outside a sale)

SIGN ON

SIGN OFF

Server Code [SIGN ON/OFF] Same as Sign ON
 (see the details below)

NOTE: On a Server-Cashier System terminal, a server Sign-ON or Sign-OFF must be operated in a cashier signed-ON condition. When the cashier has already signed OFF on such a terminal, no server operations are accepted.

Composition of a "Server Code":

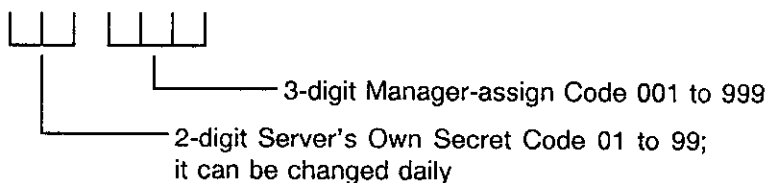

This 5-digit code will also be used for "SERVER CODE" entry. The code being entered on the terminal will not be displayed.

-- Sign ON/OFF Receipt Samples (The print form is common for Cashiers and Servers.) --

```

RESTAURANT TEC
1234 PEACH DRIVE
PHONE: 87-6437
9:00 - 20:00

SPECIAL LUNCH MENU
from 11:00 to 13:00

05-05-89 FRI #555501

*SIGN ON *

EDEN 0187 T13:02
    
```

```

RESTAURANT TEC
1234 PEACH DRIVE
PHONE: 87-6437
9:00 - 20:00

SPECIAL LUNCH MENU
from 11:00 to 13:00

05-05-89 FRI #555501

*SIGN OFF*

EDEN 0187 T13:03
    
```

CASHIER CODE ENTRY

In the Non-tab Mode System (Type 1) and the Server-Cashier System (Type 2), a cashier code entry may be required (depending on the system type and program options) for every cashier operation on the terminal, besides his/her sign ON to be operated on the first stage.

OPERATION

(must be operated outside a sale on the terminal signed on by the same cashier. Nothing is displayed and no print occurs.)

On Non-tab Mode Terminal

Without Cashier Locks: "Compulsory" or "Prohibited" by a system option selection.

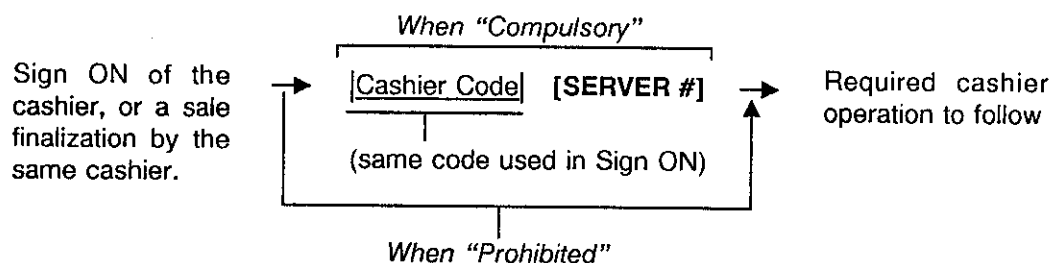

With Cashier Locks: No cashier code entry is to be operated; same as "Prohibited" above.

On Server-Cashier System Terminal

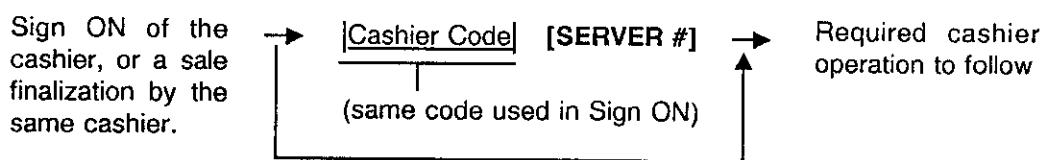

With Cashier Locks: No cashier code entry is to be operated

SERVER CODE ENTRY

In the Server-Cashier System (Type 2) and the Server/Banking System (Type 3), a sever code entry is required for every server operation on any terminal, besides his/her sign ON to be operated on the first stage.

OPERATION (must be operated outside a sale on any terminal. Noting is displayed and no print occurs)

On Server-Cashier System Terminal

Without Cashier Locks: Must be operated outside a cashier operation.

Sign ON of the server, or finalization of a transaction by any server or cashier. → Server Code [SERVER #] → Required server operation to follow
 (same code used in Sign ON)

With Cashier Locks: Must be operated when both Cashier Locks 1 and 2 are OFF, i.e. outside a cashier operation. The operation is the same as above.

On Server/Banking System Terminal: Same as above.

Sign ON of the server, or finalization of a transaction by any server. → Server Code [SERVER #] → Required server operation to follow
 (same code used in Sign ON)

SALE SEQUENCE IN NON-TAB MODE

In the Non-tab System (Type 1), Previous Balance files are not used and a simple sale sequence from menu item entries to finalization by media keys is carried out on the terminal. Cashiers (i.e. operators programmed as cashiers) always operate the terminal.

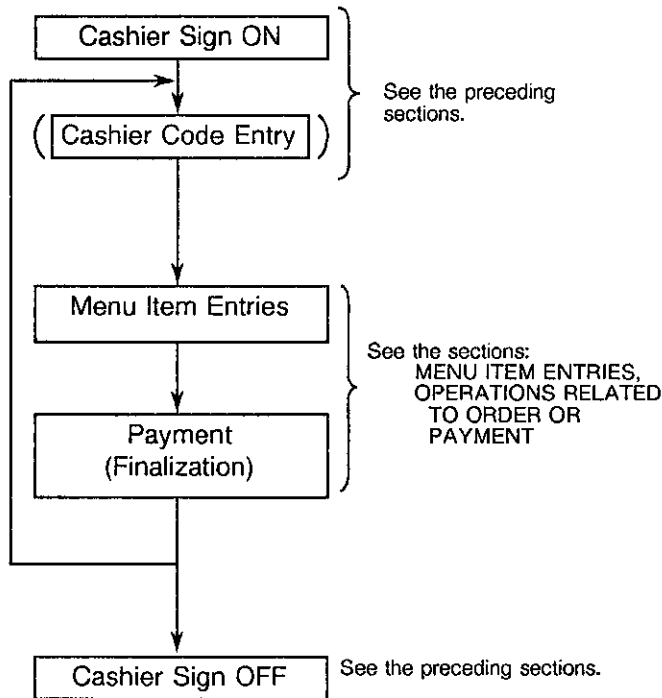

NOTES

1. Menu Item Entries and Payment are operated in one sequence, and a receipt of the sale is issued.
2. Usually, Guest Checks are not issued in this system. However, a Guest Check Printer can be connected and guest checks can be printed by system option.
3. Usually, Remote Kitchen Printers are not used in this system. However, they can be connected and print the ordered menu item by system option.

A receipt sample issued in Non-tab Mode:

RESTAURANT TEC		} Store Name/Message and Commercial Message (Max. 7 lines programmable)
1234 PEACH DRIVE		
PHONE: 87-6437		
9:00 - 20:00		
SPECIAL LUNCH MENU		} Date, Day-of-Week, Register No./Terminal ID No.
from 11:00 to 13:00		
05-05-89 FRI #555501		} Menu Items (Sale Items)
FRUIT SALAD 2.50 T		
COFFEE 0.70 T		} Taxes due
TAX1 0.19		
TOTAL 3.39		Sale Total including Taxes
CASH 3.39		
ITEM 2		Total Item Count of this sale
EDEN 0191 T13:14		Cashier Name, Receipt Consecutive No., Current Time

SALE SEQUENCE IN TAB MODE

In the Tab Mode Systems (Type 2 & Type 3), Previous Balance files are used. The sale sequence is roughly divided into two parts: order entries and check payment. Once a new check is generated and assigned to a guest party, the check memory tracks all the order items until it is finalized by payment. In Type 2 (Server-Cashier System), order entries are operated by servers and payment by cashiers. For Type 3, see the next page.

Type 2: SERVER-CASHIER

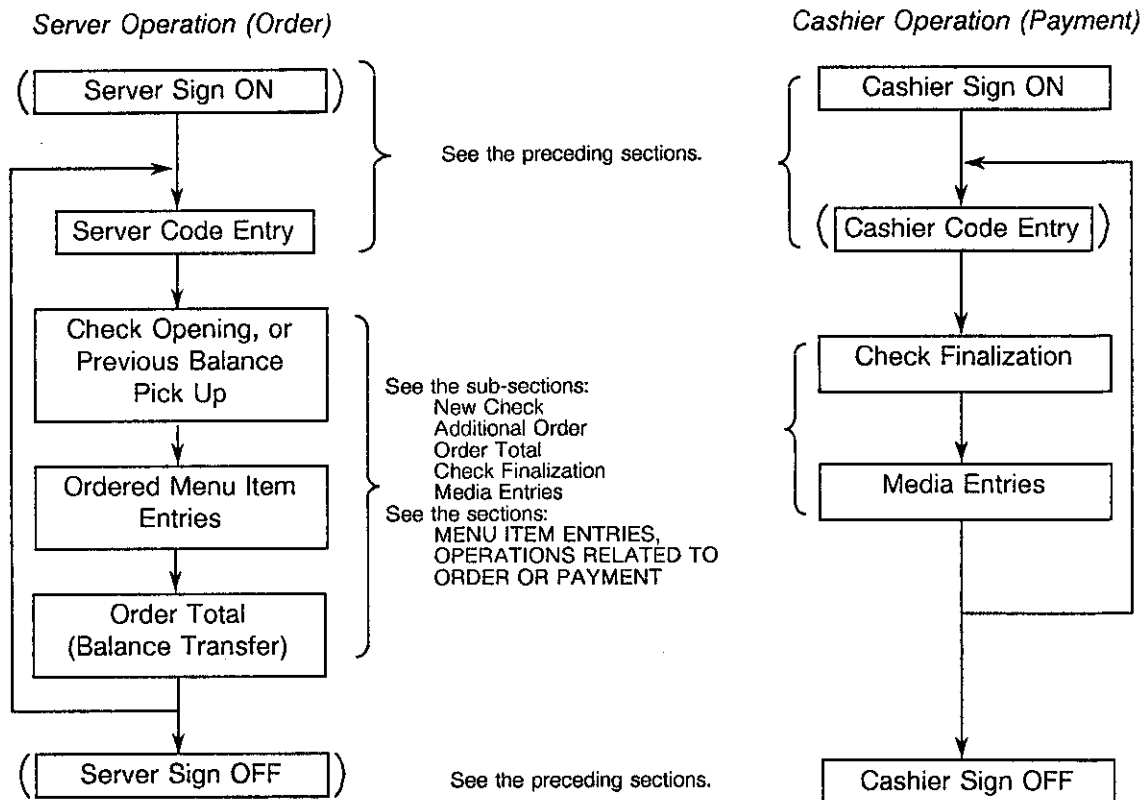

- NOTES**
1. *Menu Item Entries are operated in a New Check sequence and an Additional Order sequence by servers. Payments (Check Finalization and Media Entries) are operated by cashiers. Receipts can be issued for the respective sequences. (If receipts are not necessary, turn the [RECEIPT ON/OFF] switch to the OFF position.) When a Guest Check Printer is connected, all the sequences are printed on the guest check of a guest party. (Refer to the section of GUEST CHECK PRINTER.)*
 2. *When RKPs (Remote Kitchen Printers) are connected, each item entry is printed on the RKPs to which the item is programmed to send the entry data. When an RKP is down, the item print data can be printed and issued from the terminal receipt printer as a formatted receipt if so programmed by system option. (Refer to the section REMOTE KITCHEN PRINTER.)*

In Type 3 (Server/Banking System), each server operates both order entries and payment for his/her guest party.

Type 3: SERVER/BANKING

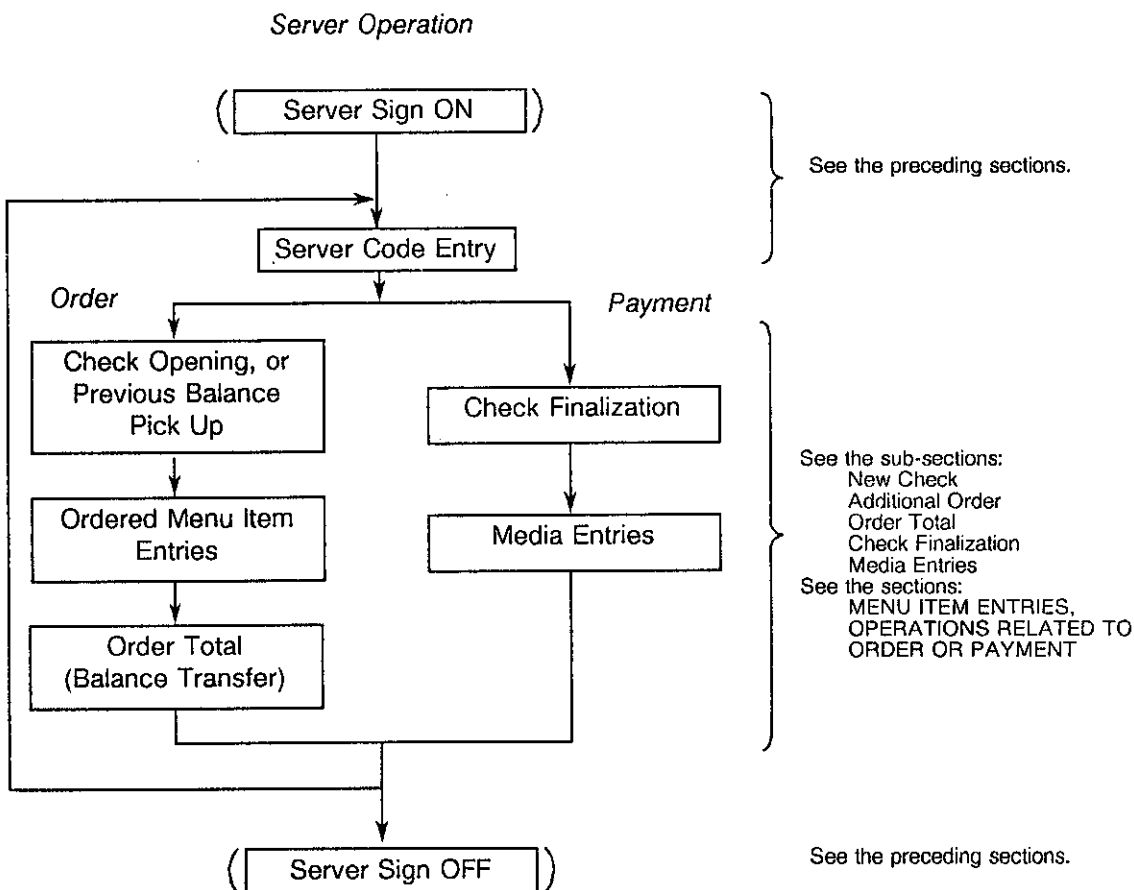

- NOTES**
1. *Menu Item Entries are operated in a New Check sequence and an Additional Order sequence by servers. Payments (Check Finalization and Media Entries) are also operated by servers. Receipts can be issued for the respective sequences. (If receipts are not necessary, turn the [RECEIPT ON/OFF] switch to the OFF position.) When a Guest Check Printer is connected, all the sequences are printed on the guest check of a guest party. (Refer to the section of GUEST CHECK PRINTER.)*
 2. *When RKPs (Remote Kitchen Printers) are connected, each item entry is printed on the RKPs to which the item is programmed to send the entry data. When an RKP is down, the item data can be printed and issued from the terminal receipt printer as a formatted receipt if so programmed by system option. (Refer to the section REMOTE KITCHEN PRINTER.)*

New Check

This operation is applied to Type 2 (Server-Cashier) and Type 3 (Server/Banking) and used to open a check for a new guest party.

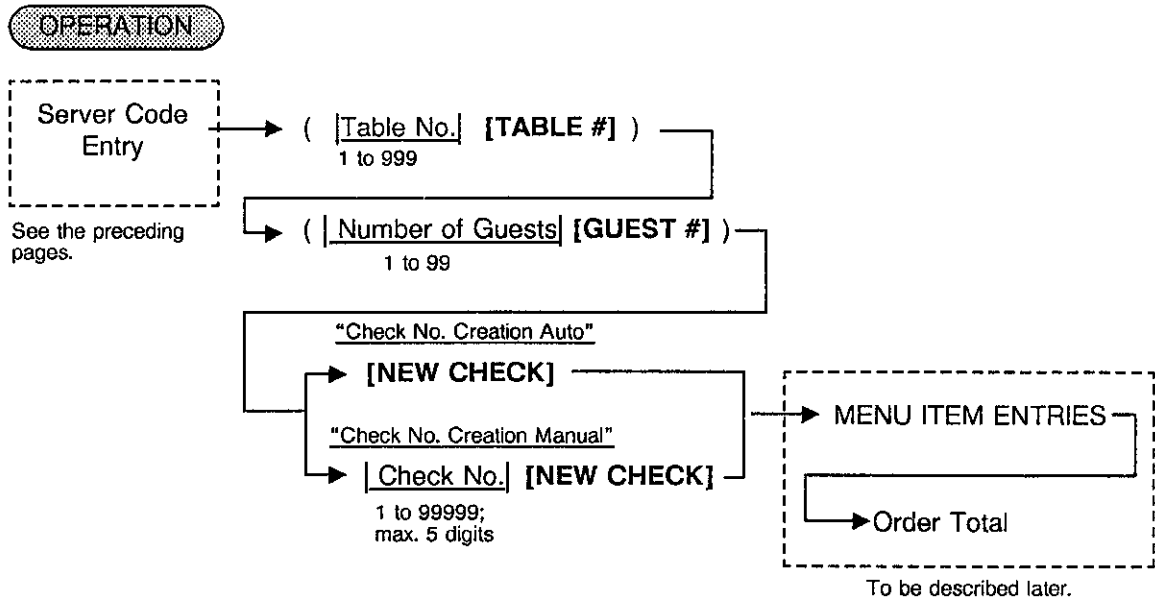

- NOTES**
1. Table No. and/or Number-of-Guests must be entered if so programmed.
 2. When the "Check No. Creation Auto" option is selected, a number is automatically given to the new check.
 3. When the "Check No. Creation Manual" option is selected, any number from 1 to 99999 not currently in use can be entered.
 4. When the "Check Digit Print" option is selected, a Check Digit is calculated and added to the rightmost of the number. In entering the Check No. for additional order sequences, the Check Digit must also be entered as part of the Check No., i.e. the number will be 6 digits maximum.
 5. The receipt is issued and the guest check printing is activated at the Order Total stage but not at the New Check entry.

-- PRINT SAMPLE --

Terminal Receipt

```

05-05-89 FRI #555501
CHK# 00006
BEEF STEAK L 14.00 T
TAX1          0.84
TOTAL         14.84
ITEM          1
JOHNSON 0192 T13:16
  
```



Additional Order

This operation is applied to Type 2 (Server-Cashier) and Type 3 (Server/Banking) and used to enter additional order items in the check already opened. The operation sequence is basically the same as that of the New Check sequence, except that the Check No. entry is mandatory regardless of program option selections and that the [PB] (Previous Balance) key is used instead of the [NEW CHECK] key. The current balance is recalled from the check file memory and additional order item entries are accepted.

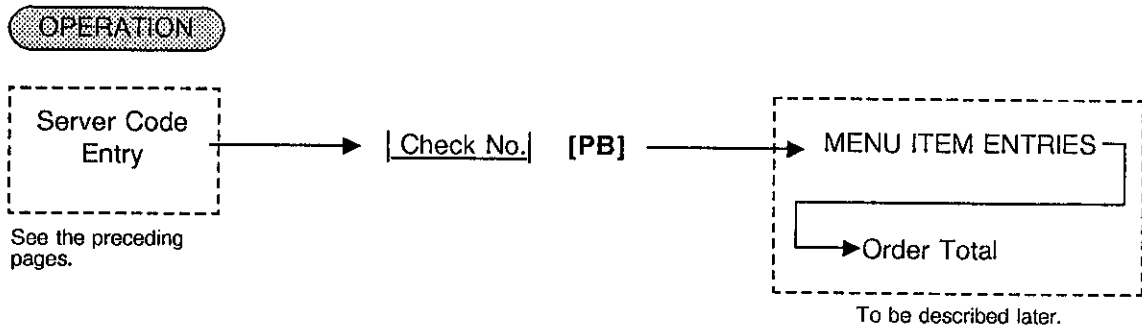

- NOTES**
1. The Check No. here must be identical to that entered in the New Check sequence. When the "Check Digit Print" option is selected, enter the entire number including the Check Digit generated in the New Check sequence.
 2. The check printing is activated on the Order Total stage but not the previous balance pick-up operation.
 3. It is programmable whether the header line is printed on the check at only the first time of order sequences or at every time.
 4. It is also programmable whether the Previous Balance is printed or not at every additional order sequence.

-- PRINT SAMPLE --

Terminal Receipt

```

05-05-89 FRI #555501
CHK# 00006
PREV-BAL      14.00
COFFEE       0.70 T
TAX1         0.88
TOTAL        15.58

ITEM         1
JOHNSON    0193 T13:16
  
```



Order Total (Balance Transfer)

This operation is applied to Type 2 (Server-Cashier) and Type 3 (Server/Banking) and used to finalize the order entries and transfer the balance. The Order Total operation is performed to finalize order entries in a New Check sequence or an Additional Order sequence.

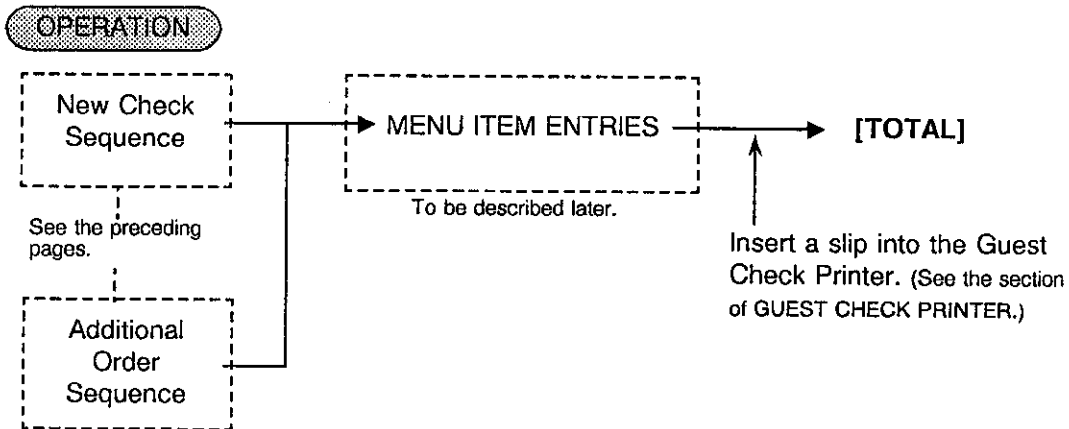

- NOTES**
1. By depressing the **[TOTAL]** key, the order items are entered in the check and the balance is transferred. The Check No., Server Code, and the new balance are stored in the check file memory. At the same time, the order item data are sent to the Remote Kitchen Printers designated by each menu item print destination status if they are connected. If not connected, the order data can be printed as a formatted receipt and issued from the terminal printer if so programmed.
 2. When Guest Check printing is programmed to be compulsory, an error will result if the **[TOTAL]** key is depressed without setting a slip to the Guest Check Printer. In this case clear the error by the **[C]** key, and set the check, and then operate the **[TOTAL]** key.

-- PRINT SAMPLES --

Terminal Receipt

New Order Sequence

```

    05-05-89 FRI #555501
    CHK# 00006
    BEEF STEAK L 14.00 T
    TAX1          0.84
    TOTAL         14.84
    ITEM          1
    JOHNSON 0192 T13:16
  
```

Additional Order Sequence

```

    05-05-89 FRI #555501
    CHK# 00006
    PREV-BAL      14.00
    COFFEE        0.70 T
    TAX1          0.88
    TOTAL         15.58
    ITEM          1
    JOHNSON 0193 T13:16
  
```

Check Finalization (Check Paid)

This operation is applied to Type 2 (Server-Cashier) and Type 3 (Server/Banking) and used to finalize checks opened and entered with order items. The **[CHECK PAID]** key declares the closing of a check and accepts payment using media keys.

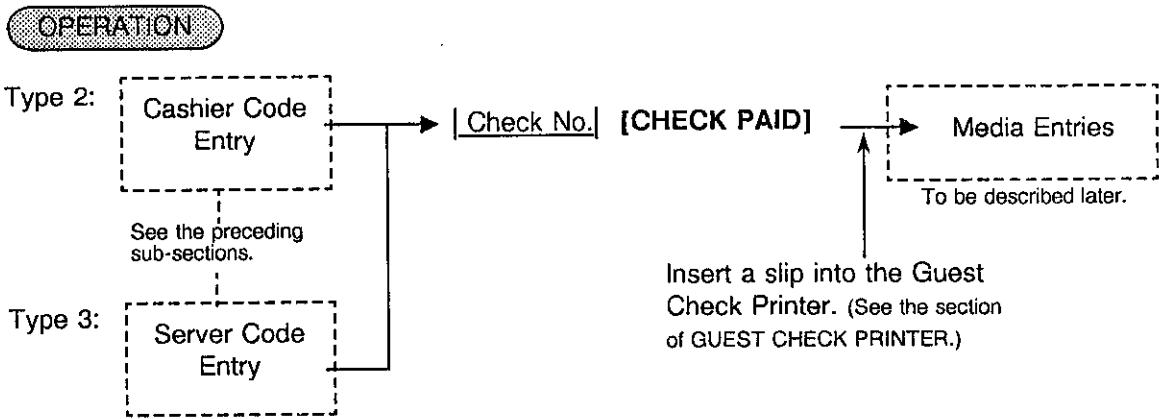

- NOTES**
1. No additional order entries are accepted after the **[CHECK PAID]** key depression.
 2. When payment is recorded by Media Entries and the check is printed, the previous balance file of the check is cleared.

-- PRINT SAMPLE --

Terminal Receipt

```

RESTAURANT TEC
1234 PEACH DRIVE
PHONE: 87-6437
9:00 - 20:00

SPECIAL LUNCH MENU
from 11:00 to 13:00

05-05-89 FRI #555501

CHK# 00006
CHK PAID 14.70
TAX1 0.88
TOTAL 15.58
CASH 15.58

EDEN 0194 T13:16
  
```



Media Entries (Payment)

This operation is applied to all the system types and used to finalize the transaction or check by entering the payment through media keys.

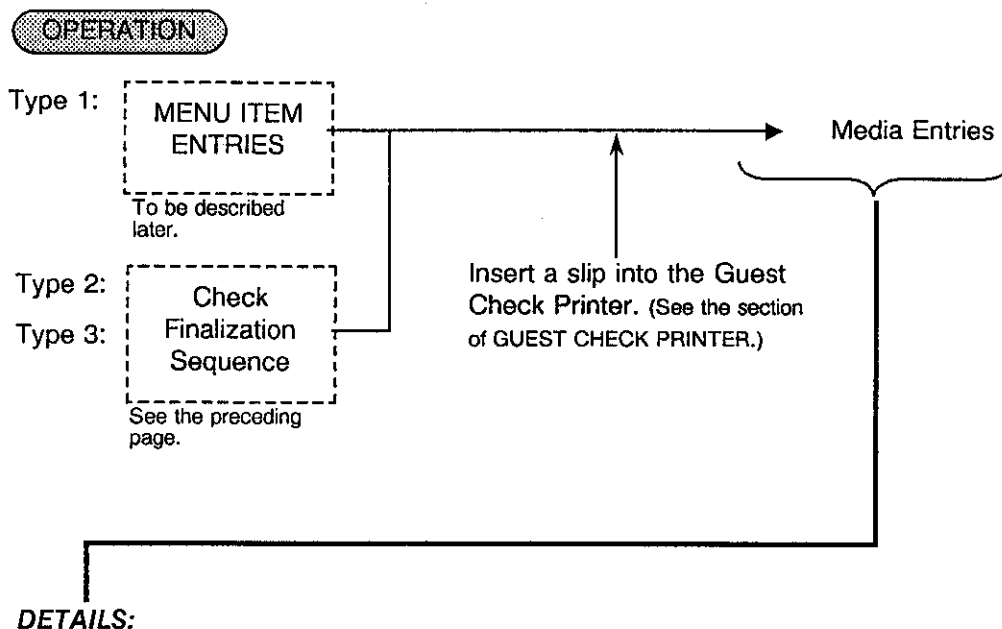

For obtaining total without change computation ("TOTAL" function)

→ [Media Key]

For tender and change computation ("TENDER" function)

→ [Amount Tendered] [Media Key]

- NOTES**
1. The "[Media Key]" here indicates such keys as [CASH], [CREDIT CARD], [GIFT CERT], or [HOUSE CHARGE]. Some other key labels may be on the media keys on your terminal. Use the appropriate media key according to the media tendered for payment.
 2. Each media key is programmed with a function of "TOTAL only", "TENDER only", or "TOTAL & TENDER". Over-tender and/or short-tender are allowed if the media key is so programmed.
 3. When the amount tendered is less than the sale total (i.e. short-tender), another tender or total operation can follow with the same or different media key can follow. In this case, the sale is finalized on reaching the sale total amount.
 4. Whether the drawer opens on operating a non-cash media key is determined by a status selection of the media key. The [CASH] key always has the "Drawer Open" status. The drawer opens even on a zero-balance sale if so selected by system option.

-- MEDIA ENTRY PRINT SAMPLES --

Terminal Receipts

Cash Total

TAX1	0.88
TOTAL	15.58
CASH	15.58
ITEM	2
EDEN	0195 T14:10

Cash Tender

TAX1	0.88
TOTAL	15.58
CASH TND	20.00
CHANGE	4.42
ITEM	2
EDEN	0198 T14:16



Non-cash Media Total
([HOUSE CHARGE] KEY)

TAX1	0.88
TOTAL	15.58
HOUSE CH	15.58
ITEM	2
EDEN	0196 T14:11

Non-cash Media Tender
([GIFT CERT] KEY)

TAX1	0.88
TOTAL	15.58
GIFT CRT	20.00
CHANGE	4.42
ITEM	2
EDEN	0197 T14:14



MENU ITEM ENTRIES

This section describes how to enter menu items during the order sequence. These item entries are applied to all system types unless the types are specified.

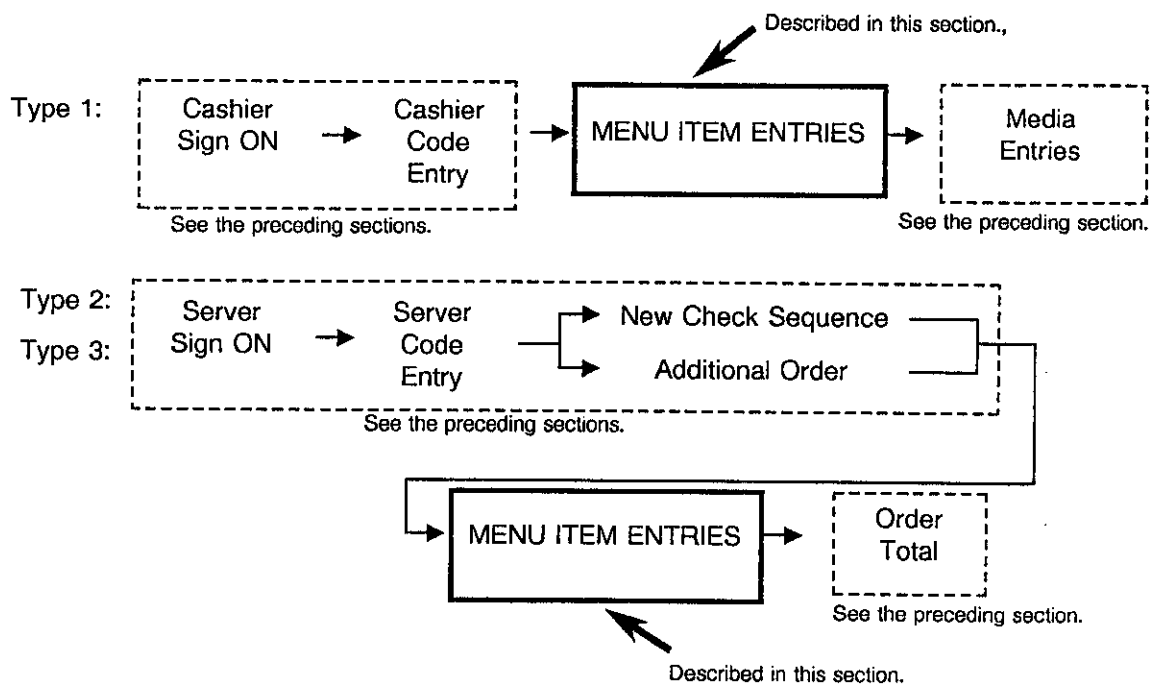

Individual Menu Item

Preset-price Menu Items

Using Code-preset Menu Keys

[Code-preset Menu] ... (Each of these keys is labeled with a specific menu name.)

Using [ITEM #] Key

Menu Item Code [ITEM #]

1 to 9999; max. 4 digits

Open-price Menu Items

Using Code-preset Menu Keys

Price [Code-preset Menu]

Using [ITEM #] Key

Menu Item Code [ITEM #] Price [AMOUNT]

1 to 9999; max. 4 digits

Repeat Entry

To repeat the same item as the last entry, simply depress the last key of any of the Menu item entry sequences on the preceding page.

Quantity Extension (Multiplication)

- Quantity **[@/FOR]** **[Code-preset Menu]** ... (for a preset-price item through Code-preset Key)
 Max. 9 or 99
 depending on a system
 option selection
- Quantity **[@/FOR]** Menu Item Code **[ITEM #]**
 ... (for a preset-price item through **[ITEM #]** Key)
- Quantity **[@/FOR]** Unit Price **[Code-preset Menu]**
 ... (for an open-price item through Code-preset Key)
- Quantity **[@/FOR]** Menu Item Code **[ITEM #]** Unit Price **[AMOUNT]**
 ... (for an open-price item through **[ITEM #]** Key)

Split Package Pricing

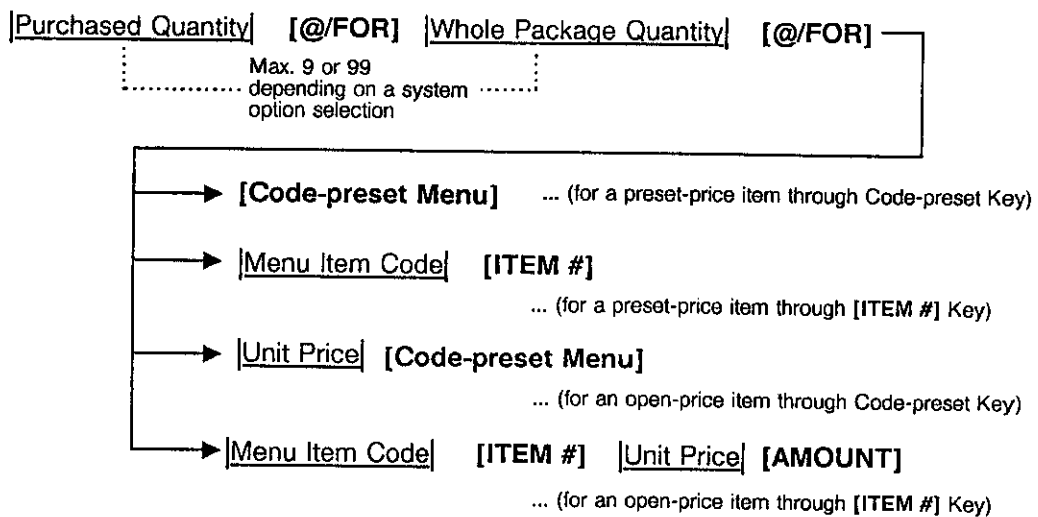

Scale Items (applicable only to items set with the “scalable” status)

Auto Scale Without Tare Subtraction (Place the item on the scale platter first.)

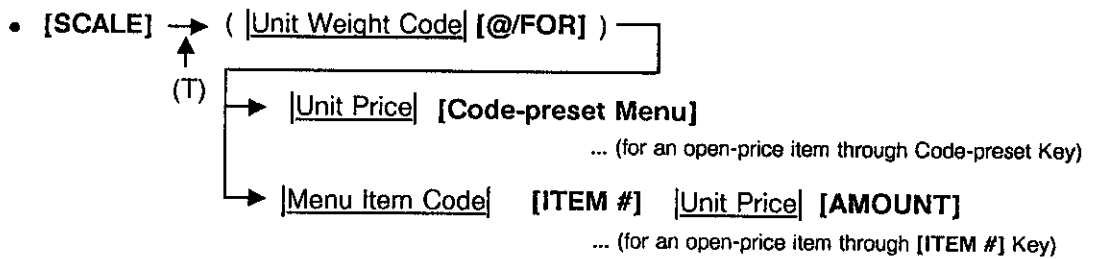
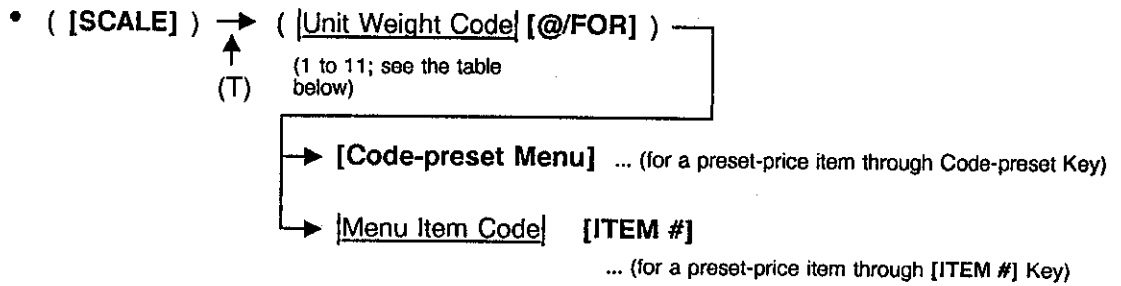

Unit Weight Code Table

Unit Weight Code	LB Option	Kg Option
1	1LB	1Kg
⋮	⋮	⋮
9	9LB	9Kg
10	½LB	100g
11	¼LB	100g

The LB or Kg option is determined by the system option of Unit Weight selection.

- NOTES**
1. The [SCALE] key depression can be skipped for preset-price scalable items.
 2. If the Unit Weight Code specification is skipped, the preprogrammed Unit Weight will be active.

Auto Scale With Tare Subtraction (Place the item on the scale platter first.)

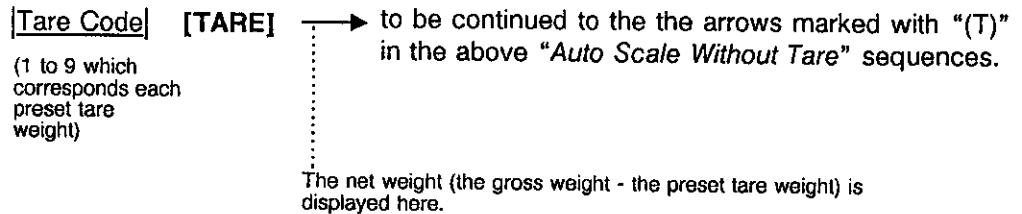

Manual Scale Item Entry

[Net Weight] of the item → to be continued to the top of each sequence in "Auto Scale Without Tare" on the preceding page. In this case, the [SCALE] key depression is mandatory.

- NOTES**
1. The Net Weight must be entered by the unit of 1/100LB (for LB specification) or grams (for Kg specification).
 2. The Manual Scale Item Entries can be prohibited by system option.

RETURN or VOID Scale Item Entry (always by manual weight entry)

[RETURN] (for Void) }
 [VOID] (for Return) } → to be continued to the top of the "Manual Scale Item Entry" sequence above.

- NOTES**
1. The Net Weight must be entered by the unit of 1/100LB (for LB specification) or g (for Kg specification).
 2. The RETURN and VOID Scale Item Entries can be prohibited by system option.

Modifier Entry

The operation patterns are the same as described for the **Preset-price Menu Items** in the **Individual Menu Item** sub-section. Each modifier item is entered immediately after a menu item that requires the modification. The modification descriptor (and the price if preset) will be printed below the item to be modified on the terminal receipt and on the Remote Kitchen Printer paper.

Using Code-preset Menu Keys

[Code-preset Menu]

Using [ITEM #] Key

[Menu Item Code] [ITEM #]

Set Menu Entry

A maximum of 10 Set Menu Tables are programmable. In one table, a maximum of 10 Menu Items can be set. By entering the main menu item of the table, the sub items are automatically entered in a string. Only the main item will be printed on the guest check while all the sub items are printed as well on the Remote Kitchen Printer paper.

Using Code-preset Menu Keys

[Code-preset Menu] (of an item programmed as Main Item of a Set Menu)

Using [ITEM #] Key

Menu Item Code **[ITEM #]**
 ⋮
 (of an item programmed as Main Item of a Set Menu)

NOTES 1. When any of the menu items in a Set Menu Table is programmed with the "LOCK" status (order stop), an error results on entering the Main Item.

Price Shift

Each menu item can be preset with three different prices. The price can be shifted from one to another by operating the **[PRICE SHIFT]** key. The triangular lamp "P/2" or "P/3" turns lit to indicate the current price level. For Price 1 (ordinary price), no such lamps are lit.

Price Shift Code **[PRICE SHIFT]**
 ⋮
 1: for Price 1
 2: for Price 2
 3: for Price 3

NOTES 1. The above operation is available only after a Cashier Code entry on a Non-tab Mode Terminal, or only after a Server Code entry on a Tab Mode Terminal.

2. Once a Price Shift is operated, the designated price level is held until another Price Shift operation is entered.

Preset Price Open Entry

When the price of a preset-price menu item is suddenly changed, this operation is available as a temporary measure.

[PR OPEN] → Follow the same sequences of "open-price" menu items already described, using the required "preset-price" menu key or Item Code. Please note that the Repeat Entry is not possible for a Preset Price Open Entry using a **[Code-preset Menu]** Key. (It is possible when an entry using a Menu Item Code and the **[ITEM #]** key.

-- RECEIPT PRINT SAMPLES OF VARIOUS MENU ITEM ENTRIES --

Individual Menu Item

```
BEEF STEAK L 14.00 T
```

← "T": Taxable Symbol

Auto Scale

```
0.50LB@ 7.50/¼LB
BOILED CRAB 15.00 T
```

0.50LB of @7.50 per 1/4LB = \$15.00

Repeat Entry

```
BEER-A      1.40 T
EER-A      1.40 T
```

Manual Scale

```
MANUAL
0.50LB@ 7.50/¼LB
BOILED CRAB* 15.00 T
```

← Manual Scale Indication (The asterisk at the end of the item name is also a symbol of Manual Scale Item Entry.)

Quantity Extension

```
5X 0.70@
COFFEE 3.50 T
```

5 (Quantity) x @0.70 (Unit Price) = \$3.50

Modifier

```
BEEF STEAK S 7.50 T
rare
```

← Menu Item
← Modifier

Split Package Pricing

```
1X 1.80/ 2
RED WINE 0.90 T
3X 6.70/ 5
FRIED SHRIMP 4.02 T
```

1/2 of a @1.80 bottle wine = \$0.90

3/5 of a @6.70 package = \$4.02

Set Menu

```
HAMB.STK SET 9.00 T
TOSSED SALAD†
CORN SOUP†
COFFEE†
```

← Main Item (or Set Name)
} Sub-items

OPERATIONS RELATED TO ORDER OR PAYMENT

This section describes various operations related to order or payment sequence.

Item Correct (Last Line Voiding)

Most items entered last during an order or payment sequence can be deleted. The following items can be item-corrected, printing a dotted line over the item on the receipt and journal. For the GCP and RKPs, an item correction deletes the required item within the buffer memory before sending the order item data, so the deleted item itself will not be printed.

OPERATION Item Entry → **[ITEM CORR]**

↑

Individual Menu Item (including Modifier; Set Menu Item cannot be item corrected)
 Repeat Entry ... (Only the last one of the repeated items is deleted.)
 Quantity Extension ... (The product of the multiplication is deleted.)
 Split Package Pricing ... (The result of the calculation is deleted.)
 Scale Item Entry
 %-/COUPON Entry
 Check Transfer
 Check Combine
 Service Adjust
 Service Charge
 Charge Tip
 Tip Paid
 Received-on-Account Item
 Paid-Out Item
 Manual Tax
 Short-tendered Media Amount

The following items can be item-corrected, resulting in canceling the transaction and issuing a cancel receipt:

New Check
 Previous Balance
 Check Paid

-- RECEIPT PRINT SAMPLE --

```

  _____
 | PORK-SAUTE----4.50-T |
 |_____
```

Void (Designated Line Voiding)

Menu items entered within a transaction or a guest check can be voided even if they are entered before the last item. A Void entry clears the item when the item to be voided has been entered within the same order entry sequence, or is printed in red on the RKP paper when the item to be voided was entered in a past order entry sequence.

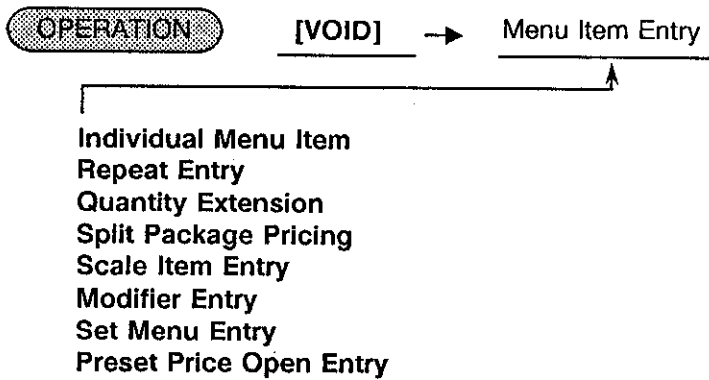

- NOTES**
1. A voiding operation to turn the sale total into a credit balance is usually allowed, but it can be prohibited by system option.
 2. By operating the required menu item entry and then entering a %-ICOUPON item after depressing the **[VOID]** key once, both the menu item and the attached %-ICOUPON item will be voided.
 3. Voiding a menu item included in the last Tray Total is possible.

-- RECEIPT PRINT SAMPLE --

```

*VOID*
SALMON SLICE 9.50-T
  
```

Return

The Return operation is used to record returned items once purchased in a transaction already finalized with payment in Non-tab Mode. (If an item is returned or canceled within a transaction, the Void operation is used.) This operation is not possible in Tab Mode (Server-Cashier or Server/Banking system). The returned item entries will not be printed on RKP paper.

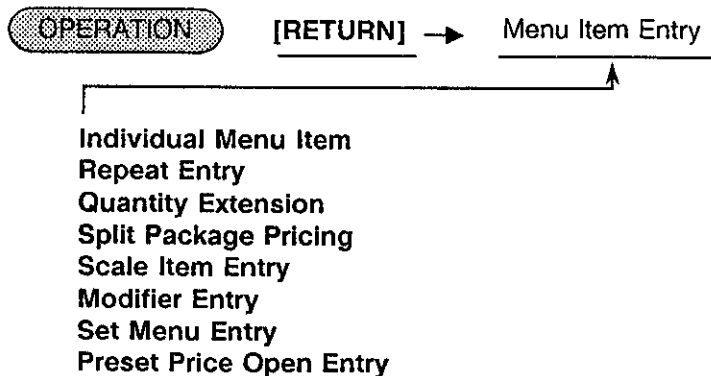

- NOTES**
1. Return operations to turn the sale total into a credit balance is usually allowed but it can be prohibited by system option.
 2. By operating the required menu item entry and then entering a %-/COUPON item after depressing the [RETURN] key once, both the menu item and the attached %-/COUPON item will be voided.
 3. Returning a menu item included in the last Tray Total is possible.

-- RECEIPT PRINT SAMPLE --

```

RTN
FRD CHICKEN  4.50-T
  
```

Clear Transaction

Data entered in the current transaction (one order sequence, for example) can be cleared in a one-touch key operation. It will not clear the data already entered in previous order sequences for a guest check. (To clear the entire data of the guest check, see the Void Check operation on the next page.) When the Clear Transaction is operated in the Non-tab mode, the entire data of the current sale will be cleared.

OPERATION

[CLEAR TRAN]

- NOTES**
1. A receipt is issued and the transaction ends.
 2. It can be operated in New Check, Additional Order, or Check Paid sequences in Tab Modes (Server-Cashier, Server/Banking), and in sale entry sequences in Non-tab Mode.
 3. Since it clears the data in the buffer memory, the data itself will not be printed on the guest check or RKP paper.

-- RECEIPT PRINT SAMPLE --

Non-tab Mode

```

RESTAURANT TEC
1234 PEACH DRIVE
PHONE: 87-6437
9:00 - 20:00

SPECIAL LUNCH MENU
from 11:00 to 13:00

05-05-89 FRI #555501

      3X   1.40@
BEER-A      4.20 T
VEG.SALAD   2.20 T

CANCEL      6.40

EDEN      0206 T14:59
  
```

Tab Mode
(Additional Order Sequence)

```

RESTAURANT TEC
1234 PEACH DRIVE
PHONE: 87-6437
9:00 - 20:00

SPECIAL LUNCH MENU
from 11:00 to 13:00

05-05-89 FRI #555501

CHK# 00005

PREV-BAL    15.40

      3X   1.40@
BEER-A      4.20 T
VEG.SALAD   2.20 T

CANCEL      6.40

JOHNSON    0207 T12:55
  
```

Void Check

This operation is used to void the entire data of an outstanding check. When it is operated, the previous balance will be processed into the VOID CHECK memory (including taxes).

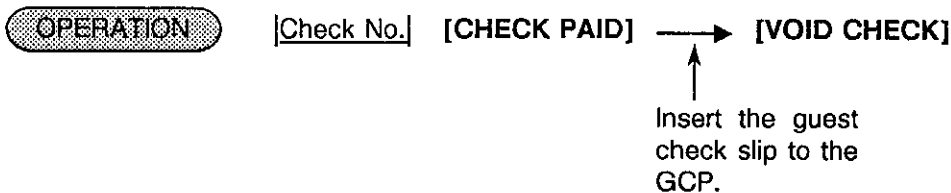

- NOTES**
1. A receipt is issued and the data of the guest check are all cleared.
 2. This operation is not applied to transactions in Non-tab Mode.

-- PRINT SAMPLE --

Receipt

```

RESTAURANT TEC
1234 PEACH DRIVE
PHONE: 97-6437
9:00 - 20:00

SPECIAL LUNCH MENU
from 11:00 to 13:00

05-05-89 FRI #555501

CHK# 00005

CHK PAID      15.40

VOID CHK      15.40

EDEN          0208 T12:55
  
```

Guest Check

```

-----
JOHNSON          CHK# 00005
                CHK PAID    15.40
                VOID CHK    15.40
05-05-89 FRI #555501 EDEN    0208 T12:55
-----
  
```

%-, Dollar Discount, Coupon

Some credit keys may be installed on your terminal, and they may be labeled with various names. These are classified into two types -- keys to enter percent discount (to be called "%-" keys here) and keys to enter amount discount (to be called "COUPON" keys here). Each of the keys is also programmed to discount from individual menu items or from the subtotal of the sale. A preset rate or amount can be set on each key.

OPERATION

%- Keys:

Discounting from an item

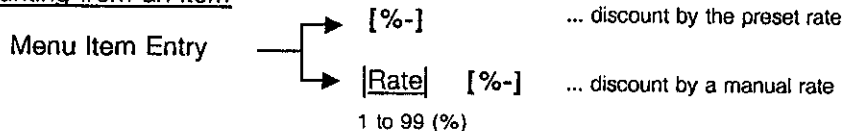

Discounting from the sale

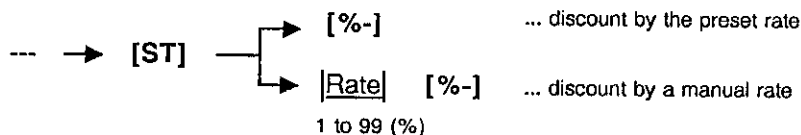

COUPON (or Dollar Discount) Keys:

Discounting from an item

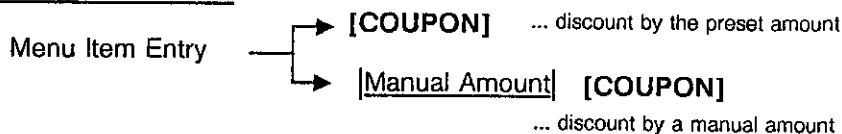

Discounting from the sale

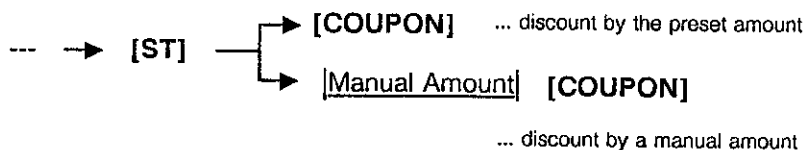

- NOTES**
- Discount operations to turn the sale total into a credit balance is usually allowed, but it can be prohibited by system option.
 - For %- keys, a maximum of 2 digits (1 to 99%) can be entered as a manual rate, but a maximum of 6 digits (0.0001 to 99.9999%) can be set as the preset rate for each key.

-- RECEIPT PRINT SAMPLE --

Discounting from the sale

SUBTOTAL	18.50
DISC TL	
10%	1.85-T

Discounting from an item

BEEF STEAK L	14.00 T
COUPON	5.00-T

Service Charge (% +)

This operation is used to add a service charge rate or table charge rate to the guest check. The charge rate can be entered in the Additional Order sequence or Check Paid sequence. It can be operated only in Tab Mode.

OPERATION

During an Additional Order Sequence:

[Check No.] [PB] → ([Rate]) [SERVICE CHARGE] → ---
 1 to 99 (%)

During a Check Paid Sequence:

[Check No.] [CHECK PAID] → ([Rate]) [SERVICE CHARGE] → ---
 1 to 99 (%)

- NOTES**
1. When the [SERVICE CHARGE] key is simply depressed, the preset rate will be active. When a rate is entered manually, the manual rate prevails.
 2. A maximum of 2 digits (1 to 99%) can be entered as a manual rate, but a maximum of 6 digits (0.0001 to 99.9999%) can be set as the preset rate for each key.

Receipt

```

RESTAURANT TEC
1234 PEACH DRIVE
PHONE: 87-6437
9:00 - 20:00

SPECIAL LUNCH MENU
from 11:00 to 13:00

05-05-89 FRI #555501

CHK# 00004

CHK PAID      2.10

SERV CHG
  15%        0.32 T

TAX1          0.15
TAX2          0.08
TOTAL        2.65

CASH          2.65

EDEN      0212 T12:41
    
```

-- PRINT SAMPLE --

Guest Check

```

JOHNSON          CHK# 00004
                CHK PAID      2.10
SERV CHG      15%      0.32 T
                TAX          0.23
                TOTAL        2.65
                CASH          2.65
05-05-89 FRI #555501 EDEN      0212 T12:41
    
```

Tip Paid

This operation is used to record a tip amount paid in cash at the terminal register and clarifies which server will receive the tip. A receipt is issued. This operation is applied only to Tab Mode terminals.

OPERATION (must be operated outside a transaction)

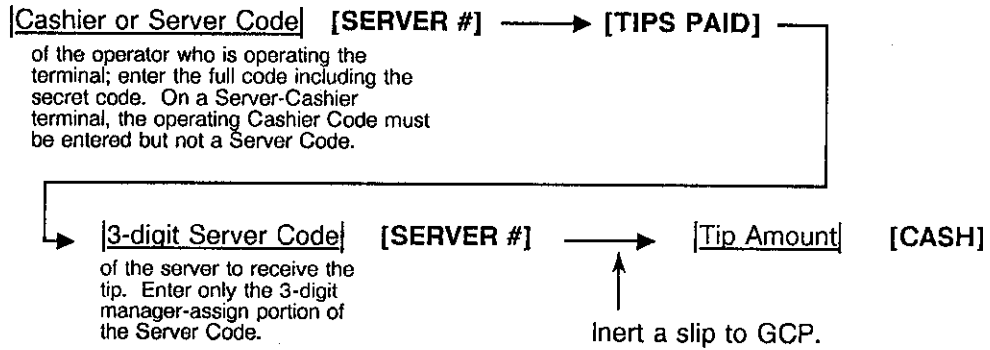

-- PRINT SAMPLE --

Receipt

```

RESTAURANT TEC
1234 PEACH DRIVE
PHONE: 87-6437
9:00 - 20:00

SPECIAL LUNCH MENU
from 11:00 to 13:00

05-05-89 FRI #555501

TIP PAID    JOHNSON
CASH        1.00

EDEN        0213 T15:23
  
```

Slip

```

TIP PAID    JOHNSON
CASH        1.00
05-05-89 FRI #555501 EDEN    0213 T15:23
  
```

Charge Tip

This operation is used to record a tip amount paid in other medias than cash. The entered tip amount is thus added to the sale total of the guest check. It is operated in a Check Paid sequence.

OPERATION

[Check No.] [CHECK PAID] → [Tip Amount] [CHARGE TIP]

Payment Entry using the same media as the tip.

NOTES 1. The media key to be used here must be a media programmed with the status "Charge Tip Allowed".

-- PRINT SAMPLE --

Receipt

```

RESTAURANT TEC
1234 PEACH DRIVE
PHONE: 87-6437
9:00 - 20:00

SPECIAL LUNCH MENU
from 11:00 to 13:00

05-05-89 FRI #555501

CHK# 00003

CHK PAID      5.40

CHG TIP       1.00

TAX1          0.32
TOTAL         6.72

HOUSE CH      6.72

EDEN          0214 T11:07
    
```

Guest Check

```

-----
JOHNSON          CHK# 00003
                  CHK PAID      5.40
                  CHG TIP       1.00
                  TAX           0.32
                  TOTAL         6.72
                  HOUSE CH      6.72
05-05-89 FRI #555501 EDEN    0214 T11:07
-----
    
```

Service Adjust

This operation is used to refund an amount and adjust the sale total of a guest check. It is operated in the Additional Order sequence or Check Paid sequence.

OPERATION

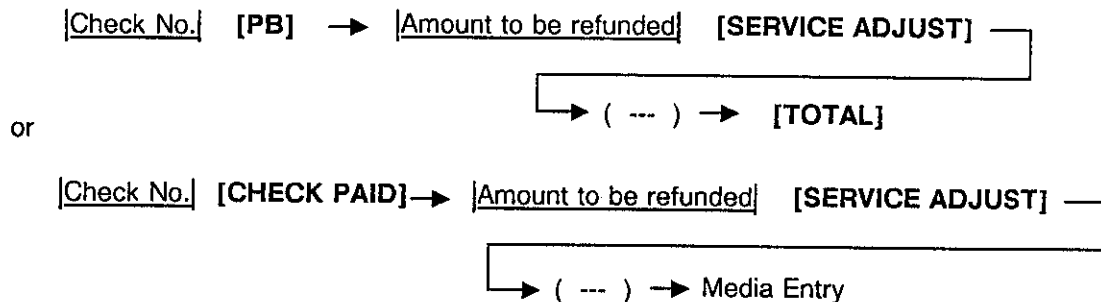

NOTES 1. The Service Adjust entries do not affect report memory totals of individual menu items.

-- PRINT SAMPLE --

Receipt

```

RESTAURANT TEC
1234 PEACH DRIVE
PHONE: 87-6437
9:00 - 20:00

SPECIAL LUNCH MENU
from 11:00 to 13:00

05-05-89 FRI #555501

CHK# 00002

PREV-BAL      3.50
SERV ADJ      0.50-T
TAX1          0.18
TAX2          0.04
TOTAL         3.22

ITEM          0
JOHNSON      0216 T18:55
    
```

Guest Check

```

-----
PREV-BAL      3.50
SERV ADJ      0.50-T
TAX           0.22
TOTAL         3.22
-----
    
```



Check Transfer

This operation is used to change the Server Code, Table No., and/or the number of guests of a check. The Check No. will not be changed. It is operated in an Additional Order sequence.

OPERATION

(must be operated outside a transaction)

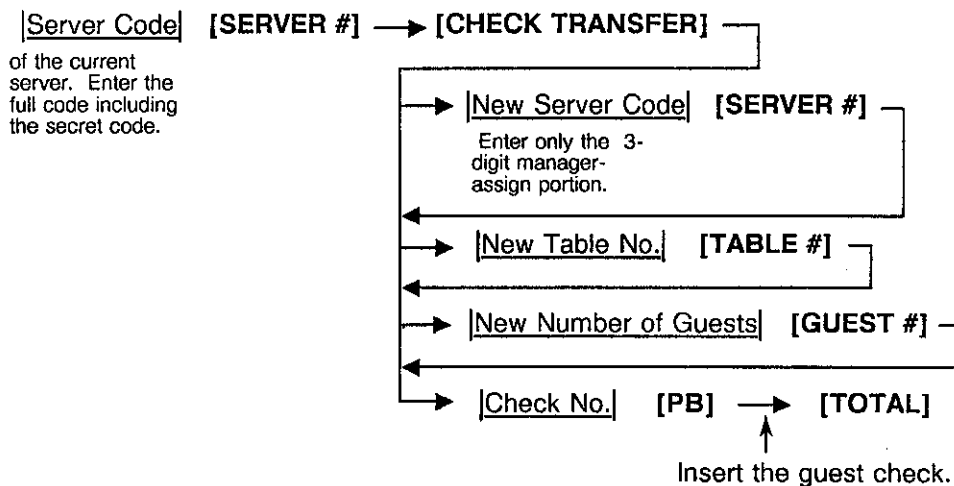

NOTES 1. Of the entries of New Server Code, New Table No., and New Number of Guests, unchanged data can be skipped. But the last line (from "Check No." through the [TOTAL] key) cannot be skipped.

```

RESTAURANT TEC
1234 PEACH DRIVE
PHONE: 87-6437
9:00 - 20:00

SPECIAL LUNCH MENU
from 11:00 to 13:00

05-05-89 FRI #555501

CHK# 00007

TABLE# 15
GUEST 4

CHK# 00007
TABLE# 19
GUEST 4

JOHNSON 0220 T15:56
  
```

Receipt

-- PRINT SAMPLE --

```

~~~~~
JOHNSON          CHK# 00007
05-05-89 T15:56 TABLE# 15 GUEST 4
          CHK# 00007
JOHNSON          TABLE# 19 GUEST 4
~~~~~
  
```

Check Data before change

Check Data after change

Check Data before change

Check Data after change

Subtotal

Depressing the **[ST]** key displays (and prints if so programmed) the total of the items so far entered in the transaction or the guest check. It can be operated in Tab or Non-tab mode.

OPERATION

--- → **[ST]** → ---

- NOTES**
1. When the **[ST]** key is depressed in an Additional Order sequence, the displayed subtotal amount includes the previous balance.
 2. Whether the subtotal amount is printed or not on a **[ST]** key depression is determined by a program option. If the "print" status is selected, the amount is printed on the first depression of the key and consecutive depressions thereafter will only display the amount.
 3. Whether the displayed amount is the subtotal (sale total excluding taxes) or the taxable total (sale total including taxes) is another program option. The printed amount is always the subtotal regardless of the option.

-- RECEIPT PRINT SAMPLE --

SUBTOTAL	14.70
----------	-------

Taxable Total

Depressing the **[TXBL TL]** key displays (and prints if so programmed) the total of the items so far entered in the transaction or the guest check. It can be operated in Tab or Non-tab mode. The displayed (and printed) amount includes taxes. When the **[ST]** key is programmed to display the taxable total, the **[TXBL TL]** key need not be installed on the keyboard.

OPERATION

--- → **[TXBL TL]** → ---

- NOTES**
1. The displayed amount includes the previous balance, if any.

Tax Status Modification

Each of menu items and some function keys is programmed with the taxable or non-taxable status. The status of a menu item or a function key can be reversed for that entry only by operating the [TX1/M], [TX2/M], and/or [TX3/M] keys.

OPERATION

To reverse the Tax 1 status:

[TX1/M] → Menu Item Entry or Function Key Entry

To reverse the Tax 2 status:

[TX2/M] → Menu Item Entry or Function Key Entry

To reverse the Tax 3 status:

[TX3/M] → Menu Item Entry or Function Key Entry

NOTES 1. *If more than one Tax Modifier keys are depressed prior to a required item, the multiple tax status will be reversed for the item. For example, [TX1/M] and [TX2/M] are depressed, both Tax 1 and Tax 2 statuses are reversed.*

Manual Tax

When the [TAX] key is installed, it is used to add a tax amount not charged by automatic tax calculation. This operation is applicable to certain areas only. The manual tax thus entered will be processed to the Tax 3 total memory. In such areas, therefore, a maximum of two tax tables can be programmed -- Tax 1 and Tax 2 -- but not Tax 3.

OPERATION

--- → [Tax Amount] [TAX] → ---

NOTES 1. *A manual tax entry can be item-corrected, but cannot be voided nor returned.*

Tax Exempt

This operation is used to exempt a transaction from auto-taxes.

OPERATION

Selective Tax Exemption:

--- → [TX1/M] → [TX EX] ... to exempt from Tax 1 only
 --- → [TX2/M] → [TX EX] ... to exempt from Tax 2 only
 --- → [TX3/M] → [TX EX] ... to exempt from Tax 3 only

Depressing two Tax Modifier keys will exempt the transaction from the two taxes.

All Tax Exemption:

--- → [TX EX] } ... to exempt from all taxes
 --- → [TX1/M] [TX2/M] [TX3/M] → [TX EX]

- NOTES**
1. On depressing the [TX EX] key, the sale total excluding the exempted-taxes is displayed, and the pre-taxed amount of the sale portion subject to the tax exemption is printed.
 2. After a Tax Exempt entry, only media entry for payment can be operated.
 3. When the taxable total to be tax-exempted is negative, the operation will result in an error

-- RECEIPT PRINT SAMPLE IN NON-TAB MODE --

```

05-05-89 FRI #555501
BEEF STEAK L 14.00 T
COFFEE      0.70 T
TAX1EX      14.70
TOTAL       14.70
CASH        14.70

ITEM        2
EDEN        0225 T16:19
  
```

← Pre-taxed amount of the sale portion subject to the tax exemption

Tray Total

This operation is used to divide a transaction into individual guests of a party, thus it obtains separate totals (tray total) for each guest sale. It can be operated in Non-tab Mode only and is often used in a cafeteria environment.

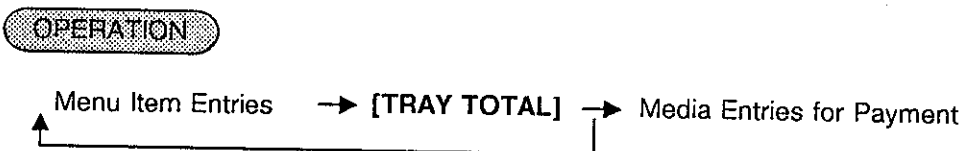

- NOTES**
1. On a [TRAY TOTAL] key depression, the taxes, the sale item count, and the Tray Total are printed. Then a dotted line is printed as a separator for starting another tray data.
 2. VOID, RETURN, or %-COUPON items can be entered after a Tray Total.
 3. For Media Entries for payment, taxes will again be calculated and printed to the entire sale total.

-- RECEIPT PRINT SAMPLE --

FRD CHICKEN	4.50	T	
7-UP	0.70	T	
TAX1	0.31		
ITEM	2		
TRAY TTL	5.51		← 1st Tray Total

← Separator Line			
FRIED SHRIMP	6.70	T	
COCA-COLA	0.70	T	
TAX1	0.44		
ITEM	2		
TRAY TTL	7.84		← 2nd Tray Total

← Separator Line			
SUBTOTAL	12.60		
TAX1	0.76		
TOTAL	13.36		
CASH TND	20.00		
CHANGE	6.64		
ITEM	4		
EDEN	0226	T16:23	} Entire Sale Data

Non-add Number Print

Non-add numbers can be entered and printed for future references, to indicate codes or numbers of customers, media checks, credit cards, etc. The entered numbers do not affect any sale total data.

OPERATION

(---) → |Number| [#] → ---

Max. 16 digits. Preceding zeros, if any, will be printed.

- NOTES**
1. Non-add numbers can be entered any time between sale items, before or after all the sale items if the transaction has not been finalized yet.
 2. It is programmable whether a No-sale operation is allowed after a Non-add Number entry.
 3. It is also programmable whether Non-add Number can only be entered once or any number of times within a transaction.

-- RECEIPT PRINT SAMPLE --

#123456

TAB/CASH Mode Change

The Tab or Cash (Non-tab) Mode of the terminal can be reversed temporarily.

OPERATION

(must be operated outside a transaction before a Cashier or Server Code entry.)

[TAB CASH] ... The Tab Mode is reversed into Non-tab, and vice versa. On completing one transaction, the original mode is regained.

- NOTES**
1. This operation is not possible on terminals of Type 3 (Tab Mode 2: Server/Banking System).
 2. This operation is possible on a terminal of Type 2 (Tab Mode 1: Server-Cashier System) when a cashier has signed ON.
 3. When the Tab Mode is accessed on terminals of Type 1 (Non-tab Mode), Check Transfer and Check Combine operations are accepted, but OPERATIONS NOT RELATED TO SALES (described in the next section) are not. They must be operated in the original Non-tab Mode.
 4. No print occurs on the [TAB CASH] key depression itself.

Validation Print

A single-line validation print is possible for a media entry if the [VALIDATE] key is installed.

OPERATION

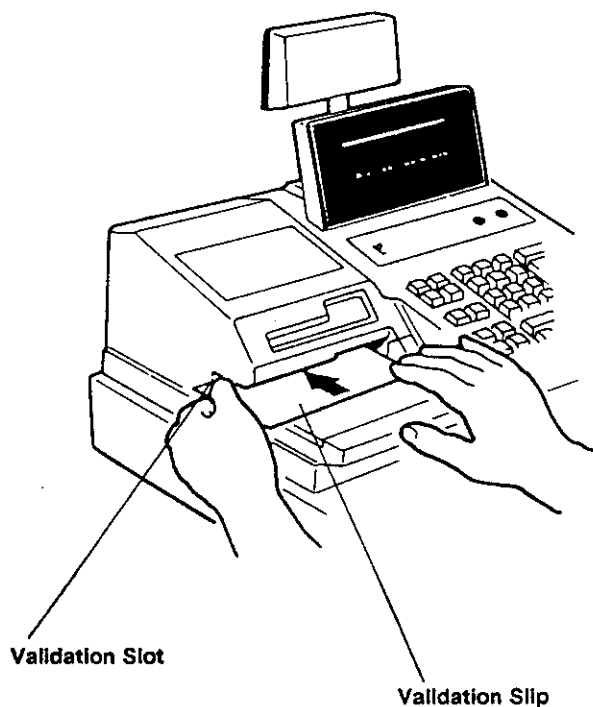
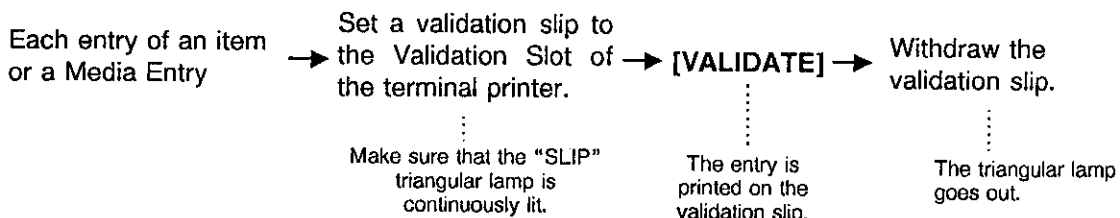

- NOTES**
1. Printing occurs on the bottom side of the slip. Please be certain to insert the slip into the validation slot with the print side downward.
 2. No other operations can follow until the validation slip already printed is withdrawn.
 3. When the "SLIP" lamp flickers, it indicates that the last key is programmed with the Validation Compulsory status. In case a media key is with the Validation Compulsory status, the drawer opens on the completion of the validation print.
 4. When the media is short-tendered, the tendered amount is printed. When over-tendered, Whether the sale total or the tendered amount is printed is decided by the key status.
 5. The following are programmable selections relating to validation:
 - (1) PRINT FORMAT
 - a) Date Print/Non-print
 - b) Consecutive No. Print/Non-print
 - (2) Single- or Multi-time Validation
 - (3) Validation Compulsory status on Media Keys and other transaction keys.

-- VALIDATION PRINT SAMPLE --

05-05-89 555 0213TIP PAIDCASH

1.00

Post Receipt

A Post Receipt is available if the **[POST RECEIPT]** key is installed.

OPERATION A transaction is finalized. → **[POST RECEIPT]**

Programmable options:

- ┌• A Post Receipt is available only when a transaction is finalized with
or **[RECEIPT ON/OFF]** switch positioned to "OFF".
- └• Available regardless of the switch position (in this case two receipts can be
obtained for a transaction).
- ┌• A Post Receipt is an itemized receipt for a sale of maximum 30 lines.
or Exceeding 30 lines, the Post Receipt is total-only receipt.
- └• A Post Receipt is always total-only receipt regardless of the number of print
lines.

- NOTES:**
1. The Post Receipt operation is not possible for a transaction not related to sales (No-sale, Received-on-Account, and Paid-out).
 2. The Time and Consecutive No. print on a Post Receipt are the same as those for the last transaction finalized.
 3. When another transaction is already under way on the terminal, the Post Receipt for the last transaction is no more available.

-- PRINT SAMPLES --

Ordinary Receipt
(issued on a transaction finalization)

```

RESTAURANT TEC
1234 PEACH DRIVE
PHONE: 87-6437
9:00 - 20:00

SPECIAL LUNCH MENU
from 11:00 to 13:00

05-05-89 FRI #555501

COFFEE          0.70 T
TAX1            0.04
TOTAL          0.74

CASH           0.74

ITEM           1
EDEN          0231 T16:35
  
```

Post Receipt
(Itemized Type)

```

RESTAURANT TEC
1234 PEACH DRIVE
PHONE: 87-6437
9:00 - 20:00

SPECIAL LUNCH MENU
from 11:00 to 13:00

05-05-89 FRI #555501

COFFEE          0.70 T
TAX1            0.04
TOTAL          0.74

CASH           0.74

ITEM           1
EDEN          0231 T16:35
  
```

Post Receipt
(Total-only Type of equivalent contents)

```

RESTAURANT TEC
1234 PEACH DRIVE
PHONE: 87-6437
9:00 - 20:00

SPECIAL LUNCH MENU
from 11:00 to 13:00

05-05-89 FRI #555501

TOTAL          0.74

EDEN          0234 T16:39
  
```

OPERATIONS NOT RELATED TO SALES

This section describes operations not directly related to sales.

Type 1: Non-tab Mode

Type 2: Server-Cashier System

Type 3: Server/Banking System

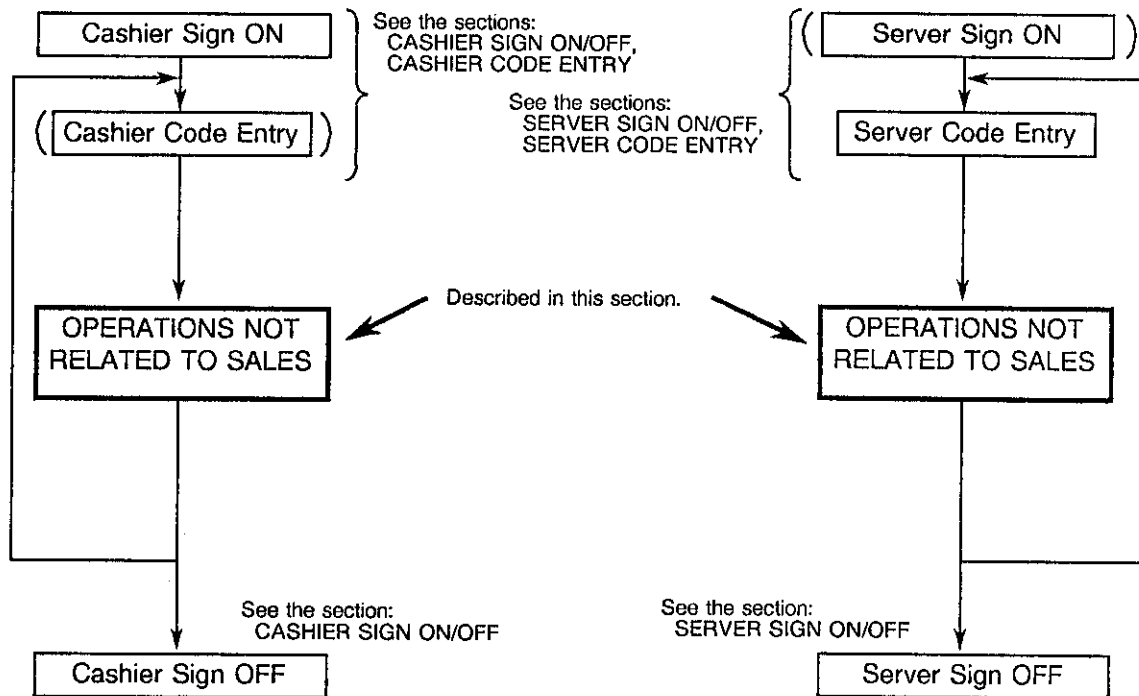

NOTES 1. When the option "Check Print Compulsory" is selected for the corresponding mode (Non-tab or Tab Mode for the terminal), a slip insertion to the GCP will be required for those operations.

2. No print will occur on Remote Kitchen Printers.

No-sale

The no-sale transaction is used to open the cash drawer without relating to any sales, such as for giving change, testing the receipt/journal print condition, etc.

OPERATION

(must be operated outside a transaction)

[NS] The drawer opens and a No-sale receipt is issued.



Insert a slip to GCP.

NOTES 1. A drawer may not be attached to the terminal by option.

-- Terminal Receipt Print Sample --

```

RESTAURANT TEC
1234 PEACH DRIVE
PHONE: 87-6437
9:00 - 20:00

SPECIAL LUNCH MENU
from 11:00 to 13:00

05-05-89 FRI #555501

*NO-SALE*

EDEN      0235 T16:42
  
```

Received-on-Account

A received-on-account transaction is used to identify money which is in the drawer but not from the daily business.

OPERATION (must be operated outside a sale)

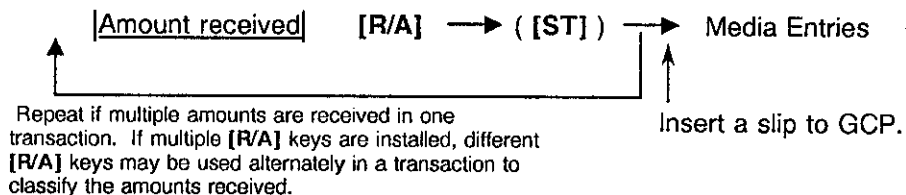

NOTES 1. Media Keys to finalize R/A entries must be programmed with the status "R/A operation allowed".

-- Terminal Receipt Print --

ex.) To enter the following payments received on account and \$8.00 cash is tendered:

<u>Amounts Received</u>	<u>Key Operation</u>
\$3.50	350 [R/A]
\$4.30	430 [R/A]
<u>Total</u> \$7.80	([ST])
	800 [CASH]

```

RESTAURANT TEC
1234 PEACH DRIVE
PHONE: 87-6437
9:00 - 20:00

SPECIAL LUNCH MENU
from 11:00 to 13:00

05-05-89 FRI #555501

R ON ACT      3.50
R ON ACT      4.30

TOTAL          7.80

CASH TND      8.00
CHANGE        0.20

EDEN          0237 T16:45
  
```

Paid-Out

A paid-out transaction is used when money is removed from the drawer without relating to a sale.

OPERATION (must be operated outside a sale)

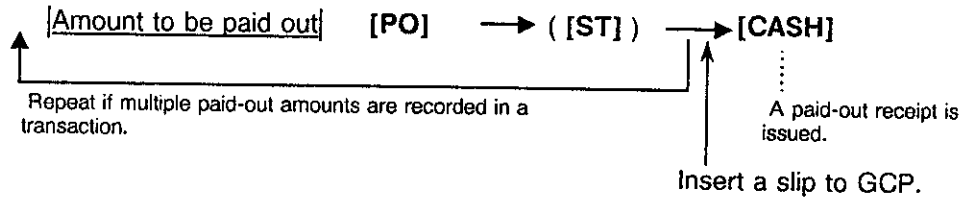

NOTES 1. Only the [CASH] key can finalize paid-out transactions. Tendering is not possible.

-- Terminal Receipt Print --

ex.) To record the following paid-outs:

<u>Amounts to be paid out</u>	<u>Key Operation</u>
\$2.60	260 [PO]
\$6.80	680 [PO]
<u>Total \$9.40</u>	([ST])
	[CASH]

```

    RESTAURANT TEC
    1234 PEACH DRIVE
    PHONE: 87-6437
    9:00 - 20:00

    SPECIAL LUNCH MENU
    from 11:00 to 13:00

    05-05-89 FRI #555501

    PAID OUT      2.60
    PAID OUT      6.80

    TOTAL         9.40

    CASH          9.40

    EDEN         0239 T16:50
  
```

KEY STRINGS USING THE [FUNCTION] KEY

A maximum of 10 Key String Function Tables can be programmed for the conveniences of daily operation routines. A maximum of 10 different key sequences can be preset in one table. A required key string is executed by entering the Table No. (1 to 10) through the [FUNCTION] key. The preset key sequences will be operated automatically.

OPERATION	Key String Function Table No.	[FUNCTION]
-----------	-------------------------------	------------

ex.) Presumed that the key sequence of 1111 [ITEM #] is programmed in Key String Function Table No.1 and that the item No. 1111 is programmed with a Main Item of a Set Menu. The operator wants to enter this Set Menu using the [FUNCTION] key in Non-tab Mode:

-- Terminal Receipt Print --

1 [FUNCTION]

... The same effect occurs as
operating: 1111 [ITEM #]

[CASH]

RESTAURANT TEC	
1234 PEACH DRIVE	
PHONE: 87-6437	
9:00 - 20:00	
SPECIAL LUNCH MENU	
from 11:00 to 13:00	
05-07-89 SUN #555501	
HAMB.STK SET	9.00 T
TOSSED SALAD†	
CORN SOUP†	
COFFEE†	
TAX1	0.54
TOTAL	9.54
CASH	9.54
ITEM	4
EDEN	0006 T17:46

GUEST CHECK PRINTER (GCP)

The TEC Guest Check Printer DRS-107 may be connected to the FDS-50 series terminal as an optional device. The printer will operate printing if a slip is properly inserted at proper timings during various operation sequences. (Refer to each operation sequence in the preceding sections as to when the guest check slip is inserted.)

1. The following are programmabilities as to the Guest Check Printer operations:

PRINT START LINE AND LIMIT LINE SETTING

Appropriate values should be set to meet the guest check slip used by each store.

SYSTEM OPTIONS

- Check Print in Non-tab Mode: COMPULSORY or NOT COMPULSORY
 - Check Print in Tab Mode: COMPULSORY or NOT COMPULSORY
 - Line Feed Control for Check Paid: YES or NO
 - Print Line Position for Check Paid:
IMMEDIATE or WITH LINE FEED
 - Check Total Format on [TOTAL], [PB], [CHECK PAID]:
WITH TAX or WITHOUT TAX
 - Header Line Print at [NEW CHECK] & [PB] Key Entries:
ONLY at [NEW CHECK] or EVERY TIME
 - Previous Balance: PRINT or NON-PRINT
 - Date Print on Checks: PRINT or NON-PRINT
2. The gap of the slip inlet is opened for insertion and closed while printing. The EJECT key on the printer can be pressed to open the closed gap. However, please do not touch this key unless it is really necessary in such cases as removing a paper jam, operating a multi-page process, etc.
 3. When the system option "Line Feed Control for Check Paid -- NO" is selected, a Check Paid entry will print at the top of a guest check. That is, a separate slip is needed for the Check Paid entry from the slip printed with the New Check and Addition Order entries.
 4. When printing of a check requires more than a page, operate as in the following for multi-page process:
 - 1) When printing reaches the last line (limit line) of the first page, printing stops, and the AMOUNT portion of the display flickers.
 - 2) Withdraw the first page, and insert the second page. Then depress the [C] key on the terminal keyboard. Printing resumes.
 5. As for the [LINE No.] key on the terminal, see the chapter of OFF-LINE MODE in the Manager's Guide.

Refer to the print samples on the following pages.

GUEST CHECK PRINT SAMPLE IN NON-TAB MODE

RESTAURANT **TEC**
 1234 PEACH DRIVE
 PHONE: 87-6437
 9:00 - 20:00

SPECIAL LUNCH MENU
 from 11:00 to 13:00

05-05-89 FRI #555501

BEEF STEAK S 7.50 T
 PORK SAUTE 4.50 T
 COFFEE 0.70 T
 BEER-A 1.40 T
 SUBTOTAL 14.10

TAX1 0.85
 TAX2 0.07
 TOTAL 15.02

CASH TND 20.00
 CHANGE 4.98

ITEM 4
 EDEN 0241 T16:54

BEEF STEAK S 7.50 T
 PORK SAUTE 4.50 T
 COFFEE 0.70 T
 BEER-A 1.40 T
 SUBTOTAL 14.10
 TAX 0.92
 TOTAL 15.02
 CASH TND 20.00
 CHANGE 4.98
 05-05-89 FRI #555501 EDEN 0241 T16:54

GUEST CHECK PRINT SAMPLE IN TAB MODE

RESTAURANT **TEC**
 1234 PEACH DRIVE
 PHONE: 87-6437
 9:00 - 20:00

SPECIAL LUNCH MENU
 from 11:00 to 13:00

05-05-89 FRI #555501

CHK# 00009

BEEF STEAK L 14.00 T

TAX1 0.84
 TOTAL 14.84

ITEM 1
 JOHNSON 0242 T17:19

CHK# 00009

PREV-BAL 14.00

COFFEE 0.70 T

TAX1 0.88
 TOTAL 15.58

ITEM 1
 JOHNSON 0243 T17:19

CHK# 00009

CHK PAID 14.70

TAX1 0.88
 TOTAL 15.58

HOUSE CH 15.58

EDEN 0244 T17:19

JOHNSON **CHK# 00009**
 05-05-89 T17:19 TABLE# 0 GUEST 0
 BEEF STEAK L 14.00 T
 TAX 0.84
 TOTAL 14.84

COFFEE
 PREV-BAL 14.00
 0.70 T
 TAX 0.88
 TOTAL 15.58

JOHNSON **CHK# 00009**
 CHK PAID 14.70
 TAX 0.88
 TOTAL 15.58
 HOUSE CH 15.58
 05-05-89 FRI #555501 EDEN 0244 T17:19

REMOTE KITCHEN PRINTER (RKP)

Appearance and Nomenclature

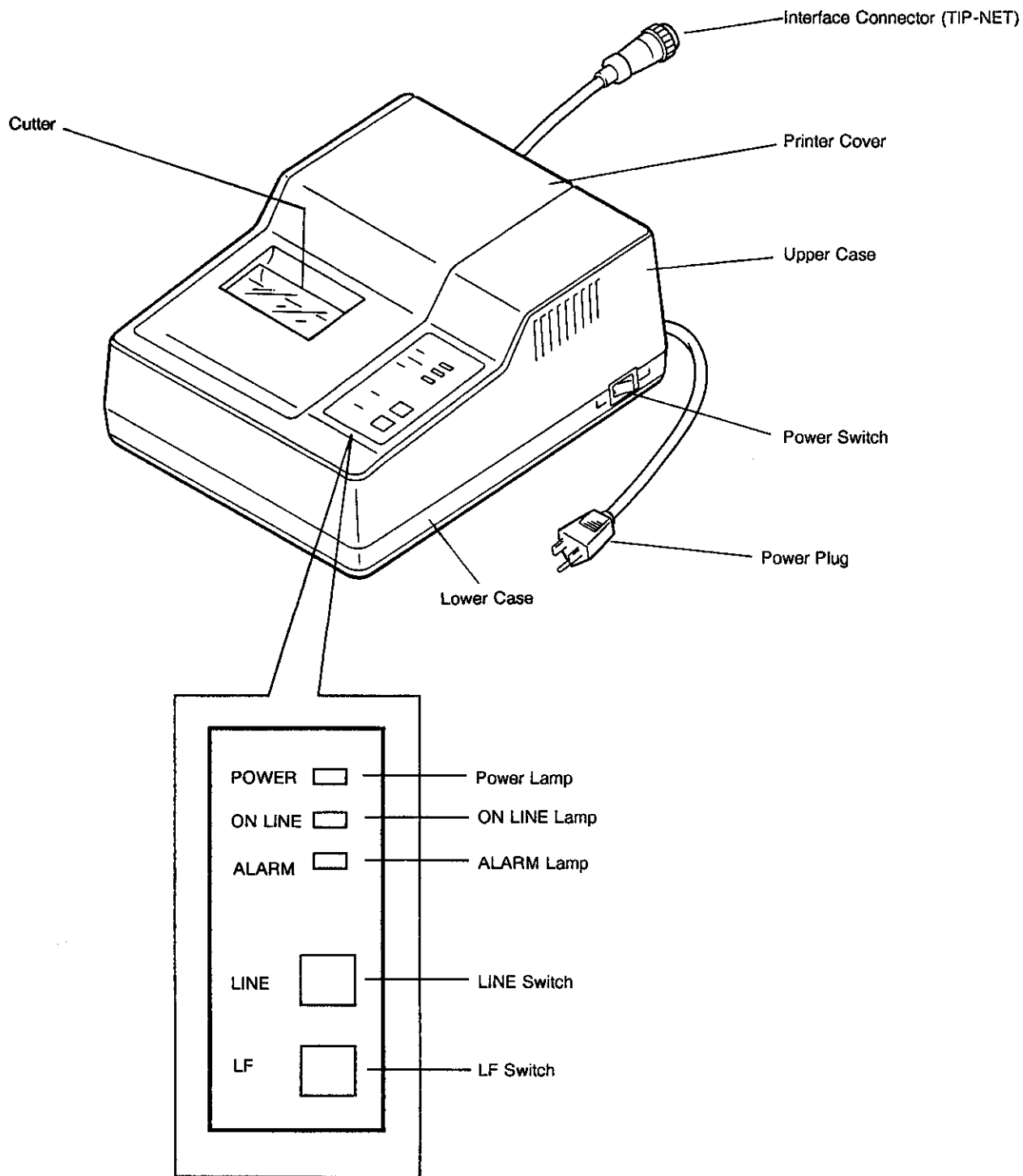

Power Switch	When the Power Switched is turned ON, the printer starts initializing, and the print head returns to the home position.
LINE Lamp	It is lit when the printer is in on-line condition. It goes out when the printer is in off-line condition. Printing is possible when the LINE lamp is lit.
ALARM Lamp	It lights up when a paper-empty error has occurred. It flickers when a hardware error such as motor lock has occurred. It goes out when the cause of the error is removed or cleared.
LF Switch	It must be pressed when paper feeding is necessary.
LINE Switch	It must be pressed to reverse the printer condition from on-line to off-line, or vice versa.

Paper End Detector

A paper-end detector is installed in the printer, and a paper-end condition is indicated in the following steps:

- (1) The ALARM lamp turns lit.
- (2) The ON LINE lamp goes out.
- (3) The alarm buzzer sounds.

When paper is refilled, the alarm buzzer stops and the ALARM lamp goes out.

Print and Cut Positions

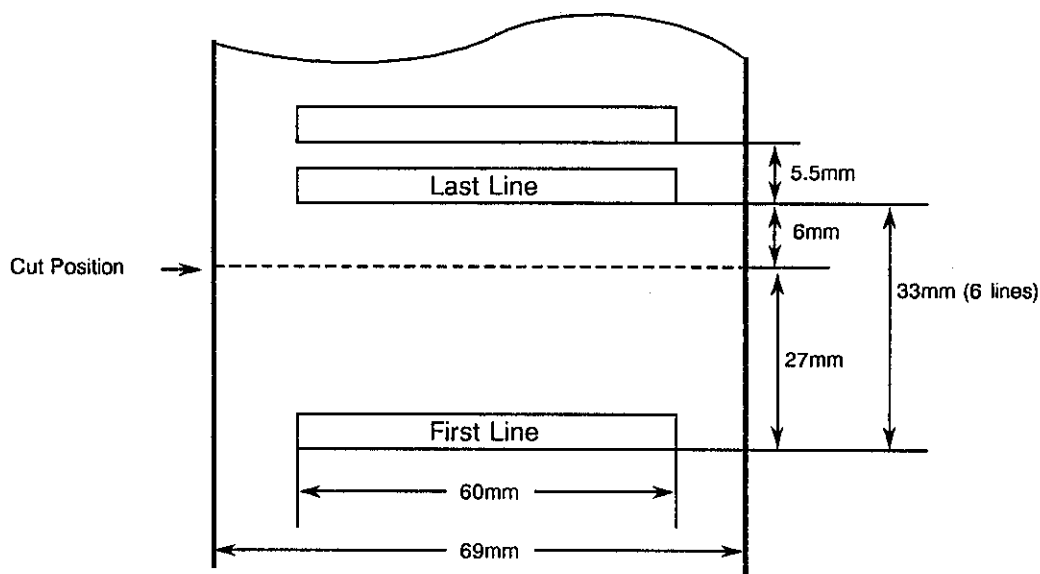

Terminal Operation and RKP Printing

A maximum of 4 Remote Kitchen Printers (RKP-50) can be connected to the terminal via the TIP NET cable. Each of the remote printers should be placed in a preparation area such as kitchen, pantry, etc. According to the status "Printer Destination 1 to 4" of each menu item, the menu item entry is printed on the designated remote printer in order sequences (accurately on depressing the **[TOTAL]** key to end the order sequence in Tab Mode or on finalizing the transaction in Non-tab Mode). If multiple menu items data are sent to one remote printer, the Print Priority set for each item decides the printing order.

If the items are set with the same Priority, items of lower Item Code No. will be printed first.

System Options relating to RKPs:

Print formatted receipt from Terminal when the RKP is in trouble or disconnected:

YES or NO

Remote Print in Non-tab Mode: PRINT or NON-PRINT

The following are samples printed on Remote Kitchen Printers in Tab Mode.

Terminal Receipt

```

CHK# 00011
TABLE# 30
GUEST 4
BEEF STEAK L 14.00 T
COFFEE 0.70 T
TAX1 0.88
TOTAL 15.58
ITEM 2
JOHNSON 0249 T11:07
    
```



Formatted Receipt

```

05-07-89 SUN #555501
CHK# 00012
TABLE# 30
1 BEEF STEAK L
1 COFFEE
JOHNSON 0252 T11:13
    
```

In case the designated RKP is down for some reason or no RKPs are not connected. Appropriate option settings are needed to issue this receipt.

RKP Print

In case the two items are destined to the same remote printer:

```

TABLE# 30 JOHNSON
1 BEEF STEAK L
1 COFFEE
05-11-89 #555501 0073 T15:28 00011
    
```

In case the two items are destined to different remote printers:

```

TABLE# 30 JOHNSON
1 BEEF STEAK L
05-11-89 #555501 0073 T15:28 00011
    
```

```

TABLE# 30 JOHNSON
1 COFFEE
05-11-89 #555501 0074 T15:28 00011
    
```

RKP No.1

RKP No.2

NOTE: In actual operations, the Consecutive Nos on the Formatted Receipt or RKP printout match that of the Terminal Receipt.

Retry and Formatted Receipt Operations

When the designated RKP is in an error status, such as Power OFF, cable disconnection, etc., a "time-out" occurs in sending the menu item to the designated RKP. The message "RETRY" is displayed in the 20-digit dot windows of the display. In this case, one of the following operations can be selected:

RETRY: When the RKP is expected to be recovered soon, depress the [TOTAL] or [CASH] key to retry to send the data again.

FORMATTED RECEIPT ISSUANCE:

When a formatted receipt is expected to be issued from the terminal printer, instead of printing on the RKP, depress the [ITEM CORR] key.

For a terminal without any RKPs connected, a formatted receipt is automatically issued without a "RETRY" display sequence.

Main Specifications

External Dimensions:	205mm(width) x 265mm(depth) x 112mm(height)
Weight:	Approx. 2.5kg
Operating Temperature:	0°C to 40°C
Operating Humidity:	10% to 85% RH
Power Required:	AC 117V \pm 10%; 50/60Hz
Life:	Printer 1.5 million lines (MCBF) Head 50 million characters
Character Size:	1.25mm(width) x 2.75mm(width) for regular-sized characters
Font Components:	5 x 7 dots (regular-sized), 11 x 7 dots (double-sized)
Print Speed:	2.7 lines/sec. for full columns, 1.2 lines/sec. for 12 columns
Max. Number of Characters per Line:	20 (regular-sized only), 40 (double-sized only)
Print Direction:	Left to right (one way)
Line Pitch:	5.5mm
Paper Roll Size:	69 \pm 1mm(width) x 80mm or less (diameter); High quality paper 45kg. (Pressure-sensitive paper cannot be used.)
Ink Ribbon:	Dual-color Ribbon (upper: black / lower: red for VOID entry) Width 13mm (spool diameter 30mm or 35mm)
Interface:	TIP-NET
Data Buffering:	TIP-NET Text of 2 blocks (= max. 48 records)
Memory Back-up:	Received data is not lost even if a power failure occurs.

10. POWER FAILURE PROCESS

If a power failure occurs, the sales memory is protected by the back-up battery; registration and printing will normally be performed on regaining the power. However, please note the following cases:

- (1) The printer will work to print the entered data without failure after the power recovery if any data was being printed. However, one extra line may be fed on the power recovery depending on the power failure timing.
- (2) The display will indicate, on the power recovery, the content that was displayed before the power failure. However, if only numeric keys or non-motorized keys ([VOID], [TX/M], [X], [PRO PEN], [RETURN], etc.) are depressed at the start of a sale registration, and then the power fails, the entered numeric value or non-motorized key will disappear by the time of power recovery and the display will indicate the error code "E40". In this case, perform the registering operation again from the very first key-in operation.

If a power failure occurs, it is recommended to check the print content before the receipt is handed to the customer.

11. JOURNAL AND RECEIPT PAPER-END DETECTOR

- (1) This detects when either the journal or receipt paper is running out. It is provided to prompt the operator to replace the old paper roll with a new one.
- (2) When the paper roll is running out (or the paper has not been set properly), no key operation is accepted and the AMOUNT portion of the display keeps flickering.
- (3) When a new paper roll is set, only the [RF] and [JF] keys are allowed to operate. Next, when the [C] key is depressed, the display flickering will be cleared and normal key-in operations will be accepted. When any printing has been suspended, it will continue printing.
- (4) If this detector senses a paper-end condition during printing, the printing stops after the current line printing is completed.
- (5) If the [C] key is depressed in the paper-end condition, it is ignored. The [C] key depression will clear the display flickering only after the new paper roll is set.

12. PRINTER MOTOR LOCK DETECTOR

- (1) This detects the printer motor lock condition (for both Terminal Printer and GCP) caused by some trouble, such as paper jamming.
- (2) When such a condition is detected, the operator display indicates "Error" and none of the keys can be operated (neither can [RF] nor [JF] be operated).
- (3) To regain the normal condition, turn the power of the ECR to OFF, remove the cause of the motor lock, and then turn the power to ON again. (In case the GCP is locked, the terminal can be made to work by temporarily removing the GCP cable from the terminal.)

13. PAPER ROLL REPLACEMENT AND OTHER MAINTENANCE OPERATIONS

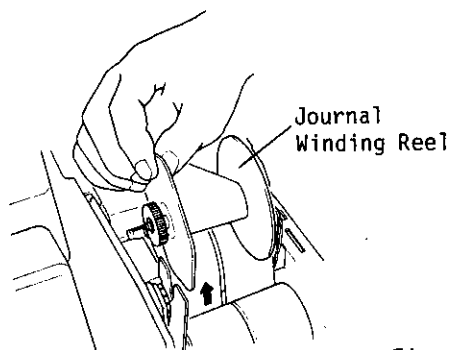

Fig. 1

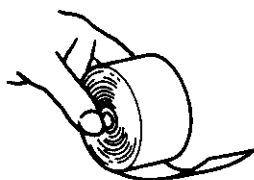

Fig. 2

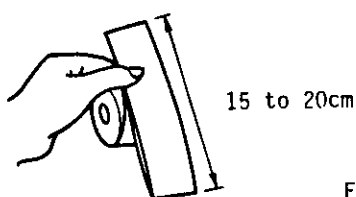

Fig. 3

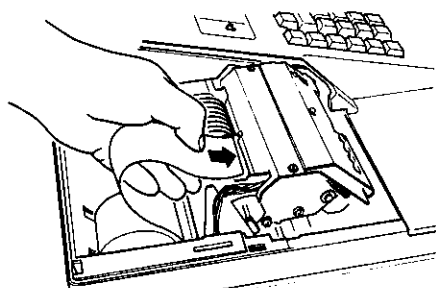

Fig. 4

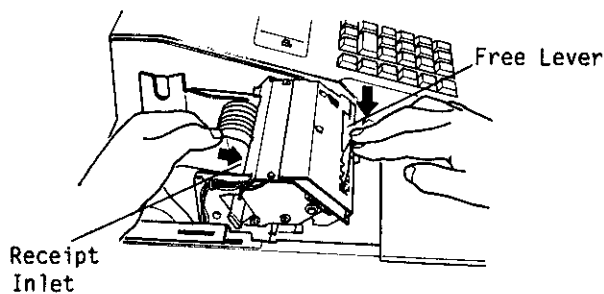

Fig. 5

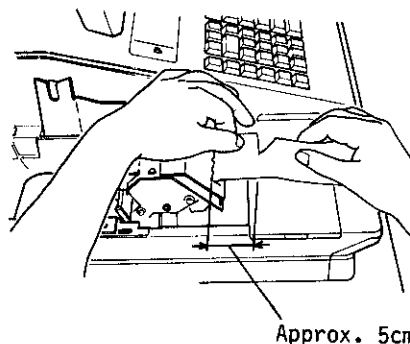

Fig. 6

13-1 INSTALLING THE RECEIPT PAPER

1. Turn the Mode Lock to the REG position with the power ON.
2. Remove the Paper Cover, and remove the Journal Winding Reel (Fig. 1).
3. Place a new paper roll in the direction shown in Fig. 2 so that the paper end will be fed from the bottom.
4. Fold the paper end as shown in Fig. 3 to ease the insertion.
5. Place the paper roll in the outer holder of the two roll holders (Fig. 4).
6. Insert the paper end into the Receipt Inlet, feed the paper in while pressing down the Free Lever (or feed the paper in while pressing the [RF] key). (Fig. 5)
7. When the whole folded portion has come out, tear off the unnecessary part with an appropriate end length remaining (approx. 5 cm or 2 inches). (Fig. 6)
8. Go on to INSTALLING THE JOURNAL PAPER steps if necessary, or go on to Step 9 below if not.
9. Attach the Paper Cover. Please note the paper end must be visible outside the cover.
10. Press the [C] key to clear the paper-end condition, and depress the [NS] key to issue a receipt to check if the paper has been properly set.

NOTE: The [RF] or [JF] keys function only when both receipt and journal paper rolls have been placed in their respective holders.

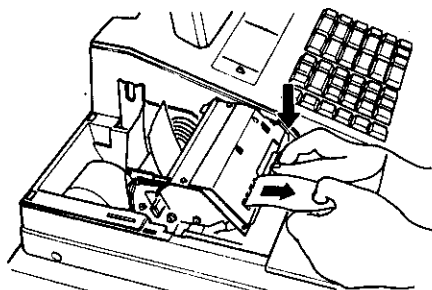

Fig. 7

13-2 REMOVING THE RECEIPT PAPER

1. Remove the Paper Cover.
2. Tear the paper end off the paper core and pull the paper end out while depressing the Free Lever. (Fig. 7)
3. Remove the paper core.

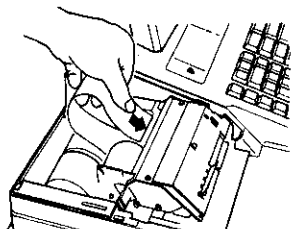

Fig. 8

13-3 INSTALLING THE JOURNAL PAPER

1. Turn the Mode Lock to the "REG" position with the power on.
2. Remove the Paper Cover by pulling it upward, and remove the Journal Winding Reel. (Fig. 1)
3. Follow Steps 3 and 4 of INSTALLING THE RECEIPT PAPER procedure on the preceding page.
4. Place the paper roll in the inner roll holder of the two holders. (Fig. 8)
5. Insert the paper end into the Journal Inlet, feed the paper in while pressing down the Free Lever (or feed the paper in while pressing the [JF] key. (Fig. 9)
6. When a sufficient amount of paper comes out, wind the paper around the Journal Winding Reel two or three times, and set the Journal Winding Reel into the Reel Holder. (Fig. 10)
7. Attach the Paper Cover.
8. Press the [C] key before starting operation.

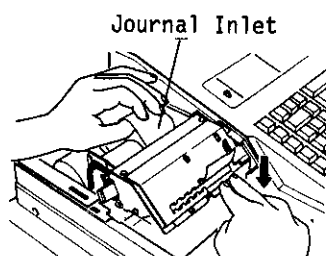

Fig. 9

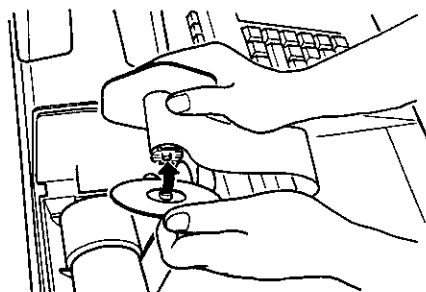

Fig. 10

13-4 REMOVING THE JOURNAL PAPER

1. Remove the Receipt Cover.
2. Press the [JF] key to wind up enough of the journal paper, and then tear off the paper, holding the Journal Winding Reel.
3. The wound-up portion of the paper can easily be removed from the Reel by pulling it sideways. (Fig. 11)
4. If enough paper remains on the roll, follow Steps 6 through 8 above; if the paper is running out, follow Steps 1 through 8 above.

NOTE: The [JF] or [RF] keys function only when both journal and receipt rolls have been placed in their respective holders.

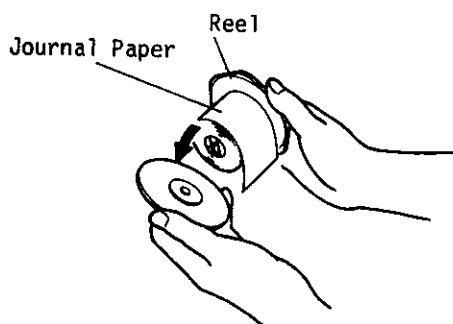
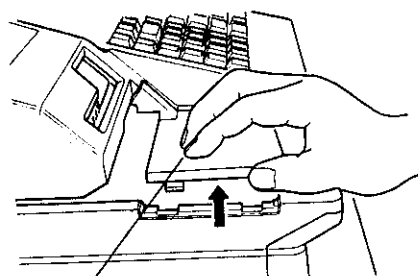

Fig. 11

13-5 REPLACING THE RIBBON CARTRIDGE

If either the receipt or journal print is too light, replace the Ribbon Cartridge in the following manner.

1. Remove the Ribbon Cover (Fig. 1).
2. Remove the old Ribbon Cartridge by pulling it toward you (Fig. 2).
3. Install a new Ribbon Cartridge in the reverse order to Step 2 above (Fig. 3).
4. The Ribbon Cartridge is a consumable product. Be certain to use a genuine Ribbon Cartridge supplied by your TEC representative.



Ribbon Cover

Fig. 1

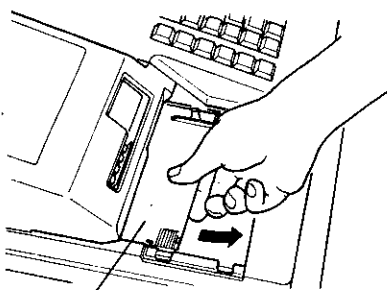

Ribbon Cartridge

Fig. 2

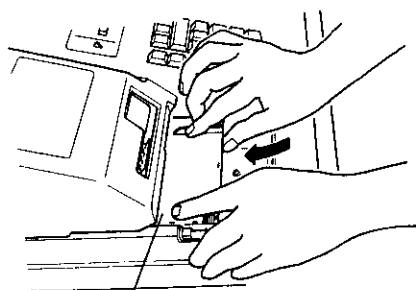

Ribbon Cartridge

Fig. 3

13-6 REPLENISHING THE STORE NAME STAMP WITH INK

When the store name stamp is printed too lightly, replenish the ink in the following manner:

1. Turn the Power Switch to OFF. Remove the Paper Cover.
2. Withdraw the store name stamp with the protruding part clasped between your fingers (Fig. 4).
3. Apply ink to the pad on the rear side of the Store Name Stamp. The amount applied should be adjusted according to the desired darkness of the printed message, but the limit of 2 cc should not be exceeded. (The ink bottle supplied contains 5 cc of ink.) (Fig.5)
4. Follow the reverse order of the instructions in Step 2, and then attach the cover.

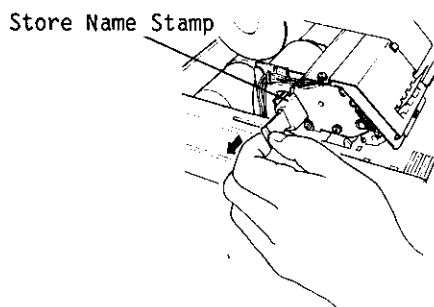

Store Name Stamp

Fig. 4

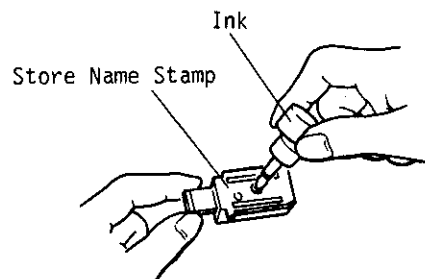

Store Name Stamp

Ink

Fig. 5

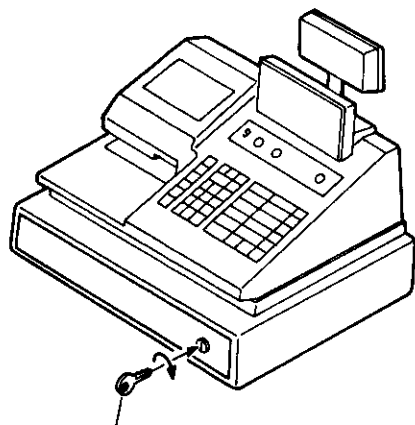

Drawer Release Key

Fig. 1

13-7 MANUAL DRAWER RELEASING

The drawer opens automatically when a registration is performed. In the event of a power failure or other trouble, the drawer can be opened manually in the following manner:

1. Insert the Drawer Release Key into the drawer release lock and turn the key clockwise. The drawer will then open. (Fig. 1)
2. The Drawer Release Key can be taken out by returning it to the original position.
3. When the drawer is closed, it is automatically locked and will not open without the Drawer Release Key or a normal registering operation.

13-8 REMOVING THE DRAWER

1. Pull the drawer out, and when it stops at the stopper, lift the drawer up and pull it further out (Fig. 2). When it stops again at the roller fixed in the drawer housing, lift it and pull it out (Fig. 3).
2. To return the drawer, follow the reverse procedure for removing.

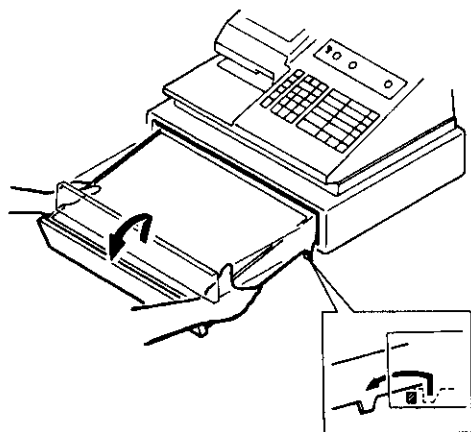

Fig. 2

13-9 CDC (Cash Drawer Cover) LOCK

Locking (Fig. 4)

1. Push the Cash Drawer Cover to the back of the drawer.
2. Press the cover lightly, insert the key into the key-hole on the cover, and turn it to lock.

Unlocking

1. Unlock the cover using the key, and lift the front end.

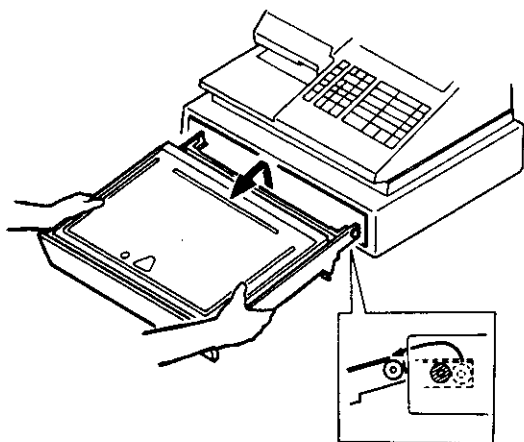

Fig. 3

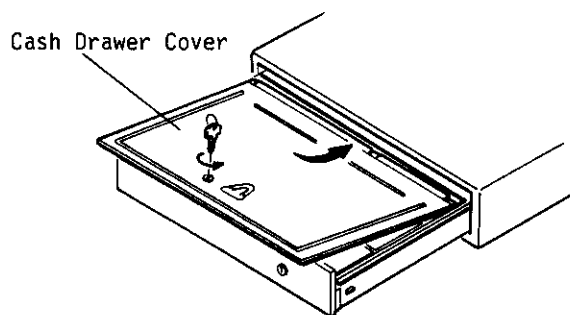

Fig. 4

14. SPECIFICATIONS

- Size** 464mm(width) x 428mm(depth) x 411mm(height)
(height including rubber feet)...with SP Drawer

522mm(height) ... when the Customer Display is
popped up.

464mm(width) x 428mm(depth) x 323mm(height)
(height including rubber feet) ... without a drawer
- Weight** 18.5kg (with a SP Drawer)
12.5kg (without drawer)
- Power Required** AC 117V ± 10%; 50Hz ± 10%
(varies depending on the destination)
- Power Consumed** 15W (standby),
30W (operating)
- Size of Receipt and Journal Tape** 45mm(width) x 80mm(diameter)
0.07mm to 0.09mm (thickness)
- Ambient Temperature** 0°C to 40°C, 10% to 90% Relative Humidity

Validation Slip Specifications

- Type of Paper Non-carbon Paper, or Ordinary Paper + Carbon Sheet
- Thickness 0.06mm to 0.2mm (total thickness)
- Max. Number of Duplicates 2 sheets (including the original sheet)
- Size of Slip Min. 150mm(width) x min. 70mm(height)

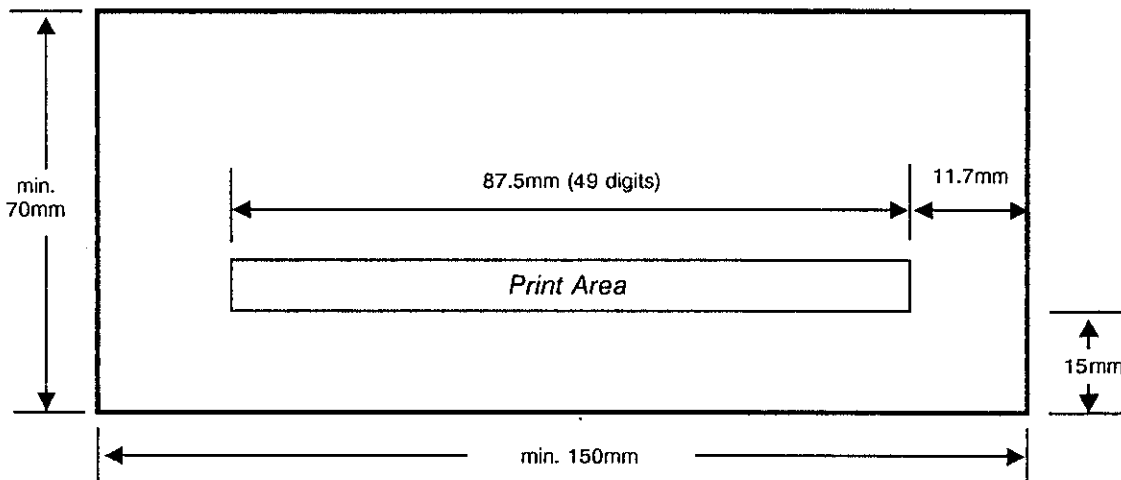

-- INDEX --

	<i>page</i>		<i>page</i>
A		J	
Additional Order Entry	28	JF (Journal Feed) Key	12
AMOUNT Display	9	K	
Auto Scale Entries	35	Keyboard Layout	10, 11
B		L	
Balance Transfer	29	LINE No. Key	13
C		LOCK position	3
Cash Drawer Cover Lock	74	M	
Cash Mode (Non-tab Mode)	15	MA Key	4
Cash Tip	46	Manager Intervention	18
Cashier Code Entry	22	Manual Scale Entry	36
Cashier Locks	5	Manual Tax	52
Cashier Sign ON/OFF	20	Media Entries (Payment)	31
Charge Tip	47	Media Keys	31
Check Combine (Check Merge)	50	Menu Item Entries	33
Check Digit of Guest Check No.	27	MGR Key	4
Check Finalizing (Closing)	30	MGR position	3
Check No. Creation Auto/Manual	27	Mode Lock	3
Check Paid	30	Modifier Entry	36
Check Transfer	49	Multiplication	34
Clear Transaction	42	N	
Coupon	44	New Check Entry	27
Customer Display	6	Non-add Number Print	55
D		Non-tab Mode (Cash Mode)	15
Discount	44	Non-tab Mode Sale Sequence	24
Display	6	No-sale	59
Drawer Open (Manual)	74	Numeric Keys	12
Drawer Opening by Media Keys	31	O	
Drawer Removing	74	OFFLINE position	3
E		Open-price Menu Items	33
Error Code and Messages	8	Opening a Guest Check	27
F		Operation Flows	15
Flat Keyboard Type	10	Operations Not Related to Sales	58
Formatted Receipt of Order Items	68	Operations Related to Order or Payment	39
FUNCTION Key Entry	62	Operator Code Entry	22,23
Functions of Each Key	12	Operator Display	6
G		Order Total (Balance Transfer)	29
GT Lock	4	Ordinary Keyboard Type	11
GTX position	4	Over-tender	31
GTZ position	4	P	
Guest Check Printer (GCP)	63	Paid-Out (PO)	61
Guest No. (Number of Guests) Entry	27	Paper Changing	71
I		Paper End (Journal or Receipt)	70
Item Correct	39		

-- INDEX -- (continued)

	<i>page</i>		<i>page</i>
Payment	31	Service Charge	45
Percent Charge	45	SET Key	4
Percent Discount	44	Set Menu Entry	37
Post Receipt	57	SET position	3
Power Failure	70	Short-tender	31
Power Switch	2	Sign ON/OFF	21,22
Preparation for Registering Operations	18	Split Package Pricing	34
Preset Price Open Entry	38	Store Name Stamp Ink	73
Preset-price Menu Items	33	Subtotal	51
Previous Balance Pick Up	28	System Type Variations	15
Price Shift	37	T Tab Mode 1	16
Printer Lock	70	Tab Mode 2	17
Q Quantity Extension	34	Tab Mode Sale Sequence	25
R RECEIPT ON/OFF Switch	5	TAB/CASH Mode Change	55
Received-on-Account (R/A)	60	Table No. Entry	27
REG Key	4	Tare Entry	35
REG position	3	Tax Exempt	53
Registering Operations	20	Tax Status Modification	52
Remote Kitchen Printer (RKP)	66	Taxable Total	51
Repeat Entry	34	TENDER function of Media Keys	31
Retry	69	Tip Paid in Cash	46
Return	41	Tip Paid in Non-cash Medias	47
Return Scale Item	36	TOTAL function of Media Keys	31
RF (Receipt Feed) Key	12	Training Mode	18
Ribbon Cartridge Changing	73	Tray Total	54
RPT (Repeat Count) Display	9	Triangular Lamps	9
RTR position	4	Type 1	15
S Sale Sequence	24,25	Type 2	16
Scale Items	35	Type 3	17
Secret Code of Cashier/Server	20,21	V Validation Print	56
Server Code Entry	23	Void	40
Server Sign ON/OFF	21	Void Check	43
Server-Cashier System	16	Void Scale Item	36
Server/Banking System	17	X X position	3
Service Adjust	48	Z Z position	3

MANAGER'S GUIDE

-- MANAGER'S GUIDE --

TABLE OF CONTENTS

	page
Chapter 1. MANAGER INTERVENTION	1
1-1 OPERATIONS PROGRAMMED TO REQUIRE MANAGER INTERVENTION	1
1-2 LISTING CAPACITY RELEASE BY MANAGER INTERVENTION	3
Chapter 2. TRAINING MODE	4
Chapter 3. OFF-LINE MODE	6
Chapter 4. MANAGER'S OWN OPERATIONS	8
Chapter 5. TERMINAL REPORTS	9
Terminal Daily Reports	9
Central File Daily Reports	10
GT Reports	10
GENERAL NOTES ON REPORT TAKINGS	11
REPORT PRINT SAMPLES	12
Chapter 6. MASTER-SATELLITE OPERATIONS	21
Chapter 7. PROGRAMMING OPERATIONS	21

1. MANAGER INTERVENTION

1-1 OPERATIONS PROGRAMMED TO REQUIRE MANAGER INTERVENTION

During daily sale entry operations, the operator (cashier or server) may call for Manager Interventions. The following is the operation flow of a Manager Intervention.

- 1) During operations, the operator (cashier or server) comes across an item that requires a Manager Intervention. The operator, already informed of it, may immediately call for a Manager Intervention. Or the operator, without knowing of it, attempts the operation, and an error results with the error code of "E09", clears the error by the [C] key, and then calls for a Manager Intervention.



- 2) You go to the terminal with the MGR or MA key.



- 3) The operator explains what kind of operation was attempted, and removes the REG key from the Mode Lock at the REG position.



- 4) You insert the MGR or MA key and turn it to the MGR position.



- 5) The operator performs the required operation.



- 6) You return the MGR or MA key to the REG position and pull it out.



- 7) The operator sets the REG key to the REG position again and continues registering operations.

On the following page is the tables of keys and operations that are programmable with Manager Intervention. Fill in the table by marking in the "Not required" or "Required" column of each item, referring to the documents, etc., listed in the table.

Table 1: KEYS/OPERATIONS AND MANAGER INTERVENTION STATUS

KEY/OPERATION	Manager Intervention		Reference
	Not required	Required	
[] (%-/COUPON 1)			Ask your TEC representative as to information or changes of KEY STATUSES.
[] (%-/COUPON 2)			
[] (%-/COUPON 3)			
[] (%-/COUPON 4)			
[] (%-/COUPON 5)			
[RETURN]			
[ITEM CORR]			
[VOID]			
[PO]			
[] (R/A 1)			
[] (R/A 2)			
[] (R/A 3)			
[] (R/A 4)			
[CHARGE TIP]			
[TIP PAID]			
[SERVICE ADJUST]			
[SERVICE CHARGE]			
[CLEAR TRAN]			
[CHECK TRANSFER]			
[VOID CHECK]			
[TX EX]			
[TAX]			
[PRICE SHIFT]			
[SIGN ON/OFF]			
[NS]			
Credit Balance (NOTE 1 on the next page.)	[RETURN]		Ask your TEC representative as to information or changes of SYSTEM OPTIONS
	[VOID]		
	Others		
Negative Balance Sales finalization by any media keys (NOTE 2 on the next page.)			

- NOTES** 1. The "Credit Balance" means that amount entries through credit keys (keys to enter negative amounts such as [RETURN], [VOID], and other %-/COUPON keys) results in over-subtraction of the sale total at the time of the entry through any of those keys. If the status "Not required" is selected, over-subtraction using the keys will be allowed in the "REG" mode. The Credit Balance "Allowed/Prohibited" status using the [RETURN] and [VOID] keys are programmed separately from that using other credit keys.
2. Even when the Credit Balance is allowed, it is another program option selection whether a negative balance sale can be finalized by media keys. If "Not required" is selected, the operator can finalize such sales in the "REG" mode.

1-2 LISTING CAPACITY RELEASE BY MANAGER INTERVENTION

Listing Capacities (LC) may be programmed for amount entries of Menu Items (Open-price Item Entry or Preset-price Open Entry), media keys, and several other transaction keys. These LC's are programmed to check an excessively high amount entry by operator's mistake at the earliest stage. The procedure of operators and Manager Intervention for LC release is same as described in 1-1, except that the error code of "E06" is displayed for an LC error instead of "E09" for a Manager Intervention requirement error. Fill the LCs in the table below and guide your operators as to the amount limit through each of the keys. (Ask your TEC representative as to information or changes of Listing Capacities.)

Table 2: Listing Capacity for Each Item or Key

Key/Item	Listing Capacity (Limit Digits)	Key/Item	Listing Capacity (Limit Digits)
Menu Items		Non-cash Media 2 []	
%-/Coupon 1 []		Non-cash Media 3 []	
%-/Coupon 2 []		Non-cash Media 4 []	
%-/Coupon 3 []		Non-cash Media 5 []	
%-/Coupon 4 []		Non-cash Media 6 []	
%-/Coupon 5 []		Non-cash Media 7 []	
[RETURN]		Non-cash Media 8 []	
[VOID]		Non-cash Media 9 []	
[SERVICE ADJUST]		[CHARGE TIP]	
[PO]		R/A 1 []	
[TAX] (Manual Tax)		R/A 2 []	
[CASH]		R/A 3 []	
Non-cash Media 1 []		R/A 4 []	

2. TRAINING MODE

When you have newly employed operators, you should provide some time for them to be trained to operate the FDS-50 terminal. You are to start and end the Training Mode. Once entering the Training Mode, an operator may operate just as ordinary sale entry operations. The data in the Training Mode are processed into Training Mode Total memory but not affect any actual sales data in business.

CONDITION

Outside a sale, in Cashier Signed-OFF condition

OPERATION FOR TRAINING MODE START

Mode Lock: **MGR** / GT Lock: Neutral

Training Mode Code **[#]**

01 to 99; this code is programmed. Ask your TEC representative for the code.

↓ (The Mode Lock may be turned to the "REG" position now.)

Registering operations are allowed by the trainees:

No cashier/server sign-ONs are necessary. (The Training Mode Start itself is a kind of sign-ON.)

- Cashier or Server Code Entry is accepted with any 5-digit number.
- All registering operations are possible in the Training Mode except:
 - 1) The drawer will not open.
 - 2) The Consecutive No. on the receipt will not be incremented.
 - 3) The Guest Check printing is possible but the RKP printing is not. Since the number of guest check print lines is not controlled, print always occurs from the first line of the slip. A manual number entry through the **[NEW CHECK]** key is always required, so is a manual previous balance entry through the **[PB]** and **[CHECK PAID]** key.
 - 4) The "SLIP" triangular lamp flickers to require a validation print on an entry of an item programmed with the "Validation Compulsory" status. A validation slip must be inserted and the **[VALIDATE]** key must be depressed, but no print occurs.
 - 5) Print occurs on receipt, journal, and GCP slip with a Training Mode header or message.

↓

OPERATION FOR TRAINING MODE END

Operate the same as the TRAINING MODE START (in the "MGR" mode).

Now the register is in a Signed-OFF condition. You may turn the Mode Lock to any position for its corresponding operations.

Refer to the receipt print samples in the Training Mode on the next page.

- TRAINING MODE RECEIPT SAMPLES ---

Training ON

```

RESTAURANT TEC
1234 PEACH DRIVE
PHONE: 87-6437
9:00 - 20:00

SPECIAL LUNCH MENU
from 11:00 to 13:00

05-07-89 SUN #555501

*TRAINING*
  ON

0261 T13:44
    
```

Receipt Issued in Training Mode
(Operation in Non-tab Mode)

```

RESTAURANT TEC
1234 PEACH DRIVE
PHONE: 87-6437
9:00 - 20:00

SPECIAL LUNCH MENU
from 11:00 to 13:00

05-07-89 SUN #555501

*TRAINING*
VEG.SALAD 2.20 T
COFFEE 0.70 T
BEER-A 1.40 T
SUBTOTAL 4.30

TAX1 0.26
TAX2 0.07
TOTAL 4.63

CASH TND 5.00
CHANGE 0.37

ITEM 3
*TRAINING*
0261 T13:52
    
```

Training Mode Header

Sale Data

Training Mode Header

Training OFF

```

RESTAURANT TEC
1234 PEACH DRIVE
PHONE: 87-6437
9:00 - 20:00

SPECIAL LUNCH MENU
from 11:00 to 13:00

05-07-89 SUN #555501

*TRAINING*
  OFF

0261 T13:57
    
```

3. OFF-LINE MODE

The off-line operations are applicable when multiple terminals are connected to the in-line cable (Master-Satellite System). When any trouble occurs on the in-line cable, the Master Terminal, etc., the communication between each Satellite Terminal and the Master Terminal is cut; therefore, normal operations in the "REG" or "MGR" mode are not accepted. If such a situation happens, business data must be entered in the "OFFLINE" position of the Mode Lock until the trouble is recovered. (Though the "OFFLINE" position is provided on the Master Terminal, it is seldom used.)

CONDITION

When an in-line trouble has occurred.

OPERATION FOR OFF-LINE MODE START

Turn the Mode Lock to the **OFFLINE** position. (GT Lock: Neutral)

When the Mode Lock is turned to the OFFLINE position, the "(-)" triangular lamp flickers and remains flickering until the Mode Lock is turned to other positions.

Registering operations are allowed in the off-line mode:

- A cashier sign-ON is necessary. Any 5-digit number is accepted. But once a cashier signs ON, the entered 5-digit number must be used for Cashier Code Entries. Server Code Entries are allowed with any 5-digit number (the number is not checked).
- All registering operations are possible in the off-line Mode except:
 - 3) The Guest Check printing is possible but the RKP printing is not (Formatted Receipts are issued for menu item entries instead). Since the number of guest check print lines is not controlled, print always occurs from the first line of the slip. A manual number entry through the **[NEW CHECK]** key is always required, so is a manual previous balance entry through the **[PB]** and **[CHECK PAID]** key. The **[LINE No.]** key can be used to feed the slip to the required position to start printing.

Operate: [Number of Lines to be fed] → **[LINE No.]**
(This must be operated immediately after the Server or Cashier Code Entry in the off-line mode.)
 - 4) In Tab Mode, taxes are calculated and printed in order entry sequences. However, in Check Paid sequences, the previous amount always includes taxes and taxes are not separately printed.
 - 5) Print occurs on receipt, journal, and GCP slip with an off-line mode header or message.

OPERATION FOR OFF-LINE MODE END

The signed-ON cashier must sign OFF. The cashier sales data recorded in the off-line mode are automatically printed as OFF-LINE CASHIER Z REPORT (Report No. Z20) and issued from the terminal printer. (The data other than cashiers are processed into the terminal memory and can be read as data included in normal X and Z reports.)

You can now turn the Mode Lock to other positions.

Refer to the receipt print samples in the off-line mode.

-- OFF-LINE MODE PRINT SAMPLES --

Sale Entry Receipt
(in Non-tab Mode)

```

RESTAURANT TEC
1234 PEACH DRIVE
PHONE: 87-6437
9:00 - 20:00

SPECIAL LUNCH MENU
from 11:00 to 13:00

05-07-89 SUN #555501

*OFF-LINE*
COFFEE      0.70 T
BEER-A      1.40 T

TAX1        0.13
TAX2        0.07
TOTAL       2.30

CASH        2.30

ITEM        2
*OFF-LINE*
EDEN        0025 T15:11
    
```

Off-line Mode Header

Off-line Mode Header

Auto Cashier Z Report issued
by Cashier Sign OFF
(The Print Format is same as ordinary
Cashier X or Z report.)

```

RESTAURANT TEC
1234 PEACH DRIVE
PHONE: 87-6437
9:00 - 20:00

SPECIAL LUNCH MENU
from 11:00 to 13:00

05-07-89 SUN #555501

*OFF-LINE*

      Z20

555
CHECK          1
GUEST
      1CU
GS              1

VD/IC

0.00
0
0.00
NO-SALE        0
TRACK1         0
0.00
TRACK2         0
0.00
TRACK3         0
0.00
TRACK4         0
0.00
TRACK5         0
0.00

0011 T15:20
    
```

"Z20" is the fixed header
for the automatic cashier
Z report after Cashier
Sign OFF in OFF-LINE
mode.

4. MANAGER'S OWN OPERATIONS

The following are operations to be performed on the terminal by the manager during business hours or between business shift periods:

PRICE SHIFT

This operation is already described in the Operator's Guide. However, to prevent operators from pressing the [PRICE SHIFT] key in the REG mode by mistake, it is recommended to program the [PRICE SHIFT] to require Manager Intervention and operate this key in the MGR mode.

CONDITION

Any time outside a sale and:
After a Server Code Entry in Tab Mode, or
After a Cash Code Entry in Non-tab Mode

OPERATION

Mode Lock: **MGR** / GT Lock: Neutral

Price Shift Code [PRICE SHIFT]

.....
1: for Price 1
2: for Price 2
3: for Price 3

KEYBOARD SHIFT (MENU SHIFT)

This operation is used to change the keyboard layout (especially the Code-preset Menu Item Keys) to match the menu items to be served for the coming business period. A maximum of three keyboard layouts can be programmed.

CONDITION

Any time outside a sale and in Cashier Signed-OFF condition

OPERATION

Mode Lock: **X** / GT Lock: Neutral

[NS] → Keyboard Shift Code [NS]

.....
1: for Keyboard 1
2: for Keyboard 2
3: for Keyboard 3

(As for the contents of each keyboard, ask your TEC representative.)

RKP DESIGNATION SWITCHING

This operation is used to change the Remote Kitchen Printer print destinations of Menu Items. This is also operated usually between different business shift periods when preparation areas are to be changed.

CONDITION

Any time outside a sale and in Cashier Signed-OFF condition

OPERATION

Mode Lock: **X** / GT Lock: Neutral

RKP Designation Table No. [SERVER #]

.....
1: for Table 1
2: for Table 2

(As for contents of the tables, ask your TEC representative.)

5. TERMINAL REPORTS

The following table shows the key operation to take each report. The "X" and "Z" reports have exactly the same print content if both are available, except that:

1. The "X" reports allow to read the sales data but not clear memories, while the "Z" reports allow to read the sales data and at the same time all the resettable memories will be cleared when the reports have been issued.
2. The symbol "Xnn" is printed on the top line of an "X" report, while "Znn" is printed on a "Z" report. ("nn" is the Report No.)
3. A reset count is printed on the bottom of a "Z" report only.
4. When multiple terminals are connected on one in-line cable (Master-Satellite System), Terminal Daily Z reports of each terminal are usually taken by report collection commands on the Master Terminal. Accordingly, those Z report takings can only be operated on each terminal with an appropriate system option selection and with an entry of the "Off-line Reset Code" prior to the key operation to take each Z report. (Mode Lock: Z, Code [#])

TABLE OF OPERATIONS FOR TERMINAL X AND Z REPORTS

Terminal Daily Reports (GT Lock: Neutral)

REPORT HEADER	REPORT NAME	MODE LOCK	KEY OPERATION	SAMPLE PAGE
X03 Z03	FINANCIAL Read FINANCIAL Reset	X Z	3 [CASH]	12,13
X04 Z04	CATEGORY & DEPARTMENT Read CATEGORY & DEPARTMENT Reset	X Z	4 [CASH]	14
X05 Z05	ALL MENU ITEM Read ALL MENU ITEM Reset	X Z	5 [CASH]	15
X05	Designated Category Menu Item Read	X	<u>Category Code</u> [#] 5 [CASH]	16
X05	Designated Department Menu Item Read	X	<u>Dept Code</u> [NS] 5 [CASH]	16
X05	Zone Menu Item Read	X	<u>Zone-start Item Code</u> [@/FOR] ↓ <u>Zone-end Item Code</u> [@/FOR] ↓ 5 [CASH]	16
X05	Individual Menu Item Read	X	[Code-preset Menu] (or <u>Item Code</u> [ITEM #]) ↓ ([ST] for subtotal) [CASH] to end	16
X06 Z06	HOURLY RANGE Read HOURLY RANGE Reset	X Z	6 [CASH]	17
	COMBINATION READ REPORTS COMBINATION RESET REPORTS	X Z	[CASH] ... for Table 1 1 [CASH] ... for Table 2 2 [CASH] ... for Table 3	

Central File Daily Reports (GT Lock: RTR)

These reports can only be taken on the Master Terminal in a Master-Satellite System. (When only one terminal is connected to the in-line cable, it is the Master Terminal.)

REPORT HEADER	REPORT NAME	MODE LOCK	KEY OPERATION	SAMPLE PAGE
X07 Z07	ALL OPERATOR Read ALL OPERATOR Reset	X Z	7 [CASH]	18,19
X07 Z07	Designated Operator Read Designated Operator Reset	X Z	[Operator Code] (3-digit Programmed Portion) [#] ↓ 7 [CASH]	18,19
X08 Z08	OUTSTANDING CHECK Read OUTSTANDING CHECK Reset	X Z	8 [CASH]	20

GT Reports (Mode Lock: Any position) -- reports of data accumulated for a certain period

These reports can only be taken on the Master Terminal.

REPORT HEADER	REPORT NAME	GT LOCK	KEY OPERATION	SAMPLE PAGE
GTX03 GTZ03	FINANCIAL GT Read FINANCIAL GT Reset	GTX GTZ	3 [CASH]	12,13
GTX04 GTZ04	CATEGORY & DEPARTMENT GT Read CATEGORY & DEPARTMENT GT Reset	GTX GTZ	4 [CASH]	14
GTX05 GTZ05	ALL MENU ITEM GT Read ALL MENU ITEM GT Reset	GTX GTZ	5 [CASH]	15
GTX05	Designated Category Menu Item GT Read	GTX	[Category Code] [#] 5 [CASH]	16
GTX05	Designated Department Menu Item GT Read	GTX	[Dept Code] [NS] 5 [CASH]	16
GTX05	Zone Menu Item GT Read	GTX	[Zone-start Item Code] [@/FOR] ↓ [Zone-end Item Code] [@/FOR] ↓ 5 [CASH]	16
GTX05	Individual Menu Item Read	GTX	[Code-preset Menu] ← (or [Item Code] [ITEM #]) ↓ ([ST] for subtotal) [CASH] to end	16
GTX06 GTZ06	HOURLY RANGE Read HOURLY RANGE Reset	GTX GTZ	6 [CASH]	17
GTX07 GTZ07	ALL OPERATOR GT Read ALL OPERATOR GT Reset	GTX GTZ	7 [CASH]	18,19
GTX07 GTZ07	Designated Operator Read Designated Operator Reset	GTX GTZ	[Operator Code] (3-digit Programmed Portion) [#] ↓ 7 [CASH]	18,19
	COMBINATION REPORTS	GTX GTZ	Same as in Daily Terminal Reports	

GENERAL NOTES ON REPORT TAKINGS

1. The cashier signed-OFF condition is required for taking any X or Z reports. Otherwise, an error will result when the Mode Lock is turned to the X or Z position or when the GT Lock is turned to the GTX or GTZ position.
2. Z and GTZ reports will be printed on the receipt roll as well as on journal, and issued, regardless of the current [RECEIPT ON/OFF] switch position.
3. The [ITEM CORR] or [VOID] key can be depressed halfway during printing a report, for the purpose to cancel the receipt issuance (except for some short reports). When a report cancel has been operated for a Z or GTZ report, the memory of the report data will not be cleared.
4. The drawer will open at the starting of printing the Financial reports if the system option "Drawer Open at Financial Reports" is selected.
5. X reports can be taken any number of times during business hours or at the end of the day. Z reports should be taken only once, usually at the end of the day, since the total memories will be cleared on taking the Z reports. To take a cashier or server Z report, the cashier or server must sign OFF beforehand. The "ALL OPERATOR RESET" report is taken when all the operators ends the business shift together. The "Individual Operator Reset" report is taken when only one or some operators ends their business shift. Similarly, GTX reports can be taken any number of time during a certain period (a week, month, etc.), while GTZ reports should be taken only once at the end of the period.
6. In a Master-Satellite System (i.e. multiple terminals are connected to one TIP-NET cable loop), Terminal Daily Z reports should not usually be taken. Instead, In-line Daily Z reports are provided to be operated on the Master Terminal. (Ask your TEC representative for detailed information). By taking those in-line Z reports, the sales data are accumulated into GTX/GTZ report memory. In a Master-only System (i.e. only one terminal is connected to the cable, besides a GCP and RKPs), by taking Terminal Daily Z Reports and Central File Daily Z Reports, the sales data are accumulated into GTX/GTZ report memory.
7. When operating a Combination Report taking, all the reports programmed in the designated Combination Report Table will be issued consecutively. The of type of the issued reports is determined by the current Mode Lock and GT Lock positions. For example, when a Combination Report taking is operated with the Mode Lock in "X" and the GT Lock in "Neutral", all the reports issued by the operation will be Daily X Reports.

FINANCIAL READ or RESET (Report No.3)

RESTAURANT **TEC**
 1234 PEACH DRIVE
 PHONE: 87-6437
 9:00 - 20:00

Mode Lock: **X** for Read
Z for Reset
 GT Lock: **GTX** for GT Read
GTZ for GT Reset

} Enter 3, depress [CASH].

SPECIAL LUNCH MENU
 FROM 11:00 to 13:00

Read Report Sample

05-07-89 SUN #555501

← Report Header

X03

NOTE:
 The sample here is a merely example. Since the print order of the total items is programmable, the format of Financial Reports can be made to meet the requirements of each user. Also note that the subtotal or total lines (such as "%-TOTAL" and "MEDIA TL" in this sample) can also be programmed to print to sum up certain items in the same group.

GT 270.21
 TRAINING 0.00
 GUEST 9CU
 CHECK 9
GS 67
 270.21
 VOID 1
 5.00
 ITEM COR 1
 14.00
 SERV ADJ 1
 0.30

 COUPON 2
 10.00
 DISC TL 1
 0.21
 DISC ITM 0
 0.00
 %- TOTAL 10.21

 TAX1 9.96
 TAX2 0.28
 TAX3 0.00

 TOTAL 65
 241.21
 CHK PAID 4CU 105.34
 CHS TIP 1
 4.00

GT (Grand Total)
 Training Grand total
 Number of Guests
 Number of Guest Checks
 Gross Sales Item Count & Amount
 Void Count & Amount
 Item Correct Count & Amount
 Service Adjust Count & Amount
 Coupon Count & Amount
 Total Discount (%-) Count & Amount
 Item Discount (%-) Count & Amount
 Total of the above three items (a line such as this is programmable)
 Tax 1 Amount
 Tax 2 Amount
 Tax 3 Amount
 Sales Total Item Count & Amount
 Check Paid Customer Count & Amount
 Charge Tip Count & Amount

(continued on next page)

FINANCIAL READ or RESET (Report No.3) -- continued --

SERV CHG	1	Service Charge Count & Amount
	2.75	
TIP PAID	1	Tip Paid Count & Amount
	4.00	
CASH	8	Cash Sales Customer Count & Amount
	83.29	
CRED CRD	1	Credit Card (Non-cash Media 1) Customer Count & Amount
	39.64	
HOUSE CH	2	House Charge (Non-cash Media 2) Customer Count & Amount
	71.27	
GIFT CRT	1	Gift Certificate (Non-cash Media 3) Customer Count & Amount
	12.00	
MEDIA TL	206.20	Total of all the above four media sales (a line such as this is programmable).
PAID OUT	1	Paid-Out Count & Amount
	5.60	
TRF TL	0	Transfer In/Out Count & In/Out Amount Balance
	0.00	
R ON ACT	2	Received-on-Account Count & Amount
	19.50	
RTN	0	Return Item Count & Amount
	0.00	
VOID CHK	0	Void Check Count & Amount
	0.00	
TXBL1	166.06	Taxable 1 Amount
TXBL2	5.41	Taxable 2 Amount
TRACK1	4	Item Track 1 Item Count & Amount
	10.72	
TRACK2	0	Item Track 2 Item Count & Amount
	0.00	
TRACK3	0	Item Track 3 Item Count & Amount
	0.00	
TRACK4	0	Item Track 4 Item Count & Amount
	0.00	
TRACK5	6	Item Track 5 Item Count & Amount
	54.00	
MISC VD	0	Miscellaneous Void Count (Item Correct on others than Menu Items) & Amount
	0.00	
TAX1EX	1	Tax 1 Exempted Transaction Count & Amount
	12.00	
TAX2EX	0	Tax 2 Exempted Transaction Count & Amount
	0.00	
-TAX	0	Negative Tax Count & Amount
	0.00	
NO-SALE	1	No-sale Operation Count
		← Reset Count is added on Z and GTZ reports
0024 T18:21		Receipt Consecutive No. & Current Time

CATEGORY & DEPARTMENT READ or RESET (Report No.4)

```

RESTAURANT TEC
1234 PEACH DRIVE
PHONE: 87-6437
9:00 - 20:00

SPECIAL LUNCH MENU
from 11:00 to 13:00

05-07-89 SUN #555501

XO4

BEEF          14
 96.9%       141.50
CHICKEN        1
  3.1%        4.50
MEAT           15
          146.00

SALMON         1
 30.9%        11.50
CRAB           1
 40.3%        15.00
SHRIMP         4
 28.8%        10.72
FISH           6
          37.22

SALAD

          3
100.0%       8.30
OTHERS        3
          8.30

TOTAL         65
          224.22

0025 T18:22
    
```

Mode Lock: X for Read
 Z for Reset
 GT Lock: GTX for GT Read
 GTZ for GT Reset

} Enter 4, depress [CASH].

Read Report Sample

← Report Header

Category Item Count
 % to Entire Department Sales & Amount
 ⋮

Department (containing the above categories) Item Count
 & Amount

Total of all Departments, Item Count
 & Amount

← Reset Count is added on Z and GTZ reports

MENU ITEM READ or RESET (Report No.5)

RESTAURANT **TEC**
 1234 PEACH DRIVE
 PHONE: 87-6437
 9:00 - 20:00

Mode Lock: **X** for Read
 Z for Reset
 GT Lock: **GTX** for GT Read
 GTZ for GT Reset

} Enter 5, depress [**CASH**]
 (for All Menu Item X or Z)

SPECIAL LUNCH MENU
 from 11:00 to 13:00

All Menu Item Read Report Sample

05-07-89 SUN #555501

X05

BEEF STEAK L	1101	
14.00@	5	
15.00@	0	
0.00@	0	
	65.00	
BEEF STEAK S	1102	
7.50@	3	
8.00@	0	
0.00@	0	
	22.50	
HAMB.STK SET	1121	
9.00@	6	
10.00@	0	
0.00@	0	
	54.00	
BEEF	14	
	141.50	
FRD CHICKEN	1401	
4.50@	1	
5.00@	0	
0.00@	0	
	4.50	
CHICKEN	1	
	4.50	
MEAT	15	
	146.00	

← Report Header

Menu Item Name, Item Code
 Price 1 Sales Item Count
 Price 2 Sales Item Count
 Price 3 Sales Item Count
 Sales Total Amount

⋮

Category Name (containing the above Menu Items) Item Count
 & Amount

⋮

Department (containing the above categories) Item Count
 & Amount

	8.30	
TOTAL	64	
	224.22	

Total of all Menu Items read in this report, Item Count
 & Amount

0026 T18:23

← Reset Count is added on Z and GTZ reports

MENU ITEM READ or RESET (Report No.5) -- continued --

Other Menu Item Read Samples

Designated Category Menu Item Read

```

RESTAURANT TEC
1234 PEACH DRIVE
PHONE: 87-6437
9:00 - 20:00

SPECIAL LUNCH MENU
from 11:00 to 13:00

05-07-89 SUN #555501

X05

01 BEEF
BEEF STEAK L 1101
14.00@ 5
15.00@ 0
    
```

Designated Category
All the Menu Items
included in the
Category follow.

Designated Department Menu Item Read

```

RESTAURANT TEC
1234 PEACH DRIVE
PHONE: 87-6437
9:00 - 20:00

SPECIAL LUNCH MENU
from 11:00 to 13:00

05-07-89 SUN #555501

X05

01 MEAT
BEEF STEAK L 1101
14.00@ 5
15.00@ 0
    
```

Designated Department
All the Menu Items
and Categories
included in the
Department follow.

Zone Menu Item Read

```

RESTAURANT TEC
1234 PEACH DRIVE
PHONE: 87-6437
9:00 - 20:00

SPECIAL LUNCH MENU
from 11:00 to 13:00

05-07-89 SUN #555501

X05

2000~2500
    
```

Zone-start Item Code &
Zone-end Item Code
All the Menu Items
included in the
zone follow.

Individual Menu Item Read

```

RESTAURANT TEC
1234 PEACH DRIVE
PHONE: 87-6437
9:00 - 20:00

SPECIAL LUNCH MENU
from 11:00 to 13:00

05-07-89 SUN #555501

X05

BEEF STEAK L 1101
14.00@ 5
15.00@ 0
    
```

Individual Menu Item
designated are read.

HOURLY RANGE READ or RESET (Report No.6)

```

RESTAURANT TEC
1234 PEACH DRIVE
PHONE: 87-6437
9:00 - 20:00

SPECIAL LUNCH MENU
from 11:00 to 13:00

05-07-89 SUN #555501

X06

08:00TM
0.0%      0CU
0.0%      0
0.0%      0.00
16:00TM
100.0%    9CU
100.0%    65
100.0%    279.52
23:00TM
0.0%      0CU
0.0%      0
0.0%      0.00

TOTAL
          9CU
          65
          279.52

0031 T18:28

```

Mode Lock: X for Read
 Z for Reset
GT Lock: GTX for GT Read
 GTZ for GT Reset

} Enter 6, depress [CASH].

Read Report Sample

← Report Header

Time Range of 8:00 to 16:00
Customer Count % to all sales, Customer Count
Item Count % to all sales, Item Count
Sales Amount % to all sales, Sales Amount

Time Range of 16:00 to 23:00

Time Range of 23:00 to 8:00

Total data of all Time Ranges
Customer Count Total
Item Count Total
Sales Amount Total

← Reset Count is added on Z and GTZ reports.

OPERATOR READ or RESET (Report No.7)

```

RESTAURANT TEC
1234 PEACH DRIVE
PHONE: 87-6437
9:00 - 20:00

SPECIAL LUNCH MENU
from 11:00 to 13:00

05-07-89 SUN #555501

      X07

555 EDEN
CHECK          9
GUEST
      9CU
GS             25
              109.11
VD/IC          0
              0.00
RTN            0
              0.00
SERV ADJ       1
              0.30

COUPON         2
              10.00
DISC TL        1
              0.21
DISC ITH       0
              0.00
%- TOTAL      10.21

TAX TL         10.24
TOTAL          25
              98.81
VOID CHK       0
              0.00
CHG TIP        1
              4.00
    
```

Mode Lock: X for Read / GT Lock: RTR
 Z for Reset / GT Lock: RTR
 GT Lock: GTX for GT Read
 GTZ for GT Reset

Read Report Sample

Enter 7, depress [CASH]
 (for All Operators)

Enter 3-digit Operator
 Code, depress [#],
 and depress [CASH]
 (for Individual Operator)

← Report Header

Operator Code, Operator Name	
Number of Guest Checks handled	9
Item Count % to all sales, Item Count	
Number of Guests	9CU
Gross Sales Item Count & Amount	GS 25 109.11
Void and Item Correct Count & Amount	VD/IC 0 0.00
Return Item Count & Amount	RTN 0 0.00
Service Adjust Count & Amount	SERV ADJ 1 0.30
Coupon Count & Amount	COUPON 2 10.00
Total Discount Count & Amount	DISC TL 1 0.21
Item Discount Count & Amount	DISC ITH 0 0.00
Total Amount of all the three above discount items (programmable)	%- TOTAL 10.21
Tax Total Amount (Tax 1 + Tax 2 + Tax 3)	TAX TL 10.24
Sales Total Item Count & Amount	TOTAL 25 98.81
Void Check Count & Amount	VOID CHK 0 0.00
Charge Tip Count & Amount	CHG TIP 1 4.00

NOTE:
 The sample here is a merely example. Since the print order of the total items is programmable, the format of Operator Reports can be made to meet the requirements of each user. Also note that the subtotal or total lines (such as "MEDIA TL" in this sample) can also be programmed to print to sum up certain items in the same group.

(continued on next page)

OPERATOR READ or RESET (Report No.7) -- continued --

(continued from the preceding page)

TIP PAID	0	Cash Tip Paid Count	
	0.00	& Amount	
TRF IN	0	Transfer In Count	
	0.00	& Amount	
TRF OUT	0	Transfer Out Count	
	0.00	& Amount	
CASH	8	Cash-in-drawer Count	
	79.29	& Amount	
CRED CRD	1	Credit Card (Non-cash Media 1) -in-drawer Count	
	39.64	& Amount	
HOUSE CH	2	House Charge (Non-cash Media 2) -in-drawer Count	
	71.27	& Amount	
GIFT CRT	1	Gift Certificate (Non-cash Media 3) in-drawer Count	
	12.00	& Amount	
MEDIA TL	202.20	Total of all the media-in-drawer amounts (including cash) -- (programmable)	
PAID OUT	1	Paid-Out Count	
	5.60	& Amount	
R ON ACT	2	Received-on-Account Count	
	19.50	& Amount	
SERV CHG	1	Service Charge Count	
	2.75	& Amount	
MISC VD	0	Miscellaneous Void Count (Item Correct on others than Menu Items)	
	0.00	& Amount	
-TAX	0	Negative Tax Count	
	0.00	& Amount	
NO-SALE	1	No-sale Count	
TRACK1	4	Item Track 1 Item Count	} These are special report memory totals provided to process sale entries of menu items on a sale campaign, etc. Ask your TEC representative as to how to program individual menu items to process into these totals.
	10.72	& Amount	
TRACK2	0	Item Track 2 Item Count	
	0.00	& Amount	
TRACK3	0	Item Track 3 Item Count	
	0.00	& Amount	
TRACK4	0	Item Track 4 Item Count	
	0.00	& Amount	
TRACK5	2	Item Track 5 Item Count	
	18.00	& Amount	
0043 T 18:42		← Reset Count is added on Z and GTZ reports.	

OUTSTANDING CHECK READ or RESET (Report No.8)

```

RESTAURANT  TEC
1234 PEACH DRIVE
PHONE: 87-6437
9:00 - 20:00

SPECIAL LUNCH MENU
from 11:00 to 13:00

05-11-89 THR #555501

X08

*****
CHK# 00001
TABLE# 10
GUEST 4
PREV-BAL 19.20
JOHNSON T10:29
*****

0058 T10:31

```

Mode Lock: X for Read / GT Lock: RTR
 Z for Reset / GT Lock: RTR

} Enter 8,
depress [CASH]

Read Report Sample

← Report Header

Outstanding Guest Check No.
 Table No.
 Number of Guests
 Current Balance remaining unpaid
 Responsible Server Name, Time served

6. MASTER-SATELLITE OPERATIONS

The FDS-50 system can be extended to compose a Master Terminal and a maximum of three Satellite Terminals. In a Master-Satellite System, sale entry operations are the same on any terminal as described in this Owner's Manual. In addition, in-line service operations are provided on the Master Terminal. The following is an overview of in-line service operations:

- In-line X and Z Reports started by report commands on the Master Terminal.
- DLLs (Down Line Loadings) to add or change program data of all the terminals by DLL commands on the Master Terminal.

Since not every user adopts a Master-Satellite System, information on these operations are to be offered by your TEC representative.

7. PROGRAMMING OPERATIONS

The system should be programmed fully according to the user's requirements at the time of delivery so that daily operations can immediately start. However, some data must be added or changed daily or in a longer period. Please consult with your TEC representative about what programmings are needed as user's daily jobs and what programmings are to be contained as your TEC representative service. Since the volume of programming contents for the system is large, the TEC representative is entirely responsible of service and information on programming operations.

Free Manuals Download Website

<http://myh66.com>

<http://usermanuals.us>

<http://www.somanuals.com>

<http://www.4manuals.cc>

<http://www.manual-lib.com>

<http://www.404manual.com>

<http://www.luxmanual.com>

<http://aubethermostatmanual.com>

Golf course search by state

<http://golfingnear.com>

Email search by domain

<http://emailbydomain.com>

Auto manuals search

<http://auto.somanuals.com>

TV manuals search

<http://tv.somanuals.com>